

January 25th 2002



# *Configuration and Options Guide*

**IBM@server**  
**xSeries**

**IBM**  
**IntelliStation®**

*Systems*

*Rack & Stack products*

*Fibre Channel*

*Storage Enclosures*

*Cables*

*Options*



**@server**<sup>™</sup>

**PROVEN**



xSeries 200



xSeries 220



xSeries 232



xSeries 240



xSeries 250



xSeries 370



xSeries 380

**Appliance Servers**  
 xSeries 130 / xSeries 135  
 xSeries 220ICA  
 xSeries 330ICA  
 xSeries 340ICA



xSeries 360

# xSeries



**RXE-100  
I/O Enclosure**



xSeries 350



**Rack Enclosures**



**EXP300  
Storage Enclosure**



xSeries 342



xSeries 330



**FAST EXP500  
Storage Enclosure**



xSeries 300



**Stack Enclosures**



**FAST T200 (HA)  
Storage Server**



**R Pro**



**M Pro  
Dual Processor  
Models**



**Z Pro**

# **IntelliStation**



## Changes in this Edition

---

<b>CHANGE MADE</b>	<b>SECTION(S) IMPACTED</b>
<b>Added New 15K Hard Disk Drives: P/N 06P5765, 06P5766 (non Hot-Swap) P/N 06P5767, 06P5768 (Hot-Swap)</b>	<b>Most Product Sections</b>
<b>Added AMI 100 IDE RAID Adapter P/N 24P2585</b>	<b>M Pro, x200, x300, x330</b>
<b>Removed Ethernet Adapter P/N 19K4401. Withdrawn effective from 18/12/01</b>	<b>Most Product Sections</b>
<b>Revised Monitors list</b>	<b>Most Product Sections</b>
<b>Removed models withdrawn effective from end of November</b>	<b>x200 (3 models), x220 (4 models), x230 (section removed), x330 (1 model), x340 (section removed)</b>



## Table of Contents

---

Changes in this Edition .....	2
Keep Us Informed - Feedback .....	4
IntelliStation® M Pro (dual processor).....	5
IntelliStation R Pro .....	11
IntelliStation Z Pro.....	15
xSeries Business Models Summary .....	19
Appliance Servers .....	21
IBM xSeries™ 200 .....	41
IBM xSeries 220 .....	49
IBM xSeries 232 .....	57
IBM xSeries 240 .....	65
IBM xSeries 250 .....	73
IBM xSeries 300 .....	83
IBM xSeries 330 .....	91
IBM xSeries 342 .....	99
IBM xSeries 350 .....	107
IBM xSeries 360 .....	115
IBM RXE-100 Remote Expansion Enclosure .....	123
IBM xSeries 370 .....	129
IBM xSeries 380 .....	139
IBM EXP300 .....	143
Fibre Channel Solutions Overview.....	147
IBM NetBAY3/NetBAY3E™ Stackable Enclosures.....	165
NetBAY Rack Cabinets and Options.....	167
NetBAY Rack Power Configuration Examples .....	173
Appendix A: Tape Drive Attributes.....	175
Appendix B: Tape Library Attributes .....	177
Appendix C: UPS Runtime Estimate (minutes) .....	179
Appendix D: External SCSI Cabling, Storage Units and Controllers .....	181
Appendix E: Internal Storage Cabling Overview .....	183
Appendix F: IBM Serial I/O .....	185
Appendix G: Useful URLs .....	186
Server Product Positioning .....	187
IBM xSeries Selection Guide .....	189
Configurator Description .....	191
Important Notes .....	193



# Keep Us Informed - Feedback

## The IBM Configuration and Options Guide Feedback Form:

Please give us the benefit of your experience

1. Please rate the value of the IBM Configuration and Options Guide overall.

- Very useful   
Useful   
Not useful

2. Please rate the usefulness of these sections in the IBM Configuration and Options Guide:

	Very Useful	Useful	Not Useful
Changes in this Edition	<input type="checkbox"/>	<input type="checkbox"/>	<input type="checkbox"/>
Business Models Summary	<input type="checkbox"/>	<input type="checkbox"/>	<input type="checkbox"/>
Product Family Pages	<input type="checkbox"/>	<input type="checkbox"/>	<input type="checkbox"/>
Sample Configurations	<input type="checkbox"/>	<input type="checkbox"/>	<input type="checkbox"/>
Fibre Channel Solutions O/view	<input type="checkbox"/>	<input type="checkbox"/>	<input type="checkbox"/>
'Rack and Stack' Sections	<input type="checkbox"/>	<input type="checkbox"/>	<input type="checkbox"/>
Rack Power Section	<input type="checkbox"/>	<input type="checkbox"/>	<input type="checkbox"/>
Tape Drives & Libraries Sections	<input type="checkbox"/>	<input type="checkbox"/>	<input type="checkbox"/>
UPS Runtimes Section	<input type="checkbox"/>	<input type="checkbox"/>	<input type="checkbox"/>
External SCSI Cabling Chart	<input type="checkbox"/>	<input type="checkbox"/>	<input type="checkbox"/>
Internal Storage Cabling Overview	<input type="checkbox"/>	<input type="checkbox"/>	<input type="checkbox"/>
Serial I/O Section	<input type="checkbox"/>	<input type="checkbox"/>	<input type="checkbox"/>
Useful URLs	<input type="checkbox"/>	<input type="checkbox"/>	<input type="checkbox"/>
Product Positioning	<input type="checkbox"/>	<input type="checkbox"/>	<input type="checkbox"/>
Selection Guidance	<input type="checkbox"/>	<input type="checkbox"/>	<input type="checkbox"/>
Configurator Description	<input type="checkbox"/>	<input type="checkbox"/>	<input type="checkbox"/>

3. How would you rate the quality of information contained in the IBM Configuration and Options Guide?

- Too much  
 About right  
 Not enough

4. Does the format allow you to assemble a preliminary xSeries or IntelliStation configuration?

- Quickly  
 Able to get it done  
 With some difficulty

5. Are you aware of the other xSeries configurators that are available on PartnerInfo and the Web? at URL: <http://www.ibm.com/pc/europe/configurators>

- Yes  
 No - but I will take a look

6. Are you a...? (Check one)

- PC Dealer       IBM Sales Support     IBM Customer  
 PC Distributor     IBM Field Sales Rep.  IBM Large Account Customer  
 PC VAR             Other (specify)

7. Other Comments

Please either fax this form to +44 (0) 1256 343964  
or send an e-mail to [psg\\_configure@uk.ibm.com](mailto:psg_configure@uk.ibm.com)

Thank You - we appreciate your help



# IntelliStation® M Pro (dual processor)

Part Number  
 Withdrawal Date: ddmmyy  
 Processor Speed<sup>2</sup>  
 Number of Processors (Std/Max)  
 L2 ECC Cache (KB)  
 Memory (Std/Max)  
 Video Adapter

Form Factor  
 Onboard Ethernet (Mbps)  
 SCSI Controller (Dual, Ultra, RAID)  
 Removable Media Bays (Total/Avail)  
 Internal Hard Disk Drive (Std/Max)  
 CD-ROM (IDE)<sup>6</sup>  
 Bays (Tot/Av)  
 Slots (Tot/Av)

IntelliStation M Pro At-A-Glance (dual processor models)														
KDT10xx <sup>1,7</sup>	-	1.5GHz	1/2	256	256MB/4GB	Matrox Millennium G450	Tower	10/100	IDE <sup>3</sup>	3/1	40GB/ 240GB <sup>4</sup>	48X-20X	9/6	6/5
KDTA0xx <sup>1,8</sup>	-	1.5GHz	1/2	256	256MB/4GB	Matrox Millennium G450	Tower	10/100	IDE <sup>3</sup>	3/1	40GB/ 240GB <sup>4</sup>	48X-20X	9/6	6/5
KDT20xx <sup>1,7</sup>	-	1.7GHz	1/2	256	256MB/4GB	Matrox Millennium G450	Tower	10/100	IDE <sup>3</sup>	3/1	40GB/ 240GB <sup>4</sup>	48X-20X	9/6	6/5
KDTB0xx <sup>1,8</sup>	-	1.7GHz	1/2	256	256MB/4GB	Matrox Millennium G450	Tower	10/100	IDE <sup>3</sup>	3/1	40GB/ 240GB <sup>4</sup>	48X-20X	9/6	6/5
KDT21xx <sup>1,7</sup>	-	1.7GHz	1/2	256	256MB/4GB	Matrox Millennium G450	Tower	10/100	U160 <sup>3</sup>	3/1	18.2GB/ 440.4GB <sup>5</sup>	48X-20X	9/6	6/5
KDTB1xx <sup>1,8</sup>	-	1.7GHz	1/2	256	256MB/4GB	Matrox Millennium G450	Tower	10/100	U160 <sup>3</sup>	3/1	18.2GB/ 440.4GB <sup>5</sup>	48X-20X	9/6	6/5
KDT22xx <sup>1,7</sup>	-	1.7GHz	1/2	256	512MB/4GB	NVIDIA Quadro2 Pro	Tower	10/100	U160 <sup>3</sup>	3/1	18.2GB/ 440.4GB <sup>5</sup>	48X-20X	9/6	6/5
KDTB2xx <sup>1,8</sup>	-	1.7GHz	1/2	256	512MB/4GB	NVIDIA Quadro2 Pro	Tower	10/100	U160 <sup>3</sup>	3/1	18.2GB/ 440.4GB <sup>5</sup>	48X-20X	9/6	6/5
KDT25xx <sup>1,7</sup>	-	1.7GHz	1/2	256	512MB/4GB	ATI Fire GL4 <sup>TM</sup>	Tower	10/100	U160 <sup>3</sup>	3/1	18.2GB/ 440.4GB <sup>5</sup>	48X-20X	9/6	6/4
KDTB5xx <sup>1,8</sup>	-	1.7GHz	1/2	256	512MB/4GB	ATI Fire GL4	Tower	10/100	U160 <sup>3</sup>	3/1	18.2GB/ 440.4GB <sup>5</sup>	48X-20X	9/6	6/4
KDT30xx <sup>1,7</sup>	-	2.0GHz	1/2	256	256MB/4GB	Matrox Millennium G450	Tower	10/100	IDE <sup>3</sup>	3/1	40GB/ 240GB <sup>4</sup>	48X-20X	9/6	6/5
KDTC0xx <sup>1,8</sup>	-	2.0GHz	1/2	256	256MB/4GB	Matrox Millennium G450	Tower	10/100	IDE <sup>3</sup>	3/1	40GB/ 240GB <sup>4</sup>	48X-20X	9/6	6/5
KDT31xx <sup>1,7</sup>	-	2.0GHz	1/2	256	256MB/4GB	Matrox Millennium G450	Tower	10/100	U160 <sup>3</sup>	3/1	18.2GB/ 440.4GB <sup>5</sup>	48X-20X	9/6	6/5
KDTC1xx <sup>1,8</sup>	-	2.0GHz	1/2	256	256MB/4GB	Matrox Millennium G450	Tower	10/100	U160 <sup>3</sup>	3/1	18.2GB/ 440.4GB <sup>5</sup>	48X-20X	9/6	6/5
KDT32xx <sup>1,7</sup>	-	2.0GHz	1/2	256	512MB/4GB	NVIDIA Quadro2 Pro	Tower	10/100	U160 <sup>3</sup>	3/1	18.2GB/ 440.4GB <sup>5</sup>	48X-20X	9/6	6/5
KDTC2xx <sup>1,8</sup>	-	2.0GHz	1/2	256	512MB/4GB	NVIDIA Quadro2 Pro	Tower	10/100	U160 <sup>3</sup>	3/1	18.2GB/ 440.4GB <sup>5</sup>	48X-20X	9/6	6/5
KDT35xx <sup>1,7</sup>	-	2.0GHz	1/2	256	512MB/4GB	ATI Fire GL4	Tower	10/100	U160 <sup>3</sup>	3/1	18.2GB/ 440.4GB <sup>5</sup>	48X-20X	9/6	6/4
KDTC5xx <sup>1,8</sup>	-	2.0GHz	1/2	256	512MB/4GB	ATI Fire GL4	Tower	10/100	U160 <sup>3</sup>	3/1	18.2GB/ 440.4GB <sup>5</sup>	48X-20X	9/6	6/4

1. IntelliStation M Pro ships with a keyboard and mouse. Tower models are rack-mountable using an optional tower-to-rack conversion kit, or they can be turned on their side and installed as desktop units capable of supporting the weight of a monitor. See "Power, Monitors, Accessories" section for more information and for a list of compatible monitors.
2. Intel Xeon<sup>TM</sup> processor with advanced transfer ECC L2 cache and 4 X 100MHz Front Side Bus (FSB).
3. All models include an integrated ATA-100 IDE controller that supports up to four IDE devices (four HDDs or three IDE HDDs and one CD-ROM) in IDE models and an integrated Ultra160 SCSI controller with one internal and one external port. Both ports are 68-pin, 16-bit Ultra160 (LVD) connectors. The external port supports external Ultra160 SCSI storage devices and the internal port supports up to six SCSI HDDs in SCSI models. Mixing of IDE and SCSI HDDs is not supported.
4. IDE models include a two-drop ATA-100 IDE cable and a two-drop ATA-33 cable. One connector of the ATA-33 cable is attached to the standard CD-ROM and the other connector can be used for an IDE HDD. The CD-ROM must be disconnected to support four IDE HDDs. Maximum storage is based on four 60GB IDE HDDs, which also requires replacing the standard 40GB HDD.
5. Requires replacement of the standard 18.2GB 10,000RPM HDD with a 73.4GB HDD.
6. Variable read rate. Actual playback speed will vary and is often less than the maximum possible.
7. These models include a Windows 2000 preloaded software package.
8. These models include a PC DOS 2000 licence.

To access IBM information specific to your country via the World Wide Web, use address: <http://www.ibm.com/pc>



**IntelliStation M Pro Processors (dual processor models)**

Part Number	Processor Upgrades	SMP Support <sup>1</sup>	Processor Speed Upgrade <sup>2</sup>
24P8401	1.5GHz/100MHz 256KB Cache Second Processor.	KDT10xx, KDTA0xx	-
24P8402	1.7GHz/100MHz 256KB Cache Second Processor.	KDT20xx to KDTB5xx	KDT10xx, KDTA0xx
24P8453	2GHz/100MHz 256KB Cache Second Processor.	KDT30xx to KDTC5xx	KDT10xx to KDTB5xx

1. One additional processor may be installed, providing a maximum of two. All processors must be identical in type, speed, and cache size.  
 2. Requires removal of the standard processor. A maximum of two processors may be installed. All processors must be identical in type, speed and cache size. Upgrades may require a BIOS update. To obtain the latest Flash BIOS, access [www.pc.ibm.com/support](http://www.pc.ibm.com/support) and enter machine "Type-Model" in Quick Path. Select "Downloadable files" then "BIOS."

**IntelliStation M Pro Memory (dual processor models)**

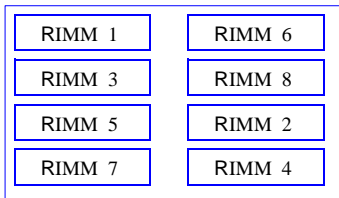

Part Number	Memory Description <sup>1</sup>
33L3350	128MB PC800 4D ECC RDRAM RIMM (288Mb)
33L3352	256MB PC800 8D ECC RDRAM RIMM (288Mb)
33L3254	512MB 800MHz ECC 16D RDRAM RIMM Memory (288Mb)
20L0275	128MB 800MHz ECC 16D RDRAM RIMM Memory (144Mb)
20L0277	256MB 800MHz ECC 16D RDRAM RIMM Memory (144Mb)

1. Memory RIMMs must be installed in pairs using the same option part number according to the following order: RIMM connectors one and two, three and four, five and six, and seven and eight.

Total System Memory <sup>1</sup>		Quantity of RIMMs Added		
256MB (2 x 128) Models	512MB (2 x 256) Models	128MB P/N 33L3350 or P/N 20L0275	256MB P/N 33L3352 or P/N 20L0277	512MB P/N 33L3254
512MB	768MB	2	-	-
768MB	1024MB	4	-	-
1024MB	1280MB	6	-	-
1280MB	1536MB	4 and	2	-
1792MB	2048MB	4 and	-	2
2304MB	2560MB	-	4 and	2
2560MB	2816MB	2 and	-	4
2816MB	3072MB	-	2 and	4
3328MB	3584MB	-	-	6
4GB (max) <sup>2</sup>	4GB (max) <sup>2</sup>	-	-	8

This table does not represent all possible memory configurations. Memory modules may vary in price per MB. Selection of smaller RIMMs may provide a more cost-effective alternative to using larger RIMMs.

1. Network operating systems may limit the maximum amount of addressable memory. See operating system specifications for further information.  
 2. Requires replacing the standard RIMM.





**IntelliStation M Pro Hard Disk Drive (HDD) Storage (dual processor models)**

SCSI Models					
Total Int Storage <sup>1</sup>	10,000RPM HDDs			15,000RPM HDDs	
	18.2GB P/N 00N8208 or 06P5750	36.4GB P/N 00N8209 or 06P5751	73.4GB P/N 06P5752	18.2GB P/N 19K0658 or 06P5765	36.4GB P/N 06P5766
18.2GB	18.2GB Standard on SCSI models (10,000rpm)			18.2GB Standard on SCSI models (10,000rpm)	
36.4GB	1	-	-	1	-
54.6GB	2	-	-	2	-
72.8GB	3	-	-	3	-
91GB	4	-	-	4	-
109.2GB	5	-	-	5	-
127.4GB	4 and	1	-	4 and	1
145.6GB	3 and	2	-	3 and	2
163.8GB	2 and	3	-	2 and	3
182GB	1 and	4	-	1 and	4
200.2GB	-	5	-	-	5
237.2GB	-	4 and	1	-	-
274.2GB	-	3 and	2	-	-
311.2GB	-	2 and	3	-	-
348.2GB	-	1 and	4	-	-
385.2GB	-	-	5	-	-
440.4GB <sup>2</sup>	-	-	6	-	-

This table does not represent all possible HDD configurations. Total Internal Storage listed is within +/-0.2GB unless otherwise noted.

1. Select a total storage row then add the quantity of HDDs from all columns within an RPM range to the standard HDD.
2. Requires replacement of the standard HDD.

EIDE Models			
Total Internal Storage <sup>1</sup>	7200RPM EIDE HDDs <sup>2</sup>		
	20.4GB P/N 19K4461	40GB P/N 22P7157	60GB P/N 09N4207
40GB	-	Std on EIDE models	-
60.4GB	1	-	-
80GB	-	1	-
100GB	-	-	1
120GB	-	2	-
140GB	-	1	1
160GB	-	-	2
180GB <sup>3</sup>	-	-	3 <sup>3</sup>
240GB (max) <sup>4</sup>	-	-	4 <sup>4</sup>

This table does not represent all possible HDD configurations. Total Internal Storage listed is within +/-0.2GB unless otherwise noted.

1. Select a total storage row then add the quantity of HDDs to the standard HDD.
2. Supports a maximum of four IDE devices including CD-ROM drives, HDDs and IDE tape drives.
3. Requires replacement of the standard HDD.
4. Requires replacement of the standard HDD and disconnection of the CD-ROM drive.



Bay	Form Factor	Height	Front Access	Usage
1	133mm (5.25in)	HH	Yes	open <sup>1</sup>
2	133mm (5.25in)	HH	Yes	CD-ROM
3	89mm (3.5in)	SL	Yes	Diskette
4 ... 8	89mm (3.5in)	SL	Yes	open <sup>2</sup>
9	89mm (3.5in)	SL	Yes	Std HDD <sup>3</sup>

1. Supports removable media devices only. Hard disk drives are not supported.

2. Maximum of six SCSI HDDs supported in SCSI models and a maximum of three IDE HDDs are supported without disconnecting the CD-ROM drive in IDE models.

3. The standard IDE HDD is installed in bay five in IDE models.

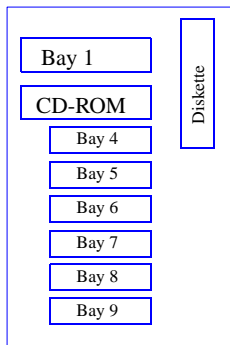

Part Number	Description	RPM	Height	Bays Supported <sup>3</sup>	Max Qty
<b>IDE HDD<sup>1, 2</sup></b>					
19K4461	20.4GB ATA-100 (EIDE) HDD	7200	SL	4...9	4 <sup>1</sup>
22P7157	40GB ATA-100 (EIDE) HDD	7200	SL	4...9	4 <sup>1</sup>
09N4207	60GB ATA-100 (EIDE) HDD	7200	SL	4...9	4 <sup>1</sup>
<b>Ultra160 SCSI HDDs<sup>2, 4</sup></b>					
00N8208	18.2GB 10,000rpm Ultra160 HDD	10000	SL	4...9	6
06P5750	18.2GB 10,000rpm Ultra160 HDD	10000	SL	4...9	6
00N8209	36.4GB 10,000rpm Ultra160 HDD	10000	SL	4...9	6
06P5751	36.4GB 10,000rpm Ultra160 HDD	10000	SL	4...9	6
06P5752	73.4GB 10,000rpm Ultra160 HDD	10000	SL	4...9	6
06P5765	18.2GB 15,000rpm Ultra160 HDD	15000	SL	4...9	6
19K0658	18.2GB 15,000rpm Ultra160 HDD	15000	SL	4...9	6
06P5766	36.4GB 15,000rpm Ultra160HDD	15000	SL	4...9	6
<b>Removable Media Devices<sup>5</sup></b>					<b>Bays Supported</b>
10K3785	12X-8X-32X CD-RW Drive, Black <sup>6</sup>	1, 2			
10K3790	8X-4X-32X-8X Max CD-RW/DVD-ROM Combination Drive <sup>6, 7</sup>	1, 2			
22P6950	16X Max RAM-Read DVD-ROM Drive, Black <sup>6</sup>	1, 2			
10K3782	48X-20X CD-ROM Drive, Black <sup>6</sup>	1, 2			
00N8078	250MB IDE Internal Zip Drive	1, 2			

1. IDE models support a maximum of four IDE devices including CD-ROM drives, IDE hard disk drives and IDE tape drives.

2. Mixing of IDE and SCSI hard disk drives is not supported.

3. Standard HDD installed in bay nine for SCSI models and bay five for IDE models.

4. SCSI models support a maximum of six SCSI HDDs.

5. Install only in removable media bays (133mm/5.25in width).

6. Either replace the standard CD-ROM or install in the available media bay.

An IDE cable with three connectors is included with the optional optical drive.

The included audio cable must be connected in order to support audio (for music CDs but not for DVD-ROM).

7. Some operating systems support the read function only.

**IntelliStation M Pro I/O Options (dual processor models)**

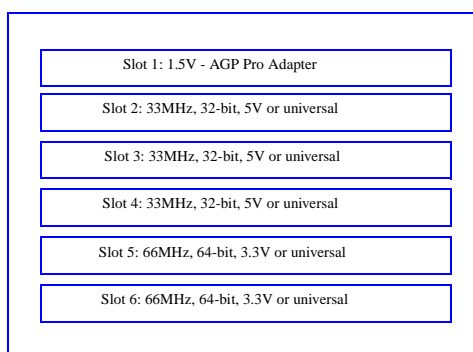

All slots are full-length.

Part Number	Description	Adapter Length	PCI Support <sup>1</sup>	Slots Supported <sup>2,3</sup>
<b>Storage Controllers<sup>4</sup></b>				
19K4646	PCI Wide Ultra160 SCSI Adapter <sup>5</sup>	Half	32-bit	2 ... 6
06P5740	ServeRAID-4Lx Ultra160 SCSI Controller <sup>6</sup>	Half	64-bit	2 ... 6
24P2585	IDE 100 RAID Controller by AMI <sup>7</sup>	Half	32-bit	2 ... 6
<b>Networking<sup>8</sup></b>				
<b>Ethernet<sup>9</sup></b>				
09N3601	10/100 EtherLink PCI Management Adapter by 3Com	Half	32-bit	2 ... 6
22P4501	Intel Pro/100S Desktop Adapter	Half	32-bit	2 ... 6
<b>Token Ring</b>				
34L5001	16/4 Token-Ring PCI Management Adapter	Half	32-bit	2 ... 6
34L5201	High-Speed 100/16/4 Token-Ring PCI Management Adapter	Half	32-bit	2 ... 6
<b>Communications<sup>10</sup></b>				

1. A 64-bit adapter installed into a 32-bit slot will transfer data at 32-bit rates. Adapters rated at 66MHz will operate at 33MHz when installed in a 33MHz slot.  
2. IntelliStation M Pro has six full-length PCI expansion slots.  
3. Slot one supports a standard AGP graphics adapter. When the standard graphics adapter is a Fire GL4, slot two is not available to install another adapter.  
4. IntelliStation M Pro includes integrated ATA-100 IDE and Ultra160 SCSI storage controllers.  
5. PCI Wide Ultra160 SCSI Adapter (P/N 19K4646) provides a single channel with one internal connector, a five-drop multi-mode terminated LVD SCSI cable and one external 0.8mm VHDCI connector. Only one of the two connectors may be utilised.  
6. ServeRAID-4Lx Ultra160 SCSI Controller is powered by a 100MHz Intel Zion GC80303 processor and provides a single channel, 32MB of ECC cache and either one internal or one external Ultra160 connection. External connector is 0.8mm VHDCI.  
7. Supported only in IDE models. Dual channel adapter includes two connectors, supporting one ATA-100 HDD per channel. Two 18in ATA-66 cables ship with the option. Allows RAID 0 and RAID 1 configurations.  
8. Wake on LAN® is not supported through the PCI networking adapters.  
9. The integrated full duplex 10/100 Intel-based Ethernet controller supports Wake on LAN.  
10. M Pro includes two USB ports, two high-speed serial/asynchronous ports (NS1650A software compatible) and one bidirectional parallel port supporting devices using EPP/ECP protocols.



**IntelliStation M Pro Power, Monitors, Accessories (dual processor models)**

Part Number	Description
<b>Power<sup>1,2</sup></b>	
94G7448	Rack Power Cable Type C12 (3.7m) <sup>2</sup>
<b>Monitors</b>	
T51U3xx <sup>4</sup>	P96 Color Monitor 19in (456mm, 17.9in viewable image), stealth black
T274Axx <sup>4</sup>	G78 Color Monitor 17in (406.4mm, 16in viewable image), stealth black
T57HGxx <sup>4</sup>	T750 Hybrid Flat Panel Color Monitor 17in (433mm, 17in viewable image), stealth black
T52U3xx <sup>4</sup>	P275 Color Monitor 21in (503mm, 19.8in viewable image), stealth black
T58HGxx <sup>4</sup>	T84H TFT LCD Color Monitor 18.1in (460mm, 18.1in viewable image), stealth black
T39U3xx <sup>4</sup>	P77 Color Monitor 17in (406mm, 16in viewable image), stealth black
T1U3Nxx <sup>4</sup>	P97 Color Monitor 19in (457.3mm, 18in viewable image), stealth black
T56HGxx <sup>4</sup>	T560 Hybrid Flat Panel Monitor 15in (381mm, 15in viewable image), stealth black
T4HB0xx <sup>4</sup>	T560 Hybrid Flat Panel Monitor 18.1in (460mm, 18.1in viewable image), stealth black
<b>Conversion Kits<sup>2</sup></b>	
10L7006	Tower-to-Rack Conversion Kit <sup>2</sup>
<b>Keyboard and Mouse<sup>3</sup></b>	
22P5xxx <sup>5</sup>	Rapid Access III USB Keyboard, stealth black
22P51xx <sup>6</sup>	Wireless Keyboard and Mouse
33L3252	SpaceBall 3D Input Device
33L3247	3-Button ScrollPoint Pro Mouse, Slate Blue

1. IntelliStation M Pro includes a 480W voltage-sensing power supply and a single standard country power cord.
2. If conversion to Rack format is being carried out, Rack Power Cable P/N 94G7448 (type C12) must be ordered if connection to a high voltage UPS or PDU is required.
3. IntelliStation M Pro ships with an IBM 104-key keyboard and three-button mouse as standard.
4. Where 'xx' represents a specific country code as follows: DK=Denmark, IS=Israel, IT=Italy, SD=Saudi Arabia, SA=South Africa, CH=Switzerland, UK=UK, EU=Europe.
5. Where 'xxx' represents a specific country code as follows: 189=Belgian/UK, 190=Danish, 191=Dutch, 192=French, 193=German, 194=Greek, 195=Icelandic, 196=Italian, 197=Norwegian, 198=Spanish, 199=Swedish/Finnish, 200=Swiss, 201=UK English, 202=US International, 205=Arabic
6. Where 'xx' represents a specific country code as follows: 73=Danish, 74=French, 75=German, 76=Italian, 77=Spanish, 78=UK English, 79=Swedish/Finnish, 80=Belgian/UK, 82=Swiss.

**IntelliStation M Pro Tape Options (dual processor models)**

Part Number	Tape Drives	Bays Supported	SCSI Interface (bit)	Form Factor	Termination Included	68/50-pin Converter Incl	Ext Tape Encl
20L0549	10/20GB TR5 Internal IDE Tape Drive	1	-	89mm (3.5in) SL or 133mm (5.25in) HH	-	-	-
09N4042	10/20GB NS Internal SCSI Tape Drive	1	8	89mm (3.5in) SL or 133mm (5.25in) HH	Y	Y	-

Note: An integrated Ultra160 SCSI controller with a five-drop multi-mode terminated LVD SCSI cable is standard. Single-ended devices attached to this cable will limit the entire SCSI bus to single-ended performance. Connecting an IDE tape drive to the standard IDE controller will limit the number of hard disk drives supported in IDE models.

Note: Additional tape attributes can be found in Appendix A: Tape Drive Attributes.



# IntelliStation R Pro

Part Number  
 Withdrawal Date: ddmmyy  
 Processor Speed<sup>2</sup>  
 Number of Processors (Std/Max)  
 L2 ECC Cache (KB)  
 Memory (Std/Max) (R = RDIMM)  
 Video Adapter  
 Form Factor  
 Onboard Ethernet (Mbps)  
 HDD Controller (EIDE, Ultra)  
 Removable Media Bays (Total/Avail)  
 Internal Hard Disk Drive (Std/Max)  
 CD-ROM (IDE)<sup>3</sup>  
 Bays (Tot/Av)  
 Slots (Tot/Av)<sup>4</sup>

## IntelliStation R Pro At-A-Glance

Part Number	Withdrawal Date	Processor Speed	Number of Processors	L2 ECC Cache	Memory	Video Adapter	Form Factor	Onboard Ethernet	HDD Controller	Removable Media Bays	Internal Hard Disk Drive	CD-ROM	Bays	Slots
KCK12xx <sup>1</sup>	-	1.13GHz	1/2	512	256MB/4GB	Matrox G200 PAL	Rack (1U)	2 x 10/100	IDE	-	20.4GB/80GB	24X-10X	4/1	2/0
KCK13xx <sup>1</sup>	-	1.13GHz	1/2	512	256MB/4GB	Matrox G200 PAL	Rack (1U)	2 x 10/100	U160 <sup>5</sup>	-	18.2GB/146.8GB	24X-10X	4/1	2/0
KET22xx <sup>1</sup>	-	1.26GHz	1/2	512	256MB/4GB	Matrox G200 PAL	Rack (1U)	2 x 10/100	IDE	-	20.4GB/80GB	24X-10X	4/1	2/0
KET23xx <sup>1</sup>	-	1.26GHz	1/2	512	256MB/4GB	Matrox G200 PAL	Rack (1U)	2 x 10/100	U160 <sup>5</sup>	-	18.2GB/146.8GB	24X-10X	4/1	2/0

- Housed in a 19in rack-mountable drawer. Ships standard with a keyboard and mouse. See Rack Cabinets and Options section for supported IBM racks (refer to xSeries 330 information).
- Intel Pentium III processor with 512KB advanced transfer L2 cache and 133MHz Front-side Bus (FSB).
- Variable read rate. Actual playback speed will vary and is often less than the maximum possible.
- All models are equipped with a Matrox G200 multimonitor video adapter and an IBM PCI audio adapter.
- This IntelliStation R Pro model has an integrated single-channel Ultra160 SCSI Controller.

## IntelliStation R Pro Processor Upgrades

Part Number	Processor Upgrades	SMP Support <sup>1</sup>	Processor Speed Upgrade <sup>2</sup>
25P2835	xSeries 1.13GHz/133MHz FSB - 512KB Cache Upgrade with Advanced Transfer Cache Pentium III Processor	KCK12xx, KCK13xx	-
25P2836	xSeries 1.26GHz/133MHz FSB - 512KB Cache Upgrade with Advanced Transfer Cache Pentium III Processor	KET22xx, KET23xx	KCK12xx, KCK13xx

- One additional processor may be installed, providing a maximum of two. All processors must be identical in type, speed, and cache size.
- Requires removal of the standard processor. A maximum of two processors may be installed. All processors must be identical in type, speed and cache size. Upgrades may require a BIOS update. To obtain the latest Flash BIOS, access [www.ibm.com/pc/support](http://www.ibm.com/pc/support) and enter machine "Type-Model" in Quick Path. Select "Downloadable files" and then "BIOS".

## IntelliStation R Pro Memory Configurator

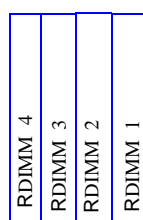

Total Memory <sup>1</sup>	Quantity of RDIMMs Added			
	128MB P/N 10K0018	256MB P/N 10K0020	512MB P/N 10K0022	1GB P/N 33L3326
256MB (1 x 256) Models				
384MB	1	-	-	-
512MB	2 or	1	-	-
640MB	3	-	-	-
768MB	-	2 or	1	-
1024MB	-	3	-	-
1280MB	-	-	2 or	1
1792MB	-	-	3	-
2048MB	-	-	4 <sup>2</sup>	-
2304MB	-	-	-	2
3328MB	-	-	-	3
4096MB (max)	-	-	-	4 <sup>2</sup>

Part Number	Memory Description <sup>1</sup>
10K0018	128MB PC133MHz ECC SDRAM RDIMM
10K0020	256MB PC133MHz ECC SDRAM RDIMM
10K0022	512MB PC133MHz ECC SDRAM RDIMM
33L3326	1GB PC133MHz ECC SDRAM RDIMM

- Memory RDIMMs must be installed in sequence from RDIMM connector 1 through connector 4. RDIMM size is not relevant.

- This table does not represent all possible memory configurations. Memory modules may vary in price per MB. Selection of smaller RDIMMs may provide a more cost-effective alternative to using larger RDIMMs.
- Network operating systems may limit the maximum amount of addressable memory. See operating system specifications for further information.
  - Requires removal of standard memory.



**IntelliStation R Pro Internal Hard Disk Drive (HDD) Configurator**

SCSI Models					
Total Int Storage <sup>1</sup>	10,000RPM HDDs			15,000RPM HDDs	
	18.2GB P/N 00N8208 or 06P5750	36.4GB P/N 00N8209 or 06P5751	73.4GB P/N 06P5752	18.2GB P/N 19K0658 or 06P5765	36.4GB P/N 06P5766
18.2GB	18.2GB (10,000 rpm) Standard on SCSI model)			18.2GB (10,000rpm) Standard on SCSI model)	
36.4GB	1	-	-	1	-
54.6GB	-	1	-	-	1
72.8GB <sup>2</sup>	-	2 <sup>2</sup>	-	-	2 <sup>2</sup>
91.6GB	-	-	1	-	-
146.8GB (max) <sup>2</sup>	-	-	2 <sup>2</sup>	-	-

This table does not represent all possible HDD configurations.

1. Select a total storage row then identify the recommended HDDs from within an RPM range according to choice. Total Internal Storage listed is within ± 0.2 GB unless otherwise noted.
2. Requires replacing standard HDD.

EIDE Models			
Total Internal Storage <sup>1,2</sup>	7200RPM EIDE HDDs		
	20.4GB P/N 19K4461	40GB P/N 22P7157	60GB P/N 09N4207
20.4GB	20.4GB (7200rpm) Std on EIDE model	-	-
40.8GB	1	-	-
60.4GB	-	1	-
80GB <sup>3</sup>	-	2 <sup>3</sup>	-
80.4GB	-	-	1
120GB <sup>3</sup>	-	-	2 <sup>3</sup>

This table does not represent all possible HDD configurations. Total Internal Storage listed is within +/-0.2GB unless otherwise noted.

1. Select a total storage row then add the quantity of HDDs from both columns to the standard HDD.
2. The R Pro dual integrated EIDE controllers support a maximum of three IDE devices per machine including one CD-ROM and two IDE HDDs.
3. Requires removal of the standard HDD.

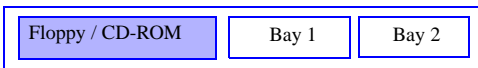

Bay	Form Factor	Height	Front Access	Usage	Part Number	Description	RPM	Height	Bays Supported	Max Qty
1 <sup>1</sup>	89mm (3.5in)	SL	Yes	HDD <sup>2</sup>	<b>IDE HDDs<sup>1,2</sup></b>					
2	89mm (3.5in)	SL	Yes	Open	19K4461	20.4GB 7200rpm ATA-100 (EIDE) HDD	7200	SL	1, 2	2
					22P7157	40GB 7200rpm ATA-100 (EIDE) HDD	7200	SL	1, 2	2
					09N4207	60GB 7200rpm ATA-100 (EIDE) HDD	7200	SL	1, 2	2
					<b>Non Hot-Swap Ultra160 SCSI HDDs<sup>2</sup></b>					
					00N8208	18.2GB 10,000rpm Ultra160 HDD	10000	SL	1, 2	2
					06P5750	18.2GB 10,000rpm Ultra160 HDD	10000	SL	1, 2	2
					00N8209	36.4GB 10,000rpm Ultra160 HDD	10000	SL	1, 2	2
					06P5751	36.4GB 10,000rpm Ultra160 HDD	10000	SL	1, 2	2
					06P5752	73.4GB 10,000rpm Ultra160 HDD	10000	SL	1, 2	2
					06P5765	18.2GB 15,000rpm Ultra160 HDD	15000	SL	1, 2	2
					19K0658	18.2GB 15,000rpm Ultra160 HDD	15000	SL	1, 2	2
					06P5766	36.4GB 15,000rpm Ultra160 HDD	15000	SL	1, 2	2

1. The R Pro dual integrated EIDE controllers support a maximum of three IDE devices per machine including one CD-ROM and two IDE hard disk drives. IDE HDDs are supported only on IDE models.
2. Mixing of IDE and SCSI hard disk drives is not supported.

**IntelliStation R Pro Power, Monitors, Accessories**

Part Number	Description
<b>Power<sup>1, 8</sup></b>	
94G7448	Rack Power Cable Type C12 (3.7m) <sup>8</sup>
<b>Uninterruptible Power Supply (UPS)<sup>2</sup></b>	
14RIxxx <sup>9</sup>	APC Smart-UPS 1400RMiB <sup>3</sup>
30RIxxx <sup>9</sup>	APC Smart-UPS 3000RMiB <sup>3</sup>
37L6862	APC Smart-UPS 5000RMiB <sup>4</sup>
<b>Monitors<sup>5</sup></b>	
T274Axx <sup>10</sup>	G78 Color Monitor 17in (406.4mm, 16in viewable image), stealth black <sup>6</sup>
T51U3xx <sup>10</sup>	P96 Color Monitor 19in (456mm, 17.9in viewable image), stealth black
T57HGxx <sup>10</sup>	T750 Hybrid Flat Panel Color Monitor 17in (433mm, 17in viewable image), stealth black
T58HGxx <sup>10</sup>	T84H TFT LCD Color Monitor 18.1in (460mm, 18.1in viewable image), stealth black
T3147xx <sup>10</sup>	E54 Color Monitor 15in (350mm, 13.8in viewable image), stealth black <sup>6</sup>
T3247xx <sup>10</sup>	E74 Color Monitor 17in (406mm, 16in viewable image), stealth black <sup>6</sup>
T52U3xx <sup>10</sup>	P275 Color Monitor 21in (503mm, 19.8in viewable image), stealth black
T1U3Nxx <sup>10</sup>	P97 Color Monitor 19in (457.3mm, 18in viewable image), stealth black
T39U3xx <sup>10</sup>	P77 Color Monitor 17in (406mm, 16in viewable image), stealth black
32P1032	NetBAY 1UFlat Panel Monitor Console Kit (without keyboard) <sup>7</sup>

1. IntelliStation R Pro includes a worldwide, voltage sensing 200W power supply with auto restart and a standard country power cord.
2. For runtimes and UPS attributes see Appendix C: UPS Runtime Estimate.
3. Height is 3U. See Rack Cabinets and Options section for supported IBM racks.
4. Height is 5U. See Rack Cabinets and Options section for supported IBM racks.
5. Third-party sourcing is required for connecting the rack-mounted R Pro system to remote workstation console devices. Keyboard, video and mouse (KVM) connectivity hardware for IntelliStation R Pro is not available through IBM but can be purchased through various vendors including the following:  
AmuletHotKey in London, England on the Web at [www.amulet-hotkey.com](http://www.amulet-hotkey.com) or telephone +44(0)20 7407 2522.  
Wey Technology AG in Rotkreuz, Germany at [info@wey.ch](mailto:info@wey.ch) (E-mail) or telephone +41 41 798 20 49.  
IBM makes no representations or warranties with respect to non-IBM products.  
These products are offered and warranted by third parties, not IBM.
6. Installation within a rack requires optional Monitor Compartment (P/N 94G7444).
7. Includes a 15in Flat Panel Monitor.
8. A Rack Power Cable P/N 94G7448 must be ordered for power connection to a high voltage rack-mounted UPS or PDU.
9. Where 'xxx' represents a specific country code as follows:- DEN=Denmark, ISR=Israel, ITA=Italy, SDI=Saudi Arabia, SAF=South Africa, SWS=Switzerland, UKM=United Kingdom, EUR=Europe.
10. Where 'xx' represents a specific country code as follows: DK=Denmark, IS=Israel, IT=Italy, SD=Saudi Arabia, SA=South Africa, CH=Switzerland, UK=UK, EU=Europe.

Part Number	Description
<b>Rack and NetBAY<sup>1, 2</sup></b>	
<b>NOTE:</b> Refer to the Rack Cabinets and Options section for details of IBM Racks and rack-supported devices.	
94G7448	Rack Power Cable Type C12 (3.7m) <sup>3</sup>
<b>Keyboard and Mouse<sup>4, 5</sup></b>	
28L36xx <sup>8</sup>	Space Saver II Keyboard <sup>6, 7</sup>
28L3675	Sleek 2-button Stealth Black Mouse

1. IntelliStation R Pro is housed in a 19in rack-mountable drawer and requires one of the racks listed in the Rack Cabinets and Options section for the xSeries 330.
2. Note limitations and restrictions required for adequate cooling in the Rack Cabinets and Options section for xSeries 330. If non-IBM racks are to be used, assure that both the front and rear doors offer a minimum of 48% open area uniformly distributed and in line with installed servers. A clearance of 51 to 64mm (2 to 2.5in) must be maintained between the front door and the system unit's front bezel. The rear door must maintain the same or greater clearance.
3. A Rack Power Cable P/N 94G7448 must be ordered for power connection to a high voltage rack-mounted UPS or PDU.
4. IntelliStation R Pro supports rack configurations only, and ships with a standard keyboard and mouse.
5. Third-party sourcing is required for connecting the rack-mounted R Pro system to remote workstation console devices. Keyboard, video and mouse (KVM) connectivity hardware for IntelliStation R Pro is not available through IBM but can be purchased through various vendors including the following:  
AmuletHotKey in London, England on the Web at [www.amulet-hotkey.com](http://www.amulet-hotkey.com) or telephone +44(0)20 7407 2522.  
Wey Technology AG in Rotkreuz, Germany at [info@wey.ch](mailto:info@wey.ch) (E-mail) or telephone +41 41 798 20 49.  
IBM makes no representations or warranties with respect to non-IBM products.  
These products are offered and warranted by third parties, not IBM.
6. Installation within a rack requires optional keyboard tray P/N 28L4707. The keyboard stows in a ready-to-use position.
7. Advanced TrackPoint IV features are not available on IntelliStation R Pro systems.
8. Where 'xx' represents a specific country code as follows:- 46=Danish, 47=France, 48=Germany, 49=Italian, 50=Spanish, 51=UK English, 44=US English, and P/N 19K3831=Switzerland, 19K3832=Sweden/Finland, 19K3833=Portugal, 19K3834=Belgium, 19K3836=Russia, 19K3837=Poland.







# IntelliStation Z Pro

Part Number  
 Withdrawal Date: ddmmyy  
 Processor Speed<sup>3</sup>  
 Number of Processors (Std/Max)  
 L3 ECC Cache  
 Memory (Std/Max)  
 Video Adapter  
 Form Factor  
 Onboard Ethernet (Mbps)  
 SCSI Controller (Dual, Ultra, RAID)  
 Removable Media Bays (Total/Avail)  
 Internal Hard Disk Drive (Std/Max)  
 CD-ROM (IDE)  
 Bays (Tot/Av)  
 Slots (Tot/Av)

IntelliStation Z Pro At-A-Glance														
KBK10xx <sup>1</sup>	28/12/01	800MHz	2/2	2MB	2GB/16GB	Matrox Millennium G450	Tower	10/100	D,U160 <sup>4</sup>	4/2	18.2GB/ 182GB	12X-8X- 32X <sup>5</sup>	9/7	8/6
KBK12xx <sup>1</sup>	28/12/01	800MHz	2/2	2MB	2GB/16GB	NVIDIA Quadro2 Pro	Tower	10/100	D,U160 <sup>4</sup>	4/2	36.4GB/ 182GB	12X-8X- 32X <sup>5</sup>	9/7	8/6
KBK14xx <sup>1,2</sup>	-	800MHz	2/2	2MB	2GB/16GB	Matrox Millennium G450	Tower	10/100	D,U160 <sup>4</sup>	4/2	18.2GB/ 182GB	12X-8X- 32X <sup>5</sup>	9/7	8/6
KBK16xx <sup>1,2</sup>	-	800MHz	2/2	2MB	2GB/16GB	NVIDIA Quadro2 Pro	Tower	10/100	D,U160 <sup>4</sup>	4/2	36.4GB/ 182GB	12X-8X- 32X <sup>5</sup>	9/7	8/6

Note: This system is currently targeted at early adopters such as the scientific community and developers who are interested in porting their code to take advantage of the technological benefits of the Itanium processor. Users are advised to check with their sales representative or the Intel Web site regarding availability of operating systems and applications.

- IntelliStation Z Pro ships with a US English keyboard and mouse. See Power, Monitors, Accessories section for a list of compatible monitors.
- This model is shipped preloaded with the Microsoft Windows XP 64-bit Edition operating system.
- Intel Itanium processor with advanced transfer ECC L3 cache and 2x133MHz FSB.
- IntelliStation Z Pro includes a dual channel Ultra160 SCSI controller installed in slot two. The controller provides two external 0.8mm VHDCI connectors on one channel and three internal connectors on the other channel. Two of the internal connectors are 68-pin, 16-bit Ultra160 (LVD) and the third is a 50-pin, 8-bit Ultra2 connector. A five-drop multi-mode terminated LVD SCSI cable is included.
- Variable read rate. Actual playback speed will vary and is often less than the maximum possible.

## IntelliStation Z Pro Memory Configurator

Memory Card A (top of card)

Bank 1- J4A1	Bank 1- J9A1
Bank 1- J4B1	Bank 1- J9B1
Bank 3- J4B2	Bank 3- J9B2
Bank 3- J4B3	Bank 3- J9B3

Memory Card B (top of card)

Bank 2- J4A1	Bank 2- J9A1
Bank 2- J4B1	Bank 2- J9B1
Bank 4- J4B2	Bank 4- J9B2
Bank 4- J4B3	Bank 4- J9B3

Part Number	Memory Description <sup>1</sup>
33L3258	1GB (4 x 256MB) PC100 ECC SDRAM DIMM KIT
33L3260	2GB (4 x 512MB) PC100 ECC SDRAM DIMM KIT
33L3262	4GB (4 x 1GB) PC100 ECC SDRAM DIMM KIT

1. Due to two- and four-way interleaving, all DIMMs installed in each of the two or four banks must be the same size to achieve maximum performance. Each of the four DIMMs installed in a bank must be the same size and each bank must contain four DIMMs if the bank is populated. DIMMs in other banks can be different sizes, which might affect performance. Install DIMMs in sequence bank one through four. All compatible memory options are available only in kits of four DIMMs.

Total Memory <sup>1</sup>	Quantity of DIMMs Added <sup>2</sup>			
	2GB Standard (4x 512MB)	1GB Kit (4 x 256MB) P/N 33L3258	2GB Kit (4 x 512MB) P/N 33L3260	4GB Kit (4 x 1GB) P/N 33L3262
3GB		1	-	-
4GB		2	-	-
5GB		1 and	1	-
6GB		-	2	-
7GB		1 and	2	-
8GB		-	3	-
9GB		1 and	1 and	1
10GB		-	2 and	1
11GB		1 and	-	2
12GB		-	1 and	2
13GB <sup>3</sup>		1 and	-	3
14GB		-	-	3
16GB <sup>3</sup> (max)		-	-	4 <sup>3</sup>

This table does not represent all possible memory configurations. Memory modules may vary in price per MB. Selection of smaller DIMMs may provide a more cost-effective alternative to using larger DIMMs.

- Network operating systems may limit the maximum amount of addressable memory. See operating system specifications for further information.
- To obtain the quantity of memory identified in the "Total Memory" column, select the appropriate row and order the quantity of DIMMs identified in all columns for that row, which will be added to the standard memory noted at the top of the far left column.
- Requires removal of standard DIMMs.



IntelliStation Z Pro Internal Hard Disk Drive (HDD) Configurator

Total Internal Storage <sup>1</sup>	10,000RPM HDDs	
	18.2GB P/N 00N8208	36.4GB P/N 00N8209
18.2GB	1 <sup>2</sup>	-
36.4GB	-	1 <sup>3</sup>
54.6GB	1	1
72.8GB	-	2
91GB	1	2
109.2GB	-	3
127.4GB	1	3
145.6GB	-	4
163.8GB	1	4
182GB <sup>4</sup>	-	5

Note: The HDD quantities shown are the total number required to achieve the desired storage amount. Adjust the HDDs to be ordered according to which model/configuration is the starting point

1. Select a total storage row and then add HDDs from both columns. Total Internal Storage is within +/- 0.2GB unless otherwise noted.
2. Standard on models P/N KBK10xx and KBK14xx.
3. Standard on models P/N KBK12xx and KBK16xx.
4. This HDD configuration requires replacement of the standard HDD on models P/N KBK10xx and KBK14xx.

Bay	Form Factor	Height	Front Access	Usage	Part Number	Description	RPM	Height	Bays Supported	Max Qty
1	133mm (5.25in)	HH	Yes	IDE CD-RW	<b>Non-Hot-Swap Ultra 160 SCSI HDDs</b>					
2	133mm (5.25in)	HH	Yes	open <sup>1</sup>	00N8208	18.2GB 10,000rpm Ultra160 HDD	10000	SL	4 ... 9 <sup>1</sup>	5 <sup>2</sup>
3	133mm (5.25in)	HH	Yes	open <sup>1</sup>	00N8209	36.4GB 10,000rpm Ultra160 HDD	10000	SL	4 ... 9 <sup>1</sup>	5 <sup>2</sup>
4 ... 8	89mm (3.5in)	SL	Yes	open	<b>Optical Devices</b>			<b>Bays Supported</b>		
9	89mm (3.5in)	SL	Yes	Std HDD	10K3785	12X-8X-32X Black Internal CD-RW Drive	1, 2, 3			

1. Supports removable media devices only. Hard disk drives are not supported.

1. The standard HDD is installed in bay nine.
2. The five-drop cable allows installation of a maximum of five HDDs.

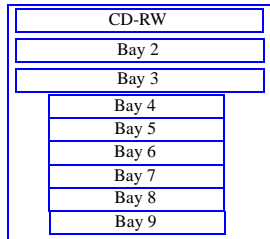

### IntelliStation Z Pro I/O Options

Part Number	Description	Adapter Length	PCI Support	Slots Supported <sup>2</sup>
<b>Storage Controllers</b>				
19K4646	PCI Wide Ultra160 SCSI Adapter <sup>1</sup>	Half	32-bit	1 ... 8

1. PCI Wide Ultra160 SCSI Adapter P/N 19K4646 provides a single channel with one internal connector, a five-drop multi-mode terminated LVD SCSI cable and one external 0.8mm VHDCI connector. Only one of the two connectors may be utilised.  
 2. A 64-bit adapter installed into a 32-bit slot will transfer data at 32-bit rates. Adapters rated at 66MHz will operate at 33MHz when installed in a 33MHz slot. 33MHz adapters will reduce 66MHz buses to 33MHz.

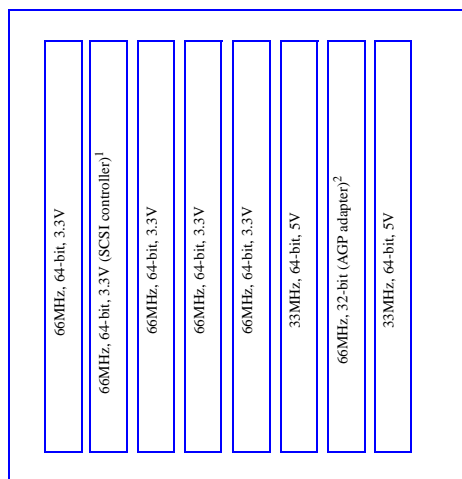

All slots are full-length.

1. Dual channel Ultra160 SCSI Adapter installed in slot two.
2. Supports Matrox Millennium G450 Graphics Accelerator with 16MB video memory (model P/N KBK10xx) or NVIDIA Quadro2 Pro with 64MB video memory (model P/N KBK12xx).

### IntelliStation Z Pro Power, Monitors, Accessories

Part Number	Description
<b>Power</b>	
	IntelliStation Z Pro includes an 800W voltage-sensing power supply and a single standard country power cord.
<b>Monitors</b>	
T51U3xx <sup>1</sup>	P96 Color Monitor 19in (456mm, 17.9in viewable image), stealth black
T274Axx <sup>1</sup>	G78 Color Monitor 17in (406.4mm, 16in viewable image), stealth black
T57HGxx <sup>1</sup>	T750 Hybrid Flat Panel Color Monitor 17in (433mm, 17in viewable image), stealth black
T52U3xx <sup>1</sup>	P275 Color Monitor 21in (503mm, 19.8in viewable image), stealth black
T39U3xx <sup>1</sup>	P77 Color Monitor 17in (406mm, 16in viewable image), stealth black
T1U3Nxx <sup>1</sup>	P97 Color Monitor 19in (457.3mm, 18in viewable image), stealth black
<b>Keyboard and Mouse</b>	
	IntelliStation Z Pro ships standard with an IBM US English keyboard and a three-button mouse.

1. Where 'xx' represents a specific country code as follows: DK=Denmark, IS=Israel, IT=Italy, SD=Saudi Arabia, SA=South Africa, CH=Switzerland, UK=UK, EU=Europe.





# xSeries Business Models Summary

*Product Family*  
*Withdrawal Date: ddmmyy*  
*Part Number*  
*Processor Speed (MHz)*  
*Number of Processors (Std/Max)*  
*L2 ECC Cache. (KB)*  
*Memory: (Std/Max)(R=RDIMM)<sup>5</sup>*  
*Form Factor*  
*Power Supply Quantity (Std/Max)*  
*Ethernet (Mbps)(OB=Onboard)*  
*Additional SCSI Controller (Part Number)*  
*Internal Hard Disk Drive Std (Quan/P/N)*  
*Bays (Total/Avail)*  
*Slots (Total/Avail)*  
*Std. Model P/N<sup>7</sup>*

BUSINESS MODELS <sup>1</sup>														
xSeries 200	-	K953Gxx	1.13GHz <sup>4</sup>	1/1	512	256MB/1.5GB <sup>6</sup>	Tower	1/1	10/100 <sup>OB</sup>	-	2 x 00N8208	7/3	5/4	K952Xxx
xSeries 220	-	K63BGxx	1.13GHz <sup>4</sup>	1/2	512	256MB <sup>R</sup> /4GB <sup>6</sup>	Tower	1/1	10/100 <sup>OB</sup>	06P5740	3 x 37L7205	7/2	5/4	K63AXxx
xSeries 232	-	P813Gxx	1GHz <sup>3</sup>	1/2	256	512MB <sup>R</sup> /4GB <sup>8</sup>	Tower	2/3	10/100 <sup>OB</sup>	06P5740	3 x 37L7205	10/5	5/4	-
xSeries 232	-	P823Gxx	1.13GHz <sup>4</sup>	1/2	512	512MB <sup>R</sup> /4GB <sup>8</sup>	Tower	2/3	10/100 <sup>OB</sup>	06P5740	3 x 37L7205	10/5	5/4	P822Xxx
xSeries 232	-	P843Gxx	1.26GHz <sup>4</sup>	1/2	512	512MB <sup>R</sup> /4GB <sup>8</sup>	Tower	2/3	10/100 <sup>OB</sup>	06P5740	3 x 37L7205	10/5	5/4	P842Xxx
xSeries 330	-	K414Gxx	1.13GHz <sup>4</sup>	2/2 <sup>2</sup>	512	512MB <sup>R</sup> /4GB <sup>7</sup>	Rack(1U)	1/1	2 x 10/100 <sup>OB</sup>	-	2 x 37L7205	4/0	2/2	K411Xxx
xSeries 330	-	K434Gxx	1.26GHz <sup>4</sup>	2/2 <sup>2</sup>	512	512MB <sup>R</sup> /4GB <sup>7</sup>	Rack(1U)	1/1	2 x 10/100 <sup>OB</sup>	06P5740	2 x 37L7205	4/0	2/1	K431Xxx
xSeries 342	-	K91TGxx	1GHz <sup>3</sup>	1/2	256	512MB <sup>R</sup> /4GB <sup>8</sup>	Rack(3U)	2/2	10/100 <sup>OB</sup>	06P5740	3 x 37L7205	7 <sup>9</sup> /2	5/4	2 x HS P/S
xSeries 342	-	K92TGxx	1.13GHz <sup>4</sup>	1/2	512	512MB <sup>R</sup> /4GB <sup>8</sup>	Rack(3U)	2/2	10/100 <sup>OB</sup>	06P5740	3 x 37L7205	7 <sup>9</sup> /2	5/4	2 x HS P/S
xSeries 342	-	K94TGxx	1.26GHz <sup>4</sup>	1/2	512	512MB <sup>R</sup> /4GB <sup>8</sup>	Rack(3U)	2/2	10/100 <sup>OB</sup>	06P5740	3 x 37L7205	7 <sup>9</sup> /2	5/4	2 x HS P/S



1. Business Models are standard models shipped with additional options already installed. They provide popular starting configurations that give a price advantage and enable easy installation. The Part Number that in most cases appears in the extreme righthand column, shows the standard model upon which the Business model is based. Refer to the appropriate product section and to this reference part number for more information.
2. One additional processor (of the same type and speed as the standard one) is supplied already installed with this Business Model.
3. Intel Pentium III processor with 133MHz FSB and 256KB advanced transfer cache.
4. Intel Pentium III processor with 133MHz FSB and 512KB advanced transfer cache.
5. High-speed 133MHz SDRAM.
6. The standard memory is replaced in this model with one 256MB DIMM - already installed.
7. One additional 256MB RDIMM memory option is supplied already installed with this Model.
8. The standard memory is replaced in this model with two 256MB DIMMs - already installed.
9. The optional 3-Pack Ultra160 Hot-Swap Expansion Kit (P/N 33L5050) is available, which converts the two available removable media bays into three slim-line (SL) hot-swap bays. This increases the Total Bays and Available Bays number by one (from 7/2 to 8/3), and also increases the total quantity of hot-swap bays from three to six. The available bays in this model would then all be hot-swap capable, allowing for installation of further hot-swap hard disks.



# Appliance Servers

## IBM xSeries 130/135

Part Number  
 Withdrawal Date: ddmmyy<sup>6</sup>  
 Processor Speed<sup>2</sup>  
 Number of Processors (Std/Max)  
 L2 ECC Cache (KB)  
 Memory (Std/Max) (R = RDIMM)  
 Form Factor  
 Power Supply Quantity (Std/Max)  
 Hot-Swap (Power, Slots, HDD, Fans)  
 Adv System Management Processor  
 Onboard Ethernet (Mbps)  
 Hard Disk Controller (EIDE, Ultra)  
 Removable Media Bays (Total/Avail)  
 Internal Hard Disk Drive (Std/Max)  
 CD-ROM (IDE)<sup>3</sup>  
 Bays (Tot/Av)  
 Slots (Tot/Av)

xSeries 130 At-A-Glance																
K225Xxx <sup>1,4</sup>	-	800MHz	1/1	128	256MB(R)/1.5GB	Rack (1U)	1/1	-	N	2 x 10/100	IDE	-	20.4GB/80GB	24X-10X	4/1	2/2
K45DXxx <sup>1,4</sup>	28/12/01	1GHz	1/2	256	256MB(R)/2GB	Rack (1U)	1/1	H	Y	2 x 10/100	U160	-	18.2GB/72.8GB	24X-10X	4/1	2/2
xSeries 135 At-A-Glance																
K224Xxx <sup>1,5</sup>	-	800MHz	1/1	128	256MB(R)/1.5GB	Rack (1U)	1/1	-	N	2 x 10/100	IDE	-	20.4GB/80GB	24X-10X	4/1	2/2
K45CXxx <sup>1,5</sup>	28/12/01	1GHz	1/2	256	256MB(R)/4GB	Rack (1U)	1/1	H	N	2 x 10/100	U160	-	18.2GB/72.8GB	24X-10X	4/1	2/2

1. Housed in a 19in rack-mountable drawer and ships standard without a keyboard or mouse. See Rack Cabinets and Options section for supported IBM racks.
2. Intel Pentium III processor with advanced transfer L2 cache and 133MHz Front-Side Bus (FSB). Models P/N K225Xxx and K224Xxx do not provide SMP support.
3. Variable read rate. Actual playback speed will vary and is often less than the maximum possible.
4. This system is a superior Web-hosting appliance delivering full X-architecture™ integration and system management capabilities. Powered by Windows 2000 technology, Microsoft Internet Information Services, and Web Server Accelerator, the x130 offers the performance and reliability for the most demanding e-business companies.
5. This system is a price/performance Web hosting solution based on Linux and IBM HTTP Server. The x135 is an ideal solution for customers who have chosen the open source architecture and are seeking the optimum price/performance solution for Web hosting.
6. Not available from IBM after this date. Business Partner inventory may be available.

### xSeries 130 / 135 Processor Upgrades

Part Number	Processor Upgrades Description	SMP Support <sup>1</sup>
10K0053	1GHz Upgrade with 133MHz FSB and 256KB Advanced Transfer Cache Pentium III Processor	K45CXxx, K45DXxx

1. One additional processor may be installed, providing a maximum of two. All processors must be identical in type, speed, and cache size. SMP support is not available for 800MHz models. Upgrading processor speed for 800MHz models requires removing the standard processor and installing one or two 1GHz processors.



**xSeries 130 / 135 Memory Configurator**

**Models P/N K45CXxx and K45DXxx**

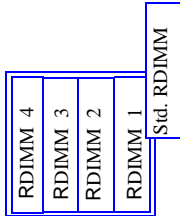

Part Number	Memory Description <sup>1</sup>
10K0018	128MB PC133 ECC SDRAM RDIMM
10K0020	256MB PC133 ECC SDRAM RDIMM
10K0022	512MB PC133 ECC SDRAM RDIMM
33L3326	1GB PC133 ECC SDRAM RDIMM

1. Memory RDIMMs must be installed in sequence from RDIMM connector 1 through connector 4. RDIMM size is not relevant.

Models P/N K45CXxx and K45DXxx				
Total System Memory <sup>1</sup>	Quantity of RDIMMs Added			
	128MB P/N 10K0018	256MB P/N 10K0020	512MB P/N 10K0022	1GB P/N 33L3326
1 x 256MB (std)				
384MB	1	-	-	-
512MB	2 or	1	-	-
640MB	3	-	-	-
768MB	-	2 or	1	-
1024MB	-	3	-	-
1280MB	-	-	2 or	1
1792MB	-	-	3	-
2048MB (max) <sup>2</sup>	-	-	4 or	2

This table does not represent all possible memory configurations. Memory modules may vary in price per MB. Selection of smaller RDIMMs may provide a more cost-effective alternative to using larger RDIMMs.

1. Network operating systems may limit the maximum amount of addressable memory. See operating system specifications for further information. Optimum performance occurs with 1GB total memory.
2. Requires removal of standard memory.

**Models P/N K224Xxx and K225Xxx**

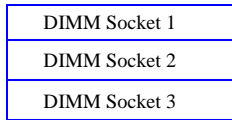

Part Number	Memory Description <sup>1</sup>
33L3081	128MB 133MHz ECC SDRAM Unbuffered DIMM Memory
33L3083	256MB 133MHz ECC SDRAM Unbuffered DIMM Memory
33L3085	512MB 133MHz ECC SDRAM Unbuffered DIMM Memory

Models P/N K224Xxx and K225Xxx			
Total System Memory <sup>1</sup>	Quantity of RDIMMs Added		
	128MB P/N 33L3081	256MB P/N 33L3083	512MB P/N 33L3085
1 x 256MB (std)			
384MB	1	-	-
512MB	2	-	-
640MB	1 and	1	-
768MB	-	2	-
1024MB	-	1 and	1
1280MB	-	-	2
1536MB (max) <sup>2</sup>	-	-	3

This table does not represent all possible memory configurations. Memory modules may vary in price per MB. Selection of smaller RDIMMs may provide a more cost-effective alternative to using larger RDIMMs.

1. Network Operating Systems may limit the maximum amount of addressable memory. See operating system specifications for further information. Optimum performance occurs with 1GB total memory.
2. Requires removal of standard memory.





**xSeries 130 / 135 Internal Hard Disk Drive (HDD) Configurator**

Models P/N K45CXxx and K45DXxx			
Total Int Storage <sup>1</sup>	10,000RPM SCSI HDDs		
	9.1GB P/N 37L7204	18.2GB P/N 37L7205	36.4GB P/N 37L7206
18.2GB	Standard on base models		
27.3GB	1	-	-
36.4GB	-	1	-
54.6GB	-	-	1
72.8GB (max) <sup>2</sup>	-	-	2 <sup>2</sup>

This table does not represent all possible HDD configurations.

1. Select a total storage row then add the quantity of HDDs from all columns to the standard HDD. Total Internal Storage listed is within +/- 0.2GB unless otherwise noted.
2. Maximum internal storage of 72.8GB (2x36.4GB) is achieved by replacing the standard HDD which is the software preload boot disk on this model. A Boot CD is shipped with the system which contains the software preload, enabling recovery to the standard configuration, if the standard disk is replaced.

Models P/N K45CXxx and K45DXxx					Models P/N K45CXxx and K45DXxx					
Bay	Form Factor	Height	Front Access	Usage	Part Number	Description	RPM	Height	Bays Supported	Max Qty
1 <sup>1</sup>	HS	SL	Yes	HDD	<b>Ultra160 SCSI HDDs</b>					
2	HS	SL	Yes	Open	37L7204	9.1GB 10K-4 Ultra160 SCSI Hot-Swap SL HDD	10000	SL	1 ... 2	2
					37L7205	18.2GB 10K-4 Ultra160 SCSI Hot-Swap SL HDD	10000	SL	1 ... 2	2
					37L7206	36.4GB 10K-4 Ultra160 SCSI Hot-Swap SL HDD	10000	SL	1 ... 2	2

1. Boot drive should be located in bay 1.

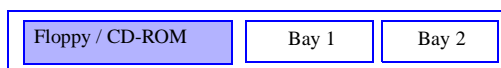

Models P/N K224Xxx and K225Xxx		
Total Int Storage <sup>1</sup>	7200RPM IDE HDDs <sup>2</sup>	
	20.4GB P/N 19K4461	40GB P/N 22P7157
20.4GB	Standard on EIDE models	
40.8GB	1	-
60.4GB	-	1
80GB (max) <sup>3</sup>	-	2 <sup>3</sup>

This table does not represent all possible HDD configurations. Total Internal Storage listed is within +/- 0.2GB unless otherwise noted.

1. Select a total storage row then add the quantity of HDDs from all columns to the standard HDD.
2. The xSeries 130/135 dual integrated EIDE controllers support a maximum of three IDE devices per system including one CD-ROM and two IDE HDDs.
3. Maximum internal storage of 80GB (2x40GB) is achieved by replacing the standard HDD which is the software preload boot disk on this model. A Boot CD is shipped with the system which contains the software preload, enabling recovery to the standard configuration, if the standard disk is replaced.



Models P/N K224Xxx and K225Xxx				
Bay	Form Factor	Height	Front Access	Usage
1 <sup>1</sup>	89mm (3.5in)	SL	Yes	HDD
2	89mm (3.5in)	SL	Yes	Open

1. Boot drive should be located in bay 1.

Models P/N K224Xxx and K225Xxx					
Part Number	Description	RPM	Height	Bays Supported	Max Qty
<b>IDE HDDs<sup>1</sup></b>					
19K4461	20.4GB 7200rpm ATA-100 (EIDE) HDD	7200	SL	1, 2	2
22P7157	40GB 7200rpm ATA-100 (EIDE) HDD	7200	SL	1, 2	2

1. Mixing of IDE and SCSI hard disk drives is not supported.

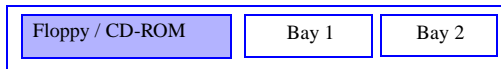

**xSeries 130 / 135 I/O Options**

Part Number	Description	Adapter Length	PCI Support	Slots Supported <sup>2</sup>
<b>Networking<sup>1</sup></b>				
22P6801	PRO/1000XT Server Adapter by Intel (with CD, manuals)	Half	64-bit	1, 2

1. xSeries 130 / 135 includes dual full-duplex, 10/100Mbps Ethernet controllers.  
 2. A 64-bit adapter installed into a 32-bit slot will transfer data at 32-bit rates. Adapters rated at 66MHz will operate at 33MHz when installed in a 33MHz slot. 133MHz PCI-X adapters are backward compatible with 33/66MHz, 64-bit PCI-based servers.



Exterior Connector Access



**xSeries 130 / 135 Power, Monitors, Accessories**

Part Number	Description
<b>Power<sup>1</sup></b>	
94G7448	Rack Power Cable Type C12 (3.7m) <sup>10</sup>
<b>Uninterruptible Power Supply (UPS)<sup>2</sup></b>	
14RIxxx <sup>11</sup>	APC Smart-UPS 1400RMiB <sup>3</sup>
30RIxxx <sup>11</sup>	APC Smart-UPS 3000RMiB <sup>3</sup>
37L6862	APC Smart-UPS 5000RMiB <sup>4</sup>
<b>Monitors<sup>5</sup></b>	
06P4792	Cable Chain Technology Cable Kit <sup>6,7</sup>
T3147xx <sup>12</sup>	E54 Color Monitor 15in (350mm, 13.8in Viewable Image Size), stealth black <sup>8</sup>
T3247xx <sup>12</sup>	E74 Color Monitor 17in (406mm, 16in Viewable Image Size), stealth black <sup>8</sup>
T274Axx <sup>12</sup>	G78 Color Monitor 17in (406.4mm, 16in Viewable Image Size), stealth black <sup>8</sup>
T11AGxx <sup>12</sup>	T540 Flat Panel Color Monitor 15in (381mm, 15in viewable image), stealth black <sup>9</sup>

1. The xSeries 130 / 135 includes a worldwide, voltage sensing 200W power supply with auto restart and a standard country line cords.
2. For runtimes and UPS attributes see Appendix C: UPS Runtime Estimate.
3. Height is 3U. See Rack Cabinets and Options section for supported IBM racks.
4. Height is 5U. See Rack Cabinets and Options section for supported IBM racks.
5. The xSeries 130 / 135 uses an SVGA controller (S-3 Savage4 chipset) with 8MB of video memory.
6. A Cable Chain Technology Cable Kit P/N 06P4792 (quantity one) is required for models P/N K45DXxx and K45CXxx to allow the attachment of one or multiple-chained xSeries 130/135s to Keyboard/Video/Mouse either directly or via a Console Switch. If attaching directly, the Console Breakout Cable included in the Kit connects from the system 'Out' port (or from the last one if multiple systems are chained together), to the K/V/M connectors. If attaching via a Console Switch, Console Cable P/N 09N4293 (2.1m/7ft) or P/N 94G7447 (3.6m/12ft) is required in addition to the kit and connects between the Console Breakout Cable and the Switch. Chaining technology is not applicable to models P/N K224Xxx and K225Xxx.
7. Each model P/N K45DXxx and K45CXxx ships with a Console Chaining Cable (254mm/10in), for connecting adjacent systems, thereby creating a console signal 'bus' that runs along a group of systems. The last system in the group then connects to console devices as described in note 6. Kit P/N 06P4792 also includes a longer Console Chaining Cable (2m/6.5ft) for use when the standard cable is not long enough. A maximum of 42 systems and no more than one Kit are allowed in one system chain.
8. Installation within a rack requires optional Monitor Compartment P/N94G7444.
9. Installation within a rack requires optional Flat Panel Monitor Rack Mount Kit II P/N 37L6888 and Rack Keyboard Tray P/N 28L4707. A space saver keyboard may coexist within the same keyboard tray.
10. Rack Power Cable P/N 94G7448 must be ordered for power connection to a high voltage UPS or PDU.
11. Where 'xxx' represents a specific country code as follows:- DEN=Denmark, ISR=Israel, ITA=Italy, SDI=Saudi Arabia, SAF=South Africa, SWS=Switzerland, UKM=United Kingdom, EUR=Europe
12. Where 'xx' represents a specific country code as follows:- DK=Denmark, IS=Israel, IT=Italy, SD=Saudi Arabia, SA=South Africa, CH=Switzerland, UK=UK, EU=Europe.

Part Number	Description
<b>Rack and NetBAY<sup>1,2</sup></b>	
94G7448	Rack Power Cable Type C12 (3.7m) <sup>9</sup>
<b>NOTE: Refer to the Rack Cabinets and Options section for details of IBM Racks and rack-supported devices.</b>	
<b>Keyboard and Mouse<sup>3</sup></b>	
06P4792	Cable Chain Technology Cable Kit <sup>4,5</sup>
28L36xx <sup>10</sup>	Space Saver II Keyboard <sup>6,8</sup>
28L36xx <sup>11</sup>	Preferred Keyboard (stealth black) <sup>7</sup>
28L3675	Sleek 2-button Stealth Black Mouse

1. xSeries 130 / 135 are housed in a 19in rack-mountable drawer and require one of the racks listed in the Rack Cabinets and Options section.
2. Note limitations and restrictions for adequate cooling in the Rack Cabinets and Options section. If non-IBM racks are used, assure that both the front and rear doors offer a minimum of 48% open area uniformly distributed and in line with the installed servers. A clearance of 51 to 64mm (2 to 2.5in) must be maintained between the front door and the system unit's front bezel. The rear door must maintain the same or greater clearance.
3. xSeries 130/135 supports rack configurations only and ships without a keyboard or mouse.
4. A Cable Chain Technology Cable Kit P/N 06P4792 (quantity one) is required for the attachment of one or multiple-chained xSeries 130/135 Models SDX/SCX to Keyboard/Video/Mouse either directly or via a Console Switch. If attaching directly, the Console Breakout Cable included in the Kit connects from the system 'Out' port (or from the last one if multiple systems are chained together), to the K/V/M connectors. If attaching via a Console Switch, Console Cable P/N 09N4293 (2.1m/7ft) or P/N 94G7447 (3.6m/12ft) is required in addition to the kit and connects between the Console Breakout Cable and the Switch.
5. Each x130/135 Model 5DX/5CX ships with a Console Chaining Cable (254mm/10in), for connecting adjacent systems, thereby creating a console signal 'bus' that runs along a group of systems. The last system in the group then connects to console devices as described in note 4. Kit P/N 06P4792 also includes a longer Console Chaining Cable (2m/6.5ft) for use when the standard cable is not long enough. A maximum of 42 systems and no more than one Kit are allowed in one system chain.
6. Installation within a rack requires optional keyboard tray P/N 28L4707 which stows in ready-to-use position.
7. Installation within a rack requires optional keyboard tray P/N 28L4707. This keyboard cannot share a keyboard tray with a flat panel display.
8. Advanced TrackPoint IV features are not available on IBM xSeries systems.
9. The xSeries 130 / 135 ships with a standard country power cord. For connection to a high voltage UPS or PDU, a Rack Power Cable P/N 94G7448 must be ordered.
10. Where 'xx' represents a specific country code as follows:- 46=Danish, 47=France, 48=Germany, 49=Italian, 50=Spanish, 51=UK English, 44=US English, and P/N 19K3831=Switzerland, 19K3832=Sweden/Finland, 19K3833=Portugal, 19K3834=Belgium, 19K3836=Russia, 19K3837=Poland.
11. Where 'xx' represents a specific country code as follows:- 25=French, 26=German, 27=Italian, 29=UK English, 31=Danish, 33=Norwegian, 34=Swedish/Finnish, 35=Swiss, 36=Dutch, 21=US English, and P/N 22P7325=Belgium/UK, 22P7323=Icelandic.





# Appliance Servers

## IBM xSeries 220 ICA

Part Number  
 Withdrawal Date: ddmmyy<sup>6</sup>  
 Processor Speed<sup>1</sup>  
 Number of Processors (Std/Max)  
 L2 ECC Cache (KB)  
 Memory (Std/Max) (R=RDIMM)  
 Form Factor  
 Power Supply Quantity (Std/Max)  
 Hot-Swap (Power, Slots, HDD, Fans)  
 Adv System Management Processor  
 Onboard Ethernet (Mbps)  
 SCSI Controller (Dual, Ultra, RAID)  
 Removable Media Bays (Total/Avail)  
 Internal Hard Disk Drive (Std/Max)  
 CD-ROM (IDE)<sup>3</sup>  
 Bays (Tot/Av)  
 Slots (Tot/Av)

xSeries 220 ICA At-A-Glance																
K534Xxx <sup>4,5</sup>	28/12/01	866MHz	1/2	256	256MB(R)/4GB	Tower	1/1	-	-	10/100	U160 <sup>2</sup>	4/2	18.2GB/ 145.6GB	48X-20X	7/4	5/5

- Intel Pentium III processor with advanced transfer L2 cache and 133MHz FSB.
- xSeries 220 Internet Caching Appliance (ICA) has an integrated Ultra160 SCSI Controller with a single internal channel and includes a five-drop, multi-mode terminated LVD SCSI cable.
- Variable read rate. Actual playback speed will vary and is often less than the maximum possible.
- Tower-tier ICA forward proxy software preloaded designed for small offices with up to 50 users.
- This appliance is preconfigured and optimised to support specific Internet applications per the Volera Excelerator V2.0 Internet Caching software licensing structure. Performance can be enhanced by installing additional memory, 15Krpm HDD storage, gigabit Ethernet adapters and additional or faster processors (impact of processor speed less significant than other options).
- Not available from IBM after this date. Business Partner inventory may be available.

### xSeries 220 ICA Processor Upgrades

Part Number	Processor Upgrades Description	SMP Support <sup>1</sup>	Processor Speed Upgrade <sup>2</sup>
10K3818	866MHz with 133MHz FSB and 256KB Advanced Transfer Cache Pentium III Upgrade Processor	K534Xxx	-
10K3819	933MHz with 133MHz FSB and 256KB Advanced Transfer Cache Pentium III Upgrade Processor	-	K534Xxx

- One additional processor may be installed, providing a maximum of two. All processors must be identical in type, speed, and cache size.
- Requires removal of the standard processor. A maximum of two processors may be installed. Optimal performance is achieved with the standard processor, i.e., upgrading the processor does not necessarily increase performance. Upgrades may require a BIOS update. To obtain the latest Flash BIOS, access [www.pc.ibm.com/support](http://www.pc.ibm.com/support) and enter machine "Type-Model" in Quick Path. Select "Downloadable files" and then "BIOS".

### xSeries 220 ICA Memory Configurator

Part Number	Memory Description	Total System Memory <sup>1</sup>	Quantity of RDIMMs Added			
			128MB	256MB	512MB	1GB
		<b>256MB (1x256) standard</b>	<b>P/N 10K0018</b>	<b>P/N 10K0020</b>	<b>P/N 10K0022</b>	<b>P/N 33L3326</b>
		384MB	1	-	-	-
		512MB	-	1	-	-
		640MB	1 and	1	-	-
		768MB	2 and	1	-	-
		1024MB	-	3	-	-
		1280MB	-	-	2	-
		1536MB	-	1 and	2	-
		1792MB	-	-	3	-
		2048MB <sup>2</sup>	-	-	4	-
		2560MB <sup>2</sup>	-	-	3 and	1
		3072MB <sup>2</sup>	-	-	2 and	2
		4096MB (max) <sup>2</sup>	-	-	-	4 <sup>2</sup>

This table does not represent all possible memory configurations. Memory modules may vary in price per MB. Selection of smaller RDIMMs may provide a more cost-effective alternative to using larger RDIMMs. Select the desired total memory from the appropriate column (Standard Model 256MB), then select a quantity in that row from one of the RDIMM columns.

- Network operating systems may limit the maximum amount of addressable memory. See operating system specifications for further information.
- Requires removal of standard memory.



**xSeries 220 ICA Internal Hard Disk Drive (HDD) and External Storage Configurator**

Total Internal Storage <sup>1</sup>	10,000RPM HDDs			15,000RPM HDD
	9.1GB P/N 00N8207	18.2GB P/N 00N8208	36.4GB P/N 00N8209	18.2GB P/N 19K0658
18.2GB	18.2GB (10,000rpm) Standard on the x220 ICA			18.2GB (10,000rpm ) Standard on the x220 ICA
27.3GB	1	-	-	-
36.4GB	-	1	-	1
54.6GB	-	2	-	2
72.8GB	-	3	-	3
91.0GB	-	-	2	-
109.2GB	-	1	2	-
127.4GB	-	-	3	-
145.6GB <sup>2</sup>	-	-	4 <sup>2</sup>	-

This table does not represent all possible HDD configurations.  
 1. Select a total storage row then identify the recommended HDDs from within an RPM range according to choice. Total Internal Storage listed is within ± 0.2 GB unless otherwise noted.  
 2. Maximum internal storage of 145.6GB (4x36.4GB) is achieved by replacing the standard HDD which is the software preload boot disk on this model. A Boot CD is shipped with the system which contains the software preload, enabling recovery to the standard configuration, if the standard disk is replaced.

Part Number	Description	RPM	Height	Bays Supported	Maximum Quantity
<b>Non-Hot-Swap Ultra160 Hard Disk Drives (HDD)</b>					
00N8207	9.1GB 10,000rpm Ultra160 SCSI HDD	10000	SL	4 ... 7	4
00N8208	18.2GB 10,000rpm Ultra160 SCSI HDD	10000	SL	4 ... 7	4
00N8209	36.4GB 10,000rpm Ultra160 SCSI HDD	10000	SL	4 ... 7	4
19K0658	18.2GB 15,000rpm Ultra160 SCSI HDD	15000	SL	4 ... 7	4

Note: Assuming adequate network bandwidth, adding HDD options has the greatest impact on forward proxy performance.

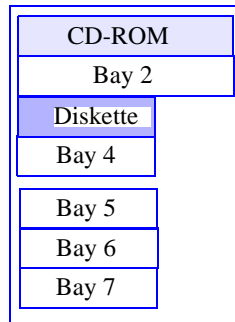

Bay	Form Factor	Height	Front Access	Usage
1	133mm (5.25in)	HH	yes	IDE CD-ROM
2	133mm (5.25in)	HH	yes	open <sup>1</sup>
3	89mm (3.5in)	SL	yes	Diskette
4	89mm (3.5in)	SL	yes	open
5	89mm (3.5in)	SL	yes	18.2GB HDD
6 ... 7	89mm (3.5in)	SL	yes	open

1. Supports removable media devices only. Hard drives are not supported.

### xSeries 220 ICA I/O Options

Part Number	Description	Adapter Length	PCI Support	Slots Supported <sup>1</sup>
<b>Storage Controllers<sup>2</sup></b>				
19K4646	PCI Wide Ultra160 SCSI Adapter <sup>3</sup>	Half	32-bit	1 ... 5
02K3454	PCI Fast/Wide Ultra SCSI Adapter <sup>4</sup>	Half	32-bit	1 ... 5
<b>Networking<sup>5</sup></b>				
<b>Ethernet<sup>6</sup></b>				
09N9901	10/100 EtherLink Server Adapter by 3Com <sup>7</sup>	Half	32-bit	1 ... 5
06P3601	10/100 Ethernet Server Adapter <sup>7</sup>	Half	32-bit	1 ... 5
06P3701	Gigabit Ethernet SX Server Adapter (fibre optic interface)	Half	64-bit	1 ... 5
<b>Token Ring</b>				
34L0701	Token-Ring 16/4 PCI Adapter 2 with Wake on LAN <sup>7</sup>	Half	32-bit	1 ... 5
34L5001	16/4 Token-Ring PCI Management Adapter <sup>7</sup>	Half	32-bit	1 ... 5
34L5201	High-Speed 100/16/4 Token-Ring PCI Management Adapter <sup>7</sup>	Half	32-bit	1 ... 5
<b>Systems Management</b>				
09N75xx <sup>8</sup>	Remote Supervisor Adapter	Half	32-bit	2

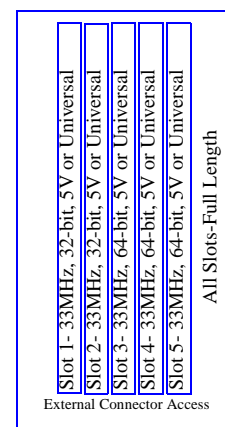

1. The xSeries 220 ICA has five full-length, 33MHz PCI expansion slots, three 64-bit and two 32-bit. A 64-bit adapter installed into a 32-bit slot will transfer data at 32-bit rates. Adapters rated at 66MHz will operate at 33MHz when installed in a 33MHz slot.
2. xSeries 220 ICA has an integrated Ultra160 SCSI Controller with a single internal channel and includes a five-drop, multi-mode terminated LVD SCSI cable.
3. PCI Wide Ultra160 SCSI Adapter P/N 19K4646 provides a single channel with one internal connector and a five-drop multi-mode terminated LVD SCSI cable and one external connector with a 0.8mm VHDCI connector. Only one of the two connectors may be utilised.
4. PCI Fast/Wide Ultra SCSI Adapter (P/N 02K3454) provides one external 68-pin high density connector that supports external SCSI devices such as tape enclosures.
5. The xSeries 220 includes an integrated full-duplex, 10/100Mbps Ethernet controller.
6. In a fault-tolerant networking environment, using the fault-tolerant software delivered with the Ethernet adapters of a single manufacturer is recommended. Installing fault-tolerant solutions provided by multiple manufacturers may cause failures if the intermediate drivers provided with the adapters are not compatible. The onboard Ethernet is Intel-based, which is compatible with the two Intel-based optional Ethernet adapters P/N 06P3601 and P/N 06P3701.
7. The Wake on LAN™ feature of this adapter is supported only in slot one.
8. Where 'xx' represents a specific country code as follows:- 86=Europe, 87=Denmark, 88=South Africa, 89=UK, 90=Switzerland, 91=Italy, 92=Israel, 85=USA.

### xSeries 220 ICA Power, Monitors, Accessories

Part Number	Description
<b>Power<sup>1,8</sup></b>	
94G7448	Rack Power Cable Type C12 (3.7m) <sup>8</sup>
<b>Free Standing Uninterruptible Power Supply (UPS)<sup>2</sup></b>	
SUP072Y	APC Smart-UPS 700
SUP102Y	APC Smart-UPS 1000
SUP142Y	APC Smart-UPS 1400
<b>Rack Mount Uninterruptible Power Supply (UPS)<sup>2</sup></b>	
14RIxxx <sup>9</sup>	APC Smart-UPS 1400RMiB <sup>3</sup>
30RIxxx <sup>9</sup>	APC Smart-UPS 3000RMiB <sup>3</sup>
37L6862	APC Smart-UPS 5000RMiB <sup>4</sup>
<b>Monitors<sup>5</sup></b>	
T3147xx <sup>10</sup>	E54 Color Monitor 15in (350mm, 13.8in Viewable Image Size), stealth black <sup>6</sup>
T3247xx <sup>10</sup>	E74 Color Monitor 17in (403mm, 15.9in Viewable Image Size), stealth black <sup>6</sup>
T274Axx <sup>10</sup>	G78 Color Monitor 17in (406.4mm, 16in Viewable Image Size), stealth black <sup>6</sup>
T11AGxx <sup>10</sup>	T540 Flat Panel Color Monitor 15in (381mm, 15in viewable image), stealth black <sup>7</sup>

1. The xSeries 220 ICA includes a 330W voltage sensing power supply and one standard country line cord.
2. For runtimes and UPS attributes see Appendix C: UPS Runtime Estimate.
3. Height is 3U. See Rack Cabinets and Options section for supported IBM racks.
4. Height is 5U. See Rack Cabinets and Options section for supported IBM racks.
5. The xSeries 220 ICA includes an integrated SVGA controller (S3 Savage4 Chipset) with 8MB of video memory.
6. Installation within a rack requires optional Monitor Compartment P/N 94G7444.
7. Installation within a rack requires optional Flat Panel Monitor Rack Mount Kit II P/N 37L6888 and Rack Keyboard Tray P/N 28L4707. A space saver keyboard may coexist within the same keyboard tray.
8. The xSeries 220 ICA ships with a standard country power cord. If conversion to Rack format is being carried out, Rack Power Cable P/N 94G7448 (type C12), must be ordered to allow connection to a high voltage UPS or PDU.
9. Where 'xxx' represents a specific country code as follows:- DEN=Denmark, ISR=Israel, ITA=Italy, SDI=Saudi Arabia, SAF=South Africa, SWS=Switzerland, UKM=United Kingdom, EUR=Europe.
10. Where 'xx' represents a specific country code as follows: DK=Denmark, IS=Israel, IT=Italy, SD=Saudi Arabia, SA=South Africa, CH=Switzerland, UK=UK, EU=Europe.



Part Number	Description
<b>Conversion Kits</b>	
09N4300	4Ux20D Tower-to-Rack Kit <sup>1,5</sup>
<b>Rack and NetBAY<sup>1,5</sup></b>	
94G7448	Rack Power Cable Type C12 (3.7m) <sup>5</sup>
<b>NOTE:</b> Refer to the Rack Cabinets and Options section for details of IBM Racks and rack-supported devices.	
<b>Keyboard and Mouse<sup>2</sup></b>	
28L36xx <sup>6</sup>	Space Saver II Keyboard <sup>3,4</sup>

1 Rack installation of an xSeries 220 ICA requires 4Ux20D Tower-to-Rack Kit P/N 09N4300 and one of the racks listed in the Rack Cabinets and Options section.

2. The xSeries 220 ICA includes both a mouse and non space saver keyboard.

3. Installation within a rack requires optional keyboard tray P/N 28L4707, which stows in ready-to-use position.

4. Advanced TrackPoint IV features are not available on IBM xSeries systems.

5. The xSeries 220 ICA ships with a standard country power cord. If conversion to Rack format and connection to a high voltage UPS or PDU is being carried out, a Rack Power Cable P/N 94G7448 (type C12), must be ordered.

6. Where 'xx' represents a specific country code as follows:- 46=Danish , 47=France, 48=Germany, 49=Italian, 50=Spanish, 51=UK English, 44=US English, 19K3831=Switzerland, 19K3832=Sweden/Finland, 19K3833=Portugal, 19K3834=Belgium, 19K3836=Russia, 19K3837=Poland.



# Appliance Server

## IBM xSeries 330 ICA

Part Number  
 Withdrawal Date: ddmmyy<sup>7</sup>  
 Processor Speed<sup>2</sup>  
 Number of Processors (Std/Max)  
 L2 ECC Cache (KB)  
 Memory (Std/Max) (R = RDIMM)  
 Form Factor  
 Power Supply Quantity (Std/Max)  
 Hot-Swap (Power, Slots, HDD, Fans)  
 Adv System Management Processor  
 Onboard Ethernet (Mbp)  
 SCSI Controller (Dual, Ultra, RAID)<sup>3</sup>  
 Removable Media Bays (Total/Avail)  
 Internal Hard Disk Drive (Std/Max)  
 CD-ROM (IDE)<sup>4</sup>  
 Bays (Tot/Av)  
 Slots (Tot/Av)

xSeries 330 ICA At-A-Glance																
K437Xxx <sup>1,5</sup>	28/12/01	866MHz	1/2	256	384MB(R)/4GB	Rack (1U)	1/1	H	Y	2 x 10/100	U160	-	36.4GB/72.8GB	24X-10X	4/0	2/2
K438Xxx <sup>1,6</sup>	28/12/01	866MHz	1/2	256	1GB(R)/4GB	Rack (1U)	1/1	H	Y	2 x 10/100	U160	-	18.2GB/72.8GB	24X-10X	4/1	2/2

- Housed in a 19in rack-mountable drawer and ships standard without a keyboard or mouse. See Rack Cabinets and Options section for supported IBM racks. These appliances are preconfigured and optimised to support specific Internet applications per the Volera Excelsator V2.0 Internet Caching software licensing structure. Performance can be enhanced by installing additional memory. 15Krpm HDD storage, gigabit Ethernet adapters and additional or faster processors (impact of processor speed less significant than other options).
- Intel Pentium III processor with advanced transfer L2 cache and 133MHz FSB.
- xSeries 330 ICA has an integrated single-channel Ultra160 SCSI Controller.
- Variable read rate. Actual playback speed will vary and is often less than the maximum possible.
- Workgroup-tier ICA forward proxy software preload designed for departments ranging up to 250 users.
- Workgroup-tier ICA reverse proxy software preload designed for small- to mid-range applications handling up to 3,500 requests per second.
- Not available from IBM after this date. Business Partner inventory may be available.

### xSeries 330 ICA Processor Upgrades

Part Number	Processor Upgrades	SMP Support <sup>1</sup>	Processor Speed Upgrade <sup>2</sup>
10K3806	866MHz Upgrade with 133MHz FSB and 256KB Advanced Transfer Cache Pentium III Processor	K437Xxx, K438Xxx	-
10K0052	933MHz Upgrade with 133MHz FSB and 256KB Advanced Transfer Cache Pentium III Processor	-	K437Xxx, K438Xxx
10K0053	1GHz Upgrade with 133MHz FSB and 256KB Advanced Transfer Cache Pentium III Processor	-	K437Xxx, K438Xxx

- One additional processor may be installed, providing a maximum of two. All processors must be identical in type, speed, and cache size.
- Requires removal of the standard processor. A maximum of two processors may be installed. Optimal performance is achieved with the standard processor, i.e., upgrading the processor does not necessarily increase performance. Upgrades may require a BIOS update. To obtain the latest Flash BIOS, access [www.pc.ibm.com/support](http://www.pc.ibm.com/support) and enter machine "Type-Model" in Quick Path. Select "Downloadable files" then "BIOS."

### xSeries 330 ICA Memory Configurator

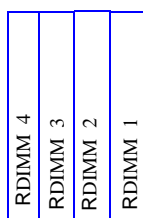

Part Number	Memory Description <sup>1</sup>
10K0018	128MB PC133 ECC SDRAM RDIMM
10K0020	256MB PC133 ECC SDRAM RDIMM
10K0022	512MB PC133 ECC SDRAM RDIMM
33L3326	1GB PC133 ECC SDRAM RDIMM

Memory amount has the greatest impact on reverse proxy performance.  
 1. Memory RDIMMs must be installed in sequence from RDIMM connector 1 through connector 4. RDIMM size is not relevant.

Total Memory <sup>1</sup>	Quantity of RDIMMs IN TOTAL			
	128MB P/N 10K0018	256MB P/N 10K0020	512MB P/N 10K0022	1GB P/N 33L3326
384MB <sup>2</sup>	1 and	1	-	-
512MB	2 and	1	-	-
640MB	3 and	1	-	-
768MB	2 and	2	-	-
1152MB	1 and	2 and	1	-
1024MB <sup>3</sup>	-	-	2	-
1408MB	1 and	1 and	2	-
2304MB <sup>4</sup>	-	1 and	2 and	1
2432MB <sup>5</sup>	1 and	1 and	-	2
3072MB <sup>4</sup>	-	-	2 and	2
4096MB (max) <sup>6</sup>	-	-	-	4

- Note: The DIMM quantities shown are the total number required to achieve the desired memory amount. Adjust the DIMMS to be ordered according to which model/configuration is the starting point**
- Network operating systems may limit the maximum amount of addressable memory. See operating system specifications for further information.
  - Model P/N K437Xxx ships standard with 1x128MB and 1x256MB RDIMMs.
  - Model P/N K438Xxx ships standard with 2x512MB RDIMMs.
  - Model P/N K437Xxx requires removing one or both standard RDIMMs for this configuration.
  - Model P/N K438Xxx requires removing the standard RDIMMs for this configuration.
  - Requires removal of standard memory.



**xSeries 330 ICA Internal Hard Disk Drive (HDD) and External Storage Configurator**

Total Int Storage <sup>1</sup>	Model P/N K437Xxx			
	10,000RPM HDDs			15,000RPM HDDs
	9.1GB P/N 37L7204	18.2GB P/N 37L7205	36.4GB P/N 37L7206	18.2GB P/N 19K0656
36.4GB	2 x 18.2GB (10,000rpm) Standard on this model			2 x 18.2GB (10,000rpm) Standard on this model
54.6GB	-	-	1 <sup>2</sup>	-
72.8GB <sup>3</sup> (max)	-	-	2 <sup>3</sup>	-

Assuming adequate network bandwidth, HDD storage typically has the greatest impact on forward proxy performance. This table does not represent all possible HDD configurations.

1. Select a total storage row then identify the recommended HDDs from within an RPM range according to choice. Total Internal Storage listed is within  $\pm 0.2$  GB unless otherwise noted.
2. Requires removal of standard HDD installed in bay two.
3. Maximum internal storage of 72.8GB (2x36.4GB) is achieved by replacing both standard HDDs which would include the replacement of the software preload boot disk on this model. A Boot CD is shipped with the system which contains the software preload, enabling recovery to the standard configuration, if the standard disk is replaced.

Total Int Storage <sup>1</sup>	Model P/N K438Xxx			
	10,000RPM HDDs			15,000RPM HDDs
	9.1GB P/N 37L7204	18.2GB P/N 37L7205	36.4GB P/N 37L7206	18.2GB P/N 19K0656
18.2GB	1 x 18.2GB (10,000rpm) Standard on this model			1 x 18.2GB (10,000rpm) Standard on this model
27.3GB	1	-	-	-
36.4GB	-	1	-	1
54.6GB	-	-	1	-
72.8GB <sup>2</sup> (max)	-	-	2 <sup>2</sup>	-

This table does not represent all possible HDD configurations.

1. Select a total storage row then identify the recommended HDDs from within an RPM range according to choice. Total Internal Storage listed is within  $\pm 0.2$  GB unless otherwise noted.
2. Maximum internal storage of 72.8GB (2x36.4GB) is achieved by replacing the standard HDD which is the software preload boot disk on this model. A Boot CD is shipped with the system which contains the software preload, enabling recovery to the standard configuration, if the standard disk is replaced.

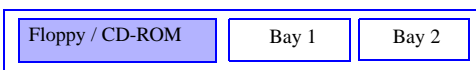

Bay	Form Factor	Height	Front Access	Usage	Part Number	Description	RPM	Height	Bays Supported	Max Qty
1 <sup>1</sup>	HS or 89mm (3.5in)	SL	Yes	18.2GB HDD	<b>Hot-swap Ultra160 HDDs</b>					
2	HS or 89mm (3.5in)	SL	Yes	Open <sup>2</sup>	37L7204	9.1GB 10K-4 Ultra160 SCSI Hot-Swap SL HDD	10000	SL	1 ... 2	2
					37L7205	18.2GB 10K-4 Ultra160 SCSI Hot-Swap SL HDD	10000	SL	1 ... 2	2
					37L7206	36.4GB 10K-4 Ultra160 SCSI Hot-Swap SL HDD	10000	SL	1 ... 2	2
					19K0656	18.2GB 15,000rpm Ultra160 SCSI Hot-Swap HDD	15000	SL	1 ... 2	2

1. Boot drive should be located in bay 1.
2. Model P/N K437Xxx includes two standard HDDs.

### xSeries 330 ICA I/O Options

Part Number	Description	Adapter Length	PCI Support	Slots Supported <sup>2</sup>
<b>Storage Controllers<sup>1</sup></b>				
19K4646	PCI Wide Ultra160 SCSI Adapter <sup>3</sup>	Half	32-bit	1, 2
02K3454	PCI Fast/Wide Ultra SCSI Adapter <sup>4</sup>	Half	32-bit	1, 2
<b>Networking<sup>5</sup></b>				
<b>Ethernet<sup>6</sup></b>				
06P3601	10/100 Ethernet Server Adapter <sup>7</sup>	Half	32-bit	1, 2
06P3701	Gigabit Ethernet SX Server Adapter (fibre optic interface)	Half	64-bit	1, 2
<b>Token Ring</b>				
34L5001	16/4 Token-Ring PCI Management Adapter <sup>7</sup>	Half	32-bit	1, 2
34L5201	High-Speed 100/16/4 Token-Ring PCI Management Adapter <sup>7</sup>	Half	32-bit	1, 2

1. xSeries 330 ICA has an integrated single-channel Ultra160 SCSI Controller.
2. A 64-bit adapter installed into a 32-bit slot will transfer data at 32-bit rates. Adapters rated at 66MHz will operate at 33MHz when installed in a 33MHz slot.
3. PCI Wide Ultra160 SCSI Adapter P/N 19K4646 provides a single channel with one internal connector and one external 0.8mm VHDCI connector. Support for external SCSI devices only. A five-drop terminated LVD SCSI cable is included but not supported for use in this server.
4. PCI Fast/Wide Ultra SCSI Adapter P/N 02K3454 provides one external 68-pin high density connector that supports external SCSI devices such as tape enclosures.
5. xSeries 330 ICA includes dual full-duplex, 10/100Mbps Ethernet controllers.
6. In a fault-tolerant networking environment, using the fault-tolerant software delivered with the Ethernet adapters of a single manufacturer is recommended. Installing fault-tolerant solutions provided by multiple manufacturers may cause failures if the intermediate drivers provided with the adapters are not compatible. The onboard Ethernet is Intel-based, which is compatible with the two Intel-based optional Ethernet adapters P/N 06P3601, and P/N 06P3701.
7. The Wake on LAN function of this option is not supported by this server.

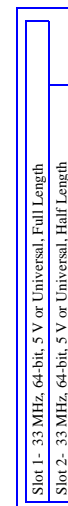

Exterior  
Connector  
Access

### xSeries 330 ICA Power, Monitors, Accessories

Part Number	Description
<b>Power<sup>1, 9</sup></b>	
94G7448	Rack Power Cable Type C12 (3.7m) <sup>9</sup>
<b>Uninterruptible Power Supply (UPS)<sup>2</sup></b>	
14RIxxx <sup>10</sup>	APC Smart-UPS 1400RMiB <sup>3</sup>
30RIxxx <sup>10</sup>	APC Smart-UPS 3000RMiB <sup>3</sup>
<b>Monitors<sup>4</sup></b>	
06P4792	Cable Chain Technology Cable Kit <sup>5, 6</sup>
T3147xx <sup>11</sup>	E54 Color Monitor 15in (350mm, 13.8in Viewable Image Size), stealth black <sup>7</sup>
T3247xx <sup>11</sup>	E74 Color Monitor 17in (403mm, 15.9in Viewable Image Size), stealth black <sup>7</sup>
T274Axx <sup>11</sup>	G78 Color Monitor 17in (406.4mm, 16in Viewable Image Size), stealth black <sup>7</sup>
T11AGxx <sup>11</sup>	T540 Flat Panel Color Monitor 15in (381mm, 15in viewable image), stealth black <sup>8</sup>

1. The xSeries 330 ICA includes a worldwide, voltage sensing 200W power supply and a standard country power cord.
2. For runtimes and UPS attributes see Appendix C: UPS Runtime Estimate.
3. Height is 3U. See Rack Cabinets and Options section for supported IBM racks.
4. xSeries 330 ICA uses an SVGA controller (S-3 Savage4 chipset) with 8MB of video memory.
5. A Cable Chain Technology Cable Kit P/N 06P4792 (quantity one) is required for the attachment of one or multiple-chained xSeries 330s to Keyboard/Video/Mouse either directly or via a Console Switch. If attaching directly, the Console Breakout Cable included in the Kit connects from the x330 'Out' port (or from the last x330 if multiple systems are chained together), to the K/V/M connectors. If attaching via a Console Switch, Console Cable P/N 09N4293 (2.1m/7ft) or P/N 94G7447 (3.6m/12ft) is required in addition to the kit and connects between the Console Breakout Cable and the Switch.
6. Each x330 ships with a Console Chaining Cable (254mm/10in), for connecting adjacent systems, thereby creating a console signal 'bus' that runs along a group of systems. The last system in the group then connects to console devices as described in note 5. Kit P/N 06P4792 also includes a longer Console Chaining Cable (2m/6.5ft) for use when the standard cable is not long enough. A maximum of 42 systems and no more than one Kit are allowed in one system chain.
7. Installation within a rack requires optional Monitor Compartment P/N94G7444.
8. Installation within a rack requires optional Flat Panel Monitor Rack Mount Kit II P/N 37L6888 and Rack Keyboard Tray P/N 28L4707. A space saver keyboard may coexist within the same keyboard tray.
9. Rack Power Cable P/N 94G7448 must be ordered for power connection to a high voltage UPS or PDU.
10. Where 'xxx' represents a specific country code as follows:- DEN=Denmark, ISR=Israel, ITA=Italy, SDI=Saudi Arabia, SAF=South Africa, SWS=Switzerland, UKM=United Kingdom, EUR=Europe
11. Where 'xx' represents a specific country code as follows:- DK=Denmark, IS=Israel, IT=Italy, SD=Saudi Arabia, SA=South Africa, CH=Switzerland, UK=UK, EU=Europe.



Part Number	Description
<b>Rack and NetBAY<sup>1, 2, 8</sup></b>	
94G7448	Rack Power Cable Type C12 (3.7m) <sup>9</sup>
NOTE: Refer to the Rack Cabinets and Options section for details of IBM Racks and rack-supported devices.	
<b>Keyboard and Mouse<sup>3</sup></b>	
06P4792	Cable Chain Technology Cable Kit <sup>4, 5</sup>
28L36xx <sup>10</sup>	Space Saver II Keyboard <sup>6, 7</sup>
28L36xx <sup>11</sup>	Preferred Keyboard (stealth black) <sup>8</sup>
28L3675	Sleek 2-button Stealth Black Mouse

1. xSeries 330 ICA is housed in a 19in rack-mountable drawer and requires one of the racks listed in the Rack Cabinets and Options section.
2. Note limitations and restrictions required for adequate cooling in the Rack Cabinets and Options section. If non-IBM racks are to be used, assure that both the front and rear doors offer a minimum of 48% open area uniformly distributed and in line with installed servers. A clearance of 51 to 64mm (2 to 2.5in) must be maintained between the front door and the system unit's front bezel. The rear door must maintain the same or greater clearance.
3. xSeries 330 ICA supports rack configurations only and ships without a keyboard or mouse.
4. A Cable Chain Technology Cable Kit P/N 06P4792 (quantity one) is required for the attachment of one or multiple-chained xSeries 330s to Keyboard/Video/Mouse either directly or via a Console Switch. If attaching directly, the Console Breakout Cable included in the Kit connects from the x330 'Out' port (or from the last x330 if multiple systems are chained together), to the K/V/M connectors. If attaching via a Console Switch, Console Cable P/N 09N4293 (2.1m/7ft) or P/N 94G7447 (3.6m/12ft) is required in addition to the kit and connects between the Console Breakout Cable and the Switch.
5. Each x330 ships with a Console Chaining Cable (254mm/10in), for connecting adjacent systems, thereby creating a console signal 'bus' that runs along a group of systems. The last system in the group then connects to console devices as described in note 4. Kit P/N 06P4792 also includes a longer Console Chaining Cable (2m/6.5ft) for use when the standard cable is not long enough. A maximum of 42 systems and no more than one Kit are allowed in one system chain.
6. Installation within a rack requires optional keyboard tray P/N 28L4707, which stows in ready-to-use position.
7. Advanced TrackPoint IV features are not available on IBM xSeries systems.
8. Installation within a rack requires optional keyboard tray P/N 28L4707. This keyboard cannot share a keyboard tray with a flat panel display.
9. Rack Power Cable P/N 94G7448 must be ordered for power connection to a high voltage UPS or PDU.
10. Where 'xx' represents a specific country code as follows:- 46=Danish, 47=France, 48=Germany, 49=Italian, 50=Spanish, 51=UK English, 44=US English, and P/N 19K3831=Switzerland, 19K3832=Sweden/Finland, 19K3833=Portugal, 19K3834=Belgium, 19K3836=Russia, 19K3837=Poland.
11. Where 'xx' represents a specific country code as follows:- 25=French, 26=German, 27=Italian, 29=UK English, 31=Danish, 33=Norwegian, 34=Swedish/Finnish, 35=Swiss, 36=Dutch, 21=US English, and P/N 22P7325=Belgium/UK, 22P7323=Icelandic.



# Appliance Server

## IBM xSeries 340 ICA

Part Number  
 Withdrawal Date: ddmmyy<sup>11</sup>  
 Processor Speed (MHz)<sup>2</sup>  
 Number of Processors (Std/Max)  
 L2 ECC Cache (KB)  
 Memory (Std/Max) (R = RDIMM)  
 Form Factor  
 Power Supply Quantity (Std/Max)  
 Hot-Swap (Power, Slots, HDD, Fans)  
 Redundancy (Optional, Standard)  
 Adv System Management Processor  
 Onboard Ethernet (Mbps)  
 SCSI Controller (Dual, Ultra, RAID)<sup>4</sup>  
 Removable Media Bays (Total/Avail)  
 Internal Hard Disk Drive (Std/Max)  
 CD-ROM (IDE)<sup>7</sup>  
 Bays (Tot/Av)  
 Slots (Tot/Av)

xSeries 340 ICA At-A-Glance																	
K645Xxx <sup>1,8</sup>	28/12/01	866MHz	1/2	256	768MB(R)/4GB	Rack (3U)	1/2	P, H, F	O - Power <sup>3</sup> S - Fans	Y	10/100	D,U160	4/2 <sup>5</sup>	54.6GB/ 109.2GB <sup>5</sup>	24X- 10X	7/2 <sup>5</sup>	5/5
K646Xxx <sup>1,9</sup>	28/12/01	866MHz	1/2	256	1.5GB(R)/4GB	Rack (3U)	2/2	P, H, F	S - Power S - Fans	Y	10/100	D,U160	4/0 <sup>5</sup>	109.2GB/ 218.4GB <sup>5,6</sup>	24X- 10X	8/0 <sup>6</sup>	5/5
K647Xxx <sup>1,10</sup>	28/12/01	866MHz	1/2	256	4GB(R)/4GB	Rack (3U)	1/2	P, H, F	O - Power <sup>3</sup> S - Fans	Y	10/100	D,U160	4/2 <sup>5</sup>	54.6GB/ 109.2GB <sup>5</sup>	24X- 10X	7/2 <sup>5</sup>	5/5

- Housed in a 19in rack-mountable drawer and ships standard without a keyboard or mouse. See Rack Cabinets and Options section for supported IBM racks. These appliances are preconfigured and optimised to support specific Internet applications per the Volera Excelsator V2.0 Internet Caching software licensing structure. Performance can be enhanced by installing additional memory, 15Krpm HDD storage, gigabit Ethernet adapters and additional or faster processors (impact of processor speed less significant than other options).
- Intel Pentium III processor with advanced transfer L2 cache and 133MHz FSB.
- Power supply redundancy requires installation of optional 270W Hot-Swap Redundant Power Supply P/N 37L6879.
- xSeries 340 ICA includes a dual-port, dual-channel Ultra160 SCSI controller for internal use only. No standard external port is available. Due to xSeries 340 ICA's low profile, some adapters with connectors on the top edge may not have sufficient clearance to attach a cable.
- xSeries 340 ICA includes two available removable media bays that can be converted to three slim-line (SL) hot-swap bays with the addition of optional 3-pack Ultra160 Hot-Swap Expansion Kit P/N 33L5050, doubling internal hard disk drive storage capacity. Model P/N K646Xxx ships standard with the 3-Pack Expansion Kit already installed.
- Includes the 3-Pack Ultra160 Hot-Swap Expansion Kit P/N 33L5050, which converts the two available removable media bays into three slim-line (SL) hot-swap bays.
- Variable read rate. Actual playback speed will vary and is often less than the maximum possible.
- Department-tier ICA forward proxy software preload designed for enterprises with up to 500 users.
- Enterprise-tier ICA forward proxy software preload designed for ISPs and large enterprises with up to 1,000 users.
- Enterprise-tier ICA reverse proxy software preload designed for commercial or large-site operations handling up to 20,000 requests per second.
- Not available from IBM after this date. Business Partner inventory may be available.

### xSeries 340 ICA Processor Upgrades

Part Number	Processor Upgrades	SMP Support <sup>1</sup>	Processor Speed Upgrade <sup>2</sup>
19K4630	866MHz 133MHz FSB/256KB Upgrade with Pentium III Processor	K645Xxx, K646Xxx, K647Xxx	-
19K4631	933MHz 133MHz FSB/256KB Upgrade with Pentium III Processor	-	K645Xxx, K646Xxx, K647Xxx
19K4640	1GHz Upgrade with 133MHz FSB and 256KB Advanced Transfer Cache Pentium III Processor	-	K645Xxx, K646Xxx, K647Xxx

- One additional processor may be installed, providing a maximum of two. All processors must be identical in type, speed, and cache size.
- Requires removal of the standard processor. A maximum of two processors may be installed. Optimal performance is achieved with the standard processor, i.e., upgrading the processor does not necessarily increase performance. Upgrades may require a BIOS update. To obtain the latest Flash BIOS, access [www.pc.ibm.com/support](http://www.pc.ibm.com/support) and enter machine "Type-Model" in Quick Path. Select "Downloadable files" then "BIOS."



### xSeries 340 ICA Memory Configurator

RDIMM Socket 4
RDIMM Socket 3
RDIMM Socket 2
RDIMM Socket 1

Recommended order of installation:  
Slot 1-2-3-4

Part Number	Memory Description <sup>1</sup>
10K0018	128MB PC133 ECC SDRAM RDIMM
10K0020	256MB PC133 ECC SDRAM RDIMM
10K0022	512MB PC133 ECC SDRAM RDIMM
33L3326	1GB PC133 ECC SDRAM RDIMM

Memory amount has the greatest impact on reverse proxy performance.

1. The recommended order of installation is in sequence from Socket 1 to Socket 4.  
Memory size is not a factor.

	Quantity of RDIMMs IN TOTAL			
	128MB	256MB	512MB	1GB
	PN 10K0018	P/N 10K0020	P/N 10K0022	P/N 33L3326
768MB <sup>2</sup>		1 and	1	-
896MB	1 and	1 and	1	-
1536MB <sup>3</sup>	-	-	1 and	1
1920MB	1 and	1 and	1 and	1
2176MB	-	2 and	1 and	1
2432MB	-	1 and	2 and	1
2816MB	-	1 and	1 and	2
3072MB <sup>4</sup>	-	-	2 and	2
3584MB <sup>4</sup>	-	-	1 and	3
4096MB (max) <sup>5,6</sup>	-	-	-	4

**Note: The DIMM quantities shown are the total number required to achieve the desired memory amount. Adjust the DIMMS to be ordered according to which model/configuration is the starting point.**

1. Network operating systems may limit the maximum amount of addressable memory. See operating system specifications for further information.
2. Model P/N K645Xxx ships standard with 1x256MB and 1x512MB RDIMMs.
3. Model P/N K646Xxx ships standard with 1x512MB and 1x1GB RDIMMs.
4. Model P/N K645Xxx requires removal of one standard RDIMM to support this configuration.
5. Requires removal of standard memory for models P/N K645Xxx and K646Xxx.
6. Model P/N K647Xxx ships standard with 4x1GB RDIMMs.

### xSeries 340 ICA Internal Hard Disk Drive (HDD) and External Storage Configurator

Total Int Storage <sup>1</sup>	Models P/N K645Xxx and P/N K647Xxx			
	10,000RPM HDDs			15,000RPM HDDs
	9.1GB P/N 37L7204	18.2GB P/N 37L7205	36.4GB P/N 37L7206	18.2GB P/N 19K0656
54.6GB	3 x 18.2GB (10,000rpm) Standard on this model			3 x 18.2GB (10,000rpm) Standard on this model
91.0GB	-	2 <sup>2</sup>	-	2 <sup>2</sup>
109.2GB	-	3 <sup>2</sup>	-	3 <sup>2</sup>
163.8GB	-	-	3 <sup>2</sup>	-
182.0GB	-	-	4 <sup>2,3</sup>	-
200.2GB	-	-	5 <sup>2,3</sup>	-
218.4GB <sup>4</sup>	-	-	6 <sup>4</sup>	-

Assuming adequate network bandwidth, HDD storage typically has the greatest impact on forward proxy performance.  
This table does not represent all possible HDD configurations.

1. Select a total storage row then identify the recommended HDDs from within an RPM range according to choice. Total Internal Storage listed is within ± 0.2 GB unless otherwise noted.
2. Assumes installation of optional 3-Pack Ultra160 Hot-Swap Expansion Kit P/N 33L5050.
3. Requires replacement of one or more standard HDDs.
4. Internal storage of 218.4GB (6x36.4GB) is achieved by installing optional 3-Pack Ultra160 Hot-Swap Expansion Kit P/N 33L5050 and by replacing all standard HDDs which would include the software preload boot disk on this model. A Boot CD is shipped with the system which contains the software preload, enabling recovery to the standard configuration, if the standard disk is replaced.

Total Int Storage <sup>1</sup>	Model P/N K646Xxx			
	10,000RPM HDDs			15,000RPM HDDs
	9.1GB P/N 37L7204	18.2GB P/N 37L7205	36.4GB P/N 37L7206	18.2GB P/N 19K0656
109.2GB	6 x 18.2GB 10Krpm standard on this model			6 x 18.2GB 10Krpm standard on this model
127.4GB	-	-	1 <sup>2</sup>	-
145.6GB	-	-	2 <sup>2</sup>	-
163.8GB	-	-	3 <sup>2</sup>	-
182.0GB	-	-	4 <sup>2</sup>	-
200.2GB	-	-	5 <sup>2</sup>	-
218.4GB(max) <sup>3</sup>	-	-	6 <sup>3</sup>	-

Assuming adequate network bandwidth, HDD storage typically has the greatest impact on forward proxy performance.

This table does not represent all possible HDD configurations.

1. Select a total storage row then identify the recommended HDDs from within an RPM range according to choice. Total Internal Storage listed is within ± 0.2 GB unless otherwise noted.

2. Requires replacement of one or more standard HDDs

3. Maximum internal storage of 218.4GB (6x36.4GB) is achieved by replacing all standard HDDs which would include the software preload boot disk on this model. A Boot CD is shipped with the system which contains the software preload, enabling recovery to the standard configuration, if the standard disk is replaced.

Bay	Form Factor	Height	Front Access	Usage	Part Number	Description	RPM	Height	Bays Supported <sup>1</sup>	Max Qty <sup>1</sup>
-	89mm (3.5in)	-	Yes	Diskette	<b>Ultra160 HDDs</b>					
-	133mm (5.25in)	-	Yes	IDE CD-ROM	37L7204	9.1GB 10K-4 Ultra160 SCSI Hot-Swap SL HDD	10000	SL	1 ... 6	6
1 ... 3	HS	SL	Yes	HDD	37L7205	18.2GB 10K-4 Ultra160 SCSI Hot-Swap SL HDD	10000	SL	1 ... 6	6
A, B	133mm (5.25in)	HH <sup>1</sup>	Yes	HDD	37L7206	36.4GB 10K-4 Ultra160 SCSI Hot-Swap SL HDD	10000	SL	1 ... 6	6
4 ... 6 <sup>2</sup>	HS	SL	Yes	HDD	19K0656	18.2GB 15,000rpm Ultra160 SCSI Hot-Swap HDD	15000	SL	1 ... 6	6
<b>Associated Options</b>										
					33L5050	IBM 3-Pack Ultra160 Hot-Swap Expansion Kit <sup>2</sup>	-	3 x SL	4 ... 6	-

1 By installing xSeries 3-Pack Ultra160 Hot-Swap Expansion Kit P/N 33L5050, bays A and B are transformed into three SL hot-swap bays 4 ... 6.  
2. Model P/N K646Xxx ships with 3-Pack Ultra160 Hot-Swap Expansion Kit P/N 33L5050 and six 18.2GB HDDs already installed.

1. xSeries 340 ICA Models P/N K645Xxx and K647Xxx ship with Bays 1 ... 3 enabled. Model P/N K646Xxx ships with all six bays enabled, which includes installation of 3-Pack Ultra160 Hot-Swap Expansion Kit P/N 33L5050.  
2. 3-Pack Ultra160 Hot-Swap Expansion Kit P/N 33L5050 includes a hot-swap backplane and associated components for two cabling options. The backplane may be cabled directly to the second integrated SCSI channel or supported by the same SCSI channel as the standard backplane through the use of an included repeater card.

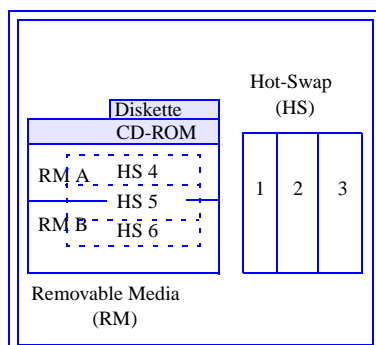



**xSeries 340 ICA I/O Options**

Part Number	Description	Adapter Length	PCI Support	Slots Supported <sup>2</sup>
<b>Storage Controllers<sup>1</sup></b>				
19K4646	PCI Wide Ultra160 SCSI Adapter <sup>3</sup>	Half	32-bit	1 ... 5
02K3454	PCI Fast/Wide Ultra SCSI Adapter <sup>4</sup>	Half	32-bit	1 ... 5
<b>Networking<sup>5</sup></b>				
<b>Ethernet<sup>6</sup></b>				
06P3601	10/100 Ethernet Server Adapter <sup>7</sup>	Half	32-bit	1 ... 5
06P3701	Gigabit Ethernet SX Server Adapter (fibre optic interface)	Half	64-bit	1 ... 5
09N9901	10/100 EtherLink Server Adapter by 3Com <sup>7</sup>	Half	32-bit	1 ... 5
<b>Token Ring<sup>7</sup></b>				
34L0701	Token-Ring 16/4 PCIAdapter 2 with Wake on LAN <sup>7</sup>	Half	32-bit	1 ... 5
34L5001	16/4 Token-Ring PCI Management Adapter <sup>7</sup>	Half	32-bit	1 ... 5
34L5201	High-Speed 100/16/4 Token-Ring PCI Management Adapter <sup>7</sup>	Half	32-bit	1 ... 5

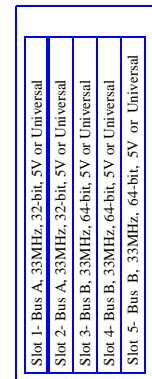

Exterior Connector Access

All Slots - Full Length

- xSeries 340 ICA includes a dual-port, dual-channel Ultra160 SCSI controller for internal use only. No standard external port is available. See "Internal SCSI Cabling" in xSeries 340 section for cabling alternatives. Due to xSeries 340 ICA's low profile, some adapters with connectors on the top edge may not have sufficient clearance to attach a cable.
- A 64-bit adapter installed into a 32-bit slot will transfer data at 32-bit rates. Adapters rated at 66MHz will operate at 33MHz when installed in a 33MHz slot.
- PCI Wide Ultra 160 SCSI Adapter P/N 19K4646 provides a single channel with one internal connector, a five-drop multi-mode terminated LVD SCSI cable and one external 0.8mm VHDCI connector. Only one of the two connectors may be utilised.
- PCI Fast/Wide Ultra SCSI Adapter provides one external 68-pin high density connector. The internal connectors are not accessible due to a cabling interference.
- xSeries 340 ICA includes a full-duplex, 10/100Mbps Ethernet PCI controller.
- In a fault-tolerant networking environment, using the fault-tolerant software delivered with the Ethernet adapters of a single manufacturer is recommended. Installing fault-tolerant solutions provided by multiple manufacturers may cause failures if the intermediate drivers provided with the adapters are not compatible. The onboard Ethernet is AMD-based. Two of the optional PCI Ethernet adapters listed are Intel-based - P/Ns 06P3601 and P/N 06P3701.
- The Wake on LAN function of this option is not supported by this server.

**xSeries 340 ICA Power, Monitors, Accessories**

Part Number	Description
<b>Power<sup>1,8</sup></b>	
37L6879	270W Hot-Swap Redundant Power Supply <sup>1,8</sup>
94G7448	Rack Power Cable Type C12 (3.7m) <sup>8</sup>
<b>Uninterruptible Power Supply (UPS)<sup>2</sup></b>	
14RIxxx <sup>9</sup>	APC Smart-UPS 1400RMiB <sup>3</sup>
30RIxxx <sup>9</sup>	APC Smart-UPS 3000RMiB <sup>3</sup>
37L6862	APC Smart-UPS 5000RMiB <sup>4</sup>
<b>Monitors<sup>5</sup></b>	
T3147xx <sup>10</sup>	E54 Color Monitor 15in (350mm, 13.8in Viewable Image Size), stealth black <sup>6</sup>
T3247xx <sup>10</sup>	E74 Color Monitor 17in (403mm, 15.9in Viewable Image Size), stealth black <sup>6</sup>
T274Axx <sup>10</sup>	G78 Color Monitor 17in (406.4mm, 16in Viewable Image Size), stealth black <sup>6</sup>
T11AGxx <sup>10</sup>	T540 Flat Panel Color Monitor 15in (381mm, 15in viewable image), stealth black <sup>7</sup>

- xSeries 340 ICA systems include a single 270W, hot-swap power supply and a single standard country power cord. Power supply redundancy can be achieved with the addition of optional 270W Hot-Swap Redundant Supply P/N 37L6879.
- For runtimes and UPS attributes see Appendix C: UPS Runtime Estimate.
- Height is 3U. See Rack Cabinets and Options section for supported IBM racks.
- Height is 5U. See Rack Cabinets and Options section for supported IBM racks.
- xSeries 340 ICA uses an SVGA controller (S3 Savage4 chipset) with 8MB of video memory.
- Installation within a rack requires optional Monitor Compartment P/N 94G7444.
- Installation within a rack requires optional Flat Panel Monitor Rack Mount Kit II P/N 37L6888 and Rack Keyboard Tray P/N 28L4707. A space saver keyboard may coexist within the same keyboard tray.
- Rack Power Cable P/N 94G7448 (one for each power supply), must be ordered for power connection to a high voltage UPS or PDU.
- Where 'xxx' represents a specific country code as follows:- DEN=Denmark, ISR=Israel, ITA=Italy, SDI=Saudi Arabia, SAF=South Africa, SWS=Switzerland, UKM=United Kingdom, EUR=Europe
- Where 'xx' represents a specific country code as follows:- DK=Denmark, IS=Israel, IT=Italy, SD=Saudi Arabia, SA=South Africa, CH=Switzerland, UK=UK, EU=Europe.





Part Number	Description
<b>Rack and NetBAY<sup>1,6</sup></b>	
94G7448	Rack Power Cable Type C12 (3.7m) <sup>6</sup>
<b>NOTE:</b> Refer to the Rack Cabinets and Options section for details of IBM Racks and rack-supported devices.	
<b>Keyboard and Mouse<sup>2</sup></b>	
28L36xx <sup>7</sup>	Space Saver II Keyboard <sup>3, 5</sup>
28L36xx <sup>8</sup>	Preferred Keyboard (stealth black) <sup>4</sup>
28L3675	Sleek 2-Button Stealth Black Mouse

1. xSeries 340 ICA is housed in a 19in rack-mountable drawer and requires one of the racks listed in the Rack Cabinets and Options section.

2. xSeries 340 ICA supports rack configurations only and ships without a mouse or keyboard.

3. Installation within a rack requires optional keyboard tray P/N 28L4707, which stows in ready-to-use position.

4. Installation within a rack requires optional keyboard tray P/N 28L4707. This keyboard cannot share a keyboard tray with a flat panel display.

5. Advanced TrackPoint IV features are not available on IBM xSeries systems.

6. The xSeries 340 ICA ships with a standard country power cord. For connection to a high voltage UPS or PDU, a Rack Power Cable P/N 94G7448 (one for each power supply), must be ordered.

7. Where 'xx' represents a specific country code as follows:- 46=Danish, 47=France, 48=Germany, 49=Italian, 50=Spanish, 51=UK English, 44=US English, and P/N 19K3831=Switzerland,

19K3832=Sweden/Finland, 19K3833=Portugal, 19K3834=Belgium, 19K3836=Russia, 19K3837=Poland.

8. Where 'xx' represents a specific country code as follows:- 25=French, 26=German, 27=Italian, 29=UK English, 31=Danish, 33=Norwegian, 34=Swedish/Finnish, 35=Swiss, 36=Dutch, 21=US English, and P/N 22P7325=Belgium/UK, 22P7323=Icelandic.





# IBM xSeries 200

Part Number  
 Withdrawal Date: ddmmyy  
 Processor Speed  
 Number of Processors (Std/Max)  
 L2 ECC Cache (KB)  
 Memory (Std/Max)  
 Form Factor<sup>5</sup>  
 Power Supply Quantity (Std/Max)  
 Adv. System Management Processor  
 Onboard Ethernet Processor  
 Hard Disk Controller (EIDE, Ultra)  
 Removable Media Bays (Total/Avail)  
 Internal Hard Disk Drive (Std/Max)  
 CD-ROM (IDE)<sup>6</sup>  
 Bays: (Tot/Av)  
 Slots (Tot/Av)

xSeries 200 At-A-Glance Chart															
K831Xxx	-	800MHz <sup>1,3</sup>	1/1	128	64MB/1.5GB	Tower	1/1	-	10/100	IDE	4/2	20.4/90GB <sup>4</sup>	48X-20X	7/4	5/5
K833Xxx	-	800MHz <sup>1,3</sup>	1/1	128	128MB/1.5GB	Tower	1/1	-	10/100	U160 <sup>3</sup>	4/2	18.2/293.6GB <sup>4</sup>	48X-20X	7/4	5/4
K911Xxx	-	850MHz <sup>1,4</sup>	1/1	128	128MB/1.5GB	Tower	1/1	-	10/100	IDE	4/2	20.4/180GB <sup>4</sup>	48X-20X	7/4	5/5
K913Xxx	-	850MHz <sup>1,4</sup>	1/1	128	128MB/1.5GB	Tower	1/1	-	10/100	U160 <sup>3</sup>	4/2	18.2/293.6GB <sup>4</sup>	48X-20X	7/4	5/4
K941Xxx	-	1GHz <sup>2,4</sup>	1/1	256	128MB/1.5GB	Tower	1/1	-	10/100	IDE	4/2	20.4/180GB <sup>4</sup>	48X-20X	7/4	5/5
K942Xxx	-	1GHz <sup>2,4</sup>	1/1	256	128MB/1.5GB	Tower	1/1	-	10/100	U160 <sup>3</sup>	4/2	18.2/293.6GB <sup>4</sup>	48X-20X	7/4	5/4
K951Xxx	-	1.13GHz <sup>2,4</sup>	1/1	512	128MB/1.5GB	Tower	1/1	-	10/100	IDE	4/2	20.4/180GB <sup>4</sup>	48X-20X	7/4	5/5
K952Xxx	-	1.13GHz <sup>2,4</sup>	1/1	512	128MB/1.5GB	Tower	1/1	-	10/100	U160 <sup>3</sup>	4/2	18.2/293.6GB <sup>4</sup>	48X-20X	7/4	5/4
K961Xxx	-	1.26GHz <sup>2,4</sup>	1/1	512	128MB/1.5GB	Tower	1/1	-	10/100	IDE	4/2	20.4/180GB <sup>4</sup>	48X-20X	7/4	5/5
K962Xxx	-	1.26GHz <sup>2,4</sup>	1/1	512	128MB/1.5GB	Tower	1/1	-	10/100	U160 <sup>3</sup>	4/2	18.2/293.6GB <sup>4</sup>	48X-20X	7/4	5/4
P411Xxx <sup>7</sup>	-	850MHz <sup>1,4</sup>	1/1	128	128MB/1.5GB	Tower	1/1	-	10/100	IDE	4/2	20.4/180GB <sup>4</sup>	48X-20X	7/4	5/5
P421Xxx <sup>7</sup>	-	1GHz <sup>2,4</sup>	1/1	256	128MB/1.5GB	Tower	1/1	-	10/100	IDE	4/2	20.4/180GB <sup>4</sup>	48X-20X	7/4	5/5

1. Intel® Celeron™ processor with 100MHz FSB.
2. Intel Pentium III processor with advanced transfer L2 cache and 133 MHz FSB.
3. Includes a single-channel, 32-bit Ultra160 SCSI PCI storage adapter installed in slot three.
4. Maximum capacity assumes replacement of standard hard disk drives and tape drive (if installed), with the largest supported IBM hard disk drive.
5. Tower to Rack conversion Kit P/N 09N4300 is available if rack mounting is required.
6. Variable read rate. Actual playback speed will vary and is often less than the maximum possible.
7. This model features a one-year on-site limited warranty.

## xSeries 200 Processor Upgrades

Part Number	Processor Upgrades Description	Processor Speed Upgrade <sup>1</sup>
10K0051	xSeries 1GHz Upgrade with 133MHz FSB and 256KB Advanced Transfer Cache Pentium III Processor	K831Xxx, K833Xxx
32P0650	xSeries 1GHz/133MHz FSB - 256KB Cache Upgrade with Pentium III Processor	K911Xxx, K913Xxx P411Xxx
32P0651	xSeries 1.13GHz/133MHz FSB - 512KB Cache Upgrade with Pentium III Processor	K911Xxx, K913Xxx K941Xxx, K942Xxx P411Xxx, P421Xxx
32P0652	xSeries 1.26GHz/133MHz FSB - 512KB Cache Upgrade with Pentium III Processor	K911Xxx, K913Xxx K941Xxx, K942Xxx K951Xxx, K952Xxx P411Xxx, P421Xxx

<sup>1</sup>Requires removal of the standard processor. A maximum of one processor may be installed. Upgrades may require a BIOS update. To obtain the latest Flash BIOS, access [www.ibm.com/pc/support](http://www.ibm.com/pc/support) and enter machine type "Type-Model" in Quick Path. Select "Downloadable files" and then "BIOS".



## xSeries 200 Memory Configurator

DIMM Socket
DIMM Socket
DIMM Socket

Part Number	Memory Description
33L3079 <sup>1</sup>	64MB 133MHz ECC SDRAM Unbuffered DIMM Memory
33L3081	128MB 133MHz ECC SDRAM Unbuffered DIMM Memory
33L3083	256MB 133MHz ECC SDRAM Unbuffered DIMM Memory
33L3085	512MB 133MHz ECC SDRAM Unbuffered DIMM Memory

Total System Memory <sup>1</sup>		DIMMs			
Standard Model with 64MB	Standard Model with 128MB	64MB P/N 33L3079 <sup>3</sup>	128MB P/N 33L3081	256MB P/N 33L3083	512MB P/N 33L3085
128MB	192MB	1	-	-	-
192MB	256MB	2 or	1	-	-
320MB	384MB	-	2 or	1	-
384MB <sup>2</sup>	-	-	3 <sup>2</sup>	-	-
576MB	640MB	-	-	2 or	1
768MB <sup>2</sup>	768MB <sup>2</sup>	-	-	3 <sup>2</sup>	-
1088MB	1152MB	-	-	-	2
1536MB (max) <sup>2</sup>	1536MB (max) <sup>2</sup>	-	-	-	3 <sup>2</sup>

1. Supported only in models P/N K831Xxx, K833Xxx, K871Xxx, K872Xxx.

This table does not represent all possible memory configurations. Memory modules may vary in price per MB.

Selection of smaller DIMMs may provide a more cost-effective alternative to using larger DIMMs. Select the desired total memory from the appropriate column (Standard Model 64MB or 128MB), then select a quantity in that row from one of the DIMM columns.

1. Network Operating Systems may limit the maximum amount of addressable memory. See operating system specifications for further information.

2. Requires removal of standard DIMMs.

3. Supported only in models P/N K831Xxx, K833Xxx, K871Xxx, K872Xxx.

## xSeries 200 Internal SCSI Cabling

### EIDE Models

In xSeries 200 models using the EIDE interface for storage device attachment, a two-drop cable is used to attach the standard EIDE HDD to one of the EIDE connectors. A second EIDE controller provides the interface for the IDE CD-ROM drive which is connected by a two-drop cable. Up to two additional IDE devices can be installed (one connected to each controller).

### SCSI Models

xSeries 200 models with a SCSI adapter are cabled internally with a five-drop, 16-bit wide LVD SCSI cable with a built-in multi-mode active terminator at one end of the cable. The other end of the cable is attached to the internal 68-pin connector of the standard Ultra160 SCSI adapter. SCSI devices can be connected to any of the five cable connectors.

### Other Configuration Alternatives

In the case where a RAID controller is used to support internal drives in a xSeries 200 SCSI model, the standard cable is moved from the standard adapter to the RAID adapter. To connect a SCSI tape drive to the standard adapter, use the 16-bit multi-mode terminated, two-drop SCSI cable included with optional Media Bay Tray and LVD Cable Kit P/N 10K2340.

External SCSI support can be obtained by installing an optional SCSI adapter or RAID controller and using appropriate external SCSI cabling.

**For additional information regarding internal cabling, refer to Appendix E: Internal Storage Cabling Overview.**

**xSeries 200 Internal Hard Disk Drive (HDD) and External Storage Configurator**

Total Internal Storage <sup>1</sup>	10,000RPM Ultra160 SCSI HDDs				15,000RPM Ultra160 SCSI HDD	
	9.1GB P/N 00N8207	18.2GB P/N 00N8208 or 06P5750	36.4GB P/N 00N8209 or 06P5751	73.4GB P/N 06P5752	18.2GB P/N 19K0658 or 06P5765	36.4GB P/N 06P5766
18.2GB	-	18.2GB (10,000rpm) Standard on Base SCSI Models	-	-	18.2GB (10,000rpm) Standard on Base SCSI Models	-
27.3GB	1	-	-	-	-	-
36.4GB	-	1	-	-	1	-
45.5GB	1 and	1	-	-	-	-
54.6GB	-	2 or	1	-	2 or	1
72.8GB	-	3	-	-	3	-
91.0GB	-	-	2	-	-	2
127.4GB	-	-	3	-	-	3
145.6GB <sup>2</sup>	-	-	4 <sup>2</sup>	-	-	4 <sup>2</sup>
165.0GB	-	-	-	2	-	-
238.4GB	-	-	-	3	-	-
293.6GB (max) <sup>2</sup>	-	-	-	4 <sup>2</sup>	-	-

This table does not represent all possible hard disk drive (HDD) configurations.

1. Select a total storage row then identify the recommended HDDs from within an RPM range according to choice. Total Internal Storage listed is within ± 0.2 GB unless otherwise noted.
2. Requires replacement of standard hard disk drive.

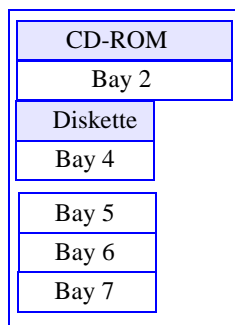

Total Internal Storage <sup>1,2</sup>	7200 RPM IDE HDDs			
	20.4GB P/N 19K4461	30GB P/N 00N8203	40GB P/N 22P7157	60GB P/N 09N4207
20.4GB	20.4GB Standard in EIDE Models	-	-	-
40.8GB	1	-	-	-
50.4GB	-	1	-	-
60.4GB	-	-	1	-
61.2GB	2	-	-	-
80.4GB	-	2	-	-
100.4GB	-	-	2	-
120GB <sup>3</sup>	-	-	3	-
140.4GB	-	-	-	2
180GB <sup>3</sup>	-	-	-	3 <sup>3</sup>

This table does not represent all possible hard drive configurations. Total Internal Storage listed is within +/-0.2GB unless otherwise noted.

1. Select a total storage row and then select the quantity of HDDs from a column corresponding to the hard disk drive of choice.
2. The two EIDE controllers support a maximum of four IDE devices per machine including CD-ROM drive, hard disks and IDE tape drive.
3. Requires replacement of the standard HDD.



Bay	Form Factor	Height	Front Access	Usage	Part Number	Description	RPM	Height	Bays Supported	Max. Qty
1	133mm (5.25in)	HH	yes	IDE CD-ROM	<b>IDE HDDs<sup>1, 2</sup></b>					
2	133mm (5.25in)	HH	yes	open <sup>1</sup>	19K4461	20.4GB ATA/100 (EIDE) HDD	7200	SL	4...7	3
3	89mm (3.5in)	SL	yes	Diskette	00N8203	30GB ATA/100 (EIDE) HDD	7200	SL	4...7	3
4	89mm (3.5in)	SL	yes	open	22P7157	40GB ATA-100 (EIDE) HDD	7200	SL	4...7	3
5...7	89mm (3.5in)	SL	yes	open	09N4207	60GB ATA-100 (EIDE) HDD	7200	SL	4...7	3
<b>Non Hot-Swap Ultra160 SCSI HDDs<sup>2</sup></b>										
					00N8207	9.1GB 10,000rpm Ultra160 HDD	10000	SL	4...7	4
					00N8208	18.2GB 10,000rpm Ultra160 HDD	10000	SL	4...7	4
					06P5750	18.2GB 10,000rpm Ultra160 HDD	10000	SL	4...7	4
					00N8209	36.4GB 10,000rpm Ultra160 HDD	10000	SL	4...7	4
					06P5751	36.4GB 10,000rpm Ultra160 HDD	10000	SL	4...7	4
					06P5752	73.4GB 10,000rpm Ultra160 HDD	10000	SL	4...7	4
					06P5765	18.2GB 15,000rpm Ultra160 HDD	15000	SL	4...7	4
					19K0658	18.2GB 15,000rpm Ultra160 HDD	15000	SL	4...7	4
					06P5766	36.4GB 15,000rpm Ultra160 HDD	15000	SL	4...7	4
<b>Optical Devices</b>							<b>Bays Supported</b>			
					10K3785	12X-8X-32X Black Internal CD-RW Drive <sup>3, 7</sup>	1, 2			
					22P6950	16X Max RAM-Read DVD-ROM Drive <sup>3, 4</sup>	1, 2			
<b>External Storage Expansion Unit<sup>5</sup></b>							<b>Form Factor</b>			
					19K11xx <sup>9</sup>	EXP300 Storage Expansion Unit <sup>6, 8</sup>	Rack (3U)			
					09N7296	EXP300 Rack-to-Tower Conversion Kit <sup>6</sup>	-			
					94G7448	Rack Power Cable Type C12 (3.7m, 12 ft.) <sup>8</sup>	-			

1. Bay 2 supports removable media devices only. Hard disk drives are not supported.

- The xSeries 200 EIDE controllers support a maximum of four IDE devices per machine including CD-ROM drives, hard disks and IDE tape drive.
- Mixing of IDE and SCSI hard disk drives is not supported.
- Either replace the standard CD-ROM or install in the available media bay. An IDE cable with three connectors is included with the optional optical drive. If installing as an additional device, connect the cable to each optical device and to the IDE connector on the system board. Configure the optional device as a master using the preset configuration if replacing the standard device or as a slave if installed as a redundant device. Refer to the Internal SCSI Cabling section for more information.
- Audio not supported for DVD-ROM drives. The drive operates in video mode only.
- Not supported by the external SCSI port included in SCSI models. Select an optional SCSI controller then refer to Appendix D: Cables-Storage Units-Controllers to confirm the controller supports the EXP300 External Storage Expansion Unit and to select a supported cable. For HDD or other expansion unit options, see the specific expansion unit section.
- The EXP300 includes a single 2M Ultra2 SCSI cable and dual hot-swap 500 W redundant power supplies, each with its own standard country power cord. To convert an EXP300 to a tower form factor, EXP300 Rack-to-Tower Conversion Kit P/N 09N7296 is required.
- Some operating systems support the read function only.
- This unit does not include Rack Power Cables P/N 94G7448 when shipped (for attachment to high voltage UPS or PDU). Standard country power cords only are included. If required, order one Rack Power Cable for each power supply.
- Where 'xx' represents a specific country code as follows: 51=US/English, 52=European/English, 56=Danish/English, 57=Israel/English, 58=Italian/English, 59=South Africa/English, 60=Swiss/English, 63=UK/English:- Line Cords/ Publication Country Kits are included as indicated.

**xSeries 200 I/O Options**

Part Number	Description	Adapter Length	PCI Support <sup>1</sup>	Slots Supported <sup>2,3</sup>
<b>Storage Controllers<sup>4,5</sup></b>				
06P5736	ServeRAID-4Mx Ultra160 SCSI Controller <sup>6</sup>	Full	64-bit	2...5
06P5740	ServeRAID-4Lx Ultra160 SCSI Controller <sup>7</sup>	Half	64-bit	2...5
19K4646	PCI Wide Ultra160 SCSI Adapter <sup>8</sup>	Half	32-bit	2...5
02K3454	PCI Fast/Wide Ultra SCSI Adapter <sup>9</sup>	Half	32-bit	2...5
24P2585	IDE 100 RAID Controller by AMI <sup>10</sup>	Half	32-bit	2...5
<b>Networking<sup>11</sup></b>				
<b>Ethernet<sup>12</sup></b>				
09N9901	10/100 EtherLink Server Adapter by 3Com <sup>13</sup>	Half	32-bit	1...5
06P3601	10/100 Ethernet Server Adapter <sup>13</sup>	Half	32-bit	1...5
06P3701	Gigabit Ethernet SX Server Adapter (fibre optic cabling interface)	Half	64-bit	1...5
22P4901	10/100 Dual Port Ethernet Server Adapter <sup>13</sup>	Half	64-bit	1...5
<b>Token Ring</b>				
34L5001	16/4 Token-Ring PCI Management Adapter <sup>13</sup>	Half	32-bit	1...5
34L5201	High-speed 100/16/4 Token-Ring PCI Management Adapter <sup>13</sup>	Half	32-bit	1...5
<b>Communications<sup>14</sup></b>				
37L14xx	Serial I/O SST 8, 16 and 128 Port Adapters <sup>15</sup>	Half	32-bit	2...5 <sup>14</sup>

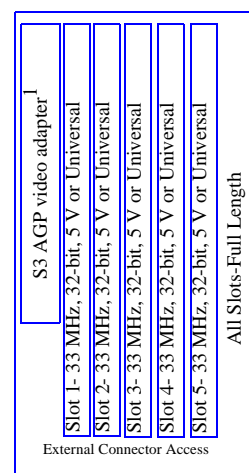

1. xSeries 200 ships standard with an AGP video adapter. Alternate video adapters are not supported.

1. A 64-bit adapter installed in a 32-bit slot will transfer data at 32-bit rates. Adapters rated at 66MHz will operate at 33MHz when installed in a 33MHz slot.
2. The xSeries 200 has five full-length, 33 MHz PCI expansion slots. The number of available slots is model specific.
3. The Ultra160 SCSI controller shipped standard in SCSI models is installed in slot three.
4. Some models of the xSeries 200 include a single channel Ultra160 SCSI Adapter with a five drop multi-mode terminated LVD SCSI Cable. All models include dual-channel EIDE controllers. IDE models require an optional SCSI adapter P/N 19K4646 for external SCSI functionality or SCSI tape support. See the At-A-Glance chart for model attributes.
5. Storage controllers are supported in slots two through five only. Slots two and four and slots three and five are paired so that they support only the same type of adapter e.g if a storage controller is installed in slot two, only another storage controller should be installed in slot four. Thus a networking adapter should not be installed in slot four when a storage controller is installed in slot two (slot one is next to the AGP video adapter and slot five is the farthest from the processor).
6. ServeRAID-4Mx Ultra160 SCSI Controller is powered by a 100MHz Intel Zion GC80303 processor that provides 64MB of battery-backed ECC cache and two internal and two external Ultra160 connections (only two connectors may be used). External connections are 0.8mm VHDCI.
7. ServeRAID-4Lx Ultra160 SCSI Controller is powered by a 100MHz Intel Zion GC80303 processor and provides a single channel, 32MB of ECC cache and either one internal or one external Ultra160 connection. External connector is 0.8mm VHDCI.
8. PCI Wide Ultra160 SCSI Adapter P/N 19K4646 provides a single channel with one internal connector and a five-drop multi-mode terminated LVD SCSI cable and one external 0.8-mm VHDCI connector. Only one of the two connectors may be utilised.
9. PCI Fast/Wide Ultra SCSI Adapter P/N 02K3454 provides one external 68-pin high density connector that supports external SCSI devices such as tape enclosures.
10. Supported only in IDE models. Dual channel adapter includes two connectors, supporting one ATA-100 HDD per channel. Two 18in ATA-66 cables ship with the option. Allows RAID 0 and RAID 1 configurations.
11. xSeries 200 includes an integrated full-duplex, 10/100Mbps Ethernet controller. Networking adapters are supported in slots one through five. Slots two and four, and slots three and five are paired so that they support only the same type of adapter e.g if a networking adapter is installed in slot three, only another networking adapter should be installed in slot five. Thus a storage controller should not be installed in slot five when a networking adapter is installed in slot three (slot one is next to the AGP video adapter and slot five is the farthest from the processor).
12. In a fault-tolerant networking environment, using the fault-tolerant software delivered with the Ethernet adapters of a single manufacturer is recommended. Installing fault-tolerant solutions provided by multiple manufacturers may cause failures if the intermediate drivers provided with the adapters are not compatible. The onboard Ethernet is Intel-based, which is compatible with the Intel-based optional Ethernet adapters listed here: P/Ns 06P3601, 06P3701 and 22P4901.
13. Wake on LAN™ is supported for this adapter when installed in slots one through five (refer to limitation explained in footnotes five and ten).
14. xSeries 200 includes two USB ports, two high-speed serial/asynchronous ports, (NS16550A software compatible) and one high-speed parallel port supporting devices using SSP/EPP/ECP protocols adhering to the IEEE 1284 Standard.
15. See Appendix F for details of Serial I/O options and configuration limitations. A maximum of four Serial I/O adapters (in any combination) may be installed.



**xSeries 200 Power, Monitors, Accessories**

Part Number	Description
<b>Power<sup>1,9</sup></b>	
94G7448	Rack Power Cable Type C12 (3.7m) <sup>9</sup>
<b>Floor Standing Uninterruptible Power Supply (UPS)<sup>2</sup></b>	
SUP072Y	APC Smart-UPS 700
SUP102Y	APC Smart-UPS 1000
SUP142Y	APC Smart-UPS 1400
<b>Rack Mount Uninterruptible Power Supply (UPS)<sup>2</sup></b>	
14RIxxx <sup>10</sup>	APC Smart-UPS 1400RMiB <sup>3</sup>
32P16xx <sup>11</sup>	APC 2U Smart-UPS 1400RMiB <sup>5</sup>
30RIxxx <sup>10</sup>	APC Smart-UPS 3000RMiB <sup>3</sup>
37L6862	APC Smart-UPS 5000RMiB <sup>4</sup>
<b>Monitors<sup>6</sup></b>	
T3147xx <sup>12</sup>	E54 Color Monitor 15in (350mm, 13.8in Viewable Image Size), stealth black <sup>7</sup>
T3247xx <sup>12</sup>	E74 Color Monitor 17in (403mm, 15.9in Viewable Image Size), stealth black <sup>7</sup>
T274Axx <sup>12</sup>	G78 Color Monitor 17in (406.4mm, 16.0in Viewable Image Size), stealth black <sup>7</sup>
T11AGxx <sup>12</sup>	T540 Flat Panel Color Monitor 15in (381mm, 15in viewable image), stealth black <sup>8</sup>

1. The xSeries 200 includes a 330W voltage sensing power supply and a single standard country power cord.
2. For runtimes and UPS attributes see Appendix C: UPS Runtime Estimate.
3. Height is 3U. See Rack Cabinets and Options section for supported IBM racks.
4. Height is 5U. See Rack Cabinets and Options section for supported IBM racks.
5. Height is 2U. See Rack Cabinets and Options section for supported IBM racks.
6. The xSeries 200 models P/N K831Xxx, K833Xxx, contain an S3 Savage-4 LT video adapter. Models P/N K911Xxx, K913Xxx, K941Xxx, K942Xxx, K951Xxx, K952Xxx, K961Xxx, K962Xxx, P411Xxx, P421Xxx contain an ATI Savage-4 LT video adapter. Both adapters include 8MB of memory and are plugged into the standard AGP slot.
7. Installation within a rack requires optional Monitor Compartment (P/N94G7444).
8. Installation within a rack requires optional Flat Panel Monitor Rack Mount Kit II (P/N 37L6888) and Rack Keyboard Tray P/N 28L4707. A space saver keyboard may coexist within the same keyboard tray. See Rack Cabinets and Options section for more information.
9. The xSeries 200 ships with a standard country power cord. If conversion to Rack format is being carried out, Rack Power Cable P/N 94G7448 (type C12), must be ordered if connection to a high voltage UPS or PDU is required.
10. Where 'xxx' represents a specific country code as follows:- DEN=Denmark, ISR=Israel, ITA=Italy, SDI=Saudi Arabia, SAF=South Africa, SWS=Switzerland, UKM=United Kingdom, EUR=Europe.
11. Where 'xx' represents a specific country code as follows:- 12=Europe, 13=UK, 14=Italy, 15=Switzerland, 16=Denmark, 17=South Africa, 18=Israel.
12. Where 'xx' represents a specific country code as follows:- DK=Denmark, IS=Israel, IT=Italy, SD=Saudi Arabia, SA=South Africa, CH=Switzerland, UK=UK, EU=Europe.

Part Number	Description
<b>Conversion Kits</b>	
09N4300	4Ux20D Tower-to-Rack Kit <sup>5</sup>
<b>Rack and NetBAY<sup>1,5</sup></b>	
94G7448	Rack Power Cable Type C12 (3.7m) <sup>5</sup>
<b>NOTE: Refer to the Rack Cabinets and Options section for details of IBM Racks and rack-supported devices.</b>	
<b>Keyboard and Mouse<sup>2</sup></b>	
28L36xx <sup>6</sup>	Space Saver II Keyboard <sup>3,4</sup>

1. Rack installation of an xSeries 200 requires 4Ux20D Tower-to-Rack Kit P/N 09N4300 and one of the Racks listed in the Rack Cabinets and Options section.
2. The xSeries 200 includes both a mouse and non space saver keyboard.
3. Installation within a rack requires optional keyboard tray P/N 28L4707 (stows in "ready-to-use" position).
4. Advanced TrackPoint IV features are not available on IBM xSeries systems.
5. The xSeries 200 ships with a standard country power cord. If conversion to Rack format and connection to a high voltage UPS or PDU is being carried out, a Rack Power Cable P/N 94G7448 (type C12), must be ordered.
6. Where 'xx' represents a specific country code as follows:- 46=Danish, 47=France, 48=Germany, 49=Italian, 50=Spanish, 51=UK English, 44=US English, 19K3831=Switzerland, 19K3832=Sweden/Finland, 19K3833=Portugal, 19K3834=Belgium, 19K3836=Russia, 19K3837=Poland.





**xSeries 200 Tape Options**

Part Number	Description	Bays Supported	SCSI Interface (bit)	Form Factor	Termination Included	68/50-pin Converter Included.	Ext. Tape Enclosures <sup>1</sup>
20L0549	10/20GB TR5 Internal IDE Tape Drive <sup>2</sup>	2	-	89mm (3.5in) SL or 133mm (5.25in) HH	-	-	-
09N4041	12/24GB DDS/3 4mm Internal SCSI Tape Drive <sup>3, 4, 5</sup>	2	8	89mm (3.5in) HH or 133mm (5.25in) HH	Y	Y	10L7440, 03K8756
09N4042	10/20GB NS Internal SCSI Tape Drive <sup>3, 4, 5</sup>	2	8	89mm (3.5in) SL or 133mm (5.25in) HH	Y	Y	10L7440, 03K8756
00N7991	20/40GB DDS/4 4-mm Internal SCSI Tape Drive <sup>4, 5</sup>	2	16 Ultra2 LVD	89mm (3.5in) HH or 133mm (5.25in) HH	N	-	10L7440 <sup>6</sup> , 03K8756 <sup>7</sup>
00N8015	110/220GB Super DLT Internal SCSI Tape Drive	-	16 Ultra2 LVD	133mm (5.25in) FH	N	-	03K8756 <sup>7</sup>
00N8016	100/200GB LTO SCSI Tape Drive	-	16 Ultra2 LVD	133mm (5.25in) FH	N	-	03K8756 <sup>7</sup>
24P2398	40/80GB DLTVS Internal SCSI Tape Drive <sup>4, 5</sup>	2	16 Ultra2 LVD	133mm (5.25in) HH	N	-	03K8756 <sup>7</sup>
<b>External Tape Enclosures</b>							
10L7440	External Half High SCSI Storage Enclosure <sup>8</sup>	-	8/16	Desktop	N	N	-
03K8756	NetMEDIA Storage Expansion Unit EL <sup>9</sup>	-	16	Rack	Y	N	-
10L7113	NetMEDIA Systems Management Adapter <sup>10</sup>	-	16 LVD	-	N	N	03K8756
<b>Associated Options</b>							
00N7956	68-pin External Multimode LVD/SE SCSI Terminator	-	16 LVD/SE	External	Y	N	10L7440
10K2340	Media Bay Tray and LVD Cable Kit <sup>4,7</sup>	-	16 LVD	Internal	Y	N	03K8756

Note: SCSI models include an Ultra160 SCSI controller with a five-drop multi-mode terminated LVD SCSI cable. Single-Ended devices attached to this cable will limit the entire SCSI bus to single-ended performance. SCSI tape drives and external tape enclosures are supported by PCI Wide Ultra160 SCSI Adapter P/N 19K4646 which includes a five-drop multi-mode LVD SCSI cable and an external 0.8-mm VHDCI connector.

1. To determine cable requirements, note the tape drive's SCSI interface, the appropriate SCSI controller from the system configurator section, and the desired enclosure, then refer to Appendix D: Cables - Storage Units - Controllers.

2. SCSI models include a two-drop EIDE cable for attachment to the CD-ROM and an optional IDE tape drive.

3. This single-ended device will limit the SCSI bus to which it is attached to Ultra SCSI speeds. To provide a dedicated tape SCSI bus, install PCI Wide Ultra160 SCSI Adapter P/N 19K4646 which includes a five-drop multi-mode LVD SCSI cable.

4. For RAID configurations (in SCSI models) where the standard SCSI cable is attached to a RAID adapter, the two-drop multi-mode terminated LVD SCSI cable included with Media Bay Tray and LVD Cable Kit P/N 10K2340 is required, to allow attachment of a SCSI Tape Drive to the standard Ultra160 SCSI Adapter.

5. x200 EIDE models require optional PCI Wide Ultra160 SCSI Adapter P/N 19K4646 which includes a five-drop multi-mode LVD SCSI cable, to allow the addition of a SCSI Tape Drive.

6. Requires 68-pin External Multimode LVD/SE SCSI Terminator P/N 00N7956.

7. LVD support for LVD devices installed in a NetMEDIA Storage Expansion Unit EL P/N 03K8756 requires replacement of the standard single-ended internal cables with one or more (depending on configuration) cables from Media Bay Tray and LVD Cable Kit P/N 10K2340 which contains a single two-drop multi-mode LVD-SCSI terminated LVD cable. If the standard cables are used for attachment to LVD devices, single-ended SCSI rules and bus speeds apply.

8. Provides a black desktop 133 mm (5.25") half-high (HH) tape enclosure. Connector is configurable as 50-pin Centronix or 68-pin high density. Requires either tape drive self termination or 68-pin External Multimode LVD/SE SCSI Terminator P/N 00N7956.

9. NetMEDIA Storage Expansion Unit EL P/N 03K8756 is a black 3U, 19" rack-mountable tape enclosure which includes two full high (FH) or four half high (HH) extended length 133 mm (5.25") bays, two external 0.8mm VHDCI connectors and two internal four-drop single-ended terminated 16-bit SCSI cables for device attachment. Two power supplies and two power cords are also included. Tip: The front rail clips will need to be reversed and screwed in from behind to secure the unit in a Rack Cabinet P/N 930842x.

10. NetMEDIA Systems Management Adapter P/N 10L7113 may be installed in an Expansion Unit P/N 03K8756 to provide repeater function, LVDS interface, aggregate cable lengths up to 12 meters when attached to an LVD SCSI controller, and auto-termination when the Expansion Unit is powered off. External connector is 0.8-mm VHDCI.

Note: Additional tape details can be found in Appendix A: Tape Drive Attributes

Note: For a complete list of all IBM and non-IBM options compatibility with Network Operating Systems and IBM xSeries Servers, access the IBM ServerProven compatibility pages on the Web at URL <http://www.ibm.com/pc/us/compat>



## xSeries 200 Sample Configurations

Note: The following sample configurations are for illustration only and may not be suitable for any specific customer installation. Contact your IBM Business Partner or IBM Marketing Representative for assistance with your specific configuration requirements.

### Internet Server

Part Number	Description	Quantity
K941Xxx	x200 1GHz/256KB Pentium III, 128MB, 20.4GB EIDE, 48X	1
33L3081	128MB 133Mhz ECC SDRAM DIMM Memory	1 <sup>1</sup>
19K4461	20.4GB 7200rpm ATA/100 (EIDE) HDD	1 <sup>2</sup>
20L0549	10/20GB TR5 Internal IDE Tape Drive	1
T3147xx	E54 Color Monitor 15in (350mm, 13.8in Viewable Image Size), stealth black	1
SUP072Y	APC Smart-UPS 700	1

1. For a total of 256 MB of system memory.
2. For a total of 40.8 GB of internal storage.

An Internet server handles all requests from the Internet (Intranet or Extranet). Usually, this type of server has the same characteristics as a normal file server. The main difference is that an internet server talks a different language (TCP/IP vs. NETBEUI or IPX/SPX) and often needs to do an extra security check (firewall). In the case of an Internet server, the server itself talks mostly to one client, the Internet Service Provider (ISP), instead of many clients as a file server does.

With this in mind, the xSeries 200 was selected to provide an affordable price point for the growing Internet server market with an Intel Pentium III processor, 256 MB of system memory (expandable to 1.5 GB), and power protection with an APC Smart-UPS.

The network configuration depends on the method that will be used to connect the server to the Internet. Usually fast Ethernet routers are used, but if other methods are used you can add the appropriate adapter. The configuration includes a tape backup unit for secure backup of critical data in the event of a system or storage failure.

### File and Print Server

Part Number	Description	Quantity
K952Xxx	x200 1.13GHz/512KB Pentium III, 128MB, 18.2GB Ultra160, 48X	1
33L3081	128MB 133MHz ECC SDRAM DIMM Memory	1 <sup>1</sup>
00N8208	18.2GB 10,000rpm Ultra160 SCSI HDD	2 <sup>2</sup>
19K4646	PCI Wide Ultra160 SCSI Adapter	1
00N7991	20/40GB DDS/4 4mm Internal Tape Drive	1
T3147xx	E54 Color Monitor 15in (350mm, 13.8in Viewable Image Size), stealth black	1
SUP072Y	APC Smart-UPS 700	1

1. For a total of 256 MB of system memory.
2. For a total of 54.6 GB of internal storage.

A small business or departmental server is usually required to perform all typical server functions while servicing up to 100 users in a normal workgroup computing environment, but doesn't require the high-end performance and fault-tolerance properties of larger servers.

The sample configuration above consists of an xSeries 200 with 256 MB of memory and 54.6 GB of hard disk space. It has enough processor power and memory to run most current network operating systems comfortably and enough hard disk space to store a significant amount of data with additional external storage expansion still available. Demanding network traffic is effectively handled by the standard 100Mbps Ethernet connection.

This configuration also includes a tape backup unit, monitor, and a UPS to keep the system protected during power surges and outages.

### Application Server

Part Number	Description	Quantity
K962Xxx	x200 1.26GHz/512KB Pentium III, 128MB, 18.2GB Ultra160, 48X	1
33L3083	256MB 133MHz ECC SDRAM DIMM Memory	1 <sup>1</sup>
06P5740	ServeRAID-4Lx Ultra160 SCSI Controller	1
00N8208	18.2GB 10,000rpm Ultra160 SCSI HDD	2 <sup>2</sup>
10K2340	Media Bay Tray and LVD Cable Kit	1 <sup>3</sup>
09N4042	10/20GB NS Internal SCSI Tape Drive	1
T3147xx	E54 Colour Monitor 15in (350mm, 13.8in Viewable Image Size), stealth black	1
SUP072Y	APC Smart-UPS 700	1

1. For a total of 384 MB of system memory.
2. Three HDDs are used (in total), for RAID 5 protection. Effective storage capacity is two HDDs (36.4GB).
3. Provides a cable for dedicated attachment of tape to standard controller.

An application server differs from a file and print server in that it has a higher workload, in providing application serving requirements for users. With this in mind, the xSeries 200 was selected to provide an affordable price point for an application server, with Pentium III processing, 384 MB of system memory (expandable to 1.5 GB), and availability features such as RAID-protected internal storage and power protection with an APC Smart-UPS.



# IBM xSeries 220

Part Number  
 Withdrawal Date: ddmmyy  
 Processor Speed <sup>1</sup>  
 Number of Processors (Std/Max)  
 L2 ECC Cache. (KB)  
 Memory (Std/Max) (R=RDIMM)  
 Form Factor<sup>3</sup>  
 Power Supply Quantity (Std/Max)  
 Hot-Swap Hard Disk Capability (H)  
 Adv. System Management Processor  
 Onboard Ethernet (Mbps)  
 SCSI Controller (Dual, Ultra, RAID)  
 Removable Media Bays (Total/Avail)  
 Internal Hard Disk Drive (Std/Max)  
 CD-ROM (IDE)<sup>2</sup>  
 Bays: (Tot/Av)  
 Slots (Tot/Av)

xSeries 220 At-A-Glance Chart																
K621Xxx	-	1GHz <sup>3</sup>	1/2	256	128MB(R)/4GB	Tower	1/1	-	-	10/100	U160	4/2	0/293.6GB	48X-20X	7/5	5/5
K622Xxx	-	1GHz <sup>3</sup>	1/2	256	128MB(R)/4GB	Tower	1/1	-	-	10/100	U160	4/2	18.2/293.6GB	48X-20X	7/4	5/5
K62AXxx	-	1GHz <sup>3</sup>	1/2	256	256MB(R)/4GB	Tower	1/1	H	-	10/100	U160	4/2	0/220.2GB	48X-20X	7/5	5/5
K631Xxx	-	1.13GHz <sup>3</sup>	1/2	512	128MB(R)/4GB	Tower	1/1	-	-	10/100	U160	4/2	0/293.6GB	48X-20X	7/5	5/5
K632Xxx	-	1.13GHz <sup>3</sup>	1/2	512	128MB(R)/4GB	Tower	1/1	-	-	10/100	U160	4/2	18.2/293.6GB	48X-20X	7/4	5/5
K63AXxx	-	1.13GHz <sup>3</sup>	1/2	512	256MB(R)/4GB	Tower	1/1	H	-	10/100	U160	4/2	0/220.2GB	48X-20X	7/5	5/5
K641Xxx	-	1.26GHz <sup>3</sup>	1/2	512	128MB(R)/4GB	Tower	1/1	-	-	10/100	U160	4/2	0/293.6GB	48X-20X	7/5	5/5
K642Xxx	-	1.26GHz <sup>3</sup>	1/2	512	128MB(R)/4GB	Tower	1/1	-	-	10/100	U160	4/2	18.2/293.6GB	48X-20X	7/4	5/5
K64AXxx	-	1.26GHz <sup>3</sup>	1/2	512	256MB(R)/4GB	Tower	1/1	H	-	10/100	U160	4/2	0/220.2GB	48X-20X	7/5	5/5

1. Intel Pentium III processor with advanced transfer L2 cache and 133MHz FSB.
2. Variable read rate. Actual playback speed will vary and is often less than the maximum possible.
3. Tower to Rack conversion Kit P/N 09N4300 is available if rack mounting is required.

## xSeries 220 Processor Upgrades

Part Number	Processor Upgrades Description	SMP Support <sup>1</sup>	Processor Speed Upgrade <sup>2</sup>
32P0650	xSeries 1GHz/133MHz FSB - 256KB Cache Upgrade with Pentium III Processor	K621Xxx, K622Xxx K62AXxx	-
32P0651	xSeries 1.13GHz/133MHz FSB - 512KB Cache Upgrade with Pentium III Processor	K631Xxx, K632Xxx K63AXxx	K621Xxx, K622Xxx K62AXxx
32P0652	xSeries 1.26GHz/133MHz FSB - 512KB Cache Upgrade with Pentium III Processor	K641Xxx, K642Xxx K64AXxx	All K62xXxx, K63xXxx

1. One additional processor may be installed, providing a maximum of two. All processors must be identical in type, speed, and cache size.
2. Requires removal of the standard processor. A maximum of two processors may be installed. Upgrades may require a BIOS update. To obtain the latest Flash BIOS, access [www.ibm.com/pc/support](http://www.ibm.com/pc/support) and enter machine "Type-Model" in Quick Path. Select "Downloadable files" and then "BIOS".



### xSeries 220 Memory Configurator

RDIMM Socket
RDIMM Socket
RDIMM Socket
RDIMM Socket

Part Number	Memory Description <sup>1</sup>
10K0018	128MB PC133 ECC SDRAM RDIMM
10K0020	256MB PC133 ECC SDRAM RDIMM
10K0022	512MB PC133 ECC SDRAM RDIMM
33L3326	1GB PC133 ECC SDRAM RDIMM

1. Install additional RDIMMs in sequence of socket two through four.

Total System Memory <sup>1</sup>		Quantity of RDIMMs Added			
128MB (1 x 128) Models	256MB (1 x 256) Models	128MB P/N 10K0018	256MB P/N 10K0020	512MB P/N 10K0022	1GB P/N 33L3326
256MB	384MB	1	-	-	-
384MB	512MB	2 or	1	-	-
512MB	640MB	3	-	-	-
640MB	768MB	-	2 or	1	-
896MB	1024MB	-	3	-	-
1024MB <sup>2</sup>	-	-	4 <sup>2</sup>	-	-
1152MB	1280MB	-	-	2 or	1
1664MB	1792MB	-	-	3	-
2048MB <sup>2</sup>	2048MB <sup>2</sup>	-	-	4 <sup>2</sup>	-
2176MB	2304MB	-	-	-	2
3200MB	3328MB	-	-	-	3
4096MB (max) <sup>2</sup>	4096MB (max) <sup>2</sup>	-	-	-	4 <sup>2</sup>

This table does not represent all possible memory configurations. Memory modules may vary in price per MB.

Selection of smaller RDIMMs may provide a more cost-effective alternative to using larger RDIMMs. Select the desired total memory from the lefthand column, then select a quantity in that row from one of the DIMM columns.

1. Network Operating Systems may limit the maximum amount of addressable memory. See operating system specifications for further information.
2. Requires removal of standard memory.

### xSeries 220 Internal SCSI Cabling

#### Non-Hot-Swap Models

xSeries 220 non-hot-swap models are cabled internally with a five-drop, 16-bit wide LVD SCSI cable with a built-in multi-mode active terminator on one end of the cable. The other end of the cable is attached to the internal 68-pin connector of the integrated Ultra160 SCSI controller. SCSI devices can be connected to any of the five cable connectors.

#### Hot-Swap Models

xSeries 220 hot-swap models are cabled internally with a two-drop, 16-bit wide LVD SCSI cable. One end is connected to the internal 68-pin connector of the integrated Ultra160 SCSI controller. The second drop is connected to the hot-swap SCSI backplane. The SCSI backplane provides termination for the SCSI bus. Installation of a fixed disk in bay 4 of hot-swap models is not supported without the use of PCI Ultra160 SCSI Adapter P/N 19K4646 to provide a separate SCSI bus.

#### Other Configuration Alternatives

In the case where a RAID controller is used to support internal drives in a xSeries 220, the standard cable is moved from the onboard controller to the RAID adapter. To connect a tape drive to the onboard SCSI controller, the two-drop cable from the optional Media Bay Tray and LVD Cable Kit P/N 10K2340 should be used. External SCSI support can be obtained by installing an optional SCSI adapter or RAID controller and using appropriate external SCSI cabling.

**For additional information regarding internal cabling, refer to Appendix E: Internal Storage Cabling Overview.**

### xSeries 220 Internal Hard Disk Drive (HDD) and External Storage Configurator

Total Internal Storage <sup>1</sup>	10,000RPM Ultra160 SCSI HDDs				15,000RPM Ultra160 SCSI HDDs	
	9.1GB <sup>2</sup> P/N 00N8207	18.2GB <sup>2</sup> P/N 00N8208 or 06P5750 P/N 37L7205 or 06P5754	36.4GB <sup>2</sup> P/N 00N8209 or 06P5751 P/N 37L7206 or 06P5755	73.4GB <sup>2</sup> P/N 06P5752	18.2GB <sup>2</sup> P/N 19K0658 or 06P5765 P/N 19K0656 or 06P5767	36.4GB <sup>2</sup> P/N 06P5766
Hot-Swap----->	P/N 37L7204			P/N 06P5756		P/N 06P5768
0 GB	0GB Standard on most Base Models <sup>4</sup>				0GB Standard on most Base Models <sup>4</sup>	
9.1GB	1	-	-	-	-	-
18.2GB	2 or	1	-	-	1	-
27.3GB	3	-	-	-	-	-
36.4GB	4 <sup>3</sup> or	2 or	1	-	2 or	1
54.6GB	-	3	-	-	3	-
72.8GB	-	4 <sup>3</sup> or	2	-	4 <sup>3</sup> or	2
109.2GB	-	-	3	-	-	3
145.6GB	-	-	4 <sup>3</sup>	-	-	4 <sup>3</sup>
146.8GB	-	-	-	2	-	-
220.2GB	-	-	-	3	-	-
293.6GB (max) <sup>3</sup>	-	-	-	4 <sup>3</sup>	-	-

This table does not represent all possible hard disk drive (HDD) configurations.

1. Select a total storage row then identify the recommended HDDs from within an RPM range according to choice. Total Internal Storage listed is within ± 0.2 GB unless otherwise noted.

2. Both hot-swap and non-hot-swap HDDs are listed. Select the appropriate part number for the model of xSeries 220 being configured.

3. A maximum of three hot-swap drives may be installed in hot-swap models. Installation of a fixed disk in bay 4 of hot-swap models is not supported without the use of PCI Ultra160 SCSI Adapter P/N 19K4646 to provide a separate SCSI bus.

4. xSeries 220 models P/N K622Xxx, K632Xxx and K642Xxx include one 18.2GB Ultra160 SCSI non hot-swap HDD as standard. Recalculate requirements accordingly.

Part Number	Description	RPM	Height	Hot-Swap Models		Non-Hot-Swap Models	
				Bays Supported <sup>1</sup>	Maximum Quantity	Bays Supported	Maximum Quantity
<b>Non Hot-Swap Ultra160 SCSI HDDs<sup>1</sup></b>							
00N8207	9.1GB 10,000rpm Ultra160 HDD	10000	SL	-	-	Bays 4...7	4
00N8208	18.2GB 10,000 rpm Ultra160 HDD	10000	SL	-	-	4...7	4
06P5750	18.2GB 10,000rpm Ultra160 HDD	10000	SL	-	-	4...7	4
00N8209	36.4GB 10,000 rpm Ultra160 HDD	10000	SL	-	-	4...7	4
06P5751	36.4GB 10,000rpm Ultra160 HDD	10000	SL	-	-	4...7	4
06P5752	73.4GB 10,000rpm Ultra160 HDD	10000	SL	-	-	4...7	4
06P5765	18.2GB 15,000rpm Ultra160 HDD	15000	SL	-	-	4...7	4
19K0658	18.2GB 15,000rpm Ultra160 HDD	15000	SL	-	-	4...7	4
06P5766	36.4GB 15,000rpm Ultra160 HDD	15000	SL	-	-	4...7	4
<b>Hot-Swap Ultra160 SCSI HDDs<sup>2</sup></b>							
37L7204	9.1GB 10K-4 Ultra160 Hot-Swap HDD	10000	SL	Bays 5...7	3	-	-
37L7205	18.2GB 10K-4 Ultra160 Hot-Swap HDD	10000	SL	5...7	3	-	-
06P5754	18.2GB 10,000rpm Ultra160 Hot-Swap HDD	10000	SL	5...7	3	-	-
37L7206	36.4GB 10K-4 Ultra160 Hot-Swap HDD	10000	SL	5...7	3	-	-
06P5755	36.4GB 10,000rpm Ultra160 Hot-Swap HDD	10000	SL	5...7	3	-	-
06P5756	73.4GB 10,000rpm Ultra160 Hot-Swap HDD	10000	SL	5...7	3	-	-
06P5767	18.2GB 15,000rpm Ultra160 Hot-Swap HDD	15000	SL	5...7	3	-	-
19K0656	18.2GB 15,000rpm Ultra160 Hot-Swap HDD	15000	SL	5...7	3	-	-
06P5768	36.4GB 15,000rpm Ultra160 Hot-Swap HDD	15000	SL	5...7	3	-	-
<b>Optical Devices</b>			<b>Bays Supported</b>				
10K3785	12X-8X-32X Black Internal CD-RW Drive <sup>3, 7</sup>	1, 2					
22P6950	16X Max RAM-Read DVD-ROM Drive <sup>3, 4</sup>	1, 2					
<b>External Storage Expansion Unit<sup>5</sup></b>			<b>Form Factor</b>				
19K11xx <sup>9</sup>	EXP300 Storage Expansion Unit <sup>6, 8</sup>	Rack (3U)					
09N7296	EXP300 Rack-to-Tower Conversion Kit <sup>6</sup>	-					
94G7448	Rack Power Cable Type C12 (3.7m, 12 ft.) <sup>8</sup>	-					

1. Non-hot-swap HDDs are supported in bays 4...7 of non-hot swap models. Installation of a fixed disk in bay 4 of hot-swap models is not supported without the use of PCI Ultra160 SCSI Adapter P/N 19K4646 to provide a separate SCSI bus.

2. Hot-swap HDDs are supported in bays 5...7 of hot-swap models.

3. Either replace the standard CD-ROM or install in the available media bay. An IDE cable with three connectors is included with the optional optical drive (same cable is standard in the system). If installing as an additional device, connect the cable to each optical device and the IDE connector on the system board. Configure the optional device as a master using the preset configuration if replacing the standard device, or as a slave if installed as a redundant device.

4. Audio not supported for DVD-ROM drives. The drive operates in video mode only.

5. Not supported by the onboard SCSI controller. Select an optional SCSI controller then refer to Appendix D: Cables-Storage Units-Controllers to confirm the controller supports the EXP300 External Storage Expansion Unit and to select a supported cable. For HDD or other expansion unit options, see the specific expansion unit section.

6. The EXP300 includes a single 2M Ultra2 SCSI cable and dual hot-swap 500 W redundant power supplies, each with its own standard country power cord. To convert an EXP300 to a tower form factor, EXP300 Rack-to-Tower Conversion Kit P/N 09N7296 is required.

7. Some operating systems support the read function only.

8. This unit does not include Rack Power Cables P/N 94G7448 when shipped (for attachment to high voltage UPS or PDU). Standard country power cords only are included. If required, order Rack Power Cables (one for each power supply).

9. Where 'xx' represents a specific country code as follows: 51=US/English, 52=European/English, 56=Danish/English, 57=Israel/English, 58=Italian/English, 59=South Africa/English,

60=Swiss/English, 63=UK/English;- Line Cords/ Publication Country Kits are included as indicated.

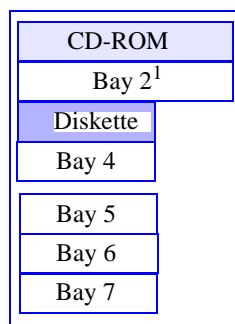

Bay	Form Factor	Height	Front Access	Usage
1	133mm (5.25in)	HH	yes	IDE CD-ROM
2	133mm (5.25in)	HH	yes	open <sup>1</sup>
3	89mm (3.5in)	SL	yes	Diskette
4	89mm (3.5in)	SL	yes	open
5 ... 7	89mm (3.5in)	SL	yes <sup>2</sup>	open

1. Bay 2 does not support HDD options. It can be used for removable media devices such as tape drives.

2. These bays are configured as hot-swap bays on models P/N K62AXxx, K63AXxx, K64AXxx.



**xSeries 220 I/O Options**

Part Number	Description	Adapter Length	PCI Support <sup>1</sup>	Slots Supported <sup>2</sup>
<b>SCSI Storage Controllers<sup>3</sup></b>				
06P5736	ServeRAID-4Mx Ultra160 SCSI Controller <sup>4</sup>	Full	64-bit	1, 2, 3, 5
06P5740	ServeRAID-4Lx Ultra160 SCSI Controller <sup>5</sup>	Half	64-bit	1, 2, 3, 5
19K4646	PCI Wide Ultra160 SCSI Adapter <sup>6</sup>	Half	32-bit	1...5
02K3454	PCI Fast/Wide Ultra SCSI Adapter <sup>7</sup>	Half	32-bit	1...5
<b>Networking<sup>8</sup></b>				
<b>Ethernet<sup>9</sup></b>				
09N9901	10/100 EtherLink Server Adapter by 3Com <sup>10</sup>	Half	32-bit	1...5
06P3601	10/100 Ethernet Server Adapter <sup>10</sup>	Half	32-bit	1...5
06P3701	Gigabit Ethernet SX Server Adapter (fibre optic cabling interface)	Half	64-bit	1...5
22P4901	10/100 Dual Port Ethernet Server Adapter <sup>10</sup>	Half	64-bit	1...5
22P6801	PRO/1000XT Server Adapter by Intel (with CD and manuals) <sup>10</sup>	Half	64-bit	1...5
<b>Token Ring</b>				
34L5001	16/4 Token-Ring PCI Management Adapter <sup>10</sup>	Half	32-bit	1...5
34L5201	High-speed 100/16/4 Token-Ring PCI Management Adapter <sup>10</sup>	Half	32-bit	1...5
<b>Communications<sup>11</sup></b>				
37L14xx	Serial I/O SST 8, 16 and 128 Port Adapters <sup>12</sup>	Half	32-bit	1...5 <sup>12</sup>
<b>Systems Management</b>				
09N75xx <sup>13</sup>	Remote Supervisor Adapter	Half	32-bit	2

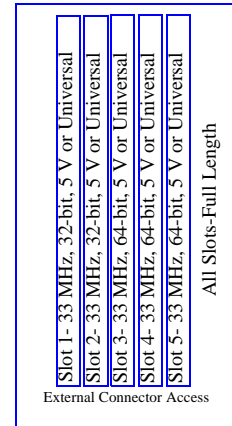

1. A 64-bit adapter installed into a 32-bit slot will transfer data at 32-bit rates. Adapters rated at 66MHz will operate at 33MHz when installed in a 33MHz slot. 133MHz PCI-X adapters are backward compatible with 33/66MHz, 64-bit PCI-based servers.

2. The xSeries 220 has five full-length, 33 MHz PCI expansion slots, three 64-bit and two 32-bit.

3. xSeries 220 has an integrated Ultra160 SCSI Controller with a single internal channel. Non hot-swap models ship with a five-drop, multi-mode terminated LVD SCSI cable. Hot-swap models ship with a two-drop non-terminated LVD SCSI cable. Termination is provided by the hot-swap backplane.

4. ServeRAID-4Mx Ultra160 SCSI Controller is powered by a 100MHz Intel Zion GC80303 processor that provides 64MB of battery-backed ECC cache and two internal and two external Ultra160 connections (only two connectors may be used). External connections are 0.8mm VHDCI.

5. ServeRAID-4Lx Ultra160 SCSI Controller is powered by a 100MHz Intel Zion GC80303 processor and provides a single channel, 32MB of ECC cache and either one internal or one external Ultra160 connection. External connector is 0.8mm VHDCI.

6. PCI Wide Ultra160 SCSI Adapter (P/N 19K4646) provides a single channel with one internal connector and a five-drop multi-mode terminated LVD SCSI cable and one external 0.8-mm VHDCI connector. Only one of the two connectors may be utilised.

7. PCI Fast/Wide Ultra SCSI Adapter P/N 02K3454 provides one external 68-pin high density connector that supports external SCSI devices such as tape enclosures.

8. The xSeries 220 includes an integrated full-duplex, 10/100 Mbps Ethernet controller.

9. In a fault-tolerant networking environment, using the fault-tolerant software delivered with the Ethernet adapters of a single manufacturer is recommended. Installing fault-tolerant solutions provided by multiple manufacturers may cause failures if the intermediate drivers provided with the adapters are not compatible. The onboard Ethernet is Intel-based, which is compatible with the Intel-based optional Ethernet adapters listed here: P/Ns 06P3601, 06P3701, 22P4901, 22P6801.

10. The Wake on LAN feature of this adapter is supported in slot 1 only.

11. xSeries 220 includes two USB ports, two high-speed serial/asynchronous ports, (NS16550A software compatible) and one high-speed parallel port supporting devices using SSP/EPP/ECP protocols adhering to the IEEE 1284 Standard.

12. See Appendix F for details of Serial I/O options and configuration limitations. A maximum of four Serial I/O adapters (in any combination) may be installed.

13. Where 'xx' represents a specific country code as follows:- 86=Europe, 87=Denmark, 88=South Africa, 89=UK, 90=Switzerland, 91=Italy, 92=Israel, 85=USA.

**xSeries 220 Power, Monitors, Accessories**

Part Number	Description
<b>Power<sup>1, 9</sup></b>	
94G7448	Rack Power Cable Type C12 (3.7m) <sup>9</sup>
<b>Free Standing Uninterruptible Power Supply (UPS)<sup>2</sup></b>	
SUP072Y	APC Smart-UPS 700
SUP102Y	APC Smart-UPS 1000
SUP142Y	APC Smart-UPS 1400
<b>Rack Mount Uninterruptible Power Supply (UPS)<sup>2</sup></b>	
14RIxxx <sup>10</sup>	APC Smart-UPS 1400RMiB <sup>3</sup>
32P16xx <sup>11</sup>	APC 2U Smart-UPS 1400RMiB <sup>5</sup>
30RIxxx <sup>10</sup>	APC Smart-UPS 3000RMiB <sup>3</sup>
37L6862	APC Smart-UPS 5000RMiB, <sup>4</sup>
<b>Monitors<sup>6</sup></b>	
T3147xx <sup>12</sup>	E54 Color Monitor 15in (350mm, 13.8in Viewable Image Size), stealth black <sup>7</sup>
T3247xx <sup>12</sup>	E74 Color Monitor 17in (403mm, 15.9in Viewable Image Size), stealth black <sup>7</sup>
T274Axx <sup>12</sup>	G78 Color Monitor 17in (406.4mm, 16.0in Viewable Image Size), stealth black <sup>7</sup>
T11AGxx <sup>12</sup>	T540 Flat Panel Color Monitor 15in (381mm, 15in viewable image), stealth black <sup>8</sup>

1. The xSeries 220 includes a 330W voltage sensing power supply and a single standard country power cord.
2. For runtimes and UPS attributes see Appendix C: UPS Runtime Estimate.
3. Height is 3U. See Rack Cabinets and Options section for supported IBM racks.
4. Height is 5U. See Rack Cabinets and Options section for supported IBM racks.
5. Height is 2U. See Rack Cabinets and Options section for supported IBM racks.
6. The xSeries 220 includes an integrated SVGA controller(S3 Savage4 Chipset) with 8Mb of video memory
7. Installation within a rack requires optional Monitor Compartment P/N94G7444.
8. Installation within a rack requires optional Flat Panel Monitor Rack Mount Kit II P/N 37L6888 and Rack Keyboard Tray P/N 28L4707. A space saver keyboard may coexist within the same 28L4707 keyboard tray. See Rack Cabinets and Options section for more information.
9. The xSeries 220 ships with a standard country power cord. If conversion to Rack format is being carried out, Rack Power Cable P/N 94G7448 (type C12), must be ordered if connection to a high voltage UPS or PDU is required.
10. Where 'xxx' represents a specific country code as follows:- DEN=Denmark, ISR=Israel, ITA=Italy, SDI=Saudi Arabia, SAF=South Africa, SWS=Switzerland, UKM=United Kingdom, EUR=Europe.
11. Where 'xx' represents a specific country code as follows:- 12=Europe, 13=UK, 14=Italy, 15=Switzerland, 16=Denmark, 17=South Africa, 18=Israel.
12. Where 'xx' represents a specific country code as follows:- DK=Denmark, IS=Israel, IT=Italy, SD=Saudi Arabia, SA=South Africa, CH=Switzerland, UK=UK, EU=Europe.

Part Number	Description
<b>Conversion Kits</b>	
09N4300	4Ux20D Tower-to-Rack Kit <sup>5</sup>
<b>Rack and NetBAY<sup>1,5</sup></b>	
94G7448	Rack Power Cable Type C12 (3.7m) <sup>5</sup>
<b>NOTE: Refer to the Rack Cabinets and Options section for details of IBM Racks and rack-supported devices.</b>	
<b>Keyboard and Mouse<sup>2</sup></b>	
28L36xx <sup>6</sup>	Space Saver II Keyboard <sup>3, 4</sup>

- 1 Rack installation of an xSeries 220 requires 4Ux20D Tower-to-Rack Kit (P/N 09N4300) and one of the racks listed in the Rack Cabinets and Options section.
2. The xSeries 220 includes both a mouse and non space saver keyboard.
3. Installation within a rack requires optional keyboard tray P/N 28L4707 (stows in "ready-to-use" position).
4. Advanced TrackPoint IV features are not available on IBM xSeries systems.
5. The xSeries 220 ships with a standard country power cord. If conversion to Rack format and connection to a high voltage UPS or PDU is being carried out, a Rack Power Cable P/N 94G7448 (type C12), must be ordered.
6. Where 'xx' represents a specific country code as follows:- 46=Danish, 47=France, 48=Germany, 49=Italian, 50=Spanish, 51=UK English, 44=US English, 19K3831=Switzerland, 19K3832=Sweden/Finland, 19K3833=Portugal, 19K3834=Belgium, 19K3836=Russia, 19K3837=Poland.



**xSeries 220 Tape Options**

Part Number	Description	Bays Supported	SCSI Interface (bit)	Form Factor	Termination Included	68/50-pin Converter Incl.	Ext. Tape Enclosures <sup>1</sup>
09N4041	12/24GB DDS/3 4mm Internal SCSI Tape Drive <sup>2, 3</sup>	2	8	89mm (3.5in) HH or 133mm (5.25in) HH	Y	Y	10L7440, 03K8756
09N4042	10/20GB NS Internal SCSI Tape Drive <sup>2, 3</sup>	2	8	89mm (3.5in) SL or 133mm (5.25in) HH	Y	Y	10L7440, 03K8756
00N7991	20/40GB DDS/4 4-mm Internal SCSI Tape Drive <sup>3</sup>	2	16 Ultra2 LVD	89mm (3.5in) HH or 133mm (5.25in) HH	N	-	10L7440 <sup>4</sup> , 03K8756 <sup>5</sup>
00N8015	110/220GB Super DLT Internal SCSI Tape Drive	-	16 Ultra2 LVD	133mm (5.25in) FH	N	-	03K8756 <sup>5</sup>
00N8016	100/200GB LTO SCSI Tape Drive	-	16 Ultra2 LVD	133mm (5.25in) FH	N	-	03K8756 <sup>5</sup>
24P2398	40/80GB DLTVS Internal SCSI Tape Drive <sup>3</sup>	2	16 Ultra2 LVD	133mm (5.25in) HH	N	-	03K8756 <sup>5</sup>
<b>Tape Autoloaders</b>							
00N7992	120/240GB DDS/4 SCSI Tape Autoloader	-	16 Ultra2 LVD	133mm (5.25in) FH	N	-	03K8756 <sup>5</sup>
<b>External Tape Enclosures</b>							
10L7440	External Half High SCSI Storage Enclosure <sup>6</sup>	-	8/16	Desktop	N	N	-
03K8756	NetMEDIA Storage Expansion Unit EL <sup>7</sup>	-	16	Rack	Y	N	-
10L7113	NetMEDIA Systems Management Adapter <sup>8</sup>	-	16 LVD	-	N	N	03K8756
<b>Associated Options</b>							
00N7956	68-pin External Multimode LVD/SE SCSI Terminator	-	16 LVD/SE	External	Y	N	10L7440
10K2340	Media Bay Tray and LVD Cable Kit <sup>3,5</sup>	-	16 LVD	Internal	Y	N	03K8756

Note: All models include an integrated Ultra160 SCSI Controller. Non hot-swap models include a five-drop multi-mode terminated LVD SCSI cable. Hot-swap models include a two-drop non-terminated cable. Hot-swap models do not support attachment of an additional SCSI device to the bus that supports the hot-swap backplane. If a single-ended device (such as tape drives P/N 09N4041 or 09N4042) is attached to the same SCSI bus as the HDDs in non hot-swap models, performance of the bus will be limited to single-ended performance. As an alternative attachment method, all tape drives and external tape enclosures are supported by the optional PCI Wide Ultra160 SCSI Adapter P/N 19K4646 which includes a five-drop multi-mode terminated LVD SCSI cable and an external 0.8-mm VHDCI connector.

1. To determine cable requirements, note the tape drive's SCSI interface, the appropriate SCSI controller from the system configurator section, and the desired enclosure, then refer to Appendix D: Cables - Storage Units - Controllers.
2. This single-ended device will limit the SCSI bus to which it is attached to Ultra SCSI speeds. To provide a dedicated tape SCSI bus, install PCI Wide ultra160 SCSI Adapter P/N 19K4646 which includes a five-drop multi-mode LVD SCSI cable.
3. For RAID configurations where the standard SCSI cable is attached to a RAID adapter, the two-drop multi-mode terminated LVD SCSI cable included with Media Bay Tray and LVD Cable Kit P/N 10K2340 is required, to allow attachment of a SCSI Tape Drive to the standard Ultra160 SCSI controller.
4. Requires 68-pin External Multimode LVD/SE SCSI Terminator P/N 00N7956.
5. LVD support for LVD devices installed in a NetMEDIA Storage Expansion Unit EL P/N 03K8756 requires replacement of the standard single-ended internal cables with one or more (depending on configuration) cables from Media Bay Tray and LVD Cable Kit P/N 10K2340 which contains a single two-drop multi-mode LVD-SCSI terminated cable. If the standard cables are used for attachment to LVD devices, single-ended SCSI rules and bus speeds apply.
6. Provides a black desktop 133 mm (5.25") half-high (HH) tape enclosure. Connector is configurable as 50-pin Centronix or 68-pin high density. Requires either tape drive self termination or 68-pin External Multimode LVD/SE SCSI Terminator (P/N 00N7956).
7. NetMEDIA Storage Expansion Unit EL (P/N 03K8756) is a black 3U, 19" rack-mountable tape enclosure which includes two full high (FH) or four half high (HH) extended length 133 mm (5.25") bays, two external 0.8mm VHDCI connectors and two internal four-drop single-ended terminated 16-bit SCSI cables for device attachment. Two power supplies and two power cords are also included. Tip: The front rail clips will need to be reversed and screwed in from behind to secure the unit in a Rack Cabinet P/N 930842x.
8. NetMEDIA Systems Management Adapter (P/N 10L7113) may be installed in an Expansion Unit P/N 03K8756 to provide repeater function, LVDS interface, aggregate cable lengths up to 12 meters when attached to an LVD SCSI controller, and auto-termination when the Expansion Unit is powered off. External connector is 0.8-mm VHDCI.

Note: Additional tape details can be found in Appendix A: Tape Drive Attributes

Note: For a complete list of all IBM and non-IBM options compatibility with Network Operating Systems and IBM xSeries Servers, access the IBM ServerProven compatibility pages on the Web at URL <http://www.ibm.com/pc/us/compat>



## xSeries 220 Sample Configurations

Note: The following sample configurations are for illustration only and may not be suitable for any specific customer installation. Contact your IBM Business Partner or IBM Marketing Representative for assistance with your specific configuration requirements.

### Internet Server

Part Number	Description	Quantity
K62AXxx	x220 1GHz/256KB, 256MB ECC, OPEN-HS, 48X, PCI	1
10K0018	128MB PC133 ECC SDRAM RDIMM	1 <sup>1</sup>
37L7205	18.2GB 10K-4 Ultra160 SCSI Hot-Swap SL HDD	2 <sup>1</sup>
00N7991	20/40 GB DDS/4 4mm Internal Tape Drive	1
19K4646	PCI Wide Ultra160 SCSI Adapter	1
T3147xx	E54 Color Monitor 15in (350mm, 13.8in Viewable Image Size), stealth black	1
SUP072Y	APC Smart-UPS 700	1

1. For a total of 384MB of system memory.
1. For a total of 36.4 GB of internal storage.

An Internet server is a server that handles all requests from the Internet (Intranet or Extranet). Usually, this type of server has the same characteristics as a normal file server. The main difference is that an internet server talks a different language (TCP/IP vs. NETBEUI or IPX/SPX) and often needs to do an extra security check (firewall). In the case of an Internet server, the server itself talks mostly to one client, the Internet Service Provider (ISP), instead of many clients like a file server does.

With this in mind, the xSeries 200 was selected to provide an affordable price point for the growing Internet server market with up to two-way Pentium III processing, 384 MB of system memory (expandable to 4 GB), and power protection with an APC Smart-UPS.

The network configuration depends on the method that will be used to connect the server to the Internet. Usually fast Ethernet routers are used, but if other methods are used you can add the appropriate adapter. The configuration includes a tape backup unit for secure backup of critical data in the event of a system or storage failure.

### File and Print Server

Part Number	Description	Quantity
K631Xxx	x220 1.13GHz/512KB, 128MB ECC, OPEN-HS, 48X	1
10K0018	128MB PC133 ECC SDRAM RDIMM	1 <sup>1</sup>
00N8208	18.2GB 10,000rpm Ultra160 SCSI SL HDD	3 <sup>2</sup>
00N7991	20/40GB DDS/4 4mm Internal Tape Drive	1
19K4646	PCI Wide Ultra160 SCSI Adapter	1
T3147xx	E54 Color Monitor 15in (350mm, 13.8in Viewable Image Size), stealth black	1
SUP072Y	APC Smart-UPS 700	1

1. For a total of 256 MB of system memory.
2. For a total of 54.6 GB of internal storage.

A small business or departmental server is usually required to perform all typical server functions while servicing up to 100 users in a normal workgroup computing environment, but doesn't require the high-end performance and fault-tolerance properties of larger servers.

The sample configuration above consists of an xSeries 220 with 256 MB of memory and 54.6 GB of hard disk space. It has enough processor power and memory to run most current network operating systems comfortably and enough hard disk drive space to store a significant amount of data with additional external storage expansion still available. Demanding network traffic is effectively handled by the standard 100 Mbps Ethernet connection.

This configuration also includes a tape backup unit, monitor, and a UPS to keep the system protected during power surges and outages.

### Application Server

Part Number	Description	Quantity
K64AXxx	x220 1.26GHz/512KB, 256MB ECC, Open, 48X	1
32P0652	1.26GHz/133MHz 512KB Cache Upgrade with Pentium III Processor SVR	1
10K0020	256MB PC133 ECC SDRAM RDIMM	1 <sup>1</sup>
06P5740	ServeRAID-4Lx Ultra160 SCSI Controller	1
37L7205	18.2GB 10K-4 Ultra160 SCSI Hot-Swap SL HDD	3 <sup>2</sup>
10K2340	Media Bay Tray and LVD Cable Kit	1 <sup>3</sup>
00N7991	20/40GB DDS/4 4mm Internal Tape Drive NS Internal SCSI Tape Drive	1
T3147xx	E54 Color Monitor 15in (350mm, 13.8in Viewable Image Size), stealth black	1
SUP072Y	APC Smart-UPS 700	1

1. For a total of 512 MB of system memory.
2. Three HDDs are used (in total) for RAID 5 protection. Effective capacity is two HDDs or 36.4GB
3. Contains a cable for dedicated attachment of tape to standard controller.

An application server differs from a file and print server in that it has a higher workload, in providing application serving requirements for users. With this in mind, the xSeries 220 was selected to provide an affordable price point for an application server, with two-way Pentium III processing, 512MB of system memory (expandable to 4 GB), and availability features such as RAID protected internal storage and power protection with an APC Smart-UPS.





# IBM xSeries 232

Part Number  
 Withdrawal Date: ddmmyy  
 Processor Speed<sup>2</sup>  
 Number of Processors (Std/Max)  
 L2 ECC Cache (KB)  
 Memory (Std/Max) (RDIMM)<sup>5</sup>  
 Form Factor  
 Power Supply Quantity (Std/Max)  
 Hot-Swap (Power, Slots, HDD, Fans)  
 Redundancy (Optional, Standard)  
 Integrated System Management Processor  
 Onboard Ethernet (Mbps)  
 SCSI Controller (Dual, Ultra, RAID)  
 Removable Media Bays (Tot/Av)  
 Internal Hard Disk Drive (Std/Max)  
 CD-ROM (IDE)<sup>9</sup>  
 Bays (Tot/Av)  
 Slots (Tot/Av)

xSeries 232 At-A-Glance																	
P811Xxx	-	1GHz <sup>3</sup>	1/2	256	256MB/4GB	Tower	1/3	H	O - Power <sup>6</sup>	Y	10/100	D,U160	4/2 <sup>7</sup>	0/440.4GB <sup>8</sup>	48X-20X	10/8 <sup>10</sup>	5/5
P81RXxx <sup>1</sup>	-	1GHz <sup>3</sup>	1/2	256	256MB/4GB	Rack (5U)	1/3	H	O - Power <sup>6</sup>	Y	10/100	D,U160	4/2 <sup>7</sup>	0/440.4GB <sup>8</sup>	48X-20X	10/8 <sup>10</sup>	5/5
P821Xxx	-	1.13GHz <sup>3</sup>	1/2	512	256MB/4GB	Tower	1/3	H	O - Power <sup>6</sup>	Y	10/100	D,U160	4/2 <sup>7</sup>	0/440.4GB <sup>8</sup>	48X-20X	10/8 <sup>10</sup>	5/5
P82RXxx <sup>1</sup>	-	1.13GHz <sup>3</sup>	1/2	512	256MB/4GB	Rack (5U)	1/3	H	O - Power <sup>6</sup>	Y	10/100	D,U160	4/2 <sup>7</sup>	0/440.4GB <sup>8</sup>	48X-20X	10/8 <sup>10</sup>	5/5
P822Xxx	-	1.13GHz <sup>3</sup>	1/2	512	256MB/4GB	Tower	2/3	P, H	S - Power	Y	10/100	D,U160	4/2 <sup>7</sup>	0/440.4GB <sup>8</sup>	48X-20X	10/8 <sup>10</sup>	5/5
P82SXxx <sup>1</sup>	-	1.13GHz <sup>3</sup>	1/2	512	256MB/4GB	Rack (5U)	2/3	P, H	S - Power	Y	10/100	D,U160	4/2 <sup>7</sup>	0/440.4GB <sup>8</sup>	48X-20X	10/8 <sup>10</sup>	5/5
P824Xxx	-	1.13GHz <sup>4</sup>	1/2	512	256MB/4GB	Tower	2/3	P, H, F	S - Power, S - Fans	Y	10/100	D,U160	4/2 <sup>7</sup>	0/440.4GB <sup>8</sup>	48X-20X	10/8 <sup>10</sup>	5/5
P82TXxx <sup>1</sup>	-	1.13GHz <sup>4</sup>	1/2	512	256MB/4GB	Rack (5U)	2/3	P, H, F	S - Power, S - Fans	Y	10/100	D,U160	4/2 <sup>7</sup>	0/440.4GB <sup>8</sup>	48X-20X	10/8 <sup>10</sup>	5/5
P841Xxx	-	1.26GHz <sup>3</sup>	1/2	512	256MB/4GB	Tower	1/3	H	O - Power <sup>6</sup>	Y	10/100	D,U160	4/2 <sup>7</sup>	0/440.4GB <sup>8</sup>	48X-20X	10/8 <sup>10</sup>	5/5
P84RXxx <sup>1</sup>	-	1.26GHz <sup>3</sup>	1/2	512	256MB/4GB	Rack (5U)	1/3	H	O - Power <sup>6</sup>	Y	10/100	D,U160	4/2 <sup>7</sup>	0/440.4GB <sup>8</sup>	48X-20X	10/8 <sup>10</sup>	5/5
P842Xxx	-	1.26GHz <sup>3</sup>	1/2	512	256MB/4GB	Tower	2/3	P, H	S - Power	Y	10/100	D,U160	4/2 <sup>7</sup>	0/440.4GB <sup>8</sup>	48X-20X	10/8 <sup>10</sup>	5/5
P84SXxx <sup>1</sup>	-	1.26GHz <sup>3</sup>	1/2	512	256MB/4GB	Rack (5U)	2/3	P, H	S - Power	Y	10/100	D,U160	4/2 <sup>7</sup>	0/440.4GB <sup>8</sup>	48X-20X	10/8 <sup>10</sup>	5/5
P844Xxx	-	1.26GHz <sup>4</sup>	1/2	512	256MB/4GB	Tower	2/3	P, H, F	S - Power, S - Fans	Y	10/100	D,U160	4/2 <sup>7</sup>	0/440.4GB <sup>8</sup>	48X-20X	10/8 <sup>10</sup>	5/5
P84TXxx <sup>1</sup>	-	1.26GHz <sup>4</sup>	1/2	512	256MB/4GB	Rack (5U)	2/3	P, H, F	S - Power, S - Fans	Y	10/100	D,U160	4/2 <sup>7</sup>	0/440.4GB <sup>8</sup>	48X-20X	10/8 <sup>10</sup>	5/5

- Housed in a 19in rack-mountable drawer and ships standard without a keyboard or mouse. See Rack Cabinets and Options section for supported IBM racks.
- Intel Pentium III processor with advanced transfer L2 cache and 133MHz FSB.
- Not compatible with processors for models P/N P824Xxx, P82TXxx, P844Xxx, P84TXxx.
- Not compatible with processors for models P/N P811Xxx, P81RXxx, P821Xxx, P82RXxx, P822Xxx, P82SXxx, P841Xxx, P84RXxx, P842Xxx, P84SXxx.
- High-speed, 133MHz SDRAM.
- Power supply redundancy requires removal of the standard 385W power supply and the addition of either two or three 250W Hot-Swap Redundant Power Supply P/N 33L37xx and a Hot-Swap Power Conversion Kit P/N 24P3513. See xSeries 232 Power, Monitors, Accessories for additional information.
- xSeries 232 includes two available removable media bays that can be converted to three slim-line (SL) hot-swap bays with the addition of optional 3-Pack Ultra160 Hot-Swap Expansion Kit P/N 33L5050. The optional 3-Pack Ultra160 Hot-Swap Expansion Kit P/N 33L5050 is available, which converts the two available removable media bays into three slim-line (SL) hot-swap bays. This increases the Total Bays and Available Bays from 10/8 to 11/9 and the number of hot-swap disk bays from 6 to 9, thereby allowing the internal hot-swap hard disk drive capacity to increase to 660.6GB.
- Variable read rate. Actual playback speed will vary and is often less than the maximum possible.
- The total number of bays can be increased to 11, and hot-swap bays from 6 to 9, by installing an optional 3-Pack Ultra160 Hot-Swap Expansion Kit P/N 33L5050, which converts the two available removable media bays into 3x SL hot-swap HDD bays.

## xSeries 232 Processor Upgrades

Part Number	Processor Upgrades	SMP Support <sup>1</sup>	Processor Speed Upgrade <sup>2</sup>
24P3511	xSeries 1GHz/133MHz, 256KB Cache Upgrade with Pentium III Processor	P811Xxx, P81RXxx	-
24P3512	xSeries 1.13GHz/133MHz, 512KB Cache Upgrade with Pentium III Processor	P821Xxx, P82RXxx	P811Xxx, P81RXxx
25P2600	xSeries 1.26GHz/133MHz, 512KB Cache Upgrade with Pentium III Processor	P841Xxx, P84RXxx, P842Xxx, P84SXxx	P811Xxx, P81RXxx, P821Xxx, P82RXxx
22P1997	xSeries 1.13GHz/133MHz, 512KB Cache Upgrade with Pentium III Processor	P824Xxx, P82TXxx	-
22P1998	xSeries 1.26GHz/133MHz, 512KB Cache Upgrade with Pentium III Processor	P844Xxx, P84TXxx	P824Xxx, P82TXxx

- One additional processor may be installed, providing a maximum of two. All processors must be identical in type, speed, and cache size.
- Requires removal of the standard processor. A maximum of two processors may be installed. All processors must be identical in type, speed and cache size. Upgrades may require a BIOS update. To obtain the latest Flash BIOS, access [www.pc.ibm.com/support](http://www.pc.ibm.com/support) and enter machine "Type-Model" in Quick Path. Select "Downloadable files" then "BIOS."

To access IBM information specific to your country via the World Wide Web, use address: <http://www.ibm.com/pc>



### xSeries 232 Memory Configurator

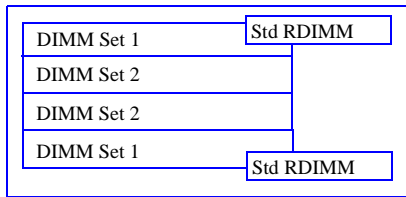

Total Memory <sup>1</sup>	Quantity of RDIMMs Added			
	128MB P/N 33L3320	256MB P/N 33L3322	512MB P/N 33L3324	1GB P/N 33L3326
256MB (2x128) Models				
512MB	2	-	-	-
768MB	-	2	-	-
1GB <sup>2</sup>	-	4 <sup>2</sup>	-	-
1.25GB	-	-	2	-
2.0GB <sup>2</sup>	-	-	4 <sup>2</sup>	-
2.25GB	-	-	-	2
4GB(max) <sup>2</sup>	-	-	-	4 <sup>2</sup>

Part Number	Memory Description <sup>1</sup>
33L3320	IBM 128MB PC133 ECC SDRAM RDIMM
33L3322	IBM 256MB PC133 ECC SDRAM RDIMM
33L3324	IBM 512MB PC133 ECC SDRAM RDIMM
33L3326	IBM 1GB PC133 ECC SDRAM RDIMM

This table does not represent all possible memory configurations. Memory modules may vary in price per MB. Selection of smaller RDIMMs may provide a more cost-effective alternative to using larger RDIMMs. RDIMMs must be added in pairs to support interleaving technology.  
 1. Network operating systems may limit the maximum amount of addressable memory. See operating system specifications for further information.  
 2. Requires removal of standard memory.

1. Due to two-way interleaving, memory options are required to be installed in pairs beginning with set 1.

### xSeries 232 Internal SCSI Cabling

The xSeries 232 contains 10 drive bays. The six 3.5in hot-swap bays are located on the lower half of the xSeries 232 tower models or on the left side of the rack models. These bays support various hot-swap drive options. There are four bays on the top portion of tower models or the right side of rack models, which are primarily designed for removable media devices. One bay contains the standard 3.5in SL diskette drive and another bay contains the standard CD-ROM drive. The remaining two 5.25in half-high bays can support tape backup or other devices. Using an optional 3-Pack Ultra160 Hot-Swap Expansion Kit P/N 33L5050, these two bays can be converted to support three 3.5in SL hot-swap HDDs.

The xSeries 232 contains a backplane supporting six hot-swap drive bays. The backplane is connected to the integrated dual-channel, Ultra160 SCSI controller connector through a 16-bit LVD SCSI cable. If internal RAID support is required, this cable can be used to connect to a supported RAID adapter rather than the integrated SCSI controller. A two-drop, 16-bit SCSI cable with integrated terminator is included with the Media Bay Tray and LVD Cable Kit P/N 10K2340. The two-drop cable supports up to two internal devices in the open 5.25in media device bays. This cable can be attached to the integrated Ultra160 SCSI controller connector if a RAID adapter is used to support the internal hot-swap drive bays. It can also be used to attach to a supported SCSI adapter if the integrated Ultra160 SCSI controller is utilized for the hot-swap bays. The 48X-20X IDE CD-ROM is cabled directly to the IDE port. To attach external SCSI devices, a supported SCSI adapter is required.

**For additional information regarding internal cabling, refer to Appendix E: Internal Storage Cabling Overview.**

### xSeries 232 Internal Hard Disk Drive (HDD) and External Storage Configurator

Total Int Storage <sup>1</sup>	10,000RPM HDDs				15,000RPM HDDs	
	9.1GB P/N 37L7204	18.2GB P/N 37L7205 or 06P5754	36.4GB P/N 37L7206 or 06P5755	73.4GB P/N 06P5756	18.2GB P/N 19K0656 or 06P5767	36.4GB P/N 06P5768
0GB	0GB Standard on base models				0GB Standard on base models	
9.1GB	1	-	-	-	-	-
18.2GB	2 or	1	-	-	1	-
27.3GB	3	-	-	-	-	-
36.4GB	4 or	2 or	1	-	2 or	1
45.5GB	5	-	-	-	-	-
54.6GB	6 or	3	-	-	3	-
72.8GB	-	4 or	2	-	4 or	2
91.0GB	-	5	-	-	5	-
109.2GB	-	6 or	3	-	6 or	3
145.6GB	-	-	4	-	-	4
182.0GB	-	-	5	-	-	5
218.4GB	-	-	6	-	-	6
327.6GB <sup>2</sup>	-	-	9 <sup>2</sup>	-	-	9 <sup>2</sup>
440.4GB	-	-	-	6	-	-
660.6GB <sup>3</sup>	-	-	-	9 <sup>3</sup>	-	-

This table does not represent all possible HDD configurations.  
 1. Select a total storage row then identify the recommended HDDs from within an RPM range according to choice. Total Internal Storage listed is within ± 0.2 GB unless otherwise noted.  
 2. Internal storage using 36.4GB HDD can be increased to 327.6GB by converting the two available removable bays to three hot-swap HDD bays using an optional 3-Pack Ultra160 Hot-Swap Expansion Kit P/N 33L5050.  
 3. Internal storage using 73.4GB HDD can be increased to 660.6GB by converting the two available removable media bays to three hot-swap HDD bays using an optional 3-Pack Ultra160 Hot-Swap Expansion Kit P/N 33L5050.

Bay	Form Factor	Height	Front Access	Usage	Part Number	Description	RPM	Height	Bays Supported	Max Qty <sup>1</sup>
A <sup>1</sup>	133mm (5.25in)	HH <sup>2</sup>	Yes	Open	<b>Hot-Swap Ultra160 SCSI HDDs</b>					
B <sup>1</sup>	133mm (5.25in)	HH <sup>2</sup>	Yes	Open	37L7204	9.1GB 10K-4 Ultra160 Hot-Swap HDD	10000	SL	C ... H	6
-	133mm (5.25in)	HH	Yes	IDE CD-ROM	37L7205	18.2GB 10K-4 Ultra160 Hot-Swap HDD	10000	SL	C ... H	6
-	89mm (3.5in)	SL	Yes	Diskette	06P5754	18.2GB 10,000rpm Ultra160 Hot-Swap HDD	10000	SL	C ... H	6
C ... H	HS	SL	Yes	Open	37L7206	36.4GB 10K-4 Ultra160 Hot-Swap HDD	10000	SL	C ... H	6
					06P5755	36.4GB 10,000rpm Ultra160 Hot-Swap HDD	10000	SL	C ... H	6
					06P5756	73.4GB 10,000rpm Ultra160 Hot-Swap HDD	10000	SL	C ... H	6
					06P5767	18.2GB 15,000rpm Ultra160 Hot-Swap HDD	15000	SL	C ... H	6
					19K0656	18.2GB 15,000rpm Ultra160 Hot-Swap HDD	15000	SL	C ... H	6
					06P5768	36.4GB 15,000rpm Ultra160 Hot-Swap HDD	15000	SL	C ... H	6

1. Bays A and B can be converted to three hot-swap HDDs using the optional 3-Pack Ultra160 Hot-Swap Expansion Kit P/N 33L5050.  
 2. Two Half-High (HH) bays can be combined to support a single Full-High device.

### Tower Model View

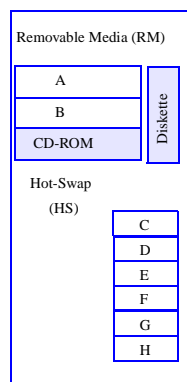

For clarity purposes, bay labels in these diagrams are for reference by the accompanying tables and are not the actual labels. Refer to information shipped with the system for further details on actual labels.

### Rack Model View

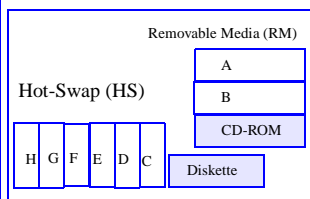

Associated Options			
33L37xx <sup>13</sup>	250W Hot-Swap Redundant Power Supply	-	
24P3513	xSeries Hot-Swap Power Conversion Kit <sup>2</sup>	-	
33L5050	IBM 3-Pack Ultra160 H/Swap Expansion Kit <sup>3</sup>	-	
Optical Devices		Bays Supported	
10K3785	12X-8X-32X Black Internal CD-RW Drive <sup>4,11</sup>	A, B	
22P6950	16X Max RAM-Read DVD-ROM Drive <sup>4,5</sup>	A, B	
External Storage Expansion Units <sup>6</sup>		Form Factor	
19K11xx <sup>14</sup>	EXP300 Storage Expansion Unit <sup>7,12</sup>	Rack (3U)	
09N7296	EXP300 Rack-to-Tower Conversion Kit	-	
19K11xx <sup>15</sup>	FAStT200 Storage Server <sup>8,9,12</sup>	Rack (3U)	
19K11xx <sup>16</sup>	FAStT200 HA Storage Server <sup>8,12</sup>	Rack (3U)	
19K1121	FAStT200 Redundant RAID Controller <sup>9</sup>	-	
00N71xx <sup>17</sup>	FAStT EXP500 Storage Expansion Unit <sup>10,12</sup>	Rack (3U)	
94G7448	Rack Power Cable Type C12 3.7m <sup>12</sup>	-	

- Maximum quantity of HDDs can be increased to nine by converting the two removable media bays to three SL HDD bays using the 3-Pack Ultra160 Hot-Swap Expansion Kit P/N 33L5050.
- xSeries Hot-Swap Power Conversion Kit P/N 24P3513 contains a hot-swap power backplane that supports installation for up to three 250W hot-swap power supplies.
- Bays A and B can be converted to three hot-swap bays using the optional 3-Pack Ultra160 Hot-Swap Expansion Kit P/N 33L5050. The hot-swap backplane can be cabled as an independent bus or as an extension of the standard backplane using the included jumper cable.
- Either replace standard CD-ROM or install in one of the media bays. An IDE cable with three connectors is included with the optional optical drive. If installing as an additional device, connect the cable to each optical device and the IDE connector on the system board. Configure the optional device as a master using the preset configuration if replacing the standard device or as a slave if installed as a redundant device.
- Audio not supported for DVD-ROM drives. The drive operates in video mode only.
- To configure an external SCSI storage devices, select an optional SCSI controller then refer to Appendix D: Cables - Storage Units - Controllers to confirm the controller supports the desired External Storage Expansion Unit and to select a supported cable. For HDD or other expansion unit options, see the specific expansion unit section. For Fibre Channel storage devices, refer to the Fibre Channel Solutions Overview section.
- The EXP300 includes a single 2 M Ultra2 SCSI cable and dual hot-swap 500W redundant power supplies, each with it's own standard country power cord.
- The FAStT200 Storage Server and HA Storage Server each include two hot-swap, 350 W auto-ranging redundant power supplies each with it's own standard country power cord.
- Can be upgraded to FAStT200 HA Storage Server through the addition of a FAStT200 Redundant RAID Controller (P/N 19K1121).
- The FAStT EXP500 Storage Expansion Unit (P/N 00N71xx) includes dual hot-swap 350W power supplies each with it's own standard country power cord.
- Some operating systems support the read function only.
- These units do not include Rack Power Cables P/N 94G7448 when shipped (for attachment to high voltage UPS or PDU). Standard country power cords only are included. If required, order Rack Power Cables (one for each power supply).
- Where 'xx' represents a specific country code as follows: 60=Saudi Arabia, 61=Europe, 62=Denmark, 63=Israel, 64=Italy, 65=South Africa, 66=Switzerland, 67=United Kingdom&Arabia.
- Where 'xx' represents a specific country code as follows: 51=US/English, 52=European/English, 56=Danish/English, 57=Israel/English, 58=Italian/English, 59=South Africa/English, 60=Swiss/English, 63=UK/English:- Line Cords/ Publication Country Kits are included as indicated.
- Where 'xx' represents a specific country code as follows: 23=US/English, 24=Euro/English, 25=Euro/Spanish, 27=Euro/German, 28=Denmark/English, 29=Israel/English, 30=Italy/English, 31=South Africa/English, 32=Switzerland/English, 34=Switzerland/German, 36=UK/English. Country/Language - Line Cords/Publications are included as indicated
- Where 'xx' represents a specific country code as follows: 37=US/English, 38=Euro/English, 39=Euro/Spanish, 41=Euro/German, 42=Denmark/English, 43=Israel/English, 44=Italy/English, 45=South Africa/English, 46=Switzerland/English, 48=Switzerland/German, 50=UK/English. Country/Language - Line Cords/Publications are included as indicated.
- Where 'xx' represents a specific country code as follows: 36=US/English, 37=Euro/English, 41=Denmark/English, 42=Israel/English, 43=Italy/English, 44=South Africa/English, 45=Switzerland/English, 49=UK/English. Country/ Language Line Cords/Publications are included as indicated.



**xSeries 232 I/O Options**

Part Number	Description	Adapter Length	PCI Support <sup>1</sup>	Slots Supported <sup>1</sup>
<b>Storage Controllers<sup>2</sup></b>				
37L6889	ServeRAID-4H Ultra160 SCSI Controller <sup>3</sup>	Full	64-bit	2...5
06P5736	ServeRAID-4Mx Ultra160 SCSI Controller <sup>4</sup>	Full	64-bit	2...5
06P5740	ServeRAID-4Lx Ultra160 SCSI Controller <sup>5</sup>	Half	64-bit	1...5
19K4646	PCI Wide Ultra160 SCSI Adapter <sup>6</sup>	Half	32-bit	1...5
02K3454	PCI Fast/Wide Ultra SCSI Adapter <sup>7</sup>	Half	32-bit	1...5
<b>Fibre Storage Controllers and Options<sup>8</sup></b>				
00N6881	FAST Host Adapter	Half	64-bit	1...5
19K1246	FAST FC-2 Host Bus Adapter	Half	64-bit	1...5
<b>Networking<sup>9</sup></b>				
<b>Ethernet<sup>10, 11</sup></b>				
06P3601	10/100 Ethernet Server Adapter <sup>11</sup>	Half	32-bit	1...5
06P3701	Gigabit Ethernet SX Server Adapter (fibre optic cabling interface)	Half	64-bit	1...5
09N9901	10/100 EtherLink Server Adapter by 3Com <sup>11</sup>	Half	32-bit	1...5
22P4901	10/100 Dual Port Ethernet Server Adapter	Half	64-bit	1...5
22P6801	PRO/1000XT Server Adapter by Intel (with CD and manuals) <sup>11</sup>	Half	64-bit	1...5
<b>Token Ring<sup>11</sup></b>				
34L5201	High-Speed 100/16/4 Token-Ring PCI Management Adapter <sup>11</sup>	Half	32-bit	1...5
34L5001	16/4 Token-Ring PCI Management Adapter <sup>11</sup>	Half	32-bit	1...5
<b>Communications<sup>12</sup></b>				
37L14xx	Serial I/O SST 8, 16 and 128 Port Adapters <sup>13</sup>	Half	32-bit	1...5 <sup>13</sup>
<b>Systems Management</b>				
09N75xx <sup>15</sup>	Remote Supervisor Adapter <sup>14</sup>	Half	32-bit	1

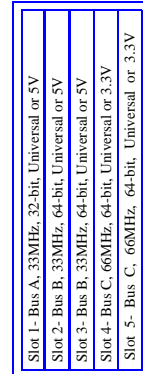

All Slots - Full Length

Exterior Connector Access

1. A 64-bit adapter installed into a 32-bit slot will transfer data at 32-bit rates. Adapters rated at 66MHz will operate at 33MHz when installed in a 33MHz slot. 33MHz adapters will reduce 66MHz buses to 33MHz. 133MHz PCI-X adapters are backward compatible with 33/66MHz, 64-bit PCI-based servers.

2. xSeries 232 includes a dual-port, dual-channel Ultra160 SCSI controller for internal use only. No standard external port is available. See "Internal SCSI Cabling" for cabling alternatives.

3. ServeRAID-4H Ultra160 SCSI Controller is powered by a 266MHz PowerPC 750 processor and provides four channels and 128MB of battery-backed ECC cache, with two internal and up to four external Ultra160 connectors. (a combination of four connectors may be utilised). External connectors are 0.8mm VHDCI.

4. ServeRAID-4Mx Ultra160 SCSI Controller is powered by a 100MHz Intel Zion GC80303 processor that provides 64MB of battery-backed ECC cache and two internal and two external Ultra160 connections (only two connectors may be used). External connections are 0.8mm VHDCI.

5. ServeRAID-4Lx Ultra160 SCSI Controller is powered by a 100MHz Intel Zion GC80303 processor and provides a single channel, 32MB of ECC cache and either one internal or one external Ultra160 connection. External connector is 0.8mm VHDCI.

6. PCI Wide Ultra160 SCSI Adapter P/N 19K4646 provides a single channel with one internal connector, a five-drop multi-mode terminated LVD SCSI cable and one external 0.8mm VHDCI connector. Only one of the two connectors may be utilised.

7. PCI Fast/Wide Ultra SCSI Adapter P/N 02K3454 provides one external 68-pin high density connector that supports external SCSI devices such as tape enclosures.

8. See Fibre Array Solutions section for additional configuration information.

9. xSeries 232 includes a full-duplex, 10/100Mbps Ethernet PCI controller.

10. In a fault-tolerant networking environment, using the fault-tolerant software delivered with the Ethernet adapters of a single manufacturer is recommended. Installing fault-tolerant solutions provided by multiple manufacturers may cause failures if the intermediate drivers provided with the adapters are not compatible. The onboard Ethernet is Intel-based, which is compatible with the Intel-based optional Ethernet adapters listed here: P/Ns 06P3601, 06P3701, 22P4901, 22P6801.

11. This server supports Wake on LAN and Alert-on-LAN functions through the integrated Ethernet controller only. These functions are not supported for optional PCI adapters.

12. xSeries 232 includes two USB ports and two serial ports.

13 See Appendix F for details of Serial I/O options and configuration limitations. A maximum of four Serial I/O adapters (in any combination) may be installed.

14. Disables the Integrated System Management processor when installed in xSeries 232 and provides full system management functionality through a customer-supplied Ethernet cable or modem connection or as part of an interconnected system management bus (option includes all interconnect hardware).

15. Where 'xx' represents a specific country code as follows:- 86=Europe, 87=Denmark, 88=South Africa, 89=UK, 90=Switzerland, 91=Italy, 92=Israel, 85=USA.

**xSeries 232 Power, Monitors, Accessories**

Part Number	Description
<b>Power<sup>1, 11</sup></b>	
33L37xx <sup>12</sup>	250W Hot-Swap Redundant Power Supply <sup>2, 11</sup>
24P3513	xSeries Hot-Swap Power Conversion Kit <sup>3</sup>
94G7448	Rack Power Cable Type C12 (3.7m) <sup>11</sup>
<b>Free-Standing Uninterruptible Power Supply (UPS)<sup>4</sup></b>	
SUP102Y	APC Smart-UPS 1000
SUP142Y	APC Smart-UPS 1400
<b>Rack-Mount Uninterruptible Power Supply (UPS)<sup>4</sup></b>	
14RIxxx <sup>13</sup>	APC Smart-UPS 1400RMiB <sup>5</sup>
32P16xx <sup>14</sup>	APC 2U Smart-UPS 1400RMiB <sup>7</sup>
30RIxxx <sup>13</sup>	APC Smart-UPS 3000RMiB <sup>5</sup>
37L6862	APC Smart-UPS 5000RMiB <sup>6</sup>
<b>Monitors<sup>8</sup></b>	
T3147xx <sup>15</sup>	E54 Color Monitor 15in (350mm, 13.8in Viewable Image Size), stealth black <sup>9</sup>
T3247xx <sup>15</sup>	E74 Color Monitor 17in (403mm, 15.9in Viewable Image Size), stealth black <sup>9</sup>
T274Axx <sup>15</sup>	G78 Color Monitor 17in (406.4mm, 16in Viewable Image Size), stealth black <sup>9</sup>
T11AGxx <sup>15</sup>	T540 Flat Panel Color Monitor 15in (381mm, 15in viewable image), stealth black <sup>10</sup>

1. xSeries 232 models P/N P811Xxx, P81RXxx, P821Xxx, P82RXxx, P841Xxx, P84RXxx include a single 385W power supply and a single standard country power cord. Power supply redundancy may be achieved by removing the standard power supply and installing two or three optional 250W Hot-Swap Redundant Supplies P/N 33L37xx. xSeries Hot-Swap Power Conversion Kit P/N 24P3513 is required when optional power supplies are added to these base models. Models P/N P822Xxx, P82SXxx, P842Xxx, P84SXxx shipping standard with power redundancy, are equipped with two hot-swap 250W power supplies. A third hot-swap 250W power supply may be added for robust configurations. The hot-swap power supply backplane is included in redundant models. To assist in determining when an additional power supply is required to preserve redundancy, a "Non-Redundant LED" is a standard feature.
2. 250W Hot-Swap Redundant Power Supply P/N 33L37xx includes a single standard country power cord. xSeries Hot-Swap Power Supply Conversion Kit P/N 24P3513 must be installed prior to adding optional power supplies in those base models that include a single 385W power supply.
3. xSeries Hot-Swap Power Supply Conversion Kit P/N 24P3513 includes a hot-swap power backplane. Use when installing hot-swap power supplies in 385W models (removal of standard power supply required). See also Notes 1 and 2.
4. For runtimes and UPS attributes see Appendix C: UPS Runtime Estimate.
5. Height is 3U. See Rack Cabinets and Options section for supported IBM racks.
6. Height is 5U. See Rack Cabinets and Options section for supported IBM racks.
7. Height is 2U. See Rack Cabinets and Options section for supported IBM racks.
8. xSeries 232 uses an SVGA controller (S3 Savage4 chipset) with 8MB of video memory.
9. Installation within a rack requires optional Monitor Compartment P/N 94G7444.
10. Installation within a rack requires optional Flat Panel Monitor Rack Mount Kit II P/N 37L6888 and Rack Keyboard Tray P/N 28L4707. A space saver keyboard may coexist within the same keyboard tray. See Rack Cabinets and Options section for more information.
11. Rack Power Cable P/N 94G7448 (one for each power supply), must be ordered for power connection of a Rack model to a high voltage UPS or PDU.
12. Where 'xx' represents a specific country code as follows: 60=Saudi Arabia, 61=Europe, 62=Denmark, 63=Israel, 64=Italy, 65=South Africa, 66=Switzerland, 67=United Kingdom&Arabia.
13. Where 'xxx' represents a specific country code as follows:- DEN=Denmark, ISR=Israel, ITA=Italy, SDI=Saudi Arabia, SAF=South Africa, SWS=Switzerland, UKM=United Kingdom, EUR=Europe.
14. Where 'xx' represents a specific country code as follows:- 12=Europe, 13=UK, 14=Italy, 15=Switzerland, 16=Denmark, 17=South Africa, 18=Israel.
15. Where 'xx' represents a specific country code as follows: DK=Denmark, IS=Israel, IT=Italy, SD=Saudi Arabia, SA=South Africa, CH=Switzerland, UK=UK, EU=Europe.

Part Number	Description
<b>Conversion Kits</b>	
21P9593	5Ux24D Tower-to-Rack Kit II
<b>Rack and NetBAY<sup>1, 6</sup></b>	
94G7448	Rack Power Cable Type C12 (3.7m) <sup>6</sup>
<b>NOTE:</b> Refer to the Rack Cabinets and Options section for details of IBM Racks and rack-supported devices.	
<b>Keyboard and Mouse<sup>2</sup></b>	
28L36xx <sup>7</sup>	Space Saver II Keyboard <sup>3, 5</sup>
28L36xx <sup>8</sup>	Preferred Keyboard (stealth black) <sup>4</sup>
28L3675	Sleek 2-Button Stealth Black Mouse

1. xSeries 232 rack models are housed in a 19in rack-mountable drawer and require one of the racks listed in the Rack Cabinets and Options section.
2. Tower models include both a standard keyboard and mouse. Rack models include neither.
3. Installation within a rack requires optional keyboard tray P/N 28L4707, which stows in ready-to-use position.
4. Installation within a rack requires optional keyboard tray P/N 28L4707. This keyboard cannot share a keyboard tray with a flat panel display.
5. Advanced TrackPoint IV features are not available on IBM xSeries systems.
6. The xSeries 232 ships with a standard country power cord. For connection of a Rack model to a high voltage UPS or PDU, or if a Tower model is being converted for rack installation and is to be connected to a UPS or PDU, a Rack Power Cable P/N 94G7448 (one for each power supply), must be ordered.
7. Where 'xx' represents a specific country code as follows: 46=Danish, 47=France, 48=Germany, 49=Italian, 50=Spanish, 51=UK English, 44=US English, and P/N 19K3831=Switzerland, 19K3832=Sweden/Finland, 19K3833=Portugal, 19K3834=Belgium, 19K3836=Russia, 19K3837=Poland.
8. Where 'xx' represents a specific country code as follows:- 25=French, 26=German, 27=Italian, 29=UK English, 31=Danish, 33=Norwegian, 34=Swedish/Finnish, 35=Swiss, 36=Dutch, 21=US English, and P/N 22P7325=Belgium/UK, 22P7323=Icelandic.



**xSeries 232 Tape Options**

Part Number	Tape Drives	Bays Supported	SCSI Interface (bit)	Form Factor	Termination Included	68/50-pin Converter Incl	Ext Tape Enclosures
00N7991	20/40GB DDS/4 4mm Internal SCSI Tape Drive <sup>1</sup>	A, B	16 Ultra2 LVD	89mm (3.5in) HH or 133mm (5.25in) HH	N	-	10L7440 <sup>3</sup> , 03K8756 <sup>2</sup>
09N4040	20/40GB DLT Internal SCSI Tape Drive <sup>1</sup>	A+B	8	133mm (5.25in) FH	N	Y	03K8756 <sup>3</sup>
00N7990	40/80GB DLT Internal SCSI Tape Drive <sup>1</sup>	A+B	16 Ultra2 LVD	133mm (5.25in) FH	N	-	03K8756 <sup>2</sup>
00N8015	110/220GB Super DLT Internal SCSI Tape Drive <sup>1</sup>	A+B	16 Ultra2 LVD	133mm (5.25in) FH	N	-	03K8756 <sup>2</sup>
00N8016	100/200GB LTO Internal SCSI Tape Drive <sup>1</sup>	A+B	16 Ultra2 LVD	133mm (5.25in) FH	N	-	03K8756 <sup>2</sup>
24P2396	100/200GB LTO Internal SCSI HH Tape Drive <sup>1</sup>	A, B	16 Ultra2 LVD	133mm (5.25in) HH	N	-	03K8756 <sup>2</sup>
24P2398	40/80GB DLTVS Internal SCSI Tape Drive <sup>1</sup>	A, B	16 Ultra2 LVD	133mm (5.25in) HH	N	-	03K8756 <sup>2</sup>
<b>Tape Autoloaders</b>							
00N7992	120/240GB DDS/4 Internal SCSI Tape Autoloader <sup>1</sup>	A+B	16 Ultra2 LVD	133mm (5.25in) FH	N	-	03K8756 <sup>2</sup>
00N79xx <sup>9</sup>	DLT SCSI Tape Autoloader	-	16	Desktop	Y	-	-
<b>External Tape Libraries<sup>4</sup></b>							
00N79xx <sup>10</sup>	DLT SCSI Tape Library	-	16	Desktop or Rack	Y	-	-
<b>External Tape Enclosures</b>							
10L7440	External Half High SCSI Storage Enclosure <sup>5</sup>	-	8/16	Desktop	N	N	-
03K8756	NetMEDIA Storage Expansion Unit EL <sup>6</sup>	-	16	Rack	Y	N	-
10L7113	NetMEDIA Systems Management Adapter <sup>7</sup>	-	16 LVD	-	N	N	03K8756
<b>Associated Options</b>							
00N7956	68-pin External Multimode LVD/SE SCSI Terminator	-	16 LVD/SE	Ext.	Y	N	10L7440, 03K8705
10K2340	Media BayTray and LVD Cable Kit <sup>1, 2</sup>	-	16 LVD	Int	Y	N	03K8756
24P3513	xSeries Hot-Swap Power Conversion Kit <sup>8</sup>	-	-	-	-	-	-
33L37xx <sup>11</sup>	250W Hot-Swap Redundant Power Supply	-	-	-	-	-	-

**Note: Additional power is not required when installing a SCSI device in bay A or B.** If adding additional power supplies to base models for redundancy, removal of the standard 385W power supply is required before adding both Hot-Swap Power Conversion Kit P/N 24P3513 and two or three optional 250W Hot-Swap Redundant Power Supplies P/N 33L37xx. Models shipped standard with redundant power contain two hot-swap 250W power supplies (maximum of three). External tape enclosures are supported by PCI Wide Ultra160 SCSI Adapter P/N 19K4646 which has an external 0.8mm VHDCI connector.

1. Internal tape drives require the two-drop multi-mode terminated LVD SCSI cable included with the Media Bay Tray and LVD Cable Kit P/N 10K2340.
2. LVD support for LVD devices installed in a NetMEDIA Storage Expansion Unit EL P/N 03K8756 requires replacement of the standard single-ended internal cables with one or more (depending on configuration) cables from Media Bay Tray and LVD Cable Kit P/N 10K2340 which contains a single two-drop multi-mode terminated cable. If the standard cables are used for attachment to LVD devices, single-ended SCSI rules and bus speeds apply.
3. Requires 68-pin External Multimode LVD/SE SCSI terminator P/N 00N7956.
4. Tape library attributes and prerequisites are located in Appendix B: Tape Library Attributes.
5. Provides a black desktop 133 mm (5.25") half-high (HH) tape enclosure. Connector is configurable as 50-pin Centronix or 68-pin high density. Requires either tape drive self termination or 68-pin External Multimode LVD/SE SCSI Terminator P/N 00N7956.
6. NetMEDIA Storage Expansion Unit EL P/N 03K8756 is a black 3U, 19in rack mountable tape enclosure which includes two full-high (FH) or four half-high (HH) extended length 133mm (5.25in) bays, two external 0.8mm VHDCI connectors and two internal four-drop single-ended terminated 16-bit SCSI cables for device attachment. Two power supplies and two standard country power cords are also included. Tip: The front rail clips will need to be reversed and screwed in from behind to secure the unit in a Rack Cabinet P/N 930842x.
7. NetMEDIA Systems Management Adapter P/N 10L7113 may be installed in a NetMEDIA Storage Expansion Unit to provide repeater function, LVDS interface, aggregate cable lengths up to 12m when attached to an LVD SCSI controller, and auto-termination when the Expansion Unit is powered off. External connector is 0.8mm VHDCI.
8. IBM eServer xSeries Hot-Swap Power Conversion Kit P/N 24P3513 includes a hot-swap power backplane. Required when upgrading standard power on base models P/N P811Xxx, P81RXxx, P821Xxx, P82RXxx, P841Xxx, P84RXxx, which are shipped with a single 385W power supply that must be removed when adding this option.
9. Where 'xx' represents a country specific power cord code: 70=UK, 71=Swiss, 72=Italy, 73=Israel, 33L4981=EU1, 33L4982=Denmark, 33L4983=South Africa/India.
10. Where 'xx' represents a country specific power cord code: *Tower versions* - 74=EU1, 75=Denmark, 76=India/South Africa, 77=UK, 78=Swiss, 79=Italy, 80=Israel; *Rack versions* - 81=EU1, 82=Denmark, 83=India/South Africa, 84=UK, 85=Swiss, 86=Italy, 87=Israel.
11. Where 'xx' represents a specific country code as follows: 60=Saudi Arabia, 61=Europe, 62=Denmark, 63=Israel, 64=Italy, 65=South Africa, 66=Switzerland, 67=United Kingdom&Arabia.

Note: Additional tape attributes can be found in Appendix A: Tape Drive Attributes.

Note: For a complete list of all IBM and non-IBM options compatibility with Network Operating Systems and IBM xSeries Servers, access the IBM ServerProven compatibility pages on the Web at URL <http://www.ibm.com/pc/us/compat>





## xSeries 232 Sample Configurations

Note: The following sample configurations are for illustration only and may not be suitable for any specific customer installation. Contact your IBM Business Partner or IBM Marketing Representative for assistance with your specific configuration requirements.

### Internet Server

Part Number	Description	Quantity
P811Xxx	xSeries 232 1GHz/256KB Pentium III, 256MB ECC, Open, 48X	1
33L3320	128MB PC133 ECC SDRAM RDIMM	2 <sup>1</sup>
06P5740	ServeRAID-4Lx Ultra160 SCSI Controller	1
37L7206	36.4GB 10K-4 Ultra160 SCSI Hot-Swap SL HDD	4 <sup>2</sup>
24P2396	100/200GB LTO Internal SCSI HH Tape Drive	1
10K2340	Media Bay Tray and LVD Cable Kit	1
T3147xx	E54 Color Monitor 15in (350mm, 13.8in viewable image), stealth black	1
SUP102Y	APC Smart-UPS 1000	1

1. For a total of 512MB of system memory.

2. Three HDDs are used for RAID 5 protection. One HDD is identified as a hot-spare. Effective capacity is two HDDs or 72.8GB.

An Internet server handles all requests from the Internet (Intranet or Extranet). Usually this type of server has the same characteristics as a file server. The main difference is that an Internet server uses a different protocol (TCP/IP vs NETBEUI or IPX/SPX) and often needs to perform an extra security check (firewall). In the case of an Internet server, the server itself communicates primarily with one client, the Internet Service Provider (ISP), instead of many clients as applies to a file server.

With this in mind, the xSeries 232 was selected to provide an affordable price point for the growing Internet server market with two-way Pentium processing, 512MB of system memory (expandable to 4GB), availability features such as RAID-protected internal hot-swap storage and power protection with an APC Smart-UPS.

The network configuration depends on the method that will be used to connect the server to the Internet. Usually fast Ethernet routers are used, but if other methods are preferable, you can add the appropriate adapter. The configuration includes a tape back-up unit for secure storage of critical data in the event of a system or storage media failure.

### File and Print Server

Part Number	Description	Quantity
P821Xxx	xSeries 232 1.13GHz/512KB Pentium III, 256MB ECC, Open, 48X	1
33L3322	256MB PC133 ECC SDRAM RDIMM	2 <sup>1</sup>
06P5740	ServeRAID-4Lx Ultra160 SCSI Controller	1
37L7205	18.2GB 10K-4 Ultra160 SCSI Hot-Swap SL HDD	5 <sup>2</sup>
24P2396	100/200GB LTO Internal SCSI HH Tape Drive	1
10K2340	Media Bay Tray and LVD Cable Kit	1
T3147xx	E54 Color Monitor 15in (350mm, 13.8in viewable image), stealth black	1
SUP102Y	APC Smart-UPS 1000	1
24P3513	xSeries Hot-Swap Power Conversion Kit	1
33L37xx	250W Hot-Swap Redundant Power Supply	2

1. For a total of 768MB of system memory.

2. Four HDDs are used for RAID 5 protection. One HDD is identified as a hot-spare. Effective capacity is three HDDs or 54.6GB.

A small business or departmental server is usually required to perform all typical server functions while servicing up to 100 users in a normal workgroup computing environment, but doesn't require the high-end performance and fault-tolerance properties of larger servers.

The sample configuration above consists of an xSeries 232 with 768MB of memory (expandable to 4GB) and 54.6GB of RAID-protected hard disk drive space. It has enough processor power and memory to run most current network operating systems comfortably and enough hard disk drive space to store a significant amount of data with additional external storage expansion still available. Demanding network traffic is effectively handled by the standard 100Mbps Ethernet connection.

This configuration also includes a tape back-up unit, monitor, and a UPS to protect the system during power surges and outages.

### Rack-Mounted Application Server

Part Number	Description	Quantity
P82SXxx	xSeries 232 1.13GHz/512KB Pentium III, 256MB ECC, Open, 48X, PCI (5U Rack)	1
24P3512	xSeries 1.13GHz/133MHz 512KB Cache Upgrade with Pentium III Processor SVR	1
33L3324	512MB PC133 ECC SDRAM RDIMM	2 <sup>1</sup>
06P5736	ServeRAID-4Mx Ultra160 SCSI Controller	1
37L7205	18.2GB 10K-4 Ultra160 SCSI Hot-Swap SL HDD	5 <sup>2</sup>
24P2396	100/200GB LTO Internal SCSI HH Tape Drive	1
10K2340	Media Bay Tray and LVD Cable Kit	1
T3147xx	E54 Color Monitor 15in (350mm, 13.8in viewable image), stealth black	1
14RIxxx	APC Smart-UPS 1400RMiB	1
33L37xx	250W Hot-Swap Redundant Power Supply	1
Industry Standard 19in Rack, EIA-310D, min depth of 28in (711mm)		
9306250	NetBAY25 Standard Rack Cabinet	1
28L36xx	Space Saver II Keyboard	1
94G6670	Blank Filler Panel Kit	2

1. For a total of 1.25GB of system memory.

2. Five HDDs are used for RAID 5 protection. Effective capacity is four HDDs or 72.8GB.

An application server differs from a file and print server in that it services a larger workload in providing application serving requirements for users. With this in mind, the xSeries 232 was selected to provide an affordable price point for an application server with two-way Pentium III processing, 1.25GB of system memory (expandable to 4GB), and availability features such as battery-backed cache, RAID-protected internal hot-swap storage and power protection with an APC Smart-UPS.

To access IBM information specific to your country via the World Wide Web, use address: <http://www.ibm.com/pc>





# IBM xSeries 240

Part Number  
 Withdrawal Date: ddmmyy  
 Processor Speed<sup>2</sup>  
 Number of Processors (Std./Max)  
 L2 ECC Cache (KB)  
 Memory (Std./Max) (R=RDIMM)<sup>3</sup>  
 Form Factor  
 Power Supply Quantity (Std./Max)  
 Hot-Swap (Power, HDD, Fans)  
 Redundancy (Optional, Standard)  
 Adv. System Management Processor  
 Onboard Ethernet (Mbps)  
 SCSI Controller (Dual, Ultra, RAID)  
 Removable Media Bays (Total/Avail)  
 Internal Hard Disk Drive (Std./Max)  
 CD-ROM (IDE)<sup>5</sup>  
 Bays: (Tot/Av)  
 Slots: (Tot/Av)

xSeries 240 At-A-Glance Chart																		
K481Yxx	-	1 GHz	1/2	256	256MB (R)/4GB	Tower	2/3	P, S,H,F	S-Power <sup>4</sup> S-Fans	Y	10/100	D,U2	4/2	0/440.4GB	40X- 17X	10/8	5/5	
K48RYxx <sup>1</sup>	-	1 GHz	1/2	256	256MB (R)/4GB	Rack(5U)	2/3	P, S,H,F	S-Power <sup>4</sup> S-Fans	Y	10/100	D,U2	4/2	0/440.4GB	40X- 17X	10/8	5/5	

1. Housed in a 19" Rack mountable drawer and ships standard without a keyboard or mouse. See Rack Cabinets and Options section for supported IBM racks.
2. Intel Pentium III processor with advanced transfer (full speed) L2 cache and 133 Mhz Front-Side Bus.
3. High-speed, 133 MHz SDRAM.
4. Robust configurations may require optional 250W Hot-Swap Redundant Power Supply P/N 33L37xx for redundancy. See xSeries 240 Power, Monitor, Accessories for additional information.
5. Variable read rate. Actual playback speed will vary and is often less than the maximum possible.

## xSeries 240 Processor Upgrades

Part Number	Processor Upgrades Description	SMP Support <sup>1</sup>	Processor Speed Upgrade <sup>2</sup>
19K4640	1GHz Upgrade with 133MHz FSB and 256KB Advanced Transfer Cache Pentium III Processor	K481Yxx, K48RYxx	-

1. One additional processor may be installed, providing a maximum of two. All processors must be identical in type, speed, and cache size.
2. Requires removal of the standard processor. A maximum of two processors may be installed. All processors must be identical in type, speed and cache size. Upgrades may require a BIOS update. To obtain the latest Flash BIOS, access [www.ibm.com/pc/support](http://www.ibm.com/pc/support) and enter machine "Type-Model" in Quick Path. Select "Downloadable files" and then "BIOS".

### xSeries 240 Memory Configurator

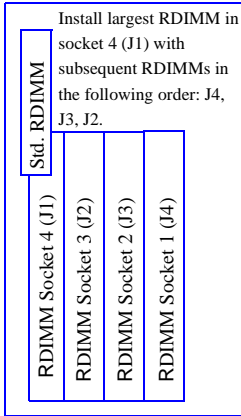

Total Memory <sup>1</sup>	Quantity of RDIMMs Added			
	128MB P/N 33L3058	256MB P/N 33L3060	512MB P/N 33L3062	1GB P/N 33L3064
256MB (1 x 256) Models				
384MB	1	-	-	-
512MB	2 or	1	-	-
640MB	3	-	-	-
768MB	-	2 or	1	-
1024MB	-	3	-	-
1280MB	-	-	2 or	1
1792MB	-	-	3	-
2048MB	-	-	4 <sup>2</sup>	-
2304MB	-	-	-	2
3328MB	-	-	-	3
4096MB (max) <sup>2</sup>	-	-	-	4 <sup>2</sup>

This table does not represent all possible memory configurations.  
 1. Network operating systems may limit the maximum amount of addressable memory. See operating system specifications for further information.  
 2. Requires removal of standard memory.

Part Number	Memory Description <sup>1</sup>
33L3058	128MB, 133MHz SDRAM ECC RDIMM
33L3060	256MB, 133MHz SDRAM ECC RDIMM
33L3062	512MB, 133MHz SDRAM ECC RDIMM
33L3064	1GB, 133MHz SDRAM ECC RDIMM

1. Install largest RDIMM in socket 4 (J1) with subsequent RDIMMs in the following order: J4, J3, J2.

### xSeries 240 Internal SCSI Cabling

The xSeries 240 contains a backplane supporting six hot-swap drive bays. The backplane is connected to the integrated dual channel, wide Ultra2 SCSI controller connector through a 16-bit LVD SCSI cable. If internal RAID support is required, this cable can be used to connect to a supported RAID adapter rather than the integrated SCSI controller. A two-drop, 16-bit non-LVD SCSI cable with integrated terminator is also included with the server and can support up to two internal removable media devices. Alternatively, PCI U160 SCSI Adapter P/N 19K4646 includes an LVD cable for use with the adapter to support the media bays in a non-RAID system. In a RAID system Media Bay Kit P/N 10K2340 provides an LVD cable for use with the integrated controller. The second channel of the integrated controller is available through an industry-standard 0.8-mm very high density connector interface (VHDCI) located on the rear panel for external use.

**For additional information regarding internal cabling, refer to Appendix E: Internal Storage Cabling Overview.**



**xSeries 240 Internal Hard Disk Drive (HDD) and External Storage Configurator**

Total Int. Storage <sup>1</sup>	10,000RPM Ultra160 <sup>2</sup> SCSI HDDs				15,000RPM Ultra160 <sup>2</sup> SCSI HDDs	
	9.1GB P/N37L7204	18.2GB P/N37L7205 or 06P5754	36.4GB P/N37L7206 or 06P5755	73.4GB P/N06P5756	18.2GB P/N19K0656 or 06P5767	36.4GB P/N 06P5768
0GB	0GB Standard on Base Models				0GB Standard on Base Models	
9.1GB	1	-	-	-	-	-
18.2GB	2 or	1	-	-	1	-
27.3GB	3	-	-	-	-	-
36.4GB	4 or	2 or	1	-	2 or	1
45.5GB	5	-	-	-	-	-
54.6GB	6 or	3	-	-	3	-
72.8GB	-	4 or	2	-	4 or	2
91.0GB	-	5	-	-	5	-
109.2GB	-	6 or	3	-	6 or	3
145.6GB	-	-	4	-	-	4
182.0GB	-	-	5	-	-	5
218.4GB	-	-	6	-	-	6
220.2GB	-	-	-	3	-	-
293.6GB	-	-	-	4	-	-
367.0GB	-	-	-	5	-	-
440.4GB (max)	-	-	-	6	-	-

This table does not represent all possible hard disk drive (HDD) configurations.

1. Select a total storage row then identify the recommended HDDs from within an RPM range according to choice. Total Internal Storage listed is within ± 0.2 GB unless otherwise noted.
2. xSeries 240 contains an Ultra2 hot-swap backplane which limits Ultra160 HDDs to Ultra2 bus speeds.



Bay	Form Factor	Height	Front Access	Usage	Part Number	Description	RPM	Height	Bays Supported	Max. Qty.
A	133mm (5.25in)	HH <sup>1</sup>	Yes	Open	<b>Hot-Swap Ultra160 SCSI HDDs<sup>1</sup></b>					
B	133mm (5.25in)	HH <sup>1</sup>	Yes	Open	37L7204	9.1GB 10K-4 Ultra160 Hot-Swap HDD	10000	SL	C...H	6
-	133mm (5.25in)	HH	Yes	IDE CD-ROM	37L7205	18.2GB 10K-4 Ultra160 Hot-Swap HDD	10000	SL	C...H	6
-	89mm (3.5in)	SL	Yes	Diskette	06P5754	18.2GB 10,000rpm Ultra160 Hot-Swap HDD	10000	SL	C...H	6
C...H	HS	SL	Yes	Open	37L7206	36.4GB 10K-4 Ultra160 Hot-Swap HDD	10000	SL	C...H	6
					06P5755	36.4GB 10,000rpm Ultra160 Hot-Swap HDD	10000	SL	C...H	6
					06P5756	73.4GB 10,000rpm Ultra160 Hot-Swap HDD	10000	SL	C...H	6
					06P5767	18.2GB 15,000rpm Ultra160 Hot-Swap HDD	15000	SL	C...H	6
					19K0656	18.2GB 15,000rpm Ultra160 Hot-Swap HDD	15000	SL	C...H	6
					06P5768	36.4GB 15,000rpm Ultra160 Hot-Swap HDD	15000	SL	C...H	6
<b>Optical Devices</b>							<b>Bays Supported</b>			
					10K3785	12X-8X-32X Black Internal CD-RW Drive <sup>2,9</sup>	A, B			
					22P6950	16X Max RAM-Read DVD-ROM Drive <sup>2,3</sup>	A, B			
<b>External Storage Expansion Units<sup>4</sup></b>							<b>Form Factor</b>			
					19K11xx <sup>11</sup>	EXP300 Storage Expansion Unit <sup>5,10</sup>	Rack (3U)			
					09N7296	EXP300 Rack-to-Tower Conversion Kit	-			
					19K11xx <sup>12</sup>	FASiT 200 Storage Server <sup>6,7,10</sup>	Rack (3U)			
					19K11xx <sup>13</sup>	FASiT 200 HA Storage Server <sup>6,10</sup>	Rack (3U)			
					19K1121	FASiT 200 Redundant RAID Controller <sup>7</sup>	-			
					00N71xx <sup>14</sup>	FASiT EXP500 Storage Expansion Unit <sup>8,10</sup>	Rack (3U)			
					94G7448	Rack Power Cable Type C12 (3.7m) <sup>10</sup>	-			

1. Two half-high (HH) bays can be combined to support a single full-high (FH) device

- xSeries 240 contains an Ultra2 hot-swap backplane which limits Ultra160 HDDs to Ultra2 bus speeds.
- Either replace standard CD-ROM or install in one of the media bays. An IDE cable with three connectors is included with the optional optical drive. If installing as an additional device, connect the cable to each optical device and the IDE connector on the system board. Configure the optional device as a master using the preset configuration if replacing the standard device or as a slave if installed as a redundant device.
- Audio not supported for DVD-ROM drives. The drive operates in video mode only.
- Not supported by the onboard external SCSI port. To configure an external SCSI storage devices, select an optional SCSI controller then refer to see Appendix D: Cables-Storage Units-Controllers to confirm that the controller supports the desired External Storage Expansion Unit and to select a supported cable. For HDD or other expansion unit options, see the specific expansion unit section. For Fibre Channel storage devices, refer to the Fibre Channel Solutions Overview section.
- The EXP300 includes a single 2 M Ultra2 SCSI cable and dual hot-swap 500 W redundant power supplies, each with it's own standard country power cord. To convert an EXP300 to a tower form factor, EXP300 Rack-to-Tower Conversion Kit P/N 09N7296 is required.
- The FASiT200 Storage Server and HA Storage Server each include two hot-swap, 350 W auto-ranging redundant power supplies each with it's own standard country power cord.
- Can be upgraded to a FASiT200 HA Storage Server through the addition of a FASiT200 Redundant RAID Controller P/N 19K1121.
- The FASiT EXP500 Storage Expansion Unit P/N 00N71xx includes dual hot-swap 350 W power supplies, each with it's own standard country power cord.
- Some operating systems support the read function only.
- These units do not include Rack Power Cables P/N 94G7448 when shipped (for attachment to high voltage UPS or PDU). Standard country power cords only are included. If required, order Rack Power Cables (one for each power supply).
- Where 'xx' represents a specific country code as follows:- 51=US/English, 52=European/English, 56=Danish/English, 57=Israel/English, 58=Italian/English, 59=South Africa/English, 60=Swiss/English, 63=UK/English:- Line Cords/ Publication Country Kits are included as indicated.
- Where 'xx' represents a specific country code as follows:- 23=US/English, 24=Euro/English, 25=Euro/Spanish, 27=Euro/German, 28=Denmark/English, 29=Israel/English, 30=Italy/English, 31=South Africa/English, 32=Switzerland/English, 34=Switzerland/German, 36=UK/English. Country/Language - Line Cords/Publications are included as indicated
- Where 'xx' represents a specific country code as follows:- 37=US/English, 38=Euro/English, 39=Euro/Spanish, 41=Euro/German, 42=Denmark/English, 43=Israel/English, 44=Italy/English, 45=South Africa/English, 46=Switzerland/English, 48=Switzerland/German, 50=UK/English. Country/Language - Line Cords/Publications are included as indicated.
- Where 'xx' represents a specific country code as follows:- 36=US/English, 37=Euro/English, 41=Denmark/English, 42=Israel/English, 43=Italy/English, 44=South Africa/English, 45=Switzerland/English, 49=UK/English. Country/Language Line Cords/Publications are included as indicated.

### Tower Model View

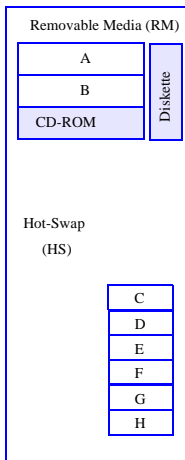

For clarity purposes, bay labels in these diagrams are for reference by the accompanying tables and are not the actual labels. Refer to the documentation shipped with the system for further details on actual labels.

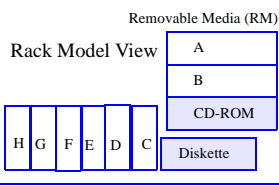

**xSeries 240 I/O Options**

Part Number	Description	Adapter Length	PCI Support <sup>1</sup>	Slots Supported <sup>1</sup>	Hot-Plug <sup>2</sup>
<b>SCSI Storage Controllers<sup>3</sup></b>					
37L6889	ServeRAID-4H Ultra160 SCSI Controller <sup>4</sup>	Full	64-bit	1...5	X
06P5736	ServeRAID-4Mx Ultra160 SCSI Controller <sup>5</sup>	Full	64-bit	1...5	X
06P5740	ServeRAID-4Lx Ultra160 SCSI Controller <sup>6</sup>	Half	64-bit	1...5	X
19K4646	PCI Wide Ultra160 SCSI Adapter <sup>7</sup>	Half	32-bit	1...5	-
02K3454	PCI Fast/Wide Ultra SCSI Adapter <sup>8</sup>	Half	32-bit	1...5	-
<b>Fibre Storage Controller<sup>9</sup></b>					
00N6881	FASiT Host Adapter	Half	64-bit	1...5	X
19K1246	FASiT FC-2 Host Bus Adapter	Half	64-bit	1...5	X
<b>Networking<sup>10</sup></b>					
<b>Ethernet<sup>11</sup></b>					
09N9901	10/100 EtherLink Server Adapter by 3Com <sup>12</sup>	Half	32-bit	1...5	X
06P3601	10/100 Ethernet Server Adapter <sup>12</sup>	Half	32-bit	1...5	X
06P3701	Gigabit Ethernet SX Server Adapter (fibre optic cabling interface)	Half	64-bit	1...5	X
22P4901	10/100 Dual Port Ethernet Server Adapter <sup>12</sup>	Half	64-bit	1...5	X
22P6801	PRO/1000XT Server Adapter by Intel (with CD and manuals) <sup>12</sup>	Half	64-bit	1...5	X
<b>Token Ring</b>					
34L5001	16/4 Token-Ring PCI Management Adapter <sup>12</sup>	Half	32-bit	1...5	X
34L5201	High-Speed 100/16/4 Token-Ring PCI Management Adapter <sup>12</sup>	Half	32-bit	1...5	X
34L0701	Token-Ring 16/4 PCI Adapter 2 with Wake on LAN <sup>12</sup>	Half	32-bit	1...5	X
<b>Communications<sup>13</sup></b>					
37L14xx	Serial I/O SST 8, 16 and 128 Port Adapters <sup>14</sup>	Half	32-bit	1...5 <sup>14</sup>	-
<b>Systems Management<sup>15</sup></b>					
36L96xx <sup>19</sup>	Advanced System Management PCI Adapter <sup>16</sup>	Full	32-bit	1...5 <sup>17</sup>	-
03K9309	Advanced System Management Interconnect Cable Kit <sup>18</sup>	-	-	-	-

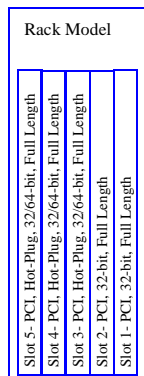

1. A 64-bit adapter installed into a 32-bit slot will transfer data at 32-bit rates. Adapters rated at 66MHz will operate at 33MHz when installed in a 33MHz slot. 33MHz adapters will reduce 66MHz buses to 33MHz. 133MHz PCI-X adapters are backward compatible with 33/66MHz, 64-bit PCI-based servers.

2. Three of the five PCI slots are 32/64-bit hot-plug capable using IBM's Active™ PCI technology. For Network Operating System support access URL [www.ibm.com/pc/us/compat](http://www.ibm.com/pc/us/compat).

3. xSeries 240 has two integrated Wide Ultra2 SCSI channels. One is internal and the other is external with a 0.8-mm Very High Density Connection Interface (VHDCI).

4. ServeRAID-4H Ultra160 SCSI Controller is powered by a 266 MHz PowerPC 750 processor and provides four channels, 128 MB of battery-backed ECC cache with two internal and up to four external Ultra160 connectors (a combination of four connectors may be utilised). External connectors are 0.8-mm VHDCI.

5. ServeRAID-4Mx Ultra160 SCSI Controller is powered by a 100MHz Intel Zion GC80303 processor that provides 64MB of battery-backed ECC cache and two internal and two external Ultra160 connections (only two connectors may be used). External connections are 0.8mm VHDCI.

6. ServeRAID-4Lx Ultra160 SCSI Controller is powered by a 100MHz Intel Zion GC80303 processor and provides a single channel, 32MB of ECC cache and either one internal or one external Ultra160 connection. External connector is 0.8mm VHDCI.

7. PCI Wide Ultra160 SCSI Adapter (P/N 19K4646) provides a single channel with one internal connector and a five-drop multi-mode terminated LVD SCSI cable and one external 0.8-mm VHDCI connector. Only one of the two connectors may be utilised.

8. PCI Fast/Wide Ultra SCSI Adapter P/N 02K3454 provides one external 68-pin high density connector that supports external SCSI devices such as tape enclosures.

9. See Fibre Array Solutions section for additional configuration information.

10. xSeries 240 has an integrated 10/100 PCI Ethernet Controller.

11. In a fault-tolerant networking environment, using the fault-tolerant software delivered with the Ethernet adapters of a single manufacturer is recommended. Installing fault-tolerant solutions provided by multiple manufacturers may cause failures if the intermediate drivers provided with the adapters are not compatible. The onboard Ethernet is AMD-based. The optional PCI Ethernet adapters listed here are Intel-based: P/Ns 06P3601, 06P3701, 22P4901, 22P6801.

12. The Wake on LAN function of this option is not supported by this server.

13. xSeries 240 includes two USB ports, three high-speed serial/asynchronous ports, (two NS16550A compatible, one for the Advanced System Management Processor), and one high-speed (up to 2 MB/sec. data transfer speed) bi-directional parallel port supporting devices using ECP/EPP/SSP protocols adhering to the IEEE 1284 standard.

14. See Appendix F for details on Serial I/O options and configuration limitations. A maximum of four Serial I/O adapters (in any combination) may be installed.

15. The Advanced Systems Management Processor and Interconnect Bus integrated into xSeries 240 works with Netfinity Director to provide significant system management function. When used with optional Advanced System Management PCI Adapter (P/N 36L96xx) and Advanced System Management Interconnect Cable Kit (P/N 03K9309) additional management and control of up to 12 service processors from a remote console through a single modem or LAN connection is possible.

16. Includes PCI adapter, Advanced System Management Interconnect Cable Kit components and 56-watt AC adapter which requires a separate power source. Provides an integrated 10/100 Ethernet port.

17. A maximum quantity of one is supported.

18. Required to provide RS-485 ports to connect the standard Advanced System Management Processor to an interconnect network with other servers for system management support through a single LAN or modem connection. Optional Advanced System Management PCI Adapter (P/N 36L96xx) includes the contents of this option. Up to 12 service processors or optional adapters may be interconnected with an aggregate connection length of no more than 91.4m (300 ft.). A customer-supplied Cat5 Ethernet cable is required for each interconnection.

19. Where 'xx' represents a specific country code as follows:- 57=Denmark, 58=South Africa/India, 59=UK, 60=Switzerland, 61=Italy, 62=Israel, 01K7310=Europe, 01K7209=US/Saudi Arabia.



**xSeries 240 Power, Monitors, Accessories**

Part Number	Description
<b>Power<sup>1,9</sup></b>	
33L37xx <sup>10</sup>	250W Hot-Swap Redundant Power Supply <sup>9</sup>
94G7448	Rack Power Cable Type C12 (3.7m) <sup>9</sup>
<b>Free Standing Uninterruptible Power Supply (UPS)<sup>2</sup></b>	
SUP102Y	APC Smart-UPS 1000
SUP142Y	APC Smart-UPS 1400
<b>Rack Mount Uninterruptible Power Supply (UPS)<sup>2</sup></b>	
14RIxxx <sup>11</sup>	APC Smart-UPS 1400RMB <sup>3</sup>
32P16xx <sup>12</sup>	APC 2U Smart-UPS 1400RMiB <sup>5</sup>
30RIxxx <sup>11</sup>	APC Smart-UPS 3000RMB <sup>3</sup>
37L6862	APC Smart-UPS 5000RMB <sup>4</sup>
<b>Monitors<sup>6</sup></b>	
T3147xx <sup>13</sup>	E54 Color Monitor 15in (350-mm, 13.8in Viewable Image Size), stealth black <sup>7</sup>
T3247xx <sup>13</sup>	E74 Color Monitor 17in (403-mm, 15.9in Viewable Image Size), stealth black <sup>7</sup>
T274Axx <sup>13</sup>	G78 Color Monitor 17in (406.4-mm, 16.0in Viewable Image Size), stealth black <sup>7</sup>
T11AGxx <sup>13</sup>	T540 Flat Panel Color Monitor 15in (381mm, 15in viewable image), stealth black <sup>8</sup>

- xSeries 240 includes two 250W hot-swap power supplies, each with its own standard country power cord. These standard power supplies are sufficient to operate fully configured systems; however optional 250W Hot-Swap Redundant Power Supply P/N 33L37xx is required to preserve redundancy if any of the following are exceeded:  
**Single Processor Configuration:** Six SL hard disk drive (HDDs) and two PCI adapters (1 HH HDD = 2 SL, 1 tape = 2 SL, 1 PCI adapter = 2 SL)  
 e.g. To preserve power supply redundancy with 3 PCI adapters only 4 SL HDDs can be installed before an optional power supply is required.  
**Dual Processor Configuration:** Four SL hard disk drives (HDDs) and two PCI adapters (1 HH HDD = 2 SL, 1 tape = 2 SL, 1 PCI adapter = 2 SL)  
 A "non-redundant" LED on the system unit will indicate when 250W has been exceeded. 250 W Hot-Swap Redundant Power Supply (P/N 33L37xx) includes a standard country power cord which requires an additional power source. An independent power source such as a second UPS or second circuit is not required.
- For runtimes and UPS attributes see Appendix C: UPS Runtime Estimate.
- Height is 3U. See Rack Cabinets and Options section for supported IBM racks.
- Height is 5U. See Rack Cabinets and Options section for supported IBM racks.
- Height is 2U. See Rack Cabinets and Options section for supported IBM racks.
- xSeries 240 uses an SVGA controller (S3 Trio 3D chipset) with 4 MB of video memory.
- Installation within a rack requires optional Monitor Compartment P/N 94G7444.
- Installation within a rack requires optional Flat Panel Monitor Rack Mount Kit II P/N 37L6888 and Rack Keyboard Tray P/N 28L4707. A space saver keyboard may coexist within the same keyboard tray. See Rack Cabinets and Options section for more information.
- Rack Power Cable P/N 94G7448 (one for each power supply), must be ordered for power connection of a Rack model to a high voltage UPS or PDU.
- Where 'xx' represents a specific country code as follows: 60= Saudi Arabia, 61=Europe, 62=Denmark, 63=Israel, 64=Italy, 65=South Africa, 66=Switzerland, 67=United Kingdom&Arabia.
- Where 'xxx' represents a specific country code as follows:- DEN=Denmark, ISR=Israel, ITA=Italy, SDI= Saudi Arabia, SAF=South Africa, SWS=Switzerland, UKM=United Kingdom, EUR=Europe.
- Where 'xx' represents a specific country code as follows:- 12=Europe, 13=UK, 14=Italy, 15=Switzerland, 16=Denmark, 17=South Africa, 18=Israel.
- Where 'xx' represents a specific country code as follows: DK=Denmark, IS=Israel, IT=Italy, SD= Saudi Arabia, SA=South Africa, CH=Switzerland, UK=UK, EU=Europe.

Part Number	Description
<b>Conversion Kits</b>	
37L6858	5Ux24D Tower-to-Rack Kit <sup>6</sup>
<b>Rack and NetBAY<sup>1,6</sup></b>	
94G7448	Rack Power Cable Type C12 (3.7m) <sup>6</sup>
<b>NOTE:</b> Refer to the Rack Cabinets and Options section for details of IBM Racks and rack-supported devices.	
<b>Keyboard and Mouse<sup>2</sup></b>	
28L36xx <sup>7</sup>	Space Saver II Keyboard <sup>3,5</sup>
28L36xx <sup>8</sup>	Preferred Keyboard (stealth black) <sup>4</sup>
28L3675	Sleek 2-Button Stealth Black Mouse

- xSeries 240 rack models are housed in a 19" rack mountable drawer and require one of the racks listed in the Rack Cabinets and Options section.
- Tower models include both a mouse and a keyboard. Rack models include neither.
- Installation within a rack requires optional keyboard tray P/N 28L4707 (stows in "ready-to-use" position).
- Installation within a rack requires optional keyboard tray P/N 28L4707. This keyboard cannot share a keyboard tray with a flat panel display.
- Advanced TrackPoint IV features are not available on IBM xSeries systems.
- The xSeries 240 ships with a standard country power cord. For connection of a Rack model to a high voltage UPS or PDU, or if a Tower model is being converted for rack installation and is to be connected to a UPS or PDU, a Rack Power Cable P/N 94G7448 (one for each power supply), must be ordered.
- Where 'xx' represents a specific country code as follows:- 46=Danish, 47=France, 48=Germany, 49=Italian, 50=Spanish, 51=UK English, 44=US English, and P/N 19K3831=Switzerland, 19K3832=Sweden/Finland, 19K3833=Portugal, 19K3834=Belgium, 19K3836=Russia, 19K3837=Poland.
- Where 'xx' represents a specific country code as follows:- 25=French, 26=German, 27=Italian, 29=UK English, 31=Danish, 33=Norwegian, 34=Swedish/Finnish, 35=Swiss, 36=Dutch, 21=US English, and P/N 22P7325=Belgium/UK, 22P7323=Icelandic.



**xSeries 240 Tape Options**

Part Number	Tape Drives	Bays Supported	SCSI Interface (bit)	Form Factor	Termination Included	68/50-pin Converter Incl.	Ext. Tape Enclosures
09N4042	10/20GB NS Internal SCSI Tape Drive <sup>1</sup>	A, B	8	89mm (3.5in) SL or 133mm (5.25in) HH	Y	Y	10L7440
00N7991	20/40GB DDS/4 4-mm Internal SCSI Tape Drive <sup>2</sup>	A, B	16 Ultra2 LVD	89mm (3.5in) HH or 133mm (5.25in) HH	N	-	10L7440 <sup>4</sup> , 03K8756 <sup>3</sup>
09N4040	20/40GB DLT Internal SCSI Tape Drive <sup>1</sup>	A+B	8	133mm (5.25in) FH	N	Y	03K8756
00N7990	40/80GBDLT Internal SCSI Tape Drive <sup>2</sup>	A+B	16 Ultra2 LVD	133mm (5.25in) FH	N	-	03K8756 <sup>3</sup>
00N8016	100/200GB LTO Internal SCSI Tape Drive <sup>2</sup>	A+B	16 Ultra2 LVD	133mm (5.25in) FH	N	-	03K8756 <sup>3</sup>
00N8015	110/220GB Super DLT Internal SCSI Tape Drive <sup>2</sup>	A+B	16 Ultra2 LVD	133mm (5.25in) FH	N	-	03K8756 <sup>3</sup>
24P2396	100/200GB LTO Internal SCSI HH Tape Drive <sup>2</sup>	A, B	16 Ultra2 LVD	133mm (5.25in) HH	N	-	03K8756 <sup>3</sup>
24P2398	40/80GB DLTVS Internal SCSI Tape Drive <sup>2</sup>	A, B	16 Ultra2 LVD	133mm (5.25in) HH	N	-	03K8756 <sup>3</sup>
<b>Tape Autoloaders</b>							
00N79xx <sup>12</sup>	DLT SCSI Tape Autoloader	-	16	Desktop	Y	-	-
00N7992	120/240GB DDS/4 Internal SCSI Tape Autoloader <sup>2</sup>	A+B	16 Ultra2 LVD	133mm (5.25in) FH	N	-	03K8756 <sup>3</sup>
09N40xx <sup>13</sup>	3600 Series 900GB/1.8TB LTO SCSI Tape Autoloader <sup>5</sup>	-	16 Ultra2 LVD	Tower or 6U Rack	Y	-	-
<b>External Tape Libraries<sup>6</sup></b>							
00N79xx <sup>14</sup>	DLT Tape Library	-	16	Desktop or Rack	Y	-	-
21P99xx <sup>15</sup>	3600 Series 2/4TB LTO Tape Library (Tower)	-	16 Ultra2 LVD	Tower	Y	-	-
21P99xx <sup>15</sup>	3600 Series 2/4TB LTO Tape Library (Rack)	-	16 Ultra2 LVD	5U Rack	Y	-	-
21P99xx <sup>16</sup>	3600 Series 2-Drive, 20-Cartridge Expander Module <sup>7</sup>	-	16 Ultra2 LVD	5U Rack	Y	-	-
09N4048	3600 Series LTO Drive Upgrade Option <sup>8</sup>	-	16 Ultra2 LVD	-	N	-	-
<b>External Tape Enclosures</b>							
10L7440	External Half High SCSI Storage Enclosure <sup>9</sup>	-	8/16	Desktop	N	N	-
03K8756	NetMEDIA Storage Expansion Unit EL <sup>10</sup>	-	16	Rack	Y	N	-
10L7113	NetMEDIA Systems Management Adapter <sup>11</sup>	-	16 LVD	-	N	N	03K8756
<b>Associated Options</b>							
00N7956	68-pin External Multimode LVD/SE SCSI Terminator	-	16 LVD/SE	Ext.	Y	N	10L7440
10K2340	Media Bay Tray and LVD Cable Kit <sup>2,3</sup>	-	16 LVD	Int.	Y	N	03K8756

Note: xSeries 240 includes a wide two-drop single-ended non-LVD terminated cable. If LVD support is required, an optional LVD cable must be ordered. An external Ultra2 SCSI port is available with a 0.8-mm VHDCI connector. External tape enclosures are supported by the standard external SCSI port or PCI Wide Ultra 160 SCSI Adapter P/N 19K4646 which has an external 0.8-mm VHDCI connector.

- Requires PCI Wide Ultra 160 SCSI Adapter P/N 19K4646 which contains a five-drop multi-mode terminated LVD SCSI cable, when the onboard Ultra2 SCSI controller is connected to the backplane.
  - If the backplane is connected to the onboard Ultra2 SCSI controller, PCI Wide Ultra 160 SCSI Adapter P/N 19K4646, which contains a five-drop multi-mode terminated LVD SCSI cable, is required. If the backplane is connected to an optional RAID controller, the two-drop multi-mode terminated LVD SCSI cable included with the Media Bay Tray and LVD Cable Kit P/N 10K2340 is required to support LVD Mode. Connecting an LVD tape device to the single-ended terminated cable shipped with the server limits the tape device to single-ended SCSI rules.
  - LVD support for LVD devices installed in a NetMEDIA Storage Expansion Unit EL P/N 03K8756 requires replacement of the standard single-ended internal cables with one or more (depending on configuration) cables from Media Bay Tray and LVD Cable Kit P/N 10K2340 which contains a single two-drop multi-mode LVD-SCSI terminated cable. If the standard cables are used for attachment to LVD devices, single-ended SCSI rules and bus speeds apply.
  - Requires 68-pin External Multimode LVD/SE SCSI terminator P/N 00N7956.
  - If installed in a rack, a fixed shelf is required. Allow an additional 1U for the fixed shelf. One unit only per shelf is supported.
  - Tape library attributes and prerequisites are located in Appendix B: Tape Library Attributes.
  - Supported only with the 3600 Series LTO Tape Library (Rack) P/N 21P99xx. Allow one additional EIA space when installing either one or two (maximum) units to accommodate a filler plate for cable routing. Up to two 3600 Series LTO Drive Upgrade Options can be installed in each module or the module can operate off the LTO drives installed in the LTO tape library.
  - Install in second drive bay of 3600 Series LTO Tape Libraries or in open bays of 3600 Series 2-drive, 20-cartridge Expander Module to increase performance. Includes an LTO (Ultrium) drive and a one-meter external LVD SCSI cable.
  - Provides a black desktop 133 mm (5.25") half-high (HH) tape enclosure. Connector is configurable as 50-pin Centronix or 68-pin high density. Requires either tape drive self termination or 68-pin External Multimode LVD/SE SCSI Terminator P/N 00N7956.
  - NetMEDIA Storage Expansion Unit EL P/N 03K8756 is a black 3U, 19" rack-mountable tape enclosure which includes two full high (FH) or four half high (HH) extended length 133 mm (5.25") bays, two external 0.8mm VHDCI connectors and two internal four-drop single-ended terminated 16-bit SCSI cables for device attachment. Two power supplies and two power cords are also included. Tip: The front rail clips will need to be reversed and screwed in from behind to secure the unit in a Rack Cabinet P/N 930842x.
  - NetMEDIA Systems Management Adapter P/N 10L7113 may be installed in a NetMEDIA Storage Expansion Unit to provide repeater function, LVDS interface, aggregate cable lengths up to 12 meters when attached to an LVD SCSI controller, and auto-termination when the Expansion Unit is powered off. External connector is 0.8mm VHDCI.
  - Where 'xx' represents a country specific power cord code: 70=UK, 71=Swiss, 72=Italy, 73=Israel, 33L4981=EU1, 33L4982=Denmark, 33L4983=South Africa/India.
  - Where 'xx' represents a specific country code as follows: 49=UK, 50=Europe, 51=Denmark, 52=South Africa, 53=Switzerland, 54=Italy, 55=Israel.
- Note: Additional tape details can be found in Appendix A: Tape Drive Attributes.
- Where 'xx' represents a country specific power cord code: *Tower versions* - 74=EU1, 75=Denmark, 76=India/South Africa, 77=UK, 78=Swiss, 79=Italy, 80=Israel; *Rack versions* - 81=EU1, 82=Denmark, 83=India/South Africa, 84=UK, 85=Swiss, 86=Italy, 87=Israel.
  - Where 'xx' represents a specific country code as follows: *Tower version* - 71=Europe, 72=Denmark, 73=South Africa, 70=UK, 74=Swiss, 75=Italy, 76=Israel; *Rack version* - 78=Europe, 79=Denmark, 80=South Africa, 77=UK, 81=Swiss, 82=Italy, 83=Israel.
  - Where 'xx' represents a specific country code as follows: 85=Europe, 86=Denmark, 87=South Africa, 84=UK, 88=Swiss, 89=Italy, 90=Israel.

Note: For a complete list of all IBM and non-IBM options compatibility with Network Operating Systems and IBM xSeries and Netfinity Servers, access the IBM ServerProven compatibility pages on the Web at URL <http://www.ibm.com/pc/us/compat>



## xSeries 240 Sample Configurations

Note: The following sample configurations are for illustration only and may not be suitable for any specific customer installation. Contact your IBM Business Partner or IBM Marketing Representative for assistance with your specific configuration requirements.

### High Availability Application Server

Part Number	Description	Quantity	Usage
K481Yxx	xSeries 240 1GHz/256KB, 256MB ECC, Open, 40X, PCI	1	-
33L3060	256MB, 133MHz SDRAM ECC RDIMM	1	512MB total system memory
37L7204	9.1GB 10K-4 Ultra160 SCSI Hot-Swap SL HDD	2	9.1GB mirrored for NOS
37L7205	18.2GB 10K-4 Ultra160 SCSI Hot-Swap SL HDD	4 <sup>1</sup>	-
24P2396	100/200GB LTO Internal SCSI HH Tape Drive	1	-
10K2340	Media Bay Tray and LVD Cable Kit	1	-
06P5740	ServeRAID-4Lx Ultra160 SCSI Controller	1	RAID 5
33L37xx	250W Hot-Swap Redundant Power Supply	1	Full power redundancy
T3147xx	E54 Color Monitor 15in (350mm, 13.8in Viewable Image Size), stealth black <sup>6</sup>	1	-
SUP102Y	APC Smart-UPS 1000	1	UPS

1. Four HDDs are used for RAID 5 protection. Effective capacity is three HDDs or 54.6GB

This tower server is configured to act as the foundation for business critical applications that your business cannot afford to be without. Configured with enough HDD storage to mirror the operating system and provide a standard RAID 5 environment for data, optional hot-swap redundant power and UPS for power even during a blackout, this server represents the leading edge in high availability. An internal tape drive is included to back up that all important asset...data. A modem could be included to allow out-of-band (non-LAN) system management utilising the integrated Advanced System Management Processor.

### High Availability File Server

Part Number	Description	Quantity	Usage
K481Yxx	xSeries 240 1GHz/256KB, 256MB ECC, Open, 40X, PCI	1	-
37L7204	9.1GB 10K-4 Ultra2 SCSI Hot-Swap SL HDD	6 <sup>1</sup>	-
24P2396	100/200GB LTO Internal SCSI HH Tape Drive	1	-
10K2340	Media Bay Tray and LVD Cable Kit	1	-
37L6889	ServeRAID-4H Ultra160 SCSI Controller	1	RAID 5 array, with hot-spare
33L37xx	250W Hot-Swap Redundant Power Supply	1	Full power redundancy
T3147xx	E54 Color Monitor 15in (350-mm, 13.8in Viewable Image Size), stealth black <sup>6</sup>	1	-
SUP102Y	APC Smart-UPS 1000	1	-

1. Six HDDs are used for RAID 5 protection. One HDD is identified as a hot-spare. Effective storage capacity is four HDDs or 36.4GB

This tower model is configured to meet the need of server consolidation. Many businesses are trying to get their arms around the dispersed departmental servers that have grown up around the enterprise. By moving multiple servers onto one platform there is only one system to manage, both hardware and software. There is potentially less expense for service, software licenses, etc., and there is less concern about single points of failure because the xSeries 240 is designed for high availability. This configuration includes RAID-protected internal storage, a third power supply which provides fully redundant power, a UPS to help protect the system against a momentary power loss, and an internal tape drive that provides backup, to 200GB per tape...in addition to all the standard features of the xSeries 240.



# IBM xSeries 250

Part Number  
 Withdrawal Date: ddmmyy  
 Processor Speed<sup>2</sup>  
 Number of Processors (Std/Max)  
 L2 ECC Cache (KB)  
 Memory (Std/Max) (R = RDIMM)<sup>3</sup>  
 Form Factor  
 Power Supply Quantity (Std/Max)  
 Hot-Swap (Power, Slots, HDD, Fans)  
 Redundancy (Optional, Standard)  
 Adv System Management  
 Onboard Ethernet (Mbps)<sup>7</sup>  
 SCSI Controller (Dual, Ultra, RAID)  
 Removable Media Bays (Total/Avail)  
 Internal Hard Disk Drive (Std/Max)  
 CD-ROM (IDE)  
 Bays (Tot/Av)  
 Slots (Tot/Av)

xSeries 250 At-A-Glance Chart																	
K561Yxx	-	700MHz	1/4	1024	512MB(R)/16GB	Tower	2/4	P, S, H, F	S-Fans O-Power <sup>4</sup>	Y	10/100	D,U2	4/2	0/734GB <sup>6</sup>	48X-20 <sup>5</sup>	14/12	6/6
K56RYxx <sup>1</sup>	-	700MHz	1/4	1024	512MB(R)/16GB	Rack (8U)	2/4	P, S, H, F	S-Fans O-Power <sup>4</sup>	Y	10/100	D,U2	4/2	0/734GB <sup>6</sup>	48X-20 <sup>5</sup>	14/12	6/6
K571Yxx	-	700MHz	1/4	2048	512MB(R)/16GB	Tower	2/4	P, S, H, F	S-Fans O-Power <sup>4</sup>	Y	10/100	D,U2	4/2	0/734GB <sup>6</sup>	48X-20 <sup>5</sup>	14/12	6/6
K57RYxx <sup>1</sup>	-	700MHz	1/4	2048	512MB(R)/16GB	Rack (8U)	2/4	P, S, H, F	S-Fans O-Power <sup>4</sup>	Y	10/100	D,U2	4/2	0/734GB <sup>6</sup>	48X-20 <sup>5</sup>	14/12	6/6
K581Yxx	-	900MHz	1/4	2048	512MB(R)/16GB	Tower	2/4	P, S, H, F	S-Fans O-Power <sup>4</sup>	Y	10/100	D,U2	4/2	0/734GB <sup>6</sup>	48X-20 <sup>5</sup>	14/12	6/6
K58RYxx <sup>1</sup>	-	900MHz	1/4	2048	512MB(R)/16GB	Rack (8U)	2/4	P, S, H, F	S-Fans O-Power <sup>4</sup>	Y	10/100	D,U2	4/2	0/734GB <sup>6</sup>	48X-20 <sup>5</sup>	14/12	6/6

- Housed in a 19in rack-mountable drawer and ships standard without a keyboard or mouse. See Rack Cabinets and Options section for supported IBM racks.
- Intel Pentium III Xeon processor with advanced transfer (full speed) L2 cache and 100MHz access to memory and I/O buses.
- Advanced Chipkill ECC memory corrects two-, three-, and four-bit memory errors.
- An optional 250W Hot-Swap Redundant Power Supply P/N 33L37xx is required for redundancy. See xSeries 250 Power, Monitor & Accessories for additional information.
- Variable read rate. Actual playback speed will vary and is often less than the maximum possible.
- xSeries Ultra160 SCSI Repeater Card kit P/N 37L7086 includes a jumper cable and installation hardware. This option is used to convert the standard split backplane into a single SCSI channel supporting up to 10 HDDs. See Internal Cabling section for more information.

## xSeries 250 Processor Upgrades

Part Number	Processor Upgrades Description	SMP Support <sup>1</sup>	Processor Speed Upgrade <sup>2</sup>
10K2331	700MHz/1MB Upgrade II with Pentium III Xeon Processor	K561Yxx, K56RYxx	-
10K2332	700MHz/2MB Upgrade II with Pentium III Xeon Processor	K571Yxx, K57RYxx	K561Yxx, K56RYxx
19K4635	xSeries 250 900MHz/2MB Upgrade with Pentium III Xeon Processor	K581Yxx, K58RYxx	K561Yxx to K57RYxx

- Three additional processors may be installed, providing a maximum of four. All processors must be identical in type, speed, and cache size.
- Requires removal of the standard processor. A maximum of four processors may be installed. All processors must be identical in type, speed and cache size. Upgrades may require a BIOS update. To obtain the latest Flash BIOS, access [www.pc.ibm.com/support](http://www.pc.ibm.com/support) and enter machine "Type-Model" in Quick Path. Select "Downloadable files" and then "BIOS."



## xSeries 250 Memory Configurator

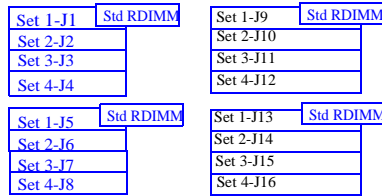

All RDIMMs installed in each set must be the same size, but all the sets do not have to contain RDIMMs of the same size. Install RDIMM sets in numerical sequence from one to four.

Total Memory <sup>1</sup>	Quantity of RDIMMs Added <sup>2</sup>				
	512MB (4 x 128 RDIMMs) standard	128MB P/N 33L3113	256MB P/N 33L3115	512MB P/N 33L3117 <sup>3</sup>	1GB P/N 33L3119
1GB		4	-	-	-
1.5GB		-	4	-	-
2GB		4 and	4	-	-
2.5GB		-	8	-	-
3GB		4 and	-	4	-
4GB		4 and	4 and	4	-
5GB		4 and	-	8	-
6GB <sup>4</sup>		-	8 and	8	-
7GB <sup>4</sup>		-	4 and	12	-
8GB <sup>4</sup>		-	-	16	-
9GB		4 and	-	-	8
10GB <sup>4</sup>		-	-	12 and	4
12GB <sup>4</sup>		-	-	8 and	8
14GB <sup>4</sup>		-	-	4 and	12
16GB <sup>4</sup> (max)		-	-	-	16

This table does not represent all possible memory configurations. Memory modules may vary in price per MB. Selection of smaller RDIMMs may provide a more cost-effective alternative to using larger RDIMMs.

1. Network operating systems may limit the maximum amount of addressable memory. See operating system specifications for further information.

2. To obtain the Quantity of memory identified in the "Total Memory" column, select the appropriate row and order the quantity of RDIMMs identified in all columns for that row. Example: For 2GB, order 4 x P/N 33L3113 plus 4 x P/N 33L3115.

3. The 2GB memory option P/N 33L3147, each of which includes four 512MB RDIMMs, can be substituted for a quantity of four 512MB P/N 33L3117 RDIMMs.

4. Requires removal of standard RDIMMs.

Part Number	Memory Description <sup>1</sup>
33L3113	128MB, 100MHz ECC SDRAM RDIMM
33L3115	256MB, 100MHz ECC SDRAM RDIMM
33L3117	512MB, 100MHz ECC SDRAM RDIMM <sup>2</sup>
33L3119	1GB 100MHz ECC SDRAM RDIMM
33L3147	2GB 100MHz ECC SDRAM RDIMM Kit (4 x 512MB) <sup>2</sup>

1. Due to four-way interleaving all RDIMMs installed in each set must be the same size, but all the sets do not have to contain RDIMMs of the same size. Memory must be installed in sets of four identical RDIMMs (example: quantity four of P/N 33L3113. Install RDIMM sets in numerical sequence from Set 1 to Set 4. Chipkill support is provided on the memory card.

2. Due to the new technology used by the 512MB RDIMMs contained in Kit P/N 33L3147, they should not be mixed within a set with the 512MB 100MHz ECC SDRAM RDIMM P/N 33L3117.

## xSeries 250 Internal SCSI Cabling

The xSeries 250 contains a hot-swap backplane architected into two backplanes, each containing five drives. This split backplane supports a total of 10 hot-swap SCA-2 compliant drives. One of the backplanes is connected to one of the internal connectors of the standard Ultra2 SCSI controller through a 16-bit LVDS cable. Another 16-bit LVDS cable is connected to the other backplane connector; however, this cable is left disconnected at the other end. The standard configuration allows support of five drives from the standard SCSI controller. If additional drive bays are required to be supported by the standard controller, an optional xSeries Ultra160 SCSI Repeater Card P/N 37L7086 must be installed to connect both backplanes into a single channel, 10-bay configuration. The repeater card is shipped with a jumper cable and installation hardware.

Channel A of the dual-channel, Wide Ultra2 SCSI controller only supports external SCSI attachment and is connected directly to an external 0.8mm VHDCI SCSI connector.

To support SCSI devices in the internal 5.25in half-high bays, a two-drop, 16-bit LVD, terminated SCSI cable is included and can be used to connect channel B of the integrated Wide Ultra2 SCSI controller to SCSI devices in one or both of the removable media bays when an optional RAID controller is used to support the internal hot-swap drive bays. If the standard SCSI controller is used to support the hot-swap drive bays, then an optional SCSI adapter is required to support installation of devices in these 5.25in half-high bays.

Most configurations for this class of server will generally incorporate an optional ServeRAID-4 Ultra160 SCSI controller to support internal RAID protection. The split backplane of the xSeries 250 is optimised to support a two-channel ServeRAID controller to enhance performance. Each backplane can be cabled to an internal connector of the RAID controller by removing the standard 16-bit LVDS cable from the Ultra2 SCSI controller and attaching it to one of the RAID controller connections. The other standard 16-bit LVDS cable is attached to the remaining internal connector of the RAID controller. In configurations where a single channel RAID array is required, an xSeries Ultra160 SCSI Repeater Card P/N 37L7086 must be installed.

**For additional information regarding internal cabling, refer to Appendix E: Internal Storage Cabling Overview.**



**xSeries 250 Internal Hard Disk Drive (HDD) and External Storage Configurator**

Total Int Storage <sup>1</sup>	10,000RPM Ultra160 <sup>2</sup> SCSI HDDs				15,000RPM Ultra160 <sup>2</sup> SCSI HDDs	
	9.1GB P/N37L7204	18.2GB P/N37L7205 or 06P5754	36.4GB P/N37L7206 or 06P5755	73.4GB P/N06P5756	18.2GB P/N19K0656 or 06P5767	36.4GB P/N 06P5768
0GB	0GB Standard on base models				0GB Standard on base models	
9.1GB	1	-	-	-	-	-
18.2GB	2 or	1	-	-	1	-
27.3GB	3	-	-	-	-	-
36.4GB	4 or	2 or	1	-	2 or	1
45.5GB	5	-	-	-	-	-
54.6GB	6 or	3	-	-	3	-
63.7GB	7	-	-	-	-	-
72.8GB	8 or	4 or	2	-	4 or	2
81.9GB	9	-	-	-	-	-
91.0GB	10 or	5	-	-	5	-
109.2GB	-	6 or	3	-	6 or	3
127.4GB	-	7	-	-	7	-
145.6GB	-	8 or	4	-	8 or	4
163.8GB	-	9	-	-	9	-
182.0GB	-	10 or	5	-	10 or	5
218.4GB	-	-	6	-	-	6
254.8GB	-	-	7	-	-	7
291.2GB	-	-	8	-	-	8
327.6GB	-	-	9	-	-	9
364.0GB	-	-	10	-	-	10
367.0GB	-	-	-	5	-	-
440.4GB	-	-	-	6	-	-
513.8GB	-	-	-	7	-	-
587.2GB	-	-	-	8	-	-
660.6GB	-	-	-	9	-	-
734.0GB (max)	-	-	-	10	-	-

This table does not represent all possible HDD configurations.

1. Select a total storage row then identify the recommended HDDs from within an RPM range according to choice. Total Internal Storage listed is within ± 0.2 GB unless otherwise noted.

2. xSeries 250 ships standard with an Ultra2 SCSI storage controller. The standard backplane supports Ultra160 HDDs at Ultra2 speeds (80Mbps) when connected to the standard integrated storage controller or at Ultra160 speeds (160Mbps) with the addition of an optional Ultra160 storage controller.



Bay	Form Factor	Height	Front Access	Usage	Part Number	Description	RPM	Height	Bays Supported	Max Qty
-	89mm (3.5in)	SL	Yes	Diskette	<b>Hot-Swap Ultra160 SCSI HDDs<sup>1</sup></b>					
-	133mm (5.25in)	HH	Yes	IDE CD-ROM	37L7204	9.1GB 10K-4 Ultra160 Hot-Swap HDD	10000	SL	See diagram	10 <sup>2</sup>
RM 1	133mm (5.25in)	HH <sup>1</sup>	Yes	Open	37L7205	18.2GB 10K-4 Ultra160 Hot-Swap HDD	10000	SL	See diagram	10 <sup>2</sup>
RM 2	133mm (5.25in)	HH <sup>1</sup>	Yes	Open	06P5754	18.2GB 10,000rpm Ultra160 Hot-Swap HDD	10000	SL	See diagram	10 <sup>2</sup>
1 ... 10	HS	SL	Yes	Open	37L7206	36.4GB 10K-4 Ultra160 Hot-Swap HDD	10000	SL	See diagram	10 <sup>2</sup>
NB3 <sup>2</sup>	19in Rack	3U	Yes	Open	06P5755	36.4GB 10,000rpm Ultra160 Hot-Swap HDD	10000	SL	See diagram	10 <sup>2</sup>
					06P5756	73.4GB 10,000rpm Ultra160 Hot-Swap HDD	10000	SL	See diagram	10 <sup>2</sup>
					06P5767	18.2GB 15,000rpm Ultra160 Hot-Swap HDD	15000	SL	See diagram	10 <sup>2</sup>
					19K0656	18.2GB 15,000rpm Ultra160 Hot-Swap HDD	15000	SL	See diagram	10 <sup>2</sup>
					06P5768	36.4GB 15,000rpm Ultra160 Hot-Swap HDD	15000	SL	See diagram	10 <sup>2</sup>
					<b>Associated Options</b>					
					37L7086	xSeries Ultra160 SCSI Repeater Card <sup>2</sup>	-	-	-	1
					<b>External Storage Expansion Units<sup>3</sup></b>				<b>Form Factor</b>	
					19K11xx <sup>9</sup>	EXP300 Storage Expansion Unit <sup>4, 8</sup>			Rack (3U)	
					09N7296	EXP300 Rack-to-Tower Conversion Kit <sup>4</sup>			-	
					19K11xx <sup>10</sup>	FAStT200 Storage Server <sup>5, 6, 8</sup>			Rack (3U)	
					19K11xx <sup>11</sup>	FAStT200 HA Storage Server <sup>5, 8</sup>			Rack (3U)	
					19K1121	FAStT200 Redundant RAID Controller <sup>6</sup>			-	
					00N71xx <sup>12</sup>	FAStT EXP500 Storage Expansion Unit <sup>7, 8</sup>			Rack (3U)	
					94G7448	Rack Power Cable Type C12 (3.7m, 12ft) <sup>8</sup>			-	

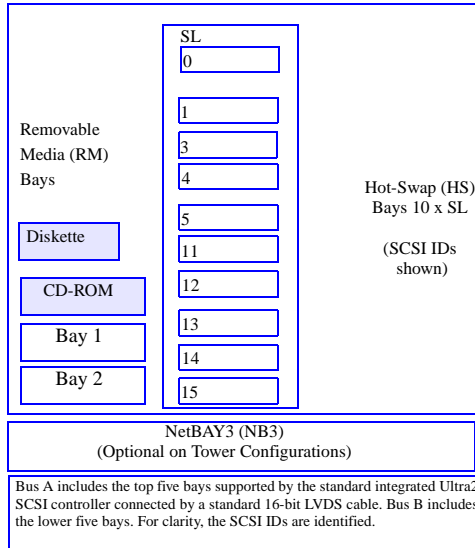

- xSeries 250 contains an Ultra2 hot-swap, split backplane which supports Ultra160 HDDs at Ultra2 bus speeds when connected to the standard integrated storage controller. Ultra160 bus speeds are supported with the addition of an optional Ultra160 storage controller.
- xSeries Ultra160 SCSI Repeater Card kit P/N 37L7086 includes a jumper cable and installation hardware. This option is used to convert the standard split backplane into a single SCSI channel supporting up to 10 HDDs. See Internal Cabling section for more information.
- Not supported by the onboard external SCSI port. To configure one of the SCSI storage devices listed here, select an optional SCSI controller then refer to Appendix D: Cables - Storage Units - Controllers to confirm the controller supports the desired External Storage Expansion Unit and to select a supported cable. For HDD or other expansion unit options, see the specific expansion unit section. For Fibre Channel storage devices, refer to the Fibre Channel Solutions Overview section.
- The EXP300 includes a single 2M Ultra2 SCSI cable and dual hot-swap 500W power supplies, each with its own standard country power cord. To convert an EXP300 to a tower form factor, EXP300 Rack-to-Tower Conversion Kit P/N 09N7296 is required.
- The FAStT200 and FAStT200 HA Storage Servers each include two hot-swap, 350W auto-ranging redundant power supplies, each with its own standard country power cord.
- Can be upgraded to FAStT200 HA Storage Server through the addition of a FAStT200 Redundant RAID Controller P/N 19K1121.
- The FAStT EXP500 Storage Expansion Unit includes dual hot-swap 350W power supplies, each with its own standard country power cord.
- These units do not include Rack Power Cables P/N 94G7448 when shipped (for attachment to high voltage UPS or PDU). Standard country power cords only are included. If required, order Rack Power Cables according to the number of power supplies.
- Where 'xx' represents a specific country code as follows: 51=US/English, 52=European/English, 56=Danish/English, 57=Israel/English, 58=Italian/English, 59=South Africa/English, 60=Swiss/English, 63=UK/English:- Line Cords/ Publication Country Kits are included as indicated.
- Where 'xx' represents a specific country as follows:- 23=US/English, 24=Euro/English, 25=Euro/Spanish, 27=Euro/German, 28=Denmark/English, 29=Israel/English, 30=Italy/English, 31=South Africa/English, 32=Switzerland/English, 34=Switzerland/German, 36=UK/English. Country/Language - Line Cords/Publications are included as indicated
- Where 'xx' represents a specific country code as follows:- 37=US/English, 38=Euro/English, 39=Euro/Spanish, 41=Euro/German, 42=Denmark/English, 43=Israel/English, 44=Italy/English, 45=South Africa/English, 46=Switzerland/English, 48=Switzerland/German, 50=UK/English. Country/Language - Line Cords/Publications are included as indicated.
- Where 'xx' represents a specific country code as follows:- 36=US/English, 37=Euro/English, 41=Denmark/English, 42=Israel/English, 43=Italy/English, 44=South Africa/English, 45=Switzerland/English, 49=UK/English. Country/Language Line Cords/Publications are included as indicated.

### xSeries 250 I/O Options

Part Number	Description	Adapter Length	PCI Support <sup>1</sup>	Slots Supported <sup>1</sup>	Hot-Plug <sup>2</sup>	PCI Voltage Key	MHz
<b>SCSI Storage Controllers<sup>3</sup></b>							
37L6889	ServeRAID-4H Ultra160 SCSI Controller <sup>4</sup>	Full	64-bit	1 ... 6	X	Universal	33
06P5736	ServeRAID-4Mx Ultra160 SCSI Controller <sup>5</sup>	Full	64-bit	1 ... 6	X	Universal	66
06P5740	ServeRAID-4Lx Ultra160 SCSI Controller <sup>6</sup>	Half	64-bit	1 ... 6	X	Universal	66
19K4646	PCI Wide Ultra160 SCSI Adapter <sup>7</sup>	Half	32-bit	1 ... 6	-	Universal	66
02K3454	PCI Fast/Wide Ultra SCSI Adapter <sup>8</sup>	Half	32-bit	3 ... 6	-	5	33
<b>Fibre Storage Controller<sup>9</sup></b>							
00N6881	FASiT Host Adapter	Half	64-bit	1 ... 6	X	Universal	66
19K1246	FASiT FC-2 Host Bus Adapter	Half	64-bit	1 ... 6	X	Universal	66
<b>Networking<sup>10</sup></b>							
<b>Ethernet<sup>11</sup></b>							
09N9901	10/100 EtherLink Server Adapter by 3Com <sup>12</sup>	Half	32-bit	1 ... 6	X	Universal	33
06P3601	10/100 Ethernet Server Adapter <sup>12</sup>	Half	32-bit	1 ... 6	X	Universal	33
06P3701	Gigabit Ethernet SX Server Adapter (fibre optic cabling interface)	Half	64-bit	1 ... 6	X	Universal	66
22P4901	10/100 Dual Port Ethernet Server Adapter <sup>12</sup>	Half	64-bit	1 ... 6	X	Universal	66
<b>Token Ring</b>							
34L0701	Token-Ring 16/4 PCI Adapter 2 with Wake on LAN <sup>12</sup>	Half	32-bit	1 ... 6	X	Universal	33
34L5001	16/4 Token-Ring PCI Management Adapter <sup>12</sup>	Half	32-bit	1 ... 6	X	Universal	33
34L5201	High-Speed 100/16/4 Token-Ring PCI Management Adapter <sup>12</sup>	Half	32-bit	1 ... 6	X	Universal	33
<b>Communications<sup>13</sup></b>							
37L14xx	Serial I/O SST 8, 16, and 128 port adapters <sup>14</sup>	Half	32-bit	3 ... 6 <sup>14</sup>	-	5	33
<b>Systems Management<sup>15</sup></b>							
36L96xx <sup>18</sup>	Advanced System Management PCI Adapter <sup>16, 17</sup>	Full	32-bit	3 ... 6 <sup>17</sup>	-	5	33

1. The 5V slots support Universal or 5V adapters. The 3.3V slots support universal or 3.3V adapters. A 66MHz adapter plugged into a 33MHz slot will operate at 33MHz. A 33MHz adapter plugged into a 66MHz slot limits other adapters installed on the same bus to 33MHz. A 64-bit adapter installed into a 32-bit slot will transfer data at 32-bit rates. 133MHz PCI-X adapters are backward compatible with 33/66MHz, 64-bit PCI-based servers.
2. Slots three through six include hot-plug capability using IBM's Active PCI technology. For Network Operating System support access [www.ibm.com/pc/us/compat](http://www.ibm.com/pc/us/compat).
3. All models include a dual-port, dual-channel, 64-bit Wide Ultra2 SCSI controller with one internal connector (connected to Channel A of the hot-swap split backplane) and one external port with a 0.8mm Very High Density Connection Interface (VHDCI).
4. ServeRAID-4H Ultra160 SCSI Controller is powered by a 266MHz PowerPC 750 processor and provides four channels, 128MB of battery-backed ECC cache with two internal and up to four external Ultra160 connectors (a combination of four connectors may be utilised). External connectors are 0.8mm VHDCI.
5. ServeRAID-4Mx Ultra160 SCSI Controller is powered by a 100MHz Intel Zion GC80303 processor that provides 64MB of battery-backed ECC cache and two internal and two external Ultra160 connections (only two connectors may be used). External connections are 0.8mm VHDCI.
6. ServeRAID-4Lx Ultra160 SCSI Controller is powered by a 100MHz Intel Zion GC80303 processor and provides a single channel, 32MB of ECC cache and either one internal or one external Ultra160 connection. External connector is 0.8mm VHDCI.
7. PCI Wide Ultra160 SCSI Adapter (P/N 19K4646) provides a single channel with one internal connector and a five-drop multi-mode terminated LVD SCSI cable and one external 0.8mm VHDCI connector. Only one of the two connectors may be utilised.
8. PCI Fast/Wide Ultra SCSI Adapter P/N 02K3454 provides one external 68-pin high density connector that supports external SCSI devices such as tape enclosures.
9. See Fibre Array Solutions section for additional configuration information.
10. xSeries 250 includes a full-duplex, 10/100Mbps Ethernet PCI Controller.
11. In a fault-tolerant networking environment, using the fault-tolerant software delivered with the Ethernet adapters of a single manufacturer is recommended. Installing fault-tolerant solutions provided by multiple manufacturers may cause failures if the intermediate drivers provided with the adapters are not compatible. The onboard Ethernet is AMD-based. The optional PCI Ethernet adapters listed here are Intel-based - P/Ns 06P3601, 06P3701, 22P4901.
12. The Wake-on LAN function of this option is not supported by this server.
13. xSeries 250 includes two USB ports, two high-speed serial/asynchronous ports (NS16550A compatible), and one high-speed (up to 2MB/sec data transfer speed) bidirectional parallel port supporting devices using ECP/EPP/SSP protocols adhering to the IEEE 1284 standard.
14. See Appendix F for details on Serial I/O Options and configuration limitations. A maximum of four Serial I/O adapters (in any combination) may be installed.
15. The Advanced Systems Management Processor and Interconnect Bus integrated into xSeries 250 works with Netfinity Director to provide significant system management function. When used with optional Advanced System Management PCI Adapter P/N 36L96xx or connected directly into an interconnect network using the integrated RS-485 ports located on the rear of the system chassis. Additional management and control of up to 12 service processors from a remote console through a single modem or LAN connection is possible.
16. Includes PCI adapter, Advanced System Management Interconnect Cable Kit components and 56W AC adapter which requires a separate power source. Provides an integrated 10/100 Ethernet port.
17. A maximum quantity of one is supported.
18. Where 'xx' represents a specific country code as follows:- 57=Denmark, 58=South Africa/India, 59=UK, 60=Switzerland, 61=Italy, 62=Israel, 01K7310=Europe, 01K7209=US/Saudi Arabia.

Slot 1- Bus A- 66MHz- 3.3V or Universal	All Slots- Full Length, 64-bit
Slot 2- Bus A- 66MHz- 3.3V or Universal	
Slot 3- Bus B- 33MHz- 5V or Universal, Active PCI	
Slot 4- Bus B- 33MHz- 5V or Universal, Active PCI	
Slot 5- Bus B- 33MHz- 5V or Universal, Active PCI	
Slot 6- Bus B- 33MHz- 5V or Universal, Active PCI	



**xSeries 250 Power, Monitors, Accessories**

Part Number	Description
<b>Power<sup>1,9</sup></b>	
33L37xx <sup>10</sup>	250W Hot-Swap Redundant Power Supply <sup>9</sup>
94G7448	Rack Power Cable Type C12 (3.7m, 12 ft.) <sup>9</sup>
<b>Free Standing Uninterruptible Power Supply (UPS)<sup>2</sup></b>	
SUP102Y	APC Smart-UPS 1000
SUP142Y	APC Smart-UPS 1400
<b>Rack Mount Uninterruptible Power Supply (UPS)<sup>2</sup></b>	
14RIxxx <sup>11</sup>	APC Smart-UPS 1400RMiB <sup>3</sup>
30RIxxx <sup>11</sup>	APC Smart-UPS 3000RMiB <sup>3</sup>
37L6862	APC Smart-UPS 5000RMiB <sup>4</sup>
<b>Monitors<sup>5</sup></b>	
T3147xx <sup>12</sup>	E54 Color Monitor 15in (350mm, 13.8in Viewable Image Size), stealth black <sup>6</sup>
T3247xx <sup>12</sup>	E74 Color Monitor 17in (403mm, 15.9in Viewable Image Size), stealth black <sup>6</sup>
T274Axx <sup>12</sup>	G78 Color Monitor 17in (406.4mm, 16in Viewable Image Size), stealth black <sup>6</sup>
T11AGxx <sup>12</sup>	T540 Flat Panel Color Monitor 15in (381mm, 15in viewable image), stealth black <sup>7</sup>

1. xSeries 250 includes two 250W hot-swap redundant power supplies, with the ability to accept up to two additional 250W Hot-Swap Redundant Power Supplies P/N 33L37xx. To assist in determining when an additional power supply is required to preserve redundancy, a "Non-Redundant LED" is a standard feature of the xSeries 250. Predicting whether or not a particular configuration will require an additional power supply for redundancy is very complex. However, once the system is installed, the "Non-Redundant LED" will indicate when an additional power supply is required. The following sample configuration is provided as a reference.

Number of Power Supplies	System Configuration Supported
<b>Typical Non-Redundant Configuration</b>	
2	2 x Processors
	3 x PCI Adapters
	5 x Slim-Line HDDs
	8 x 512MB RDIMMs
<b>Typical Redundant Configuration</b>	
3 <sup>8</sup>	4 x Processors
	6 x PCI Adapters
	10 Slim-Line HDDs
	16 x 512MB RDIMMs
4	<b>Full Configuration with Redundancy</b>

2. For runtimes and UPS attributes see Appendix C: UPS Runtime Estimate.
3. Height is 3U. See Rack Cabinets and Options section for supported IBM racks.
4. Height is 5U. See Rack Cabinets and Options section for supported IBM racks.
5. xSeries 250 uses an SVGA controller (S3 Trio 3D chipset) with 4MB of video memory.
6. Installation within a rack requires optional Monitor Compartment (P/N 94G7444).
7. Installation within a rack requires optional Flat Panel Monitor Rack Mount Kit II P/N 37L6888 and Rack Keyboard Tray P/N 28L4707. A space saver keyboard may coexist within the same keyboard tray. See Rack Cabinets and Options section for more information.
8. The addition of a DLT tape drive may require a fourth power supply to preserve redundancy.
9. Rack Power Cable P/N 94G7448 (one for each Power Supply), must be ordered for power connection to a high voltage UPS or PDU.
10. Where 'xx' represents a specific country code as follows:- 60= Saudi Arabia, 61=Europe, 62=Denmark, 63=Israel, 64=Italy, 65=South Africa, 66=Switzerland, 67=United Kingdom&Arabia.
11. Where 'xxx' represents a specific country code as follows:- DEN=Denmark, ISR=Israel, ITA=Italy, SDI= Saudi Arabia, SAF=South Africa, SWS=Switzerland, UKM=United Kingdom, EUR=Europe.
12. Where 'xx' represents a specific country code as follows:- DK=Denmark, IS=Israel, IT=Italy, SD= Saudi Arabia, SA=South Africa, CH=Switzerland, UK=UK, EU=Europe.





Part Number	Description
<b>Conversion Kits</b>	
37L6860	8Ux24D Rack-to-Tower Kit <sup>1</sup>
37L6859	8Ux24D Tower-to-Rack Kit <sup>7</sup>
<b>Rack and NetBAY<sup>2,7</sup></b>	
94G7448	Rack Power Cable Type C12 (3.7m) <sup>7</sup>
<b>NOTE:</b> Refer to the Rack Cabinets and Options section for details of IBM Racks and rack-supported devices.	
<b>Keyboard and Mouse<sup>3</sup></b>	
28L36xx <sup>8</sup>	Space Saver II Keyboard <sup>4, 6</sup>
28L36xx <sup>9</sup>	Preferred Keyboard (stealth black) <sup>5</sup>
28L3675	Sleek 2-Button Stealth Black Mouse

1. Includes one NetBAY3 with casters.

2. xSeries 250 rack models are housed in a 19in rack mountable drawer and require one of the racks listed in the Rack Cabinets and Options section.

3. xSeries 250 rack models ship without a keyboard or mouse.

4. Installation within a rack requires optional keyboard tray P/N 28L4707 (stows in ready-to-use position).

5. Installation within a rack requires optional keyboard tray P/N 28L4707. This keyboard cannot share a keyboard tray with a flat panel display.

6. Advanced TrackPoint IV features are not available on IBM xSeries systems.

7. The xSeries 250 ships with a standard country power cord. For connection of a Rack model to a high voltage UPS or PDU, or if a Tower model is being converted for rack installation and is to be connected to a UPS or PDU, a Rack Power Cable P/N 94G7448 (one for each power supply), must be ordered.

8. Where 'xx' represents a specific country code as follows:- 46=Danish, 47=France, 48=Germany, 49=Italian, 50=Spanish, 51=UK English, 44=US English, and P/N 19K3831=Switzerland, 19K3832=Sweden/Finland, 19K3833=Portugal, 19K3834=Belgium, 19K3836=Russia, 19K3837=Poland.

9. Where 'xx' represents a specific country code as follows:- 25=French, 26=German, 27=Italian, 29=UK English, 31=Danish, 33=Norwegian, 34=Swedish/Finnish, 35=Swiss, 36=Dutch, 21=US English, and P/N 22P7325=Belgium/UK, 22P7323=Icelandic.



### xSeries 250 Tape Options

Part Number	Tape Drives	Bays Supported	SCSI Interface (bit)	Form Factor	Termination Included	68/50-pin Converter Incl	Ext Tape Enclosures
00N7991	20/40GB DDS/4 4mm Internal SCSI Tape Drive	1, 2	16 Ultra2 LVD	89mm (3.5in) HH or 133mm (5.25in) HH	N	-	10L7440 <sup>2</sup> , 03K8756 <sup>1</sup>
00N7990	40/80GB DLT Internal SCSI Tape Drive	1+2	16 Ultra2 LVD	133mm (5.25in) FH	N	-	03K8756 <sup>1</sup>
00N8015	110/220GB Super DLT Internal SCSI Tape Drive	1+2	16 Ultra2 LVD	133mm (5.25in) FH	N	-	03K8756 <sup>1</sup>
09N4040	20/40GB DLT Internal SCSI Tape Drive	1+2	8	133mm (5.25in) FH	N	Y	03K8756
00N8016	100/200GB LTO Internal SCSI Tape Drive	1+2	16 Ultra2 LVD	133mm (5.25in) FH	N	-	03K8756 <sup>1</sup>
24P2396	100/200GB LTO Internal SCSI HH Tape Drive	1, 2	16 Ultra2 LVD	133mm (5.25in) HH	N	-	03K8756 <sup>1</sup>
24P2398	40/80GB Half-High DLT/VS Internal SCSI Tape Drive	1, 2	16 Ultra2 LVD	133mm (5.25in) HH	N	-	03K8756 <sup>1</sup>
<b>Tape Autoloaders</b>							
00N79xx <sup>10</sup>	DLT SCSI Tape Autoloader	-	16	Desktop	Y	-	-
00N7992	120/240GB DDS/4 Internal SCSI Tape Autoloader	1+2	16 Ultra2 LVD	133mm (5.25in) FH	N	-	03K8756 <sup>1</sup>
09N40xx <sup>11</sup>	3600 Series 900GB/1.8TB LTO SCSI Tape Autoloader <sup>3</sup>	-	16 Ultra2 LVD	Tower or 6U Rack	Y	-	-
<b>External Tape Libraries<sup>4</sup></b>							
00N79xx <sup>12</sup>	DLT SCSI Tape Library	-	16	Desktop or Rack	Y	-	-
21P99xx <sup>13</sup>	3600 Series 2/4TB LTO SCSI Tape Library (Tower)	-	16 Ultra2 LVD	Tower	Y	-	-
21P99xx <sup>13</sup>	3600 Series 2/4TB LTO SCSI Tape Library (Rack)	-	16 Ultra2 LVD	5U Rack	Y	-	-
21P99xx <sup>14</sup>	3600 Series 2-Drive, 20-Cartridge Expander Module <sup>5</sup>	-	16 Ultra2 LVD	5U Rack	Y	-	-
09N4048	3600 Series LTO Drive Upgrade Option <sup>6</sup>	-	16 Ultra2 LVD	-	N	-	-
<b>External Tape Enclosures</b>							
10L7440	External Half High SCSI Storage Enclosure <sup>7</sup>	-	8, 16	Desktop	N	N	-
03K8756	NetMEDIA Storage Expansion Unit EL <sup>8</sup>	-	16	Rack	Y	N	-
10L7113	NetMEDIA Systems Management Adapter <sup>9</sup>	-	16 LVD	-	N	N	03K8756
<b>Associated Options</b>							
00N7956	68-pin External Multimode LVD/SE SCSI Terminator	-	16 LVD/SE	Ext	Y	N	10L7440
10K2340	Media Bay/Tray and LVD Cable Kit <sup>1</sup>	-	16 LVD	Int	Y	N	03K8756

Note: xSeries 250 includes a two-drop multimode terminated LVD SCSI cable, for attaching an internal tape drive to the standard controller if internal RAID is being used, or to an optional adapter in a non-RAID system. See the Internal Cabling section for more information.

- LVD support for LVD devices installed in a NetMEDIA Storage Expansion Unit EL P/N 03K8756 requires replacement of the standard single-ended internal cables with one or more (depending on configuration) cables from Media Bay Tray and LVD Cable Kit P/N 10K2340 which contains a single two-drop multi-mode terminated LVD-SCSI cable. If the standard cables are used for attachment to LVD devices, single-ended SCSI rules and bus speeds apply.
- Requires 68-pin External Multimode LVD/SE SCSI terminator P/N 00N7956.
- If installed in a rack, a fixed shelf is required. Allow an additional 1U for the fixed shelf. One unit only per shelf is supported.
- Tape library attributes and prerequisites are located in Appendix B: Tape Library Attributes.
- Supported only with the 3600 Series LTO Tape Library (Rack) (P/N 21P99xx). Allow one additional EIA space when installing either one or two (maximum) units to accommodate a filler plate for cable routing. Up to two 3600 Series LTO Drive Upgrade Options can be installed in each module or the module can operate off the LTO drives installed in the LTO tape library.
- Install in second drive bay of 3600 Series LTO Tape Libraries or in either of the two bays of 3600 Series 2-drive, 20-cartridge Expander Module to increase performance. Includes an LTO (Ultraium) drive and a one-meter external LVD SCSI cable.
- Provides a black desktop 133mm (5.25in) half-high (HH) tape enclosure. Connector is configurable as 50-pin Centronix or 68-pin high density. Requires either tape drive self-termination or 68-pin External Multimode LVD/SE SCSI Terminator (P/N 00N7956).
- NetMEDIA Storage Expansion Unit EL P/N 03K8756 is a black 3U, 19in rack or NetBAY3/3E mountable tape enclosure which includes two full-high (FH) or four half-high (HH) extended length 133mm (5.25in) bays, two external 0.8mm VHDCI connectors and two internal four-drop single-ended terminated 16-bit SCSI cables for device attachment. Two power supplies and two power cords are also included. Tip: The front rail clips will need to be reversed and screwed in from behind to secure the unit in a Rack Cabinet P/N 930842P or 930842X.
- NetMEDIA Systems Management Adapter P/N 10L7113 may be installed in a NetMEDIA Storage Expansion Unit to provide repeater function, LVDS interface, aggregate cable lengths up to 12 meters when attached to an LVD SCSI controller, and auto-termination when the Expansion Unit is powered off. External connector is 0.8mm VHDCI.
- Where 'xx' represents a country specific power cord code: 70=UK, 71=Swiss, 72=Italy, 73=Israel, 33L4981=EU1, 33L4982=Denmark, 33L4983=South Africa/India.
- Where 'xx' represents a specific country code as follows:- 49=UK, 50=Europe, 51=Denmark, 52=South Africa, 53=Switzerland, 54=Italy, 55=Israel.
- Where 'xx' represents a country specific power cord code: *Tower versions* - 74=EU1, 75=Denmark, 76=India/South Africa, 77=UK, 78=Swiss, 79=Italy, 80=Israel; *Rack versions* - 81=EU1, 82=Denmark, 83=India/South Africa, 84=UK, 85=Swiss, 86=Italy, 87=Israel.
- Where 'xx' represents a specific country code as follows:- *Tower version* - 71=Europe, 72=Denmark, 73=South Africa, 70=UK, 74=Swiss, 75=Italy, 76=Israel; *Rack version* - 78=Europe, 79=Denmark, 80=South Africa, 77=UK, 81=Swiss, 82=Italy, 83=Israel.
- Where 'xx' represents a specific country code as follows:- 85=Europe, 86=Denmark, 87=South Africa, 84=UK, 88=Swiss, 89=Italy, 90=Israel.

Note: Additional tape attributes can be found in Appendix A: Tape Drive Attributes.

Note: For a complete list of all IBM and non-IBM options compatibility with Network Operating Systems and IBM xSeries Servers, access the IBM ServerProven compatibility pages on the Web at URL <http://www.ibm.com/pc/us/compat>



## xSeries 250 Sample Configurations

Note: The following sample configurations are for illustration only and may not be suitable for any specific customer installation. Contact your IBM Business Partner or IBM Marketing Representative for assistance with your specific configuration requirements.

### High Availability Application Server

Part Number	Description	Quantity	Usage
K57RYxx	xSeries 250 Pentium III Xeon 700/2MB, 512MB(R) ECC, OPEN, 40X, PCI (Rack 8U)	1	-
33L3113	128MB, 100MHz ECC SDRAM RDIMM	4	-
33L3115	256MB, 100MHz ECC SDRAM RDIMM	4	-
33L3117	512MB, 100MHz ECC SDRAM RDIMM	4	4GB Total System Memory
10K2332	700MHz/2MB Upgrade II with Pentium III Xeon Processor	3	Total of 4 SMP processors
06P5736	ServeRAID-4Mx Ultra160 SCSI Controller	1	Optional RAID adapter
37L7204	9.1GB 10K-4 Ultra160 SCSI Hot-Swap SL HDD	2	9.1GB mirrored for NOS
37L7205	18.2GB 10K-4 Ultra160 SCSI Hot-Swap SL HDD	6 <sup>1</sup>	72GB RAID 5 with Hot-Spare
00N7990	40/80GB DLT Internal SCSI Tape Drive	1	-
33L37xx	250W Hot-Swap Redundant Power Supply	2	Full Power Redundancy
T274Axx	G78 Color Monitor 17in (406.4mm, 16in Viewable Image Size), stealth black	1	-
28L36xx	Space Saver II Keyboard	1	-
14RIxxx	APC Smart-UPS 1400RMiB	1	-
<b>External Storage</b>			
19K11xx	EXP300 Storage Expansion Unit	1	Includes 2M Ultra2 cable
37L7206	36.4GB 10K-4 Wide Ultra160 SCSI Hot-Swap SL HDD	14	RAID 5 Data Storage with Hot-Spare
<b>Rack</b>			
9306250	NetBAY25	1	-
09N4290	NetBAY 1x4 Console Switch	1	-
94G7448	Rack Power Cable Type C12 (3.7m, 12ft)	6	-
94G7447	NetBAY Console Cable Set-12ft	1	-
94G6670	Blank Filler Panel Kit	1	-

1. Six Internal HDDs are used for RAID 5 protection. One HDD is identified as a hot-spare. Effective capacity is four HDDs or 72.8GB

This rack server is configured to act as the foundation for business critical applications, applications your business cannot afford to be without. Configured with enough HDDs to mirror the operating system and provide a standard RAID 5 environment for data, optional hot-swap redundant power and UPS for power even during a blackout, this server represents the leading edge in high availability. An internal tape drive is included to back up that all important asset--data. A modem could be included to allow out-of-band (non-LAN) system management utilising the integrated Advanced System Management Processor.

### Server Consolidation

Part Number	Description	Quantity	Usage
K56RYxx	xSeries 250 Pentium III Xeon 700/1MB, 512MB(R) ECC, OPEN, 40X, PCI (Rack 8U)	1	-
33L3113	128MB, 100MHz ECC SDRAM RDIMM	4	1GB Total System Memory
10K2331	700MHz/1MB Upgrade II with Pentium III Xeon Processor	1	Total of 2 SMP processors
06P5736	ServeRAID-4Mx Ultra160 SCSI Controller	1	Optional RAID adapter
37L7204	9.1GB 10K-4 Ultra160 SCSI Hot-Swap SL HDD	2	9.1GB mirrored for NOS
37L7205	18.2GB 10K-4 Ultra160 SCSI Hot-Swap SL HDD	8 <sup>1</sup>	109GB RAID 5 with Hot-Spare
06P3601	10/100 Ethernet Server Adapter	3	Total of 4 Ethernet connections
00N7990	40/80GB DLT Internal SCSI Tape Drive	1	-
T274Axx	G78 Color Monitor 17in (406.4mm, 16in Viewable Image Size), stealth black	1	-
28L36xx	Space Saver II Keyboard	1	-
14RIxxx	APC Smart-UPS 1400RMiB	1	-
<b>Rack</b>			
9306250	NetBAY25	1	-
09N4290	NetBAY 1x4 Console Switch	1	-
94G7448	Rack Power Cable Type C12 (3.7m, 12ft)	3	-
94G7447	NetBAY Console Cable Set 12ft	1	-
94G6670	Blank Filler Panel Kit	2	-

1. Eight HDDs are used for RAID 5 protection. One HDD is identified as a hot-spare. Effective capacity is six HDDs or 109.2GB

This rack server is configured to meet the need of server consolidation. Many businesses are trying to achieve better control of the dispersed departmental servers that have grown up around the enterprise. By moving multiple servers on to one platform, there is only one system to manage both hardware and software. There is potentially less expense for service, software licenses, etc., and there is less concern about single points of failure because the xSeries 250 is designed for high availability. This configuration includes 109GB of internal HDD storage, features three power supplies which provide fully redundant power, a UPS to help protect the system against a momentary power loss, and an internal tape drive that backs up as much as 80GB per tape--in addition to all the standard features of the xSeries 250.



### High Availability File and Print Server

Part Number	Description	Quantity	Usage
K561Yxx	xSeries 250 Pentium III Xeon 700/1MB, 512MB(R) ECC, OPEN, 40X, PCI (Tower)	1	-
33L3113	128MB, 100MHz ECC SDRAM RDIMM	4	1GB Total System Memory
10K2331	700MHz/1MB Upgrade II with Pentium III Xeon Processor	1	Total of 2 SMP processors
06P5736	ServeRAID-4Mx Ultra160 SCSI Controller	1	Optional RAID adapter
37L7086	xSeries Ultra160 SCSI Repeater Card	1	Create single SCSI bus from split backplane
37L7204	9.1GB 10K-4 Ultra160 SCSI Hot-Swap SL HDD	2	9.1GB mirrored for NOS
37L7205	18.2GB 10K-4 Ultra160 SCSI Hot-Swap SL HDD	8 <sup>1</sup>	109GB RAID 5 with Hot-Spare
06P3601	10/100 Ethernet Server Adapter	3	Total of 4 Ethernet connections
00N7990	40/80GB DLT Internal SCSI Tape Drive	1	-
T274Axx	G78 Color Monitor 17in (406.4mm, 16in Viewable Image Size), stealth black	1	-
SUP142Y	APC Smart-UPS 1400	1	-

1. Eight HDDs are used for RAID 5 protection. One HDD is identified as a hot-spare. Effective capacity is six HDDs or 109.2GB.

This file and print server is designed to handle a high workload with significant storage and availability requirements. With this in mind, the IBM xSeries 250 was selected to provide an affordable price point for a high end file and print server with optional four-way Pentium III Xeon processing, 1GB of system memory (expandable to 16GB), and availability such as battery-backed cache RAID-protected internal hot-swap storage and power protection with an APC Smart-UPS.



# IBM xSeries 300

Part Number      Withdrawal Date: ddmmyy  
 Processor Speed      Number of Processors (Std/Max)  
 L2 ECC Cache (KB)      Memory (Std/Max) (R = RDIMM)  
 Form Factor      Power Supply Quantity (Std/Max)  
 Hot-Swap (Power, Slots, HDD, Fans)  
 Adv System Management Processor  
 Onboard Ethernet (Mbps)  
 SCSI Controller (Dual, Ultra, RAID)  
 Removable Media Bays (Total/Avail)  
 Internal Hard Disk Drive (Std/Max)  
 CD-ROM (IDE)<sup>4</sup>  
 Bays (Tot/Av)  
 Slots (Tot/Av)

xSeries 300 At-A-Glance Chart																
K222Xxx <sup>1</sup>	-	800MHz <sup>2</sup>	1/1	128	128MB/1.5GB	Rack (1U)	1/1	-	N	2x10/100	IDE	-	20.4GB/120.0GB	24X-10X	4/1	2/2
K223Xxx <sup>1</sup>	-	800MHz <sup>2</sup>	1/1	128	128MB/1.5GB	Rack (1U)	1/1	-	N	2x10/100	U160	-	18.2GB/72.8GB	24X-10X	4/1	2/1
K22AXxx <sup>1,5</sup>	-	800MHz <sup>2</sup>	1/1	128	128MB/1.5GB	Rack (1U)	DC	-	N	2x10/100	IDE	-	20.4GB/120.0GB	24X-10X	4/1	2/2
K282Xxx <sup>1</sup>	-	1GHz <sup>3</sup>	1/1	256	256MB/1.5GB	Rack (1U)	1/1	-	N	2x10/100	IDE	-	20.4GB/120.0GB	24X-10X	4/1	2/2
K283Xxx <sup>1</sup>	-	1GHz <sup>3</sup>	1/1	256	256MB/1.5GB	Rack (1U)	1/1	-	N	2x10/100	U160	-	18.2GB/72.8GB	24X-10X	4/1	2/1

1. Housed in a 19in rack-mountable drawer and ships standard without a keyboard or mouse. See Rack Cabinets and Options section for supported IBM racks.
2. Intel Celeron processor with 100MHz FSB. xSeries 300 does not support processor upgrades.
3. Intel Pentium III processor with advanced transfer L2 cache and 133MHz FSB. xSeries 300 does not support processor upgrades.
4. Variable read rate. Actual playback speed will vary and is often less than the maximum possible.
5. This direct current (DC) power model includes a 200W, 48V direct current power supply requiring a direct current power source for utilisation in a telecommunications network infrastructure.

## xSeries 300 Processor Upgrades

Part Number	Processor Upgrades Description
N/A	xSeries 300 does not support processor upgrades

## xSeries 300 Memory Configurator

Part Number	Memory Description	Total System Memory (Standard Models) <sup>1</sup>		DIMMs		
		128MB (1 x 128)	256MB (1 x 256)	128MB P/N 33L3081	256MB P/N 33L3083	512MB P/N 33L3085
		256MB	384MB	1	-	-
		384MB	512MB	2	-	-
		512MB	640MB	1	1	-
		640MB	768MB	-	2	-
		896MB	1024MB	-	1	1
		1152MB	1280MB	-	-	2
		1536MB (max) <sup>2</sup>	1536MB (max) <sup>2</sup>	-	-	3

This table does not represent all possible memory configurations. Memory modules may vary in price per MB. Selection of smaller DIMMs may provide a more cost-effective alternative to using larger DIMMs. Select the desired total memory from the appropriate column (Standard 128MB or 256MB models), then add the quantities in that row from the DIMM columns.

1. Network operating systems may limit the maximum amount of addressable memory. See operating system specifications for further information.
2. Requires removal of standard DIMMs.



## xSeries 300 Internal SCSI Cabling

### EIDE Configuration Cabling

The xSeries 300 contains two integrated ATA-100 EIDE controllers. One controller is cabled directly to the 24x-10x IDE CD-ROM. xSeries 300 models that ship with a standard EIDE HDD use the second EIDE controller to attach the standard HDD. This controller supports up to two EIDE HDDs through the use of a two-drop cable.

### SCSI Configuration Cabling

xSeries 300 SCSI models contain a single channel, Ultra160 SCSI adapter. A two-drop, terminated 16-bit LVD SCSI cable is attached to the internal connector of this adapter to support the standard Ultra160 HDD. The second drop can be used to attach a second SCSI HDD. In configurations where external SCSI device attachment is required, a supported SCSI adapter or ServeRAID controller must be installed.

**For additional information regarding internal cabling, refer to Appendix E: Internal Storage Cabling Overview.**

## xSeries 300 Internal Hard Disk Drive (HDD) and External Storage Configurator

Total Internal Storage <sup>1</sup>	SCSI Models				
	10,000RPM SCSI HDDs			15,000RPM SCSI HDD	
	9.1GB P/N 00N8207	18.2GB P/N 00N8208 or 06P5750	36.4GB P/N 00N8209 or 06P5751	18.2GB P/N 19K0658 or 06P5765	36.4GB P/N 06P5766
18.2GB	18.2GB (10,000rpm) Standard on SCSI models			18.2GB (10,000rpm) Standard on SCSI models	
27.3GB	1	-	-	-	-
36.4GB	-	1	-	1	-
54.6GB	-	-	1	-	1
72.8GB (max) <sup>2</sup>	-	-	2 <sup>2</sup>	-	2 <sup>2</sup>

This table does not represent all possible HDD configurations.

1. Select a total storage row then identify the recommended HDDs from within an RPM range according to choice. Total Internal Storage listed is within ± 0.2 GB unless otherwise noted.

2. Maximum capacity assumes replacement of standard hard disk drive with the largest supported hard disk drive.

Total Internal Storage <sup>1</sup>	EIDE Models		
	7200RPM IDE HDDs <sup>2</sup>		
	20.4GB P/N 19K4461	40GB P/N 22P7157	60GB P/N 09N4207
20.4GB	20.4GB Standard on EIDE models		
40.8GB	1	-	-
60.4GB	-	1	-
80GB <sup>3</sup>	-	2 <sup>3</sup>	-
80.4GB	-	-	1
120GB (max) <sup>3</sup>	-	-	2 <sup>3</sup>

This table does not represent all possible HDD configurations. Total Internal Storage listed is within +/-0.2GB unless otherwise noted.

1. Select a total storage row then select the quantity of HDDs from the appropriate column.

2. The xSeries 300 dual integrated EIDE controllers support a maximum of three IDE devices per machine including one CD-ROM and two IDE HDDs.

3. Maximum capacity assumes replacement of standard hard disk drive with the largest supported hard disk drive.



Diskette / CD-ROM	Bay 1	Bay 2
-------------------	-------	-------

Bay	Form Factor	Height	Front Access	Usage
1 <sup>1</sup>	89mm (3.5in)	SL	Yes	HDD
2	89mm (3.5in)	SL	Yes	Open

1. Boot drive should be located in bay 1.

Part Number	Description	RPM	Height	Bays Supported	Max Qty
<b>IDE HDDs<sup>1, 2</sup></b>					
19K4461	20.4GB 7200rpm ATA-100 (EIDE) HDD	7200	SL	1, 2	2
22P7157	40GB 7200rpm ATA-100 (EIDE) HDD	7200	SL	1, 2	2
09N4207	60GB 7200rpm ATA-100 (EIDE) HDD	7200	SL	1, 2	2
<b>Non Hot-Swap Ultra160 SCSI HDDs<sup>2</sup></b>					
00N8207	9.1GB 10,000rpm Ultra160 HDD	10000	SL	1, 2	2
00N8208	18.2GB 10,000rpm Ultra160 HDD	10000	SL	1, 2	2
06P5750	18.2GB 10,000rpm Ultra160 HDD	10000	SL	1, 2	2
00N8209	36.4GB 10,000rpm Ultra160 HDD	10000	SL	1, 2	2
06P5751	36.4GB 10,000rpm Ultra160 HDD	10000	SL	1, 2	2
06P5765	18.2GB 15,000rpm Ultra160 HDD	15000	SL	1, 2	2
19K0658	18.2GB 15,000rpm Ultra160 HDD	15000	SL	1, 2	2
06P5766	36.4GB 15,000rpm Ultra160 HDD	15000	SL	1, 2	2
<b>External Storage Expansion Units<sup>3</sup></b>				<b>Form Factor</b>	
19K11xx <sup>9</sup>	EXP300 Storage Expansion Unit <sup>4, 8</sup>	Rack (3U)			
19K11xx <sup>10</sup>	FASt200 Storage Server <sup>5, 6, 8</sup>	Rack (3U)			
19K11xx <sup>11</sup>	FASt200 HA Storage Server <sup>5, 8</sup>	Rack (3U)			
19K1121	FASt200 Redundant RAID Controller <sup>6</sup>	-			
00N71xx <sup>12</sup>	FASt EXP500 Storage Expansion Unit <sup>7, 8</sup>	Rack (3U)			
94G7448	Rack Power Cable Type C12 (3.7m) <sup>8</sup>	-			

1. The xSeries 300 dual integrated EIDE controllers support a maximum of three IDE devices per machine including one CD-ROM, and two IDE hard disk drives.

2. Mixing of internal IDE and SCSI hard disk drives is not supported.

3. xSeries 300 does not include an external SCSI connector. To configure a SCSI storage device, select an optional SCSI controller then refer to Appendix D: Cables - Storage Units - Controllers to confirm the controller supports the desired External Storage Expansion Unit and to select a supported cable. For HDD or other expansion unit options, see the specific expansion unit section. For Fibre Channel storage devices, refer to the Fibre Channel Solutions Overview section.

4. The EXP300 includes a single 2M Ultra2 SCSI cable and dual hot-swap 500W redundant power supplies, each with its own standard country power cord.

5. The FASt200 Storage Server and HA Storage Server each include two hot-swap, 350W auto-ranging redundant power supplies, each with its own standard country power cord.

6. Can be upgraded to FASt200 HA Storage Server through the addition of a FASt200 Redundant RAID Controller P/N 19K1121.

7. The FASt EXP500 Storage Expansion Unit P/N 00N71xx includes dual hot-swap 350W power supplies, each with its own standard country power cord.

8. These units do not include Rack Power Cables P/N 94G7448 when shipped (for attachment to high voltage UPS or PDU). Standard country power cords only are included. If required, order Rack Power Cables according to the number of power supplies.

9. Where 'xx' represents a specific country code as follows: 51=US/English, 52=European/English, 56=Danish/English, 57=Israel/English, 58=Italian/English, 59=South Africa/English, 60=Swiss/English, 63=UK/English:- Line Cords/Publication Country Kits are included as indicated.

10. Where 'xx' represents a specific country code as follows:- 23=US/English, 24=Euro/English, 25=Euro/Spanish, 27=Euro/German, 28=Denmark/English, 29=Israel/English, 30=Italy/English, 31=South Africa/English, 32=Switzerland/English, 34=Switzerland/German, 36=UK/English. Country/Language - Line Cords/Publications are included as indicated

11. Where 'xx' represents a specific country code as follows:- 37=US/English, 38=Euro/English, 39=Euro/Spanish, 41=Euro/German, 42=Denmark/English, 43=Israel/English, 44=Italy/English, 45=South Africa/English, 46=Switzerland/English, 48=Switzerland/German, 50=UK/English. Country/Language - Line Cords/Publications are included as indicated.

12. Where 'xx' represents a specific country code as follows:- 36=US/English, 37=Euro/English, 41=Denmark/English, 42=Israel/English, 43=Italy/English, 44=South Africa/English, 45=Switzerland/English, 49=UK/English. Country/Language Line Cords/Publications are included as indicated.



## xSeries 300 I/O Options

Part Number	Description	Adapter Length	PCI Support <sup>1</sup>	Slots Supported <sup>1,2</sup>
<b>Storage Controllers<sup>3, 15</sup></b>				
37L6889	ServeRAID-4H Ultra160 SCSI Controller <sup>4</sup>	Full	64-bit	1
06P5736	ServeRAID-4Mx Ultra160 SCSI Controller <sup>5</sup>	Full	64-bit	1
06P5740	ServeRAID-4Lx Ultra160 SCSI Controller <sup>6</sup>	Half	64-bit	1, 2
19K4646	PCI Wide Ultra160 SCSI Adapter <sup>7</sup>	Half	32-bit	1, 2
02K3454	PCI Fast/Wide Ultra SCSI Adapter <sup>8</sup>	Half	32-bit	1, 2
24P2585	IDE 100 RAID Controller by AMI <sup>9</sup>	Half	32-bit	1
<b>Fibre Storage Controller<sup>10</sup></b>				
00N6881	FASiT Host Adapter	Half	64-bit	1, 2
19K1246	FASiT FC-2 Host Bus Adapter	Half	64-bit	1, 2
<b>Networking<sup>11</sup></b>				
<b>Ethernet<sup>12</sup></b>				
09N9901	10/100 EtherLink Server Adapter by 3Com <sup>13</sup>	Half	32-bit	1, 2
06P3601	10/100 Ethernet Server Adapter <sup>13</sup>	Half	32-bit	1, 2
22P4901	10/100 Dual Port Server Adapter <sup>13</sup>	Half	64-bit	1, 2
22P6801	PRO/1000XT Server Adapter by Intel (with CD and manuals) <sup>13</sup>	Half	64-bit	1, 2
<b>Token Ring</b>				
34L5001	16/4 Token-Ring PCI Management Adapter <sup>13</sup>	Half	32-bit	1, 2
34L5201	High-Speed 100/16/4 Token-Ring PCI Management Adapter <sup>13</sup>	Half	32-bit	1, 2
<b>Communications<sup>14</sup></b>				

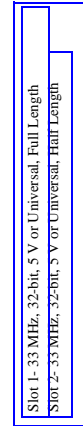

**Exterior  
Connector  
Access**

1. A 64-bit adapter installed into a 32-bit slot will transfer data at 32-bit rates. Adapters rated at 66MHz will operate at 33MHz when installed in a 33MHz slot. 133MHz PCI-X adapters are backward compatible with 33/66MHz, 64-bit PCI-based servers.
2. Slot one only is available for SCSI models (Ultra160 SCSI Controller is installed in slot two). The external connector does not support external SCSI devices.
3. xSeries 300 has dual integrated EIDE (ATA-100) bus master controllers. SCSI models ship standard with a single-channel Ultra160 SCSI Adapter in slot two. The SCSI Adapter includes a two-drop cable for connection to two internal HDDs. External connection of a SCSI device requires a supported SCSI adapter.
4. ServeRAID-4H Ultra160 SCSI Controller is powered by a 266MHz PowerPC 750 processor and 128MB of battery-backed ECC cache. The internal connectors are not accessible due to a cabling interference. Four external Ultra160 0.8mm VHDCI connectors are available. Some operating systems will function with this adapter only if the latest version of IPSSSEND is installed.
5. ServeRAID-4Mx Ultra160 SCSI Controller is powered by a 100MHz Intel Zion GC80303 processor that provides 64MB of battery-backed ECC cache and two internal and two external Ultra160 connections (only two connectors may be used). External connections are 0.8mm VHDCI.
6. ServeRAID-4Lx Ultra160 SCSI Controller is powered by a 100MHz Intel Zion GC80303 processor and provides a single channel, 32MB of ECC cache and either one internal or one external Ultra160 connection. External connector is 0.8mm VHDCI. If attached to the internal HDDs, installation is supported only in slot one.
7. PCI Wide Ultra160 SCSI Adapter P/N 19K4646 provides a single channel with one internal connector and one external 0.8mm VHDCI Ultra160 connector. Support for external SCSI devices only. A five-drop terminated LVD SCSI cable is included but not supported for use in this server.
8. PCI Fast/Wide Ultra SCSI Adapter P/N 02K3454 provides one external 68-pin high density connector that supports external SCSI devices such as tape enclosures.
9. Supported only in IDE models. Dual channel adapter includes two connectors, supporting one ATA-100 HDD per channel. Two 18in ATA-66 cables ship with the option. Allows RAID 0 and RAID 1 configurations.
10. See the Fibre Array Solutions section for additional configuration information.
11. xSeries 300 includes dual full-duplex, 10/100Mbps Ethernet controllers.
12. In a fault-tolerant networking environment, using the fault-tolerant software delivered with the Ethernet adapters of a single manufacturer is recommended. Installing fault-tolerant solutions provided by multiple manufacturers may cause failures if the intermediate drivers provided with the adapters are not compatible. The onboard Ethernet is Intel-based, which is compatible with the Intel-based optional Ethernet adapters listed here: P/Ns 06P3601, 06P3701, 22P4901, 22P6801.
13. The Wake on LAN function provided with this networking adapter is supported by this server.
14. xSeries 300 includes two USB ports and a high speed serial/asynchronous port (NS16550A compatible).
15. When storage controllers are installed in both PCI slots, the BIOS for the integrated storage controller must be disabled. i.e it cannot support either external or internal storage media. If the two storage controllers in slots one and two are both RAID adapters, the boot media must be attached to the RAID adapter in slot one.





**xSeries 300 Power, Monitors, Accessories**

Part Number	Description
<b>Power<sup>1, 2, 10</sup></b>	
94G7448	Rack Power Cable Type C12 (3.7m) <sup>10</sup>
<b>Uninterruptible Power Supply (UPS)<sup>3</sup></b>	
14RIxxx <sup>11</sup>	APC Smart-UPS 1400RMiB <sup>4</sup>
32P16xx <sup>12</sup>	APC 2U Smart-UPS 1400RMiB <sup>6</sup>
30RIxxx <sup>11</sup>	APC Smart-UPS 3000RMiB <sup>4</sup>
37L6862	APC Smart-UPS 5000RMiB <sup>5</sup>
<b>Monitors<sup>7</sup></b>	
T3147xx <sup>13</sup>	E54 Color Monitor 15in (350mm, 13.8in Viewable Image Size), stealth black <sup>8</sup>
T3247xx <sup>13</sup>	E74 Color Monitor 17in (403mm, 15.9in Viewable Image Size), stealth black <sup>8</sup>
T274Axx <sup>13</sup>	G78 Color Monitor 17in (406.4mm, 16in Viewable Image Size), stealth black <sup>8</sup>
T11AGxx <sup>13</sup>	T540 Flat Panel Color Monitor 15in (381mm, 15in viewable image), stealth black <sup>9</sup>

1. Most xSeries 300 models include a worldwide, voltage-sensing 200W power supply with auto restart and a standard country power cord.
2. A direct current model P/N K22AXxx includes a 200W, 48V direct current power supply. The line cord is customer-supplied. This model is designed for specific application in a telecommunications infrastructure.
3. For runtimes and UPS attributes see Appendix C: UPS Runtime Estimate.
4. Height is 3U. See Rack Cabinets and Options section for supported IBM racks.
5. Height is 5U. See Rack Cabinets and Options section for supported IBM racks.
6. Height is 2U. See Rack Cabinets and Options section for supported IBM racks.
7. xSeries 300 uses an SVGA controller (S-3 Savage4 chipset) with 8MB of video memory.
8. Installation within a rack requires optional Monitor Compartment P/N94G7444.
9. Installation within a rack requires optional Flat Panel Monitor Rack Mount Kit II P/N 37L6888 and Rack Keyboard Tray P/N 28L4707. A space saver keyboard may coexist within the same keyboard tray. See Rack Cabinets and Options section for more information.
10. Rack Power Cable P/N 94G7448 must be ordered for power connection to a high voltage UPS or PDU.
11. Where 'xxx' represents a specific country code as follows:- DEN=Denmark, ISR=Israel, ITA=Italy, SDI=Saudi Arabia, SAF=South Africa, SWS=Switzerland, UKM=United Kingdom, EUR=Europe
12. Where 'xx' represents a specific country code as follows:- 12=Europe, 13=UK, 14=Italy, 15=Switzerland, 16=Denmark, 17=South Africa, 18=Israel.
13. Where 'xx' represents a specific country code as follows:- DK=Denmark, IS=Israel, IT=Italy, SD=Saudi Arabia, SA=South Africa, CH=Switzerland, UK=UK, EU=Europe.

Part Number	Description
<b>Rack and NetBAY<sup>1, 2, 7</sup></b>	
94G7448	Rack Power Cable Type C12 (3.7m) <sup>7</sup>
<b>NOTE: Refer to the Rack Cabinets and Options section for details of IBM Racks and rack-supported devices.</b>	
<b>Keyboard and Mouse<sup>3</sup></b>	
28L36xx <sup>8</sup>	Space Saver II Keyboard <sup>4, 6</sup>
28L36xx <sup>9</sup>	Preferred Keyboard (stealth black) <sup>5</sup>
28L3675	Sleek 2-button Stealth Black Mouse

1. xSeries 300 is housed in a 19in rack-mountable drawer and requires one of the racks listed in the Rack Cabinets and Options section.
2. Note limitations and restrictions for adequate cooling in the Rack Cabinets and Options section. If non-IBM racks are to be used, assure that both the front and rear doors offer a minimum of 48% open area uniformly distributed and in line with installed servers. A clearance of 51 to 64mm (2 to 2.5in) must be maintained between the front door and the system unit's front bezel. The rear door must maintain the same or greater clearance.
3. xSeries 300 supports rack configurations only and ships without a keyboard or mouse.
4. Installation within a rack requires optional keyboard tray P/N 28L4707, which stows in ready-to-use position.
5. Installation within a rack requires optional keyboard tray P/N 28L4707. This keyboard cannot share a keyboard tray with a flat panel display.
6. Advanced TrackPoint IV features are not available on IBM xSeries systems.
7. The xSeries 300 ships with a standard country power cord. For connection to a high voltage UPS or PDU, a Rack Power Cable P/N 94G7448 must be ordered.
8. Where 'xx' represents a specific country code as follows:- 46=Danish, 47=France, 48=Germany, 49=Italian, 50=Spanish, 51=UK English, 44=US English, and P/N 19K3831=Switzerland, 19K3832=Sweden/Finland, 19K3833=Portugal, 19K3834=Belgium, 19K3836=Russia, 19K3837=Poland.
9. Where 'xx' represents a specific country code as follows:- 25=French, 26=German, 27=Italian, 29=UK English, 31=Danish, 33=Norwegian, 34=Swedish/Finnish, 35=Swiss, 36=Dutch, 21=US English, and P/N 22P7325=Belgium/UK, 22P7323=Icelandic.



**xSeries 300 Tape Options**

Part Number	Tape Drives	Bays Supported <sup>1</sup>	SCSI Interface (bit)	Form Factor	Termination Included	68/50-pin Converter Incl	Ext Tape Enclosures
09N4041	12/24GB DDS/3 4mm SCSI Tape Drive	-	8	89mm (3.5in) HH or 133mm (5.25in) HH	Y	Y	03K8756
09N4042	10/20GB NS SCSI Tape Drive	-	8	89mm (3.5in) SL or 133mm (5.25in) HH	Y	Y	03K8756
00N7991	20/40GB DDS/4 4mm SCSI Tape Drive	-	16 Ultra2 LVD	89mm (3.5in) HH or 133mm (5.25in) HH	N	-	03K8756 <sup>2</sup>
24P2396	100/200GB LTO SCSI HH Tape Drive	-	16 Ultra2 LVD	133mm (5.25in) HH	N	-	03K8756 <sup>2</sup>
24P2398	40/80GB Half-High DLTVS Internal SCSI Tape Drive	-	16 Ultra2 LVD	133mm (5.25in) HH	N	-	03K8756 <sup>2</sup>
00N8015	110/220GB Super DLT Internal SCSI Tape Drive	-	16 Ultra2 LVD	133mm (5.25in) FH	N	-	03K8756 <sup>2</sup>
00N8016	100/200GB LTO Tape Drive	-	16 Ultra2 LVD	133mm (5.25in) FH	N	-	03K8756 <sup>2</sup>
<b>External Tape Enclosures</b>							
03K8756	NetMEDIA Storage Expansion Unit EL <sup>3</sup>	-	16	Rack	Y	N	-
10L7113	NetMEDIA Systems Management Adapter <sup>4</sup>	-	16 LVD	-	N	N	03K8756
<b>Associated Options</b>							
10K2340	Media BayTray and LVD Cable Kit <sup>2</sup>	-	16 LVD	Int	Y	N	03K8756

1. xSeries 300 does not support internal tape drives and does not include an external SCSI connector. An internal tape drive with a tape enclosure, supported SCSI adapter and appropriate cable must be selected. All tape drives and enclosures are supported by PCI Wide Ultra160 SCSI Adapter P/N 19K4646 which has an external 0.8mm VHDCI connector. Select tape drive, enclosure and supported adapter then use Appendix D: Cables - Storage Units - Controllers to select an appropriate external cable.

2. LVD support for LVD devices installed in a NetMEDIA Storage Expansion Unit EL P/N 03K8756 requires replacement of the standard single-ended internal cables with one or more (depending on configuration) cables from Media Bay Tray and LVD Cable Kit P/N 10K2340 which contains a single two-drop multi-mode terminated cable. If the standard cables are used for attachment to LVD devices, single-ended SCSI rules and bus speeds apply.

3. NetMEDIA Storage Expansion Unit EL P/N 03K8756 is a black 3U, 19in rack mountable tape enclosure which includes two full-high (FH) or four half-high (HH) extended length 133mm (5.25in) bays, two external 0.8mm VHDCI connectors and two internal four-drop single-ended terminated 16-bit SCSI cables for device attachment. Two power supplies and two power cords are also included.

Tip: The front rail clips will need to be reversed and screwed in from behind to secure the unit in a Rack Cabinet P/N 930842x.

4. NetMEDIA Systems Management Adapter P/N 10L7113 may be installed in a NetMEDIA Storage Expansion Unit to provide repeater function, LVDS interface, aggregate cable lengths up to 12m when attached to an LVD SCSI controller, and auto-termination when the Expansion Unit is powered off. External connector is 0.8mm VHDCI.

Note: Additional tape attributes can be found in Appendix A: Tape Drive Attributes.

Note: For a complete list of all IBM and non-IBM options compatibility with Network Operating Systems and IBM xSeries Servers, access the IBM ServerProven compatibility pages on the Web at URL <http://www.ibm.com/pc/us/compat>



## xSeries 300 Sample Configurations

Note: The following sample configurations are for illustration only and may not be suitable for any specific customer installation. Contact your IBM Business Partner or IBM Marketing Representative for assistance with your specific configuration requirements.

### Internet Server<sup>1</sup>

Part Number	Description	Quantity
K283Xxx	xSeries 300 1GHz/256KB Pentium III, 256MB ECC, 18.2GB Ultra160 SCSI HDD, 24X	1
00N8208	18.2GB 10,000rpm Ultra160 SCSI HDD	1 <sup>2</sup>
T11AGxx	T540 Flat Panel Color Monitor 15in (381mm, 15in viewable image), stealth black	1
28L36xx	Space Saver II Keyboard	1
14RIxxx	APC Smart-UPS 1400RMiB	1

1. This example shows a 19in rackable configuration. The rack components are not included.
2. For a total of 36.4GB of internal storage.

An Internet server handles all requests from the Internet (Intranet or Extranet). Usually, this type of server has the same characteristics as a normal file server. The main difference is that an Internet server talks a different language (TCP/IP vs. NETBEUI or IPX/SPX) and often needs to do an extra security check (firewall). In the case of an Internet server, the server itself talks mostly to one client, the Internet Service Provider (ISP), instead of many clients as a file server does.

With this in mind, the xSeries 300 was selected to provide an affordable price point for the growing Internet server market with Pentium III processing, 256MB of system memory (expandable to 1.5GB), and power protection with an APC Smart-UPS.

The network configuration depends on the method that will be used to connect the server to the Internet. Usually fast Ethernet routers are used, but if other methods are used you can add the appropriate adapter.

### File and Print Server<sup>1</sup>

Part Number	Description	Quantity
K223Xxx	xSeries 300 800MHz/128KB Celeron, 128MB ECC, 18.2GB Ultra160 SCSI HDD, 24X	1
33L3083	256MB 133MHz ECC SDRAM DIMM Memory	1 <sup>2</sup>
00N8209	36.4GB 10,000rpm Ultra160 SCSI HDD	2 <sup>3</sup>
T11AGxx	T540 Flat Panel Color Monitor 15in (381mm, 15in viewable image), stealth black	1
28L36xx	Space Saver II Keyboard	1
14RIxxx	APC Smart-UPS 1400RMiB	1

1. This example shows a 19in rackable configuration. The rack components are not included.
2. For a total of 384MB of system memory.
3. For a total of 72.8GB of internal storage - the standard 18.2GB disk has to be removed.

A small business or departmental server is usually required to perform all typical server functions while servicing up to 100 users in a normal workgroup computing environment, but doesn't require the high-end performance and fault-tolerance properties of larger servers.

The sample configuration above consists of an xSeries 300 with 384MB of memory and 72.8GB of HDD space. It has enough processor power and memory to run most current network operating systems comfortably and enough HDD space to store a significant amount of data with additional external storage expansion still available. Demanding network traffic is effectively handled by the standard 100Mbps Ethernet connection.

This configuration also includes a UPS to keep the system protected during power surges and outages.

### Application Platform<sup>1</sup>

Part Number	Description	Quantity
K283Xxx	xSeries 300 1GHz/256KB Pentium III, 256MB ECC, 18.2GB Ultra160 SCSI HDD, 24X	1
33L3085	512MB 133MHz ECC SDRAM Unbuffered DIMM Memory	1 <sup>2</sup>
00N8208	18.2GB 10,000rpm Ultra160 SCSI HDD	1 <sup>3</sup>
T11AGxx	T540 Flat Panel Color Monitor 15in (381mm, 15in viewable image), stealth black	1
28L36xx	Space Saver II Keyboard	1
14RIxxx	APC Smart-UPS 1400RMiB	1

1. This example shows a 19in rackable configuration. The rack components are not included.
2. For a total of 768MB of system memory.
3. For a total of 36.4GB of internal storage.

An application server differs from a file and print server in that it has a higher workload in providing application serving requirements for users. As an appliance platform, this server efficiently delivers task-specific solutions using a single application, e.g., Web hosting, Web caching, firewalls or gateways. With this in mind, the xSeries 300 was selected to provide an affordable price point for an application server with Pentium III processing, 768MB of system memory (expandable to 1.5GB), and availability features such as power protection with an APC Smart-UPS. The internal SCSI controller can be upgraded by selecting an optional ServeRAID adapter to provide even higher availability.





# IBM xSeries 330

Part Number  
 Withdrawal Date: ddmmyy  
 Processor Speed  
 Number of Processors (Std./Max)  
 L2 ECC Cache (KB)  
 Memory (Std./Max) (R = RDIMM)  
 Form Factor  
 Power Supply Quantity (Std./Max)  
 Hot-Swap (Power, Slots, HDD, Fans)  
 Adv. System Management Processor  
 Onboard Ethernet (Mbps)  
 SCSI Controller (Dual, Ultra, RAID)  
 Removable Media Bays (Total/Avail)  
 Internal Disk Drive (Std./Max)  
 CD-ROM (IDE)<sup>3</sup>  
 Bays: (Tot/Av)  
 Slots(Tot/Av)

xSeries 330 At-A-Glance Chart																
K411Xxx <sup>1</sup>	-	1.13GHz <sup>2</sup>	1/2	512	256MB <sup>(R)</sup> /4GB	Rack(1U)	1/1	H	Y	2x10/100	U160	-	0/ 146.8GB	24X-10X	4/2	2/2
K412Xxx <sup>1</sup>	-	1.13GHz <sup>2</sup>	1/2	512	256MB <sup>(R)</sup> /4GB	Rack(1U)	1/1	-	Y	2x10/100	IDE	-	20.4GB/ 120GB	24X-10X	4/1	2/2
K413Xxx <sup>1</sup>	-	1.13GHz <sup>2</sup>	1/2	512	256MB <sup>(R)</sup> /4GB	Rack(1U)	1/1	-	Y	2x10/100	U160	-	18.2/ 146.8GB <sup>4</sup>	24X-10X	4/1	2/2
K431Xxx <sup>1</sup>	-	1.26GHz <sup>2</sup>	1/2	512	256MB <sup>(R)</sup> /4GB	Rack(1U)	1/1	H	Y	2x10/100	U160	-	0/ 146.8GB	24X-10X	4/2	2/2
K432Xxx <sup>1</sup>	-	1.26GHz <sup>2</sup>	1/2	512	256MB <sup>(R)</sup> /4GB	Rack(1U)	1/1	-	Y	2x10/100	IDE	-	20.4GB/ 120GB	24X-10X	4/1	2/2
K433Xxx <sup>1</sup>	-	1.26GHz <sup>2</sup>	1/2	512	256MB <sup>(R)</sup> /4GB	Rack(1U)	1/1	-	Y	2x10/100	U160	-	18.2/ 146.8GB <sup>4</sup>	24X-10X	4/1	2/2
K43AXxx <sup>1,5</sup>	-	1.26GHz <sup>2</sup>	1/2	512	256MB <sup>(R)</sup> /4GB	Rack(1U)	DC	H	Y	2x10/100	U160	-	0/ 146.8GB	24X-10X	4/2	2/2

1. Housed in a 19" Rack mountable drawer and ships standard without a keyboard or mouse. See Rack Cabinets and Options section for supported IBM racks.
2. Intel Pentium III processor with 133MHz FSB and 512KB advanced transfer cache.
3. Variable read rate. Actual playback speed will vary and is often less than the maximum possible.
4. This model does not support hot-swap HDDs.
5. This direct current (DC) power model includes a 200W, 48V direct current power supply requiring a direct current power source for utilisation in a telecommunications network infrastructure.

## xSeries 330 Processor Upgrades

Part Number	Processor Upgrades Description	SMP Support <sup>1</sup>	Processor Speed Upgrade <sup>2</sup>
25P2835	1.13GHz Upgrade with 133MHz FSB and 512KB Advanced Transfer Cache Pentium III Processor	K411Xxx, K412Xxx K413Xxx	-
25P2836	xSeries 1.26GHz/133MHz FSB - 512KB Cache Upgrade with Advanced Transfer Cache Pentium III Processor	K431Xxx, K432Xxx, K433Xxx, K43AXxx	K411Xxx, K412Xxx K413Xxx

1. One additional processor may be installed, providing a maximum of two. All processors must be identical in type, speed, and cache size.
2. Requires removal of the standard processor. A maximum of two processors may be installed. All processors must be identical in type, speed and cache size. Upgrades may require a BIOS update. To obtain the latest Flash BIOS, access [www.ibm.com/pc/support](http://www.ibm.com/pc/support) and enter machine "Type-Model" in Quick Path. Select "Downloadable files" and then "BIOS".



## xSeries 330 Memory Configurator

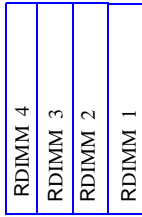

Part Number	Memory Description <sup>1</sup>
10K0018	IBM 128MB PC133 ECC SDRAM RDIMM
10K0020	IBM 256MB PC133 ECC SDRAM RDIMM
10K0022	IBM 512MB PC133 ECC SDRAM RDIMM
33L3326	IBM 1GB PC133 ECC SDRAM RDIMM

1. Memory RDIMMs must be installed in sequence from RDIMM connector 1 through connector 4. RDIMM size is not relevant.

Total Memory <sup>1</sup>	Quantity of RDIMMs Added			
	128MB P/N10K0018	256MB P/N10K0020	512MB P/N10K0022	1GB P/N33L3326
384MB	1	-	-	-
512MB	2 or	1	-	-
640MB	3	-	-	-
768MB	-	2 or	1	-
1024MB	-	3	-	-
1280MB	-	-	2 or	1
1792MB	-	-	3	-
2048MB <sup>2</sup>	-	-	4 <sup>2</sup>	-
2304MB	-	-	-	2
3328MB	-	-	-	3
4096MB (max) <sup>2</sup>	-	-	-	4 <sup>2</sup>

This table does not represent all possible memory configurations. Memory modules may vary in price per MB. Selection of smaller RDIMMs may provide a more cost-effective alternative to using larger RDIMMs.

1. Network operating systems may limit the maximum amount of addressable memory. See operating system specifications for further information.

2. Requires removal of standard memory.

## xSeries 330 Internal SCSI Cabling

xSeries 330 hot-swap models contain a DASD backplane supporting two hot-swap, SCA-2 compliant drive bays. The backplane is connected to the internal connector of the integrated Ultra160 SCSI controller through a 16-bit LVD SCSI cable. If internal RAID is required, the cable can be attached to the internal connector of the optional RAID adapter. The cable is of sufficient length to attach to adapters in slot one but not slot two.

xSeries 330 non hot-swap models contain either of the following:

- 20.4GB EIDE HDD cabled directly to an integrated EIDE controller through a two-drop cable that can support up to two EIDE HDDs
- 18.2GB 10,000RPM Ultra160 SCSI HDD cabled directly to the Ultra160 SCSI controller through a terminated two-drop LVDS SCSI cable that can support up to two HDDs.

In configurations where external SCSI device attachment is required, a supported SCSI adapter or ServeRAID controller must be installed.

**For additional information regarding internal cabling, refer to Appendix E: Internal Storage Cabling Overview.**

**xSeries 330 Internal Hard Disk Drive (HDD) and External Storage Configurator**

Total Internal Storage <sup>1,3</sup>	SCSI Models					
	10,000RPM Ultra160 SCSI HDDs				15,000RPM Ultra160 SCSI HDDs	
	9.1GB <sup>2</sup>	18.2GB <sup>2</sup>	36.4GB <sup>2</sup>	73.4GB <sup>2</sup>	18.2GB	36.4GB
Non H/Swap---->	P/N 00N8207	P/N 00N8208 or 06P5750	P/N 00N8209 or 06P5751	P/N 06P5752	P/N19K0656 or 06P5765	P/N 06P5766
Hot-Swap----->	P/N 37L7204	P/N 37L7205 or 06P5754	P/N 37L7206 or 06P5755	P/N 06P5756	P/N19K0658 or 06P5767	P/N 06P5768
0 GB	0GB Standard on Hot-Swap SCSI Models <sup>2,3</sup>				0GB Standard on Hot-Swap SCSI Models <sup>2,3</sup>	
9.1 GB	1	-	-	-	-	-
18.2 GB	2 <sup>4</sup> or	1	-	-	1	-
36.4 GB	-	2 <sup>4</sup> or	1	-	2 <sup>4</sup> or	1
72.8 GB	-	-	2 <sup>4</sup>	-	-	2 <sup>4</sup>
73.4GB	-	-	-	1	-	-
146.8GB (max) <sup>4</sup>	-	-	-	2 <sup>4</sup>	-	-

This table does not represent all possible hard disk drive (HDD) configurations.

1. Select a total storage row then identify the recommended HDDs from within an RPM range according to choice and type of disk required (hot-swap or non hot-swap). Total Internal Storage listed is within ± 0.2 GB unless otherwise noted.
2. Both hot-swap and non-hot-swap HDDs are listed. Select the appropriate part number for the model of xSeries 330 being configured.
3. Models P/N K413Xxx, K433Xxx support only fixed disks and ship standard with one 18.2GB non hot-swap disk P/N 00N8208. Recalculate storage requirements accordingly, using non hot-swap P/Ns.
4. Requires replacing standard HDD in non hot-swap SCSI models P/N K413Xxx and K433Xxx.

Total Internal Storage <sup>1</sup>	IDE Models		
	7200RPM HDDs <sup>2</sup>		
	20.4GB P/N19K4461	40GB P/N22P7157	60GB P/N 09N4207
20.4GB	Std on EIDE model		
40.8GB	1	-	-
60.4GB	-	1	-
80GB <sup>3</sup>	-	2 <sup>3</sup>	-
80.4GB	-	-	1
120GB (max) <sup>3</sup>	-	-	2 <sup>3</sup>

This table does not represent all possible HDD configurations. Total Internal Storage listed is within +/-0.2GB unless otherwise noted.

1. Select a total storage row then identify the recommended HDD to achieve the desired total.
2. The xSeries 330 dual integrated EIDE controllers support a maximum of three IDE devices per machine including one CD-ROM and two IDE HDDs.
3. Requires removal of the standard HDD.

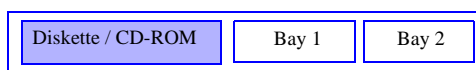

Bay	Form Factor	Height	Front Access	Usage
1 <sup>1</sup>	HS or 89mm (3.5in) <sup>2</sup>	SL	Yes	Open <sup>3</sup>
2	HS or 89mm (3.5in) <sup>2</sup>	SL	Yes	Open <sup>3</sup>

1. Boot drive should be located in bay 1.
2. x330 now includes IDE and SCSI fixed disk and SCSI hot-swap disk models.
3. Some fixed disk SCSI and IDE models ship with one standard HDD.



Part Number	Description	RPM	Height	Bays Supported	Max. Qty.
<b>IDE HDDs<sup>1, 2</sup></b>					
19K4461	20.4GB 7200rpm ATA-100 (EIDE) HDD	7200	SL	1 ... 2	2
22P7157	40GB 7200rpm ATA-100 (EIDE) HDD	7200	SL	1 ... 2	2
09N4207	60GB 7200rpm ATA-100 (EIDE) HDD	7200	SL	1 ... 2	2
<b>Non Hot-Swap Ultra160 SCSI HDDs<sup>2, 3</sup></b>					
00N8207	9.1GB 10,000rpm Ultra160 HDD	10000	SL	1 ... 2	2
00N8208	18.2GB 10,000rpm Ultra160 HDD	10000	SL	1 ... 2	2
06P5750	18.2GB 10,000rpm Ultra160 HDD	10000	SL	1 ... 2	2
00N8209	36.4GB 10,000rpm Ultra160 HDD	10000	SL	1 ... 2	2
06P5751	36.4GB 10,000rpm Ultra160 HDD	10000	SL	1 ... 2	2
06P5752	73.4GB 10,000rpm Ultra160 HDD	10000	SL	1 ... 2	2
06P5765	18.2GB 15,000rpm Ultra160 HDD	15000	SL	1 ... 2	2
19K0658	18.2GB 15,000rpm Ultra160 HDD	15000	SL	1 ... 2	2
06P5766	36.4GB 15,000rpm Ultra160 HDD	15000	SL	1 ... 2	2
<b>Hot-Swap Ultra160 SCSI HDDs<sup>4</sup></b>					
37L7204	9.1GB 10K-4 Ultra160 Hot-Swap HDD	10000	SL	1...2	2
37L7205	18.2GB 10K-4 Ultra160 Hot-Swap HDD	10000	SL	1...2	2
06P5754	18.2GB 10,000rpm Ultra160 Hot-Swap HDD	10000	SL	1...2	2
37L7206	36.4GB 10K-4 Ultra160 Hot-Swap HDD	10000	SL	1...2	2
06P5755	18.2GB 10,000rpm Ultra160 Hot-Swap HDD	10000	SL	1...2	2
06P5756	73.4GB 10,000rpm Ultra160 Hot-Swap HDD	10000	SL	1...2	2
06P5767	18.2GB 15,000rpm Ultra160 Hot-Swap HDD	15000	SL	1...2	2
19K0656	18.2GB 15,000rpm Ultra160 Hot-Swap HDD	15000	SL	1...2	2
06P5768	36.4GB 15,000rpm Ultra160 Hot-Swap HDD	15000	SL	1...2	2
<b>External Storage Expansion Units<sup>5</sup></b>			<b>Form Factor</b>		
19K11xx <sup>11</sup>	EXP300 Storage Expansion Unit <sup>6, 10</sup>	Rack (3U)			
19K11xx <sup>12</sup>	FASiT 200 Storage Server <sup>7, 8, 10</sup>	Rack (3U)			
19K11xx <sup>13</sup>	FASiT 200 HA Storage Server <sup>7, 10</sup>	Rack (3U)			
19K1121	FASiT 200 Redundant RAID Controller <sup>8</sup>	-			
00N71xx <sup>14</sup>	FASiT EXP500 Storage Expansion Unit <sup>9, 10</sup>	Rack (3U)			
94G7448	Rack Power Cable Type C12 (3.7m) <sup>10</sup>	-			

1. The xSeries 330 dual integrated EIDE controllers support a maximum of three IDE devices per machine including one CD-ROM and two IDE hard disk drives. IDE HDDs are supported only on IDE models.

2. Mixing of IDE and SCSI hard disk drives is not supported.

3. Nonhot-swap HDDs are supported only in fixed disk models.

4. Hot-swap HDDs are supported only in hot-swap models.

5. xSeries 330 does not include an external SCSI connector. To configure a SCSI storage device, select an optional SCSI controller then refer to Appendix D: Cables-Storage Units-Controllers to confirm the controller supports the desired External Storage Expansion Unit and to select a supported cable. For HDD or other expansion unit options, see the specific expansion unit section. For Fibre Channel storage devices, refer to the Fibre Channel Solutions Overview section.

6. The EXP300 includes a single 2M Ultra2 SCSI cable and dual hot-swap 500 W redundant power supplies, each with its own standard country power cord.

7. The FASiT200 Storage Server and HA Storage Server each include two hot-swap, 350 W auto-ranging redundant power supplies each with its own standard country power cord.

8. Can be upgraded to a FASiT200 HA Storage Server through the addition of a FASiT200 Redundant RAID Controller P/N 19K1121.

9. The FASiT EXP500 Storage Expansion Unit P/N 00N71xx includes dual hot-swap 350W power supplies, each with its own standard country power cord.

10. These units do not include Rack Power Cables P/N 94G7448 when shipped (for attachment to high voltage UPS or PDU). Standard country power cords only are included. If required, order Rack Power Cables according to the number of power supplies.

11. Where 'xx' represents a specific country code as follows: 51=US/English, 52=European/English, 56=Danish/English, 57=Israel/English, 58=Italian/English, 59=South Africa/English, 60=Swiss/English, 63=UK/English. Line Cords/ Publication Country Kits are included as indicated.

12. Where 'xx' represents a specific country code as follows: 23=US/English, 24=Euro/English, 25=Euro/Spanish, 27=Euro/German, 28=Denmark/English, 29=Israel/English, 30=Italy/English, 31=South Africa/English, 32=Switzerland/English, 34=Switzerland/German, 36=UK/English. Country/Language - Line Cords/Publications are included as indicated

13. Where 'xx' represents a specific country code as follows: 37=US/English, 38=Euro/English, 39=Euro/Spanish, 41=Euro/German, 42=Denmark/English, 43=Israel/English, 44=Italy/English, 45=South Africa/English, 46=Switzerland/English, 48=Switzerland/German, 50=UK/English. Country/Language - Line Cords/Publications are included as indicated.

14. Where 'xx' represents a specific country code as follows: 36=US/English, 37=Euro/English, 41=Denmark/English, 42=Israel/English, 43=Italy/English, 44=South Africa/English, 45=Switzerland/English, 49=UK/English. Country/Language Line Cords/Publications are included as indicated.



**xSeries 330 I/O Options**

Part Number	Description	Adapter Length	PCI Support <sup>1</sup>	Slots Supported <sup>1</sup>
<b>SCSI Storage Controllers<sup>2, 16</sup></b>				
37L6889	ServeRAID-4H Ultra160 SCSI Controller <sup>3</sup>	Full	64-bit	1
06P5736	ServeRAID-4Mx Ultra160 SCSI Controller <sup>4</sup>	Full	64-bit	1
06P5740	ServeRAID-4Lx Ultra160 SCSI Controller <sup>5</sup>	Half	64-bit	1, 2
19K4646	PCI Wide Ultra160 SCSI Adapter <sup>6</sup>	Half	32-bit	1, 2
02K3454	PCI Fast/Wide Ultra SCSI Adapter <sup>7</sup>	Half	32-bit	1, 2
24P2585	IDE 100 RAID Controller by AMI <sup>8</sup>	Half	32-bit	1
<b>Fibre Storage Controller<sup>9</sup></b>				
00N6881	FASrT Host Adapter	Half	64-bit	1, 2
19K1246	FASrT FC-2 Host Bus Adapter	Half	64-bit	1, 2
<b>Networking<sup>10</sup></b>				
<b>Ethernet<sup>11</sup></b>				
09N9901	10/100 EtherLink Server Adapter by 3Com <sup>12</sup>	Half	32-bit	1, 2
06P3601	10/100 Ethernet Server Adapter <sup>12</sup>	Half	32-bit	1, 2
06P3701	Gigabit Ethernet SX Server Adapter (fibre optic cabling interface)	Half	64-bit	1, 2
22P4901	10/100 Dual Port Server Adapter <sup>12</sup>	Half	64-bit	1, 2
22P6801	PRO/1000XT Server Adapter by Intel (with CD and manuals) <sup>12</sup>	Half	64-bit	1, 2
<b>Token Ring</b>				
34L0701	Token-Ring 16/4 PCI Adapter2 with Wake on LAN <sup>12</sup>	Half	32-bit	1, 2
34L5001	16/4 Token-Ring PCI Management Adapter <sup>12</sup>	Half	32-bit	1, 2
34L5201	High-Speed 100/16/4 Token-Ring PCI Management Adapter <sup>12</sup>	Half	32-bit	1, 2
<b>Communications<sup>13</sup></b>				
37L14xx	Serial I/O SST 8, 16 and 128 port adapters <sup>14</sup>	Half	32-bit	1, 2
<b>Systems Management<sup>15</sup></b>				
09N75xx <sup>19</sup>	Remote Supervisor Adapter <sup>17, 18</sup>	Half	32-bit	1, 2

Slot 1- Bus A, 33 MHz, 64-bit, 5 V or Universal, Full Length  
Slot 2- Bus A, 33 MHz, 64-bit, 5 V or Universal, Half Length

Exterior Connector Access

1. A 64-bit adapter installed into a 32-bit slot will transfer data at 32-bit rates. Adapters rated at 66MHz will operate at 33MHz when installed in a 33MHz slot. 133MHz PCI-X adapters are backward compatible with 33/66MHz, 64-bit PCI-based servers.

2. xSeries 330 has an integrated single channel Ultra160 SCSI Controller.

3. ServeRAID-4H Ultra160 SCSI Controller is powered by a 266 MHz Power PC 750 processor and provides four channels, 128 MB of battery-backed ECC cache. The internal connectors are not accessible due to a cabling interference. Four external Ultra160 0.8mm VHDCI connectors are available.

4. ServeRAID-4Mx Ultra160 SCSI Controller is powered by a 100MHz Intel Zion GC80303 processor that provides 64MB of battery-backed ECC cache and two internal and two external Ultra160 connections (only two connectors may be used). External connections are 0.8mm VHDCI.

5. ServeRAID-4Lx Ultra160 SCSI Controller is powered by a 100MHz Intel Zion GC80303 processor and provides a single channel, 32MB of ECC cache and either one internal or one external Ultra160 connection. External connector is 0.8mm VHDCI. If attached to the internal HDDs, installation is supported only in slot one.

6. PCI Wide Ultra160 SCSI Adapter P/N 19K4646 provides a single channel with one internal connector and one external 0.8-mm VHDCI Ultra160 connector. Support for external SCSI devices only. A five-drop terminated LVD SCSI cable is included but not supported for use in this server.

7. PCI Fast/Wide Ultra SCSI Adapter P/N 02K3454 provides one external 68-pin high density connector that supports external SCSI devices such as tape enclosures.

8. Supported only in IDE models. Dual channel adapter includes two connectors, supporting one ATA-100 HDD per channel. Two 18in ATA-66 cables ship with the option. Allows RAID 0 and RAID 1 configurations.

9. See the Fibre Array Solutions section for additional configuration information.

10. xSeries 330 includes dual full-duplex, 10/100 Mbps Ethernet controllers.

11. In a fault-tolerant networking environment, using the fault-tolerant software delivered with the Ethernet adapters of a single manufacturer is recommended. Installing fault-tolerant solutions provided by multiple manufacturers may cause failures if the intermediate drivers provided with the adapters are not compatible. The onboard Ethernet is Intel-based, which is compatible with the Intel-based optional Ethernet adapters listed here: P/Ns 06P3601, 06P3701, 22P4901, 22P6801.

12. The Wake on LAN function of this option is supported by models P/N K411Xxx to K43AXxx.

13. xSeries 330 includes two USB ports and a high speed serial/asynchronous port (NS16550A compatible).

14. See Appendix F for details on Serial I/O options and configuration limitations.

15. xSeries 330 has two integrated RS-485 system management interconnect ports located on the back of the system chassis. Connection of the standard integrated service processor to other servers in an interconnect network requires only a customer-supplied Cat5 Ethernet cable.

16. When storage controllers are installed in both PCI slots, the BIOS for the integrated storage controller must be disabled. i.e it cannot support either external or internal storage media. If the two storage controllers in slots one and two are both RAID adapters, the boot media must be attached to the RAID adapter in slot one.

17. When installed in an xSeries 330, the optional adapter serves only as an Ethernet and interconnect gateway. The onboard ASM processor will provide all server processor data.

18. When installing in xSeries 330 model P/Ns K411Xxx, K412Xxx, K413Xxx, K431Xxx, K432Xxx, K433Xxx, K43AXxx, install the 20-pin cable to provide the adapter with power. The AC power supply then becomes optional and provides redundant power to the adapter.

19. Where 'xx' represents a specific country code as follows:- 86=Europe, 87=Denmark, 88=South Africa, 89=UK, 90=Switzerland, 91=Italy, 92=Israel, 85=USA.



**xSeries 330 Power, Monitors, Accessories**

Part Number	Description
<b>Power<sup>1, 2, 13</sup></b>	
94G7448	Rack Power Cable Type C12 (3.7m) <sup>13</sup>
<b>Uninterruptible Power Supply (UPS)<sup>3</sup></b>	
14RIxxx <sup>14</sup>	APC Smart-UPS 1400RMB <sup>4</sup>
32P16xx <sup>15</sup>	APC 2U Smart-UPS 1400RMiB <sup>6</sup>
30RIxxx <sup>14</sup>	APC Smart-UPS 3000RMB <sup>4</sup>
37L6862	APC Smart-UPS 5000RMB <sup>5</sup>
<b>Monitors<sup>7, 8</sup></b>	
06P4792	Cable Chain Technology Cable Kit <sup>8, 9</sup>
T3147xx <sup>16</sup>	E54 Color Monitor 15in (350-mm, 13.8in Viewable Image Size), stealth black <sup>10</sup>
T3247xx <sup>16</sup>	E74 Color Monitor 17in (403-mm, 15.9in Viewable Image Size), stealth black <sup>10</sup>
T274Axx <sup>16</sup>	G78 Color Monitor 17in (406.4mm, 16.0in Viewable Image Size), stealth black <sup>10</sup>
T11AGxx <sup>16</sup>	T540 Flat Panel Color Monitor 15in (381mm, 15in viewable image), stealth black <sup>11</sup>
32P1032	NetBAY 1U Flat Panel Monitor Console Kit (without keyboard) <sup>12</sup>

1. Most xSeries 330 models include a worldwide, voltage-sensing 200W power supply with auto restart and a standard country power cord.
2. A direct current model P/N K43AXxx includes a 200W, 48V direct current power supply. The line cord is customer-supplied. This model is designed for specific application in a telecommunications infrastructure.
3. For runtimes and UPS attributes see Appendix C: UPS Runtime Estimate.
4. Height is 3U. See Rack Cabinets and Options section for supported IBM racks.
5. Height is 5U. See Rack Cabinets and Options section for supported IBM racks.
6. Height is 2U. See Rack Cabinets and Options section for supported IBM racks.
7. The xSeries 330 uses an SVGA controller (S-3 Savage4 chipset) with 8Mb of video memory.
8. A Cable Chain Technology Cable Kit P/N 06P4792 (quantity one) is required for the attachment of one or multiple-chained xSeries 330s to Keyboard/Video/Mouse either directly or via a Console Switch. If attaching directly, the Console Breakout Cable included in the Kit connects from the x330 'Out' port (or from the last x330 if multiple systems are chained together), to the K/V/M connectors. If attaching via a Console Switch, Console Cable P/N 09N4293 (2.1m/7ft) or P/N 94G7447 (3.6m/12ft) is required in addition to the kit and connects between the Console Breakout Cable and the Switch.
9. Each x330 ships with a Console Chaining Cable (254mm/10in), for connecting adjacent systems, thereby creating a console signal 'bus' that runs along a group of systems. The last system in the group then connects to console devices as described in note 6. Kit P/N 06P4792 also includes a longer Console Chaining Cable (2m/6.5ft) for use when the standard cable is not long enough. A maximum of 42 systems and no more than one Kit are allowed in one system chain.
10. Installation within a rack requires optional Monitor Compartment P/N94G7444.
11. Installation within a rack requires optional Flat Panel Monitor Rack Mount Kit II P/N 37L6888 and Rack Keyboard Tray P/N 28L4707. A space saver keyboard may coexist within the same keyboard tray. See Rack Cabinets and Options section for more information.
12. Includes a 15in Flat Panel Monitor. Does not include a keyboard. See note 11. - this is an alternative console solution.
13. Rack Power Cable P/N 94G7448 must be ordered for power connection to a high voltage UPS or PDU.
14. Where 'xxx' represents a specific country code as follows:- DEN=Denmark, ISR=Israel, ITA=Italy, SDI=Saudi Arabia, SAF=South Africa, SWS=Switzerland, UKM=United Kingdom, EUR=Europe
15. Where 'xx' represents a specific country code as follows:- 12=Europe, 13=UK, 14=Italy, 15=Switzerland, 16=Denmark, 17=South Africa, 18=Israel.
16. Where 'xx' represents a specific country code as follows:- DK=Denmark, IS=Israel, IT=Italy, SD=Saudi Arabia, SA=South Africa, CH=Switzerland, UK=UK, EU=Europe.

Part Number	Description
<b>Rack and NetBAY<sup>1, 2, 9</sup></b>	
94G7448	Rack Power Cable Type C12 (3.7m) <sup>9</sup>
<b>NOTE:</b> Refer to the Rack Cabinets and Options section for details of IBM Racks and rack-supported devices.	
<b>Keyboard and Mouse<sup>3</sup></b>	
06P4792	Cable Chain Technology Cable Kit <sup>4, 5</sup>
28L36xx <sup>10</sup>	Space Saver II Keyboard <sup>6, 8</sup>
28L36xx <sup>11</sup>	Preferred Keyboard (stealth black) <sup>7</sup>
28L3675	Sleek 2-button Stealth Black Mouse

1. xSeries 330 is housed in a 19in rack-mountable drawer and requires one of the racks listed in the Rack Cabinets and Options section.
2. Note limitations and restrictions for adequate cooling in the Rack Cabinets and Options section. If non-IBM racks are used, assure that both the front and rear doors offer a minimum of 48% open area uniformly distributed and in line with the installed servers. A clearance of 51 to 64mm (2 to 2.5in) must be maintained between the front door and the system unit's front bezel. The rear door must maintain the same or greater clearance.
3. xSeries 330 supports rack configurations only and ships without a keyboard or mouse.
4. A Cable Chain Technology Cable Kit P/N 06P4792 (quantity one) is required for the attachment of one or multiple-chained xSeries 330s to Keyboard/Video/Mouse either directly or via a Console Switch. If attaching directly, the Console Breakout Cable included in the Kit connects from the x330 'Out' port (or from the last x330 if multiple systems are chained together), to the K/V/M connectors. If attaching via a Console Switch, Console Cable P/N 09N4293 (2.1m/7ft) or P/N 94G7447 (3.6m/12ft) is required in addition to the kit and connects between the Console Breakout Cable and the Switch.
5. Each x330 ships with a Console Chaining Cable (254mm/10in), for connecting adjacent systems, thereby creating a console signal 'bus' that runs along a group of systems. The last system in the group then connects to console devices as described in note 4. Kit P/N 06P4792 also includes a longer Console Chaining Cable (2m/6.5ft) for use when the standard cable is not long enough. A maximum of 42 systems and no more than one Kit are allowed in one system chain.
6. Installation within a rack requires optional keyboard tray P/N 28L4707 (stows in "ready-to-use" position).
7. Installation within a rack requires optional keyboard tray P/N 28L4707. This keyboard cannot share a keyboard tray with a flat panel display.
8. Advanced TrackPoint IV features are not available on IBM xSeries systems.
9. The xSeries 330 ships with a standard country power cord. For connection to a high voltage UPS or PDU, a Rack Power Cable P/N 94G7448 must be ordered.
10. Where 'xxx' represents a specific country code as follows:- 46=Danish, 47=France, 48=Germany, 49=Italian, 50=Spanish, 51=UK English, 44=US English, and P/N 19K3831=Switzerland, 19K3832=Sweden/Finland, 19K3833=Portugal, 19K3834=Belgium, 19K3836=Russia, 19K3837=Poland.
11. Where 'xx' represents a specific country code as follows:- 25=French, 26=German, 27=Italian, 29=UK English, 31=Danish, 33=Norwegian, 34=Swedish/Finnish, 35=Swiss, 36=Dutch, 21=US English, and P/N 22P7325=Belgium/UK, 22P7323=Icelandic.



**xSeries 330 Tape Options**

Part Number	Description	Bays Supported <sup>1</sup>	SCSI Interface (bit)	Form Factor	Termination Included	68/50-pin Converter Incl.	Ext. Tape Enclosures
09N4041	12/24GB DDS/3 4-mm SCSI Tape Drive	-	8	89mm (3.5in) HH or 133mm (5.25in) HH	Y	Y	03K8756
09N4042	10/20GB NS SCSI Tape Drive	-	8	89mm (3.5in) SL or 133mm (5.25in) HH	Y	Y	03K8756
00N7991	20/40GB DDS/4 4-mm SCSI Tape Drive	-	16 Ultra2 LVD	89mm (3.5in) HH or 133mm (5.25in) HH	N	-	03K8756 <sup>2</sup>
09N4040	20/40GB DLT SCSI Tape Drive	-	8	133mm (5.25in) FH	N	Y	03K8756
00N7990	40/80GB DLT SCSI Tape Drive	-	16 Ultra2 LVD	133mm (5.25in) FH	N	-	03K8756 <sup>2</sup>
00N8015	110/220GB Super DLT Internal SCSI Tape Drive	-	16 Ultra2 LVD	133mm (5.25in) FH	N	-	03K8756 <sup>2</sup>
00N8016	100/200GB LTO SCSI Tape Drive	-	16 Ultra2 LVD	133mm (5.25in) FH	N	-	03K8756 <sup>2</sup>
24P2396	100/200GB LTO SCSI HH Tape Drive	-	16 Ultra2 LVD	133mm (5.25in) HH	N	-	03K8756 <sup>2</sup>
24P2398	40/80GB Half-High DLT/VS SCSI Tape Drive	-	16 Ultra2 LVD	133mm (5.25in) HH	N	-	03K8756 <sup>2</sup>
<b>Tape Autoloaders</b>							
00N79xx <sup>9</sup>	DLT SCSI Tape Autoloader	-	16	Desktop	Y	-	-
00N7992	120/240GB DDS/4 SCSI Tape Autoloader	-	16 Ultra2 LVD	133mm (5.25in) FH	N	-	03K8756 <sup>2</sup>
09N40xx <sup>10</sup>	3600 Series 900GB/1.8TB LTO SCSI Tape Autoloader <sup>3</sup>	-	16 Ultra2 LVD	Tower or 6U Rack	Y	-	-
<b>External Tape Libraries<sup>4</sup></b>							
00N79xx <sup>11</sup>	DLT SCSI Tape Library	-	16	Rack	Y	-	-
21P99xx <sup>12</sup>	3600 Series 2/4TB LTO SCSI Tape Library (Tower)	-	16 Ultra2 LVD	Tower	Y	-	-
21P99xx <sup>12</sup>	3600 Series 2/4TB LTO SCSI Tape Library (Rack)	-	16 Ultra2 LVD	5U Rack	Y	-	-
21P99xx <sup>13</sup>	3600 Series 2-Drive, 20-Cartridge Expander Module <sup>5</sup>	-	16 Ultra2 LVD	5U Rack	Y	-	-
09N4048	3600 Series LTO Drive Upgrade Option <sup>6</sup>	-	16 Ultra2 LVD	-	N	-	-
<b>External Tape Enclosures</b>							
03K8756	NetMEDIA Storage Expansion Unit EL <sup>7</sup>	-	16	Rack	Y	N	-
10L7113	NetMEDIA Systems Management Adapter <sup>8</sup>	-	16 LVD	-	N	N	03K8756
<b>Associated Options</b>							
10K2340	Media Bay Tray and LVD Cable Kit <sup>2</sup>	-	16 LVD	Int.	Y	N	03K8756

- xSeries 330 does not support internal tape drives and does not include an external SCSI connector. An external tape library or internal tape drive with a tape enclosure, supported SCSI adapter and appropriate cable must be selected. All tape drives and enclosures are supported by PCI Wide Ultra160 SCSI Adapter P/N 19K4646 which has an external 0.8-mm VHDCI connector. Select tape drive, enclosure and supported adapter then use Appendix D: Cables-Storage Units-Controllers to select an appropriate external cable.
- LVD support for LVD devices installed in a NetMEDIA Storage Expansion Unit EL P/N 03K8756 requires replacement of the standard single-ended internal cables with one or more (depending on configuration) cables from Media Bay Tray and LVD Cable Kit P/N 10K2340 which contains a single two-drop multi-mode LVD-SCSI terminated cable. If the standard cables are used for attachment to LVD devices, single-ended SCSI rules and bus speeds apply.
- If installed in a rack, a fixed shelf is required. Allow an additional 1U for the fixed shelf. One unit only per shelf is supported.
- Tape library attributes and prerequisites are located in Appendix B: Tape Library Attributes.
- Supported only with the 3600 Series LTO Tape Library (Rack) P/N 21P99xx. Allow one additional EIA space when installing either one or two (maximum) units to accommodate a filler plate for cable routing. Up to two 3600 Series LTO Drive Upgrade Options can be installed in each module or the module can operate off the LTO drives installed in the LTO tape library.
- Install in second drive bay of 3600 Series LTO Tape Libraries or in open bays of 3600 Series 2-drive, 20-cartridge Expander Module to increase performance. Includes an LTO (Ultrium) drive and a one-meter external LVD SCSI cable.
- NetMEDIA Storage Expansion Unit EL P/N 03K8756 is a black 3U, 19" rack-mountable tape enclosure which includes two full high (FH) or four half high (HH) extended length 133 mm (5.25") bays, two external 0.8mm VHDCI connectors and two internal four-drop single-ended terminated 16-bit SCSI cables for device attachment. Two power supplies and two power cords are also included. Tip: The front rail clips will need to be reversed and screwed in from behind to secure the unit in a Rack Cabinet P/N 930842x.
- NetMEDIA Systems Management Adapter P/N 10L7113 may be installed in a NetMEDIA Storage Expansion Unit to provide repeater function, LVDS interface, aggregate cable lengths up to 12 meters when attached to an LVD SCSI controller, and auto-termination when the Expansion Unit is powered off. External connector is 0.8mm VHDCI.
- Where 'xx' represents a country specific power cord code: 70=UK, 71=Swiss, 72=Italy, 73=Israel, 33L4981=EU1, 33L4982=Denmark, 33L4983=South Africa/India.
- Where 'xx' represents a specific country code as follows:- 49=UK, 50=Europe, 51=Denmark, 52=South Africa, 53=Switzerland, 54=Italy, 55=Israel.
- Where 'xx' represents a specific country code as follows:- Rack versions - 81=EU1, 82=Denmark, 83=India/South Africa, 84=UK, 85=Swiss, 86=Italy, 87=Israel.
- Where 'xx' represents a specific country code as follows:- Tower version - 71=Europe, 72=Denmark, 73=South Africa, 70=UK, 74=Swiss, 75=Italy, 76=Israel- Rack version - 78=Europe, 79=Denmark, 80=South Africa, 77=UK, 81=Swiss, 82=Italy, 83=Israel.
- Where 'xx' represents a specific country code as follows:- 85=Europe, 86=Denmark, 87=South Africa, 84=UK, 88=Swiss, 89=Italy, 90=Israel.

Note: Additional tape attributes can be found in Appendix A: Tape Drive Attributes.

Note: For a complete list of all IBM and non-IBM options compatibility with Network Operating Systems and IBM xSeries Servers, access the IBM ServerProven compatibility pages on the Web at URL <http://www.ibm.com/pc/us/compat>

To access IBM information specific to your country via the World Wide Web, use address: <http://www.ibm.com/pc>



## xSeries 330 Sample Configurations

Note: The following sample configurations are for illustration only and may not be suitable for any specific customer installation. Contact your IBM Business Partner or IBM Marketing Representative for assistance with your specific configuration requirements.

### Internet Server<sup>1</sup>

Part Number	Description	Quantity
K411Xxx	xSeries 330 1.13GHz/512KB, 256MB ECC, Open, Hot-Swap, 24X, PCI	1
37L7205	18.2GB 10K-4 Ultra160 SCSI Hot-Swap SL HDD	2 <sup>2</sup>
06P4792	Cable Chain Technology Cable Kit <sup>3</sup>	1
T3147xx	E54 Color Monitor 15in (350mm, 13.8in Viewable Image Size), stealth black	1
28L36xx	Space Saver II Keyboard	1
14RIxxx	APC Smart-UPS 1400RMiB	1

1. This example shows a 19" rackable configuration. The rack components are not included.

2. For a total of 36.4GB of internal storage.

3. A single Cable Chain Technology Cable Kit P/N 06P4792 is required for attachment of one or multiple (up to 42) chained xSeries 330s to a single monitor, mouse and keyboard.

An Internet server handles all requests from the Internet (Intranet or Extranet). Usually, this type of server has the same characteristics as a normal file server. The main difference is that an internet server talks a different language (TCP/IP vs. NETBEUI or IPX/SPX) and often needs to do an extra security check (firewall). In the case of an Internet server, the server itself talks mostly to one client, the Internet Service Provider (ISP), instead of many clients as a file server does.

With this in mind, the xSeries 330 was selected to provide an affordable price point for the growing Internet server market with two-way Pentium III processing, 256MB of system memory (expandable to 4GB), and power protection with an APC Smart-UPS.

The network configuration depends on the method that will be used to connect the server to the Internet. Usually fast Ethernet routers are used, but if other methods are used you can add the appropriate adapter.

### File and Print Server<sup>1</sup>

Part Number	Description	Quantity
K411Xxx	xSeries 330 1.13GHz/512KB, 256MB ECC, Open, Hot-Swap, 24X, PCI	1
10K0018	128MB PC133 ECC SDRAM RDIMM	1 <sup>2</sup>
37L7206	36.4GB 10K-4 Ultra160 SCSI Hot-Swap SL HDD	2 <sup>3</sup>
06P4792	Cable Chain Technology Cable Kit	1 <sup>4</sup>
T3147xx	E54 Color Monitor 15in (350mm, 13.8in Viewable Image Size), stealth black	1
28L36xx	Space Saver II Keyboard	1
14RIxxx	APC Smart-UPS 1400RMiB	1

1. This example shows a 19" rackable configuration. The rack components are not included.

2. For a total of 384MB of system memory.

3. For a total of 72.8GB of internal storage.

4. A single Cable Chain Technology Cable Kit (P/N 06P4792) is required for attachment of one or multiple (up to 42) chained xSeries 330s to a single monitor, mouse and keyboard.

A small business or departmental server is usually required to perform all typical server functions while servicing up to 100 users in a normal workgroup computing environment, but doesn't require the high-end performance and fault-tolerance properties of larger servers.

The sample configuration above consists of an xSeries 330 with 384MB of memory and 72.8GB of hard disk space. It has enough processor power and memory to run most current network operating systems comfortably and enough hard disk drive space to store a significant amount of data with additional external storage expansion still available. Demanding network traffic is effectively handled by the standard 100Mbps Ethernet connection.

This configuration also includes a UPS to keep the system protected during power surges and outages.

### Application Server<sup>1</sup>

Part Number	Description	Quantity
K411Xxx	xSeries 330 1.13GHz/512KB, 256MB ECC, Open, Hot-Swap, 24X	1
25P2835	1.13GHz Upgrade with 133MHz FSB and 256 KB Advanced Transfer Cache Pentium III Processor	1
10K0020	256MB PC133 ECC SDRAM RDIMM	1 <sup>2</sup>
37L7205	18.2GB 10K-4 Ultra160 SCSI Hot-Swap SL HDD	2 <sup>3</sup>
06P4792	Cable Chain Technology Cable Kit	1 <sup>4</sup>
T31U2xx	E54 Color Monitor 15in (350mm, 13.8in Viewable Image Size), stealth black	1
28L36xx	Space Saver II Keyboard	1
14RIxxx	APC Smart-UPS 1400RMiB	1

1. This example shows a 19" rackable configuration. The rack components are not included.

2. For a total of 512MB of system memory.

3. For a total of 36.4GB of internal storage.

4. A single Cable Chain Technology Cable Kit P/N 06P4792 is required for attachment of one or multiple (up to 42) chained xSeries 330s to a single monitor, mouse and keyboard.

An application server differs from a file and print server in that it has a higher workload, in providing application serving requirements for users. With this in mind, the xSeries 330 was selected to provide an affordable price point for an application server, with two-way Pentium III processing, 512MB of system memory (expandable to 4GB), and optional availability features such as RAID-protected internal storage and power protection with an APC Smart-UPS.



# IBM xSeries 342

Part Number  
 Withdrawal Date: ddmmyy  
 Processor Speed<sup>2</sup>  
 Number of Processors (Std/Max)  
 L2 ECC Cache (KB)  
 Memory (Std/Max) (DIMM)  
 Form Factor  
 Power Supply Quantity (Std/Max)  
 Hot-Swap (Power, Slots, HDD, Fans)  
 Redundancy (Optional, Standard)  
 Integrated System Management  
 Onboard Ethernet (Mbps)  
 SCSI Controller (Dual, Ultra, RAID)  
 Removable Media Bays (Total/Avail)  
 Internal Hard Disk Drive (Std/Max)  
 Bays (Total/Avail)  
 Slots (Tot/Avail)

xSeries 342 At-A-Glance																		
K91RXxx <sup>1</sup>	-	1GHz	1/2	256	256MB/4GB	Rack (3U)	1/2	P, H, F	O - Power <sup>3</sup> S - Fans	Y	10/100	D,U160	4/2 <sup>4</sup>	0/220.2GB <sup>5</sup>	24X-10X	7/5 <sup>4</sup>	5/5	
K92RXxx <sup>1</sup>	-	1.13 GHz	1/2	512	256MB/4GB	Rack (3U)	1/2	P, H, F	O - Power <sup>3</sup> S - Fans	Y	10/100	D,U160	4/2 <sup>4</sup>	0/220.2GB <sup>5</sup>	24X-10X	7/5 <sup>4</sup>	5/5	
K94RXxx <sup>1</sup>	-	1.26 GHz	1/2	512	256MB/4GB	Rack (3U)	1/2	P, H, F	O - Power <sup>3</sup> S - Fans	Y	10/100	D,U160	4/2 <sup>4</sup>	0/220.2GB <sup>5</sup>	24X-10X	7/5 <sup>4</sup>	5/5	

- Housed in a 19in rack-mountable drawer and ships standard without a keyboard or mouse. See Rack Cabinets and Options section for supported IBM racks.
- Intel Pentium III processor with advanced transfer L2 cache and 133MHz FSB.
- Power supply redundancy requires installation of optional 270W Hot-Swap Redundant Power Supply P/N 37L6879.
- xSeries 342 includes two available removable media bays that can be converted to three slim-line (SL) hot-swap bays with the addition of optional 3-Pack Ultra160 Hot-Swap Expansion Kit P/N 33L5050, thereby doubling internal hard disk drive storage capacity.
- The optional 3-Pack Ultra160 Hot-Swap Expansion Kit P/N 33L5050 is available, which converts the two available removable media bays into three slim-line (SL) hot-swap bays. This increases the Total Bays and Available Bays from 7/5 to 8/6 and the number of hot-swap disk bays from 3 to 6, thereby doubling the internal hot-swap hard disk drive capacity to 440.4GB.
- Variable read rate. Actual playback speed will vary and is often less than the maximum possible.

## xSeries 342 Processor Upgrades

Part Number	Processor Upgrades	SMP Support <sup>1</sup>	Processor Speed Upgrade <sup>2</sup>
24P3511	xSeries 1GHz/133MHz 256KB Cache Upgrade with Pentium III Processor	K91RXxx	-
24P3512	xSeries 1.13GHz/133MHz 512KB Cache Upgrade with Pentium III Processor	K92RXxx	K91RXxx
25P2600	xSeries 1.26GHz/133MHz 512KB Cache Upgrade with Pentium III Processor	K94RXxx	K91RXxx, K92RXxx

- One additional processor may be installed, providing a maximum of two. All processors must be identical in type, speed, and cache size.
- Requires removal of the standard processor. A maximum of two processors may be installed. All processors must be identical in type, speed and cache size. Upgrades may require a BIOS update. To obtain the latest Flash BIOS, access [www.pc.ibm.com/support](http://www.pc.ibm.com/support) and enter machine "Type-Model" in Quick Path. Select "Downloadable files" then "BIOS."

## xSeries 342 Memory Configurator

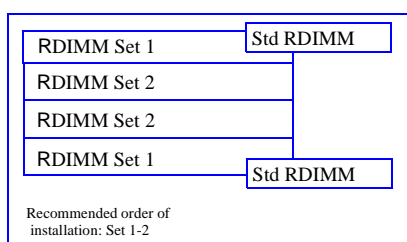

Total Memory <sup>1</sup>	Quantity of RDIMMs Added			
	128MB P/N 33L3320	256MB P/N 33L3322	512MB P/N 33L3324	1GB P/N 33L3326
256MB (2 x 128) Models				
512MB	2	-	-	-
768MB	-	2	-	-
1GB <sup>2</sup>	-	4 <sup>2</sup>	-	-
1.25GB	-	-	2	-
2.0GB <sup>2</sup>	-	-	4 <sup>2</sup>	-
2.25GB	-	-	-	2
4GB (max) <sup>2</sup>	-	-	-	4 <sup>2</sup>

This table does not represent all possible memory configurations. Memory modules may vary in price per MB. Selection of smaller RDIMMs may provide a more cost-effective alternative to using larger RDIMMs.

- Network operating systems may limit the maximum amount of addressable memory. See operating system specifications for further information.
- Requires removal of standard memory.

Part Number	Memory Description <sup>1</sup>
33L3320	IBM 128MB PC133 ECC SDRAM RDIMM
33L3322	IBM 256MB PC133 ECC SDRAM RDIMM
33L3324	IBM 512MB PC133 ECC SDRAM RDIMM
33L3326	IBM 1GB PC133 ECC SDRAM RDIMM

1. Due to two-way interleaving, memory options are required to be installed in pairs beginning with set 1.



### xSeries 342 Internal SCSI Cabling

The xSeries 342 contains seven standard drive bays. The top bay on the left contains the standard 3.5in slim-line (SL) diskette drive and the bay beneath contains the standard CD-ROM drive. Three 3.5in SL hot-swap bays in the center of the server support various hot-swap drive options. Two 5.25in half-high (HH) bays on the left support either tape back-up or an optional 3-Pack Ultra160 Hot-Swap Expansion Kit P/N 33L5050. The 24X-10X IDE CD-ROM is cabled directly to the IDE port.

The xSeries 342 contains a DASD backplane supporting three hot-swap, SCA-2 compliant drive bays. The backplane is connected to one of the internal connectors of the integrated dual-channel Ultra160 SCSI controller through a 16-bit LVD SCSI cable.

**Additional Cabling Requirements:**

xSeries 342 supports two storage alternatives in the two 5.25in HH media bays. An optional 3-Pack Ultra160 Hot-Swap Expansion Kit P/N 33L5050 can be installed to provide additional internal HDD storage capacity. Included with this option is a 16-bit LVD SCSI cable that can be attached from the 3-Pack Ultra160 Hot-Swap backplane to the second connector of the Ultra160 controller, or through the use of a repeater card that is included with the option, it can be cabled directly to the standard backplane. If a tape backup device is required in one or both of the media bays, a two-drop SCSI cable available in the Media Bay Tray and LVD Cable Kit P/N10K2340 must be ordered to connect these devices to the Ultra160 controller. In configurations where external SCSI device attachment is required, a supported SCSI adapter must be installed.

**For additional information regarding internal cabling, refer to Appendix E: Internal Storage Cabling Overview.**

### xSeries 342 Internal Hard Disk Drive (HDD) and External Storage Configurator

Total Int Storage <sup>1</sup>	10,000RPM HDDs				15,000RPM HDDs	
	9.1GB P/N 37L7204	18.2GB P/N 37L7205 or 06P5754	36.4GB P/N 37L7206 or 06P5755	73.4GB P/N 06P5756	18.2GB P/N 19K0656 or 06P5767	36.4GB P/N 06P5768
0GB	0GB Standard on base models				0GB Standard on base models	
9.1GB	1	-	-	-	-	-
18.2GB	2 or	1	-	-	1	-
27.3GB	3	-	-	-	-	-
36.4GB	4 <sup>2</sup> or	2 or	1	-	2 or	1
45.5GB	5 <sup>2</sup>	-	-	-	-	-
54.6GB	6 <sup>2</sup> or	3	-	-	3	-
72.8GB	-	4 <sup>2</sup> or	2	-	4 <sup>2</sup> or	2
91GB	-	5 <sup>2</sup>	-	-	5 <sup>2</sup>	-
109.2GB	-	6 <sup>2</sup> or	3	-	6 <sup>2</sup> or	3
145.6GB	-	-	4 <sup>2</sup>	-	-	4 <sup>2</sup>
182GB	-	-	5 <sup>2</sup>	-	-	5 <sup>2</sup>
218.4GB	-	-	6 <sup>2</sup>	-	-	6 <sup>2</sup>
220.2GB	-	-	-	3	-	-
293.6GB	-	-	-	4 <sup>2</sup>	-	-
367GB	-	-	-	5 <sup>2</sup>	-	-
440.4GB <sup>2</sup>	-	-	-	6 <sup>2</sup>	-	-

This table does not represent all possible HDD configurations.

- Select a total storage row then identify the recommended HDDs from within an RPM range according to choice. Total Internal Storage listed is within ± 0.2 GB unless otherwise noted.
- Requires 3-Pack Ultra160 Hot-Swap Expansion Kit P/N 33L5050 to be installed.

Bay	Form Factor	Height	Front Access	Usage	Part Number	Description	RPM	Height	Bays Supported <sup>1</sup>	Max Qty <sup>1</sup>
-	89mm (3.5in)	-	Yes	Diskette	<b>Hot-Swap Ultra160 SCSI HDDs</b>					
-	133mm (5.25in)	-	Yes	IDE CD-ROM	37L7204	9.1GB 10K-4 Ultra160 Hot-Swap HDD	10000	SL	1 ... 6	6
1 ... 3	HS	SL	Yes	Open	37L7205	18.2GB 10K-4 Ultra160 Hot-Swap HDD	10000	SL	1 ... 6	6
A, B <sup>1</sup>	133mm (5.25in)	HH <sup>1</sup>	Yes	Open	06P5754	18.2GB 10,000rpm Ultra160 Hot-Swap HDD	10000	SL	1 ... 6	6
4 ... 6 <sup>2</sup>	HS	SL	Yes	Open	37L7206	36.4GB 10K-4 Ultra160 Hot-Swap HDD	10000	SL	1 ... 6	6
					06P5755	36.4GB 10,000rpm Ultra160 Hot-Swap HDD	10000	SL	1 ... 6	6
					06P5756	73.4GB 10,000rpm Ultra160 Hot-Swap HDD	10000	SL	1 ... 6	6
					06P5767	18.2GB 15,000rpm Ultra160 Hot-Swap HDD	15000	SL	1 ... 6	6
					19K0656	18.2GB 15,000rpm Ultra160 Hot-Swap HDD	15000	SL	1 ... 6	6
					06P5768	36.4GB 15,000rpm Ultra160 Hot-Swap HDD	15000	SL	1 ... 6	6

<sup>1</sup> Two half-high (HH) bays can be combined to support a single full-high (FH) device. By installing the 3-Pack Ultra160 Hot-Swap Expansion Kit P/N 33L5050, bays A and B are transformed into three SL hot-swap bays 4 ... 6.

<sup>2</sup> To enable bays 4 ... 6, optional 3-Pack Ultra160 Hot-Swap Expansion Kit P/N 33L5050 is required.

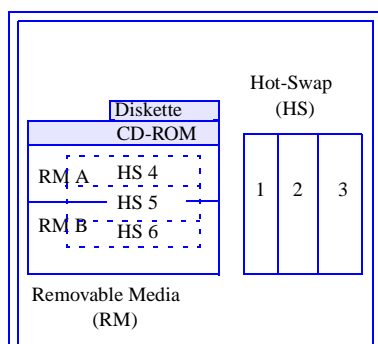

Associated Options					
33L5050	IBM 3-Pack Ultra160 Hot-Swap Expansion Kit <sup>2</sup>	-	3 x SL	4 ... 6	-
Optical Devices			Bays Supported		
10K3785	12x-8x-32x Black Internal CD-RW Drive <sup>3, 10</sup>	A, B			
22P6950	16X Max RAM-Read DVD-ROM Drive <sup>3, 4</sup>	A, B			
External Storage Expansion Units <sup>5</sup>			Form Factor		
19K11xx <sup>12</sup>	EXP300 Storage Expansion Unit <sup>6, 11</sup>	Rack (3U)			
19K11xx <sup>13</sup>	FAStT 200 Storage Server <sup>7, 8, 11</sup>	Rack (3U)			
19K11xx <sup>14</sup>	FAStT 200 HA Storage Server <sup>7, 11</sup>	Rack (3U)			
19K1121	FAStT200 Redundant RAID Controller <sup>8</sup>	-			
00N71xx <sup>15</sup>	FAStT EXP500 Storage Expansion Unit <sup>9, 11</sup>	Rack (3U)			
94G7448	Rack Power Cable Type C12 (3.7m) <sup>11</sup>	-			

1. xSeries 342 ships with Bays 1 ... 3 enabled. To enable installation of greater than three HDDs requires 3-Pack Ultra160 Hot-Swap Expansion Kit P/N 33L5050.

2. 3-Pack Ultra160 Hot-Swap Expansion Kit P/N 33L5050 includes a hot-swap backplane and associated components for two cabling options. The backplane may be cabled directly to the second integrated SCSI channel or be supported by the same SCSI channel as the standard backplane through the use of an included repeater card.

3. Install in one of the media bays, disconnecting power to the standard slim-line CD-ROM. Connect one end of the IDE cable included with the option to the IDE connector on the system board and the other end to the optical device. The middle connector on the cable may be used to connect a second optional optical device installed in the other media bay. Configure the first device as master using the preset configuration. If a second is installed, configure it as slave. The standard CD-ROM may not be used when an optional optical device is installed.

4. Audio not supported for DVD-ROM drives. The drive operates in video mode only.

5. To configure a SCSI storage device, select an optional SCSI controller then refer to Appendix D: Cables - Storage Units - Controllers to confirm the controller supports the desired External Storage Expansion Unit and to select a supported cable. For HDD or other expansion unit options, see the specific expansion unit section. For Fibre Channel storage devices, refer to the Fibre Channel Solutions Overview section.

6. The EXP300 includes a single 2 M Ultra2 SCSI cable and dual hot-swap 500W redundant power supplies, each with a standard country power cord.

7. The FAStT200 Storage Server and HA Storage Server each include two hot-swap, 350 W auto-ranging redundant power supplies each with it's own standard country power cord.

8. Can be upgraded to FAStT200 HA Storage Server through the addition of a FAStT200 Redundant RAID Controller P/N 19K1121.

9. The FAStT EXP500 Storage Expansion Unit P/N 00N71xx includes dual hot-swap 350W power supplies, each with it's own standard country power cord.

10. Some operating systems support the read function only.

11. These units do not include Rack Power Cables P/N 94G7448 when shipped (for attachment to high voltage UPS or PDU). Standard country power cords only are included. If required, order Rack Power Cables according to the number of power supplies.

12. Where 'xx' represents a specific country code as follows:- 51=US/English, 52=European/English, 56=Danish/English, 57=Israel/English, 58=Italian/English, 59=South Africa/English, 60=Swiss/English, 63=UK/English:- Line Cords/Publication Country Kits are included as indicated.

13. Where 'xx' represents a specific country code as follows:- 23=US/English, 24=Euro/English, 25=Euro/Spanish, 27=Euro/German, 28=Denmark/English, 29=Israel/English, 30=Italy/English, 31=South Africa/English, 32=Switzerland/English, 34=Switzerland/German, 36=UK/English. Country/Language - Line Cords/Publications are included as indicated

14. Where 'xx' represents a specific country code as follows:- 37=US/English, 38=Euro/English, 39=Euro/Spanish, 41=Euro/German, 42=Denmark/English, 43=Israel/English, 44=Italy/English, 45=South Africa/English, 46=Switzerland/English, 48=Switzerland/German, 50=UK/English. Country/Language - Line Cords/Publications are included as indicated.

15. Where 'xx' represents a specific country code as follows:- 36=US/English, 37=Euro/English, 41=Denmark/English, 42=Israel/English, 43=Italy/English, 44=South Africa/English, 45=Switzerland/English, 49=UK/English. Country/Language Line Cords/Publications are included as indicated.





**xSeries 342 I/O Options**

Part Number	Description	Adapter Length	PCI Support <sup>1</sup>	Slots Supported <sup>1,2</sup>
<b>Storage Controllers<sup>3</sup></b>				
37L6889	ServeRAID-4H Ultra160 SCSI Controller <sup>4</sup>	Full	64-bit	2 ... 5
06P5736	ServeRAID-4Mx Ultra160 SCSI Controller <sup>5</sup>	Full	64-bit	2 ... 5
06P5740	ServeRAID-4Lx Ultra160 SCSI Controller <sup>6</sup>	Half	64-bit	1 ... 5
19K4646	PCI Wide Ultra160 SCSI Adapter <sup>7</sup>	Half	32-bit	1 ... 5
02K3454	PCI Fast/Wide Ultra SCSI Adapter <sup>8</sup>	Half	32-bit	1 ... 5
<b>Fibre Storage Controllers and Options<sup>9</sup></b>				
00N6881	FASTT Host Adapter	Half	64-bit	1 ... 5
19K1246	FASTT FC-2 Host Bus Adapter	Half	64-bit	1 ... 5
<b>Networking<sup>10</sup></b>				
<b>Ethernet<sup>11</sup></b>				
06P3601	10/100 Ethernet Server Adapter <sup>12</sup>	Half	32-bit	1 ... 5
06P3701	Gigabit Ethernet SX Server Adapter (fibre optic cabling interface)	Half	64-bit	1 ... 5
09N9901	10/100 EtherLink Server Adapter by 3Com <sup>12</sup>	Half	32-bit	1 ... 5
22P4901	10/100 Dual Port Ethernet Server Adapter <sup>12</sup>	Half	64-bit	1 ... 5
22P6801	PRO/1000XT Server Adapter by Intel (with CD and manuals) <sup>12</sup>	Half	64-bit	1 ... 5
<b>Token Ring</b>				
34L5201	High-Speed 100/16/4 Token-Ring PCI Management Adapter <sup>12</sup>	Half	32-bit	1 ... 5
34L5001	16/4 Token-Ring PCI Management Adapter <sup>12</sup>	Half	32-bit	1 ... 5
<b>Communications<sup>13</sup></b>				
37L14xx	Serial I/O SST 8, 16 and 128 Port Adapters <sup>14</sup>	Half	32-bit	1...5 <sup>14</sup>
<b>Systems Management</b>				
09N75xx <sup>16</sup>	Remote Supervisor Adapter <sup>15</sup>	Half	32-bit	1 ... 5

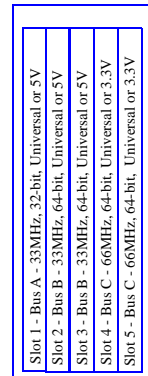

Exterior Connector Access

All Slots - Full Length

1. A 64-bit adapter installed into a 32-bit slot will transfer data at 32-bit rates. Adapters rated at 66MHz will operate at 33MHz when installed in a 33MHz slot. 33MHz adapters will reduce 66MHz buses to 33MHz. 133MHz PCI-X adapters are backward compatible with 33/66MHz, 64-bit PCI-based servers.

2. To avoid damage to internal cables, do not route cabling under a full-length PCI adapter.

3. xSeries 342 includes a dual-port, dual-channel Ultra160 SCSI controller for internal use only. No standard external port is available. See "Internal SCSI Cabling" for cabling alternatives. Due to xSeries 342 low profile, some adapters with connectors on the top edge may not have sufficient clearance to attach a cable. Cabling interferences are identified in the footnotes.

4. ServeRAID-4H Ultra160 SCSI Controller is powered by a 266MHz PowerPC 750 processor and provides four channels, 128MB of battery-backed ECC cache. The internal connectors are not accessible due to cabling interference. Four external Ultra160 0.8mm VHDCI connectors are available.

5. ServeRAID-4Mx Ultra160 SCSI Controller is powered by a 100MHz Intel Zion GC80303 processor that provides 64MB of battery-backed ECC cache and two internal and two external Ultra160 connections (only two connectors may be used). External connections are 0.8mm VHDCI.

6. ServeRAID-4Lx Ultra160 SCSI Controller is powered by a 100MHz Intel Zion GC80303 processor and provides a single channel, 32MB of ECC cache and either one internal or one external Ultra160 connection. External connector is 0.8mm VHDCI.

7. PCI Wide Ultra160 SCSI Adapter P/N 19K4646 provides a single channel with one internal connector, a five-drop multi-mode terminated LVD SCSI cable and one external 0.8mm VHDCI connector. Only one of the two connectors may be utilised.

8. PCI Fast/Wide Ultra SCSI Adapter provides one external 68-pin high density connector. The internal connectors are not accessible due to a cabling interference.

9. See Fibre Array Solutions section for additional configuration information.

10. xSeries 342 includes a full-duplex, 10/100Mbps Ethernet PCI controller.

11. In a fault-tolerant networking environment, using the fault-tolerant software delivered with the Ethernet adapters of a single manufacturer is recommended. Installing fault-tolerant solutions provided by multiple manufacturers may cause failures if the intermediate drivers provided with the adapters are not compatible. The onboard Ethernet is Intel-based, which is compatible with the Intel-based optional Ethernet adapters listed here: P/Ns 06P3601, 06P3701, 22P4901, 22P6801.

12. This server supports Wake on LAN or Alert-on-LAN functions through the integrated Ethernet controller only. These functions are not supported for optional PCI adapters.

13. xSeries 342 includes two USB ports and two serial ports.

14. See Appendix F for details of Serial I/O options and configuration limitations. A maximum of four Serial I/O adapters (in any combination) may be installed.

15. Disables the Integrated Systems Management processor when installed in xSeries 342 and provides full system management functionality through a customer-supplied Ethernet cable or modem connection or as part of an interconnected system management bus (option includes all interconnect hardware).

16. Where 'xx' represents a specific country code as follows:- 86=Europe, 87=Denmark, 88=South Africa, 89=UK, 90=Switzerland, 91=Italy, 92=Israel, 85=USA.



**xSeries 342 Power, Monitors, Accessories**

Part Number	Description
<b>Power<sup>1,9</sup></b>	
37L6879	270W Hot-Swap Redundant Power Supply <sup>1,9</sup>
94G7448	Rack Power Cable Type C12 (3.7m) <sup>9</sup>
<b>Uninterruptible Power Supply (UPS)<sup>2</sup></b>	
14RIxxx <sup>10</sup>	APC Smart-UPS 1400RMB <sup>3</sup>
32P16xx <sup>11</sup>	APC 2U Smart-UPS 1400RMiB <sup>5</sup>
30RIxxx <sup>10</sup>	APC Smart-UPS 3000RMB <sup>3</sup>
37L6862	APC Smart-UPS 5000RMB <sup>4</sup>
<b>Monitors<sup>6</sup></b>	
T3147xx <sup>12</sup>	E54 Color Monitor 15in (350mm, 13.8in Viewable Image Size), stealth black <sup>7</sup>
T3247xx <sup>12</sup>	E74 Color Monitor 17in (403mm, 15.9in Viewable Image Size), stealth black <sup>7</sup>
T274Axx <sup>12</sup>	G78 Color Monitor 17in (406.4mm, 16in Viewable Image Size), stealth black <sup>7</sup>
T11AGxx <sup>12</sup>	T540 Flat Panel Color Monitor 15in (381mm, 15in viewable image), stealth black <sup>8</sup>

1. xSeries 342 systems include a single 270W, hot-swap power supply and a single standard country power cord. Power supply redundancy can be achieved with the addition of optional 270W Hot-Swap Redundant Power Supply P/N 37L6879.
2. For runtimes and UPS attributes see Appendix C: UPS Runtime Estimate.
3. Height is 3U. See Rack Cabinets and Options section for supported IBM racks.
4. Height is 5U. See Rack Cabinets and Options section for supported IBM racks.
5. Height is 2U. See Rack Cabinets and Options section for supported IBM racks.
6. xSeries 342 uses an SVGA controller (S3 Savage4 chipset) with 8MB of video memory.
7. Installation within a rack requires optional Monitor Compartment (P/N 94G7444).
8. Installation within a rack requires optional Flat Panel Monitor Rack Mount Kit II P/N 37L6888 and Rack Keyboard Tray P/N 28L4707. A space saver keyboard may coexist within the same keyboard tray. See Rack Cabinets and Options section for more information.
9. Rack Power Cable P/N 94G7448 (one for each power supply), must be ordered for power connection to a high voltage UPS or PDU.
10. Where 'xxx' represents a specific country code as follows:- DEN=Denmark, ISR=Israel, ITA=Italy, SDI=Saudi Arabia, SAF=South Africa, SWS=Switzerland, UKM=United Kingdom, EUR=Europe.
11. Where 'xx' represents a specific country code as follows:- 12=Europe, 13=UK, 14=Italy, 15=Switzerland, 16=Denmark, 17=South Africa, 18=Israel.
12. Where 'xx' represents a specific country code as follows:- DK=Denmark, IS=Israel, IT=Italy, SD=Saudi Arabia, SA=South Africa, CH=Switzerland, UK=UK, EU=Europe.

Part Number	Description
<b>Rack and NetBAY<sup>1,6</sup></b>	
94G7448	Rack Power Cable Type C12 (3.7m) <sup>6</sup>
<b>NOTE:</b> Refer to the Rack Cabinets and Options section for details of IBM Racks and rack-supported devices.	
<b>Keyboard and Mouse<sup>2</sup></b>	
28L36xx <sup>7</sup>	Space Saver II Keyboard <sup>3,5</sup>
28L36xx <sup>8</sup>	Preferred Keyboard (stealth black) <sup>4</sup>
28L3675	Sleek 2-Button Stealth Black Mouse

1. xSeries 342 is housed in a 19in rack-mountable drawer and requires one of the racks listed in the Rack Cabinets and Options section.
2. xSeries 342 supports rack configurations only and ships without a mouse or keyboard.
3. Installation within a rack requires optional keyboard tray P/N 28L4707, which stows in ready-to-use position.
4. Installation within a rack requires optional keyboard tray P/N 28L4707. This keyboard cannot share a keyboard tray with a flat panel display.
5. Advanced TrackPoint IV features are not available on IBM xSeries systems.
6. The xSeries 342 ships with a standard country power cord. For connection to a high voltage UPS or PDU, a Rack Power Cable P/N 94G7448 (one for each power supply), must be ordered.
7. Where 'xx' represents a specific country code as follows:- 46=Danish, 47=France, 48=Germany, 49=Italian, 50=Spanish, 51=UK English, 44=US English, and P/N 19K3831=Switzerland, 19K3832=Sweden/Finland, 19K3833=Portugal, 19K3834=Belgium, 19K3836=Russia, 19K3837=Poland.
8. Where 'xx' represents a specific country code as follows:- 25=French, 26=German, 27=Italian, 29=UK English, 31=Danish, 33=Norwegian, 34=Swedish/Finnish, 35=Swiss, 36=Dutch, 21=US English, and P/N 22P7325=Belgium/UK, 22P7323=Icelandic.



**xSeries 342 Tape Options**

Part Number	Tape Drives	Bays Supported	SCSI Interface (bit)	Form Factor	Termination Included	68/50-pin Converter Incl	Ext Tape Enclosures
00N7991	20/40GB DDS/4 4mm Internal SCSI Tape Drive <sup>3</sup>	A, B	16 Ultra2 LVD	89mm (3.5in) HH or 133mm (5.25in) HH	N <sup>4</sup>	-	10L7440 <sup>2</sup> , 03K8756 <sup>1</sup>
09N4040	20/40GB DLT Internal SCSI Tape Drive	A+B	8	133mm (5.25in) FH	N <sup>4</sup>	Y	03K8756
00N7990	40/80GB DLT Internal SCSI Tape Drive <sup>3</sup>	A+B	16 Ultra2 LVD	133mm (5.25in) FH	N <sup>4</sup>	-	03K8756 <sup>1</sup>
00N8015	110/220GB Super DLT Internal SCSI Tape Drive <sup>3</sup>	A+B	16 Ultra2 LVD	133mm (5.25in) HH	N <sup>4</sup>	-	03K8756 <sup>1</sup>
00N8016	100/200GB LTO Internal SCSI Tape Drive <sup>3</sup>	A+B	16 Ultra2 LVD	133mm (5.25in) FH	N <sup>4</sup>	-	03K8756 <sup>1</sup>
24P2396	100/200GB LTO Internal SCSI HH Tape Drive <sup>3</sup>	A, B	16 Ultra2 LVD	133mm (5.25in) HH	N <sup>4</sup>	-	03K8756 <sup>1</sup>
24P2398	40/80GB Half-High DLT/VS Internal SCSI Tape Drive <sup>1</sup>	A, B	16 Ultra2 LVD	133mm (5.25in) HH	N <sup>4</sup>	-	03K8756 <sup>1</sup>
<b>Tape Autoloaders</b>							
00N7992	120/240GB DDS/4 Internal SCSI Tape Autoloader <sup>3</sup>	A+B	16 Ultra2 LVD	133mm (5.25in) FH	N <sup>4</sup>	-	03K8756 <sup>1</sup>
00N79xx <sup>9</sup>	DLT SCSI Tape Autoloader	-	16	Desktop	Y	-	-
<b>External Tape Libraries<sup>5</sup></b>							
00N79xx <sup>10</sup>	DLT SCSI Tape Library	-	16	Desktop or Rack	Y	-	-
<b>External Tape Enclosures</b>							
10L7440	External Half High SCSI Storage Enclosure <sup>6</sup>	-	8, 16	Desktop	N	N	-
03K8756	NetMEDIA Storage Expansion Unit EL <sup>7</sup>	-	16	Rack	Y	N	-
10L7113	NetMEDIA Systems Management Adapter <sup>8</sup>	-	16 LVD	-	N	N	03K8756
<b>Associated Options</b>							
10K2340	Media Bay Tray and LVD Cable Kit <sup>1, 2</sup>	-	16 LVD	Int	Y	N	03K8756
00N7956	68-pin External Multimode LVD/SE SCSI Terminator	-	16 LVD/SE	Ext	Y	N	10L7440

Note: xSeries 342 includes a single drop, 16-bit, single-ended, non-terminated non-LVD SCSI cable. All tape drives and enclosures are supported by PCI Wide Ultra160 SCSI Adapter P/N 19K4646 which has an external 0.8mm VHDCI connector.

1. LVD support for LVD devices installed in a NetMEDIA Storage Expansion Unit EL P/N 03K8756 requires replacement of the standard single-ended internal cables with one or more (depending on configuration) cables from Media Bay Tray and LVD Cable Kit P/N 10K2340 which contains a single two-drop multi-mode terminated cable. If the standard cables are used for attachment to LVD devices, single-ended SCSI rules and bus speeds apply.
2. Requires 68-pin External Multimode LVD/SE SCSI terminator P/N 00N7956.
3. LVD support for LVD devices requires installation of the 16-bit multi-mode terminated, two-drop, LVD SCSI cable included with optional Media Bay Tray and LVD Cable Kit P/N 10K2340.
4. Termination requires installation of the multi-mode terminated, two-drop, LVD SCSI cable included with optional Media Bay Tray and LVD Cable Kit P/N 10K2340.
5. Tape library attributes and prerequisites are located in Appendix B: Tape Library Attributes.
6. Provides a black desktop 133mm (5.25in) half-high (HH) tape enclosure. Connector is configurable as 50-pin Centronix or 68-pin high density. Requires either tape drive self-termination or 68-pin External Multimode LVD/SE SCSI Terminator (P/N 00N7956).
7. NetMEDIA Storage Expansion Unit EL P/N 03K8756 is a black 3U, 19in rack mountable tape enclosure which includes two full- high (FH) or four- half high (HH) extended length 133mm (5.25in) bays, two external 0.8mm VHDCI connectors and two internal four-drop single-ended terminated 16-bit SCSI cables for device attachment. Two power supplies and two power cords are also included. Tip: The front rail clips will need to be reversed and screwed in from behind to secure the unit in a Rack Cabinet P/N 930842x.
8. NetMEDIA Systems Management Adapter P/N 10L7113 may be installed in a NetMEDIA Storage Expansion Unit to provide repeater function, LVDS interface, aggregate cable lengths up to 12m when attached to an LVD SCSI controller, and auto-termination when the NetMEDIA is powered off. External connector is 0.8mm VHDCI.
9. Where 'xx' represents a country specific power cord code: 70=UK, 71=Swiss, 72=Italy, 73=Israel, 33L4981=EU1, 33L4982=Denmark, 33L4983=South Africa/India.
10. Where 'xx' represents a country specific power cord code: *Tower versions* - 74=EU1, 75=Denmark, 76=India/South Africa, 77=UK, 78=Swiss, 79=Italy, 80=Israel; *Rack versions* - 81=EU1, 82=Denmark, 83=India/South Africa, 84=UK, 85=Swiss, 86=Italy, 87=Israel.

Note: Additional tape attributes can be found in Appendix A: Tape Drive Attributes.

Note: For a complete list of all IBM and non-IBM options compatibility with Network Operating Systems and IBM xSeries Servers, access the IBM ServerProven compatibility pages on the Web at URL <http://www.ibm.com/pc/us/compat>



## xSeries 342 Sample Configurations

Note: The following sample configurations are for illustration only and may not be suitable for any specific customer installation. Contact your IBM Business Partner or IBM Marketing Representative for assistance with your specific configuration requirements.

### Internet Server

Part Number	Description	Quantity
K91RXxx	xSeries 342 1GHz/256KB Pentium III, 256MB ECC, Open, 24X (3U Rack)	1
33L3320	128MB PC133 ECC SDRAM RDIMM	2 <sup>1</sup>
06P5736	ServeRAID-4Mx Ultra160 SCSI Controller	1
37L7204	9.1GB 10K-4 Ultra160 SCSI Hot-Swap SL HDD	3 <sup>2</sup>
24P2396	100/200GB LTO Internal SCSI HH Tape Drive	1
10K2340	Media Bay Tray and LVD Cable Kit	1
T3147xx	E54 Color Monitor 15in (350mm, 13.8in viewable image), stealth black	1
14RIxxx	APC Smart-UPS 1400RMiB	1
37L6879	270W Hot-Swap Redundant Power Supply	1
<b>Industry Standard 19in Rack, EIA-310D, min depth of 28in (711mm)</b>		
9306250	NetBAY25 Standard Rack Cabinet	1
28L36xx	Space Saver II Keyboard	1
94G6670	Blank Filler Panel Kit	2

1. For a total of 512MB of system memory.

2. Three HDDs are used for RAID 5 protection. Effective capacity is two HDDs or 18.2GB.

An Internet server handles all requests from the Internet (Intranet or Extranet). Usually this type of server has the same characteristics as a file server. The main difference is that an Internet server uses a different protocol (TCP/IP vs NETBEUI or IPX/SPX) and often performs an additional security check (firewall). In the case of an Internet server, the server itself communicates primarily with only one client, the Internet Service Provider (ISP), instead of many clients as applies to a file server.

With this in mind, the xSeries 342 was selected to provide an affordable price point for the growing Internet server market. The system includes two-way Pentium III processing, 512MB of system memory (expandable to 4GB), power protection with an APC Smart-UPS and availability features such as RAID-protected internal hot-swap storage.

The network configuration depends on the method that will be used to connect the server to the Internet. Usually fast Ethernet routers are used, but if other methods are preferable, you can add the appropriate adapter. The configuration includes a tape back-up unit for secure storage of critical data in the event of a system or storage media failure.

### Application Server

Part Number	Description	Quantity
K92RXxx	xSeries 342 1.13GHz/512KB Pentium III, 256MB ECC, Open, 24X (3U Rack)	1
24P3512	xSeries 1.13GHz/133MHz 512KB Cache Upgrade with Pentium III Processor SVR	1
33L3322	256MB PC133 ECC SDRAM RDIMM	2 <sup>1</sup>
06P5736	ServeRAID-4Mx Ultra160 SCSI Controller	1
37L7205	18.2GB 10K-4 Ultra160 SCSI Hot-Swap SL HDD	3 <sup>2</sup>
24P2396	100/200GB LTO Internal SCSI HH Tape Drive	1
10K2340	Media Bay Tray and LVD Cable Kit	1
T3147xx	E54 Color Monitor 15in (350mm, 13.8in viewable image), stealth black	1
37L6879	270W Hot-Swap Redundant Power Supply	1
14RIxxx	APC Smart-UPS 1400RMB	1
<b>Industry Standard 19in Rack, EIA-310D, min depth of 28in (711mm)</b>		
9306250	NetBAY25 Standard Rack Cabinet	1
28L36xx	Space Saver II Keyboard	1
94G6670	Blank Filler Panel Kit	2

1. For a total of 768MB of system memory.

2. Three HDDs are used for RAID 5 protection. Effective capacity is two HDDs or 36.4GB.

An application server is designed to handle a high workload while providing application serving requirements for users. With this in mind, the xSeries 342 was selected to provide an affordable price point for an application server with two-way Pentium III processing, 768MB of system memory (expandable to 4GB), power protection with an APC Smart-UPS and availability features such as battery-backed cache RAID-protected internal hot-swap storage.





# IBM xSeries 350

Part Number  
 Withdrawal Date: ddmmyy  
 Processor Speed<sup>2</sup>  
 Number of Processors (Std./Max)  
 L2 ECC Cache (KB)  
 Memory (Std./Max) (R=RDIMM)<sup>3</sup>  
 Form Factor  
 Power Supply Quantity (Std./Max)  
 Hot-Swap (Power, HDD, Fans)  
 Redundancy (Optional, Standard)  
 Adv. System Management Processor  
 Onboard Ethernet (Dual, Ultra, RAID)  
 SCSI Controller (Dual, Ultra, RAID)  
 Removable Media Bays (Total/Avail)  
 Internal Hard Disk Drive (Std./Max)  
 CD-ROM (IDE)<sup>5</sup>  
 Bays: (Tot/Av) Slots(Tot/Av)

xSeries 350 At-A-Glance																		
K24RYxx <sup>1</sup>	-	700MHz	1/4	1024	512MB(R)/16GB	Rack(4U)	1/3	P, S, H,F	S-Fans O-Power <sup>4</sup>	Y	10/100	D,U160	2/0	0/220,2 GB <sup>7</sup>	48X-20X	5/3 <sup>6</sup>	6/6	
K25RYxx <sup>1</sup>	-	700MHz	1/4	2048	512MB(R)/16GB	Rack(4U)	1/3	P, S, H,F	S-Fans O-Power <sup>4</sup>	Y	10/100	D,U160	2/0	0/220,2 GB <sup>7</sup>	48X-20X	5/3 <sup>6</sup>	6/6	
K26RYxx <sup>1</sup>	-	900MHz	1/4	2048	512MB(R)/16GB	Rack(4U)	1/3	P, S, H,F	S-Fans O-Power <sup>4</sup>	Y	10/100	D,U160	2/0	0/220,2 GB <sup>7</sup>	48X-20X	5/3 <sup>6</sup>	6/6	

- Housed in a 19" Rack mountable drawer and ships standard without a keyboard or mouse. See Rack Cabinets and Options section for supported IBM racks.
- Intel Pentium III Xeon processor with integrated full speed ECC L2 cache and 100 MHz access to memory and I/O buses.
- Advanced Chipkill ECC memory corrects two-, three-, and four-bit memory errors.
- N+1 power supply redundancy requires a minimum of one optional 270 W Hot-Swap Redundant Power Supply P/N 37L6879. Robust configurations may require two. See 'Power' under Power, Monitors, Accessories for additional information.
- Variable read rate. Actual playback speed will vary and is often less than the maximum possible.
- xSeries 350 includes three hot-swap bays. Optional 3-Pack Ultra 160 Hot-Swap Expansion Kit P/N 33L5050 expands the hot-swap bays to six, giving bays total/available of 8/6 and allowing a maximum possible storage capacity of 440.4GB.
- The optional 3-Pack Ultra 160 Hot-Swap Expansion Kit P/N 33L5050 is available, which installs three additional hot-swap HDD bays, thereby doubling the internal hard disk drive capacity to 440.4GB.

## xSeries 350 Processor Upgrades

Part Number	Processor Upgrades Description	SMP Support <sup>1</sup>	Processor Speed Upgrade <sup>2</sup>
00N7946	700 MHz/1MB Upgrade with Pentium III Xeon Processor	21RYMxx, K24RYxx	-
00N7944	700 MHz/2MB Upgrade with Pentium III Xeon Processor	22RYMxx, K25RYxx	21RYMxx, K24RYxx
19K4633	900MHz/2MB Upgrade with Pentium III xeon Processor	K26RYxx	21RYMxx to K25RYxx

- Three additional processors may be installed, providing a maximum of four. All processors must be identical in type, speed, and cache size. Processors must be installed in numerical order from slot one to slot four.
- Requires removal of the standard processor. A maximum of four processors may be installed. All processors must be identical in type, speed and cache size. Upgrades may require a BIOS update. To obtain the latest Flash BIOS, access [www.ibm.com/pc/support](http://www.ibm.com/pc/support) and enter machine "Type-Model" in Quick Path. Select "Downloadable files" and then "BIOS".



## xSeries 350 Memory Configurator

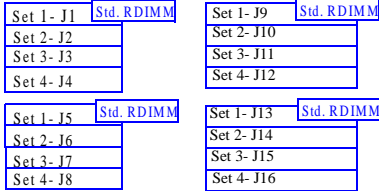

All RDIMMs installed in each set must be the same size, but all the sets do not have to contain RDIMMs of the same size. Install RDIMM sets in numerical sequence from 1 to 4.

Total Memory <sup>1</sup>	Quantity of RDIMMs Added <sup>2</sup>			
	128MB P/N 33L3113	256MB P/N 33L3115	512MB P/N 33L3117 or 33L3147 <sup>4</sup>	1GB P/N 33L3119
512MB	4 x 128 RDIMMs standard	-	-	-
1.0GB	4	-	-	-
1.5GB	-	4	-	-
2.0GB	4	4	-	-
2.5GB	-	8	-	-
3.0GB	4	-	4	-
4GB	4	4	4	-
5GB	4	-	8	-
6GB <sup>3</sup>	-	8	8	-
7GB <sup>3</sup>	-	4	12	-
8GB <sup>3</sup>	-	-	16	-
9GB	4	-	-	8
10GB <sup>3</sup>	-	-	12	4
12GB <sup>3</sup>	-	-	8	8
14GB <sup>3</sup>	-	-	4	12
16GB (max) <sup>3</sup>	-	-	-	16 <sup>3</sup>

Note: This table does not represent all possible memory configurations. Memory modules may vary in price per MB. Selection of smaller RDIMMs may provide a more cost-effective alternative to using larger RDIMMs.

1. Network operating systems may limit the maximum amount of addressable memory. See operating system specifications for further information.
2. To obtain the quantity of memory identified in the "Total Memory" column, select the appropriate row and order the quantity of RDIMMs identified in all columns for that row. Example: For 2.0 GB, order 4 x 33L3113 plus 4 x 33L3115.
3. Requires removal of standard RDIMMs.
4. Intermixing of RDIMM P/N 33L3117 and the RDIMMs contained within Kit P/N 33L3147 in the same bank (set of four), is not supported.

Part No.	Memory Description <sup>1</sup>
33L3113	128MB, 100MHz ECC SDRAM RDIMM
33L3115	256MB, 100MHz ECC SDRAM RDIMM
33L3117	512MB, 100MHz ECC SDRAM RDIMM
33L3119	1GB 100MHz ECC SDRAM RDIMM
33L3147	2GB 100MHz ECC SDRAM RDIMM KIT (4 x 512MB) <sup>2</sup>

1. Due to four-way interleaving all RDIMMs installed in each set must be the same size, but all the sets do not have to contain RDIMMs of the same size. Install RDIMM sets in numerical sequence from 1 to 4. Chipkill support is provided on the memory card.
2. Intermixing of the RDIMMs contained within Kit P/N 33L3147 and RDIMM P/N 33L3117 in the same bank (set of four) is not supported.

## xSeries 350 Internal SCSI Cabling

The xSeries 350 contains a DASD backplane supporting three hot-swap, SCA-2 compliant drive bays. The backplane is connected to one of the internal connectors of the integrated dual-channel Ultra160 SCSI controller through a 16-bit LVD SCSI cable. An optional 3-Pack Ultra160 Hot-Swap Expansion Kit P/N 33L5050 can be installed to provide additional internal HDD storage capacity. Within this option are two 16-bit LVD SCSI cables. One can be attached from the 3-Pack Ultra Hot-Swap backplane to the second connector of the dual-channel Ultra160 SCSI controller, the other, through the use of a repeater card included with the option, can be cabled directly to the standard backplane.

In configurations where external SCSI device attachment is required instead of additional internal HDD storage, a second 16-bit LVD SCSI cable is included with the server. One end of the cable can be attached to the second Ultra160 connector and the other is attached to the external 0.8-mm VHDCI connector on the back of the chassis. This provides an external connection to support LVDS devices.

**For additional information regarding internal cabling, refer to Appendix E: Internal Storage Cabling Overview.**

**xSeries 350 Internal Hard Disk Drive (HDD) and External Storage Configurator**

Total Int. Storage <sup>1</sup>	10,000RPM Ultra160 SCSI HDDs				15,000RPM Ultra160 SCSI HDDs	
	9.1GB P/N 37L7204	18.2GB P/N 37L7205 or 06P5754	36.4GB P/N 37L7206 or 06P5755	73.4GB P/N 06P5756	18.2GB P/N 19K0656 or 06P5767	36.4GB P/N 06P5768
0 GB	0GB Standard on Base Models				0GB Standard on Base Models	
9.1 GB	1	-	-	-	-	-
18.2 GB	2 or	1	-	-	1	-
27.3 GB	3	-	-	-	-	-
36.4 GB	4 <sup>2</sup> or	2 or	1	-	2 or	1
45.5 GB	5 <sup>2</sup>	-	-	-	-	-
54.6 GB	6 <sup>2</sup> or	3	-	-	3	-
72.8 GB	-	4 <sup>2</sup> or	2	-	4 <sup>2</sup> or	2
91 GB	-	5 <sup>2</sup>	-	-	5 <sup>2</sup>	-
109.2 GB	-	6 <sup>2</sup> or	3	-	6 <sup>2</sup> or	3
145.6GB	-	-	4 <sup>2</sup>	-	-	4 <sup>2</sup>
182GB	-	-	5 <sup>2</sup>	-	-	5 <sup>2</sup>
218.4GB	-	-	6 <sup>2</sup>	-	-	6 <sup>2</sup>
220.2GB	-	-	-	3	-	-
293.6GB	-	-	-	4 <sup>2</sup>	-	-
367.0GB	-	-	-	5 <sup>2</sup>	-	-
440.4GB	-	-	-	6 <sup>2</sup>	-	-

This table does not represent all possible hard disk drive (HDD) configurations.

1. Select a total storage row then identify the recommended HDDs from within an RPM range according to choice. Total Internal Storage listed is within ± 0.2 GB unless otherwise noted.

2. Requires installation of optional 3-Pack Ultra 160 Hot-Swap Expansion Kit P/N 33L5050.



Bay	Form Factor	Height	Front Access	Usage	Part Number	Description	RPM	Height	Bays Supported <sup>1,2</sup>	Max. Qty <sup>1</sup>
-	89 mm (3.5in)	SL	Yes	Diskette	<b>Hot-Swap Ultra160 SCSI HDDs</b>					
-	133 mm (5.25in)	HH	Yes	IDE CD-ROM	37L7204	9.1GB 10K-4 Ultra160 Hot-Swap HDD	10000	SL	1...6	6
1...3	HS	SL	Yes	Open	37L7205	18.2GB 10K-4 Ultra160 Hot-Swap HDD	10000	SL	1...6	6
4...6 <sup>1</sup>	HS	SL	Yes	Open	06P5754	18.2GB 10,000rpm Ultra160 Hot-Swap HDD	10000	SL	1...6	6
					37L7206	36.4GB 10K-4 Ultra160 Hot-Swap HDD	10000	SL	1...6	6
					06P5755	36.4GB 10,000rpm Ultra160 Hot-Swap HDD	10000	SL	1...6	6
					06P5756	73.4GB 10,000rpm Ultra160 Hot-Swap HDD	10000	SL	1...6	6
					06P5767	18.2GB 15,000rpm Ultra160 Hot-Swap HDD	15000	SL	1...6	6
					19K0656	18.2GB 15,000rpm Ultra160 Hot-Swap HDD	15000	SL	1...6	6
					06P5768	36.4GB 15,000rpm Ultra160 Hot-Swap HDD	15000	SL	1...6	6
<b>Associated Options</b>										
					33L5050	IBM 3-Pack Ultra160 Hot-Swap Expansion Kit <sup>1,2</sup>	-	3 x SL	4...6	-

1. To enable Bays 4...6, optional 3-Pack Ultra160 Hot-Swap Expansion Kit P/N 33L5050 is required.

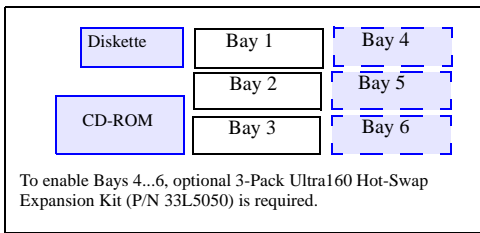

<b>External Storage Expansion Units<sup>3</sup></b>		<b>Form Factor</b>	
19K11xx <sup>9</sup>	EXP300 Storage Expansion Unit <sup>4,8</sup>	Rack (3U)	
19K11xx <sup>10</sup>	FASiT 200 Storage Server <sup>5,6,8</sup>	Rack (3U)	
19K11xx <sup>11</sup>	FASiT 200 HA Storage Server <sup>5,8</sup>	Rack (3U)	
19K1121	FASiT 200 Redundant RAID Controller <sup>6</sup>	-	
00N71xx <sup>12</sup>	FASiT EXP500 Storage Expansion Unit <sup>7,8</sup>	Rack (3U)	
94G7448	Rack Power Cable Type C12 (3.7m, 12 ft.) <sup>8</sup>	-	

- xSeries 350 ships with bays 1...3 enabled. To enable installation of greater than three HDDs requires 3-Pack Ultra160 Hot-Swap Expansion Kit P/N 33L5050.
- 3-Pack Ultra160 Hot-Swap Expansion Kit P/N 33L5050 includes a hot-swap backplane and associated components that allow two ways to connect the expansion backplane. Within the option kit are two 16-bit LVD SCSI cables. One can be attached from the 3-Pack Ultra160 Hot-Swap backplane to the second connector of the onboard dual-channel Ultra160 SCSI controller, creating two independent buses. (utilising the second channel will eliminate the possibility of attaching external devices to that channel.) Using the repeater card included with the option kit, the other cable can be connected to the standard backplane, creating a single bus with six hot-swap HDD bays. Install tip: Do not route cabling over a memory card. If necessary, the longer standard SCSI cable can be disconnected from the standard backplane and connected to the backplane included in the expansion kit. Then the LVD SCSI cable that comes with the expansion kit would be connected to the standard backplane. Cabling can be routed either over or under the fans.
- Not supported by the onboard external SCSI port. To configure one of the SCSI storage devices listed here, select an optional SCSI controller then refer to Appendix D: Cables - Storage Units - Controllers to confirm that the controller supports the desired External Storage Expansion Unit and to select a supported cable. For HDD or other expansion unit options, see the specific expansion unit section. For Fibre Channel storage devices, refer to the Fibre Channel Solutions Overview section.
- The EXP300 includes a single 2 M Ultra2 SCSI cable and dual hot-swap 500W redundant power supplies, each with it's own standard country power cord.
- The FASiT200 Storage Server and HA Storage Server each include two hot-swap, 350 W auto-ranging redundant power supplies each with it's own standard country power cord.
- Can be upgraded to a FASiT200 HA Storage Server through the addition of a FASiT200 Redundant RAID Controller P/N 19K1121.
- The FASiT EXP500 Storage Expansion Unit includes dual hot-swap 350W power supplies, each with it's own standard country power cord.
- These units do not include Rack Power Cables P/N 94G7448 when shipped (for attachment to high voltage UPS or PDU). Standard country power cords only are included. If required, order Rack Power Cables according to the number of power supplies.
- Where 'xx' represents a specific country code as follows:- 51=US/English, 52=European/English, 56=Danish/English, 57=Israel/English, 58=Italian/English, 59=South Africa/English, 60=Swiss/English, 63=UK/English:- Line Cords/Publication Country Kits are included as indicated.
- Where 'xx' represents a specific country code as follows:- 23=US/English, 24=Euro/English, 25=Euro/Spanish, 27=Euro/German, 28=Denmark/English, 29=Israel/English, 30=Italy/English, 31=South Africa/English, 32=Switzerland/English, 34=Switzerland/German, 36=UK/English. Country/Language - Line Cords/Publications are included as indicated
- Where 'xx' represents a specific country code as follows:- 37=US/English, 38=Euro/English, 39=Euro/Spanish, 41=Euro/German, 42=Denmark/English, 43=Israel/English, 44=Italy/English, 45=South Africa/English, 46=Switzerland/English, 48=Switzerland/German, 50=UK/English. Country/Language - Line Cords/Publications are included as indicated.
- Where 'xx' represents a specific country code as follows:- 36=US/English, 37=Euro/English, 41=Denmark/English, 42=Israel/English, 43=Italy/English, 44=South Africa/English, 45=Switzerland/English, 49=UK/English. Country/Language Line Cords/Publications are included as indicated.





**xSeries 350 I/O Options**

Part Number	Description	Adapter Length	PCI Support	Slots Supported <sup>1,2</sup>	Hot-Plug <sup>3</sup>	PCI Voltage Key	MHz
<b>SCSI Storage Controllers<sup>4</sup></b>							
37L6889	ServeRAID-4H Ultra160 SCSI Controller <sup>5</sup>	Full	64-bit	1...6	X	Universal	33
06P5736	ServeRAID-4Mx Ultra160 SCSI Controller <sup>6</sup>	Full	64-bit	1...6	X	Universal	66
06P5740	ServeRAID-4Lx Ultra160 SCSI Controller <sup>7</sup>	Half	64-bit	1...6	X	Universal	66
02K3454	PCI Fast/Wide Ultra SCSI Adapter <sup>8</sup>	Half	32-bit	1, 5, 6	-	5	33
19K4646	PCI Wide Ultra160 SCSI Adapter <sup>9</sup>	Half	32-bit	1...6	-	Universal	66
<b>Fibre Storage Controller<sup>10</sup></b>							
00N6881	FASiT Host Adapter	Half	64-bit	1...6	X	Universal	66
19K1246	FASiT FC-2 Host Bus Adapter	Half	64-bit	1...6	X	Universal	66
<b>Networking<sup>11</sup></b>							
<b>Ethernet<sup>12</sup></b>							
09N9901	10/100 EtherLink Server Adapter by 3Com <sup>13</sup>	Half	32-bit	1...6	X	Universal	33
06P3601	10/100 Ethernet Server Adapter <sup>13</sup>	Half	32-bit	1...6	X	Universal	33
06P3701	Gigabit Ethernet SX Server Adapter (fibre optic cabling interface)	Half	64-bit	1...6	X	Universal	66
22P4901	10/100 Dual Port Ethernet Server Adapter <sup>13</sup>	Half	64-bit	1...6	X	Universal	66
22P6801	PRO/1000XT Server Adapter by Intel (with CD and manuals) <sup>13</sup>	Half	64-bit	1...6	X	Universal	133
<b>Token Ring</b>							
34L0701	Token-Ring 16/4 PCI Adapter 2 with Wake on LAN <sup>13</sup>	Half	32-bit	1...6	X	Universal	33
34L5201	High-Speed 100/16/4 Token-Ring PCI Management Adapter <sup>13</sup>	Half	32-bit	1...6	X	Universal	33
<b>Communications<sup>14</sup></b>							
37L14xx	Serial I/O SST 8, 16, and 128 port adapters <sup>15</sup>	Half	32-bit	1, 5, 6 <sup>15</sup>	-	5	33
<b>Systems Management<sup>16</sup></b>							
36L96xx <sup>19</sup>	Advanced System Management PCI Adapter <sup>17, 18</sup>	Full	32-bit	1, 5, 6 <sup>18</sup>	-	5	33

1. The 5 V - 33 MHz slots support Universal or 5 V adapters. A universal voltage-66 MHz adapter plugged into these slots will operate at 33 MHz. The 3.3 V slots support universal or 3.3 V adapters. A universal voltage-33 MHz adapter plugged into these slots limits a 66 MHz PCI adapter installed on the same bus to 33 MHz.
2. A 64-bit adapter installed into a 32-bit slot will transfer data at 32-bit rates. Adapters rated at 66MHz will operate at 33MHz when installed in a 33MHz slot. 33MHz adapters will reduce 66MHz buses to 33MHz. 133MHz PCI-X adapters are backward compatible with 33/66MHz, 64-bit PCI-based servers.
3. All six slots are full length hot-plug capable using IBM's Active PCI technology. For Network Operating System support access URL [www.ibm.com/pc/us/compat](http://www.ibm.com/pc/us/compat).
4. xSeries 350 includes a dual-port, dual-channel Ultra160 SCSI controller. See "Internal SCSI Cabling" for cabling alternatives. Install tip: For RAID configurations, the RAID cable provided with the system is routed underneath the PCI adapters because there is not sufficient space between the case lid and the top of the optional adapters.
5. ServeRAID-4H Ultra160 SCSI controller is powered by a 266MHz PowerPC 750 processor and provides four channels, 128 MB of battery-backed ECC cache with two internal and up to four external Ultra160 connectors (a combination of four connectors may be utilised). External connectors are 0.8-mm VHDCI.
6. ServeRAID-4Mx Ultra160 SCSI Controller is powered by a 100MHz Intel Zion GC80303 processor that provides 64MB of battery-backed ECC cache and two internal and two external Ultra160 connections (only two connectors may be used). External connections are 0.8mm VHDCI.
7. ServeRAID-4Lx Ultra160 SCSI Controller is powered by a 100MHz Intel Zion GC80303 processor and provides a single channel, 32MB of ECC cache and either one internal or one external Ultra160 connection. External connector is 0.8mm VHDCI.
8. PCI Fast/Wide Ultra SCSI Adapter P/N 02K3454 provides one external 68-pin high density connector that supports external SCSI devices such as tape enclosures.
9. PCI Wide Ultra160 SCSI Adapter P/N 19K4646 provides a single channel with one internal connector and a five-drop multi-mode terminated LVD SCSI cable and one external 0.8-mm VHDCI connector. Only one of the two connectors may be utilised.
10. See Fibre Array Solutions section for additional configuration information.
11. xSeries 350 has an integrated 10/100 PCI Ethernet Controller.
12. In a fault-tolerant networking environment, using the fault-tolerant software delivered with the Ethernet adapters of a single manufacturer is recommended. Installing fault-tolerant solutions provided by multiple manufacturers may cause failures if the intermediate drivers provided with the adapters are not compatible. The onboard Ethernet is AMD-based. The optional PCI Ethernet adapters listed here are Intel-based: P/Ns 06P3601, 06P3701, 22P4901, 22P6801.
13. The Wake on LAN function of this option is not supported by this server.
14. xSeries 350 includes two USB ports, two serial and one parallel port.
15. See Appendix F for details on Serial I/O options and configuration limitations. A maximum of four Serial I/O adapters (in any combination) may be installed.
16. The Advanced System Management Processor and Interconnect Bus integrated into xSeries 350 works with Netfinity Director to provide significant system management function when used either with optional Advanced System Management PCI Adapter P/N 36L96xx or when connected directly into an interconnect network using the integrated RS-485 ports located on the rear of the system chassis. Additional management and control of up to 12 service processors or optional adapters from a remote console through a single modem or LAN connection is possible.
17. Includes PCI adapter, Advanced System Management Interconnect Cable Kit components and 56-watt AC adapter which requires a separate power source. Provides an integrated 10/100 Ethernet port.
18. A maximum quantity of one is supported.
19. Where 'xx' represents a specific country code as follows:- 57=Denmark, 58=South Africa/India, 59=UK, 60=Switzerland, 61=Italy, 62=Israel, 01K7310=Europe, 01K7209=US/Saudi Arabia.



### xSeries 350 Power, Monitors, Accessories

Part Number	Description
<b>Power<sup>1, 10</sup></b>	
37L6879	270 W Hot-Swap Redundant Power Supply <sup>1, 2, 10</sup>
94G7448	Rack Power Cable Type C12 (3.7m, 12ft.) <sup>10</sup>
<b>Uninterruptible Power Supply (UPS)<sup>3</sup></b>	
14RIxxx <sup>11</sup>	APC Smart-UPS 1400RMiB <sup>4</sup>
32P16xx <sup>12</sup>	APC 2U Smart-UPS 1400RMiB <sup>6</sup>
30RIxxx <sup>11</sup>	APC Smart-UPS 3000RMiB <sup>4</sup>
37L6862	APC Smart-UPS 5000RMiB <sup>5</sup>
<b>Monitors<sup>7</sup></b>	
T3147xx <sup>13</sup>	E54 Color Monitor 15in (350mm, 13.8in Viewable Image Size), stealth black <sup>8</sup>
T3247xx <sup>13</sup>	E74 Color Monitor 17in (403mm, 15.9in Viewable Image Size), stealth black <sup>8</sup>
T274Axx <sup>13</sup>	G78 Color Monitor 17in (406.4mm, 16.0in Viewable Image Size), stealth black <sup>8</sup>
T11AGxx <sup>13</sup>	T540 Flat Panel Color Monitor 15in (381mm, 15in viewable image), stealth black <sup>9</sup>

1. xSeries 350 systems include a single 270W, hot-swap power supply with a standard country power cord. N+1 power supply redundancy may be achieved with the addition of an optional 270W Hot-Swap Redundant Power Supply P/N 37L6879. Redundancy for configurations of greater than 270W requires installation of a second optional power supply i.e a total of three 270W power supplies. To assist in determining when an additional power supply is required to preserve redundancy, a "Non-Redundant LED" is a standard feature of the xSeries 350.

The following table is provided as an example. The table shows the maximum configuration that can be supported by a single 270W power supply. Any additional power draw would require another 270W power supply. Redundancy for the configuration displayed requires a second 270W power supply.

Number of Power Supplies	System Configuration Supported
	<b>Non-Redundant</b>
	Up to two processors
1	Up to three PCI adapters
	Up to three HDDs
	Up to eight memory RDIMMs

2. 270 W Hot-Swap Redundant Power Supply P/N 37L6879 includes a single standard country power cord.

3. For runtimes and UPS attributes see Appendix C: UPS Runtime Estimate.

4. Height is 3U. See Rack Cabinets and Options section for supported IBM racks.

5. Height is 5U. See Rack Cabinets and Options section for supported IBM racks.

6. Height is 2U. See Rack Cabinets and Options section for supported IBM racks.

7. xSeries 350 uses an SVGA controller (S3 Savage4 chipset) with 8 MB of video memory.

8. Installation within a rack requires optional Monitor Compartment P/N 94G7444.

9. Installation within a rack requires optional Flat Panel Monitor Rack Mount Kit P/N 37L6888 and Rack Keyboard Tray P/N 28L4707. A space saver keyboard may coexist within the same keyboard tray. See Rack Cabinets and Options section for more information.

10. Rack Power Cable P/N 94G7448 (one for each power supply), must be ordered for power connection to a high voltage UPS or PDU.

11. Where 'xxx' represents a specific country code as follows:- DEN=Denmark, ISR=Israel, ITA=Italy, SDI=Saudi Arabia, SAF=South Africa, SWS=Switzerland, UKM=United Kingdom, EUR=Europe.

12. Where 'xx' represents a specific country code as follows:- 12=Europe, 13=UK, 14=Italy, 15=Switzerland, 16=Denmark, 17=South Africa, 18=Israel.

13. Where 'xx' represents a specific country code as follows:- DK=Denmark, IS=Israel, IT=Italy, SD=Saudi Arabia, SA=South Africa, CH=Switzerland, UK=UK, EU=Europe.



Part Number	Description
<b>Rack and NetBAY<sup>1,6</sup></b>	
94G7448	Rack Power Cable Type C12 (3.7m) <sup>6</sup>
<b>NOTE:</b> Refer to the Rack Cabinets and Options section for details of IBM Racks and rack-supported devices.	
<b>Keyboard and Mouse<sup>2</sup></b>	
28L36xx <sup>7</sup>	Space Saver II Keyboard <sup>3,4</sup>
28L36xx <sup>8</sup>	Preferred Keyboard (stealth black) <sup>5</sup>
28L3675	Sleek 2-Button Stealth Black Mouse

- xSeries 350 is housed in a 19" rack mountable drawer and requires one of the racks listed in the Rack Cabinets and Options section.
- xSeries 350 supports rack configurations only and ships without a keyboard or mouse.
- Installation within a rack requires optional keyboard tray P/N 28L4707 (stows in "ready-to-use" position).
- Advanced TrackPoint IV features are not available on IBM xSeries systems.
- Installation within a rack requires optional keyboard tray P/N 28L4707. This keyboard cannot share a keyboard tray with a flat panel display.
- The xSeries 350 ships with a standard country power cord. For connection to a high voltage UPS or PDU, a Rack Power Cable P/N 94G7448 (one for each power supply), must be ordered.
- Where 'xx' represents a specific country code as follows:- 46=Danish, 47=France, 48=Germany, 49=Italian, 50=Spanish, 51=UK English, 44=US English, and P/N 19K3831=Switzerland, 19K3832=Sweden/Finland, 19K3833=Portugal, 19K3834=Belgium, 19K3836=Russia, 19K3837=Poland.
- Where 'xx' represents a specific country code as follows:- 25=French, 26=German, 27=Italian, 29=UK English, 31=Danish, 33=Norwegian, 34=Swedish/Finnish, 35=Swiss, 36=Dutch, 21=US English, and P/N 22P7325=Belgium/UK, 22P7323=Icelandic.

### xSeries 350 Tape Options

Part Number	Tape Drives	Bays Supported <sup>1</sup>	SCSI Interface (bit)	Form Factor	Termination Included	68/50-pin Converter Incl.	Ext. Tape Enclosures
00N7991	20/40GB DDS/4 4mm SCSI Tape Drive	-	16 Ultra2 LVD	89mm (3.5in) HH or 133mm (5.25in) HH	N	-	03K8756 <sup>2</sup>
09N4040	20/40GB DLT SCSI Tape Drive	-	8	133mm (5.25in) FH	N	Y	03K8756
00N7990	40/80GB DLT SCSI Tape Drive	-	16 Ultra2 LVD	133mm (5.25in) FH	N	-	03K8756 <sup>2</sup>
00N8016	100/200GB LTO SCSI Tape Drive	-	16 Ultra2 LVD	133mm (5.25in) FH	N	-	03K8756 <sup>2</sup>
00N8015	110/220GB Super DLT Internal SCSI Tape Drive	-	16 Ultra2 LVD	133mm (5.25in) FH	N	-	03K8756 <sup>2</sup>
24P2396	100/200GB LTO SCSI HH Tape Drive	-	16 Ultra2 LVD	133mm (5.25in) HH	N	-	03K8756 <sup>2</sup>
24P2398	40/80GB Half-High DLT/VS Internal SCSI Tape Drive	-	16 Ultra2 LVD	133mm (5.25in) HH	N	-	03K8756 <sup>2</sup>
<b>Tape Autoloaders</b>							
00N79xx <sup>9</sup>	DLT SCSI Tape Autoloader	-	16	Desktop	Y	-	-
00N7992	120/240GB DDS/4 SCSI Tape Autoloader	-	16 Ultra2 LVD	133mm (5.25in) FH	N	-	03K8756 <sup>2</sup>
09N40xx <sup>10</sup>	3600 Series 900GB/1.8TB LTO SCSI Tape Autoloader <sup>3</sup>	-	16 Ultra2 LVD	Tower or 6U Rack	Y	-	-
<b>External Tape Libraries<sup>4</sup></b>							
00N79xx <sup>11</sup>	DLT SCSI Tape Library	-	16	Rack	Y	-	-
21P99xx <sup>12</sup>	3600 Series 2/4TB LTO SCSI Tape Library (Tower)	-	16 Ultra2 LVD	Tower	Y	-	-
21P99xx <sup>12</sup>	3600 Series 2/4TB LTO SCSI Tape Library (Rack)	-	16 Ultra2 LVD	5U Rack	Y	-	-
21P99xx <sup>13</sup>	3600 Series 2-Drive, 20-Cartridge Expander Module <sup>5</sup>	-	16 Ultra2 LVD	5U Rack	Y	-	-
09N4048	3600 Series LTO Drive Upgrade Option <sup>6</sup>	-	16 Ultra2 LVD	-	N	-	-
<b>External Tape Enclosures</b>							
03K8756	NetMEDIA Storage Expansion Unit EL <sup>7</sup>	-	16	Rack	Y	N	-
10L7113	NetMEDIA Systems Management Adapter <sup>8</sup>	-	16 LVD	-	N	N	03K8756
<b>Associated Options</b>							
10K2340	Media Bay Tray and LVD Cable Kit <sup>7</sup>	-	16 LVD	Int.	Y	N	03K8756

- xSeries 350 does not support internal tape drives. An external tape or tape enclosure must be used. If not used internally, the second integrated Ultra160 connector may be routed to an external 0.8-mm VHDCI connector with a cable included with the server. All tape drives and enclosures are supported by PCI Wide Ultra160 SCSI Adapter P/N 19K4646 which has an external 0.8-mm VHDCI connector. Select tape drive, enclosure and controller then use Appendix D: Cables-Storage Units-Controllers to select an appropriate external cable.
- LVD support for LVD devices installed in a NetMEDIA Storage Expansion Unit EL P/N 03K8756 requires replacement of the standard single-ended internal cables with one or more (depending on configuration) cables from Media Bay Tray and LVD Cable Kit P/N 10K2340 which contains a single two-drop multi-mode LVD-SCSI terminated cable. If the standard cables are used for attachment to LVD devices, single-ended SCSI rules and bus speeds apply.
- If installed in a rack, a fixed shelf is required. Allow an additional 1U for the fixed shelf. One unit only per shelf is supported.
- Tape library attributes and prerequisites are located in Appendix B: Tape Library Attributes.
- Supported only with the 3600 Series LTO Tape Library (Rack) P/N 21P99xx. One additional EIA space has to be allowed when installing either one or two units (maximum) - to accommodate a filler plate for cable routing. Up to two 3600 Series LTO Drive Upgrade Options can be installed in each module or the module can operate off the LTO drives installed in the LTO tape library.
- Install in second drive bay of 3600 Series LTO Tape Libraries or in either of the two bays of 3600 Series 2-drive, 20-cartridge Expander Module to increase performance. Includes an LTO (Ultrium) drive and a one-meter external LVD SCSI cable.
- NetMEDIA Storage Expansion Unit EL P/N 03K8756 is a black 3U, 19" rack-mountable tape enclosure which includes two full high (FH) or four half high (HH) extended length 133 mm (5.25") bays, two external 0.8-mm VHDCI connectors and two internal four-drop single-ended terminated 16-bit SCSI cables for device attachment. Two power supplies and two power cords are also included. Tip: The front rail clips will need to be reversed and screwed in from behind to secure the unit in a Rack Cabinet P/N 930842x.
- NetMEDIA Systems Management Adapter P/N 10L7113 may be installed in a NetMEDIA Storage Expansion Unit to provide repeater function, LVDS interface, aggregate cable lengths up to 12 meters when attached to an LVD SCSI controller, and auto-termination when the Expansion Unit is powered off. External connector is 0.8-mm VHDCI.
- Where 'xx' represents a country specific power cord code: 70=UK, 71=Swiss, 72=Italy, 73=Israel, 73L4981=EU1, 33L4982=Denmark, 33L4983=South Africa/India.
- Where 'xx' represents a specific country code as follows:- 49=UK, 50=Europe, 51=Denmark, 52=South Africa, 53=Switzerland, 54=Italy, 55=Israel.
- Where 'xx' represents a specific country code as follows:- *Rack version* - 81=EU1, 82=Denmark, 83=India/South Africa, 84=UK, 85=Swiss, 86=Italy, 87=Israel.
- Where 'xx' represents a specific country code as follows:- *Tower version* - 71=Europe, 72=Denmark, 73=South Africa, 70=UK, 74=Swiss, 75=Italy, 76=Israel: *Rack version* - 78=Europe, 79=Denmark, 80=South Africa, 77=UK, 81=Swiss, 82=Italy, 83=Israel.
- Where 'xx' represents a specific country code as follows:- 85=Europe, 86=Denmark, 87=South Africa, 84=UK, 88=Swiss, 89=Italy, 90=Israel.

**Note:** Additional tape details can be found in Appendix A: Tape Drive Attributes.

Note: For a complete list of all IBM and non-IBM options compatibility with Network Operating Systems and IBM xSeries and Netfinity Servers, access the IBM ServerProven compatibility pages on the Web at URL <http://www.ibm.com/pc/us/compat>

To access IBM information specific to your country via the World Wide Web, use address: <http://www.ibm.com/pc>



## xSeries 350 Sample Configurations

Note: The following sample configurations are for illustration only and may not be suitable for any specific customer installation. Contact your IBM Business Partner or IBM Marketing Representative for assistance with your specific configuration requirements.

### Internet Server

Part Number	Description	Quantity
K24RYxx	xSeries 350 700/1MB Xeon, 512MB ECC, Open, 40X, PCI	1
06P5740	ServeRAID-4Lx Ultra160 SCSI Controller	1
33L5050	3-Pack Ultra160 Hot-Swap Expansion Kit	1
37L7204	9.1GB 10K-4 Ultra160 SCSI Hot-Swap SL HDD	4 <sup>1</sup>
24P2396	100/200GB LTO Internal SCSI HH Tape Drive	1 <sup>2</sup>
10K2340	Media Bay Tray and LVD Cable Kit	1
03K8756	NetMEDIA Storage Expansion Unit EL	1
03K9310	2m Ultra2 SCSI Cable	1
T3147xx	E54 Color Monitor 15in (350mm, 13.8in Viewable Image Size), stealth black	1
14RIxxx	APC Smart-UPS 1400RMB	1
<b>Industry Standard 19" Rack, EIA-310D, min. depth of 28" (711 mm)</b>		
9306200	NetBAY22™	1
28L36xx	Space Saver II Keyboard	1
94G6670	Blank Filler Panel Kit	2

1. Four HDDs are used for RAID 5 protection. One HDD is identified as a hot-spare. Effective storage capacity is two HDDs or 18.2GB
2. Installs in the external enclosure P/N 03K8756

An Internet server handles all requests from the Internet (intranet or extranet). Usually, this type of server has the same characteristics as a file server. The main difference is that an internet server talks a different language (TCP/IP vs. NETBEUI or IPX/SPX) and often needs to do an extra security check (firewall). In the case of an Internet server, the server itself talks mostly to one client, the Internet Service Provider (ISP), instead of many clients as a file server does.

With this in mind, the IBM xSeries 350 was selected to provide an affordable price point for the growing internet server market, featuring 512MB of system memory (expandable to 16GB), availability features such as RAID protected internal hot-swap storage and power protection with an APC Smart-UPS.

The network configuration depends on the method that will be used to connect the server to the Internet. Usually fast Ethernet routers are used, but if other methods are used, you can add the appropriate adapter. The configuration includes a tape backup unit for secure backup of critical data in the event of a system or storage failure.

### Application Server

Part Number	Description	Quantity
K25RYxx	xSeries 350 700/2MB Xeon, 512MB ECC, Open, 40X, PCI	1
00N7944	700 MHz/2MB Upgrade with Pentium III Xeon Processor	3
33L3113	128MB, 100MHz ECC SDRAM RDIMM	4 <sup>1</sup>
33L3115	256MB, 100MHz ECC SDRAM RDIMM	4 <sup>1</sup>
33L5050	3-Pack Ultra160 Hot-Swap Expansion Kit	1
37L7206	36.4GB 10K-4 Ultra160 SCSI Hot-Swap SL HDD	4 <sup>2</sup>
06P5736	ServeRAID-4Mx Ultra160 SCSI Controller	1
00N7990	40/80GB DLT Internal SCSI Tape Drive	1 <sup>3</sup>
10K2340	Media Bay Tray and LVD Cable Kit	1
03K8756	NetMEDIA Storage Expansion Unit EL	1
10L7113	NetMEDIA Systems Management Adapter	1
03K9310	2m Ultra2 SCSI Cable	1
T3147xx	E54 Color Monitor 15in (350mm, 13.8in Viewable Image Size), stealth black	1
14RIxxx	APC Smart-UPS 1400RMB	1
37L6879	270W Hot-Swap Redundant Power Supply	2
<b>Industry Standard 19" Rack, EIA-310D, min. depth of 28" (711 mm)</b>		
9306200	NetBAY22	1
28L36xx	Space Saver II Keyboard	1
94G6670	Blank Filler Panel Kit	2

1. For a total of 2 GB of system memory.
2. Four HDDs are used for RAID 5 protection. Effective storage capacity is three HDDs or 109.2GB
3. Installs in the external enclosure P/N 03K8756

An application server is designed to handle a high workload while providing application serving requirements for users. With this in mind, the IBM xSeries 350 was selected to provide an affordable price point for an application server, with four-way Pentium III Xeon processing, 2GB of system memory (expandable to 16GB), and availability features such as battery-backed cache RAID protected internal hot-swap storage and power protection with an APC Smart-UPS.



# IBM xSeries 360

Part Number  
 Withdrawal Date: ddmmyy  
 Processor Speed<sup>2</sup>  
 Number of Processors (Std/Max)  
 L3 ECC Cache  
 Memory (Std/Max)  
 Form Factor  
 Power Supply Quantity (Std/Max)  
 Hot-Swap (Power, Slots, HDD, Fans)  
 Redundancy (Optional, Standard)  
 Adv System Management Processor<sup>5</sup>  
 Onboard Ethernet (Mbps)  
 SCSI Controller (Dual, Ultra, RAID)  
 Removable Media Bays (Total/Avail)  
 Internal Hard Disk Drive (IDE)<sup>7</sup>  
 Bays (Total/Avail)  
 Slots(Tot/Av)

xSeries 360 At-A-Glance Chart																	
K62RXxx <sup>1</sup>	-	1.5GHz	2/4	512KB	2GB/8GB <sup>3</sup>	Rack (3U)	2/3	P, S, H, F	S - Power <sup>4</sup> S - Fans	Y	10/100	U160	-	72.8GB/ 220.2GB <sup>6</sup>	24X- 10X	5/1	6/6 <sup>8</sup>
K63RXxx <sup>1</sup>	-	1.6GHz	2/4	1MB	2GB/8GB <sup>3</sup>	Rack (3U)	2/3	P, S, H, F	S - Power <sup>4</sup> S - Fans	Y	10/100	U160	-	72.8GB/ 220.2GB <sup>6</sup>	24X- 10X	5/1	6/6 <sup>8</sup>

- Housed in a 19in rack-mountable drawer and ships standard without a keyboard or mouse. See Rack Cabinets and Options section for supported IBM racks. Supports the Integrated xSeries Adapter (IXA) for direct attachment to iSeries systems.
- Intel Xeon MP processor with integrated full-speed ECC L3 cache and 4x100MHz (quad-pumped) access to memory and I/O buses.
- Advanced Chipkill ECC memory corrects two-, three-, and four-bit memory errors.
- N+1 power supply redundancy is provided standard. One optional 370W Hot-Swap Redundant Power Supply P/N 32P15xx is available for maximum configurations. See the Power Monitors, Accessories section for additional information.
- Advanced system management is provided by a standard Remote Supervisor Adapter installed in a dedicated PCI slot, which allows six optional PCI adapters to be installed.
- Two 36.4GB 10,000rpm hot-swap HDDs are standard (installed in bays four and five). Maximum HDD storage requires replacing the two standard HDDs with 73.4GB hot-swap HDDs and adding one additional 73.4GB HDD.
- Variable read rate. Actual playback speed will vary and is often less than the maximum possible.
- Support for an additional 12 64-bit slots available through installation of the optional RXE-100 Remote Expansion Unit (one unit only supported by xSeries 360).

## xSeries 360 Processor Upgrades

Part Number	Processor Upgrades	SMP Support <sup>1</sup>	Processor Speed Upgrade <sup>2</sup>
19K4639	xSeries 1.5GHz/512KB L3 Cache Upgrade with Xeon Processor MP	K62RXxx	-
19K4647	xSeries 1.6GHz/1MB L3 Cache Upgrade with Xeon Processor MP	K63RXxx	K62RXxx

- Two additional processors may be installed, providing a maximum of four. All processors must be identical in type, speed and cache size. Install processors in the order indicated in the diagram below.
- Requires removal of the standard processors. A maximum of four processors can be installed. All processors must be identical in type, speed and cache size. Upgrades may require a BIOS update. To obtain the latest Flash BIOS, access [www.pc.ibm.com/support](http://www.pc.ibm.com/support) and enter machine "Type-Model" in Quick Path. Select "Downloadable files" then "BIOS."

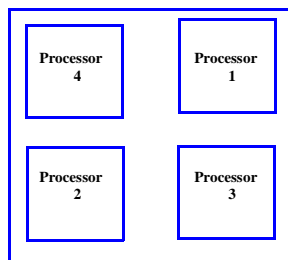



### xSeries 360 Memory Configurator

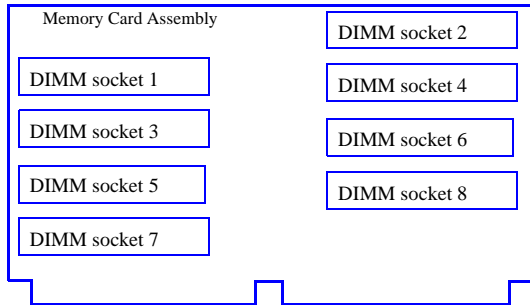

Total Memory <sup>1</sup>	Quantity of RDIMMs Added <sup>2</sup>	
	512MB P/N 33L3283	1GB P/N 33L3285
2GB	4 x 512MB RDIMMs standard	
3GB	2	-
4GB	4	-
5GB	2 and	2
6GB	-	4
7GB <sup>3</sup>	-	6
8GB (max) <sup>3</sup>	-	8

This table does not represent all possible memory configurations. Memory modules may vary in price per MB. Selection of smaller RDIMMs may provide a more cost-effective alternative to using larger RDIMMs.

1. Network operating systems may limit the maximum amount of addressable memory. See operating system specifications for further information.
2. To obtain the quantity of memory identified in the "Total Memory" column, select the appropriate row and order the quantity of RDIMMs identified in all columns for that row. Only installation in pairs is supported.
3. Requires removal of two or more standard RDIMMs.

Part Number	Memory Description <sup>1</sup>
33L3281	256MB PC 1600 ECC DDR SDRAM RDIMM
33L3283	512MB PC1600 ECC DDR SDRAM RDIMM
33L3285	1GB PC1600 ECC DDR SDRAM RDIMM

1. Due to two-way interleaving, all RDIMMs must be installed in pairs in the order indicated by the diagram. Chipkill support is provided on the memory card. Only installation in pairs is supported. The order of installation in pairs is sockets one and two, three and four, five and six, and seven and eight.

### xSeries 360 Internal SCSI Cabling

xSeries 360 contains five front-accessible drive bays located on the right side of the server. The top two bays contain the standard slim-line CD-ROM and 1.44MB slim-line diskette drive. Three 3.5in slim-line, hot-swap drive bays are located beneath them. The IDE CD-ROM is docked to a media interposer card that is cabled to the lightpath card before terminating at the system planar. The three SCA2-compliant hot-swap bays attach to a hot-swap backplane that connects to the integrated single-channel Ultra160 controller through an integrated bus. For RAID configurations, a cable provided with the system is connected to one of the internal connectors of the RAID controller and the other end of the cable is attached to a connector that supports the hot-swap HDD backplane, located on the planar between slot one and the memory card, beneath the memory options.

**For additional information regarding internal cabling, refer to Appendix E: Internal Storage Cabling Overview.**



**xSeries 360 Internal Hard Disk Drive (HDD) and External Storage Configurator**

Total Int Storage <sup>1</sup>	10,000RPM HDDs			15,000RPM HDDs	
	18.2GB P/N 37L7205 or 06P5754	36.4GB P/N 37L7206 or 06P5755	73.4GB P/N 06P5756	18.2GB P/N 19K0656 or 06P5767	36.4GB P/N 06P5768
72.8GB	2 x 36.4GB 10,000rpm hot-swap HDDs standard on base models <sup>2</sup>				
91GB	1 or	-	-	1	-
109.2GB	-	1	-	-	1
146.2GB	-	-	1	-	-
183.2GB <sup>3</sup>	-	-	2 <sup>3</sup>	-	-
220.2GB max <sup>3</sup>	-	-	3 <sup>3</sup>	-	-

This table does not represent all possible HDD configurations.

1. Select a total storage row then add the quantity of HDDs from all columns to the standard HDDs. Total Internal Storage listed is within +/- 0.2GB unless otherwise noted.

2. Standard HDDs installed in bays four and five.

3. Requires replacing one or both of the standard HDDs.

Bay	Form Factor	Height	Front Access	Usage	Part Number	Description	RPM	Height	Bays Supported <sup>1</sup>	Max Qty
1	89mm (3.5in)	SL	Yes	Diskette	<b>Hot-Swap Ultra160 SCSI HDDs</b>					
2	133mm (5.25in)	SL	Yes	IDE CD-ROM	37L7205	18.2GB 10K-4 Ultra160 Hot-Swap HDD	10000	SL	3 ... 5	3
3	HS	SL	Yes	Open	06P5754	18.2GB 10,000rpm Ultra160 Hot-Swap HDD	10000	SL	3 ... 5	3
4, 5	HS	SL	Yes	HDD <sup>1</sup>	37L7206	36.4GB 10K-4 Ultra160 Hot-Swap HDD	10000	SL	3 ... 5	3
					06P5755	36.4GB 10,000rpm Ultra160 Hot-Swap HDD	10000	SL	3 ... 5	3
					06P5756	73.4GB 10,000rpm Ultra160 Hot-Swap HDD	10000	SL	3 ... 5	3
					06P5767	18.2GB 15,000rpm Ultra160 Hot-Swap HDD	15000	SL	3 ... 5	3
					19K0656	18.2GB 15,000rpm Ultra160 Hot-Swap HDD	15000	SL	3 ... 5	3
					06P5768	36.4GB 15,000rpm Ultra160 Hot-Swap HDD	15000	SL	3 ... 5	3
<b>External Storage Expansion Units<sup>1</sup></b>							<b>Form Factor</b>			
					19K11xx <sup>7</sup>	EXP300 Storage Expansion Unit <sup>2, 6</sup>		Rack (3U)		
					19K11xx <sup>8</sup>	FAStT200 Storage Server <sup>3, 4, 6</sup>		Rack (3U)		
					19K11xx <sup>9</sup>	FAStT200 HA Storage Server <sup>3, 6</sup>		Rack (3U)		
					19K1121	FAStT200 Redundant RAID Controller <sup>4</sup>		-		
					00N71xx <sup>10</sup>	FAStT EXP500 Storage Expansion Unit <sup>5, 6</sup>		Rack (3U)		
					94G7448	Rack Power Cable Type C12 (3.7m) <sup>6</sup>		-		

1. Two 36.4GB 10,000rpm hot-swap HDDs are standard.

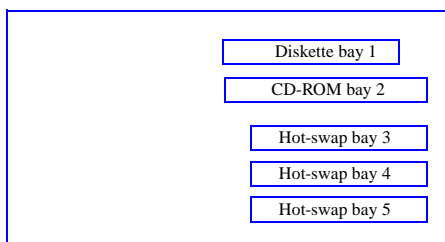

1. To configure an external SCSI storage device, select an optional SCSI controller then refer to Appendix D: Cables - Storage Units - Controllers to confirm the controller supports the desired External Storage Expansion Unit and to select a supported cable. For HDD or other expansion unit options, see the specific expansion unit section. For Fibre Channel storage devices, refer to the Fibre Channel Solutions Overview section.

2. EXP300 includes a single 2M Ultra2 SCSI cable and dual hot-swap 500W redundant power supplies, each with its own standard country power cord.

3. The FAStT200 Storage Server and HA Storage Server each include two hot-swap, 350W auto-ranging redundant power supplies, each with its own standard country power cord.

4. Can be upgraded to FAStT200 HA Storage Server through the addition of a FAStT200 Redundant RAID Controller P/N 19K1121.

5. FAStT EXP500 Storage Expansion Unit includes dual hot-swap 350W power supplies, each with its own standard country power cord.

6. These units do not include Rack Power Cables P/N 94G7448 when shipped (for attachment to high voltage UPS or PDU). Standard country power cords only are included. If required, order Rack Power Cables according to the number of power supplies.

7. Where 'xx' represents a specific country code as follows:- 51=US/English, 52=European/English, 56=Danish/English, 57=Israel/English, 58=Italian/English, 59=South Africa/English, 60=Swiss/English, 63=UK/English:- Line Cords/ Publication Country Kits are included as indicated.

8. Where 'xx' represents a specific country code as follows:- 23=US/English, 24=Euro/English, 25=Euro/Spanish, 27=Euro/German, 28=Denmark/English, 29=Israel/English, 30=Italy/English, 31=South Africa/English, 32=Switzerland/English, 34=Switzerland/German, 36=UK/English. Country/Language - Line Cords/Publications are included as indicated.

9. Where 'xx' represents a specific country code as follows:- 37=US/English, 38=Euro/English, 39=Euro/Spanish, 41=Euro/German, 42=Denmark/English, 43=Israel/English, 44=Italy/English, 45=South Africa/English, 46=Switzerland/English, 48=Switzerland/German, 50=UK/English. Country/Language - Line Cords/Publications are included as indicated.

10. Where 'xx' represents a specific country code as follows:- 36=US/English, 37=Euro/English, 41=Denmark/English, 42=Israel/English, 43=Italy/English, 44=South Africa/English, 45=Switzerland/English, 49=UK/English. Country/ Language Line Cords/Publications are included as indicated.



**xSeries 360 I/O Options**

Part Number	Description	Adapter Length	PCI Support <sup>1</sup>	Slots Supported <sup>1</sup>	Hot-Plug <sup>2</sup>	PCI Voltage Key	MHz <sup>3</sup>
<b>Storage Controllers<sup>4</sup></b>							
37L6889	ServeRAID-4H Ultra160 SCSI Controller <sup>5</sup>	Full	64-bit	1 ... 6 <sup>17</sup>	X	Universal	33
06P5736	ServeRAID-4Mx Ultra160 SCSI Controller <sup>6</sup>	Full	64-bit	1 ... 6 <sup>17</sup>	X	Universal	66
06P5740	ServeRAID-4Lx Ultra160 SCSI Controller <sup>7</sup>	Half	64-bit	1 ... 6	X	Universal	66
19K4646	PCI Wide Ultra160 SCSI Adapter <sup>8</sup>	Half	32-bit	1 ... 6	-	Universal	66
<b>Fibre Storage Controllers and Options<sup>9</sup></b>							
00N6881	Netfinity FAST Host Adapter	Half	64-bit	1 ... 6	X	Universal	66
19K1246	FAST FC-2 Host Bus Adapter	Half	64-bit	1 ... 6	X	Universal	66
<b>Networking<sup>11</sup></b>							
<b>Ethernet<sup>12</sup></b>							
09N9901	10/100 EtherLink Server Adapter by 3Com <sup>13</sup>	Half	32-bit	1 ... 6	X	Universal	33
06P3601	10/100 Ethernet Server Adapter <sup>13</sup>	Half	32-bit	1 ... 6	X	Universal	33
06P3701	Gigabit Ethernet SX Server Adapter (fibre optic cabling interface)	Half	64-bit	1 ... 6	X	Universal	66
22P4901	10/100 Dual Port Server Adapter <sup>13</sup>	Half	64-bit	1 ... 6	X	Universal	66
22P6801	PRO/1000XT Server Adapter by Intel (with CD and manuals) <sup>13</sup>	Half	64-bit	1 ... 6	X	Universal	133 <sup>3</sup>
<b>Token Ring</b>							
34L5001	16/4 Token-Ring PCI Management Adapter <sup>13</sup>	Half	32-bit	1 ... 6	X	Universal	33
34L5201	High-Speed 100/16/4 Token-Ring PCI Management Adapter <sup>13</sup>	Half	32-bit	1 ... 6	X	Universal	33
<b>Systems Management<sup>14</sup></b>							
03K9309	Advanced System Management Interconnect Cable Kit <sup>15</sup>	-	-	-	-	-	-
<b>Remote I/O Expansion</b>							
86841RX	RXE-100 Remote Expansion Enclosure <sup>16</sup>	-	-	-	-	-	-

1. Adapters rated at a lower frequency than the slots in which they are installed will reduce the bus to the frequency of the slowest adapter. 133MHz PCI-X adapters are backward compatible with 33/66MHz, 64-bit PCI-based servers.
2. All six slots are full-length hot-plug capable. For Network Operating System support, access [www.pc.ibm.com/us/compat](http://www.pc.ibm.com/us/compat).
3. Slots one and two operate at 100MHz on the same bus and support two 100MHz adapters. An adapter rated at 133MHz may be installed in slot one, but slot two must remain empty.
4. xSeries 360 includes an integrated single-channel Ultra160 SCSI controller. See "Internal SCSI Cabling" for cabling alternatives.
5. ServeRAID-4H Ultra160 SCSI Controller is powered by a 266MHz PowerPC 750 processor and provides 128MB of battery-backed ECC cache. The two internal connectors are not accessible due to a cabling interference. Four external Ultra160 0.8mm VHDCI connectors are available.
6. ServeRAID-4Mx Ultra160 SCSI Controller is powered by a 100MHz Intel Zion GC80303 processor that provides 64MB of battery-backed ECC cache and two internal and two external Ultra160 connections (only two connectors may be used). External connectors are 0.8mm VHDCI.
7. ServeRAID-4Lx Ultra160 SCSI Controller is powered by a 100MHz Intel Zion GC80303 processor and provides a single channel, 32MB of ECC cache and either one internal or one external Ultra160 connection. External connector is 0.8mm VHDCI.
8. PCI Wide Ultra160 SCSI Adapter P/N 19K4646 provides a single channel with one internal connector, a five-drop multi-mode terminated LVD SCSI cable and one external 0.8mm VHDCI connector. Only one of the two connectors may be utilised.
9. See Fibre Channel Solutions Overview section for additional configuration information.
- 10.
11. xSeries 360 has an integrated 10/100 PCI Ethernet controller. Wake on LAN is supported only for the integrated controller.
12. In a fault-tolerant networking environment, using the fault-tolerant software delivered with the Ethernet adapters of a single manufacturer is recommended. Installing fault-tolerant solutions provided by multiple manufacturers may cause failures if the intermediate drivers provided with the adapters are not compatible. The onboard Ethernet is Intel-based. The optional PCI Ethernet adapters listed here are Intel-based: P/Ns 06P3601, 06P3701, 22P4901, 22P6801.
13. The Wake on LAN function of this option is not supported by this server.
14. xSeries 360 includes a Remote Supervisor Adapter installed in a dedicated PCI slot with an external connector, leaving six PCI slots available for optional adapters. Support for connection to other servers requires an optional Advanced System Management Interconnect Cable Kit P/N 03K9309. Direct connection to the RXE drawer management controller in an RXE-100 Remote Expansion Enclosure is supported through a standard Interconnect Management Cable Kit with 3.5m cable. An 8m optional cable is available.
15. Required to connect the standard Remote Supervisor Adapter to an interconnect network with other servers for system management support through a single LAN or modem connection. Up to 12 service processors or optional adapters may be interconnected with an aggregate connection length of no more than 91.4M (300ft). A customer-supplied Cat5 Ethernet cable is required for each interconnection.
16. RXE-100 Remote Expansion Enclosure supports up to 12 additional PCI-X slots. Cable required for connection included with expansion unit, which attaches to a standard external connector located on the back of the x360 chassis. An optional longer cable is available. See RXE-100 product section.
17. Not supported in slot one, if the RAID adapter is attached to the connector on the planar that controls the hot-swap backplane, as a result of a cabling interference with the standard RAID cable, which must be routed under the adapter. External RAID attachment only is supported for full-length RAID adapters installed in slot one.





1. If a 133MHz adapter is installed in bus 2 (slot one only), slot two must remain empty.

### xSeries 360 Power, Monitors, Accessories

Part Number	Description
<b>Power<sup>1, 11</sup></b>	
32P15xx <sup>12</sup>	370W Hot-Swap Redundant Power Supply <sup>1, 11</sup>
94G7448	Rack Power Cable Type C12 (3.7m) <sup>11</sup>
<b>Uninterruptible Power Supply (UPS)<sup>2, 3</sup></b>	
14RIxxx <sup>13</sup>	APC Smart-UPS 1400RMiB <sup>4</sup>
32P16xx <sup>14</sup>	APC 2U Smart-UPS 1400RMiB <sup>6</sup>
30RIxxx <sup>13</sup>	APC Smart-UPS 3000RMiB <sup>4</sup>
37L6862	APC Smart-UPS 5000RMiB <sup>5</sup>
<b>Monitors<sup>7</sup></b>	
T3147xx <sup>15</sup>	E54 Color Monitor 15in (350mm, 13.8in viewable image), stealth black <sup>8</sup>
T3247xx <sup>15</sup>	E74 Color Monitor 17in (406mm, 16in viewable image), stealth black <sup>8</sup>
T274Axx <sup>15</sup>	G78 Color Monitor 17in (406.4mm, 16in viewable image), stealth black <sup>8</sup>
T11AGxx <sup>15</sup>	T540 Flat Panel Color Monitor 15in (381mm, 15in viewable image), stealth black <sup>9</sup>
32P1032	NetBAY 1U Flat Panel Monitor Console Kit (without keyboard) <sup>10</sup>

1. xSeries 360 systems include two 370W, hot-swap power supplies, each with its own standard country power cord. N+1 power supply redundancy is standard. The addition of an optional 370W Hot-Swap Redundant Power Supply P/N 32P15xx is supported for configurations of greater than 370W with power redundancy, i.e. a total of three 370W power supplies.

The following table is provided as a reference. The table shows an example of a maximum configuration that can be supported by two 370W power supplies with power redundancy.

Number of power supplies	System configuration supported
2	<b>Redundant</b>
	Up to three processors
	Up to four PCI adapters
	Up to two HDDs
	Up to six memory RDIMMs



2. For runtimes and UPS attributes see Appendix C: UPS Runtime Estimate.
3. Because the x360 is not equipped with a serial port, UPS remote management requires a USB to serial adapter such as the Belkin USB to Serial Adapter P/N 10K3661. For more information visit: <http://www.ibm.com> - select 'Products & Services' - click on 'Upgrades, Accessories and Parts' - enter P/N 10K3661 in the accessories search box.
4. Height is 3U. See Rack Cabinets and Options section for supported IBM racks.
5. Height is 5U. See Rack Cabinets and Options section for supported IBM racks.
6. Height is 2U. See Rack Cabinets and Options section for supported IBM racks.
7. xSeries 360 uses an SVGA controller (S3 Savage4 LT chipset) with 8MB of video memory.
8. Installation within a rack requires optional Monitor Compartment P/N 94G7444.
9. Installation within a rack requires optional Flat Panel Monitor Rack Mount Kit II P/N 37L6888 and Rack Keyboard Tray P/N 28L4707. A space saver keyboard may coexist within the same keyboard tray.
10. Includes a 15in Flat Panel Monitor. Does not include a keyboard. See note 9. - this is an alternative console solution.
11. Rack Power Cable P/N 94G7448 (one for each power supply), must be ordered for power connection to a high voltage UPS or PDU.
12. Where 'xx' represents a specific country code as follows:- 74=Europe, 75=Denmark, 76=Israel, 77=Italy, 78=South Africa, 79=Switzerland, 80=UK.
13. Where 'xxx' represents a specific country code as follows:- DEN=Denmark, ISR=Israel, ITA=Italy, SDI=Saudi Arabia, SAF=South Africa, SWS=Switzerland, UKM=United Kingdom, EUR=Europe.
14. Where 'xx' represents a specific country code as follows:- 12=Europe, 13=UK, 14=Italy, 15=Switzerland, 16=Denmark, 17=South Africa, 18=Israel.
15. Where 'xx' represents a specific country code as follows:- DK=Denmark, IS=Israel, IT=Italy, SD=Saudi Arabia, SA=South Africa, CH=Switzerland, UK=UK, EU=Europe.

Part Number	Description
<b>Rack and NetBAY<sup>1, 6</sup></b>	
94G7448	Rack Power Cable Type C12 (3.7m) <sup>6</sup>
<b>NOTE:</b> Refer to the Rack Cabinets and Options section for details of IBM Racks and rack-supported devices.	
<b>Keyboard and Mouse<sup>2</sup></b>	
28L36xx <sup>7</sup>	Space Saver II Keyboard <sup>3, 4</sup>
28L36xx <sup>8</sup>	Preferred Keyboard (stealth black) <sup>5</sup>
28L3675	Sleek 2-Button Stealth Black Mouse

1. xSeries 360 is housed in a 19in rack-mountable drawer and requires one of the racks listed in the Rack Cabinets and Options section.
2. xSeries 360 supports rack configurations only and ships without a keyboard or mouse. The system includes three USB ports, SVGA video port, mouse port and keyboard port.
3. Installation within a rack requires optional keyboard tray P/N 28L4707, which stows in ready-to-use position.
4. Advanced TrackPoint IV features are not available on IBM xSeries systems.
5. Installation within a rack requires optional keyboard tray P/N 28L4707. This keyboard cannot share a keyboard tray with a flat panel display.
6. The xSeries 360 ships with a standard country power cord. For connection to a high voltage UPS or PDU, a Rack Power Cable P/N 94G7448 (one for each power supply), must be ordered.
7. Where 'xx' represents a specific country code as follows:- 46=Danish, 47=France, 48=Germany, 49=Italian, 50=Spanish, 51=UK English, 44=US English, and P/N 19K3831=Switzerland, 19K3832=Sweden/Finland, 19K3833=Portugal, 19K3834=Belgium, 19K3836=Russia, 19K3837=Poland.
8. Where 'xx' represents a specific country code as follows:- 25=French, 26=German, 27=Italian, 29=UK English, 31=Danish, 33=Norwegian, 34=Swedish/Finnish, 35=Swiss, 36=Dutch, 21=US English, and P/N 22P7325=Belgium/UK, 22P7323=Icelandic.



**xSeries 360 Tape Options**

Part Number	Tape Drives	Bays Supported <sup>1</sup>	SCSI Interface (bit)	Form Factor	Termination Included	68/50-pin Converter Incl	Ext Tape Enclosures
00N8016	100/200GB LTO Tape Drive	-	16 Ultra2 LVD	133mm (5.25in) FH	N	-	03K8756 <sup>2</sup> 24P24xx
00N8015	110/220GB Super DLT Internal SCSI Tape Drive	-	16 Ultra2 LVD	133mm (5.25in) FH	N	-	03K8756 <sup>2</sup> 24P24xx
24P2396	100/200GB LTO Half-High Tape Drive	-	16 Ultra2 LVD	133mm (5.25in) HH	N	-	03K8756 <sup>2</sup>
<b>Tape Autoloaders</b>							
09N40xx <sup>10</sup>	3600 Series 900GB/1.8TB LTO Tape Autoloader <sup>3</sup>	-	16 Ultra2 LVD	Tower or 6U Rack	Y	-	-
<b>External Tape Libraries<sup>4</sup></b>							
21P99xx <sup>11</sup>	3600 Series 2/4TB LTO Tape Library (Tower)	-	16 Ultra2 LVD	Tower	Y	-	-
21P99xx <sup>11</sup>	3600 Series 2/4TB LTO Tape Library (Rack)	-	16 Ultra2 LVD	5U Rack	Y	-	-
21P99xx <sup>12</sup>	3600 Series 2-Drive, 20-Cartridge Expander Module <sup>5</sup>	-	16 Ultra2 LVD	5U Rack	Y	-	-
09N4048	3600 Series LTO Drive Upgrade Option <sup>6</sup>	-	16 Ultra2 LVD	-	N	-	-
<b>External Tape Enclosures</b>							
03K8756	NetMEDIA Storage Expansion Unit EL <sup>7</sup>	-	16	Rack	Y	N	-
10L7113	NetMEDIA Systems Management Adapter <sup>8</sup>	-	16 LVD	-	N	N	03K8756
24P24xx <sup>13</sup>	Full-High SCSI Tape Enclosure <sup>9</sup>	-	16 Ultra2 LVD	Desktop or 3U Rack	Y	N	-
<b>Associated Options</b>							
10K2340	Media Bay Tray and LVD Cable Kit <sup>2</sup>	-	16 LVD	Int	Y	N	03K8756

1. IBM xSeries 360 does not support internal tape drives. An external tape library or tape enclosure must be used. All tape drives and enclosures are supported by PCI Wide Ultra160 SCSI Adapter P/N 19K4646 which has an external 0.8mm VHDCI connector. Select tape drive, enclosure and controller then use Appendix D: Cables - Storage Units - Controllers to select an appropriate external cable.
2. LVD support for LVD devices installed in a NetMEDIA Storage Expansion Unit EL P/N 03K8756 requires replacement of the standard single-ended internal cables with one or more (depending on configuration) cables from Media Bay Tray and LVD Cable Kit P/N 10K2340 which contains a single two-drop multi-mode terminated cable. If the standard cables are used for attachment to LVD devices, single-ended SCSI rules and bus speeds apply.
3. If installed in a rack, a fixed shelf is required. Allow an additional 1U for the fixed shelf. One unit only per shelf is supported.
4. Tape Library attributes and prerequisites are included in Appendix B: Tape Library Attributes.
5. Supported only with the 3600 Series LTO Tape Library (Rack) P/N 21P99xx. Allow one additional EIA space when installing either one or two (maximum) units to accommodate a filler plate for cable routing. Up to two 3600 Series LTO Drive Upgrade Options can be installed in each module or the module can operate off the LTO drives installed in the LTO tape library.
6. Install in second drive bay of 3600 LTO Tape Libraries or in either of the two bays of 3600 Series 2-Drive 20-Cartridge Expander Module to increase performance. Includes an LTO (Ultrium) drive and a one-meter external LVD SCSI cable.
7. NetMEDIA Storage Expansion Unit EL P/N 03K8756 is a black 3U, 19in rack mountable tape enclosure which includes two full-high (FH) or four half-high (HH) extended length 133mm (5.25in) bays, two external 0.8mm VHDCI connectors and two internal four-drop single-ended terminated 16-bit SCSI cables for device attachment. Two power supplies and two power cords are also included. Tip: The front rail clips will need to be reversed and screwed in from behind to secure the unit in a Rack Cabinet P/N 930842x.
8. NetMEDIA Systems Management Adapter P/N 10L7113 may be installed in a NetMEDIA Storage Expansion Unit to provide repeater function, LVDS interface, aggregate cable lengths up to 12m when attached to an LVD SCSI controller, and auto-termination when the Expansion Unit is powered off. External connector is 0.8mm VHDCI.
9. Black desktop or 3U rack tape enclosure supports 133mm (5.25in) full-high LVD tape devices including DLT technology. Requires a fixed shelf if installed in a rack (allow additional 1U for fixed shelf). Supports the full-high tape options P/N 00N8015 and P/N 00N8016.
10. Where 'xx' represents a specific country code as follows: 49=UK, 50=Europe, 51=Denmark, 52=South Africa, 53=Switzerland, 54=Italy, 55=Israel.
11. Where 'xx' represents a specific country code as follows: - Tower version - 71=Europe, 72=Denmark, 73=South Africa, 70=UK, 74=Swiss, 75=Italy, 76=Israel: Rack version - 78=Europe, 79=Denmark, 80=South Africa, 77=UK, 81=Swiss, 82=Italy, 83=Israel.
12. Where 'xx' represents a specific country code as follows: - 85=Europe, 86=Denmark, 87=South Africa, 84=UK, 88=Swiss, 89=Italy, 90=Israel.
13. Where 'xx' represents a country specific code: 35=UK, 39=Swiss, 40=Italy, 41=Israel, 36=EU, 37=Denmark, 38=South Africa.

Note: Additional tape attributes can be found in Appendix A: Tape Drive Attributes.



### xSeries 360 Sample Configurations

Note: The following sample configurations are for illustration only and may not be suitable for any specific customer installation. Contact your IBM Business Partner or IBM Marketing Representative for assistance with your specific configuration requirements.

#### Microsoft Exchange SCSI Solution<sup>1</sup>

Part Number	Description	Quantity
K63RXxx	xSeries 360 Pentium III Xeon, 2x1.6GHz/4x100MHz, 1MB L3 Cache, 2GB(R) ECC, 72.8GB, 24X	1
19K4647	xSeries 1.6GHz/1MB L3 Cache Upgrade with Xeon Processor MP	2 <sup>2</sup>
32P15xx	xSeries 370W Hot-swap Redundant Power Supply	1 <sup>3</sup>
33L3283	512MB PC 1600 ECC DDR SDRAM RDIMM	2 <sup>4</sup>
37L6889	ServeRAID-4H Ultra160 SCSI Controller	1 <sup>5</sup>
37L7206	36.4GB 10K-4 Ultra160 SCSI Hot-Swap SL HDD	1 <sup>6</sup>
06P3601	10/100 Ethernet Server Adapter	1
T3147xx	E54 Color Monitor 15in (350mm, 13.8in viewable image), stealth black	1
37L6862	APC Smart-UPS 5000RMiB	1
<b>External Storage</b>		
19K11xx	EXP300 Storage Expansion Unit	2
37L7206	36.4GB 10K-4 Ultra160 SCSI Hot-Swap SL HDD	14 <sup>7</sup>
09N40xx	3600 Series 900GB/1.8TB LTO Tape Autoloader	1
<b>Rack Options</b>		
9306250	NetBAY25 Standard Rack Cabinet	1
28L36xx	Space Saver II Keyboard	1
94G6670	Blank Filler Panel Kit	1

1. This configuration supports 8,000 users.
2. Total of four processors.
3. Required to maintain N+1 power redundancy in this configuration--total of three 370W power supplies.
4. Total memory of 3GB.
5. External connectors only can be used due to internal cabling restriction.
6. Total of three 36.4GB internal HDDs (109.2GB).
7. Six HDDs are used for RAID-5E protection in each EXP300. One HDD is identified as a hot-spare. Effective capacity is five HDDs in each storage enclosure (total of 182GB).

#### Microsoft Exchange High-Availability Fibre Channel Solution<sup>1</sup>

Part Number	Description	Quantity
K63RXxx	xSeries 360 Pentium III Xeon, 2x1.6GHz/4x100MHz, 1MB L3 Cache, 2GB(R) ECC, 72.8GB, 24X	1
19K4647	xSeries 1.6GHz/1MB L3 Cache Upgrade with Xeon Processor MP	2 <sup>2</sup>
32P15xx	xSeries 370W Hot-swap Redundant Power Supply	1 <sup>3</sup>
33L3283	512MB PC 1600 ECC DDR SDRAM RDIMM	2 <sup>4</sup>
06P5736	ServeRAID-4MX Ultra160 SCSI Controller	1
37L7206	36.4GB 10K-4 Ultra160 SCSI Hot-Swap SL HDD	1 <sup>5</sup>
06P3601	10/100 Ethernet Server Adapter	1
19K1246	FASiT FC-2 Host Bus Adapter	2
86841RX	RXE-100 Remote Expansion Enclosure	1
24P09xx	FASiT700 Storage Server	1 <sup>6</sup>
37L6862	APC Smart-UPS 5000RMiB	1
30RIxxx	APC Smart-UPS 3000RMiB	1
<b>External Storage</b>		
00N71xx	FASiT EXP500 Storage Expansion Unit	3
19K0653	Netfinity 36.4GB 10K-4 FC Hot-Swap HDD	15 <sup>7</sup>
09N40xx	3600 Series 900GB/1.8TB LTO Tape Autoloader	1
<b>Rack Options</b>		
9306420	NetBAY42 Standard Rack Cabinet	1
32P1032	NetBAY 1U Flat Panel Monitor Console Kit (without Space Saver Keyboard)	1
28L36xx	Space Saver II Keyboard	1
94G6670	Blank Filler Panel Kit	1

1. This configuration supports 8,000 users.
2. Total of four processors.
3. Required to maintain N+1 power redundancy in this configuration--total of three 370W power supplies.
4. Total memory of 3GB.
5. Total of three 36.4GB internal HDDs (109.2GB).
6. Fibre Channel cable, SFP Modules and FASiT700 Mini Hubs not included.
7. Six HDDs are used for RAID-5E protection in each EXP300. One HDD is identified as a hot-spare. Effective capacity is five HDDs in each storage enclosure (total of 182GB).



# IBM RXE-100 Remote Expansion Enclosure

Part Number  
 Form Factor  
 Power Supply Quantity (Std/Max)  
 Hot-Swap (Power, Slots, HDD, Fans)  
 Redundancy (Optional, Standard)  
 System Management Controller  
 Standard Slots (Total/Avail)  
 Optional Slots (Total/Avail)

RXE-100 Remote Expansion Enclosure At-A-Glance Chart							
86841RX <sup>1</sup>	Rack (3U)	2/2	P, S, F	S - Fans S - Power <sup>2</sup>	Y <sup>3</sup>	6/6 <sup>4</sup>	6/6 <sup>5</sup>

- Housed in a 19in rack-mountable drawer. See Rack Cabinets and Options section for supported IBM racks. Ships with one 3.5m Remote I/O Cable Kit P/N 31P6102 and one 3.5m Interconnect Management Cable Kit P/N 31P6087. 8m (eight meter) cables are available as options P/N 31P6103 and P/N 31P6088.
- N+1 power supply redundancy is provided standard. Two 370W Hot-Swap Redundant Power Supplies P/N 32P15xx are installed in the RXE-100.
- RXE-100 management controller interfaces with the Remote Supervisor Adapter standard in xSeries 360 using an Interconnect Management Cable Kit P/N 31P6087 (3.5m) or P/N 31P6088 (8m).
- RXE-100 ships with six full-length, 64-bit PCI-X slots supporting three 133MHz adapters or six 100MHz adapters. Adapters rated at 33 or 66MHz restrict PCI buses in which they are installed to the frequency of the slowest adapter.
- Support for additional six 64-bit slots is available through installation of the optional Remote I/O PCI-X 6-slot Expansion Kit P/N 31P5998. Remote I/O connection is cabled internally within the RXE-100 enclosure using the secondary connector on each PCI-X 6-slot Expansion Kit, i.e., only one connection between the server and RXE-100 is required. Although the six PCI slots it contains are hot-swap, the expansion kit itself is not.



### RXE-100 Remote Expansion Enclosure

P/N 86841RX

top view

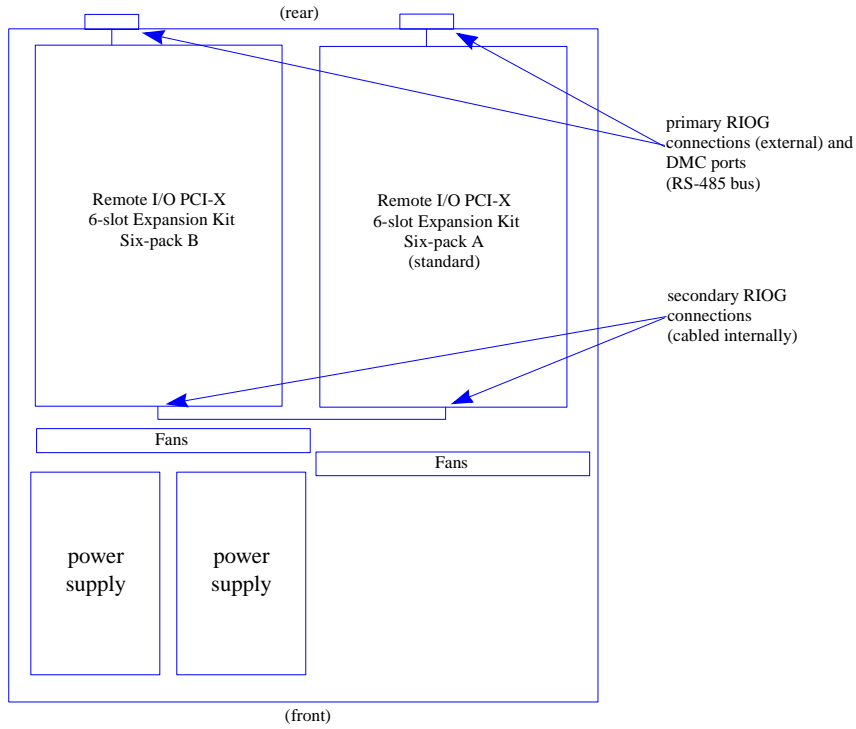

- Rack-mounted 3U enclosure that fits standard IBM racks (same size case as xSeries 360).
- Contains six active PCI-X adapter slots with support for six optional slots. The 6-slot expansion kits themselves are not hot-swap although each of the slots they contain are and they support hot-swap installation of PCI adapters.
- Supports three 133MHz or six 100MHz adapters (backward compatible to 33 or 66MHz adapters).
- Interfaces directly to the xSeries 360 memory controller, supporting 2Gb/s data transfers.
- Interfaces with Remote Supervisor Adapter in the host xSeries 360.
- Hot-swap redundancy for fans and power supplies (two 370W power supplies and four cooling fans).



**RXE-100 Remote Expansion Enclosure External HDD Storage Configurator**

Part Number	External Storage Expansion Units <sup>1</sup>	Form Factor
19K11xx <sup>7</sup>	EXP300 Storage Expansion Unit <sup>2, 6</sup>	Rack (3U)
19K11xx <sup>8</sup>	FAStT200 Storage Server <sup>3, 4, 6</sup>	Rack (3U)
19K11xx <sup>9</sup>	FAStT200 HA Storage Server <sup>3, 6</sup>	Rack (3U)
19K1121	FAStT200 Redundant RAID Controller <sup>4</sup>	-
00N71xx <sup>10</sup>	FAStT EXP500 Storage Expansion Unit <sup>5, 6</sup>	Rack (3U)
94G7448	Rack Power Cable Type C12 (3.7m) <sup>6</sup>	-

1. To configure an external SCSI storage device, select an optional SCSI controller then refer to Appendix D: Cables - Storage Units - Controllers to confirm the controller supports the desired External Storage Expansion Unit and to select a supported cable. For HDD or other expansion unit options, see the specific expansion unit section. For Fibre Channel storage devices, refer to the Fibre Channel Solutions Overview section.
2. EXP300 includes a single 2M Ultra2 SCSI cable and dual hot-swap 500W redundant power supplies, each with its own standard country power cord.
3. The FAStT200 Storage Server and HA Storage Server each include two hot-swap, 350W auto-ranging redundant power supplies, each with its own standard country power cord.
4. Can be upgraded to FAStT200 HA Storage Server through the addition of a FAStT200 Redundant RAID Controller P/N 19K1121.
5. FAStT EXP500 Storage Expansion Unit includes dual hot-swap 350W power supplies, each with its own standard country power cord.
6. These units do not include Rack Power Cables P/N 94G7448 when shipped (for attachment to high voltage UPS or PDU). Standard country power cords only are included. If required, order Rack Power Cables according to the number of power supplies.
7. Where 'xx' represents a specific country code as follows:- 51=US/English, 52=European/English, 56=Danish/English, 57=Israel/English, 58=Italian/English, 59=South Africa/English, 60=Swiss/English, 63=UK/English.- Line Cords/ Publication Country Kits are included as indicated.
8. Where 'xx' represents a specific country code as follows:- 23=US/English, 24=Euro/English, 25=Euro/Spanish, 27=Euro/German, 28=Denmark/English, 29=Israel/English, 30=Italy/English, 31=South Africa/English, 32=Switzerland/English, 34=Switzerland/German, 36=UK/English. Country/Language - Line Cords/Publications are included as indicated
9. Where 'xx' represents a specific country code as follows:- 37=US/English, 38=Euro/English, 39=Euro/Spanish, 41=Euro/German, 42=Denmark/English, 43=Israel/English, 44=Italy/English, 45=South Africa/English, 46=Switzerland/English, 48=Switzerland/German, 50=UK/English. Country/Language - Line Cords/Publications are included as indicated.
10. Where 'xx' represents a specific country code as follows:- 36=US/English, 37=Euro/English, 41=Denmark/English, 42=Israel/English, 43=Italy/English, 44=South Africa/English, 45=Switzerland/English, 49=UK/English. Country/Language Line Cords/Publications are included as indicated.



**RXE-100 Remote Expansion Enclosure I/O Options**

Part Number	Description	Adapter Length	PCI Support	Slots Supported <sup>1</sup>	Hot-Plug <sup>2</sup>	PCI Voltage Key	MHz <sup>3</sup>
<b>Storage Controllers</b>							
37L6889	ServeRAID-4H Ultra160 SCSI Controller <sup>4</sup>	Full	64-bit	1 ... 6	X	Universal	33
06P5736	ServeRAID-4Mx Ultra160 SCSI Controller <sup>5</sup>	Full	64-bit	1 ... 6	X	Universal	66
06P5740	ServeRAID-4Lx Ultra160 SCSI Controller <sup>6</sup>	Half	64-bit	1 ... 6	X	Universal	66
19K4646	PCI Wide Ultra160 SCSI Adapter <sup>7</sup>	Half	32-bit	1 ... 6	-	Universal	66
<b>Fibre Storage Controllers and Options<sup>8</sup></b>							
00N6881	Netfinity FAST Host Adapter	Half	64-bit	1 ... 6	X	Universal	66
19K1246	FAST FC-2 Host Bus Adapter	Half	64-bit	1 ... 6	X	Universal	66
<b>Networking</b>							
<b>Ethernet</b>							
09N9901	10/100 EtherLink Server Adapter by 3Com	Half	32-bit	1 ... 6	X	Universal	33
06P3601	10/100 Ethernet Server Adapter	Half	32-bit	1 ... 6	X	Universal	33
06P3701	Gigabit Ethernet SX Server Adapter (fiber)	Half	64-bit	1 ... 6	X	Universal	66
22P4901	10/100 Dual Port Server Adapter	Half	64-bit	1 ... 6	X	Universal	66
22P6801	PRO/1000XT Server Adapter by Intel (copper) w/CD, manuals	Half	64-bit	1 ... 6	X	Universal	133 <sup>3</sup>
<b>Token Ring</b>							
34L5001	16/4 Token-Ring PCI Management Adapter	Half	32-bit	1 ... 6	X	Universal	33
34L5201	High-Speed 100/16/4 Token-Ring PCI Management Adapter	Half	32-bit	1 ... 6	X	Universal	33
<b>Associated Options</b>							
31P5998	Remote I/O PCI-X 6-slot Expansion Kit <sup>9</sup>	-	-	-	-	-	-
31P6088	8m Interconnect Management Cable Kit <sup>10</sup>	-	-	-	-	-	-
31P6103	8m Remote I/O Cable Kit <sup>11</sup>	-	-	-	-	-	-
31P6087	3.5m Interconnect Management Cable Kit <sup>12</sup>	-	-	-	-	-	-
31P6102	3.5m Remote I/O Cable Kit <sup>12</sup>	-	-	-	-	-	-

1. Slots one through six are 64 bits wide configured on three buses with two slots each, supporting either one 133MHz or two 100MHz adapters in each bus. The slots are backward compatible for adapters that operate at 33 or 66MHz, which reduce the buses in which they are installed to the frequency of the slowest adapter.

2. All six slots are full-length Active PCI-X (hot-plug capable). For Network Operating System support, access [www.pc.ibm.com/us/compat](http://www.pc.ibm.com/us/compat).

3. All slots support either 100MHz or 133MHz adapters (as well as 33MHz and 66MHz adapters). If an adapter rated at 133MHz is installed in either slot of any of the three buses, the other slot must remain vacant.

4. ServeRAID-4H Ultra160 SCSI Controller is powered by a 266MHz PowerPC 750 processor and provides 128MB of battery-backed ECC cache with two internal and four external Ultra160 connectors (a combination of four connectors may be utilised). External connectors are 0.8mm VHDCI.

5. ServeRAID-4Mx Ultra160 SCSI Controller is powered by a 100MHz Intel Zion GC80303 processor that provides 64MB of battery-backed ECC cache and two internal and two external Ultra160 connections (only two connectors may be used). External connectors are 0.8mm VHDCI.

6. ServeRAID-4Lx Ultra160 SCSI Controller is powered by a 100MHz Intel Zion GC80303 processor and provides a single channel, 32MB of ECC cache and either one internal or one external Ultra160 connection. External connector is 0.8mm VHDCI.

7. PCI Wide Ultra160 SCSI Adapter (P/N 19K4646) provides a single channel with one internal connector, a five-drop multi-mode terminated LVD SCSI cable and one external 0.8mm VHDCI connector. Only one of the two connectors may be utilised.

8 See Fibre Channel Solutions Overview section for additional configuration information.

9. Installs into the RXE-100 to expand slot availability from six to 12. The expansion enclosure must be powered down to install this option. Cables internally through the secondary RIOG connectors. The additional six slots are numbered one to six with the same attributes as the standard unit.

10. Allows the x360 remote management functionality to support the RXE-100. A 3.5m cable is standard for installations in the same rack. The 8m length is required when installing in a different rack.

11. Primary expansion cable connecting the expansion enclosure PCI slot capability to the system processor and memory components. A 3.5m cable is standard for installations in the same rack. The 8m length is required when installing in a different rack. Connects the RIOG port on the back of the system to the primary RIOG port on the back of the enclosure.

12. Ships standard with the RXE-100 Remote Expansion Enclosure.





Remote I/O PCI-X 6-Slot Expansion Kit P/N 31P5998

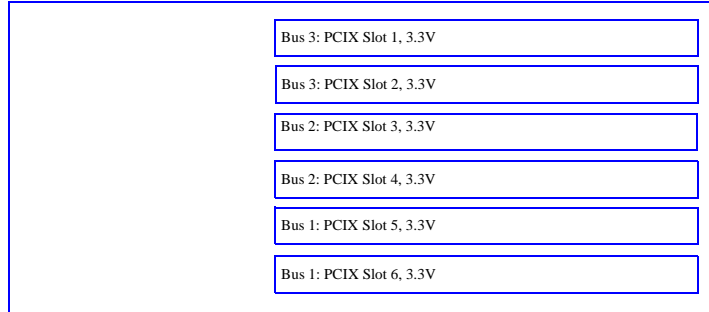

All slots are full-length, 64-bit, Active PCI-X.

**RXE-100 Remote Expansion Enclosure Power**

Part Number	Description
<b>Power<sup>1</sup></b>	
<b>Uninterruptible Power Supply (UPS)<sup>2</sup></b>	
14RIxxx <sup>6</sup>	APC Smart-UPS 1400RMiB <sup>3</sup>
32P16xx <sup>7</sup>	APC 2U Smart-UPS 1400RMiB <sup>5</sup>
30RIxxx <sup>6</sup>	APC Smart-UPS 3000RMiB <sup>3</sup>
37L6862	APC Smart-UPS 5000RMiB <sup>4</sup>

1. RXE-100 includes two 370W hot-swap power supplies (P/N 32P15xx - same as the x360), each with a Rack power cord. N+1 power supply redundancy is standard for full configurations. A third power supply is not supported.
2. For runtimes and UPS attributes see Appendix C: UPS Runtime Estimate.
3. Height is 3U. See Rack Cabinets and Options section for supported IBM racks.
4. Height is 5U. See Rack Cabinets and Options section for supported IBM racks.
5. Height is 2U. See Rack Cabinets and Options section for supported IBM racks.
6. Where 'xxx' represents a specific country code as follows:- DEN=Denmark, ISR=Israel, ITA=Italy, SDI=Saudi Arabia, SAF=South Africa, SWS=Switzerland, UKM=United Kingdom, EUR=Europe.
7. Where 'xx' represents a specific country code as follows:- 12=Europe, 13=UK, 14=Italy, 15=Switzerland, 16=Denmark, 17=South Africa, 18=Israel.



**RXE-100 Remote Expansion Enclosure Tape Options**

Part Number	Tape Drives	Bays Supported <sup>1</sup>	SCSI Interface (bit)	Form Factor	Termination Included	68/50-pin Converter Incl	Ext Tape Enclosures
00N8016	100/200GB LTO Tape Drive	-	16 Ultra2 LVD	133mm (5.25in) FH	N	-	03K8756 <sup>2</sup> 24P24xx
00N8015	110/220GB Super DLT Internal SCSI Tape Drive	-	16 Ultra2 LVD	133mm (5.25in) FH	N	-	03K8756 <sup>2</sup> 24P24xx
24P2396	100/200GB LTO Half-High Tape Drive	-	16 Ultra2 LVD	133mm (5.25in) HH	N	-	03K8756 <sup>2</sup>
<b>Tape Autoloaders</b>							
09N40xx <sup>9</sup>	3600 Series 900GB/1.8TB LTO Tape Autoloader <sup>3</sup>	-	16 Ultra2 LVD	Tower or 6U Rack	Y	-	-
<b>External Tape Libraries<sup>4</sup></b>							
21P99xx <sup>10</sup>	3600 Series 2/4TB LTO Tape Library (Tower)	-	16 Ultra2 LVD	Tower	Y	-	-
21P99xx <sup>10</sup>	3600 Series 2/4TB LTO Tape Library (Rack)	-	16 Ultra2 LVD	5U Rack	Y	-	-
09N4048	3600 Series LTO Drive Upgrade Option <sup>5</sup>	-	16 Ultra2 LVD	-	N	-	-
<b>External Tape Enclosures</b>							
03K8756	NetMEDIA Storage Expansion Unit EL <sup>6</sup>	-	16	Rack	Y	N	-
10L7113	NetMEDIA Systems Management Adapter <sup>7</sup>	-	16 LVD	-	N	N	03K8756
24P24xx <sup>11</sup>	Full-High SCSI Tape Enclosure <sup>8</sup>	-	16 Ultra2 LVD	Desktop or 3U Rack	Y	N	-
<b>Associated Options</b>							
10K2340	Media Bay Tray and LVD Cable Kit <sup>2</sup>	-	16 LVD	Int	Y	N	03K8756

1. RXE-100 does not support internal tape drives. An external tape library or tape enclosure must be used. All tape drives and enclosures are supported by PCI Wide Ultra160 SCSI Adapter P/N 19K4646 which has an external 0.8mm VHDCI connector. Select tape drive, enclosure and controller then use Appendix D: Cables - Storage Units - Controllers to select an appropriate external cable.

2. LVD support for LVD devices installed in a NetMEDIA Storage Expansion Unit EL P/N 03K8756 requires replacement of the standard single-ended internal cables with one or more (depending on configuration) cables from Media Bay Tray and LVD Cable Kit P/N 10K2340 which contains a single two-drop multi-mode terminated cable. If the standard cables are used for attachment to LVD devices, single-ended SCSI rules and bus speeds apply.

3. If installed in a rack, a fixed shelf is required. Allow an additional 1U for the fixed shelf. One unit only per shelf is supported.

4. Tape library attributes and prerequisites are located in Appendix B: Tape Library Attributes.

5. Install in second drive bay of 3600 LTO Tape Libraries or in either of the two bays of 3600 Series 2-Drive 20-Cartridge Expander Module to increase performance. Includes an LTO (Ultrium) drive and a one-meter external LVD SCSI cable.

6. NetMEDIA Storage Expansion Unit EL P/N 03K8756 is a black 3U, 19in rack mountable tape enclosure which includes two full-high (FH) or four half-high (HH) extended length 133mm (5.25in) bays, two external 0.8mm VHDCI connectors and two internal four-drop single-ended terminated 16-bit SCSI cables for device attachment. Two power supplies and two power cords are also included. Tip: The front rail clips will need to be reversed and screwed in from behind to secure the unit in a 930842x rack.

7. NetMEDIA Systems Management Adapter P/N 10L7113 may be installed in a NetMEDIA Storage Expansion Unit to provide repeater function, LVDS interface, aggregate cable lengths up to 12m when attached to an LVD SCSI controller, and auto-termination when the Expansion Unit is powered off. External connector is 0.8mm VHDCI.

8. Black desktop or 3U rack tape enclosure supports 133mm (5.25in) full-high LVD tape devices including DLT technology. Requires a fixed shelf if installed in a rack (allow additional 1U for fixed shelf). Supports the full-high tape options P/N 00N8015 and P/N 00N8016.

9. Where 'xx' represents a specific country code as follows:- 49=UK, 50=Europe, 51=Denmark, 52=South Africa, 53=Switzerland, 54=Italy, 55=Israel.

10. Where 'xxx' represents a specific country code as follows:- *Tower version* - 71=Europe, 72=Denmark, 73=South Africa, 70=UK, 74=Swiss, 75=Italy, 76=Israel; *Rack version* - 78=Europe, 79=Denmark, 80=South Africa, 77=UK, 81=Swiss, 82=Italy, 83=Israel.

11. Where 'xxx' represents a country specific code: 35=UK, 39=Swiss, 40=Italy, 41=Israel, 36=EU, 37=Denmark, 38=South Africa.



# IBM xSeries 370

Part Number  
 Withdrawal Date: ddmmyy  
 Processor Speed<sup>2</sup>  
 Number of Proc.(Std./Max)  
 L2 ECC Cache (KB)  
 Memory (Std./Max)R=RDIMM  
 Form Factor  
 Power Supply Quantity (Std./Max)  
 Hot-Swap(Power, Slots, HDD, Fans)  
 Redundancy (Optional, Standard)  
 Adv. System Management  
 Onboard Ethernet  
 SCSI Controller(Dual, Ultra2, RAID)  
 Removable Media Bays (Total/Avail)  
 Internal Hard Disk (Std./Max)  
 CD-ROM(IDE)<sup>4</sup>  
 Bays (Total/Avail)  
 Slots (T/A)

xSeries 370 At-A-Glance																	
K11RXxx <sup>1</sup>	-	700MHz	1/8	1024	512MB <sup>R</sup> /32GB	Rack (8U)	3/3	P, S, H, F	S-Fans, S-Power	Y	-	D,U2	2/0	0/146.8GB	48X-20X	4/2	12/12
K12RXxx <sup>1</sup>	-	700MHz	1/8	2048	512MB <sup>R</sup> /32GB	Rack (8U)	3/3	P, S, H, F	S-Fans, S-Power	Y	-	D,U2	2/0	0/146.8GB	48X-20X	4/2	12/12
K13RXxx <sup>1</sup>	-	900MHz	1/8	2048	512MB <sup>R</sup> /32GB	Rack (8U)	3/3	P, S, H, F	S-Fans, S-Power	Y	-	D,U2	2/0	0/146.8GB	48X-20X	4/2	12/12

1. Housed in a 19" Rack mountable drawer and ships standard without a keyboard or mouse. See Rack Cabinets and Options section for supported IBM racks.
2. Intel Pentium III Xeon processor with integrated full-speed ECC L2 cache and 100 MHz access to memory and I/O buses.
3. xSeries 370 includes a systems management adapter equivalent to the one shipped with Advanced System Management PCI Adapter P/N 36L96xx.
4. Variable read rate. Actual playback speed will vary and is often less than the maximum possible.

## xSeries 370 Processor Upgrades

Part Number	Processor Upgrades Description <sup>1</sup>	SMP Support <sup>2</sup>	Processor Speed/Cache Upgrade <sup>3</sup>
10K2330	8500R 700MHz/1 MB Upgrade with Pentium III Xeon Processor <sup>3</sup>	K11RXxx	-
10K2166	8500R 700MHz, 2 MB Upgrade with Pentium III Xeon Processor <sup>3</sup>	K12RXxx	K11RXxx
19K4637	xSeries 370 900MHz/2MB Upgrade with Pentium III Xeon Processor	K13RXxx	K11RXxx, K12RXxx
10K2335	4X Accelerator Filter	K11RXxx to K13RXxx <sup>4</sup>	K11RXxx, K12RXxx
10K2337	Mezzanine Expansion Kit	K11RXxx to K13RXxx <sup>4</sup>	K11RXxx, K12RXxx

1. xSeries 370 architecture optimises memory and bus performance using a 100 MHz, five-port crossbar core chipset. Up to eight Pentium III Xeon processors are supported on two 100 MHz P-6 CPU buses. The recommended order of processor installation is: Sockets A1, A3, A2, A4, B1, B3, B2, B4.
2. Up to seven additional processors may be installed, providing a maximum of eight. All processors must be identical in type, speed, and cache size. The fifth through eighth processors require a Mezzanine Expansion Kit P/N 10K2337.
3. Requires removal of the standard processor(s). A maximum of eight processors may be installed. Installation of greater than four processors requires the addition of a mezzanine board and two cache coherency filters. Required options which provide the board and filters vary by model. For more information refer to "Processor Upgrade Requirements". All processors must be identical in type, speed and cache size. Upgrades may require a BIOS update. To obtain the latest Flash BIOS, access [www.ibm.com/pc/support](http://www.ibm.com/pc/support) and enter machine "Type-Model" in Quick Path. Select "Downloadable files" and then "BIOS".
4. The fifth through eighth processors require this option. See "Processor Upgrade Requirements" to determine when this option is required.

Processor Upgrade Requirements <sup>1,2</sup>		
Upgrade To		
Upgrade From	≤ 4 x 700MHz, 900MHz processors	> 4 x 700MHz, 900MHz processors
≤ 4 x 550MHz processors	1 x 10K2337 <sup>3</sup>	1 x 10K2335, 2 x 10K2337 <sup>3</sup>
> 4 x 550MHz processors	1 x 10K2337 <sup>3,4</sup>	2 x 10K2337 <sup>3,5</sup>
≤ 4 x 700MHz processors	-	1 x 10K2335, 1 x 10K2337

1. This table does not address the processor part numbers required. It does address the optional Accelerator Filters and Mezzanine Board part numbers required. 900MHz processors can be substituted for 700MHz processors in this table.
2. All processors must be identical in type, speed, and cache size. Upgrades may require a BIOS update. To obtain the latest Flash BIOS, access [www.ibm.com/pc/support](http://www.ibm.com/pc/support) and enter machine "Type-Model" in Quick Path. Select "Downloadable files" then "BIOS".
3. Remove the standard processor mezzanine board.
4. Remove all optional Enablement Kit components.
5. Remove Enablement Kit mezzanine board. The Enablement Kit 4X cache coherency filters are supported for use with Mezzanine Expansion Kit P/N 10K2337.

xSeries 370 ships with a single mezzanine board containing four Pentium III Xeon processor sockets with terminators in the unoccupied sockets. An additional mezzanine board may be added, expanding the number of processor sockets to eight. The two mezzanine boards are then linked through two cache coherency filter cards, one for each mezzanine board.

### Option Content

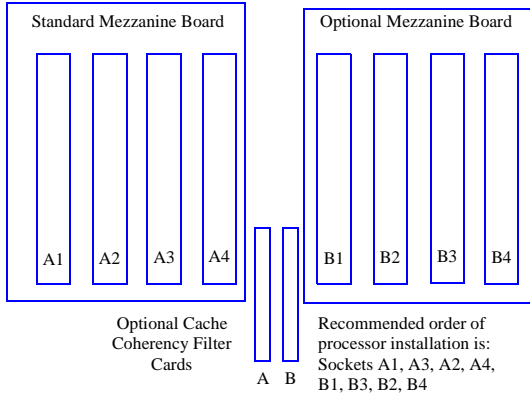

#### 4X Accelerator Filter (P/N 10K2335)

- Two cache coherency filter modules
- Requires Mezzanine Kit 10K2337

#### Mezzanine Expansion Kit (P/N 10K2337)

- One Processor Mezzanine Board
- Supports cache coherency filters from the following options:
  - P/N 10K2335
  - P/N 28L4730
  - P/N 28L4727
- Supports 700 MHz and above processors only
- Required when upgrading models 14RYxxx to 16RYxxx to 700 MHz or above
- Required when adding fifth through eighth processors rated at 700MHz or above.

All installed processors must be identical in type, speed and cache size. Upgrades may require a BIOS update. To obtain the latest Flash BIOS, access [www.ibm.com/pc/support](http://www.ibm.com/pc/support) and enter machine "Type-Model" in Quick Path. Select "Downloadable files" then "BIOS".



**xSeries 370 Memory Configurator**

Total System Memory <sup>1</sup>	Quantity of RDIMMs Added			
	Standard Models			
512MB (4 x 128)	128MB P/N 20L0245	256MB P/N 20L0247	512MB P/N 33L3149	1GB P/N 33L3056
640MB	1	-	-	-
768MB	2 or	1	-	-
1024MB	4 or	2 or	1	-
1280MB	6 or	3	-	-
1536MB	8 or	4 or	2 or	1
1792MB	10 or	5	-	-
2048MB	12 or	6 or	3	-
2560MB	16 <sup>2</sup> or	8 or	4 or	2
2816MB	18 <sup>2</sup> or	9	-	-
3072MB	20 <sup>2</sup> or	10 or	5	-
3328MB	22 <sup>2</sup> or	11	-	-
3584MB	24 <sup>2</sup> or	12 or	6 or	3
4096MB	28 <sup>2</sup> or	14 <sup>2</sup> or	7	-
4608MB	-	16 <sup>2</sup> or	8 or	4
5120MB	-	18 <sup>2</sup> or	9	-
5632MB	-	20 <sup>2</sup> or	10 or	5
6144MB	-	22 <sup>2</sup> or	11	-
6656MB	-	24 <sup>2</sup> or	12 or	6
7680MB	-	28 <sup>2</sup> or	14 <sup>2</sup> or	7
8192MB	-	32 <sup>2,3</sup> or	16 <sup>3</sup> or	8 <sup>3</sup>
8704MB	-	-	16 <sup>2</sup> or	8
9728MB	-	-	18 <sup>2</sup> or	9
10752MB	-	-	20 <sup>2</sup> or	10
11776MB	-	-	22 <sup>2</sup> or	11
12800MB	-	-	24 <sup>2</sup> or	12
13824MB	-	-	26 <sup>2</sup> or	13
14848MB	-	-	28 <sup>2</sup> or	14 <sup>2</sup>
15488MB	-	-	-	15 <sup>3</sup>
16384MB	-	-	32 <sup>2,3</sup> or	16 <sup>3</sup>
16896MB	-	-	-	16 <sup>2</sup>
18944MB	-	-	-	18 <sup>2</sup>
20992MB	-	-	-	20 <sup>2</sup>
23040MB	-	-	-	22 <sup>2</sup>
25088MB	-	-	-	24 <sup>2</sup>
27136MB	-	-	-	26 <sup>2</sup>
29184MB	-	-	-	28 <sup>2</sup>
30720MB	-	-	-	30 <sup>2,4</sup>
32768MB	-	-	-	32 <sup>2,3</sup>

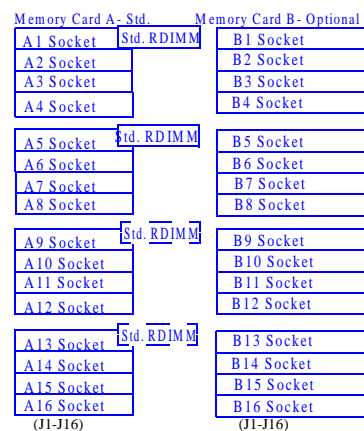

Recommended order of RDIMM population for optimum cooling: 1, 5, 9, 13, 3, 7, 11, 15, 2, 6, 10, 14, 4, 8, 12, 16.

This table does not represent all possible memory configurations. Memory modules may vary in price per MB. Selection of smaller RDIMMs may provide a more cost-effective alternative to using larger RDIMMs.

NOTE: Cache line interleaving may be enabled by installing Memory Expansion Card P/N 28L4454 with as few as two RDIMMs. Matched pairs must be installed if the memory expansion card is present. Two standard RDIMMs may be removed from Card A and installed in Card B to create two matched pairs or four additional 128MB RDIMMs may be purchased and installed in corresponding Card B sockets.

1. Network operating systems may limit the maximum amount of addressable memory. See the operating system specifications for further information.
2. Memory Expansion Card (P/N 28L4454) is required for installation of greater than 16 RDIMMs.
3. Requires removal of standard memory.
4. Requires removal of all but two of the standard RDIMMs.
5. Requires removal of all but one of the standard RDIMMs.

Part Number	Memory Option Description <sup>1</sup>
20L0245	128MB SDRAM ECC RDIMM II
20L0247	256MB SDRAM ECC RDIMM II
33L3056	1GB SDRAM ECC RDIMM II
28L4454	Memory Expansion Card <sup>2</sup>
33L3149	512MB 100MHZ ECC SDRAM RDIMM <sup>3</sup>

1. xSeries 370 includes a single memory card with the ability to support up to 16 GB of memory. All models contain four standard RDIMMs. For memory installation of greater than 16 GB, xSeries 370 Memory Expansion Card P/N 28L4454 is required. Installation of memory on systems containing a single memory card (standard on all models) has no restrictions on size or placement. When Memory Expansion Card P/N 28L4454 is installed, the memory RDIMM in each socket of Card A must match the RDIMM in the same socket on Card B. To enable cache line interleaving, both memory cards must be installed and configured identically.
2. Required for enablement of cache line interleaving or installation of greater than 16 RDIMMs. Configuration of the standard memory card (Card A) and optional P/N 28L4454 (Card B) must be identical.
3. Due to the new technology used by 512MB 100MHz ECC SDRAM RDIMM P/N 33L3149, it should not be matched with 512MB SDRAM ECC RDIMM II P/N 20L0249 when populating Memory Card B.



### xSeries 370 Internal SCSI Cabling

xSeries 370 systems contain an LVDS backplane supporting two hot-swap drive bays that support installation of up to two 3.5-inch, slim-high or half-high HDDs. The backplane is connected to the internal connector of the Wide Ultra2 SCSI controller through a 16-bit LVD SCSI cable. RAID support for the internal hot-swap drive bays is provided by adding a supported RAID adapter and moving the standard SCSI cable from the onboard controller to the optional RAID controller. The standard external Wide Ultra2 SCSI port uses a 0.8mm Very High Density Connector Interface (VHDCI).

**For additional information regarding internal cabling, refer to Appendix E: Internal Storage Cabling Overview.**

### xSeries 370 Internal Hard Disk Drive (HDD) and External Storage Configurator

Total Internal Storage <sup>1</sup>	10,000RPM Ultra160 <sup>2</sup> SCSI HDDs				15,000RPM Ultra160 <sup>2</sup> SCSI HDDs	
	9.1GB P/N37L7204	18.2GB P/N37L7205 or 06P5754	36.4GB P/N37L7206 or 06P5755	73.4GB P/N06P5756	18.2GB P/N19K0656 or P/N 06P5767	36.4GB P/N 06P5768
0GB	0GB Standard on Base Models				0GB Standard on Base Models	
9.1GB	1	-	-	-	-	-
18.2GB	2 or	1	-	-	1	-
36.4GB	-	2 or	1	-	2 or	1
72.8GB	-	-	2	-	-	2
73.4GB	-	-	-	1	-	-
146.8GB (max)	-	-	-	2	-	-

This table does not represent all possible hard disk drive (HDD) configurations.  
 1. Select a total storage row then identify the recommended HDDs from within an RPM range according to choice. Total Internal Storage listed is within ± 0.2 GB unless otherwise noted.  
 2. xSeries 370 contains an Ultra2 hot-swap backplane which limits Ultra160 HDDs to Ultra2 bus speeds.

Bay	Form Factor	Height	Front Access	Usage
-	133mm (5.25in)	HH	Yes	IIDE CD-ROM
-	89mm (3.5in)	SL	Yes	Diskette
1...2	HS	HH	Yes	Open
NB3E <sup>1</sup>	19in Rack	3U	Yes	Open

1. A total of three optional 3U NetBAY3Es can be stacked beneath an xSeries 370 which has 8Ux28D Rack-to-Tower Kit P/N 28L4705 installed. See NetBAY3x Stackable Enclosure section for supported devices.

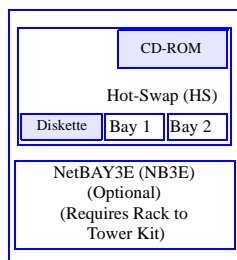

Part Number	Description	RPM	Height	Bays Supported	Max Qty.
<b>Hot-Swap Ultra160 SCSI HDDs<sup>1</sup></b>					
37L7204	9.1GB 10K-4 Ultra160 Hot-Swap HDD	10000	SL	1, 2	2
37L7205	18.2GB 10K-4 Ultra160 Hot-Swap HDD	10000	SL	1, 2	2
06P5754	18.2GB 10,000rpm Ultra160 Hot-Swap HDD	10000	SL	1, 2	2
37L7206	36.4GB 10K-4 Ultra160 Hot-Swap HDD	10000	SL	1, 2	2
06P5755	36.4GB 10,000rpm Ultra160 Hot-Swap HDD	10000	SL	1, 2	2
06P5756	73.4GB 10,000rpm Ultra160 Hot-Swap HDD	10000	SL	1, 2	2
06P5767	18.2GB 15,000rpm Ultra160 Hot-Swap HDD	15000	SL	1, 2	2
19K0656	18.2GB 15,000rpm Ultra160 Hot-Swap HDD	15000	SL	1, 2	2
06P5768	36.4GB 15,000rpm Ultra160 Hot-Swap HDD	15000	SL	1, 2	2
<b>External Storage Expansion Units<sup>2</sup></b>			<b>Form Factor</b>		
19K11xx <sup>8</sup>	EXP300 Storage Expansion Unit <sup>3, 7</sup>	Rack (3U)			
09N7296	EXP300 Rack-to-Tower Conversion Kit	-			
19K11xx <sup>9</sup>	FASiT 200 Storage Server <sup>4, 5, 7</sup>	Rack (3U)			
19K11xx <sup>10</sup>	FASiT 200 HA Storage Server <sup>4, 7</sup>	Rack (3U)			
19K1121	FASiT 200 Redundant RAID Controller <sup>5</sup>	-			
00N71xx <sup>11</sup>	FASiT EXP500 Storage Expansion Unit <sup>6, 7</sup>	Rack (3U)			
94G7448	Rack Power Cable Type C12 (3.7m, 12 ft.) <sup>7</sup>	-			

- xSeries 370 contains an Ultra2 hot-swap backplane which limits Ultra160 HDDs to Ultra2 bus speeds.
- Not supported by the onboard external SCSI port. To configure one of the SCSI storage devices listed here, select an optional SCSI controller then refer to Appendix D: Cables-Storage Units-Controllers to confirm the controller supports the desired External Storage Expansion Unit and to select a supported cable. For HDD or other expansion unit options, see the specific expansion unit section. For Fibre Channel storage devices, refer to the Fibre Channel Solutions Overview section.
- The EXP300 includes a single 2 M Ultra2 SCSI cable and dual hot-swap 500W redundant power supplies, each with its own standard country power cord. To convert an EXP300 to a tower form factor, EXP300 Rack-to-Tower Conversion Kit P/N 09N7296 is required.
- The FASiT200 Storage Server and HA Storage Server each include two hot-swap, 350 W auto-ranging redundant power supplies each with its own standard country power cord.
- Can be upgraded to a FASiT200 HA Storage Server through the addition of a FASiT200 Redundant RAID Controller P/N 19K1121.
- The FASiT EXP500 Storage Expansion Unit includes dual hot-swap 350 W power supplies, each with its own standard country power cord.
- These units do not include Rack Power Cables P/N 94G7448 when shipped (for attachment to high voltage UPS or PDU). Standard country power cords only are included. If required, order Rack Power Cables according to the number of power supplies.
- Where 'xx' represents a specific country code as follows:- 51=US/English, 52=European/English, 56=Danish/English, 57=Israel/English, 58=Italian/English, 59=South Africa/English, 60=Swiss/English, 63=UK/English;- Line Cords/Publication Country Kits are included as indicated.
- Where 'xx' represents a specific country code as follows:- 23=US/English, 24=Euro/English, 25=Euro/Spanish, 27=Euro/German, 28=Denmark/English, 29=Israel/English, 30=Italy/English, 31=South Africa/English, 32=Switzerland/English, 34=Switzerland/German, 36=UK/English. Country/Language - Line Cords/Publications are included as indicated
- Where 'xx' represents a specific country code as follows:- 37=US/English, 38=Euro/English, 39=Euro/Spanish, 41=Euro/German, 42=Denmark/English, 43=Israel/English, 44=Italy/English, 45=South Africa/English, 46=Switzerland/English, 48=Switzerland/German, 50=UK/English. Country/Language - Line Cords/Publications are included as indicated.
- Where 'xx' represents a specific country code as follows:- 36=US/English, 37=Euro/English, 41=Denmark/English, 42=Israel/English, 43=Italy/English, 44=South Africa/English, 45=Switzerland/English, 49=UK/English. Country/Language Line Cords/Publications are included as indicated.



**xSeries 370 I/O Options**

Part Number	Description	Adapter Length	PCI Support <sup>2</sup>	Slots Supported <sup>1,2</sup>	Hot Plug <sup>3</sup>	PCI Voltage Key	MHz <sup>2</sup>
<b>SCSI Storage Controllers<sup>4</sup></b>							
37L6889	ServeRAID-4H Ultra160 SCSI Controller <sup>5</sup>	Full	64-bit	1...12	X	Universal	33
06P5736	ServeRAID-4Mx Ultra160 SCSI Controller <sup>6</sup>	Full	64-bit	1...12	X	Universal	66
06P5740	ServeRAID-4Lx Ultra160 SCSI Controller <sup>7</sup>	Half	64-bit	1...12	X	Universal	66
19K4646	PCI Wide Ultra160 SCSI Adapter <sup>8</sup>	Half	32-bit	1...12	-	Universal	66
02K3454	PCI Fast/Wide Ultra SCSI Adapter <sup>9</sup>	Half	32-bit	1...5, 10...12	-	5	33
<b>Fibre Storage Controller<sup>10</sup></b>							
00N6881	FAST Host Adapter	Half	64-bit	1...12	X	Universal	66
19K1246	FAST FC-2 Host Bus Adapter	Half	64-bit	1...12	X	Universal	66
<b>Networking<sup>11</sup></b>							
<b>Ethernet<sup>12</sup></b>							
09N9901	10/100 EtherLink Server Adapter by 3Com <sup>13</sup>	Half	32-bit	1...12	X	Universal	33
06P3601	10/100 Ethernet Server Adapter <sup>13</sup>	Half	32-bit	1...12	X	Universal	33
06P3701	Gigabit Ethernet SX Server Adapter (fibre optic cabling interface)	Half	64-bit	1...12	X	Universal	66
22P4901	10/100 Dual Port Server Adapter <sup>13</sup>	Half	64-bit	1...12	X	Universal	66
22P6801	PRO/1000XT Server Adapter by Intel (with CD and manuals) <sup>13</sup>	Half	64-bit	1...12	X	Universal	133
<b>Token Ring</b>							
34L5001	16/4 Token-Ring PCI Management Adapter <sup>13</sup>	Half	32-bit	1...12	X	Universal	33
34L0701	Token-Ring 16/4 PCI Adapter 2 with Wake on LAN <sup>13</sup>	Half	32-bit	1...12	X	Universal	33
34L5201	High speed 100/16/4 Token Ring PCI Management Adapter <sup>13</sup>	Half	32-bit	1...12	X	Universal	33
<b>Communications<sup>14</sup></b>							
37L14xx	Serial I/O SST 8, 16 and 128 Port Adapters <sup>15</sup>	Half	32-bit	1...5, 10...12 <sup>15</sup>	-	5	33
<b>Systems Management<sup>16</sup></b>							
03K9309	Advanced System Management Interconnect Cable Kit <sup>17</sup>	-	-	-	-	-	-

1. The P-6 I/O bus supports four independent 64-bit PCI buses, two of which drive eight 33 MHz, 5.0 V slots (1-5, 10-12), while the other two buses drive four 66 MHz, 3.3 V slots (6-9). The 5 V slots support Universal or 5 V adapters. A 66 MHz adapter plugged into these slots will operate at 33 MHz. The 3.3 V slots support Universal or 3.3 V adapters. A 33 MHz adapter plugged into these slots limits a 66 MHz PCI adapter installed on the same bus to 33 MHz.

2. A 64-bit adapter installed into a 32-bit slot will transfer data at 32-bit rates. Adapters rated at 66MHz will operate at 33MHz when installed in a 33MHz slot. 33MHz adapters will reduce 66MHz buses to 33MHz. 133MHz PCI-X adapters are backward compatible with 33/66MHz, 64-bit PCI-based servers.

3. All 12 Slots are hot-plug capable using IBM's Active PCI technology. For Network Operating System support access URL [www.ibm.com/pc/us/compat](http://www.ibm.com/pc/us/compat).

4. xSeries 370 includes a dual-port, dual-channel, 64-bit Wide Ultra2 SCSI controller which supports either Single Ended (SE) or Low Voltage Differential SCSI (LVDS) modes. One internal connector and one external port with a 0.8-mm Very High Density Connection Interface (VHDCI) are standard. The internal LVD SCSI cable has sufficient length to attach to an adapter located in slots 10...12. If a boot device (internal or external) is to be attached to an adapter, the adapter must reside in slots 10...12 due to BIOS scanning sequences.

5. ServeRAID-4H Ultra160 SCSI Controller is powered by a 266 MHz PowerPC 750 processor and provides four channels 128 MB of battery-backed ECC cache with two internal and up to four external Ultra160 connectors (a combination of four connectors may be utilised). External connectors are 0.8-mm VHDCI.

6. ServeRAID-4Mx Ultra160 SCSI Controller is powered by a 100MHz Intel Zion GC80303 processor that provides 64MB of battery-backed ECC cache and two internal and two external Ultra160 connections (only two connectors may be used). External connections are 0.8mm VHDCI.

7. ServeRAID-4Lx Ultra160 SCSI Controller is powered by a 100MHz Intel Zion GC80303 processor and provides a single channel, 32MB of ECC cache and either one internal or one external Ultra160 connection. External connector is 0.8mm VHDCI

8. PCI Wide Ultra160 SCSI Adapter P/N 19K4646 provides a single channel with one internal connector and a five-drop multi-mode terminated LVD SCSI cable and one external 0.8-mm VHDCI connector. Only one of the two connectors may be utilised.

9. PCI Fast/Wide Ultra SCSI Adapter P/N 02K3454 provides one external 68-pin high density connector that supports external SCSI devices such as tape enclosures

10. See Fibre Channel Solutions section for additional configuration information.

11. xSeries 370 does not include an onboard network controller.

12. In a fault-tolerant networking environment, using the fault-tolerant software delivered with the Ethernet adapters of a single manufacturer is recommended. Installing fault-tolerant solutions provided by multiple manufacturers may cause failures if the intermediate drivers provided with the adapters are not compatible. The optional Ethernet adapters listed here are Intel-based: P/Ns 06P3601, 06P3701, 22P4901, 22P6801 and provide compatible intermediate drivers for failover support.

13. The Wake on LAN function of this option is not supported by this server.

14. xSeries 370 includes two USB ports, two high-speed serial/asynchronous ports, (NS 16550A compatible), and one high-speed (up to 2 MBps data transfer speed) bi-directional parallel port supporting devices using ECP/EPP/SSP protocols adhering to the IEEE 1284 standard.

15. See Appendix F for details on Serial I/O options and configuration limitations. A maximum of four Serial I/O adapters (in any combination) may be installed.

16. xSeries 370 ships standard with an Advanced System Management PCI Adapter installed in a separate PCI slot connected through a dedicated PCI bus, leaving all 12 standard PCI slots available for PCI adapters.

17. Required to connect the standard Advanced System Management PCI Adapter to an interconnect network with other servers for system management support through a single LAN or modem connection. Up to twelve service processors or optional adapters may be interconnected with an aggregate connection length of no more than 91.4 meters (300 ft). A customer-supplied Cat5 Ethernet cable is required for each interconnection.

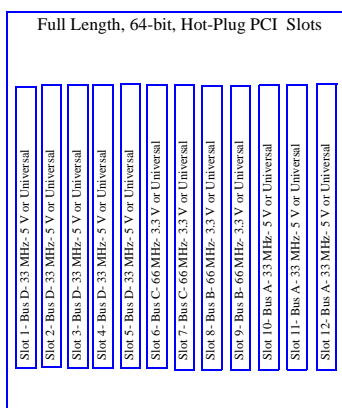

**xSeries 370 Power, Monitors, Accessories**

Part Number	Description
<b>Power<sup>1,8</sup></b>	
94G7448	Rack Power Cable Type C12 (3.7m, 12 ft.) <sup>8</sup>
<b>Uninterruptible Power Supply (UPS)<sup>2</sup></b>	
30R1xxx <sup>9</sup>	APC Smart-UPS 3000RMB <sup>3</sup>
37L6862	APC Smart-UPS 5000RMB <sup>4</sup>
<b>Monitors<sup>5</sup></b>	
T3147xx <sup>10</sup>	E54 Color Monitor 15in (350mm, 13.8in Viewable Image Size), stealth black <sup>6</sup>
T3247xx <sup>10</sup>	E74 Color Monitor 17in (403mm, 15.9in Viewable Image Size), stealth black <sup>6</sup>
T274Axx <sup>10</sup>	G78 Color Monitor 17in (406.4mm, 16.0in Viewable Image Size), stealth black <sup>6</sup>
T11AGxx <sup>10</sup>	T540 Flat Panel Color Monitor 15in (381mm, 15in viewable image), stealth black <sup>7</sup>

1. xSeries 370 systems contain three 750W (at 220V), hot-swap power supplies which handle robust configurations while providing full redundancy. Even though multiple UPSs may provide redundant power sources, systems management software does not currently take advantage of its power outage alerts.

2. For runtimes and UPS attributes see Appendix C: UPS Runtime Estimates.

3. Height is 3U. See Rack Cabinets and Options section for supported IBM racks.

4. Height is 5U. See Rack Cabinets and Options section for supported IBM racks.

5. xSeries 370 uses an SVGA controller (S3 Trio 3D chipset) with 4 MB of video memory.

6. Installation within a rack requires optional Monitor Compartment P/N 94G7444.

7. Installation within a rack requires optional Flat Panel Monitor Rack Mount Kit P/N 37L6888 and Rack Keyboard Tray P/N 28L4707. A space saver keyboard may coexist within the same keyboard tray. See Rack Cabinets and Options section for more information.

8. Rack Power Cable P/N 94G7448 (one for each Power Supply), must be ordered for power connection to a high voltage UPS or PDU.

9. Where 'xxx' represents a specific country code as follows:- DEN=Denmark, ISR=Israel, ITA=Italy, SDI=Saudi Arabia, SAF=South Africa, SWS=Switzerland, UKM=United Kingdom, EUR=Europe.

10. Where 'xx' represents a specific country code as follows:- DK=Denmark, IS=Israel, IT=Italy, SD=Saudi Arabia, SA=South Africa, CH=Switzerland, UK=UK, EU=Europe.

Part Number	Description
<b>Rack and NetBAY<sup>1,6</sup></b>	
94G7448	Rack Power Cable Type C12 (3.7m) <sup>6</sup>
<b>NOTE:</b> Refer to the Rack Cabinets and Options section for details of IBM Racks and rack-supported devices.	
<b>Keyboard and Mouse<sup>2</sup></b>	
28L36xx <sup>7</sup>	Space Saver Keyboard <sup>3,4</sup>
28L36xx <sup>8</sup>	Preferred Keyboard (stealth black) <sup>5</sup>
28L3675	Sleek 2-Button Stealth Black Mouse

1. xSeries 370 is housed in a 19" rack mountable drawer and requires one of the racks listed in the Rack Cabinets and Options section.

2. xSeries 370 ships without a keyboard or mouse.

3. Installation within a rack requires optional keyboard tray P/N 28L4707 (stows in "ready-to-use" position).

4. Advanced TrackPoint IV features are not available on IBM xSeries systems.

5. Installation within a rack requires optional keyboard tray P/N 28L4707. This keyboard cannot share a keyboard tray with a flat panel display.

6. The xSeries 370 ships with a standard country power cord. For connection to a high voltage UPS or PDU, a Rack Power Cable P/N 94G7448 (one for each power supply), must be ordered.

7. Where 'xx' represents country specific code: 46=Danish, 47=France, 48=Germany, 49=Italian, 50=Spanish, 51=UK English, 44=US English, and P/N 19K3831=Switzerland, 19K3832=Sweden/Finland, 19K3833=Portugal, 19K3834=Belgium, 19K3836=Russia, 19K3837=Poland.

8. Where 'xx' represents a specific country code as follows:- 25=French, 26=German, 27=Italian, 29=UK English, 31=Danish, 33=Norwegian, 34=Swedish/Finnish, 35=Swiss, 36=Dutch, 21=US English, and P/N 22P7325=Belgium/UK, 22P7323=Icelandic.



**xSeries 370 Tape Options**

Part Number	Description	Bays Supported <sup>1</sup>	SCSI Interface (bit)	Form Factor	Termination Included	68/50-pin Converter Incl.	Ext. Tape Encl.
00N7991	20/40GB DDS/4 4-mm SCSI Tape Drive	-	16 Ultra2 LVD	89mm (3.5in) HH or 133 mm (5.25in) HH	N	-	10L7440 <sup>3</sup> 03K8756 <sup>2</sup>
09N4040	20/40GB DLT SCSI Tape Drive	-	8	133mm (5.25in) FH	N	Y	03K8756
00N7990	40/80GB DLT SCSI Tape Drive	-	16 Ultra2 LVD	133mm (5.25in) FH	N	-	03K8756 <sup>2</sup>
00N8016	100/200GB LTO SCSI Tape Drive	-	16 Ultra2 LVD	133mm (5.25in) FH	N	-	03K8756 <sup>2</sup>
00N8015	110/220GB Super DLT Internal SCSI Tape Drive	-	16 Ultra2 LVD	133mm (5.25in) FH	N	-	03K8756 <sup>2</sup>
24P2396	100/200GB LTO SCSI HH Tape Drive	-	16 Ultra2 LVD	133mm (5.25in) HH	N	-	03K8756 <sup>2</sup>
24P2398	40/80GB Half-High DLT/VS Internal SCSI Tape Drive	-	16 Ultra2 LVD	133mm (5.25in) HH	N	-	03K8756 <sup>2</sup>
<b>Tape Autoloaders</b>							
00N79xx <sup>11</sup>	DLT SCSI Tape Autoloader	-	16	Desktop	Y	-	-
00N7992	120/240GB DDS/4 SCSI Tape Autoloader	-	16 Ultra2 LVD	133mm (5.25in) FH	N	-	03K8756 <sup>2</sup>
09N40xx <sup>12</sup>	3600 Series 900GB/1.8TB LTO SCSI Tape Autoloader <sup>4</sup>	-	16 Ultra2 LVD	Tower or 6U Rack	Y	-	-
<b>External Tape Libraries<sup>5</sup></b>							
00N79xx <sup>13</sup>	DLT SCSI Tape Library	-	16	Desktop or Rack	Y	-	-
21P99xx <sup>14</sup>	3600 Series 2/4TB LTO SCSI Tape Library (Tower)	-	16 Ultra2 LVD	Tower	Y	-	-
21P99xx <sup>14</sup>	3600 Series 2/4TB LTO SCSI Tape Library (Rack)	-	16 Ultra2 LVD	5U Rack	Y	-	-
21P99xx <sup>15</sup>	3600 Series 2-Drive, 20-Cartridge Expander Module <sup>6</sup>	-	16 Ultra2 LVD	5U Rack	Y	-	-
09N4048	3600 Series LTO Drive Upgrade Option <sup>7</sup>	-	16 Ultra2 LVD	-	N	-	-
<b>External Tape Enclosures</b>							
10L7440	External Half High SCSI Storage Enclosure <sup>8</sup>	-	8/16	Desktop	N	N	-
03K8756	NetMEDIA Storage Expansion Unit EL <sup>9</sup>	-	16	Rack	Y	N	-
10L7113	NetMEDIA Systems Management Adapter <sup>10</sup>	-	16 LVD	-	N	N	03K8756
<b>Associated Options</b>							
00N7956	68-pin External Multimode LVD/SE SCSI Terminator	-	16 LVD/SE	Ext.	Y	N	10L7440
10K2340	Media BayTray and LVD Cable Kit <sup>1</sup>	-	16 LVD	Int.	Y	N	03K8756

- xSeries 370 does not support internal tape drives but does include an external Ultra2 0.8-mm VHDCI SCSI connector for attachment of an external tape library or tape enclosure. All tape drives and enclosures are also supported by PCI Wide Ultra160 SCSI Adapter P/N 19K4646 which has an external 0.8-mm VHDCI connector. Select tape drive, enclosure and controller then use Appendix D: Cables-Storage Units-Controllers to select an appropriate external cable
- LVD support for LVD devices installed in a NetMEDIA Storage Expansion Unit EL P/N 03K8756 requires replacement of the standard single-ended internal cables with one or more (depending on configuration) cables from Media Bay Tray and LVD Cable Kit P/N 10K2340 which contains a single two-drop multi-mode LVD-SCSI terminated cable. If the standard cables are used for attachment to LVD devices, single-ended SCSI rules and bus speeds apply.
- Requires 68-pin External Multimode LVD/SE SCSI terminator P/N 00N7956.
- If installed in a rack, a fixed shelf is required. Allow an additional 1U for the fixed shelf. One unit only per shelf is supported.
- Tape library attributes and prerequisites are located in Appendix B: Tape Library Attributes.
- Supported only with the 3600 Series LTO Tape Library (Rack) P/N 21P99xx. One additional EIA space has to be allowed when installing either one or two units (maximum) - to accommodate a filler plate for cable routing. Up to two 3600 Series LTO Drive Upgrade Options can be installed in each module or the module can operate off the LTO drives installed in the LTO tape library.
- Install in second drive bay of 3600 Series LTO Tape Libraries or in either of the two bays of 3600 Series 2-drive, 20-cartridge Expander Module to increase performance. Includes an LTO (Ultrium) drive and a one-meter external LVD SCSI cable.
- Provides a black desktop 133 mm (5.25") half-high (HH) tape enclosure. Connector is configurable as 50-pin Centronix or 68-pin high density. Requires either tape drive self termination or 68-pin External Multimode LVD/SE SCSI Terminator P/N 00N7956.
- NetMEDIA Storage Expansion Unit EL P/N 03K8756 is a black 3U, 19" rack or NetBAY3/3E mountable tape enclosure which includes two full high (FH) or four half high (HH) extended length 133 mm (5.25") bays, two external 0.8mm VHDCI connectors and two internal four-drop single-ended terminated 16-bit SCSI cables for device attachment. Two power supplies and two power cords are also included. Tip: The front rail clips will need to be reversed and screwed in from behind to secure the unit in a Rack Cabinet P/N 930842x.
- NetMEDIA Systems Management Adapter P/N 10L7113 may be installed in a NetMEDIA Storage Expansion Unit to provide repeater function, LVDS interface, aggregate cable lengths up to 12 meters when attached to an LVD SCSI controller, and auto-termination when the Expansion Unit is powered off. External connector is 0.8mm VHDCI.
- Where 'xx' represents a specific country code as follows:- 70=UK, 71=Swiss, 72=Italy, 73=Israel, 33L4981=EU1, 33L4982=Denmark, 33L4983=South Africa/India.
- Where 'xx' represents a specific country code as follows:- 49=UK, 50=Europe, 51=Denmark, 52=South Africa, 53=Switzerland, 54=Italy, 55=Israel.
- Where 'xx' represents a specific country code as follows:- *Tower versions* - 74=EU1, 75=Denmark, 76=India/South Africa, 77=UK, 78=Swiss, 79=Italy, 80=Israel; *Rack versions* - 81=EU1, 82=Denmark, 83=India/South Africa, 84=UK, 85=Swiss, 86=Italy, 87=Israel.
- Where 'xx' represents a specific country code as follows:- *Tower version* - 71=Europe, 72=Denmark, 73=South Africa, 70=UK, 74=Swiss, 75=Italy, 76=Israel; *Rack version* - 78=Europe, 79=Denmark, 80=South Africa, 77=UK, 81=Swiss, 82=Italy, 83=Israel.
- Where 'xx' represents a specific country code as follows:- 85=Europe, 86=Denmark, 87=South Africa, 84=UK, 88=Swiss, 89=Italy, 90=Israel.

Note: Additional tape details can be found in Appendix A: Tape Drive Attributes.

Note: For a complete list of all IBM and non-IBM options compatibility with Network Operating Systems and IBM xSeries and Netfinity Servers, access the IBM ServerProven compatibility pages on the Web at URL <http://www.ibm.com/pc/us/compat>



### xSeries 370 Sample Configurations

The following sample configurations are for illustration only and may not be suitable for any specific customer installation. Contact your IBM Business Partner or IBM Marketing Representative for assistance with your specific configuration requirements.

#### High Availability-Rack

Part Number	Description	Quantity	Usage
K12RXxx	xSeries 370 700MHz/2MB, 512MB, Open	1	Power Redundancy standard
10K2166	700MHz/2MB Upgrade with Pentium III Xeon Processor	5	Total of 6 SMP processors
10K2335	4X Accelerator Filter	1	Required for greater than 4 processors in this model
10K2337	Mezzanine Expansion Kit	1	Required for greater than 4 processors in this model
20L0247	256MB SDRAM ECC RDIMM II	8	Total of over 2GB of memory
28L4454	Memory Expansion Card	1	Enables cache line interleaving
37L7204	9.1GB 10K-4 Ultra160 SCSI Hot-Swap SL HDD	2	NOS mirroring
37L6889	ServeRAID-4H Ultra160 SCSI Controller	1	RAID Controller - NOS plus EXP300
06P3601	10/100 Ethernet Server Adapter	1	-
T3147xx	E54 Color Monitor 15in (13.8in Viewable Image Size), stealth black	1	-
28L36xx	Space Saver Keyboard	1	-
37L6862	APC Smart-UPS 5000RMiB	1	-
<b>External Storage</b>			
03K8756	NetMEDIA Storage Expansion Unit EL	1	External Tape Drive Enclosure
00N7990	40/80GB DLT Internal SCSI Tape Drive	2	Installs in NetMEDIA Enclosure
10K2340	Media Bay Tray and LVD Cable Kit	1	-
19K11xx	EXP300 Storage Expansion Unit	1	Provides additional 10 bays
03K9310	2m Ultra2 SCSI Cable	1	Tape Enclosure to Onboard SCSI
37L7204	9.1GB 10K-4 Ultra160 SCSI Hot-Swap SL HDD	6	RAID 5 with Hot-Spare in EXP300
<b>Rack Options</b>			
9306200	NetBAY22	1	Monitor and keyboard mount on top
36L9702	NetBAY22 Rack Extension Kit	1	Required for rear door closure
94G7448	Power Cable - Type C12	5	-
94G6670	Blank Filler Panel Kit	1	-

This high availability server is configured to act as the foundation for business critical applications, applications your business cannot afford to be without. The configuration includes enough disk drives to mirror the operating system and provide a RAID 5 data environment, power supply redundancy by the server and EXP300 and a UPS for power even during a blackout. A rack mounted tape drive is included to back up that all important asset...data. This server represents the leading edge in high availability.

#### Notes/Exchange-Stack

Part Number	Description	Quantity	Usage
K13RXxx	xSeries 370 900MHz/2MB, 512MB, Open	1	Power redundancy standard
19K4637	900MHz/2MB Upgrade with Pentium III Xeon Processor	5	Total of 6 SMP processors
10K2335	4x Accelerator Filter	1	Required for greater than 4 processors
10K2337	Mezzanine Expansion Kit	1	Required for greater than 4 processors
20L0249	512MB SDRAM ECC RDIMM II	3	Total of 2GB of memory
28L4454	Memory Expansion Card	1	Enables cache line interleaving
37L7204	9.1GB 10K-4 Ultra160 SCSI Hot-Swap SL HDD	2	NOS Mirroring
06P3601	10/100 Ethernet Server Adapter	2	-
37L6889	ServeRAID-4H Ultra160 SCSI Controller	1	RAID Controller - NOS plus EXP300
T3147xx	E54 Color Monitor 15in (13.8in Viewable Image Size), stealth black	1	-
28L36xx	Space Saver Keyboard	1	-
37L6862	APC Smart-UPS 5000RMiB	1	-
<b>External Storage</b>			
03K8756	NetMEDIA Storage Expansion Unit EL	1	External Tape Enclosure - Install in NetBAY3E
00N7990	40/80GB DLT Internal SCSI Tape Drive	2	Installs in NetMEDIA Enclosure
10K2340	Media Bay Tray and LVD Cable Kit	1	-
03K9310	2m Ultra2 SCSI Cable	1	Tape Enclosure to Onboard SCSI
19K11xx	EXP300 Storage Expansion Unit	1	Provides additional 14 Bays, 1 x 2M cable
3L7205	18.2GB 10K-4 Ultra160 SCSI Hot-Swap SL HDD	14	RAID 5 with Hot-Spare in EXP300
<b>Stack Options</b>			
28L4705	8Ux28D Rack-to-Tower Kit	1	-
36L9701	NetBAY3E	3	3 x 3U enclosure for UPS, EXP300, Tape





# IBM xSeries 380

Part Number  
 Withdrawal Date: ddmmyy  
 Processor Speed<sup>3</sup>  
 Number of Proc.(Std./Max)  
 L3 ECC Cache  
 Memory (Std/Max)  
 Form Factor  
 P/S Quantity(Std./Max)  
 Hot-Swap (Power, Slots, HDD, Fans)  
 Redundancy (Optional, Standard)  
 Adv System Management Processor  
 Onboard Ethernet (Mbps)<sup>5</sup>  
 SCSI Controller (Dual, Ultra, RAID)  
 Removable Media Bays (Tot/Av)  
 Internal Hard Disk Drive (Std/Max)  
 CD-ROM (IDE)<sup>6</sup>  
 Bays (Tot/Av)  
 Slots (Tot/Av)

xSeries 380 At-A-Glance																	
K31RXxx <sup>1</sup>	-	733MHz	1/4	2MB	1GB/64GB	Rack (7U)	4/4	P, S, H, F	S-Fans, S-Power	-	10/100	D, U160 <sup>7</sup>	2/0	72.8GB/72.8GB <sup>4</sup>	24X-10X	4/0	8/8
K33RXxx <sup>1,2</sup>	-	733MHz	1/4	2MB	1GB/64GB	Rack (7U)	4/4	P, S, H, F	S-Fans, S-Power	-	10/100	D, U160 <sup>7</sup>	2/0	72.8GB/72.8GB <sup>4</sup>	24X-10X	4/0	8/8
K32RXxx <sup>1</sup>	-	800MHz	1/4	4MB	1GB/64GB	Rack (7U)	4/4	P, S, H, F	S-Fans, S-Power	-	10/100	D, U160 <sup>7</sup>	2/0	72.8GB/72.8GB <sup>4</sup>	24X-10X	4/0	8/8
K34RXxx <sup>1,2</sup>	-	800MHz	1/4	4MB	1GB/64GB	Rack (7U)	4/4	P, S, H, F	S-Fans, S-Power	-	10/100	D, U160 <sup>7</sup>	2/0	72.8GB/72.8GB <sup>4</sup>	24X-10X	4/0	8/8

Note: This system is currently targeted at early adopters such as the scientific community and developers who are interested in porting their code from IA-32 to IA-64 to take advantage of the technological benefits of the Itanium processor. Users are advised to check with their sales representative or the Intel Web site regarding availability of operating systems and applications.

- Housed in a 19in rack-mountable drawer and ships standard without a keyboard or mouse. See Rack Cabinets and Options section for supported IBM racks.
- This model includes the installation CD for Microsoft Windows Advanced Server Limited Edition for 64-bit systems.
- Intel Itanium 64-bit processor with integrated full-speed ECC L3 cache and 2 X 133MHz FSB.
- xSeries 380 supports both Fibre Channel and SCSI external storage. The system ships with two 36.4GB HDDs installed in the two internal hot-swap HDD bays. See External Storage Expansion Overview and the sections on external storage enclosures that follow this section.
- The integrated 10/100 Ethernet adapter is Intel-based.
- Variable read rate. Actual playback speed will vary and is often less than the maximum possible.
- xSeries 380 includes an integrated dual-channel Ultra160 storage controller with one internal connector and one external 0.8mm VHDCI port.

## xSeries 380 Processor Upgrades

Part Number	Processor Upgrades <sup>1</sup>	SMP Support <sup>1</sup>	Processor Speed Upgrade <sup>2</sup>
10K3815	xSeries 380 733MHz/2MB Cache Upgrade with Itanium Processor	K31RXxx, K33RXxx	-
10K0050	xSeries 380 800MHz/4MB Cache Upgrade with Itanium Processor	K32RXxx, K34RXxx	K31RXxx, K33RXxx

- Three additional processors may be installed, providing a maximum of four. All processors must be identical in type, speed, and cache size.
- Requires removal of the standard processor. A maximum of four processors may be installed. All processors must be identical in type, speed, and cache size. Upgrades may require a BIOS update. To obtain the latest Flash BIOS, access [www.pc.ibm.com/support](http://www.pc.ibm.com/support) and enter machine "Type-Model" in Quick Path. Select "Downloadable files" and then "BIOS."

## xSeries 380 Memory

Part Number	Memory Description <sup>1</sup>
33L3258	1GB (4 x 256MB) PC100 ECC SDRAM DIMM KIT
33L3260	2GB (4 x 512MB) PC100 ECC SDRAM DIMM KIT
33L3262	4GB (4 x 1GB) PC100 ECC SDRAM DIMM KIT

1. Due to four-way interleaving, all DIMMs must be installed in groups of four. All compatible memory options are available only in packs of four.

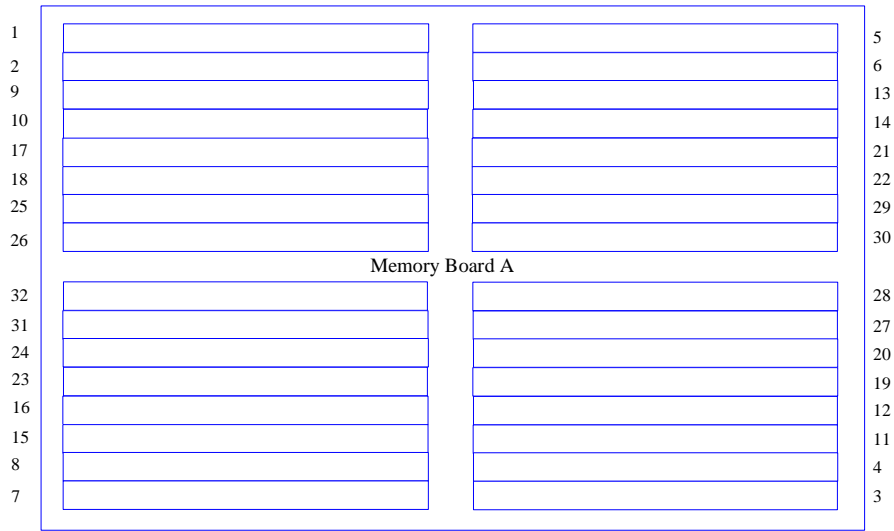

Install memory options according to the order shown for Memory Board A above. Repeat for Memory Board B.

Total Memory <sup>1</sup>	Quantity of DIMMs Added <sup>2</sup>			
	1GB Std (4 x 256MB)	1GB Kit (4 x 256MB) P/N 33L3258	2GB Kit (4 x 512MB) P/N 33L3260	4GB Kit (4 x 1GB) P/N 33L3262
2GB		1	-	-
3GB		2	-	-
4GB		1 and	1	-
5GB		-	2	-
6GB		1 and	2	-
7GB		-	3	-
8GB		1 and	1 and	1
9GB		-	2 and	1
10GB		1 and	-	2
11GB		-	1 and	2
12GB		1 and	1 and	2
15GB		-	1 and	3
17GB		-	-	4
21GB		-	-	5
25GB		-	-	6
29GB		-	-	7
33GB		-	-	8
37GB		-	-	9
41GB		-	-	10
45GB		-	-	11
49GB		-	-	12
53GB		-	-	13
57GB		-	-	14
61GB		-	-	15
64GB (max) <sup>3</sup>		-	-	16 <sup>3</sup>

This table does not represent all possible memory configurations. Memory options are available only in packs of four.

1. Network operating systems may limit the maximum amount of addressable memory. See operating system specifications for further information.
2. To obtain the quantity of memory identified in the "Total Memory" column, select the appropriate row and order the quantity of DIMMs identified in all columns for that row, which will be added to the standard memory noted at the top of the far left column.
3. Requires removal of standard DIMMs.

### xSeries 380 HDD Storage Configurator

Bay	Form Factor	Height	Front Access	Usage	Part Number	External Storage Expansion Units <sup>1</sup>	Form Factor
1	133mm (5.25in)	SL	yes	CD-ROM	19K11xx <sup>6</sup>	FASiT200 Storage Server <sup>2, 3, 5</sup>	Rack (3U)
2	89mm (3.5in)	SL	yes	Diskette	19K11xx <sup>7</sup>	FASiT200 HA Storage Server <sup>2, 5</sup>	Rack (3U)
3, 4	89mm (3.5in)	HH <sup>1</sup>	yes	Std hot-swap HDDs	19K1121	FASiT200 Redundant RAID Controller <sup>3</sup>	-
					00N71xx <sup>8</sup>	FASiT EXP500 Storage Expansion Unit <sup>4, 5</sup>	Rack (3U)
					94G7448	Rack Power Cable Type C12 (3.7m, 12 ft.) <sup>5</sup>	-

1. The hot-swap HDDs supported for installation in bays three and four and shipped as standard, are slim-line (SL). Half-high (HH) height is required to accommodate the carrier in which the HDDs are installed before insertion into the bays.

Note: xSeries 380 ships standard with a 36.4GB, 10,000RPM hot-swap Ultra160 SCSI HDD installed in each of the two internal HDD bays.

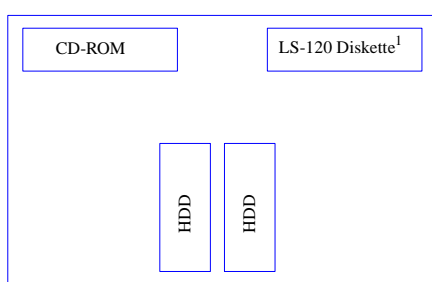

1. LS-120 slim-line diskette drive supports a diskette with capacity of 120MB.

1. xSeries 380 includes an integrated dual-channel Ultra160 storage controller. For External Fibre Channel storage devices, refer to the Fibre Channel Solutions Overview section.
2. The FASiT200 Storage Server and HA Storage Server each include two hot-swap, 350 W auto-ranging redundant power supplies each with its own standard country power cord.
3. Can be upgraded to a FASiT200 HA Storage Server through the addition of a FASiT200 Redundant RAID Controller P/N 19K1121.
4. FASiT EXP500 Storage Expansion Unit includes dual hot-swap 350W power supplies, each with its own standard country power cord.
5. These units do not include Rack Power Cables P/N 94G7448 when shipped (for attachment to high voltage UPS or PDU). Standard country power cords only are included. If required, order Rack Power Cables according to the number of power supplies.
6. Where 'xx' represents a specific country code as follows:- 23=US/English, 24=Euro/English, 25=Euro/Spanish, 27=Euro/German, 28=Denmark/English, 29=Israel/English, 30=Italy/English, 31=South Africa/English, 32=Switzerland/English, 34=Switzerland/German, 36=UK/English. Country/Language - Line Cords/Publications are included as indicated.
7. Where 'xx' represents a specific country code as follows:- 37=US/English, 38=Euro/English, 39=Euro/Spanish, 41=Euro/German, 42=Denmark/English, 43=Israel/English, 44=Italy/English, 45=South Africa/English, 46=Switzerland/English, 48=Switzerland/German, 50=UK/English. Country/Language - Line Cords/Publications are included as indicated.
8. Where 'xx' represents a specific country code as follows:- 36=US/English, 37=Euro/English, 41=Denmark/English, 42=Israel/English, 43=Italy/English, 44=South Africa/English, 45=Switzerland/English, 49=UK/English. Country/Language Line Cords/Publications are included as indicated.

### xSeries 380 I/O Options

Part Number	Description	Adapter Length	PCI Support <sup>4</sup>	Slots Supported	Hot-Plug <sup>5</sup>	PCI Voltage Key	MHz <sup>4</sup>
<b>Storage Controllers<sup>1, 2</sup></b>							
19K4646	PCI Wide Ultra160 SCSI Adapter <sup>3</sup>	Half	32-bit	1 ... 8	-	Universal	66
<b>Fibre Storage Controller<sup>6</sup></b>							
00N6881	FASiT Host Adapter	Half	64-bit	1 ... 8	X	Universal	66
19K1246	FASiT FC-2 Host Bus Adapter	Half	64-bit	1 ... 8	X	Universal	66
<b>Networking<sup>7</sup></b>							
<b>Ethernet<sup>8</sup></b>							
06P3601	10/100 Ethernet Server Adapter <sup>9</sup>	Half	32-bit	1 ... 8	X	Universal	33
06P3701	Gigabit Ethernet SX Server Adapter (fibre optic interface)	Half	64-bit	1 ... 8	X	Universal	66
22P6801	PRO/1000XT Server Adapter by Intel (with CD and manuals) <sup>11</sup>	Half	64-bit	1 ... 8	X	Universal	133

1. xSeries 380 includes an integrated dual-channel Ultra160 storage controller. External storage is supported through the external 0.8mm VHDCI connector or a supported optional PCI SCSI controller.
2. An optional RAID adapter is required to support external HDD storage. Refer to ServerProven test results for supported RAID options at [www.pc.ibm.com/us/compat](http://www.pc.ibm.com/us/compat). Select x380 from the Fast Access pulldown menu and click Go. Select SCSI and RAID Controllers. IBM makes no representations or warranties with respect to non-IBM products. These products are offered and warranted by third parties, not IBM.
3. PCI Wide Ultra160 SCSI Adapter P/N 19K4646 provides a single channel with one internal connector, a five-drop multi-mode terminated LVD SCSI cable and one external 0.8mm VHDCI connector. Only one of the two connectors may be utilised.
4. 33MHz adapters will reduce 66MHz buses to 33MHz. 133MHz PCI-X adapters are backward compatible with 33/66MHz, 64-bit PCI-based servers.
5. All eight slots are hot-plug capable. For Network Operating System support, access [www.pc.ibm.com/us/compat](http://www.pc.ibm.com/us/compat).
6. See Fibre Channel Solutions Overview section for additional configuration information.
7. In a fault-tolerant networking environment, using the fault-tolerant software delivered with the Ethernet adapters of a single manufacturer is recommended. Installing fault-tolerant solutions provided by multiple manufacturers may cause failures if the intermediate drivers provided with the adapters are not compatible. The Intel-based optional Ethernet adapters listed here: P/Ns 06P3601, 06P3701, 22P6801, provide compatible intermediate drivers for failover support.
8. xSeries 380 includes an integrated 10/100 Intel-based Ethernet adapter that supports Wake on LAN.
9. The Wake on LAN function of this option is not supported by this server.

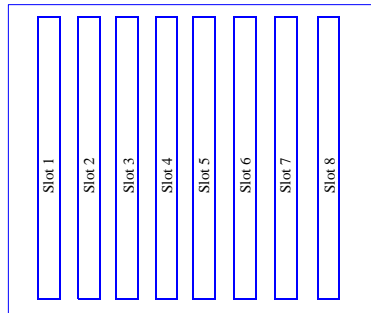

All slots are full-length, 64-bit, 66MHz, 3.3V (5V tolerant).

**xSeries 380 Power, Monitors, Accessories**

Part Number	Description
<b>Power<sup>1,7</sup></b>	
94G7448	Rack Power Cable Type C12 (3.7m, 12 ft.) <sup>7</sup>
<b>Uninterruptible Power Supply (UPS)<sup>2</sup></b>	
30RIxxx <sup>8</sup>	APC Smart-UPS 3000RMB <sup>3</sup>
37L6862	APC Smart-UPS 5000RMB <sup>4</sup>
<b>Monitors<sup>5</sup></b>	
T3247xx <sup>9</sup>	E74 Color Monitor 17in (406mm, 16in viewable image), stealth black <sup>6</sup>

1. xSeries 380 contains four 800W, hot-swap power supplies which handle robust configurations while providing full redundancy.
2. For UPS attributes see UPS Appendix C:
3. Height is 3U. See Rack Cabinets and Options section for supported IBM racks.
4. Height is 5U. See Rack Cabinets and Options section for supported IBM racks.
5. xSeries 380 uses an integrated ATI-Rage XL video controller with 8MB memory.
6. Installation within a rack requires optional Monitor Compartment P/N 94G7444.
7. Rack Power Cable P/N 94G7448 (one for each Power Supply), must be ordered for power connection to a high voltage UPS or PDU.
8. Where 'xxx' represents a specific country code as follows:- DEN=Denmark, ISR=Israel, ITA=Italy, SDI=Saudi Arabia, SAF=South Africa, SWS=Switzerland, UKM=United Kingdom, EUR=Europe.
9. Where 'xx' represents a specific country code as follows:- DK=Denmark, IS=Israel, IT=Italy, SD=Saudi Arabia, SA=South Africa, CH=Switzerland, UK=UK, EU=Europe.

Part Number	Description
<b>Rack and NetBAY<sup>1,5</sup></b>	
94G7448	Rack Power Cable Type C12 (3.7m) <sup>5</sup>
<b>NOTE: Refer to the Rack Cabinets and Options section for details of IBM Racks and rack-supported devices.</b>	
<b>Keyboard and Mouse<sup>2</sup></b>	
28L36xx <sup>8</sup>	Space Saver II Keyboard <sup>3,4</sup>
28L3675	Sleek 2-Button Stealth Black Mouse

1. xSeries 380 is housed in a 19in rack-mountable drawer. For selection of a supported rack, refer to the Rack Cabinets and Options section.
2. xSeries 380 ships without a keyboard or mouse.
3. Installation within a rack requires optional keyboard tray (P/N 28L4707), which stows in ready-to-use position.
4. Advanced TrackPoint IV features are not available on IBM xSeries or Netfinity systems.
5. The xSeries 380 ships with a standard country power cord. For connection to a high voltage UPS or PDU, a Rack Power Cable P/N 94G7448 (one for each power supply), must be ordered.





# IBM EXP300

## EXP300 Hard Disk Drive (HDD) Configurator

Total Int. Storage <sup>1</sup>	10,000RPM Ultra160 SCSI HDDs				15,000RPM Ultra160 SCSI HDDs	
	9.1GB P/N 37L7204	18.2GB P/N 37L7205 or 06P5754	36.4GB P/N 37L7206 or 06P5755	73.4GB P/N 06P5756	18.2GB P/N 19K0656 or 06P5767	36.4GB P/N 06P5768
0GB	0GB Standard on Base Models				0GB Standard on Base Models	
18.2GB	2 or	1	-	-	1	-
36.4GB	4 or	2 or	1	-	2 or	1
54.6GB	6 or	3	-	-	3	-
72.8GB	8 or	4 or	2	-	4 or	2
91GB	10 or	5	-	-	5	-
109.2GB	12 or	6 or	3	-	6 or	3
127.4GB	14 or	7 or	-	-	7	-
145.6GB	-	8 or	4	-	8 or	4
182GB	-	10 or	5	-	10 or	5
218.4GB	-	12 or	6	-	12 or	6
254.8GB	-	14 or	7	-	14 or	7
291.2GB	-	-	8	-	-	8
364.0GB	-	-	10	-	-	10
436.8GB	-	-	12	-	-	12
509.6GB	-	-	14	-	-	14
587.2GB	-	-	-	8	-	-
734.0GB	-	-	-	10	-	-
880.8GB	-	-	-	12	-	-
1027.6GB (max.)	-	-	-	14	-	-

This table does not represent all possible hard disk drive (HDD) configurations.

1. Select a total storage row then select the quantity of HDDs from a column corresponding to the HDD of choice. Total Internal Storage listed is within +/- 0.2 GB unless otherwise noted.

SCSI ID	Form Factor	Height	Front Access	Usage	Part Number	Description	RPM	Height	Bays Supported <sup>1</sup>	Max. Qty.
0...6	HS	SL	Yes	open	<b>Hot-Swap Ultra 160 SCSI HDDs</b>					
8...14	HS	SL	Yes	open	37L7204	9.1GB 10K-4 Ultra160 Hot-Swap HDD	10000	SL	1...14	14 <sup>2</sup>
					37L7205	18.2GB 10K-4 Ultra160 Hot-Swap HDD	10000	SL	1...14	14 <sup>2</sup>
					06P5754	18.2GB 10,000rpm Ultra160 Hot-Swap HDD	10000	SL	1...14	14 <sup>2</sup>
					37L7206	36.4GB 10K-4 Ultra160 Hot-Swap HDD	10000	SL	1...14	14 <sup>2</sup>
					06P5755	36.4GB 10,000rpm Ultra160 Hot-Swap HDD	10000	SL	1...14	14 <sup>2</sup>
					06P5756	73.4GB 10,000rpm Ultra160 Hot-Swap HDD	10000	SL	1...14	14 <sup>2</sup>
					06P5767	18.2GB 15,000rpm Ultra160 Hot-Swap HDD	15000	SL	1...14	14 <sup>2</sup>
					19K0656	18.2GB 15,000rpm Ultra160 Hot-Swap HDD	15000	SL	1...14	14 <sup>2</sup>
					06P5768	36.4GB 15,000rpm Ultra160 Hot-Swap HDD	15000	SL	1...14	14 <sup>2</sup>
					<b>External Storage Expansion Unit</b>		<b>Form Factor</b>			
					19K11xx <sup>5</sup>	EXP300 Storage Expansion Unit <sup>3,4</sup>	Rack (3U)			
					09N7296	EXP300 Rack-to-Tower Conversion Kit	-			
					94G7448	Rack Power Cable Type C12 (3.7m) <sup>4</sup>	-			

1. EXP300 Storage Expansion Unit ships with 14 slim-line hot-swap bays which can be configured as a single bus, two independent buses or a twintailed single bus.

2. Twintailing reduces the maximum number of HDDs on a single bus to 13.

3. The EXP300 includes a single 2 M Ultra2 SCSI cable and dual hot-swap 500W redundant power supplies, each with its own standard country power cord.

4. This unit does not include a Rack Power Cable P/N 94G7448 when shipped (for attachment to high voltage UPS or PDU). A standard country power cord only is included. If required, order one Rack Power Cable for each power supply.

5. Where 'xx' represents a specific country code as follows: 51=US/English, 52=European/English, 56=Danish/English, 57=Israel/English, 58=Italian/English, 59=South Africa/English, 60=Swiss/English, 63=UK/English;- Line Cords/ Publication Country Kits are included as indicated.

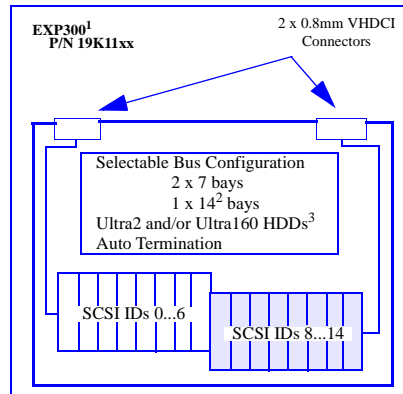

1. Housed in a 19in rack mountable drawer and ships standard with redundant 500 W hot-swap power supplies, two power cords and a single 2M Ultra2 SCSI cable capable of supporting Ultra160 speeds.
2. Twintailing reduces the maximum number of HDDs on a single bus to 13.
3. When combined with a ServeRAID-4x controller, Ultra2 and Ultra160 HDDs may be mixed on the same bus and operate at up to their maximum respective speeds.

Requires IBM NetBAY 42 Enterprise Rack or Expansion Cabinet (930842S, E), NetBAY 42 Standard Rack Cabinet or Expansion Cabinet (9306420, 1), NetBAY 25 (9306250), NetBAY 22 (9306200), NetBAY 3 (10L6912), NetBAY 3E (36L9701) or Rack-to-Tower Conversion Kit (09N7296).

External Storage Expansion Units require storage controllers and external cables. Select a supported controller from the system configurator and cables from Appendix D: Cables-Storage Units-Controllers.

### EXP300 Storage Expansion Unit P/N 19K11xx

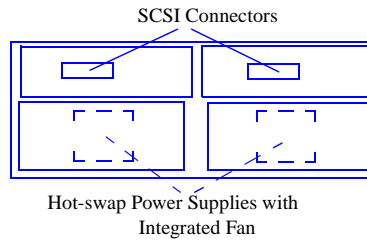

- Fourteen slim-high drive bays.
- Supports Ultra160 SCSI data transfer speeds - up to 160MB/s.
- Single or dual SCSI bus configurations.
- Dual hot-swap 500 redundant power supplies with integrated fan assemblies.
- Height is 3U (1U=1.75in or 44.45mm).
- Tower capability through optional Rack-to-Tower Conversion Kit.
- Requires Netfinity Enterprise Rack or Expansion Cabinet, IBM NetBAY Enterprise Rack or Expansion Cabinet, Netfinity Rack, Netfinity NetBAY22 or 19in EIA-D Industry-Standard Rack. Mounting rails are included with the unit.

#### Cables and Controllers:

See Appendix D: Cables - Storage Units - Controllers

EXP300 Sample Configurations

**EXP300 One Independent SCSI Bus**

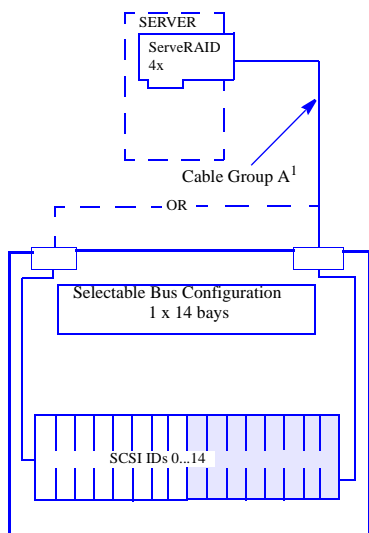

- Order:
- 1 x P/N 19K11xx
  - 1 x External Cable from Group A¹
  - Up to 14 Ultra2 and/or Ultra160 HDDs

1. One 2 M Ultra2 cable is included with each EXP300. If a longer cable is desired, select one from cable group A.

**EXP300 One Independent Twintail SCSI Bus High Availability Configuration**

To configure as one independent twintailed 13 bay SCSI bus, attach two external cables from two ServeRAID adapters, in the same or separate servers, to the two external ports of the EXP300. The EXP300 must be set for 1 x 14<sup>2</sup> bays.

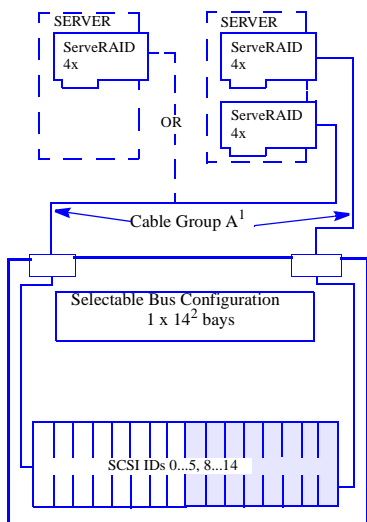

- Order:
- 1 x P/N 19K11xx
  - 2 x External Cables from Group A¹
  - Up to 13 Ultra2 and/or Ultra160 HDDs

1. One 2 M Ultra2 cable is included with each EXP300. If a longer cable is desired, select one from cable group A.  
 2. Twintailing reduces the maximum number of HDDs on a single bus to 13.

**EXP300 Two Independent SCSI Buses**

To configure as two independent 7 bay SCSI buses, attach two external cables from two ServeRAID adapters, in the same or separate servers, to the two external ports of the EXP300. The EXP300 must be set for 2 x 7 bays.

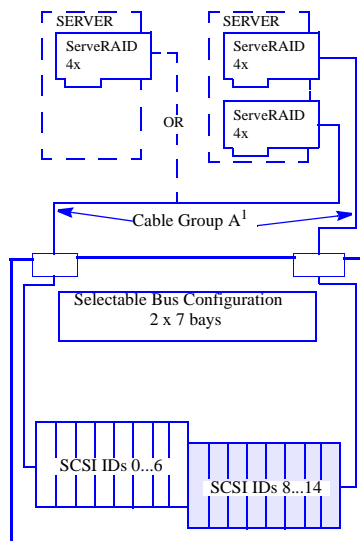

- Order:
- 1 x P/N 19K11xx
  - 2 x External Cables from Group A¹
  - Up to 14 Ultra2 and/or Ultra160 HDDs

1. One 2 M Ultra2 cable is included with each EXP300. If a longer cable is desired, select one from cable group A.





# Fibre Channel Solutions Overview

## Fibre Channel Solutions Overview At-A-Glance

Part Number	Description	Topology	Max Supported Storage	Host Partitions	Host Fabric Ports (std/max)	Max Redundant Host Connections	Drive Side Mini Hubs (std/max)	Redundant Drive Loops (std/max)	Form Factor
<b>FASiT Storage Servers</b>									
19K11xx <sup>5</sup>	FASiT200 Storage Server	Fibre-over-Fibre	734GB <sup>1</sup>	16	1/1	0	-	0	3U
19K11xx <sup>6</sup>	FASiT200 HA Storage Server	Fibre-over-Fibre	4.4TB <sup>2</sup>	16	2/2	1	-	1	3U
00N69xx <sup>7</sup>	FASiT500 Storage Server	Fibre-over-Fibre	16.15TB <sup>3</sup>	16	4/8	4	2/4	1/2	4U
24P09xx <sup>8</sup>	FASiT700 Fibre Channel Storage Server	Fibre-over-Fibre	16.15TB <sup>3</sup>	64	4/8	4	2/4	1/2	4U
<b>Fibre Channel HDD Expansion Units</b>									
00N71xx <sup>9</sup>	FASiT EXP500	Fibre-over-Fibre	734GB	-	2/2	-	-	-	3U
<b>1Gb Fibre Channel Fabric Components</b>									
00N6881	FASiT Host Adapter	-	-	-	-	-	-	-	-
00N6882	FASiT500 Mini Hub	-	-	-	-	-	-	-	-
00N6883	FASiT500 256MB Cache	-	-	-	-	-	-	-	-
19K1121	FASiT200 Redundant RAID Controller	-	-	-	-	-	-	-	-
2108R3L	SAN Data Gateway Router UltraSCSI LVD Port	-	-	-	-	-	-	-	-
09N4047	Fibre Tape Automation Adapter	-	-	-	-	-	-	-	-
2109S08	SAN FC Switch, 8-Port	-	-	-	-	-	-	-	-
2109S16	SAN FC Switch, 16-Port	-	-	-	-	-	-	-	-
35L1647	SAN FC Managed Hub	-	-	-	-	-	-	-	-
03K9307	FC Long-Wave GBIC	-	-	-	-	-	-	-	-
03K9308	FC Short-Wave GBIC	-	-	-	-	-	-	-	-
03K9305	Netfinity Fibre Channel 25M Cable	-	-	-	-	-	-	-	-
03K9306	Netfinity Fibre Channel 5M Cable	-	-	-	-	-	-	-	-
36L9973	Netfinity Fibre Channel 1M Cable	-	-	-	-	-	-	-	-
<b>2Gb Fibre Channel Fabric Components</b>									
19K1246	FASiT FC-2 Host Bus Adapter	-	-	-	-	-	-	-	-
19K1269	FASiT700 Mini Hub	-	-	-	-	-	-	-	-
2109F16	SAN FC Switch, 16-Port (2Gb)	-	-	-	-	-	-	-	-
19K1271	Short-Wave SFP Module	-	-	-	-	-	-	-	-
19K1272	Long-Wave SFP Module	-	-	-	-	-	-	-	-
19K1247	1M LC-LC Fibre Channel Cable	-	-	-	-	-	-	-	-
19K1248	5M LC-LC Fibre Channel Cable	-	-	-	-	-	-	-	-
19K1249	25M LC-LC Fibre Channel Cable	-	-	-	-	-	-	-	-
19K1250	LC-SC Fibre Channel Adapter Cable <sup>4</sup>	-	-	-	-	-	-	-	-
<b>Fibre Channel HDDs</b>									
19K0653	Netfinity 36.4GB 10K-4 FC Hot-Swap HDD	-	-	-	-	-	-	-	-
19K0654	Netfinity 73.4GB 10K-4 FC Hot-Swap HDD	-	-	-	-	-	-	-	-
06P5707	Netfinity 18.2GB 15Krpm FC Hot-Swap HDD	-	-	-	-	-	-	-	-

- Attaching expansion units to a FASiT200 Storage Server is not recommended because a single point-of-failure occurs when external storage is connected through only one RAID controller. The maximum storage value is based on 10 internal 73.4GB internal FC HDDs.
- Based on a maximum of 60 73.4GB FC HDDs installed in the redundant storage loop that includes the FASiT200 internal HDD bays and five FASiT EXP500 expansion units.
- Based on a maximum of 220 73.4GB FC HDDs installed in a maximum of 22 FASiT EXP500 expansion units. A maximum of 11 expansion units are supported in a redundant drive loop (cable pair). Four drive-side mini hubs are required to support two pairs of loops running in redundant mode.
- The LC-SC Fibre Channel Adapter Cable P/N 19K1250 is designed to connect any 1Gb device or cable to any 2Gb device or cable. When 2Gb and 1Gb technology are combined in a configuration, the signal transfer automatically converts to the slower speed.
- Where 'xx' represents a specific country code as follows: 23=US/English, 24=Euro/English, 25=Euro/Spanish, 27=Euro/German, 28=Denmark/English, 29=Israel/English, 30=Italy/English, 31=South Africa/English, 32=Switzerland/English, 34=Switzerland/German, 36=UK/English. Country/Language - Line Cords/Publications are included as indicated.
- Where 'xx' represents a specific country code as follows: 37=US/English, 38=Euro/English, 39=Euro/Spanish, 41=Euro/German, 42=Denmark/English, 43=Israel/English, 44=Italy/English, 45=South Africa/English, 46=Switzerland/English, 48=Switzerland/German, 50=UK/English. Country/Language - Line Cords/Publications are included as indicated.
- Where 'xx' represents a country specific code as follows: 13=US/English, 14=Euro/English, 18=Denmark/English, 19=Israel/English, 20=Italy/English, 21=South Africa/English, 22=Switzerland/English, 26=UK/English. Country/Language - Line Cords/Publications are included as indicated.
- Where 'xx' represents a specific country code as follows: 14=Eur/English, 15=Euro/Spanish, 18=Denmark/English, 19=Israel/English, 20=Italy/English, 21=South Africa/English, 22=Switzerland/English, 25=UK/English. Country/Language Line Cords/Publications are included as indicated.
- Where 'xx' represents a specific country code as follows: 36=US/English, 37=Euro/English, 41=Denmark/English, 42=Israel/English, 43=Italy/English, 44=South Africa/English, 45=Switzerland/English, 49=UK/English. Country/Language Line Cords/Publications are included as indicated.





# IBM FAStT EXP500

## FASTT EXP500 Storage Expansion Unit - Hard Disk Drive (HDD) Configurator

Total Internal Storage <sup>1</sup>	10,000RPM Fibre Channel HDDs		15,000RPM Fibre Channel HDD
	36.4GB (P/N 19K0653)	73.4GB (P/N 19K0654)	18.2GB (P/N 06P5707)
0GB	0GB Standard		0GB Standard
18.2GB	-	-	1
36.4GB	1	-	2
54.6GB	-	-	3
72.8GB	2	-	4
73.4GB	-	1	-
91.0GB	-	-	5
109.2GB	3	-	6
145.6GB	4	-	8
146.8GB	-	2	-
182.0GB	5	-	10
218.4GB	6	-	-
220.2GB	-	3	-
254.8GB	7	-	-
291.2GB	8	-	-
293.6GB	-	4	-
327.6GB	9	-	-
364.0GB	10	-	-
367.0GB	-	5	-
440.4GB	-	6	-
513.8GB	-	7	-
587.2GB	-	8	-
660.6GB	-	9	-
734.0GB (max)	-	10	-

This table does not represent all valid hard disk drive (HDD) configurations.

1. Select a total storage row and then select the quantity of HDDs from a column corresponding to the HDD of choice. Total Internal Storage listed is within + 0.2 GB unless otherwise noted.

Part Number	Description	RPM	Height	Bays Supported	Max. Qty Supported
19K0653	36.4GB 10K-4 FC Hot-Swap HDD	10000	SL	1...10	10
19K0654	73.4GB 10K-4 FC Hot-Swap HDD	10000	HH	1...10	10
06P5707	18.2GB 15,000rpm FC Hot-Swap HDD	15000	SL	1...10	10
External Storage Expansion Unit		Form Factor			
00N71xx <sup>3</sup>	FAStT EXP500 Storage Expansion Unit <sup>1,2</sup>	Rack (3U)			
94G7448	Rack Power Cable Type C12 (3.7m) <sup>2</sup>	-			

1. The FAStT EXP500 Storage Expansion Unit includes two hot-swap, 350 W auto-ranging redundant power supplies each with it's own standard country power cord.

2. This unit does not include a Rack Power Cable P/N 94G7448 when shipped (for attachment to high voltage UPS or PDU). Standard country power cord only are included. If required, order one Rack Power Cable for each power supply.

3. Where 'xx' represents a country specific code as follows:- 36=US/English, 37=Euro/English, 41=Denmark/English, 42=Israel/English, 43=Italy/English, 44=South Africa/English, 45=Switzerland/English, 49=UK/English. Country/Language Line Cords/Publications are included as indicated.

### IBM FAStT EXP500 Storage Expansion Unit<sup>1</sup>

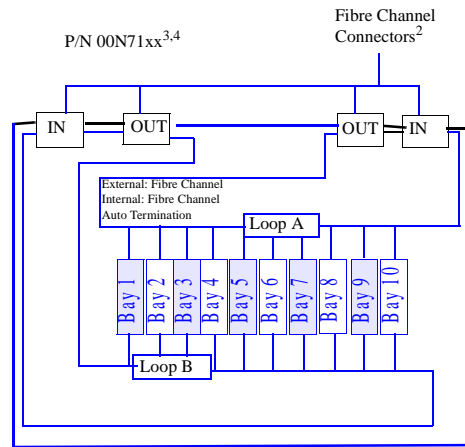

**IN** = primary or secondary (redundant) connection from FAStT500 Storage Server or previous FAStT EXP500 Storage Expansion Unit daisy-chained from the storage server  
**OUT** = primary or secondary (redundant) connection to additional FAStT EXP500 expansion units

1. Housed in a 19" Rack mountable drawer and ships standard with redundant power supplies and two standard country power cables requiring separate power sources. Requires IBM industry standard 19" rack, EIA-310D, with a minimum depth of 24" (711.2 mm) or NetBAY3/3E.

**Note:** The FAStT EXP500 Storage Expansion Unit does not ship with a storage controller or external cables. Select these items from the Fibre Channel Device Ports Reference Chart in the Fibre Array Solutions section.

2. GBICs are not included. Either Fibre Channel Long or Short-Wave GBICs (P/N 03K9307 or 03K9308 respectively) may be used.

3. Where 'xx' represents a country specific code as follows:- 36=US/English, 37=Euro/English, 41=Denmark/English, 42=Israel/English, 43=Italy/English, 44=South Africa/English, 45=Switzerland/English, 49=UK/English. Country/Language Line Cords/Publications are included as indicated.

4. This unit does not include a Rack Power Cable P/N 94G7448 when shipped (for attachment to high voltage UPS or PDU). A standard country power cord only is included. If required, order a Rack Power Cable.





# IBM FAStT200 (HA) Storage Server

## FAStT200 Storage Server - Hard Disk Drive (HDD) Configurator

Total Internal Storage <sup>1</sup>	10,000RPM Fibre Channel HDDs		15,000RPM Fibre Channel HDD
	36.4GB (P/N 19K0653)	73.4GB <sup>2</sup> (P/N 19K0654)	18.2GB (P/N 06P5707)
0GB	0GB Standard		0GB Standard
18.2GB	-	-	1
36.4GB	1	-	2
54.6GB	-	-	3
72.8GB	2	-	4
73.4GB	-	1	-
91.0GB	-	-	5
109.2GB	3	-	6
145.6GB	4	-	8
146.8GB	-	2	-
182.0GB	5	-	10
218.4GB	6	-	-
220.2GB	-	3	-
254.8GB	7	-	-
291.2GB	8	-	-
293.6GB	-	4	-
327.6GB	9	-	-
364.0GB	10	-	-
367.0GB	-	5	-
440.4GB	-	6	-
513.8GB	-	7	-
587.2GB	-	8	-
660.6GB	-	9	-
734.0GB (max)	-	10	-

This table does not represent all valid hard disk drive (HDD) configurations.

1. Select a total storage row and then select the quantity of HDDs from a column corresponding to the HDD of choice. Total Internal Storage listed is within + 0.2 GB unless otherwise noted.
2. When referring to hard disk drive capacity, GB equals one billion bytes. Total user accessible capacity may vary depending on operating environments.

Part Number	Description	RPM	Height	Bays Supported	Max. Qty Supported
19K0653	36.4GB 10K-4 FC Hot-Swap HDD	10000	SL	1...10	10
19K0654	73.4GB 10K-4 FC Hot-Swap HDD	10000	HH	1...10	10
06P5707	18.2GB 15,000rpm FC Hot-Swap HDD	15000	SL	1...10	10
External Storage Expansion Unit		Form Factor			
19K11xx <sup>4</sup>	FAStT200 Storage Server <sup>1,2,3</sup>	Rack (3U)			
19K11xx <sup>5</sup>	FAStT200 HA Storage Server <sup>1,3</sup>	Rack (3U)			
19K1121	FAStT200 Redundant RAID Controller <sup>2</sup>	-			
94G7448	Rack Power Cable Type C12 (3.7m) <sup>3</sup>	-			

1. The FAStT200 Storage Server and HA Storage Server include two hot-swap, 350 W auto-ranging redundant power supplies each with it's own standard country power cord.
2. Can be upgraded to a FAStT200 HA Storage Server through the addition of a FAStT200 Redundant RAID Controller P/N 19K1121.
3. These units do not include Rack Power Cables P/N 94G7448 when shipped (for attachment to high voltage UPS or PDU). Standard country power cords only are included. If required, order one Rack Power Cable for each power supply.
4. Where 'xx' represents a country specific code as follows:- 23=US/English, 24=Euro/English, 25=Euro/Spanish, 27=Euro/German, 28=Denmark/English, 29=Israel/English, 30=Italy/English, 31=South Africa/English, 32=Switzerland/English, 34=Switzerland/German, 36=UK/English. Country/Language - Line Cords/Publications are included as indicated
5. Where 'xx' represents a country specific code as follows:- 37=US/English, 38=Euro/English, 39=Euro/Spanish, 41=Euro/German, 42=Denmark/English, 43=Israel/English, 44=Italy/English, 45=South Africa/English, 46=Switzerland/English, 48=Switzerland/German, 50=UK/English. Country/Language - Line Cords/Publications are included as indicated.

**IBM FASiT200 Storage Server P/N 19K11xx<sup>1,2,4,6</sup>**  
**IBM FASiT200 HA Storage Server P/N 19K11xx<sup>1,2,5,6</sup>**

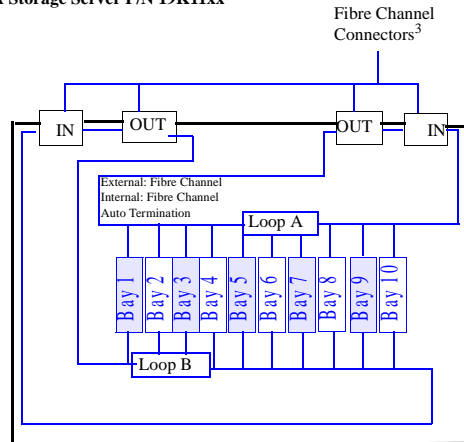

**IN** = connection to host  
**OUT** = connection to expansion units

1. Housed in a 19" Rack mountable drawer and ships standard with redundant power supplies and two standard country power cables requiring separate power sources. Requires IBM industry standard 19" rack, EIA-310D, with a minimum depth of 24" (711.2 mm) or NetBAY3/3E.

**Note:** The FASiT200 Storage Server and HA Storage Server do not ship with a storage controller or external cables. Select these items from the Fibre Channel Device Ports Reference Chart in the Fibre Array Solutions section.

2. The FASiT200 Storage Server includes a single loop only. The second loop (shown in the diagram) is available with the addition of a FASiT200 Redundant RAID Controller P/N 19K1121. This configuration then becomes equivalent to the FASiT200 HA Storage Server.

3. GBICs are not included. Either Fibre Channel long wave GBICs P/N 03K9307 or short wave GBICs P/N 03K9308 may be used.

4. Where 'xx' represents a country specific code as follows:- 23=US/English, 24=Euro/English, 25=Euro/Spanish, 27=Euro/German, 28=Denmark/English, 29=Israel/English, 30=Italy/English, 31=South Africa/English, 32=Switzerland/English, 34=Switzerland/German, 36=UK/English. Country/Language - Line Cords/Publications are included as indicated.

5. Where 'xx' represents a country specific code as follows:- 37=US/English, 38=Euro/English, 39=Euro/Spanish, 41=Euro/German, 42=Denmark/English, 43=Israel/English, 44=Italy/English, 45=South Africa/English, 46=Switzerland/English, 48=Switzerland/German, 50=UK/English. Country/Language - Line Cords/Publications are included as indicated.

6. This unit does not include a Rack Power Cable P/N 94G7448 when shipped (for attachment to high voltage UPS or PDU). A standard country power cord only is included. If required, order one Rack Power Cable for each power supply.

## Fibre / Fibre Configuration Examples (FAStT200)

Note: The following sample configurations are for illustration only and may not be suitable for any specific customer installation. Contact your IBM Business Partner or IBM Marketing Representative for assistance with your specific configuration requirements.

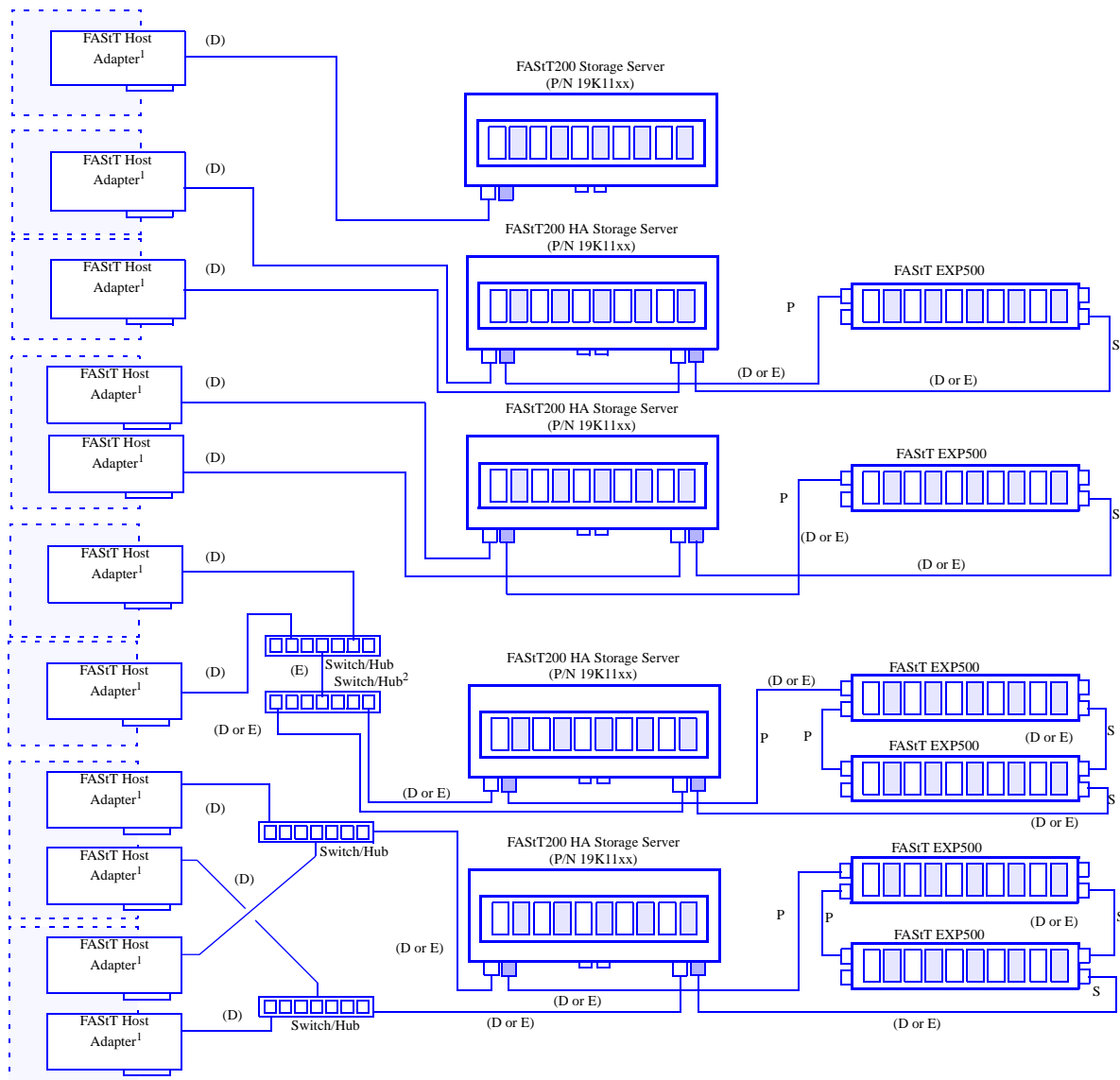

1. FAStT Host Adapter P/N 00N6881 supports short-wave connections only.
2. Buffering the long-wave optic cable expense with a second switch or hub at the remote storage location is required to requalify the signal. A managed hub supports only one long-wave GBIC.

- P = primary path, S = secondary (redundant) path
- Shaded boxes represent separate hosts.
- Cable groups are represented by letters in parenthesis.
- Maximum of 60 external storage HDDs are supported for optimum performance (up to 10 in the storage server with the remainder in expansion units).
- The number of servers that can be used in configurations with managed hubs or Fibre Channel switches are dependent on partitioning restrictions of the management system or cluster software.
- An optional short- or long-wave GBIC is required for all FAStT200 storage server and FAStT EXP500 storage connections. GBICs are not depicted in these diagrams. See device drawings at the end of this section for details.
- Other Fibre Channel devices may not require optional GBICs. For specific requirements, see the Fibre Device Ports Reference.

### Cable Group D (short-wave Fibre Channel)

36L9973 - Netfinity Fibre Channel 1M Cable  
 03K9306 - Netfinity Fibre Channel 5M Cable  
 03K9305 - Netfinity Fibre Channel 25M Cable  
 Customer supplied short-wave cable of up to 500M (0.31 miles)

### Cable Group E (long-wave Fibre Channel)

Customer supplied long-wave cable of up to 10KM 6.2 miles)

### GBIC

03K9308 - Netfinity Fibre Channel Short-Wave GBIC  
 03K9307 - Netfinity Fibre Channel Long-Wave GBIC



## Fibre / Fibre Configuration Examples FAST EXP500 with FAST500 Storage Server

Note: The following sample configurations are for illustration only and may not be suitable for any specific customer installation. Contact your IBM Business Partner or IBM Marketing Representative for assistance with your specific configuration requirements.

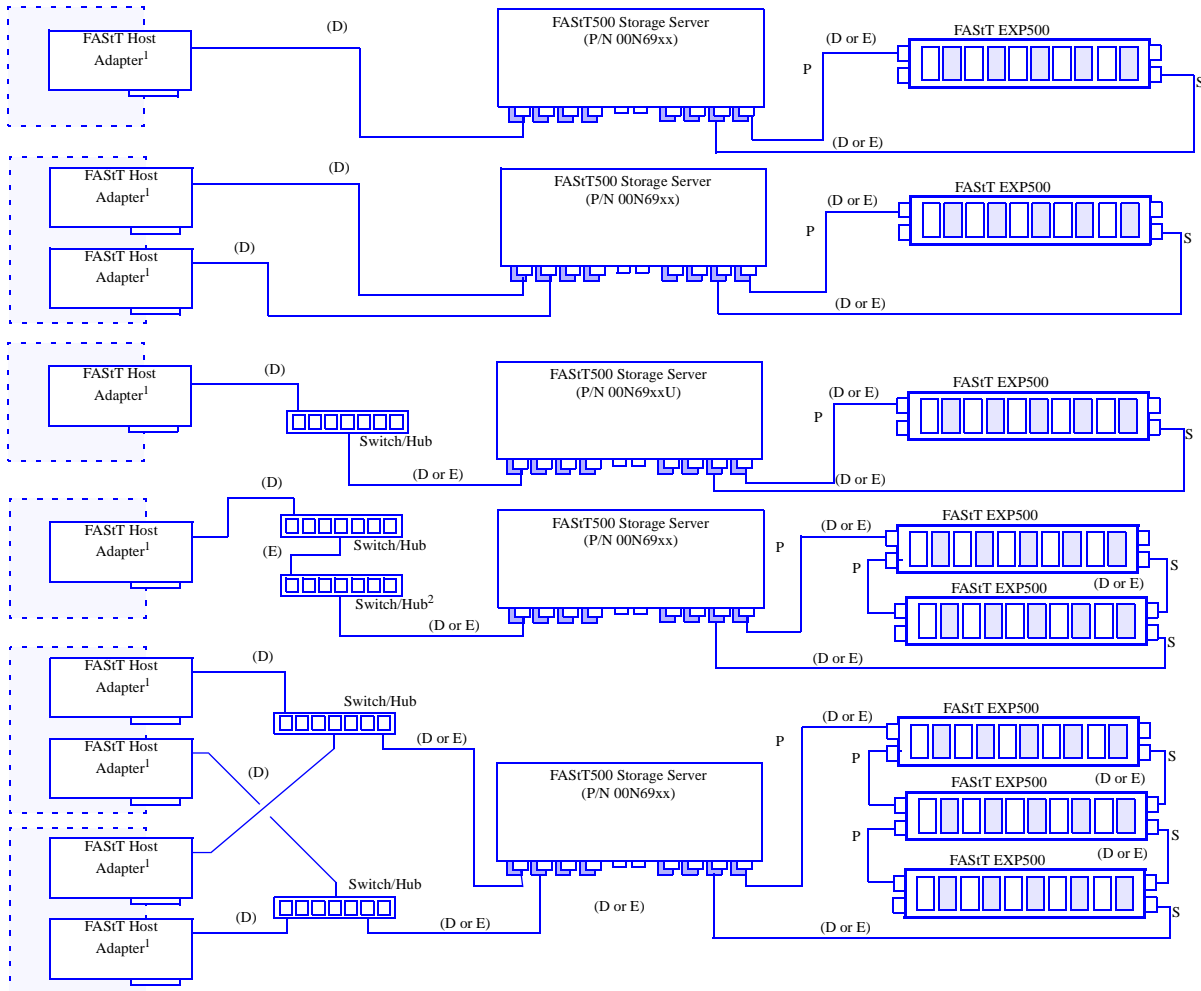

1. FAST Host Adapter P/N 00N6881 supports shortwave connections only.
2. Buffering the long-wave optic cable expanse with a second switch or hub at the remote storage location is required to requalify the signal.

- P = Primary path, S = Secondary/Redundant path
- Shaded boxes represent separate hosts.
- Cable groups are represented by letters in parenthesis.
- Maximum of 220 external storage HDDs are supported through 11 enclosures in each cable pair.
- The number of servers that can be used in configurations with managed hubs or Fibre Channel switches are dependent on partitioning restrictions of the management system or cluster software.
- An optional short- or long-wave GBIC is required for all FAST500 storage server and FAST EXP500 storage connections. GBICs are not depicted in these diagrams.
- Other Fibre Channel devices may not require optional GBICs. For specific requirements, see the Fibre Device Ports Reference.

### Cable Group D (Short-Wave Fibre)

36L9973 - Netfinity Fibre Channel 1M Cable  
 03K9306 - Netfinity Fibre Channel 5M Cable  
 03K9305 - Netfinity Fibre Channel 25M Cable  
 Customer supplied short-wave cable of up to 500M (0.31 miles)

### Cable Group E (long-wave Fibre Channel)

Customer supplied long-wave cable of up to 10KM (6.2 miles)

### GBIC

03K9308 - Netfinity Fibre Channel Short-Wave GBIC  
 03K9307 - Netfinity Fibre Channel Long-Wave GBIC

## Fibre / Fibre Configuration Examples

### FASTt EXP500 with FASTt700 Fibre Channel Storage Server

Note: The following sample configurations are for illustration only and may not be suitable for any specific customer installation. Contact your IBM Business Partner or IBM Marketing Representative for assistance with your specific configuration requirements.

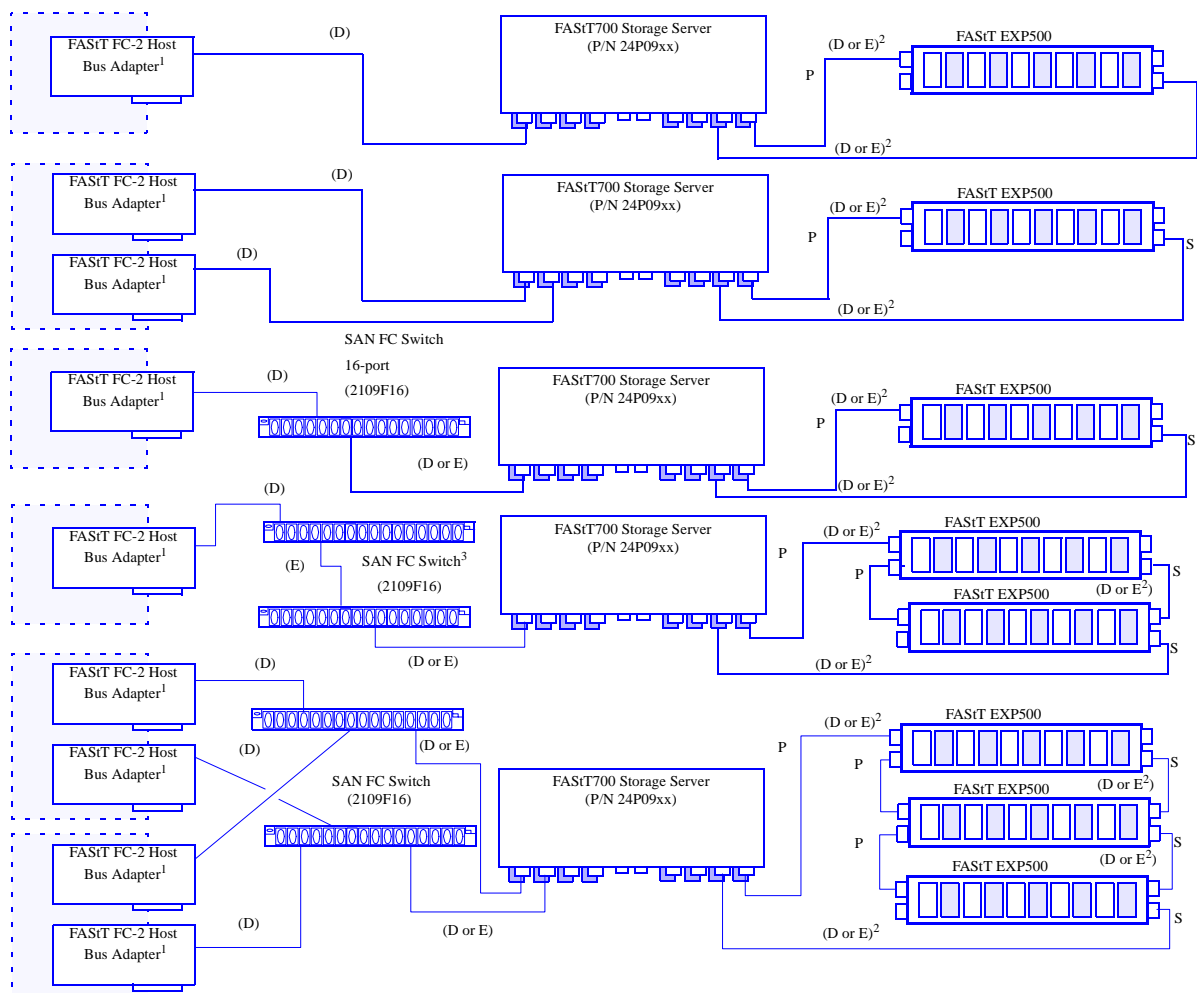

1. FASTt FC-2 Host Bus Adapter P/N 19K1246 includes an integrated short-wave SFF Module, supporting short-wave connections only.
2. Fibre Channel connections to the FASTt EXP500 require GBICs. LC-LC Fibre Channel cable does not connect directly into a GBIC. LC-SC Fibre Channel Adapter Cable (P/N 19K1250) is required. Use SC Fibre Channel cable for daisy-chaining FASTt EXP500 units (see FASTt500 Storage Server configuration for a list of SC cables).
3. Buffering the long-wave optic cable expanse with a second switch or hub at the remote storage location is required to requalify the signal.

- P = Primary path, S = Secondary/Redundant path
- Shaded boxes represent separate hosts.
- Cable groups are represented by letters in parenthesis.
- Maximum of 220 external storage HDDs are supported through a maximum of 11 enclosures in each channel pair (22 enclosures total).
- The number of servers that can be used in configurations with managed hubs or Fibre Channel switches are dependent on partitioning restrictions of the management system or cluster software.
- An optional short- or long-wave GBIC is required for all FASTt500 EXP500 storage connections.
- FASTt700 and 2Gb FC switch connections require SFP Modules. LC-SC FC Adapter Cables are required to connect LC-LC FC cables to GBICs in FASTt EXP500 connections. GBICs, SFP Modules and adapter cables are not depicted in these diagrams.
- For specific requirements concerning connections, refer to the Fibre Device Ports Reference or Fibre Interconnection Guidelines.

#### Cable Group D (Short-Wave Fibre)

19K1247 - 1M LC-LC Fibre Channel Cable  
 19K1248 - 5M LC-LC Fibre Channel Cable  
 19K1249 - 25M LC-LC Fibre Channel Cable  
 Customer supplied short-wave cable of up to 500M (0.31 miles)

#### Cable Group E (long-wave Fibre Channel)

Customer supplied long-wave cable of up to 10KM (6.2 miles)

#### GBIC/SFP Modules

03K9308 - Netfinity Fibre Channel Short-wave GBIC  
 03K9307 - Netfinity Fibre Channel Long-wave GBIC  
 19K1271 - Short-wave SFP Module  
 19K1272 - Long-wave SFP Module  
 19K1250 - LC-SC Fibre Channel Adapter Cable





Part Number	Description	00N6881 FASiT Host Adapter	00N6882 FASiT Mini Hub <sup>1</sup>	19K1121 FasT200 Red. Raid Controller <sup>1</sup>	2108R3L SAN Data Gateway Router	2109S08 SAN FC Switch, 8-Port <sup>1</sup>	2109S16 SAN FC Switch, 16-Port <sup>1</sup>	35L1647 SAN FC Managed Hub <sup>1</sup>	09N4047 Fibre Tape Automation Adapter	19K11xx <sup>6</sup> FASiT200 Storage Server <sup>1</sup>	19K11xx <sup>7</sup> FASiT200 HA Storage Server <sup>1</sup>	19K1121 FASiT200 Redundant RAID Controller <sup>1</sup>	00N69xx <sup>8</sup> FASiT500 Storage Server <sup>1</sup>	00N6882 FASiT500 Mini Hub <sup>1</sup>	00N71xx <sup>9</sup> FASiT EXP500 <sup>1</sup>	24P09xx <sup>10</sup> FASiT700 Storage Server <sup>2</sup>	19K1269 FASiT700 Mini Hub <sup>2</sup>	03K9307 FC Long-Wave GBIC	03K9308 FC Short-Wave GBIC	19K1250 LC-SC Fibre Channel Adapter Cable <sup>3</sup>	19K1271 Short-Wave SFP Module	19K1272 Long-Wave SFP Module	
00N6881	FASiT Host Adapter	-	S	S	-	S	S	S	S	S	S	S	-	-	S <sup>4</sup>	-	S <sup>4</sup>	S <sup>4</sup>	H				
19K1246	FASiT FC-2 Host Bus Adapter	-	S <sup>5</sup>	S <sup>5</sup>	-	S <sup>5</sup>	S <sup>5</sup>	-	S <sup>5</sup>	S <sup>5</sup>	S <sup>5</sup>	-	-	-	S	-	S	S	H				
2108R3L	SAN Data Gateway Router UltraSCSI LVD Port	-	-	-	-	S	S	S	-	-	-	-	-	-	S <sup>4</sup>	-	-	-	H				
2109S08	SAN FC Switch, 8-Port <sup>1</sup>	S	E	E	S	E	E	-	E	E	E	E	S	E <sup>4</sup>	E <sup>4</sup>	E <sup>4</sup>	E <sup>4</sup>	H					
2109S16	SAN FC Switch, 16-Port <sup>1</sup>	S	E	E	S	E	E	-	E	E	E	E	S	E <sup>4</sup>	E <sup>4</sup>	E <sup>4</sup>	E <sup>4</sup>	H					
2109F16	SAN Fibre Channel Switch, 16-Port <sup>2</sup>	S	E <sup>5</sup>	E <sup>5</sup>	S <sup>5</sup>	E <sup>5</sup>	E <sup>5</sup>	-	E <sup>5</sup>	E <sup>5</sup>	E <sup>5</sup>	-	-	E	S	E	E	H					
35L1647	SAN FC Managed Hub <sup>1</sup>	S	E	E	S	E	E	E	E	E	E	-	S	-	-	-	-	H					
09N4047	Fibre Tape Automation Adapter	-	-	-	-	S	S	S	-	-	-	-	-	-	-	-	-	-					
19K11xx <sup>6</sup>	FASiT200 Storage Server <sup>1</sup>	S	-	H	-	E	E	E	-	-	-	E	-	E	S <sup>4</sup>	-	-	H					
19K11xx <sup>7</sup>	FASiT200 HA Storage Server <sup>1</sup>	S	-	-	-	E	E	E	-	-	-	E	-	E	S <sup>4</sup>	-	-	H					
19K1121	FASiT200 Redundant RAID Controller <sup>1</sup>	S	-	-	-	E	E	E	H	-	-	E	-	-	S <sup>4</sup>	-	-	H					
00N69xx <sup>8</sup>	FASiT500 Storage Server <sup>1</sup>	-	H	-	-	E	E	E	-	-	-	E	-	-	S <sup>4</sup>	-	-	H					
00N6882	FASiT500 Mini Hub <sup>1</sup>	-	E	E	-	E	E	-	-	-	H	E	-	-	S <sup>4</sup>	-	-	H					
00N71xx <sup>9</sup>	FASiT EXP500 <sup>1</sup>	-	E	E	-	-	-	-	E	E	E	-	-	-	-	E <sup>4</sup>	E <sup>4</sup>	H					
24P09xx <sup>10</sup>	FASiT700 Storage Server <sup>2</sup>	S <sup>5</sup>	-	-	-	E <sup>5</sup>	E <sup>5</sup>	-	-	-	-	E <sup>5</sup>	-	E	S	-	H	H					
19K1269	FASiT700 Mini Hub <sup>2</sup>	S <sup>5</sup>	-	-	-	E <sup>5</sup>	E <sup>5</sup>	-	-	-	-	E <sup>5</sup>	-	E	S	H	-	H					
03K9307	FC Long-Wave GBIC	-	H	H	-	H	H	H	H	H	H	H	-	-	-	-	-	H					
03K9308	FC Short-Wave GBIC	-	H	H	-	H	H	H	H	H	H	H	-	-	-	-	-	H					
19K1250	LC-SC Fibre Channel Adapter Cable <sup>3</sup>	H	H	H	H	H	H	H	H	H	H	H	-	H	H	H	H	-	H				
19K1271	Short-Wave SFP Module	-	-	-	-	-	-	-	-	-	-	-	-	-	H	-	H	H	H				
19K1272	Long-Wave SFP Module	-	-	-	-	-	-	-	-	-	-	-	-	-	H	-	H	H	H				

- S** Short-wave connection only. See Fibre Device Ports Reference section for GBIC, SFP module or integrated optical port information.
- E** Either short-wave or long-wave connections allowed via the appropriate GBIC or SFP module. See Fibre Device Ports Reference section for GBIC, SFP module or integrated optical port information.
- H** Hardware connection: One of these devices installs directly into the other, e.g., the FASiT500 Mini Hub P/N 00N6882 installs directly into the FASiT500 Storage Server P/N 00N69xx<sup>6</sup> to provide GBIC availability.

1. This device requires the use of GBICs. Purchase of GBICs may be needed in order to make connections to this device. See the Fibre Device Ports Reference section for GBIC or integrated optical port information.
2. This device requires a long- or short-wave SFP module. See Fibre Device Ports Reference for additional information.
3. The LC-SC Fibre Channel Adapter Cable P/N 19K1250 is designed to connect any 1Gb device or cable to any 2Gb device or cable. When 2Gb and 1Gb technology are combined in a configuration, the signal transfer automatically converts to the slower speed.
4. When connected to 2Gb devices or cable, LC-SC Fibre Channel Adapter Cable P/N 19K1250 is required.
5. When connected to 1Gb devices or cable, LC-SC Fibre Channel Adapter Cable P/N 19K1250 is required.
6. Where 'xx' represents a specific country code as follows:- 23=US/English, 24=Euro/English, 25=Euro/Spanish, 27=Euro/German, 28=Denmark/English, 29=Israel/English, 30=Italy/English, 31=South Africa/English, 32=Switzerland/English, 34=Switzerland/German, 36=UK/English. Country/Language - Line Cords/Publications are included as indicated.
7. Where 'xx' represents a specific country code as follows:- 37=US/English, 38=Euro/English, 39=Euro/Spanish, 41=Euro/German, 42=Denmark/English, 43=Israel/English, 44=Italy/English, 45=South Africa/English, 46=Switzerland/English, 48=Switzerland/German, 50=UK/English. Country/Language - Line Cords/Publications are included as indicated.
8. Where 'xx' represents a country specific code as follows:- 13=US/English, 14=Euro/English, 18=Denmark/English, 19=Israel/English, 20=Italy/English, 21=South Africa/English, 22=Switzerland/English, 26=UK/English. Country/Language - Line Cords/Publications are included as indicated.
9. Where 'xx' represents a specific country code as follows:- 36=US/English, 37=Euro/English, 41=Denmark/English, 42=Israel/English, 43=Italy/English, 44=South Africa/English, 45=Switzerland/English, 49=UK/English. Country/Language Line Cords/Publications are included as indicated.
10. Where 'xx' represents a specific country code as follows:- 14=Eur/English, 15=Euro/Spanish, 18=Denmark/English, 19=Israel/English, 20=Italy/English, 21=South Africa/English, 22=Switzerland/English, 25=UK/English. Country/Language Line Cords/Publications are included as indicated.



Fibre Device Ports Reference

Part Number	Description	Total Connections Possible	Integrated Ports <sup>4</sup>	Mini Hubs Possible	Mini Hubs Installed	GBIC or SFP Module Ports	GBICs or SFP Modules Included <sup>4</sup>
00N6881	FASiT Host Adapter	1	1	-	-	-	-
00N6882	FASiT500 Mini Hub <sup>1</sup>	2	-	-	-	2	-
03K9307	FC Long-Wave GBIC <sup>5</sup>	1	-	-	-	-	-
03K9308	FC Short-Wave GBIC	1	-	-	-	-	-
09N4047	Fibre Tape Automation Adapter <sup>2</sup>	1	1	-	-	-	-
19K1121	FASiT200 Redundant RAID Controller	2	-	-	-	2	-
2108R3L	San Data Gateway Router UltraSCSI LVD Port <sup>3</sup>	1	1	-	-	-	-
2109S08	SAN FC Switch, 8-Port	8	-	-	-	8	4
2109S16	SAN FC Switch, 16-Port	16	-	-	-	16	4
2109F16	SAN FC Switch, 16-Port	16	-	-	-	16	8 <sup>8</sup>
35L1647	SAN FC Managed Hub	8	7	-	-	1	-
19K11xx <sup>10</sup>	FASiT200 Storage Server	2	-	-	-	2	-
19K11xx <sup>11</sup>	FASiT200 HA Storage Server	4	-	-	-	4	-
00N69xx <sup>12</sup>	FASiT500 Storage Server <sup>5</sup>	12	-	8	4	12 <sup>1</sup>	-
00N71xx <sup>13</sup>	FASiT EXP500	4	-	-	-	4	-
19K1246	FASiT FC-2 Host Bus Adapter	1	1	-	-	-	-
24P09xx <sup>14</sup>	FASiT700 FC Storage Server <sup>6</sup>	12	-	8	4	12	-
19K1269	FASiT700 Mini Hub <sup>7</sup>	2	-	-	-	2	-
19K1250	LC-SC FC Adapter Cable <sup>9</sup>	1	1	-	-	-	-
19K1271	Short-Wave SFP Module	1	-	-	-	-	-
19K1272	Long-Wave SFP Module	1	-	-	-	-	-

- Each FASiT500 Mini Hub provides two GBIC ports. The host-side mini hubs connect to one of two Fibre Channel controllers in the FASiT500 Storage Server. The drive-side mini hubs each connect to both Fibre Channel controllers. Full redundancy requires connection to two drive-side and two host-side mini hubs. Drive-side mini hubs support connection to one port only.
- This adapter installs in a 3600 Series Tape Library and attaches to a FASiT Host Adapter or GBIC installed in a Fibre Channel Switch P/N 2109S08 or 2109S16 or a Managed Hub P/N 35L1647 via a short-wave Fibre Channel cable P/N 36L9973, 03K9306, 03K9305.
- Provides one integrated short-wave optical port and two SCSI ports for tape storage connections (one LVD or HVD and one single-ended).
- Standard GBICs, SFP Modules and integrated optical ports are short-wave.
- FASiT500 Storage Server supports up to eight nonredundant or four redundant host connections and two redundant storage drive loops.
- FASiT700 Storage Server supports up to eight nonredundant or four redundant host connections and two redundant storage drive loops.
- Each FASiT700 Mini Hub provides two SFP Module ports. The host-side mini hubs connect to one of two Fibre Channel controllers in the FASiT700 Storage Server. The drive side mini hubs each connect to both Fibre Channel controllers. Full redundancy requires connection to two drive-side and two host-side mini hubs. Drive-side mini hubs support connection to one port only.
- Eight short-wave SFP modules are standard. Either short-wave or long-wave modules can populate the other eight ports.
- The LC-SC Fibre Channel Adapter Cable P/N 19K1250 is designed to connect any 1Gb device or cable to any 2Gb device or cable. When 2Gb and 1Gb technology are combined in a configuration, the signal transfer automatically converts to the slower speed.
- Where 'xx' represents a specific country code as follows:- 23=US/English, 24=Euro/English, 25=Euro/Spanish, 27=Euro/German, 28=Denmark/English, 29=Israel/English, 30=Italy/English, 31=South Africa/English, 32=Switzerland/English, 34=Switzerland/German, 36=UK/English. Country/Language - Line Cords/Publications are included as indicated.
- Where 'xx' represents a specific country code as follows:- 37=US/English, 38=Euro/English, 39=Euro/Spanish, 41=Euro/German, 42=Denmark/English, 43=Israel/English, 44=Italy/English, 45=South Africa/English, 46=Switzerland/English, 48=Switzerland/German, 50=UK/English. Country/Language - Line Cords/Publications are included as indicated.
- Where 'xx' represents a country specific code as follows:- 13=US/English, 14=Euro/English, 18=Denmark/English, 19=Israel/English, 20=Italy/English, 21=South Africa/English, 22=Switzerland/English, 26=UK/English. Country/Language - Line Cords/Publications are included as indicated.
- Where 'xx' represents a specific country code as follows:- 36=US/English, 37=Euro/English, 41=Denmark/English, 42=Israel/English, 43=Italy/English, 44=South Africa/English, 45=Switzerland/English, 49=UK/English. Country/Language Line Cords/Publications are included as indicated.
- Where 'xx' represents a specific country code as follows:- 14=Eur/English, 15=Euro/Spanish, 18=Denmark/English, 19=Israel/English, 20=Italy/English, 21=South Africa/English, 22=Switzerland/English, 25=UK/English. Country/Language Line Cords/Publications are included as indicated.



<b>Supported Cable Groups</b>	
<b>Cable Group A (0.8mm to 0.8mm)</b>	
03K9310	2M Ultra2 SCSI Cable
03K9311	4.2M Ultra2 SCSI Cable
37L7101	20M Ultra2 SCSI Cable
<b>Cable Group D (Short-Wave Fibre)</b>	
36L9973	Fibre Channel 1M Cable
03K9306	Fibre Channel 5M Cable
03K9305	Fibre Channel 25M Cable
19K1247	1M LC-LC Fibre Channel Cable
19K1248	5M M LC-LC Fibre Channel Cable
19K1249	25M M LC-LC Fibre Channel Cable
Customer supplied short-wave cable of up to 500M (0.31 miles)	
<b>Cable Group E (Long-Wave Fibre)</b>	
Customer supplied long-wave cable of up to 10KM (6.2 miles)	
<b>GBIC/SFP Modules</b>	
03K9308	Fibre Channel Short-Wave GBIC
03K9307	Fibre Channel Long-Wave GBIC
19K1271	Short-wave SFP Module
19K1272	Long-wave SFP Module
19K1250	LC-SC Fibre Channel Adapter Cable

**FAStT Host Adapter**  
P/N 00N6881



- PCI to FCAL 64/32-bit host adapter.
- Supported Attachments (use cable group D):  
FAStT500 Storage Server P/N 00N69xx.
- Integrated short-wave optical port. No GBICs required.
- Full Fibre Channel fabric support.

**FAStT FC-2 Host Bus Adapter**  
P/N 19K1246

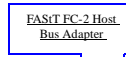

- PCI-X to FCAL 64-bit host adapter (100MHz).
- Supported Attachments (use LC-LC cable in group D):  
FAStT700 Storage Server P/N 24P09xx.
- Integrated short-wave optical port. No SFP Modules required.
- Full Fibre Channel fabric support.

**FAStT500 Storage Server**  
P/N 00N69xx

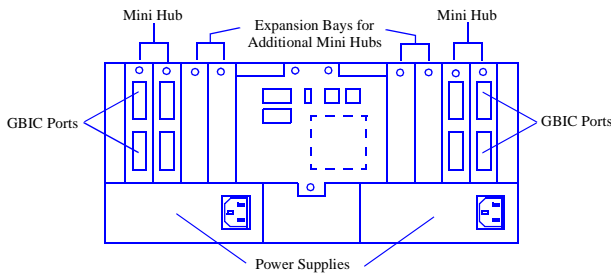

- Dual high-performance, RAID controller cards--supports up to 380MB/sec of throughput.
- Two 175W auto-ranging, hot-swap, redundant power supplies.
- Attach directly to FAStT Host Adapter(s) P/N 00N6881 with short-wave cables and GBICs or indirectly through SAN Fibre Channel Managed Hub P/N 35L1647 or either the 8-port or 16-port Fibre Channel Switch P/N 2109S08 or 2109S16, using cables from cable group D or E with corresponding GBICs.
- Height is 4U (1U = 1.75in or 44.45mm).
- For optimum performance no more than two FAStT500 Storage Servers P/N 00N69xx should be attached to a single hub P/N 35L1647.
- Includes four FAStT500 Mini Hubs P/N 00N6882, two for host and two for drive-side.
- FAStT500 256MB Cache P/N 00N6883 may be required for more complex installations.
- All connections to FAStT500 Mini Hubs require the use of GBICs. GBICs are not included.

**FAStT500 Mini Hub**  
P/N 00N6882

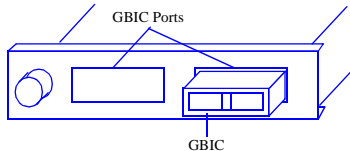

- Provides additional connections to the FAStT500 Storage Server--supports complex clustering or advanced storage applications.
- All connections to FAStT500 Mini Hubs require the use of GBICs. GBICs are not included.

**FAStT700 Mini Hub**  
P/N 19K1269

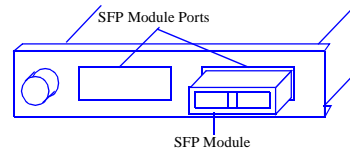

- Provides additional connections to the FAStT700 Storage Server--supports complex clustering or advanced storage applications.
- All connections to FAStT700 Mini Hubs require the use of SFP Modules, which are not included.

**FAStT700 Storage Server**  
P/N 24P09xx

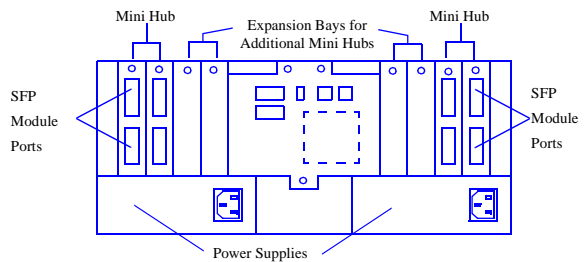

- Dual high-performance RAID controller cards--supports up to 390MB/s of throughput.
- Operates at either 1Gb or 2Gb (autosensing).
- Dual 175W auto-ranging, hot-swap, redundant power supplies.
- Attach directly to FAStT FC-2 Host Bus Adapter(s) P/N 19K1246 with short-wave cables and SFP Modules or indirectly through the SAN Fibre Channel Switch, 16-port P/N 2109F16 using LC-LC cables from cable group D or E with corresponding SFP Modules.
- Height is 4U (1U = 1.75in or 44.45mm)
- For optimum performance no more than two FAStT700 Storage Servers P/N 24P09xx should be attached to a single Fibre Channel switch.
- Includes four FAStT700 Mini Hubs P/N 19K1269, two host-side and two storage drive-side.
- Each controller is equipped with 1GB of cache (2GB total).
- All connections to FAStT700 Mini Hubs require the use of SFP Modules, which are not included.

**FAStT200 Storage Server P/N 19K11xx**

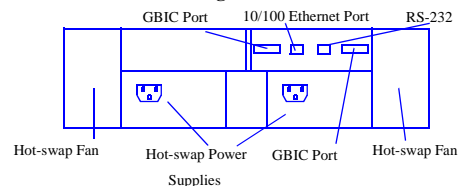

- Contains a single hot-plug, RAID controller which provides a single host Fibre Channel arbitrated loop and a single storage Fibre Channel arbitrated loop.
- Can be upgraded to a FAStT200 HA Storage Server through the addition of a FAStT200 Redundant RAID Controller P/N 19K1121.
- Integrated 10/100Mbps Ethernet connector and RS-232 service support port.
- Performance optimised for 30 HDDs - supports optional FAStT EXP500 Storage Expansion Units P/N 00N71xx.
- Two hot-swap 350W auto-ranging, redundant power supplies.
- Redundant fans: two hot-swap, dual-fan units.
- LED indicators on all critical components warn of faults, over-temperature, and other abnormalities.
- Ten drive bays--supports slim-line or half-high Fibre Channel hot-swap HDDs.
- Height is 3U (1U=1.75in or 44.45mm).
- Supports long- and short-wave connections. Requires optional GBICs for each connection. GBICs not included.

### **FASiT200 HA Storage Server P/N 19K11xx**

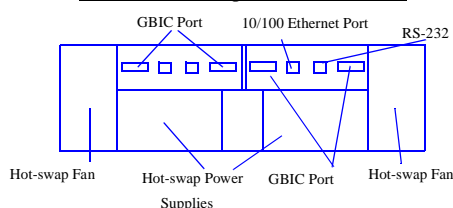

- Contains two hot-plug, RAID controllers. Each controller provides a single host Fibre Channel arbitrated loop and a single storage Fibre Channel arbitrated loop.
- Integrated 10/100Mbps Ethernet connector and RS-232 service support port.
- Performance optimised for 30 HDDs-- supports optional FASiT EXP500 Storage Expansion Units P/N 00N71xx.
- Two hot-swap 350W auto-ranging, redundant power supplies.
- Redundant fans - two hot-swap, dual-fan units.
- LED indicators on all critical components warn of faults, over-temperature, and other abnormalities.
- Ten drive bays - supports slim-line or half-high Fibre Channel hot-swap HDDs.
- Height is 3U (1U=1.75in or 44.45mm).
- Supports long- and short-wave connections. Requires optional GBICs for each connection. GBICs not included.

### **FASiT EXP500 Storage Expansion Unit P/N 00N71xx**

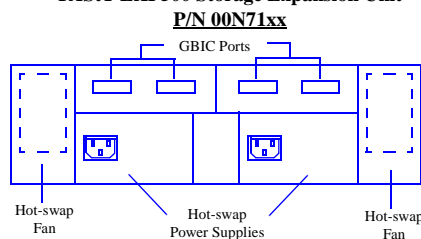

- Two hot-swap, 350W auto-ranging, redundant power supplies.
- Redundant fans - two hot-swap, dual-fan units.
- LED indicators on all critical components warn of faults, over-temperature, and other abnormalities.
- Ten drive bays - supports slim-high or half-high Fibre Channel hot-swap HDDs.
- Height is 3U (1U = 1.75in or 44.45mm).
- Requires optional GBICs for each connection. GBICs not included.

### **LC-SC Fibre Channel Adapter Cable P/N 19K1250**

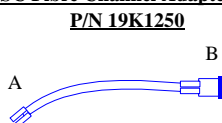

- Nine-inch adapter cable used to connect 1Gb cable or devices to 2Gb cable or devices.
- Remove the clip-on connector (B) at one end and plug into the FASiT Host Adapter integrated GBIC (or any short-wave GBIC). Use the double-female 2Gb-2Gb open connector that ships with the FASiT700 Storage Server to attach the male connector of LC-LC Fibre Channel cable to the male connector at the other end of the adapter cable (A).
- Use the 2Gb connector (A) to attach to an SFP or SFF Module, then remove the black caps from the clip-on connector and insert 1Gb cable.

### **SAN Fibre Channel Switch, 8 and 16 Ports P/Ns 2109S08 and 2109S16**

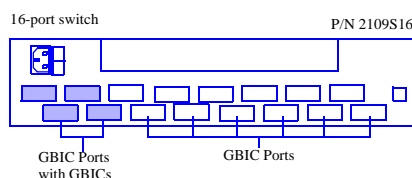
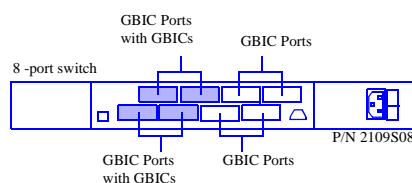

- Each port delivers up to 100MB/sec, full-duplex data transfer.
- Comes with four short-wave GBICs installed.
- Embedded Web browser configuration, management and service.
- Support for Public Fibre Channel Arbitrated Loops.
- Optional power supply P/N 09L5403 available.
- The 8-port switch is 1U (1U=1.75in or 44.45mm) and the 16-port switch is 2U.

### **SAN Fibre Channel Switch, 16-Port P/B 2109F16**



- Provides 2Gb per second port-to-port throughput with autosensing capability for connecting to 1Gb per second host servers, storage and switches with full operability.
- Contained in a 1U mechanical requiring half the rack space of the 1Gb 16-port switch.
- Up to four Inter-Switch Links can be trucked for throughput of up to 8Gb per second.
- Includes a comprehensive set of management tools that support a Web browser interface.
- Eight short-wave SFP Modules (optical transceivers) are standard.
- Built-in redundancy with no single points of failure.
- Supports up to 384 ports in a single 42U rack (scalable to 293 switches maximum).
- Two hot-swap 126W power supplies are standard.

### **SAN Fibre Channel Managed Hub P/N 35L1647**

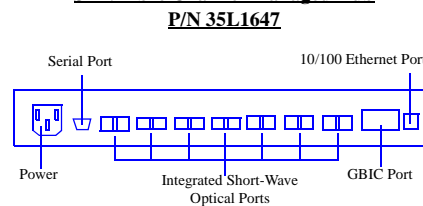

- High-speed performance utilizing nonblocking switch-based technology.
- Simultaneous 100MB/sec full duplex data transfers across all ports.
- Eight ports total, one that is configurable with either an optional short-wave or long-wave GBIC and seven integrated short-wave optical ports.
- Support for industry standard MIBs enabling standard SNMP management.
- Height is 1U (1U=1.75in or 44.45mm).



## High-speed, single-node xSeries Fibre Channel storage configuration offering performance, bandwidth & capacity

Note: The following sample configurations are for illustration only and may not be suitable for any specific customer installation. Contact your IBM Business Partner or IBM Marketing Representative for assistance with your specific configuration requirements

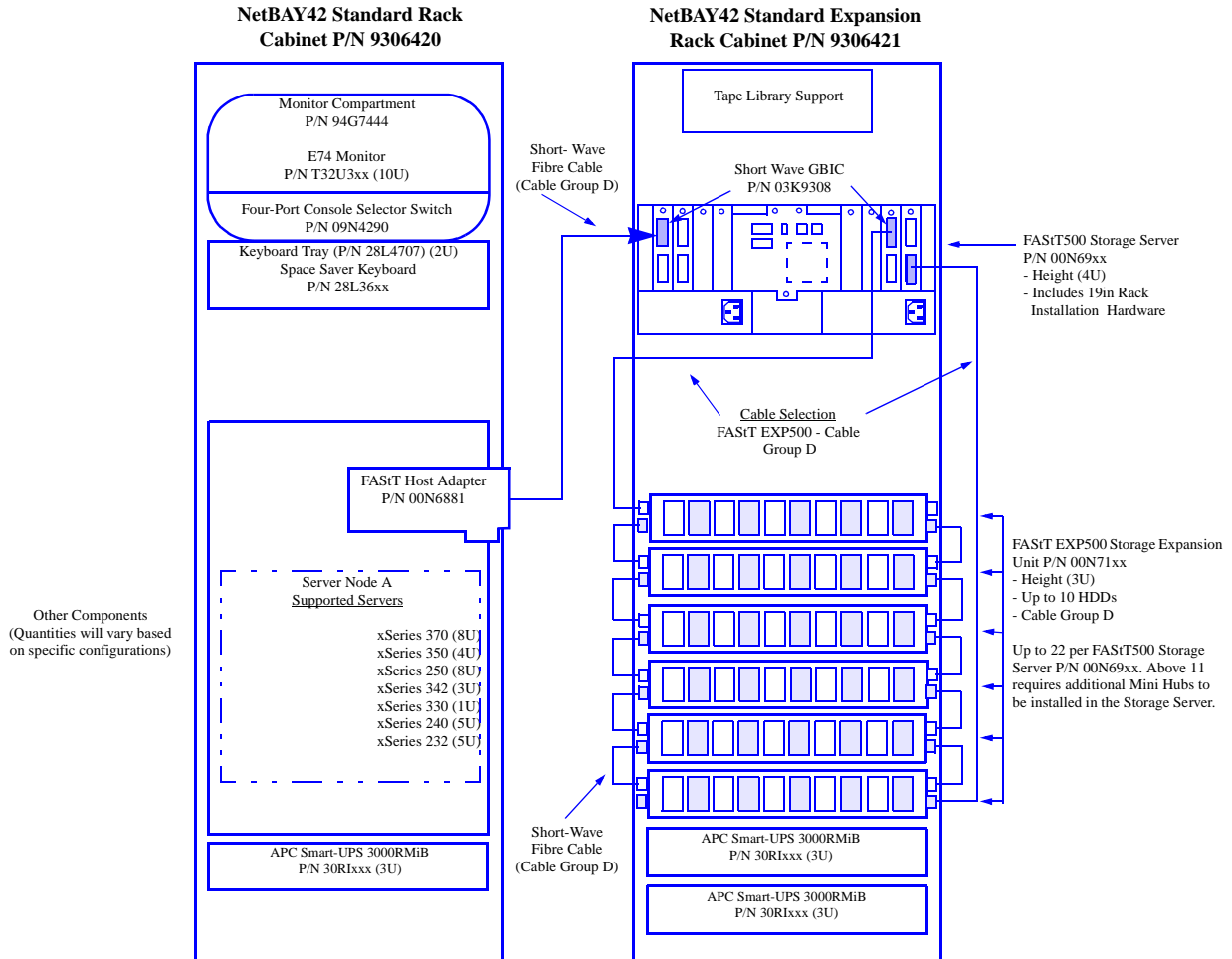

<p><b>Connector Types</b> 68-pin - High Density Connector 0.8mm - Very High Density Connection Interface (VHDCI)</p> <p><b>Cable Group A (0.8mm to 0.8mm)</b> 03K9310 - Netfinity 2M Ultra2 SCSI Cable 03K9311 - Netfinity 4.2M Ultra2 SCSI Cable 37L7101 - Netfinity 20M Ultra2 SCSI Cable</p>	<p><b>Cable Group D (Short-Wave Fibre)</b> 36L9973 - Netfinity Fibre Channel 1M Cable 03K9306 - Netfinity Fibre Channel 5M Cable 03K9305 - Netfinity Fibre Channel 25M Cable Customer supplied short-wave cable of up to 500m (0.31 miles)</p> <p><b>Cable Group E (Long-Wave Fibre)</b> Customer supplied long-wave cable of up to 10km (6.2 miles)</p> <p><b>GBIC</b> 03K9308 - Netfinity Fibre Channel Short-Wave GBIC 03K9307 - Netfinity Fibre Channel Long-Wave GBIC</p>
---	--

## High-speed, single-node xSeries Fibre Channel storage configuration with Microsoft NT failover support and RAID redundancy for availability, performance and capacity

Note: The following sample configurations are for illustration only and may not be suitable for any specific customer installation. Contact your IBM Business Partner or IBM Marketing Representative for assistance with your specific configuration requirements

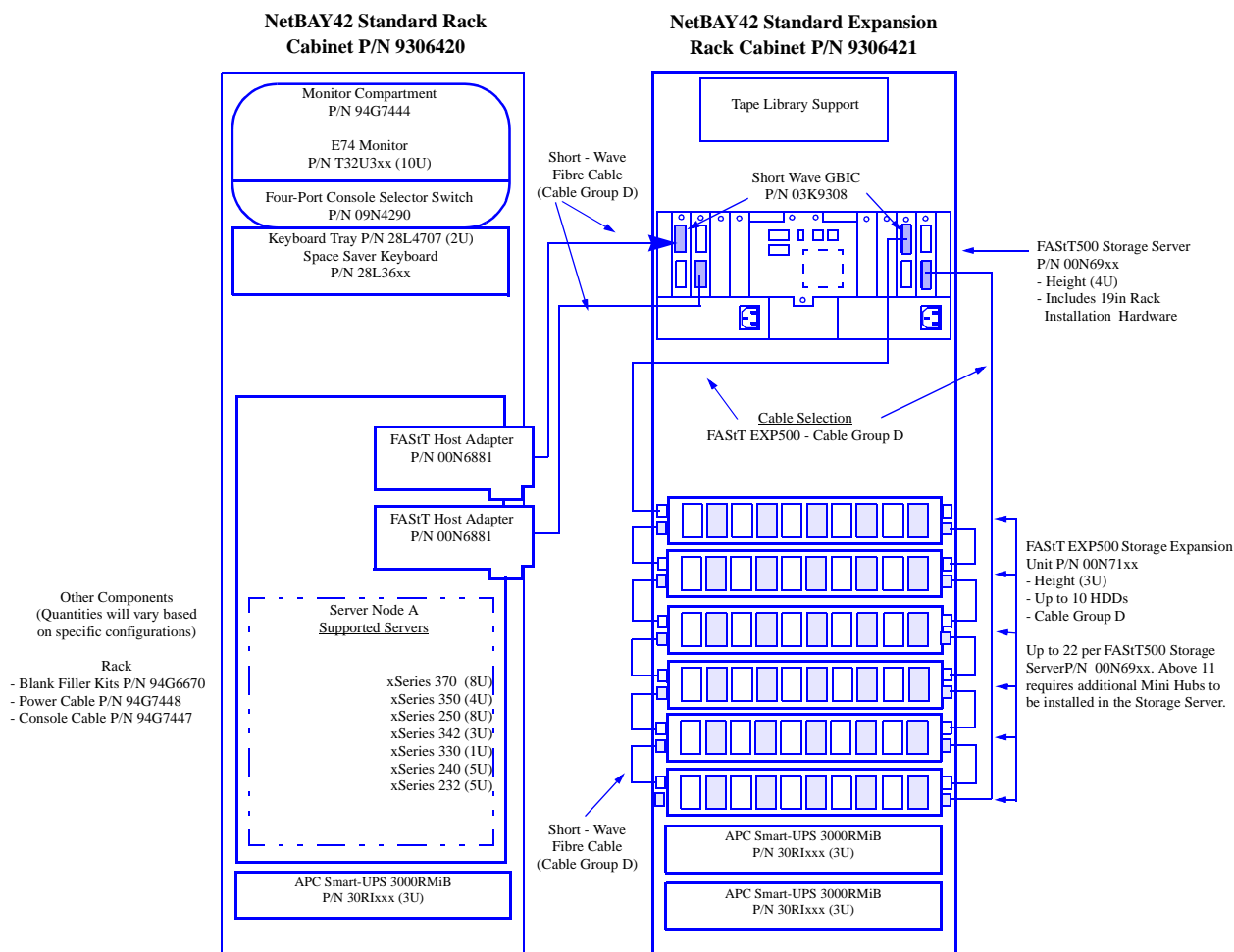

### Connector Types

68-pin - High Density Connector  
0.8mm - Very High Density Connection Interface (VHDCI)

### Cable Group A (0.8mm to 0.8mm)

03K9310 - Netfinity 2M Ultra2 SCSI Cable  
03K9311 - Netfinity 4.2M Ultra2 SCSI Cable  
37L7101 - Netfinity 20M Ultra2 SCSI Cable

### Cable Group D (Short-Wave Fibre)

36L9973 - Netfinity Fibre Channel 1M Cable  
03K9306 - Netfinity Fibre Channel 5M Cable  
03K9305 - Netfinity Fibre Channel 25M Cable  
Customer supplied short-wave cable of up to 500m (0.31 miles)

### Cable Group E (Long-Wave Fibre)

Customer supplied long-wave cable of up to 10km (6.2 miles)

### GBIC

03K9308 - Netfinity Fibre Channel Short-Wave GBIC  
03K9307 - Netfinity Fibre Channel Long-Wave GBIC



# IBM NetBAY3/NetBAY3E™ Stackable Enclosures

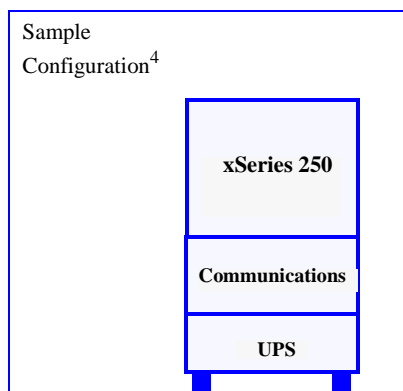

### Installation Guidelines:

- 1) Locate power units with line cords in the bottom enclosure.
- 2) Install components starting from the bottom; start with the heaviest device.
- 3) If nothing is installed in the enclosure, attach the rear blank panel for stability.

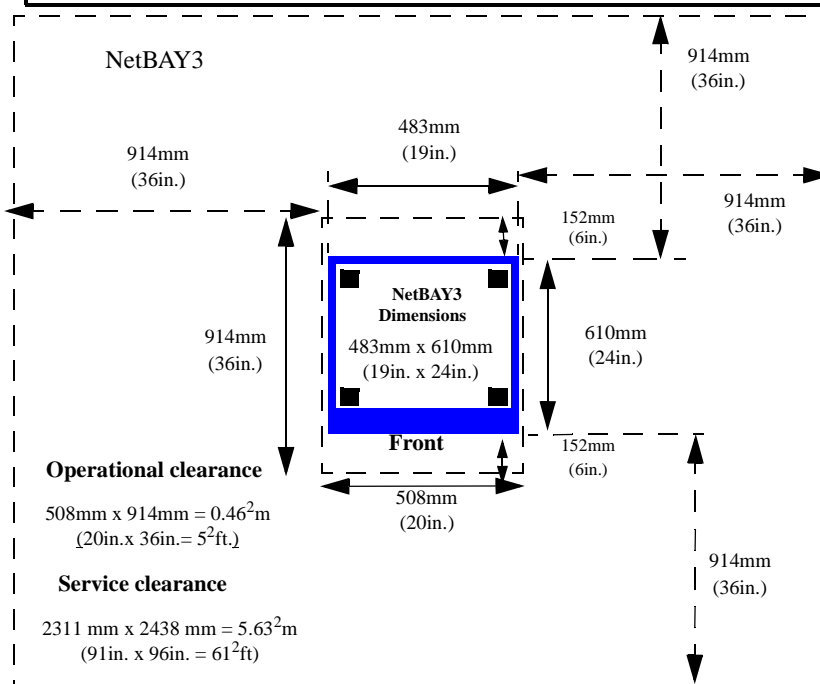

Supported Devices	NetBAY3	NetBAY3E	Size (U)	Max/Enclosure	Max/Stack
<b>Servers</b>					
xSeries 250	X	-	n/a	n/a	1
xSeries 370 <sup>1</sup>	-	X	n/a	n/a	1
<b>Expansion<sup>2</sup></b>					
EXP300	X	X	3	1	3
FASiT200 Storage Server	X	X	3	1	1
FASiT200 HA Storage Server	X	X	3	1	1
FASiT EXP500 Storage Expansion Unit <sup>3</sup>	X	X	3	1	2
<b>Tape Enclosure<sup>2</sup></b>					
NetMEDIA	X	X	3	1	3
<b>Power<sup>2</sup></b>					
APC Smart-UPS 1400RMiB	X	X	3	1	1
APC Smart-UPS 3000RMiB	X	X	3	1	1
200-240V PDU	X	X	1	1	1
NetBAY Server Dual Cord PDU	X	X	1	1	1
NetBAY Rack PDU	X	X	1	1	1
<b>Communications<sup>2</sup></b>					
8230 T-R Controlled Access Unit	X	X	2	1	3
8235 Dial-in Access to LANs	X	X	1	3	9
8285 ATM Switch	X	X	3	1	3

1. xSeries 370 systems are rack mountable and ship without a keyboard. In order to be utilized with a NetBAY3E or in a tower configuration, optional Rack-to-Tower Kit (P/N 28L4705) must be installed.

2. NetBAY3 and NetBAY3E do not contain a top cover and therefore require a supported server as the top component in a stack

3. FASiT EXP500 requires a FASiT200 or FASiT200 HA Storage Server in a NetBAY3 or NetBAY3E configuration.



# IBM NetBAY3/NetBAY3E™ Stackable Enclosures

Tower Models

Single NetBay and Casters

Max Configurations

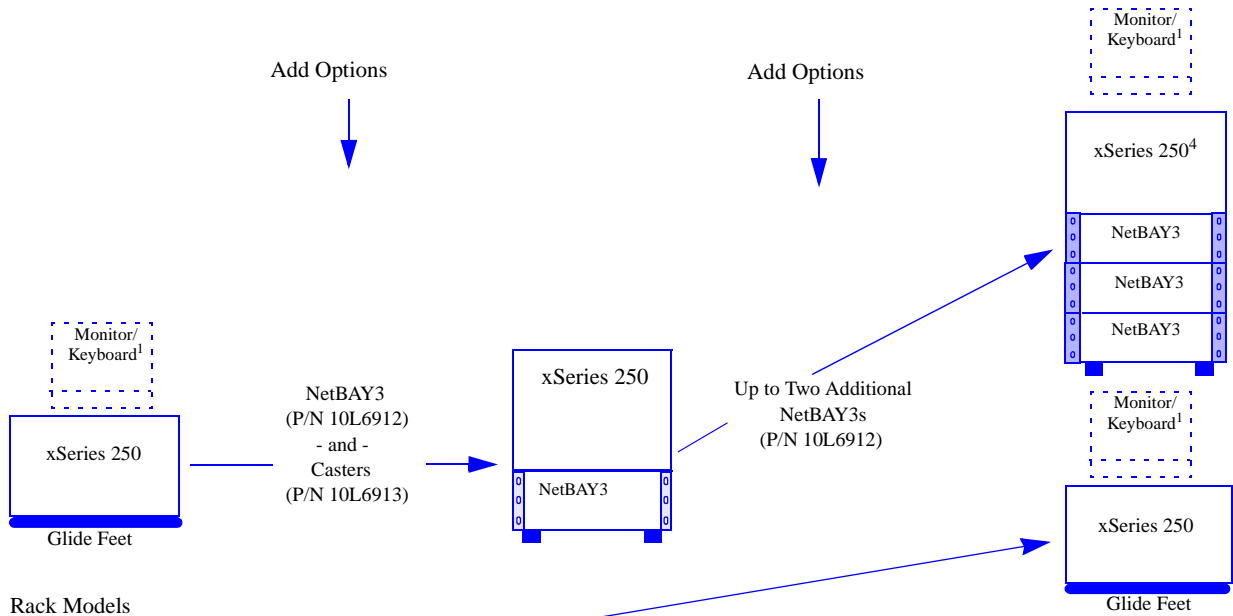

Rack Models

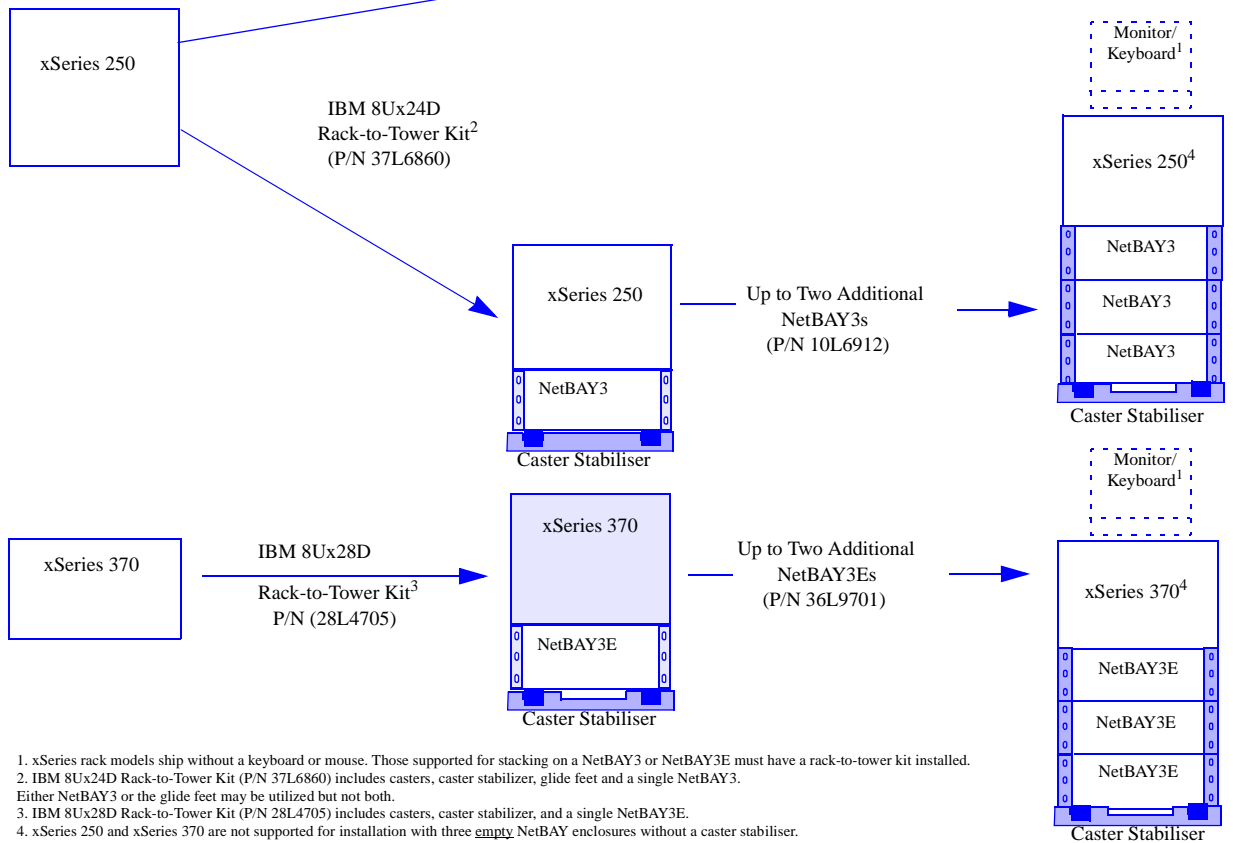

1. xSeries rack models ship without a keyboard or mouse. Those supported for stacking on a NetBAY3 or NetBAY3E must have a rack-to-tower kit installed.  
 2. IBM 8Ux24D Rack-to-Tower Kit (P/N 37L6860) includes casters, caster stabilizer, glide feet and a single NetBAY3. Either NetBAY3 or the glide feet may be utilized but not both.  
 3. IBM 8Ux28D Rack-to-Tower Kit (P/N 28L4705) includes casters, caster stabilizer, and a single NetBAY3E.  
 4. xSeries 250 and xSeries 370 are not supported for installation with three empty NetBAY enclosures without a caster stabiliser.



# NetBAY Rack Cabinets and Options

Note: For a robust rack configurator application access URL <http://www.ibm.com/pc/europe/configurators>

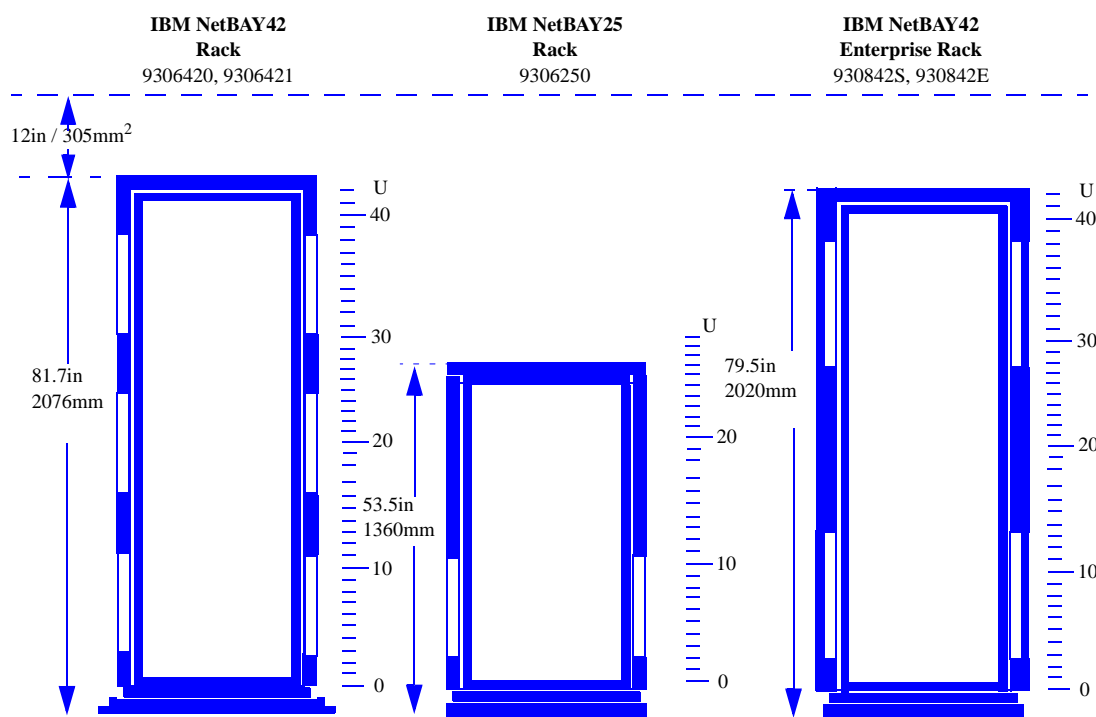

Ordering P/N-->	NetBAY42 Rack		NetBAY25 <sup>3</sup>	NetBAY22 <sup>3</sup>	NetBAY42 Enterprise Rack	
	Standard	Expansion	Standard		Standard	Expansion
P/N 9306420	P/N 9306421	P/N 9306250	P/N 9306200	P/N 930842S	P/N 930842E	
EIA Capacity <sup>4</sup>	42U	42U	25U	22U	42U	42U
Sidewall Compartments	6	6	2	2	4	4
Front Stabilizers	Std	Std	Std	Std	Std	Std
Side Stabilizers	Std	Std	NR	NR	NR	NR
Casters	Std	Std	Std	Std	Std	Std
Leveling Feet	Std	Std	Std	Std	Std	Std
Side Covers	Std	NR	Std	Std	Std	NR
Glass Front Door	N/A	N/A	N/A	Std	N/A	N/A
Vented Front Door	Std	Std	Std	No	Std	Std
Empty Weight	117Kg	92Kg	80Kg	83Kg	261Kg	234Kg
Maximum Load	646Kg	646Kg	385Kg	338Kg	667Kg	667Kg
Total Weight	763Kg	738Kg	465Kg	421Kg	928Kg	901Kg
Rack Extension Kit <sup>1</sup>	NR	NR	NR	P/N 36L9702 (Option)	NR	NR
Rack Attachment Kit	NR	Std	N/A	N/A	NR	Std
Shippable loaded <sup>5</sup>	No	No	Yes	No	Yes	Yes

NR - Not Required N/A - Not Available 1U= 1.75in= 44.45mm.

1. Rack Extension Kit adds 203mm (8inches) to rear of cabinet for cable management, recommended for systems greater than 610mm (24inches) in depth.
2. Minimum clearance to the ceiling.
3. Display and keyboard may be placed on top of the NetBAY22 and the NetBAY25.
4. Conforms to EIA 310 - D Standard 19inch rack specification for a Type A cabinet with universal hole spacing.
5. 'Shippable loaded' means the cabinet is capable of being transported with equipment installed. Required packaging including a heavy duty pallet with ramp is provided.



**Server System Rack and Stack Cabinets Cross-Reference**

	Conversion Kits			Stacks		Standard Racks <sup>1</sup>				Enterprise Racks <sup>1</sup>					
	P/N 09N4300 4Ux20D Tower-to-Rack Kit	P/N 37L6858 5Ux24D Tower-to-Rack Kit	P/N 21P9593 5Ux24D Tower-to-Rack Kit II	P/N 37L6859 8Ux24D Tower-to-Rack Kit	P/N 37L6860 8Ux24D Rack-to-Tower Kit <sup>2</sup>	P/N 28L4705 8Ux28D Rack-to-Tower Kit <sup>3</sup>	P/N 10L6912 <sup>5</sup> NetBAY3 Stackable Enclosure	P/N 36L9701 <sup>15</sup> NetBAY3E Stackable Enclosure	P/N 9306250 NetBAY25 Rack - Standard	P/N 9306200 NetBAY22	P/N 36L9702 22U Extension Kit <sup>4</sup>	P/N 9306420 NetBAY42 Rack - Standard	P/N 9306421 NetBAY42 Rack - Expansion	P/N 930842S NetBAY42 Enterprise Rack - Standard	P/N 930842E NetBAY42 Enterprise Rack - Expansion
<b>Servers<sup>14</sup></b>															
xSeries 200 <sup>5</sup>	X							X	X	X <sup>6</sup>	X	X	X	X	X
xSeries 220 <sup>5</sup>	X							X	X	X <sup>6</sup>	X	X	X	X	X
xSeries 232			X					X	X	X <sup>6</sup>	X	X	X	X	X
xSeries 240		X						X	X	X <sup>6</sup>	X	X	X	X	X
xSeries 250				X	X <sup>15</sup>		X <sup>7</sup>	X	X	X <sup>6</sup>	X	X	X	X	X
xSeries 300 <sup>8</sup>								X	X <sup>10</sup>	X <sup>11</sup>	X	X	X	X	X
xSeries 330 <sup>8</sup>								X	X <sup>10</sup>	X <sup>11</sup>	X	X	X	X	X
xSeries 342								X	X	X <sup>11</sup>	X	X	X	X	X
xSeries 350								X	X	X <sup>11</sup>	X	X	X	X	X
xSeries 370 <sup>13</sup>						X <sup>15</sup>	X <sup>7</sup>	X	X	X <sup>12</sup>	X	X	X	X	X
xSeries 380								X			X	X	X	X	X

1. See the other charts in this section for additional information concerning IBM rack-supported devices.
2. Includes one NetBAY3 stackable enclosure with casters. See IBM NetBAY3/NetBAY3E Stackable Enclosures section for supported devices.
3. Includes one NetBAY3E stackable enclosure with casters. See IBM NetBAY3/NetBAY3E Stackable Enclosures section for supported devices.
4. Usable only with NetBAY22 Rack Cabinet P/N 9306200.
5. Rack installation requires appropriate Conversion Kit.
6. Select as an option to improve cable management.
7. A maximum of three NetBAY3 or NetBAY3E enclosures may be stacked beneath a supported system unit. NetBAY3 and NetBAY3E enclosures are shipped separately and not while attached to the server system unit.
8. Blank filler panels supplied in Kit P/N 94G6670 should be placed on the front of any unused rack space to aid proper airflow through the x300 and x330 system units. If non-IBM racks are used, assure that both the front and rear doors offer a minimum of 48% open area uniformly distributed and in line with the installed servers. A clearance of at least 51mm (2in) must be maintained between the front door and the system unit's front bezel. The rear door must maintain the same or greater clearance.
9. Up to three xSeries 300s or 330s may be installed inside a NetBAY3E stackable enclosure, when the enclosure is installed beneath a supported server.
10. The front glass door must be removed to allow proper airflow.
11. Although not required, the NetBAY22 Rack Extension Kit P/N 36L9702 is recommended for improved cable management.
12. NetBAY22 Rack Extension Kit P/N 36L9702 is required for proper rear door closure clearance.
13. Stand-alone tower installation requires appropriate Conversion Kit.
14. xSeries systems ship with standard country power cords. For connection of a Rack model to a high voltage UPS or PDU, or if a Tower model is being converted for rack installation and is to be connected to a UPS or PDU, a Rack Power Cable P/N 94G7448 (one for each power supply), must be ordered. Refer to the appropriate product section for more information about server power configuration.
15. A Rack-to-Tower kit is required when using xSeries 250 or xSeries 370 with a NetBAY3 or 3E. One NetBAY3 or 3E with casters, is supplied in the kit.



IBM Rack Mountable Units						
Description	Part Number (if applicable)	Size (U) <sup>4</sup>	Depth (mm) <sup>5</sup>	Approx Weight (Kg)	Power (Watts) Typical /Max (All cords to same source)	Number of Power Supplies and Line Cords <sup>7</sup> Typical/Max
<b>Server System Units</b>						
x200 <sup>1</sup>	-	4	508	19	245/350	1/1
x220 <sup>1</sup>	-	4	508	19	245/350	1/1
x232	-	5	635	35	385/550	1/1 <sup>6</sup>
x232 with Power Conversion <sup>6</sup>	-	5	635	36	420/600	2/3 <sup>6</sup>
x240	-	5	610	36	315/450	2/3
x250	-	8	610	56	350/475	2/4
x300 <sup>2</sup>	-	1	635	13	140/200	1/1
x330 <sup>2</sup>	-	1	635	13	140/200	1/1
x342	-	3	660	28	262/375	1/2
x350	-	4	711	34	365/525	1/3
x360	-	3	711	28	520/740	2/3
x370 <sup>3</sup>	-	8	711	73	1015/1450	3/3
x380	-	7	737	68	1400/2000	2/2
<b>I/O Units</b>						
RXE-100	86841RX	3	660	25	260/370	2/2
<b>Storage Units</b>						
EXP300	P/N 19K11xx	3	534	41	285/360	2/2
FASt200	P/N 19K11xx	3	559	25	275/390	2/2
FASt200HA	P/N 19K11xx	3	559	25	275/390	2/2
FASt500 Storage Server	P/N 00N69xx	4	610	34	140/200	2/2
FASt700 Storage Server	P/N 24P09xx	4	610	38	140/200	2/2
FASt EXP500 Storage Expansion Unit	P/N 00N71xx	3	559	27	245/350	2/2
SAN FC Switch 8-port	P/N 2109S08	1	432	8	-/200	1/2
SAN FC Switch 16-port	P/N 2109S16	2	432	13	-/200	1/2
SAN FC Switch 16-port	P/N 2109F16	1	635	13	-/200	1/2
<b>Tape Unit/Enclosure</b>						
NetMEDIA	P/N 03K8756	3	482	17	130/185	2/2
DLT Tape Library	P/N 00N79xx	4	508	32	-/135	1/1
3600 Series LTO Tape Library	P/N 21P99xx	5	686	38	500/700	1/1
3600 Series Expander Module	P/N 21P99xx	5	686	34	599/700	1/1
<b>Other Options</b>						
NetBAY 1 x 4 Console Switch	P/N 09N4290	1	203	2	-/100	1/1
NetBAY 2 x 8 Console Switch	P/N 09N4291	1	203	3	-/100	1/1
Flat Panel Console Kit w/o Keyboard	P/N 32P1032	1	610	12	-/100	1/1

- Requires 4Ux20D Tower-to-Rack Kit P/N 09N4300 to mount server unit into an EIA rack cabinet.
- To provide adequate cooling, blank filler panel kit P/N 94G6670 should be placed on the front of any unused rack space. If non-IBM racks are to be used, assure that both front and rear doors offer a minimum of 48% open area uniformly distributed and in line with installed servers. A clearance of 51 to 64mm (2 to 2.5in) must be maintained between the front of the door and the system unit's front bezel. The rear door must maintain the same or greater clearance. Nonrack or NetBAY3 installations are not supported.
- xSeries 370 requires installation of extension kit P/N 36L9703 or P/N 36L9702 when installed in a Rack Cabinet P/N 9306900/P/N9306910 or P/N 9306200 respectively, for proper rear door clearance.
- 1U= 1.75in= 44.45mm.
- Rack Extension Kit P/N 36L9702 adds 203mm (8inches) to the rear of a 9306-200 for cable management and is recommended for systems greater than 610mm deep.
- One 385W power supply standard on models P/N P811Xxx, P81RXxx, P821Xxx, P82Rxx, P841Xxx, P84Rxx. Two 250W power supplies on redundant models P/N P822Xxx, P82SXxx, P842Xxx, P84SXxx, P824Xxx, P82TXxx, P844Xxx, P84TXxx. The xSeries Hot-Swap Power Conversion Kit P/N 24P3513 supports up to three hot-swap power supplies. If converting a 385W model, remove the standard power supply and add the conversion kit with 250W power supplies. Models shipped redundant as standard do not require the conversion kit.
- Standard Country Line Cords are supplied standard with all units. Rack Power Cord P/N 94G7448 (one for each power supply) must be ordered optionally if connecting to a high voltage UPS or PDU.

General rack placement rules and other information:

- Locate heaviest components at the bottom of the rack (i.e. UPS, then servers or storage, etc.)
- Do not extend more than one component on side rails at a time.
- Maximum of three UPS (including no more than two APC 5000 UPS) per rack.
- Utilise side compartments for mounting PDU's and console switches prior to using EIA space.
- When mounting components in a rack, consider user and service requirements.
- When selecting length of power, console and storage cables, consider extension of cable management arms and overall cable routing.
- BTUs = Watts x 3.41



### Rack-Mountable Options

Part Number	Description	Information
28L4707	Rack Keyboard Tray	Supports Keyboards in racks, also used with Flat Panel Monitor Rack Mount Kit II
28L36xx <sup>1</sup>	Space Saver II Keyboard	1U, includes TrackPoint IV, requires Rack Keyboard Tray P/N 28L4707
94G7444	Monitor Compartment	
T3147xx <sup>2</sup>	E54 Color Monitor	9U, requires Monitor Compartment P/N 94G7444
T3247xx <sup>2</sup>	E74 Color Monitor	10U, requires Monitor Compartment P/N 94G7444
T274Axx <sup>2</sup>	G78 Color Monitor	10U, requires Monitor Compartment P/N 94G7444
T11AGxx <sup>2</sup>	T540 Flat Panel Color Monitor	3U, requires Flat Panel Monitor Rack Mount Kit II P/N 37L6888
37L6888	Flat Panel Monitor Rack Mount Kit II	Requires Rack Keyboard Tray P/N 28L4707
32P1032	NetBAY 1U Flat Panel Monitor Console Kit w/o Keyboard	1U, built-in Flat Panel Monitor (15in viewable image), space for Space Saver Keyboard.
09N4290	NetBAY 1 x 4 Console Switch	1U, mounts in sidewall compartments, EIA space, or Monitor Compartment; supports one to four servers, one console
09N4291	NetBAY 2 x 8 Console Switch	1U, mounts in sidewall compartments, EIA space, or Monitor Compartment; supports one to eight servers, two consoles (only one console when installed in the Monitor Compartment)
09N4293	NetBAY Console Cable Set - 2.1m (7ft)	Connects servers to console switch
94G7447	NetBAY Console Cable Set - 3.7m (12ft)	Connects servers to console switch
37L68xx <sup>4</sup>	NetBAY Rack PDU (EMEA)	1U, 100-240V, 15A, mounts in sidewall compartment or EIA space, 7 IEC 320-C13 outlets
37L6866	NetBAY Rack PDU (US)	1U, 100-240V, 15A, mounts in sidewall compartment or EIA space, 7 IEC 320-C13 outlets, requires one NEMA L5-20R or L6-20R wall receptacle
37L68xx <sup>5</sup>	NetBAY Server Dual-cord PDU (EMEA)	1U, 100-240V, 15/10A, mounts in sidewall compartment or EIA space, 4 IEC 320-C13 outlets
37L6865	NetBAY Server Dual-cord PDU (US)	1U, 100-240V, 15/10A, mounts in sidewall compartment or EIA space, 4 IEC 320-C13 outlets, requires two NEMA L5-20R or L6-20R wall receptacles
37L6885	NetBAY 200-240V Single-phase Front-end PDU	1U, 200-240V, shared 20A, mounts in sidewall compartment, 3 IEC 320-C19 outlets
37L6883	NetBAY 100-127V Single-phase Front-end PDU	1U, 100-127V, shared 30A, mounts in sidewall compartment, 3 IEC 320-C19 outlets, requires one NEMA L5-30R wall receptacle
37L6887	NetBAY 3-phase Front-end PDU	1U, 200-415V, shared 30A, mounts in sidewall compartment, 3 IEC 320-C19 outlets
32P16xx <sup>6</sup>	APC 2U Smart-UPS 1400RMiB	2U, 220-240V, four - 10 Amp, IEC 320-C13 outlets
14RIxxx <sup>3</sup>	APC Smart-UPS 1400RMiB	3U, 220-240V, four - 10 Amp, IEC 320-C13 outlets
30RIxxx <sup>3</sup>	APC Smart-UPS 3000RMiB	3U, 220-240V, eight - 10 Amp IEC 320-C13 and one -16 Amp IEC 320-C19 outlets
37L6862	APC Smart-UPS 5000RMiB	5U, 220-240V, eight - 10 Amp IEC 320-C13 and two -16 Amp IEC 320-C19 outlets
94G6670	Blank Filler Panel Kit	Consists of one 5U, one 3U, and two 1U blank filler panels
94G7442	Fixed Shelf	Supports equipment weighing up to a total of 45Kg
94G7448	Rack Power Cord -Type C12	IEC 320-C13 to IEC 320-C14 3.7m (12ft)

1. Where 'xx' represents country specific code: 46=Danish, 47=France, 48=Germany, 49=Italian, 50=Spanish, 51=UK English, 44=US English, and P/N 19K3831=Switzerland, 19K3832=Sweden/Finland, 19K3833=Portugal, 19K3834=Belgium, 19K3836=Russia, 19K3837=Poland.
2. Where 'xx' represents a specific country code: DK=Denmark, IS=Israel, IT=Italy, SD=Saudi Arabia, SA=South Africa, CH=Switzerland, UK=UK, EU=Europe.
3. Where 'xxx' represents the appropriate country code as follows: - DEN=Denmark, ISR=Israel, ITA=Italy, SDI=Saudi Arabia, SAF=South Africa, SWS=Switzerland, UKM=United Kingdom, EUR=Europe.
4. Where 'xx' represents the appropriate country code as follows: - 66=US/Saudi Arabia, 68=EU, 70=Denmark/Switzerland, 72=Israel, 74=Italy, 76=South africa, P/N 06P6028=UK.
5. Where 'xx' represents the appropriate country code as follows: - 65=US/Saudi Arabia, 67=EU, 69=Denmark/Switzerland, 71=Israel, 73=Italy, 75=South africa, P/N 06P6027=UK.
6. Where 'xx' represents a specific country code as follows: - 12=Europe, 13=UK, 14=Italy, 15=Switzerland, 16=Denmark, 17=South Africa, 18=Israel.

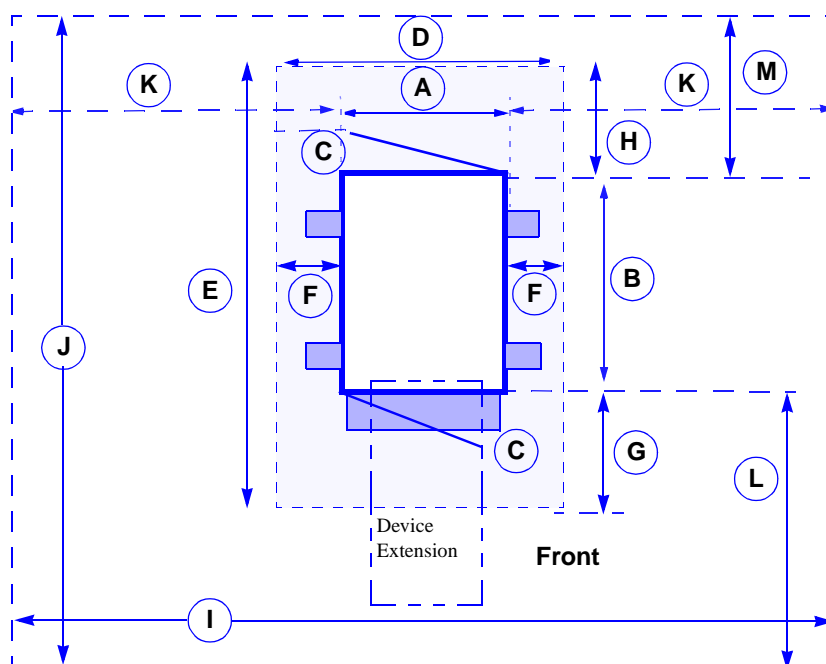

	Rack Cabinets P/Ns 9306xxx millimetres(inches)	Rack Cabinets P/N 9308xxx millimetres(inches)	Description
<b>Box Footprint</b>			
Dimension A	597(23.5)	648(25.5)	Width of rack
B	1001(39.4)	1105(43.5)	Depth of rack (not including front stabilizer)
C	610(24)	660(26)	Front and rear door clearance
<b>Operational Clearance</b>			
Dimension D	699(27.5)	749(29.5)	Width of Operational Clearance area
E	2372(93.4)	2794(110)	Depth of Operational Clearance area
F	51(2)	51(2)	Left/Right sides of rack to Operational Clearance area
G	762(30)	914(36)	Front of rack to Operational Clearance area
H	610(24)	660(26)	Rear of rack to Operational Clearance area
<b>Service Clearance</b>			
Dimension I	2426(95.5)	2477(97.5)	Width of Service Clearance area
J	3287(129.4)	3391(133.5)	Depth of Service Clearance area
K	914(36)	914(36)	Left/Right sides of rack to Service Clearance area
L	1524(60)	1524(60)	Front of rack to Service Clearance area
M	762(30)	762(30)	Rear of rack to Service Clearance area

### Console Switch Arrangements

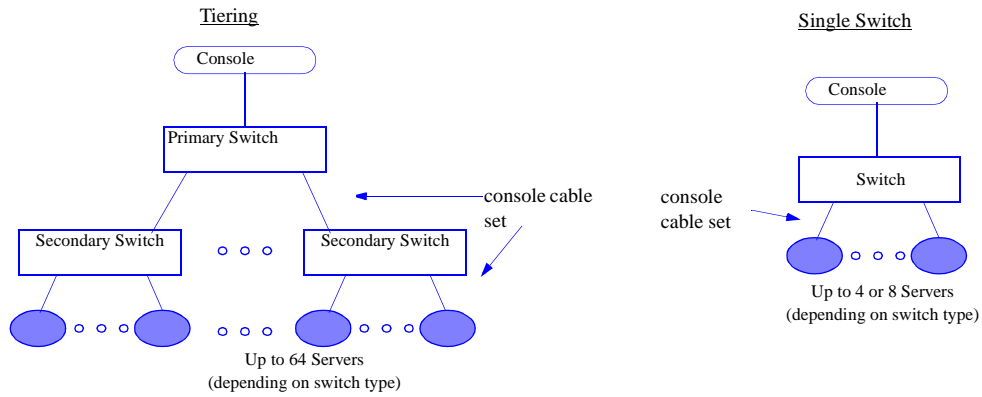

### Keyboard/Pointer/Monitor & Switch ... all in 3U space

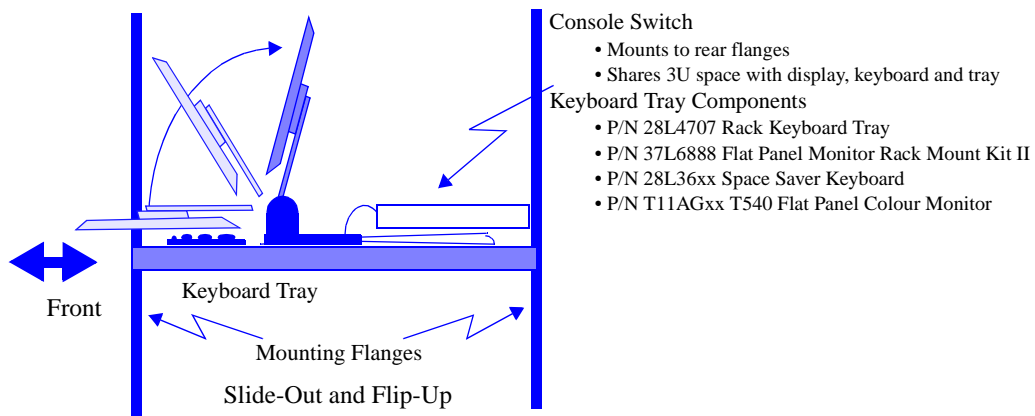

# NetBAY Rack Power Configuration Examples

## Possible Power Configurations:

### Single Rack PDU

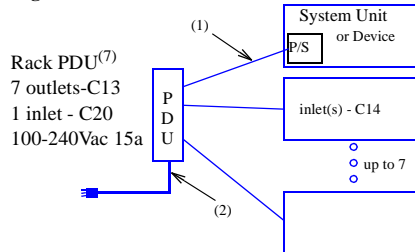

### Redundant Power Distribution

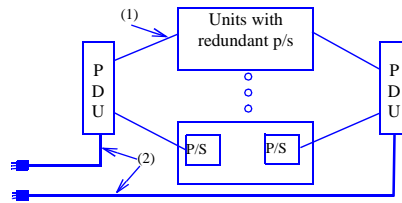

### PDU used as UPS back-end

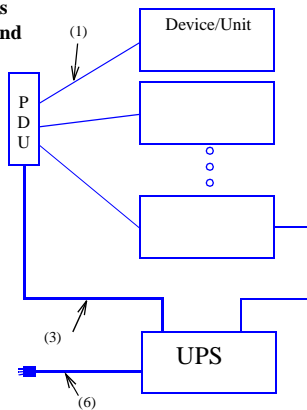

### Redundant Power Distribution with PDU and UPS

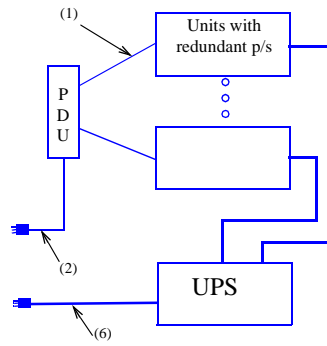

### Redundant Power Distribution with PDU and UPS with PDU

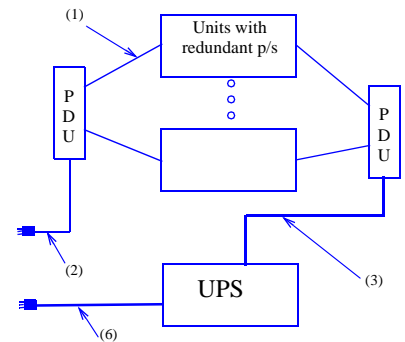

## Typical Rack Power Configurations:

Simple -- three Rack PDUs and one Front-end PDU (single circuit, 21 outlets)

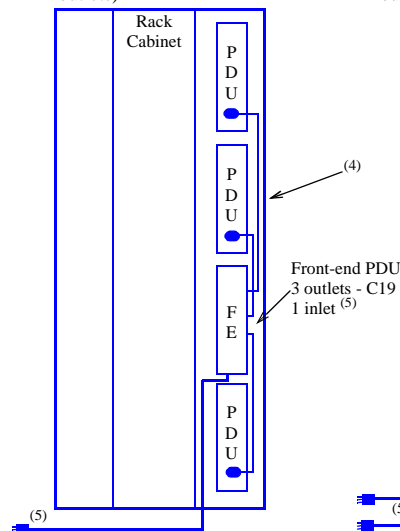

Redundant -- six Rack PDUs and two Front-end PDUs (dual circuit, 42 outlets)

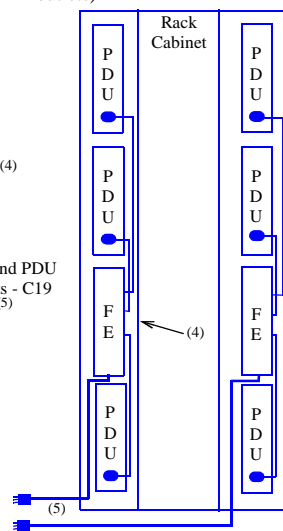

## Key:

inlet/outlet = direction of power supply flow in relation to subject device.

C13/C19 = Female Connectors  
C14/C20 = Male Connectors

## Rack Rules:

Total PDUs (LV PDUs, HV PDUs, Rack PDUs, Server PDUs, FE PDUs) = 8  
Total Server PDUs = 3  
Total Front-end PDUs = 2

Outlets:	C19	C13
Rack PDU	0	7
Server PDU	0	4
Front-end PDU	3	0
APC 1400RMiB UPS	0	4
APC 3000RMiB UPS	1	8
APC 5000RMiB UPS	2	8

## NOTES:

- RackPower Cables P/N 94G7448 (14ft) need to be ordered for each system unit or external enclosure etc. (one for each power supply). Refer to the appropriate product section for more details. This cable has a C13 connector one end and a C14 connector on the other end.
- Each PDU comes with a country-specific power cord.
- Internal rack power cable provided with APC SmartUPS 5000 UPS.
- Internal rack power cable provided with Front-end PDU.
- A power plug is provided with each Front-end PDU for connection (PDU end) to a customer-supplied (inlet) power cable.
- UPS comes with a country-specific (inlet) power cord or provides a terminal block for connection of a customer-supplied power cable.
- The NetBAY Server Dual-Cord PDU has two C20 inlet connectors and four C13 outlets. It is designed to provide switchover of the four attached devices to the alternate supply circuit in case of degradation of the primary.

Note: the Customer is required to provide a dedicated power supply circuit for each line cord protected with an appropriate circuit breaker.



## Country-Specific Considerations: Europe, Middle East and Africa

### Power Cables:

- (1). Device to PDU or UPS Rack Power Cable  
Option P/N 94G7448 3.7m (12ft)  
Connectors = IEC C13 and C14  
Rating: 10/15a
- (2). Rack and Server PDU to wall line cords  
Connectors = IEC C19 and country-specific  
Rating: 16/20a, 4.3m (14ft)
- (3). Rack PDU to UPS power cable x2  
Connectors/Rating = IEC C19 and C20, 16/20a  
provided with APC 5000RMiB UPS P/N 37L6862
- (4). Rack PDU to Front-end PDU power cables x3  
Connectors/Rating = IEC C19 and C20, 16/20a  
provided with the Front-end PDU
- (5). Front-end PDU to wall line cord  
special to country-specific connector,  
30/32a, 8.2ft (2.5m)

Rack and Server PDUs - Line Cords Included

PDU Part Number	Country	Inlet Line Cord Plug Type	Source Circuit (single phase 50/60Hz)	PDU Output (single phase 50/60Hz)
37L6866	USA/ Saudi Arabia	NEMA L5-20P	100-127Vac, 20a	seven 100-127Vac, shared 15a
		NEMA L6-20P	200-240Vac, 20a	
37L6868	European	CEE7-VII	220-240Vac, 16a	
37L6870	Denmark/Swiz.	IEC 309-2P+Gnd	220-240Vac, 16a	
37L6872	Israel	SII 32	220-240Vac, 16a	
37L6874	Italy	CEI 23-16	220-240Vac, 16a	
37L6876	South Africa	SABS 164	220-240Vac, 16a	
06P6028	UK	BS 1363/A	220-240Vac, 13a	

Front-end PDUs - Line Cord or Connector Plug provided

Part Number	Region	Type	Source Circuit (50/60Hz)	PDU Output (single phase 50/60Hz)
37L6883	Low Voltage (example: USA)	Plug: NEMA L5-30P Cable Provided	100-127Vac, 30a, single-phase	three 100-127Vac, 20a each, shared 30a
37L6884	High Voltage (example: USA)	Plug: NEMA L6-30P Cable Provided	200-240Vac, 30a, single phase line-to-line with ground	three 200-240Vac, shared 20a
37L6886	(example: USA)	Plug: NEMA L21-30P Cable Provided	200-250Vac, 30a, three-phase Y-connection with neutral	three 100-127Vac (115-145), 20a each
37L6885	(ex: Europe, M/ East, Africa)	IEC 309-2P+Gnd (inlet plug provided)	220-240Vac, 32a, single-phase	three 220-240Vac, 16a each, shared 32a
37L6887	(ex: Europe, M/ East, Africa)	IEC 309-3P+N+Gnd (inlet plug provided)	380-415Vac, 32a, three-phase Y-connection with neutral	three 220-240Vac, 16a each

## Max. Power Load Capacity -- xSeries Rack Systems

**NOTE:**

C = Rack PDU has a 15a circuit breaker  
W = FE PDU has a 20a fuse

@ = country specific:  
(see top chart)

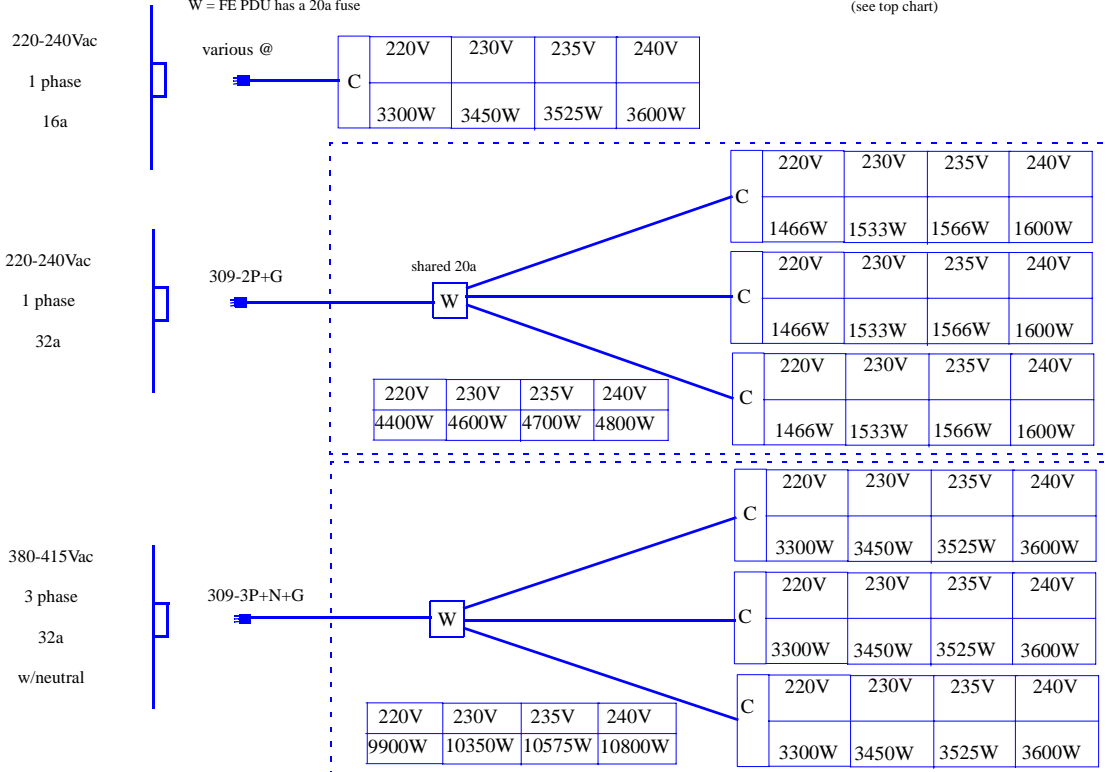





# Appendix A: Tape Drive Attributes

<i>Part Number</i>	<i>Withdrawn dummy</i>	<b>Description</b>	<i>SCSI Interface (bit)</i>	<i>Form Factor</i>	<i>Max GB-Native/Compr.<sup>2</sup></i>	<i>MB/sec - Native/compr.<sup>2</sup></i>	<i>Termination Incl.</i>	<i>68/50-pin Converter Incl.</i>	<i>Internal Cables</i>	<i>Data/Clean. Cartridges Std</i>	<i>Ext. Tape Enclosures<sup>1</sup></i>
<b>Tape Drives</b>											
20L0549	-	10/20GB TR5 Internal IDE Tape Drive	-	89mm (3.5in) SL or 133mm (5.25in) HH	10/20	1/2	-	-	-	1/0	-
09N4041	-	12/24GB DDS/3 4mm Internal Tape Drive	8	89 mm (3.5in) HH or 133 mm (5.25in)HH	12/24	1.1/2.2	Y	Y	-	1/1	10L7440 03K8756
00N7991	-	20/40 GB DDS/4 4-mm Internal Tape Drive	16 Ultra2 LVD	89 mm (3.5in) HH or 133 mm (5.25in)HH	20/40	2.75/5.5	N	-	-	1/1	10L7440 <sup>4</sup> 03K8756 <sup>3</sup>
09N4042	-	10/20GB NS Internal SCSI Tape Drive	8	89 mm (3.5in) SL or 133 mm (5.25in)HH	10/20	1/2	Y	Y	-	1/0	10L7440, 03K8756
09N4040	-	20/40GB DLT Internal SCSI Tape Drive	8	133 mm (5.25in)FH	20/40	1.5/3	N	Y	-	1/1	03K8756
00N7990	-	40/80 GB DLT Internal SCSI Tape Drive	16 Ultra2 LVD	133 mm (5.25in)FH	40/80	6/10	N	-	-	1/1	24P24xx <sup>14</sup> , 03K8756 <sup>3</sup>
00N8016	-	100/200 GB LTO Tape Drive	16 Ultra2 LVD	133 mm (5.25in)FH	100/200	15/30	N	-	-	1/1	24P24xx <sup>14</sup> , 03K8756 <sup>3</sup>
24P2396	-	100/200GB LTO Half-High Tape Drive	16 Ultra2 LVD	133mm (5.25in) HH	100/200	8/16	N	-	-	1/1	03K8756 <sup>3</sup>
00N8015	-	110/220GB Super DLT Internal SCSI Tape Drive	16 Ultra2 LVD	133mm (5.25in) FH	110/220	11/22	N	-	-	1/1	24P24xx <sup>14</sup> , 03K8756 <sup>3</sup>
24P2398	-	40/80GB Half-High DLT/VS Internal SCSI Tape Drive	16 Ultra2 LVD	133mm (5.25in) HH	40/80	3/6	N	-	-	1/1	03K8756 <sup>3</sup>
<b>Associated Options</b>											
00N7956	-	68-pin External Multimode LVD/SE SCSI Terminator	16 LVD/SE	Ext.	-	-	Y	N	-	-	10L7440
10K2340	-	Media Bay Tray and LVD Cable Kit <sup>5</sup>	16 LVD	Int.	-	-	Y	N	16-bit 2-drop	-	03K8756
<b>Tape Autoloaders</b>											
00N79xx <sup>12</sup>	-	DLT Tape Autoloader	16	Desktop	280/560	5/10	Y	-	-	1/1	-
00N7992	-	120/240 GB DDS/4 Tape Autoloader	16 Ultra2 LVD	133 mm (5.25")FH	120/240	3/6	N	-	-	5/1	24P24xx <sup>14</sup> , 03K8756
09N40xx <sup>13</sup>	-	3600 Series 900GB/1.8TB LTO Tape Autoloader <sup>6</sup>	16 Ultra2 LVD	Tower or 6U Rack	900/1.8TB	15/30	Y	-	-	1/1	-



*Part Number*  
*Withdrawn (dummy)*  
**Form Factor**  
**LEGEND**  
 HH: Half High - approx. height of 1.6"  
 SL: Slim Line - approx. height of 1"  
 FH: Full High  
**Description**  
*SCSI Interface (bit)*  
*Form Factor*  
*Max GB-Native/Compr. 2*  
*MB/sec - Native/compr. 2*  
*Termination Incl.*  
*68/50-pin Converter Incl.*  
*Internal Cables*  
*Data/Clean. Cartridges Std*  
*Ext. Tape Enclosures 1*

External Tape Enclosures											
Part Number	Withdrawn (dummy)	Description	SCSI Interface (bit)	Form Factor	Max GB-Native/Compr. 2	MB/sec - Native/compr. 2	Termination Incl.	68/50-pin Converter Incl.	Internal Cables	Data/Clean. Cartridges Std	Ext. Tape Enclosures 1
10L7440	-	External Half High SCSI Storage Enclosure <sup>7</sup>	8/16	Desktop	-	-	N	N	8-bit or 16-bit	-	-
03K8756	-	NetMEDIA Storage Expansion Unit EL <sup>8</sup>	16	Rack	-	-	Y	N	16-bit, 4-drop	-	-
10L7113	-	NetMEDIA Systems Management Adapter <sup>9</sup>	16	-	-	-	N	N	N	-	03K8756
24P24xx <sup>14</sup>	-	IBM Full-High SCSI Tape Enclosure <sup>10</sup>	16 Ultra2 LVD	Desktop or 3U Rack	-	-	Y	N	16-bit	-	-

- To determine cable requirements, note the tape drive's SCSI interface, the appropriate SCSI controller from the system configurator section and the desired enclosure then refer to Appendix D: Cables-Storage Units-Controllers. For installation of an internal tape drive into a server, see the appropriate system section.
- Data compression typically provides a 2X improvement in capacity and transfer rate, but since data compression is affected by many factors, actual improvements may be more or less than 2X.
- LVD support for LVD devices installed in a NetMEDIA Storage Expansion Unit EL P/N 03K8756 requires replacement of the standard single-ended internal cables with one or more (depending on configuration) cables from Media Bay Tray and LVD Cable Kit P/N 10K2340 which contains a single two-drop multi-mode terminated cable. If the standard cables are used for attachment to LVD devices, single-ended SCSI rules and bus speeds apply.
- Requires 68-pin External Multimode LVD/SE SCSI Terminator P/N 00N7956.
- Media Bay Tray and LVD Cable Kit P/N 10K2340 includes an internal two-drop multi-mode terminated LVD SCSI cable.
- If installed in a rack, a fixed shelf is required.
- Provides a black desktop 5.25" half-high (HH) tape enclosure. Connector is configurable as 50-pin Centronix or 68-pin high density. Requires either tape drive self termination or 68-pin External Multimode LVD/SE SCSI Terminator (P/N 00N7956).
- NetMEDIA Storage Expansion Unit EL P/N 03K8756 is a black 3U, 19" rack or NetBAY3/3E mountable tape enclosure which includes two full high (FH) or four half-high (HH) extended length 5.25" bays, two external 68-pin high density connectors and two internal four-drop single-ended terminated 16-bit SCSI cables for device attachment. Two power supplies and two standard country power cords are also included. Tip: The front rail clips will need to be reversed and screwed in from behind to secure the unit in a 930842x rack.
- NetMEDIA Systems Management Adapter P/N 10L7113 may be installed in a NetMEDIA Storage Expansion Unit to provide repeater function, LVDS interface, aggregate cable lengths up to 12 meters when attached to an LVD SCSI controller, and auto-termination when the Expansion Unit is powered off. External connector is 0.8-mm VHDCI.
- Black desktop or 3U rack tape enclosure supports 133mm (5.25in) full-high LVD tape devices including DLT technology. Requires a fixed shelf if installed in a rack. Will replace Tape Enclosure P/N 03K8705.
- A combination data/cleaning cartridge cleans the drive each time the data cartridge is used.
- Where 'xx' represents a country specific code: 70=UK, 71=Swiss, 72=Italy, 73=Israel, 33L4981=EU1, 33L4982=Denmark, 33L4983=South Africa/India.
- Where 'xx' represents a country specific code: 49=UK, 50=Europe, 51=Denmark, 52=South Africa, 53=Switzerland, 54=Italy, 55=Israel.
- Where 'xx' represents a country specific code: 35=UK, 39=Swiss, 40=Italy, 41=Israel, 36=EU, 37=Denmark, 38=South Africa.

**Note:** Tape support varies by system depending on internal bay availability, SCSI cabling type, number of cable drops, existence of a RAID controller and availability of a suitable external enclosure. The following general rules should be followed.

- Tapes are not supported for attachment to RAID controllers.
- Single-ended (non-LVD) devices may be attached to internal multi-mode terminated cables. The entire SCSI bus will be limited to single-ended operation with a maximum bus speed of Ultra-SCSI.
- LVD devices attached to single-ended terminated cables will operate in single-ended mode with a maximum bus speed of Ultra-SCSI.

#### Internal SCSI Cables and Optional SCSI Adapters

Most systems support the following SCSI adapters for use with tape. Consult the I/O Options table in the system sections for specific system support. Where tapes are supported internal to the system, the cables which ship with the adapters are supported for tape attachment. Some restrictions may apply based on cable and tape type which are explained in the note above.

Part Number	Description	Cable Description	External Connector
02K3454	PCI Fast/Wide Ultra SCSI Adapter	Four-drop, single-ended terminated, 16-bit	68-pin high density
19K4646	PCI Wide Ultra160 SCSI Adapter	Five-drop, multi-mode terminated	0.8mm VHDCI
10K2340	Media Bay Tray and LVD Cable Kit	Two-drop, multi-mode terminated	-



# Appendix B: Tape Library Attributes

**SCSI Interface & Cable Legend**  
M: Male - External  
68: 16-bit, 68-pin High Density connector  
0.8: 16-bit, 68-pin Very High Density Connection Interface (VHDCI)  
0.8 mm connector  
SE: Single-ended SCSI  
HVD: High Voltage Differential SCSI  
LVD: Low Voltage Differential SCSI

**Part Number**  
**Withdrawn: dummy 12**

**SCSI Interface**  
**Form Factor**  
**Terminator Included**  
**External Cables Incl**  
**SCSI Controllers Incl**  
**Data Cartridges: std/max**  
**Cleaning Cartridges std.**  
**Cartridge Mags std/max**  
**Qty. of drives: std./max**  
**Max Storage: Native/Compressed**  
**MB/sec<sup>1</sup>: Native/compr.**

DLT Tape Libraries													
00N79xx <sup>8</sup>	-	DLT Tape Library - Tower	SE	Desktop	Y	M68-M68 (3m)	Y	1/14	1	2/2	1/3	490GB/980GB	5/10
00N79xx <sup>8</sup>	-	DLT Tape Library - Rack <sup>2</sup>	SE	4U Rack	Y	M68-M68 (3m)	Y	1/14	1	2/2	1/3	490GB/980GB	5/10
33L4979	-	DLT Library Drive Upgrade <sup>3</sup>	SE	-	N	Jumper	N	-	-	-	-	-	5/10
3600 Series Tape Libraries													
21P99xx <sup>9</sup>	31/01/02	3600 Series 2/4TB LTO Tape Library (Tower)	LVD	Tower	Y	M68-M0.8 (2m)	N	1/20	1	4/4	1/2	2TB/4TB	15/30
21P99xx <sup>9</sup>	-	3600 Series 2/4TB LTO Tape Library (Rack)	LVD	5U Rack	Y	M68-M0.8 (2m)	N	1/20	1	4/4	1/2	2TB/4TB	15/30
21P99xx <sup>10</sup>	-	3600 Series 2-Drive, 20-Cartridge Expander Module <sup>4</sup>	LVD	5U Rack	Y	M68-M0.8 (2m)	N	0/20	1	4/4	0/2	2TB/4TB	15/30
09N40xx <sup>11</sup>	-	3600 Series 900GB/1.8TB LTO Tape Autoloader <sup>5</sup>	LVD	Tower or 6U Rack	Y	M68-M0.8 (2m)	N	1/9	1	1/1	1/1	900/1.8TB	15/30
09N4048	-	3600 Series LTO Drive Upgrade Option <sup>6</sup>	LVD	-	N	Jumper (1m)	N	-	-	-	-	-	15/30
09N4047	-	Fibre Tape Automation Adapter <sup>7</sup>	LVD	-	-	M68-M08 (2 x 18in)	-	-	-	-	-	-	-

- Transfer rates are for single SCSI Channel configurations. Tape Libraries utilising split library or dual host configurations may obtain higher rates. Data compression typically provides a 2X improvement in capacity and transfer rate, but since data compression is affected by many factors, actual improvements may be more or less than 2X.
- Includes Fixed Shelf P/N 94G7442 for installation in an IBM Rack or NetBAY22.
- Upgrade 33L4979 is an additional drive for DLT Tape Libraries. Up to two tape drives may be installed for a maximum of three drives per DLT Tape Library
- NOTE: The 3600 Series 2-Drive, 20-Cartridge Expander Module is designated as IBM Install and must be installed by IBM service. This installation service is included without additional charge. Supported only with the 3600 Series LTO Tape Library (Rack) P/N 21P99xx. One additional EIA space has to be allowed when installing either one or two (maximum) units - to accommodate a filler plate for cable routing. Up to two 3600 Series LTO Drive Upgrade Options can be installed in each module or the module can operate off the LTO drives installed in the LTO tape library.
- If installed in a rack, a fixed shelf is required. Allow an additional 1U for the fixed shelf. One unit only per shelf is supported.
- Install in second drive bay of 3600 Series LTO Tape Libraries or in either of the two bays of the 3600 Series 2-drive, 20-Cartridge Expander Module to increase performance. Includes an LTO (Ultrium) drive and a one-meter external LVD SCSI cable.
- This adapter installs in a 3600 Series Tape Library or Expander Module. It includes a Fibre Channel-to-SCSI bridge that serves as a router to provide direct attachment to a Fibre Channel Host Adapter or GBIC installed in a Fibre Channel Switch P/N 2109S08 or 2109S16 or Managed Hub P/N 35L1647 via a short-wave Fibre Channel cable P/N 36L9973, 03K9306, 03K9305. Two 18in LVD cables with a 68-pin male connector on one end and a male 0.8mm VHDCI connector on the other end are included with the option. The 68-pin connector attaches to either the standard or optional LTO tape drive in the Tape Library or Expander Module and the 0.8mm VHDCI connector attaches to one of two connectors on the adapter. Each adapter supports up to two LTO drives in a single 3600 layer P/N 21P99xx<sup>10</sup> (Tape Library - Rack) or P/N 21P99xx<sup>11</sup> (Expander Module), using one SCSI connector and cable for each drive.
- Where 'xx' represents a specific country code as follows:- Tower version - 74=EU1, 75=Denmark, 76=India/South Africa, 77=UK, 78=Swiss, 79=Italy, 80=Israel; Rack version - 81=EU1, 82=Denmark, 83=India/South Africa, 84=UK, 85=Swiss, 86=Italy, 87=Israel.
- Where 'xx' represents a specific country code as follows:- Tower version - 71=Europe, 72=Denmark, 73=South Africa, 70=UK, 74=Swiss, 75=Italy, 76=Israel; Rack version - 78=Europe, 79=Denmark, 80=South Africa, 77=UK, 81=Swiss, 82=Italy, 83=Israel.
- Where 'xx' represents a specific country code as follows:- 85=Europe, 86=Denmark, 87=South Africa, 84=UK, 88=Swiss, 89=Italy, 90=Israel.
- Where 'xx' represents a specific country code as follows:- 49=UK, 50=Europe, 51=Denmark, 52=South Africa, 53=Switzerland, 54=Italy, 55=Israel.
- Not available from IBM after this date. Business Partner inventory may be available.





## Appendix C: UPS Runtime Estimate (minutes)

Servers	# Pwr. Cords Std/Max	Watts Load Max./Typ. <sup>1</sup>
xSeries 200 <sup>2</sup>	1/1	350/245
xSeries 220 <sup>2</sup>	1/1	350/245
xSeries 232 (one 385W power supply) <sup>2</sup>	1/1	400/280
xSeries 232 (two 250W power supplies) <sup>2</sup>	2/3	450/315
xSeries 240 <sup>2</sup>	2/3	450/315
xSeries 250 <sup>2</sup>	2/4	475/350
xSeries 300 <sup>2</sup>	1/1	200/140
xSeries 330 <sup>2</sup>	1/1	200/140
xSeries 342 <sup>2</sup>	1/2	390/270
xSeries 350 <sup>2</sup>	1/3	525/395
xSeries 360 <sup>2</sup>	2/3	1450/1015
xSeries 370 <sup>2</sup>	3/3	1450/1015
xSeries 380 <sup>2</sup>	4.4	1450/1015
Other Devices		
FASt500 Storage Server (P/N 00N69xx) <sup>2</sup>	2/2	200/140
FASt EXP500 Storage Expansion Unit (P/N 00N71xx) <sup>2</sup>	2/2	350/245
FASt200 Storage Server (P/N 19K11xx) <sup>2</sup>	2/2	390/275
FASt200 HA Storage Server (P/N 19K11xx) <sup>2</sup>	2/2	390/275
FASt700 Storage Server (P/N 24P09xx) <sup>2</sup>	2/2	390/275
EXP300 Storage Expansion Unit (P/N 19K11xx) <sup>2</sup>	2/2	360/285
SAN Fibre Channel Switch 8-port (P/N 2109S08)	1/2	200/n/a
SAN Fibre Channel Switch 16-port (P/N 2109S16)	1/2	200/n/a
SAN Fibre Channel Switch 16-port (P/N 2109F16)	1/2	200/n/a
SAN Data Gateway Router (LVD) (P/N 2108R3L)	1/1	90/n/a
DLT Tape Autoloader and Library (P/N 00N79xx)	1/1	135/n/a
NetMEDIA Storage Expansion Unit EL (P/N 03K8756)	2/2	185/130

1. This table represents general guidelines for selecting the appropriate UPS based on minimum and typical runtime estimates. A 'maximum configuration' load will result in 'minimum' UPS runtime. 'Typical' loads are based on a production system running at approximately 70% of maximum capacity. The 'typical' loads represent a more likely configuration and, therefore, a more likely estimate of runtime. Customer environments are unique and are unlikely to be precisely represented by any of the specific entries in the table.

2. Power-Factor Corrected (PFC) power supply.

UPS Attributes <sup>1</sup>	Tower					Rack Mounted			
	EMEA P/N	SU-700iNET P/N SUP072Y	SU-1000iNET P/N SUP102Y	SU-1400iNET P/N SUP142Y	SU-2200iNET P/N 06P60xx <sup>6</sup>	2U SU-1400RMiB P/N 32P16xx <sup>8</sup>	SU-1400RMiB P/N 14R1xx <sup>7</sup>	SU-3000RMiB P/N 30R1xxx <sup>7</sup>	SU-5000RMiB P/N 37L6862
	US P/N	SU-700NET 94G3134	SU-1000NET 94G3135	SU-1400NET 94G3136	Not Available	2U SU-1400RMB 32P1020	SU-1400RMB 94G6674	SU-3000RMB 94G6676	SU-5000RMB 37L6861
Communications Links to Servers		1	1	1	1	1	1	3	3
Color		black	black	black	beige	black	black	black	black
EIA Height		-	-	-	-	2U	3U	3U	5U
<b>EMEA Models</b>									
50/60Hz, single phase, VAC <sup>2,3</sup> :		220-240 (208) <sup>2</sup>	220-240 (208) <sup>2</sup>	220-240 (208) <sup>2</sup>	220-240 (208) <sup>2</sup>	220-240 (208) <sup>2</sup>	220-240 (208) <sup>2</sup>	220-240 (208) <sup>2</sup>	220-240 (208) <sup>2</sup>
10 Amp, IEC 320-C13 Device Receptacles		4	4	4	8	4	4	8	8
16 Amp, IEC 320-C19 PDU Receptacles		-	-	-	1	-	-	1	2
Line Cord Receptacle (IEC 320)		C14	C14	C20	C20	C14	C14	C20	TB <sup>5</sup>
<b>US Models</b>									
50 or 60 Hz, single phase, VAC:		120 (120) <sup>2</sup>	120 (120) <sup>2</sup>	120 (120) <sup>2</sup>	-	120 (120) <sup>2</sup>	120 (120) <sup>2</sup>	120 (120) <sup>2</sup>	200-220 (208) <sup>2</sup>
Receptacles (NEMA 5-15R)		4	6	6	-	6	6	8	-
10 Amp, IEC 320-C13 (Device) receptacles		-	-	-	-	-	-	-	8
16 Amp, IEC 320-C19 (PDU 94G7450) receptacles		-	-	-	-	-	-	-	2 <sup>4</sup>
Line Cord Length, NEMA Plug		6 ft., 5-15P	6 ft., 5-15P	6 ft., 5-15P	-	6 ft., L5-15P	6 ft., L5-15P	6 ft., L5-30P	8 ft., L5-30P



1. Data provided by APC.
2. How-to-Read example for 220-240(208): Input VAC is 220- 240 as is the UPS output when electric service is active. When electric service is interrupted and the UPS is in battery mode, the UPS output is 208 VAC.
3. Battery output may be set to 220, 225, 230, or 240 VAC.
4. Two PDU jumper cables ship with the UPS for attachment from the IEC 320-C19 receptacles to Power Distribution Units (PDU) (P/N 2PDUxxx).
5. SU-5000RMiB (P/N 37L6862) contains a Terminal Block (TB) for direct attachment to an electrical source by qualified personnel.
6. Where 'xx' represents the appropriate country code as follows:- 14=UK, 15=Denmark/Switzerland, 16=EUR, 17=Israel, 18=Italy, 19=South Africa.
7. Where 'xxx' represents the appropriate country code as follows:- DEN=Denmark, ISR=Israel, ITA=Italy, SDI=Saudi Arabia, SAF=South Africa, SWS=Switzerland, UKM=United Kingdom, EUR=Europe.
8. Where 'xx' represents a specific country code as follows:- 12=Europe, 13=UK, 14=Italy, 15=Switzerland, 16=Denmark, 17=South Africa, 18=Israel.

Total Configuration Runtime Estimation (Time in minutes) <sup>1</sup>								
EMEA Part Number	Tower				Rack Mount			
	SU-700iNET P/N SUP072Y	SU-1000iNET P/N SUP102Y	SU-1400iNET P/N SUP144Y	SU-2200iNET P/N 06P60xx <sup>5</sup>	2U SU-400RMiB P/N 32P16xx <sup>7</sup>	SU-1400RMiB P/N 14R1xxx <sup>6</sup>	SU-3000RMiB P/N 30R1xxx <sup>6</sup>	SU-5000RMiB P/N 37L6862
US Part Number	SU-700NET 94G3134	SU-1000NET 94G3135	SU-1400NET 94G3136	Not Available	2U SU-1400RMB 32P1020	SU-1400RMB 94G6674	SU-3000RMB 94G6676	SU-5000RMB 37L6861
Total Load (Watts)	Runtime Minutes	Runtime Minutes	Runtime Minutes	Runtime Minutes	Runtime Minutes	Runtime Minutes	Runtime Minutes	Runtime Minutes
200	22	38	62	130	45	45	104	240
250	17	28	43	104	34	34	84	200
300	12	22	34	85	25	25	70	166
350	9	18	29	71	22	22	58	145
400	7	14	23	65	18	18	52	125
450	5	12	20	52	15	15	45	110
500	-	11	18	43	13	13	38	97
550	-	9	16	38	11	11	35	87
600	-	8	13	34	10	10	31	76
650	-	7	12	31	9	9	29	68
700	-	6	11	28	8	8	26	63
750	-	-	10	25	8	8	24	59
800	-	-	9	23	7	7	22	55
850	-	-	8	21	7	7	20	51
900	-	-	7	19	6	6	18	47
950	-	-	6	18	5	5	17	43
1000	-	-	-	17	-	-	16	39
1100	-	-	-	15	-	-	14	34
1200	-	-	-	13	-	-	12	31
1300	-	-	-	11	-	-	10	28
1400	-	-	-	9	-	-	9	25
1500	-	-	-	9	-	-	8	22
1600	-	-	-	8	-	-	8	20
1700	-	-	-	-	-	-	7	18
1800	-	-	-	-	-	-	-	17
1900	-	-	-	-	-	-	-	14
2000	-	-	-	-	-	-	-	12
2100	-	-	-	-	-	-	-	11
2200	-	-	-	-	-	-	-	11
2300	-	-	-	-	-	-	-	10
2400	-	-	-	-	-	-	-	10
2500	-	-	-	-	-	-	-	9
2600	-	-	-	-	-	-	-	9
2700	-	-	-	-	-	-	-	8
2800	-	-	-	-	-	-	-	8

1. Data provided by APC.

Steps:

1. Identify the devices contained in the configuration.
2. Sum the load (watts) of all devices in the configuration. Use either Maximum Load for minimum runtime, or Typical Load for typical runtime.
3. Find the Total Configuration Load in the table above.
4. Select the most appropriate UPS model to achieve the desired runtime.
5. Where 'xx' represents the appropriate country code as follows:- 14=UK, 15=Denmark/Switzerland, 16=EUR, 17=Israel, 18=Italy, 19=South Africa.
6. Where 'xxx' represents the appropriate country code as follows:- DEN=Denmark, ISR=Israel, ITA=Italy, SDI=Saudi Arabia, SAF=South Africa, SWS=Switzerland, UKM=United Kingdom, EUR=Europe.
7. Where 'xx' represents a specific country code as follows:- 12=Europe, 13=UK, 14=Italy, 15=Switzerland, 16=Denmark, 17=South Africa, 18=Israel.

NOTE: If the Total Configuration Load is greater than the entries above, split the load across two or more UPS units.

# Appendix D: External SCSI Cabling, Storage Units and Controllers



			<b>Instructions:</b> Identify Desired Controller Row and Storage Unit Column. The intersection of row and column contains the cable group letter which supports the connection. Go to the cable group under the corresponding storage unit for specific support. Read all Notes for row, column, and any cable group footnotes.								
			Storage Enclosure Unit			EXP300 19K11xx	External HH SCSI 10L7440	Full-High SCSI Enclosure 24P24xx	NetMEDIA 03K8756	NetMEDIA Adapter 10L7113	3600 Libraries 21P99xx
			Max.MB/sec.) <sup>1</sup>			160	-	-	-	-	30
			LVDS			X	-	X	-	-	X
			Connector Type			F0.8	F68 or F50	F68	F0.8	F0.8	F68
Description	Part Number	Max./ Channel (MB/sec) <sup>1</sup>	LVDS	Connector Type/ Max	Note #	2, 3	4	4	2, 4	2, 4, 6	2, 3, 5
<b>RAID Storage Controllers</b>											
ServeRAID-4H Ultra160 SCSI Controller	37L6889	160	X	F0.8/4	8	A	-	-	-	-	-
ServeRAID-4Mx Ultra160 SCSI Controller	06P5736	160	X	F0.8/2	8	A	-	-	-	-	-
ServeRAID-4Lx Ultra160 SCSI Controller	06P5740	160	X	F0.8/1	8	A	-	-	-	-	-
<b>Ultra160 SCSI Controllers</b>											
PCI Wide Ultra160 SCSI Adapter	19K4646	160	X	F0.8/1	-	-	B	B	A	A	B <sup>3</sup>
xSeries 350	Onboard	160	X	F0.8/1	-	-	B	B	A	A	B <sup>5</sup>
xSeries 380	Onboard	160	X	F0.8/1	-	-	-	-	-	-	-
<b>Ultra2 SCSI Controllers</b>											
xSeries 240	Onboard	80	X	F0.8/1	-	-	B	B	A	A	B <sup>5</sup>
xSeries 250	Onboard	80	X	F0.8/1	-	-	B	B	A	A	B <sup>5</sup>
xSeries 370	Onboard	80	X	F0.8/1	-	-	B	B	A	A	B <sup>5</sup>
<b>Ultra SCSI Controllers</b>											
PCI Fast/Wide Ultra SCSI Adapter	02K3454	40	-	F68/1	7	-	C	-	B	B	-
<b>No Onboard External Port<sup>11</sup></b>											
xSeries 200	Onboard	-	-	N/A	-	-	-	-	-	-	-
xSeries 220	Onboard	-	-	N/A	-	-	-	-	-	-	-
xSeries 232	Onboard	-	-	N/A	-	-	-	-	-	-	-
xSeries 300	Onboard	-	-	N/A	-	-	-	-	-	-	-
xSeries 330	Onboard	-	-	N/A	-	-	-	-	-	-	-
xSeries 342	Onboard	-	-	N/A	-	-	-	-	-	-	-
xSeries 360	Onboard	-	-	N/A	-	-	-	-	-	-	-
<b>Cable Group A (M0.8-M0.8)</b>											
Netfinity 2M Ultra2 SCSI Cable	03K9310	-	X	M0.8-M0.8	9	X <sup>10</sup>	-	-	X	X	-
Netfinity 4.2M Ultra2 SCSI Cable	03K9311	-	X	M0.8-M0.8	9	X	-	-	X	X	-
Netfinity 20 M Ultra2 SCSI Cable	37L7101	-	X	M0.8-M0.8	7	X	-	-	-	-	-
<b>Cable Group B (M68-M0.8)</b>											
IBM 2M External .8mm SCSI Cable	01K8027	-	-	M68-M0.8	-	-	X	X	X	X	X <sup>9</sup>
<b>Cable Group C (M68-M68)</b>											
PC Server F/W to F/W External SCSI Cable-1m	SS2C02Y	-	-	M68-M68	12	-	X	-	-	-	-
<b>Cable Group G (Other)</b>											
68-pin External Multimode LVD/SE SCSI Terminator	00N7956	-	-	M68	-	-	X	-	-	-	-

1. Maximum supported speeds may be limited by installation of lower speed devices, controllers or cable lengths greater than 2m.
2. Rack installation cable management requires devices to have a minimum cable length of 2 meters. Cable length requirements will vary based on placement within a single or multiple rack suite.
3. Maximum speeds may be limited by the installed devices or SCSI controller.
4. Daisy chaining tape enclosures is not supported at this time.
5. The 3600 Series Tape Libraries (rack or tower) support up to two Expander Modules P/N 21P99xx. 3600 Series Tape Libraries and Expander Module are shipped with a 2m M68-M0.8 external SCSI Cable P/N 01K8027.
6. NetMEDIA Systems Management Adapter (P/N 10L7113) may be installed in a NetMEDIA Storage Expansion Unit to provide repeater function, LVDS interface, aggregate cable lengths up to 12 meters when attached to an LVD SCSI controller, and auto-termination when the Expansion Unit is powered off. External connector is 0.8-mm VHDCI.
7. Cable lengths exceeding 4.3m are NOT supported for attachment to non-LVD controllers.
8. Maximum speeds may be limited by the enclosure or installed devices.
9. Supports attachment to Ultra-2 or single-ended SCSI controllers with operational speeds of up to Ultra-2. Controller, storage unit, cable length or storage device limitations may apply (see Max. MB/sec row and column above).
10. EXP300 P/N 19K11xx include a single 2m Ultra2 SCSI cable similar to the 2m Ultra2 SCSI Cable P/N 03K9310.
11. No external SCSI port is available on these systems. A supported optional controller must be installed. See the systems section to determine which controllers and external storage units are supported then refer back to this table for cable requirements using the controller row.
12. Not supported for use in a rack. Rack installations require a minimum cable length of two meters.





# Appendix E: Internal Storage Cabling Overview



System	IDE Connections				SCSI Connections									Media	Int RAID		
	IDE connector # <sup>1</sup>	connects to (as shipped)	std cable (IDE)	additional connectivity	# standard SCSI controllers	standard SCSI controller type	onboard?	# channels	channel reference	internal (I) or external (E) connector?	type of connector	intended or standard connection	standard SCSI cable (16-bit LVD)			terminated?	optional connectivity
x200 IDE	1	CD-ROM	2-drop <sup>2</sup>	1 optical, IDE tape or IDE HDD	-	-	-	-	-	-	-	-	-	-	-	19K4646 <sup>10</sup>	-
	2	IDE HDD	2-drop	1 HDD	-	-	-	-	-	-	-	-	-	-	-	-	-
x200 SCSI	1	CD-ROM	2-drop	1 optical or IDE tape	1	U160	N	1	A	I	68-pin	1 fixed SCSI HDD	5-drop	Y	3 fixed HDDs, 1 HH tape <sup>11</sup>	10K2340 <sup>14</sup> or 19K4646 <sup>11</sup>	Y <sup>14</sup>
x220 fixed	1	CD-ROM	2-drop	1 optical	1	U160	Y	1	A	I	68-pin	1 fixed SCSI HDD or open bay	5-drop	Y	3 fixed HDDs, 1 HH tape <sup>11</sup>	10K2340 <sup>14</sup> or 19K4646 <sup>11</sup>	Y <sup>14</sup>
x220 H/S	1	CD-ROM	2-drop	1 optical	1	U160	Y	1	A	I	68-pin	H/S backplane	2-drop	N <sup>7</sup>	-	10K2340 <sup>15</sup> or 19K4646 <sup>12</sup>	Y <sup>15</sup>
x232	1	CD-ROM	2-drop	1 optical	1	U160	Y	2	A	I	68-pin	H/S backplane	1 drop	N <sup>7</sup>	-	-	Y <sup>15</sup>
	-	-	-	-	-	-	-	-	B	I	68-pin	media bays <sup>6, 13</sup>	-	-	2 HH or 1 FH tape	10K2340 <sup>13</sup>	-
x240	1	CD-ROM	2-drop	-	1	U2	Y	2	A	I	68-pin	H/S backplane	1-drop	N <sup>7</sup>	-	10K2340 or 19K4646 <sup>8</sup>	Y <sup>15</sup>
	-	-	-	-	-	-	-	-	B	E	0.8mm VHDCI	ext SCSI device	-	-	-	-	-
x250	1	CD-ROM	2-drop	-	1	U2	Y	2	B	I	68-pin	H/S backplane <sup>5</sup>	1-drop	N <sup>7</sup>	-	standard or 19K4646 <sup>16</sup>	Y <sup>15</sup>
	-	-	-	-	-	-	-	-	A	E	0.8mm VHDCI	ext SCSI device	-	-	-	-	-
x300 IDE	1	CD-ROM	1-drop <sup>3</sup>	-	-	-	-	-	-	-	-	-	-	-	-	-	-
	2	IDE HDD	2-drop	1 IDE HDD	-	-	-	-	-	-	-	-	-	-	-	-	-
x300 SCSI	1	CD-ROM	1-drop <sup>3</sup>	-	1	U160	N	1	A	I	68-pin	1 fixed SCSI HDD	2-drop	Y	1 fixed HDD	-	Y <sup>14</sup>
x330 IDE	1	CD-ROM	1-drop <sup>3</sup>	-	-	-	-	-	-	-	-	-	-	-	-	-	-
	2	IDE HDD	2-drop	1 IDE HDD	-	-	-	-	-	-	-	-	-	-	-	-	-
x330 fixed SCSI	1	CD-ROM	1-drop <sup>3</sup>	-	1	U160	Y	1	A	I	68-pin	1 fixed SCSI HDD	2-drop	Y	1 fixed HDD	-	Y <sup>14</sup>
x330 H/S SCSI	1	CD-ROM	1-drop <sup>3</sup>	-	1	U160	Y	1	A	I	68-pin	H/S backplane	1-drop	N <sup>7</sup>	-	-	Y
x342	1	CD-ROM	1-drop <sup>4</sup>	-	1	U160	Y	2	A	I	68-pin	H/S backplane	1-drop	N <sup>7</sup>	-	-	Y <sup>15</sup>
	-	-	-	-	-	-	-	-	B	I	68-pin	media bays <sup>6, 13</sup>	see media column	-	2 HH or 1 FH tape	10K2340 <sup>13</sup>	-

System	IDE Connections				SCSI Connections										Media	Int RAID	
	1	CD-ROM	2-drop	-	1	U160	Y	2	A	I	68-pin	H/S backplane	1-drop	N <sup>7</sup>			-
x350	1	CD-ROM	2-drop	-	1	U160	Y	2	A	I	68-pin	H/S backplane	1-drop	N <sup>7</sup>	-	-	Y
	-	-	-	-	-	-	-	-	B	E	0.8mm VHDCI	ext SCSI device <sup>6,17</sup>	1-drop	-	optional b/plane or ext device <sup>17</sup>	-	-
x360	1	CD-ROM	1-drop <sup>19</sup>	-	1	U160	Y	1	A	I	Integrated	H/S backplane <sup>20</sup>	-	-	-	-	Y <sup>21</sup>
x370	1	CD-ROM	2-drop	-	1	U2	Y	2	A	I	68-pin	H/S backplane	1-drop	N <sup>7</sup>	-	-	Y
	-	-	-	-	-	-	-	-	B	E	0.8mm VHDCI	ext SCSI device	-	-	-	-	-
x380	1	CD-ROM	1-drop	-	1	U160	Y	2	A	I	68-pin	H/S backplane	1-drop	N <sup>7</sup>	-	-	Y <sup>18</sup>
	2	LS-120	1-drop	-	-	-	-	-	B	E	0.8mm VHDCI	ext SCSI device	-	-	-	-	-

- IDE controllers generally have two channels, with one connector per channel. On most systems the second connector is not supported for use (except where shown on this chart). Standard IDE cables include two drops. Some IDE devices, such as a slim-line CD-ROM, use a single-drop ribbon cable, which is soldered to a backplane at the device end of the cable, instead of using a connector.
- The term drop refers to a device connector on a cable. The connector that attaches to the controller is not counted as a drop.
- The cable is connected to one of the channels (connectors) of the IDE controller, and at the device end it is soldered to a dedicated backplane.
- This single-device cable is soldered to the CD-ROM backplane. In order to install one or two optional optical devices in vacant media bays, the two-drop cable included with the optional devices is connected to one connector of the IDE controller and one of the two drops connects to an optional device. The standard CD-ROM cannot be used when an optional device is installed in one or both media bays. A single optional device is configured as primary, and when two optional devices are installed, one must be configured as primary and the other as secondary (master and slave).
- xSeries 250 includes a split backplane with five HDD bays each. Refer to Internal SCSI Cabling in the x250 COG section for additional information.
- The 3-Pack Ultra160 Hot-swap Expansion Kit P/N 33L5050 is available, allowing conversion of the two media bays into three hot-swap bays in x232, x340 or x342 and adding three hot-swap bays in the x350. Through the use of a repeater card provided with the option, the expansion backplane can be cabled as an extension of the standard backplane and supported by its controller, or the expansion backplane can be cabled on an independent bus attached to either a separate channel of the integrated storage controller, or to a different (optional) controller.
- Termination is provided by the hot-swap backplane.
- Attachment of SCSI devices in either of the two available media bays requires optional SCSI storage controller P/N 19K4646 in a non-RAID system. This adapter comes with a supported cable. Two half-high or one full-high device may be installed. When a RAID adapter is connected to the hot-swap backplane. Media Bay Kit P/N 10K2340 supplies the appropriate cable for LVD Tape support via the integrated controller.
- An additional cable may be required, to connect SCSI devices installable in internal removable media bays, to the standard SCSI storage controller when the standard SCSI cable is used to connect an optional RAID adapter. Some systems ship with an extra cable coiled inside the system case, or the necessary cable is provided in one of the options specified in this column.
- If installing an IDE tape drive, the standard IDE cable is used. NOTE: the total number of IDE optical drives or HDDs supported and connectable across both IDE connectors is four. If installing an internal SCSI device in Bay 2, a supported SCSI storage controller is required. The single-channel Ultra160 SCSI adapter P/N 19K4646 includes a 16-bit five-drop terminated multimode SCSI cable and a 0.8mm VHDCI external connector. The PCI Fast/Wde Ultra SCSI Adapter P/N 02K3454 is also single-channel and includes a 16-bit four-drop terminated single-ended SCSI cable and a 68-pin external connector. Refer to the x200 Tape Options section for more information.
- To install an IDE tape drive in the available x200 media bay, the second connector of the standard IDE cable can be used. If installing a SCSI tape drive in x200 or 220 fixed SCSI disk models, one connector of the five-drop SCSI cable can be used, but this is not recommended, as it may adversely affect performance of the SCSI bus. For example, if the SCSI tape drive is an 8-bit device, the entire SCSI bus is limited to the speed of the tape drive. The recommended solution, is to add SCSI Adapter P/N 19K4646, to support the tape drive on a separate bus. The adapter comes with a supported cable.
- In a non-RAID hot-swap drive system, a SCSI Tape drive installed in the media bay (bay 2) or a fixed HDD installed in bay 4, are not supported on the same SCSI bus as the hot-swap backplane. The recommended solution, is to add SCSI Adapter P/N 19K4646, to support either of these on a separate bus. The adapter comes with a supported cable. Connecting a tape drive on the same bus as a HDD is not recommended, as the tape drive can affect the performance of the entire bus. See note (16) for internal RAID configuration.
- Media bay attachment requires a supported cable such as the two-drop terminated LVD cable provided in the Media Bay Tray and LVD Cable Kit (P/N 102340).
- In fixed disk models, an optional SCSI RAID adapter can be connected to the standard two-drop (x300, x330) or five-drop (x200, x220) SCSI cable. When the standard cable is used to attach to the RAID adapter, media bay connection to the standard controller for SCSI devices in the x200 and x220, requires the two-drop terminated LVD cable provided in the Media Bay Tray and LVD Cable Kit P/N 10K2340. Attachment of tape or optical drives to RAID adapters is not supported.
- An optional SCSI RAID adapter can be connected to the hot-swap backplane using the existing cable that normally connects to the standard controller. In this situation, attachment of a tape drive in a media bay to the available standard controller, requires another supported cable, such as the two-drop terminated LVD cable provided in the Media Bay Tray and LVD Cable Kit P/N 10K2340. Some systems already include an additional cable, but this may be either non-terminated or non-LVD (or both) and therefore unsuitable for supporting the latest technology tape drives. If a fixed HDD is installed in bay 4, it is not supported for connection to the same SCSI bus as the hot-swap backplane. Refer to the media bay cable column, or to the appropriate Product/Tape Options section of the COG for more information.
- Attachment of SCSI devices in either of the two available media bays requires optional SCSI storage controller P/N 19K4646 in a non-RAID system. This adapter comes with a supported cable. Two half-high or one full-high device may be installed. A two-drop SCSI cable is included with the x250 as standard, which can be used to attach one or two internal tape options to the integrated controller when a RAID adapter is used to support the hot-swap backplane. Refer to Tape Options in the x250 COG section for more information.
- Channel B of the integrated controller, can be cabled to the external connector, by using a single-drop cable included with the system. Alternatively, this channel can be used to connect to the optional hot-swap backplane included with the 3-Pack Ultra160 Hot-swap Expansion Kit P/N 33L5050 thereby enabling the three additional internal hot-swap HDD bays.
- An optional RAID adapter is required to support external HDD storage. Refer to ServerProven test results for supported RAID options at [www.pc.ibm.com/us/compat](http://www.pc.ibm.com/us/compat). Select x380 from the Fast Access pulldown menu and click Go. Select SCSI and RAID Controllers. IBM makes no representations or warranties with respect to non-IBM products. These products are offered and warranted by third parties, not IBM.
- The standard slim-line CD-ROM docks directly into a media interposer card that is routed through the lightpath card before terminating at the planar.
- The hot-swap backplane is connected to the integrated controller through a SCSI bus integrated into the system planar.
- Internal RAID configurations are supported by connecting an internal connector on the RAID controller to a connector on the planar located between slot one and the memory card using a dedicated RAID cable provided with the system. (Route cable underneath PCI adapters).

For additional information, refer to the Internal SCSI Cabling and Tape Options sections for each system or to Appendix D: SCSI Cables - Storage Units - Controllers.



# Appendix F: IBM Serial I/O

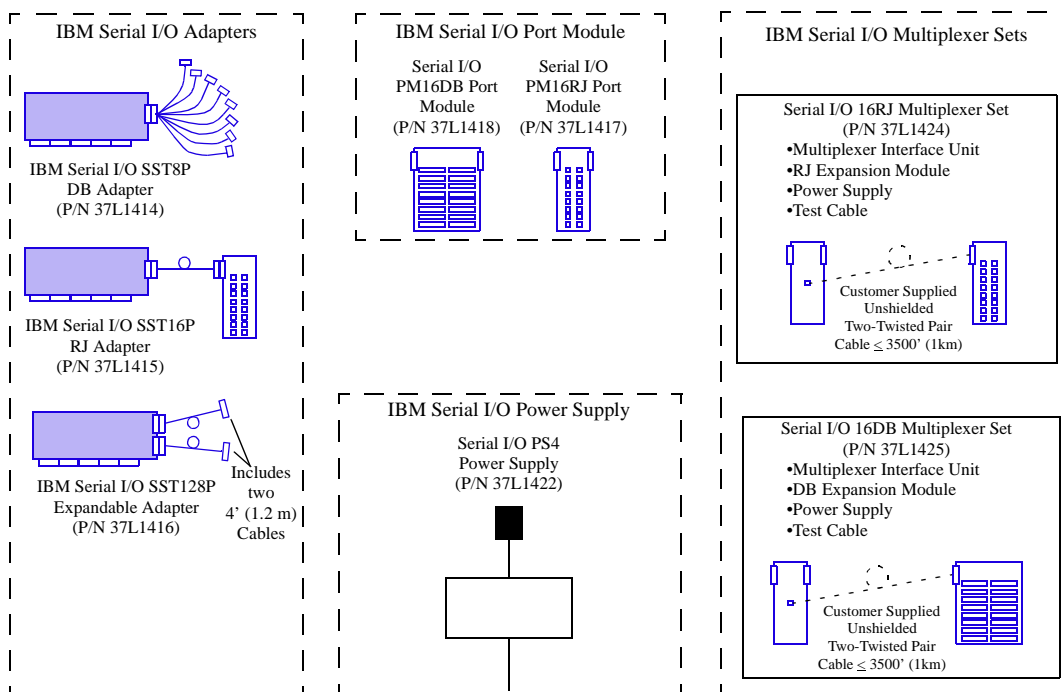

## Sample Configurations

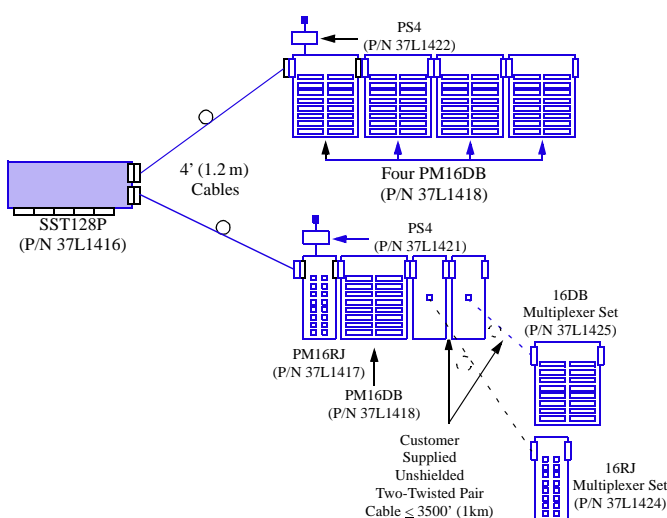

Part Number	Withdrawal Date	Description
37L1414	-	Serial I/O SST8P DB Adapter <sup>1,5</sup>
37L1415	-	Serial I/O SST16P RJ Adapter <sup>2,5</sup>
37L1416	18/12/01	Serial I/O SST128P Expandable Adapter <sup>3,5</sup>
37L1417	13/11/01	Serial I/O PM16RJ Port Module <sup>4</sup>
37L1418	13/11/01	Serial I/O PM16DB Port Module <sup>4</sup>
37L1424	26/09/00	Serial I/O 16RJ Multiplexer Set <sup>4,6</sup>
37L1425	26/09/00	Serial I/O 16DB Multiplexer Set <sup>4,6</sup>
37L1422	18/12/01	Serial I/O PS4 Power Supply <sup>4</sup>

- Intelligent serial I/O interface card providing eight DB-25 RS232 serial connections using an octopus cable. Support for all ports at 921.6 Kbps simultaneously.
- Intelligent serial I/O interface card providing sixteen RJ-45 RS232 serial connections in a breakout box. Support for all ports at 115.2 Kbps simultaneously.
- Intelligent interface card providing up to 128 RS232 serial connections (DB25 or RJ45) configured in 16 port increments utilizing any combination of Port Modules and Multiplexer Sets. Includes two 4' (1.2 m) bus cables. Each 4' cable supports attachment of 1 to 4 Port Modules and/or Multiplexer Interface Units for a total of 8 per adapter. The first Port Module or Multiplexer Set attached to a cable requires a Serial I/O PS4 Power Supply (P/N 37L1421). Support for all ports at 115.2 Kbps simultaneously.
- Port Modules and Multiplexer Sets attach directly to one of the two standard 4' (1.2m) bus cables of the Serial I/O SST128P Expandable Adapter (P/N 37L1416) or directly to 1 or more Port Modules or Multiplexer Sets already attached to one of the cables. A maximum of 4 Port Modules or Multiplexer Sets may be attached to single cable. The first Port Module or Multiplexer Set attached to a cable requires a Serial I/O PS4 Power Supply (P/N 37L1421).
- Serial I/O Adapters are 32-bit PCI half length cards. A maximum of four Serial I/O adapters (in any combination) may be installed in a single host system.
- Requires a customer supplied Unshielded Two-Twisted Pair (Category 3 minimum) cable with a maximum length of 3,500 feet (1 Km).



## Appendix G: Useful URLs

---

URL	PURPOSE
<a href="http://www.ibm.com/pc/us/compat">www.ibm.com/pc/us/compat</a>	ServerProven compatibility charts
<a href="http://www.ibm.com/pc/europe/configurators">www.ibm.com/pc/europe/configurators</a>	European configurator download site
<a href="http://www.developer.ibm.com/welcome/myvc.pl">www.developer.ibm.com/welcome/myvc.pl</a>	A ServerProven Portal for xSeries that includes a Solution Sizing Tools download site >select 'Solution sizing tools' from lefthand navigation pane as desired<
<a href="http://www.ibm.com/pc">www.ibm.com/pc</a>	PC Products - Country Selector page
<a href="http://www.ibm.com/pc/ww/eserver/xseries/benchmarks">www.ibm.com/pc/ww/eserver/xseries/benchmarks</a>	Benchmark data
<a href="http://www.ibm.com/pc/ww/eserver/xseries/clustering/index.html">www.ibm.com/pc/ww/eserver/xseries/clustering/index.html</a>	Clustering Information
<a href="http://www.ibm.com/pc/ww/eserver/xseries">www.ibm.com/pc/ww/eserver/xseries</a>	Device Driver and BIOS updates >select 'Support & downloads' (at top), 'xSeries, Netfinity' from Server Downloads (in centre), 'Device drivers, bios etc' from Get Fixes menu.<
<a href="http://www.adobe.com/products/acrobat/readstep.html">www.adobe.com/products/acrobat/readstep.html</a>	Adobe® Acrobat® Reader download site

# Server Product Positioning

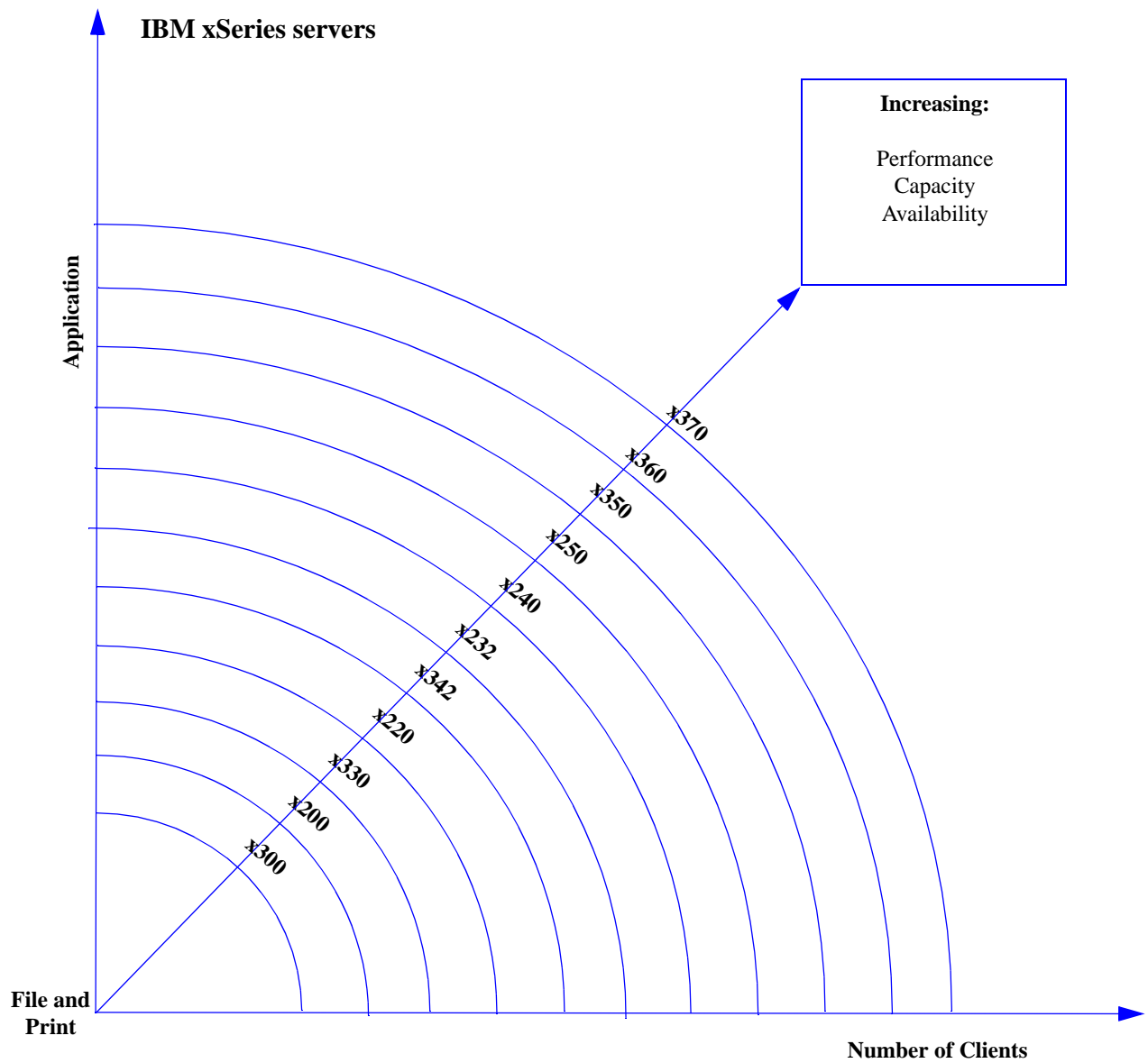



When in a competitive situation, this table suggests the appropriate IBM xSeries server to bid against other vendors' equipment. However, as an IBM business partner, you may determine that customer-specific requirements may make an alternative IBM solution a better choice.

	Value	Price Performance	Mission Critical	Rack Optimised
8-way			<b>IBM: xSeries 370</b> Compaq: ProLiant 8000, ML750 Dell: No Offering HP: NetServer LH 6000, LT6000R	<b>IBM: xSeries 370</b> Compaq: ProLiant 8500 Dell: PowerEdge 8450 HP: NetServer LXR 8000
4-way		<b>IBM: xSeries 250</b> Compaq: ProLiant ML570 Dell: PowerEdge 6400 HP: NetServer LH4	<b>IBM: xSeries 250</b> Compaq: No Offering Dell: No Offering HP: NetServer LXR 8000	<b>IBM: xSeries 350, xSeries 360</b> Compaq: ProLiant DL580 Dell: PowerEdge 6450 HP: NetServer LH4r
2-way	<b>IBM: xSeries 220</b> Compaq: ProLiant ML350 Dell: PowerEdge 1300 HP: NetServer E60	<b>IBM: xSeries 232</b> Compaq: ProLiant ML370 Dell: PowerEdge 2400 HP: NetServer LC2000	<b>IBM: xSeries 240</b> Compaq: ProLiant ML530 Dell: PowerEdge 4400 HP: NetServer LH 3000	<b>IBM: xSeries 330, xSeries 342</b> Compaq: ProLiant DL380, DL360 Dell: PowerEdge 2450 HP: NetServer LPr
Uni	<b>IBM: xSeries 200</b> Compaq: ProLiant ML330 Dell: No Offering HP: No Offering			<b>IBM: xSeries 300</b> Compaq: ProLiant DL320 Dell: PowerEdge 350 HP: NetServer LPr



## IBM xSeries Selection Guide

This chart represents general guidelines for selecting the appropriate server based on the number of users that can be supported in a particular application environment. This chart is for general guidance only, since each customer environment is unique and is unlikely to be precisely represented by any of the specific applications in the chart. However by using the chart, it is expected that a reasonable approximation can be reached. External Storage Units are utilised when internal capacities are exceeded. Basic guidelines on the use of the chart are given at the bottom of the next page. These are not published benchmark results. Access: <http://www.ibm.com/pc/us/techlink/srvperf.html> to obtain benchmark data.

Application/Expectation of Maximum # of Users	xSeries 200 Uni- Pentium® III 1.26GHz/ 256KB	xSeries 220 Dual Pentium III 1.26GHz/ 256KB	xSeries 300 Uni- Pentium III 1GHz/ 256KB	xSeries 330 Dual Pentium III 1.26GHz/ 256KB	xSeries 342 Dual Pentium III 1.26GHz/ 512KB
<b>DB Transaction Processing</b> Select, Update and Delete; Does not include image or Decision Support	<b># of Users</b>	<b>1500</b>	<b>1970</b>	<b>1500</b>	<b>2110</b>
	# of processors	1	2	1	2
	Memory	1.5GB	2GB	1.5GB	2GB
	# Hard Disk Drives	12 to 18	40 to 50	12 to 20	36 to 48
	# RAID Adapters	≥1	≥2	1	≥2
	# Network Connections	1	1	1	1
<b>File and Print</b> Application is stored locally. (For server stored applications - cut number of users in half).	<b># of Users</b>	<b>800</b>	<b>1000</b>	<b>800</b>	<b>2300</b>
	# of Processors	1	2	1	2
	Memory	1.5GB	2GB	1.5GB	2GB
	# Hard Disk Drives	5 to 10	4 to 8	5 to 10	20 to 30
	# RAID Adapters	≥1	1	1	1 to 2
	# 100Mbps Ethernet Connections	≥2	2	2	4
<b>Lotus® Notes®</b> 10% Power Users 40% Mail 50% Mail & DB	<b># of Users</b>	<b>900</b>	<b>1180</b>	<b>900</b>	<b>3100</b>
	# of Processors	1	2	1	2
	Memory	1.5GB	2GB	1.5GB	2GB
	# Hard Disk Drives	5 to 10	10 to 15	5 to 10	20 to 30
	# RAID Adapters	≥1	1	1	1 to 2
	# Network Connections	≥1	≥2	≥2	≥2
<b>Microsoft® Exchange Server 2000</b> 100% Med Users 30MB Mailbox	<b># of Users</b>	<b>1600</b>	<b>3750</b>	<b>1600</b>	<b>5250</b>
	# of Processors	1	2	1	2
	Memory	1GB	1GB	1GB	2GB
	# Hard Disk Drives	9	10	10 to 14	10
	# RAID Adapters	1	≥1	1	1
	# Network Connections	≥1	≥1	≥2	≥2
<b>SAP 3-Tier Distributed Ver 4.0b Processing</b> Sales and Distribution Application (Minimum of 16-20 Servers) See Note 2.	<b># of Users</b>	-	-	-	-
	# of Processors	-	-	-	-
	Memory (MB)	-	-	-	-
	# Hard Disk Drives	-	-	-	-
	# RAID Adapters	-	-	-	-
	# Network Connections	-	-	-	-
<b>SAP Central Ver 4.0b Processing</b> Sales and Distribution Application (One Server) See Note 2.	<b># of Users</b>	<b>75</b>	<b>80</b>	<b>75</b>	<b>160</b>
	# Processors	1	1	1	2
	Memory	1GB	1GB	1GB	1GB
	# Hard Disk Drives	12	12	12	12 to 24
	# RAID Adapters	≥1	≥1	≥1	≥1
	# Network Connections	1	1	1	1
<b>High Availability Features</b>	Hot-Swap HDD Bays	-	-	-	X
	Hot-Plug PCI Slots	-	-	-	-
	Hot-Swap Power	-	-	-	-
	Hot-Swap Fans	-	-	-	X
	RAID	Opt.	Opt.	Opt.	Opt.
	Clustering Support	-	-	-	X
	Sys. Mgt. Processor	-	Opt.	-	X
<b>Other Distinguishing Features</b>	Max # Processors	1	2	1	2
	Max Memory	1.5GB	4GB	1.5GB	4GB
	Max Int. Storage	293.6GB <sup>3</sup>	293.6GB	72.8GB	146.8GB
	Max Int. Storage with Internal Tape drive	293.6GB	293.6GB	-	-
	Available PCI Slots	5	5	1	2
	19" Rack Models	-	-	X	X
	NetBAY3x Support	-	-	-	-



## IBM xSeries Selection Guide

Application/Expectation of Maximum # of Users		xSeries 232 Dual Pentium III	xSeries 240 Dual Pentium III	xSeries 250 Quad Pentium III Xeon™	xSeries 350 Quad Pentium III Xeon	xSeries 360 Quad Pentium III Xeon	xSeries 370 Eight-Way Pentium III Xeon
		1.26GHz/ 512KB	1GHz/ 256KB	900MHz/ 2048KB	900MHz/ 2048KB	1.6GHz/ 1024KB	900MHz/ 2048KB
<b>DB Transaction Processing</b> Select, Update and Delete; Does not include image or Decision Support	# of Users	<b>3570</b>	<b>2530</b>	<b>7030</b>	<b>7030</b>	<b>9225</b>	<b>11300</b>
	# of processors	2	2	4	4	4	8
	Memory	4GB	4GB	4GB	4GB	8GB	4GB
	# Hard Disk Drives	50 to 70	30 to 50	80 to 140	80 to 140	100 to 175	180 to 250
	# RAID Adapters	≥2	≥4	≥4	≥4	≥4	≥5 or Fibre
	# Network Connections	1 to 2	1 to 2	2 to 3	2 to 3	2 to 3	2 to 3
<b>File and Print</b> Application is stored locally (For server stored applications - cut number of users in half).	# of Users	<b>2300</b>	<b>2100</b>	<b>5000</b>	<b>5000</b>	<b>5500</b>	<b>6000</b>
	# of Processors	2	2	2	2	2	3 to 4
	Memory	2GB	2GB	2 to 4GB	2 to 4GB	3 to 4GB	4GB
	# Hard Disk Drives	20 to 30	20 to 30	50 to 90	50 to 90	60 to 100	75 to 150
	# RAID Adapters	1 to 2	1 to 2	≥4	≥4	≥3	≥4 or Fibre
	# 100Mbps Ethernet Conn.	4 or 1Gb.	4	4 or 1Gb	4 or 1Gb	4 or 1Gb	4 or 1Gb
<b>Lotus Notes</b> 10% Power Users 40% Mail 50% Mail & DB	# of Users	<b>3100</b>	<b>2200</b>	<b>4615</b>	<b>4615</b>	<b>5075</b>	<b>7335</b>
	# of Processors	2	2	4	4	4	8
	Memory	3GB	2 to 3GB	3GB	3GB	3GB	4GB
	# Hard Disk Drives	20 to 30	20 to 30	20 to 30	20 to 30	25 to 30	30 to 40
	# RAID Adapters	1 to 2	1 to 2	2 to 3	2 to 3	2 to 3	≥3
	# Network Connections	≥3	≥2	≥3	≥3	≥3 or 1Gb	≥4
<b>Microsoft Exchange Server 2000</b> 100% Med Users 30MB Mailbox	# of Users	<b>5250</b>	<b>4250</b>	<b>7250</b>	<b>8000</b>	<b>9500</b>	<b>10000</b>
	# of Processors	2	2	4	4	4	8
	Memory	4GB	2GB	≥3GB	3GB	4GB	4GB
	# Hard Disk Drives	9	12	30 to 40	30	50 to 70	50 to 70
	# RAID Adapters	1	2	≥2	2	≥3	≥3
	# Network Connections	≥1	≥1	≥2	≥2	≥2	≥2
<b>SAP 3-Tier Distributed Ver 4.0b Processing</b> Sales and Distribution Application (Minimum of 16-20 Servers) See Note 2.	# of Users	-	<b>2800</b>	<b>4000</b>	<b>4000</b>	<b>4600</b>	<b>6400</b>
	# of Processors	-	2	4	4	4	8
	Memory	-	1 to 2GB	≥4GB	≥4GB	8GB	≥4GB
	# Hard Disk Drives	-	24 to 36	48 to 60	48 to 60	48 to 60	48 to 60
	# RAID Adapters	-	≥2	≥3	≥3	≥3	≥3
	# Network Connections	-	1	1	1	1	1
<b>SAP Central Ver 4.0b Processing</b> Sales and Distribution Application (One Server) See Note 2.	# Users	-	<b>180</b>	<b>300</b>	<b>300</b>	<b>345</b>	<b>480</b>
	# Processors	-	2	4	4	4	8
	Memory	-	1 to 2GB	≥2GB	≥2GB	8GB	≥4GB
	# Hard Disk Drives	-	12 to 24	24 to 36	24 to 36	24 to 36	24 to 36
	# RAID Adapters	-	≥1	≥2	≥2	≥2	≥2
	# Network Connections	-	1	1	1	1	1
<b>High Availability Features</b>	Hot-Swap HDD Bays	X	X	X	X	X	X
	Hot-Plug PCI Slots	-	X	X	X	X	X
	Hot-Swap Power	X	X	X	X	X	X
	Hot-Swap Fans	-	X	X	X	X	X
	RAID	Opt.	Opt.	Opt.	Opt.	Opt.	Opt.
	Clustering Support	X	X	X	X	X	X
	Sys. Mgt. Processor	X	X	X	X	X	X
<b>Other Distinguishing Features</b>	Max # Processors	2	2	4	4	4	8
	Max Memory	4GB	4GB	16GB	16GB	8GB	32GB
	Max Int. Storage	660.6 <sup>3</sup> GB	440.4GB	734GB	440.4GB <sup>3</sup>	220.2GB	146.8GB
	Max Int. Storage with Internal Tape drive	440.4GB	440.4GB	734GB	-	-	-
	Available PCI Slots	5	5	6	6	6	12
	19" Rack Models	X	X	X	X	X	X
NetBAY3x Support	-	-	X	-	-	X <sup>4</sup>	

1. The processor speed quoted here only represents the microprocessor internal clock speed, not application performance. Many factors affect application performance.

2. This information for SAP is a guide only. Refer to your IBM representative, for more information.

3. When referring to hard disk drive capacity, GB equals one billion bytes. Total user accessible capacity may vary depending on operating environments.

4. With a Rack-to-Tower conversion kit installed.

5. Assumes installation of Kit P/N 33L5050 which enables maximum possible number of internal HDD bays.

### Procedure for Server Selection Guidance Chart

File and Print numbers are Novell Netware-based with all others based on Microsoft Windows NT®. Other Networking Operating System (NOS) results could vary.

Extensive SAP sizings are available from IBM/SAP Competency Centres. Contact your IBM Marketing Representative for additional information.

**Step 1:** Determine which application row most closely represents the customer's environment.

**Step 2:** Move from left to right along the row (chosen in Step 1) noting which columns contain numbers that are equal to or greater than the customer's maximum planned number of users.

**Step 3:** Move up the columns (chosen in Step 2) to the top row to determine which IBM xSeries or Netfinity Servers should be considered as possible solutions.

**Step 4:** Evaluate other features such as storage, memory capacity, high availability components, number of available expansion slots, etc., which are unique to each server, in order to determine which is the most appropriate to recommend.

For your reference, configuration information corresponding to the number of users is also provided.



# Configurator Description

---

There are several sources of configuration assistance available which complement one another by providing aid at different levels and with different deliverables. Any combination of the configurators should be used depending on the situation. Always verify your hardware configurations with Network Operating System compatibility by accessing the ServerProven compatibility pages on the World Wide Web at URL <http://www.pc.ibm.com/us/compat>

**IBM xSeries and IntelliStation Sales Configuration Aid:-** a quick, easy to use tool that contains local part numbers supporting 26 countries or groups in Europe, Middle East and Africa. This sales aid enables the user to achieve most xSeries system and rack configurations with on-screen guidance provided. It is available in either Microsoft Excel or Lotus 1-2-3 formats and includes Euro pricing (for the Eurozone countries) and local currency for the others.

**New Version:** from the middle of January 2002 a new 'Wizard-type' interface with enhanced function is available on the Excel version, in addition to the normal Classic spreadsheet mode of operation.

**Updated versions:** distributed every two weeks, inline with new product announcements, via the Web and Lotus Notes (details below).

**Configuration and Options Guide (this document!):-** produced in Adobe Acrobat (.PDF) format, this configurator can be printed and used as hard copy, or on-screen using Acrobat Reader and it's simple but effective navigation functions. This 'reference-document' type tool contains the complete range of currently marketed xSeries products. This is a powerful, complete, yet easy to use tool, produced in one version for Europe, Middle East and Africa, with generic part numbers. The COG is normally updated monthly, inline with new product announcements, (it does not contain pricing) and is distributed via the Web and Lotus Notes (details below).

**Rack Configurator:-** a graphical Windows application that can be used to configure rack-mounted solutions for the xSeries products. It assists the user to decide optimum placement of items within a rack cabinet, taking into account space, power and weight factors. It provides cabling recommendations and supplies detailed specification sheets, parts lists and floor plans. The Rack Configurator is updated inline with new rack product announcements (it does not contain pricing). It is produced in one version for Europe, Middle East and Africa with generic part numbers and is distributed via the Web and Lotus Notes (details below).

The information contained in this document has not been submitted to any formal IBM test. The following paragraph does not apply to the United Kingdom or any country where any such provisions are inconsistent with local law.

INTERNATIONAL BUSINESS MACHINES CORPORATION PROVIDES THIS PUBLICATION "AS IS" WITHOUT WARRANTY OF ANY KIND, EITHER EXPRESSED OR IMPLIED, INCLUDING, BUT NOT LIMITED TO, THE IMPLIED WARRANTIES OF MERCHANTABILITY OR FITNESS FOR A PARTICULAR PURPOSE. SOME STATES DO NOT ALLOW DISCLAIMER OF EXPRESS OR IMPLIED WARRANTIES IN CERTAIN TRANSACTIONS. THEREFORE, THIS STATEMENT MAY NOT APPLY TO YOU. THERE IS NO GUARANTEE THAT IBM WILL MARKET ANY PARTICULAR PRODUCT IN YOUR COUNTRY.

The use of this information or the implementation of any of these techniques is a customer responsibility and depends on the customer's ability to evaluate and integrate them into the customer's operational environment. While each item may have been reviewed by IBM for accuracy in a specific situation, there is no guarantee that the same or similar results will be obtained elsewhere. Customers attempting to adapt these techniques to their own environments do so at their own risk. The sample configurations contained within this document are for illustration only and may not be suitable for any specific customer installation. Contact your IBM Business Partner or IBM Marketing Representative for assistance with your specific configuration requirements.

## Configurator Distribution

**All Users:** Internet: <http://www.ibm.com/pc/europe/configurators> - Latest versions of the Configuration Aid, Configuration and Options Guide, Rack Configurator.

**Business Partners:** Lotus Notes PC PartnerInfo:

Marketing Essentials Database - Configuration Aid, Configuration and Options Guide, Rack Configurator.

Business Essentials Database - Configuration Aid, Configuration and Options Guide, Rack Configurator.

**IBM Internal:** IBM EMEA xSeries Intranet site: <http://w3.ibm.com/psg/emea/xseries> - Configuration Aid, Configuration and Options Guide, Rack Configurator.

**For further information contact:-**

**e-mail:** [psg\\_configure@uk.ibm.com](mailto:psg_configure@uk.ibm.com)

**Notes Mail:** [EMEA\\_PSG-Configuration-Support/UK/IBM@IBMGB](mailto:EMEA_PSG-Configuration-Support/UK/IBM@IBMGB)





## Important Notes

---

IBM reserves the right to change product specifications and to discontinue marketing products without notice.

Processor speeds stated only represent microprocessor internal clock speed, not application performance. Many factors affect application performance.

When referring to storage capacity, 1GB stands for 1,000,000,000 bytes. Total user-accessible capacity may be less.

Tape Drives which utilise data compression technology have storage capacity that will vary depending upon whether the drive is operating in native mode (without compression) or compressed mode. Actual storage capacity will vary based upon many factors and may be less than the maximum possible.

Maximum internal hard disk drive capacities assume the replacement of any hard disk drives and the population of all hard disk drive bays with the largest currently supported drives available from IBM.

The information contained in this document has not been submitted to any formal IBM test and is distributed AS IS. The use of this information or the implementation of any of these techniques is a customer responsibility and depends on the customer's ability to evaluate and integrate them into the customer's operational environment. While each item may have been reviewed by IBM for accuracy in a specific situation, there is no guarantee that the same or similar results will be obtained elsewhere. Customers attempting to adapt these techniques to their own environments do so at their own risk.

For more information on IBM's statement of Limited Warranty, please contact your IBM representative or reseller. Copies are available upon request.

IBM makes no representations or warranties with respect to non-IBM products. Support (if any) for the non-IBM products is provided by the third party, not IBM.

IBM makes no warranties, express or implied, regarding non-IBM products and services that are ServerProven, including but not limited to the implied warranties of merchantability and fitness for particular purpose. These products are offered and warranted solely by third parties.

Applications included in IBM products may vary from retail versions and may not include all documentation or functions. Not all products are sold separately. Third-party software licenses may apply.

This publication originates in the United States. IBM may not offer the products, services or features discussed in this document in all countries, and the information is subject to change without notice. Consult your local IBM representative for more information on the products, services and features available in your area.

All the part numbers referenced in this publication are product part numbers and not service part numbers.

This publication could contain technical inaccuracies or typographical errors. Changes are periodically made to the information herein; these changes will be incorporated in new editions of this publication. IBM may make improvements and/or changes in the product(s) and/or program(s) described in this publication at any time. IBM reserves the right to alter specifications and other product information without notice. It is your responsibility to obtain the latest information.

Other part numbers in addition to those listed in this document may be required to support a specific device or function.

Data on competitive products is obtained from publicly obtained information and is subject to change without notice. Please contact the manufacturer for the most recent information.

The following items are trademarks or registered trademarks of IBM Corporation in the United States or other countries or both: IBM, the IBM logo, Active PCI, Alert on LAN, Chipkill memory, the e-business logo, ESCON, Intellistation, LANStreamer, Light Path Diagnostics, NetBAY3, NetBAY3E, NetBAY22, Netfinity, OS/2, Predictive Failure Analysis, ServeRAID, ServerGuide, ServerProven, SurePath, TechConnect, Wake on LAN, xSeries, X-Architecture.

TME 10 Netfinity is a trademark of Tivoli Systems, an IBM Company. Lotus, Lotus Notes and Lotus SmartSuite are trademarks of Lotus Development Corporation.

Intel, Pentium, Celeron, Itanium, MMX and Pentium III Xeon are trademarks or registered trademarks of Intel Corporation. Microsoft, Windows and Windows NT are trademarks or registered trademarks of the Microsoft Corporation. UNIX is a registered trademark in the USA and other countries or registered trademarks licensed exclusively through X/Open Company Limited. Trinitron is a trademark of the Sony Corporation. Java and all Java-based trademarks and logos are trademarks or registered trademarks of Sun Microsystems, Inc. in the USA and/or other countries.

All other registered trademarks and trademarks are properties of their respective owners.