



IBM USB 2.0 Portable Multi-Burner

使用手冊



IBM USB 2.0 Portable Multi-Burner

使用手冊

請注意

在使用本資訊和其支援的產品之前，請先閱讀附錄 B, 『Service and Support』、附錄 C, 『IBM Statement of Limited Warranty - Z125-4753-07 - 11/2002』和附錄 D, 『Notices』。

目錄

Safety	v
-------------------------	----------

General safety guidelines	vii
Service	vii
Power cords and power adapters	vii
Extension cords and related devices	viii
Plugs and outlets	viii
Batteries	viii
Heat and product ventilation	ix
CD and DVD drive safety	ix

關於本書	xi
註冊您的選用設備	xi

第 1 章 Multi-Burner 快速安裝	1-1
產品說明	1-1
軟體需求	1-2
電源模式配置	1-2
配置 1：自動電源（AC 整流器）配置	1-3
配置 2：標準 USB 匯流排電源配置	1-4
配置 3：輔助 USB 電源配置	1-6

第 2 章 將 Multi-Burner 的接線連接至 ThinkPad 電腦	2-1
--	------------

第 3 章 特性	3-1
---------------------------	------------

第 4 章 準備使用 Multi-Burner	4-1
--	------------

第 5 章 在 Windows 2000 和 Windows XP 中安裝及移除 Multi-Burner	5-1
移除 Multi-Burner 硬體	5-1
Windows 2000	5-1
Windows XP	5-2
設定媒體	5-2
退出媒體	5-2
播放音效光碟	5-2
Windows 2000	5-3
Windows XP	5-5

第 6 章 應用軟體	6-1
-----------------------------	------------

第 7 章 使用 Multi-Burner	7-1
準備工作	7-1
處置及維護光碟	7-1
維護 Multi-Burner 光碟機	7-2
清潔光碟機	7-2
使用光碟機	7-2
使用單面和雙面 DVD-RAM 媒體	7-2
處置的預防措施	7-3
搭配使用光碟機與 CD 和 DVD	7-3
使用 DVD 播放程式軟體	7-3
使用 DVD 功能	7-3
啓用 driver letter access (DLA)	7-3
使用 Intervideo WinDVD Creator Plus	7-4
安裝 WinDVD 及觀看 DVD 影片	7-4
啓動 WinDVD	7-5
使用 CD-R 和 CD-RW 功能	7-6
使用 DVD-R 和 DVD-RW 功能	7-6
使用 DVD+R 和 DVD+RW 功能（讀取）	7-6
備份 CD 或 DVD	7-7
問題解決	7-7

附錄 A. Product specifications.	A-1
--	------------

附錄 B. Service and Support	B-1
Online technical support	B-1
Telephone technical support	B-1

附錄 C. IBM Statement of Limited Warranty - Z125-4753-07 - 11/2002	C-1
Part 2 - Country-unique Terms	C-4
Part 3 - Warranty Information	C-16

附錄 D. Notices	D-1
Trademarks	D-2
Electronic emission notices	D-2
Federal Communications Commission (FCC) statement	D-2

Safety

Before installing this product, read the Safety Information.

مج، يجب قراءة دات السلامة

Antes de instalar este produto, leia as Informações de Segurança.

在安装本产品之前，请仔细阅读 **Safety Information** (安全信息)。

Prije instalacije ovog produkta obavezno pročitajte Sigurnosne Upute.

Před instalací tohoto produktu si přečtěte příručku bezpečnostních instrukcí.

Læs sikkerhedsforskrifterne, før du installerer dette produkt.

Ennen kuin asennat tämän tuotteen, lue turvaohjeet kohdasta Safety Information.

Avant d'installer ce produit, lisez les consignes de sécurité.

Vor der Installation dieses Produkts die Sicherheitshinweise lesen.

Πριν εγκαταστήσετε το προϊόν αυτό, διαβάστε τις πληροφορίες ασφάλειας (safety information).

לפני שתתקינו מוצר זה, קראו את הוראות הבטיחות.

A termék telepítése előtt olvassa el a Biztonsági előírásokat!

Prima di installare questo prodotto, leggere le Informazioni sulla Sicurezza.

製品の設置の前に、安全情報をお読みください。

본 제품을 설치하기 전에 안전 정보를 읽으십시오.

Пред да се инсталира овој продукт, прочитајте информацијата за безбедност.

Lees voordat u dit product installeert eerst de veiligheidsvoorschriften.

Les sikkerhetsinformasjonen (Safety Information) før du installerer dette produktet.

Przed zainstalowaniem tego produktu, należy zapoznać się z książką "Informacje dotyczące bezpieczeństwa" (Safety Information).

Antes de instalar este produto, leia as Informações sobre Segurança.

Перед установкой продукта прочтите инструкции по технике безопасности.

Pred inštaláciou tohto zariadenia si prečítajte Bezpečnostné predpisy.

Pred namestitvijo tega proizvoda preberite Varnostne informacije.

Antes de instalar este producto lea la información de seguridad.

Läs säkerhetsinformationen innan du installerar den här produkten.

安裝本產品之前，請先閱讀「安全資訊」。

General safety guidelines

Always observe the following precautions to reduce the risk of injury and property damage.

Service

Do not attempt to service a product yourself unless instructed to do so by the IBM® HelpCenter®. Use only an IBM authorized service provider who is approved to repair your particular product.

Note: Some parts can be upgraded or replaced by the customer. These parts are referred to as Customer Replaceable Units, or CRUs. IBM expressly identifies CRUs as such, and provides documentation with instructions when it is appropriate for customers to replace those parts. You must closely follow all instructions when performing such replacements. Always make sure that the power is turned off and that the product is unplugged from any power source before you attempt the replacement. If you have any questions or concerns, contact the IBM HelpCenter.

Power cords and power adapters

Use only the power cords and power adapters supplied by the product manufacturer.

Never wrap a power cord around the power adapter or other object. Doing so can stress the cord in ways that can cause the cord to fray, crack or crimp. This can present a safety hazard.

Always route power cords so that they will not be walked on, tripped over, or pinched by objects.

Protect the cord and power adapters from liquids. For instance, do not leave your cord or power adapter near sinks, tubs, toilets, or on floors that are cleaned with liquid cleansers. Liquids can cause a short circuit, particularly if the cord or power adapter has been stressed by misuse. Liquids can also cause gradual corrosion of the power cord terminals and/or the connector terminals on the adapter which can eventually result in overheating.

Always connect power cords and signal cables in the correct order and ensure that all power cord connectors are securely and completely plugged into receptacles.

Do not use any power adapter that shows corrosion at the ac input pins and/or shows signs of overheating (such as deformed plastic) at the ac input or anywhere on the power adapter.

Do not use any power cords where the electrical contacts on either end show signs of corrosion or overheating or where the power cord appears to have been damaged in any way.

Extension cords and related devices

Ensure that extension cords, surge protectors, uninterruptible power supplies, and power strips that you use are rated to handle the electrical requirements of the product. Never overload these devices. If power strips are used, the load should not exceed the power strip input rating. Consult an electrician for more information if you have questions about power loads, power requirements, and input ratings.

Plugs and outlets

If a receptacle (power outlet) that you intend to use with your computer equipment appears to be damaged or corroded, do not use the outlet until it is replaced by a qualified electrician.

Do not bend or modify the plug. If the plug is damaged, contact the manufacturer to obtain a replacement.

Some products are equipped with a three-pronged plug. This plug fits only into a grounded electrical outlet. This is a safety feature. Do not defeat this safety feature by trying to insert it into a non-grounded outlet. If you cannot insert the plug into the outlet, contact an electrician for an approved outlet adapter or to replace the outlet with one that enables this safety feature. Never overload an electrical outlet. The overall system load should not exceed 80 percent of the branch circuit rating. Consult an electrician for more information if you have questions about power loads and branch circuit ratings.

Be sure that the power outlet you are using is properly wired, easily accessible, and located close to the equipment. Do not fully extend power cords in a way that will stress the cords.

Connect and disconnect the equipment from the electrical outlet carefully

Batteries

All IBM personal computers contain a non-rechargeable coin cell battery to provide power to the system clock. In addition many mobile products such as Thinkpad notebook PCs utilize a rechargeable battery pack to provide system power when in portable mode. Batteries supplied by IBM for use with your product have been tested for compatibility and should only be replaced with IBM approved parts.

Never attempt to open or service any battery. Do not crush, puncture, or incinerate batteries or short circuit the metal contacts. Do not expose the battery to water or other liquids. Only recharge the battery pack strictly according to instructions included in the product documentation.

Battery abuse or mishandling can cause the battery to overheat, which can cause gasses or flame to “vent” from the battery pack or coin cell. If your battery is damaged, or if you notice any discharge from your battery or the buildup of foreign materials on the battery leads, stop using the battery and obtain a replacement from the battery manufacturer.

Batteries can degrade when they are left unused for long periods of time. For some rechargeable batteries (particularly Lithium Ion batteries), leaving a battery unused in a

discharged state could increase the risk of a battery short circuit, which could shorten the life of the battery and can also pose a safety hazard. Do not let rechargeable Lithium-Ion batteries completely discharge or store these batteries in a discharged state.

Heat and product ventilation

Computers generate heat when turned on and when batteries are charging. Notebook PCs can generate a significant amount of heat due to their compact size. Always follow these basic precautions:

- Do not leave the base of your computer in contact with your lap or any part of your body for an extended period when the computer is functioning or when the battery is charging. Your computer produces some heat during normal operation. Extended contact with the body could cause discomfort or, potentially, a skin burn.
- Do not operate your computer or charge the battery near flammable materials or in explosive environments.
- Ventilation slots, fans and/or heat sinks are provided with the product for safety, comfort, and reliable operation. These features might inadvertently become blocked by placing the product on a bed, sofa, carpet, or other flexible surface. Never block, cover or disable these features.

CD and DVD drive safety

CD and DVD drives spin discs at a high speed. If a CD or DVD is cracked or otherwise physically damaged, it is possible for the disc to break apart or even shatter when the CD drive is in use. To protect against possible injury due to this situation, and to reduce the risk of damage to your machine, do the following:

- Always store CD/DVD discs in their original packaging
- Always store CD/DVD discs out of direct sunlight and away from direct heat sources
- Remove CD/DVD discs from the computer when not in use
- Do not bend or flex CD/DVD discs, or force them into the computer or their packaging
- Check CD/DVD discs for cracks before each use. Do not use cracked or damaged discs

關於本書

本手冊含有針對 Multi-Burner 支援的三種電源模式配置安裝 IBM USB 2.0 Portable Multi-Burner 硬體的安裝說明。

本手冊提供下列語言的安裝說明：

- 巴西葡萄牙文
- 捷克文
- 英文
- 法文
- 德文
- 義大利文
- 日文
- 簡體中文
- 斯洛伐克文
- 西班牙文
- 繁體中文
- 土耳其文

註冊您的選用設備

感謝您購買本 IBM 產品。請用一點時間為產品註冊，並提供一些相關資訊，這將有助於 IBM 在未來提供您更好的服務。您的意見對我們的產品開發和服務十分寶貴，亦有助於您和我們進行更良好的溝通。您可以在下列 IBM 網站註冊您的選用設備：

<http://www.ibm.com/pc/register/>

除非您在網站的問卷指出您不想收到進一步資訊，否則 IBM 會提供您所註冊的產品資訊及更新。

第 1 章 Multi-Burner 快速安裝

本章含有 IBM USB 2.0 Portable Multi-Burner 的安裝說明。

產品說明

IBM USB 2.0 Portable Multi-Burner 是一款超薄型 DVD 和 CD 可燒錄光碟機，只要單一連接便可以快速輕鬆連到 IBM ThinkPad® 電腦，非常方便。此光碟機是 USB 2.0 裝置，必須接到 USB 2.0 埠。可達到高達 2x (DVD 媒體) 及 16x (CD 媒體) 的寫入速度。可達到高達 8x (DVD 媒體) 及 24x (CD 媒體) 的讀取速度。

除了本手冊外，本選用設備包裝還包含：

- IBM USB 2.0 Portable Multi-Burner 光碟機



- 標準 USB 接線和電源線配件 (用於第 1-3 頁上的配置 1，以及第 1-5 頁上的配置 2)；IBM 產品編號 22P9188

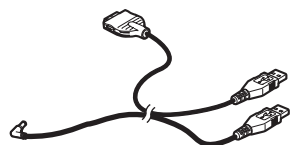

- IBM 供應的 USB 2.0 接線配件 (用於第 1-6 頁上的配置 3)；IBM 產品編號 22P9189

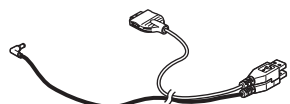

- 電源整流器

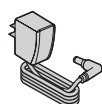

- 電源共用裝置



- *IBM USB 2.0 Portable Multi-Burner Software and Guide Super CD*

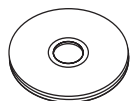

- 安全資訊手冊（兩份）



- 隨身袋

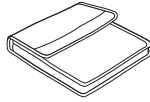

如果有物品遺失或損壞，請洽詢原購買地點。請務必保留購買證明及原包裝材料。可能需要它們才能獲取保證服務。

軟硬體需求

您的 ThinkPad 電腦必須已安裝好下列硬體，才能夠安裝本選用設備：

- 可用的 USB 2.0 埠

註：第 1-5 頁上的配置 2 必須有另一個 USB 2 埠。

您的電腦必須已安裝好下列任一種作業系統，才可以使用本選用設備：

- Microsoft® Windows® XP
- Microsoft Windows 2000 Professional (Service Pack 4 或更新版)

註：必須安裝 Service Pack 4 或更新版，光碟機才能正常操作。

電源模式配置

本節提供下列配置的安裝指示：

- 配置 1：自動電源（AC 整流器）
- 配置 2：USB 標準匯流排電源（唯讀）
- 配置 3：輔助 USB 電源

配置 1：自動電源（AC 整流器）配置

Multi-Burner 通常搭配自動電源（AC 整流器）配置使用。

需求

- 標準 USB 接線和電源線配件（隨本選用設備一起出貨）；IBM 產品編號 22P9188
- AC 整流器（隨本選用設備一起出貨）

規格

支援讀取和寫入 CD 和 DVD 媒體。

使用配置 1 連接 Multi-Burner

如果要將 Multi-Burner 接到您的系統，請完成下列程序。在安裝期間，請參閱圖 1-1。



圖 1-1. 配置 1：自動電源（AC 整流器）配置

1. 開啟電腦。
2. 壓住 USB 接線 **A** 接頭上的兩個按鈕，將接線插頭 **1** 插入光碟機的 USB 接頭。
3. 將標準 USB 接頭 **2** 插入電腦的 USB 埠。
4. 將 AC 整流器接到 Multi-Burner 上的 DC IN 接頭 **3**。

註： 這項配置不需要 USB 接線 **B**。

配置 2：標準 USB 匯流排電源配置

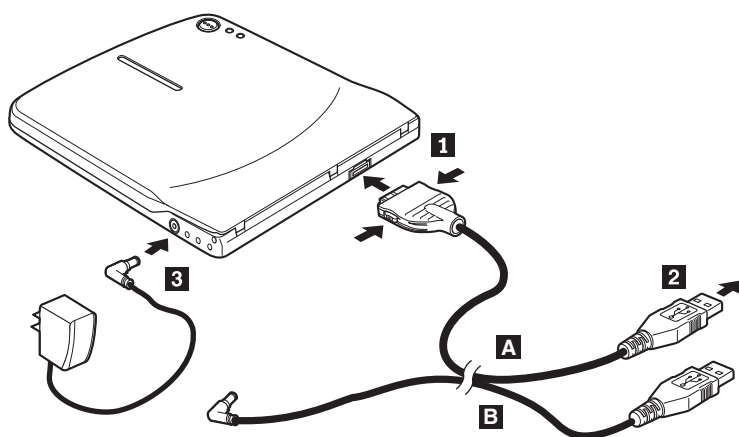
雖然 Multi-Burner 通常與自動電源搭配使用，但是在下列情況下（不在 USB 標準內），可以使用匯流排電源（唯讀），不過功能較為受限。

需求

- 標準 USB 接線和電源線配件（隨本選用設備一起出貨）；IBM 產品編號 22P9188
- 您的系統有兩個可用的 USB 埠

規格

支援唯讀 CD 和 DVD 媒體（DVD-RAM 除外）。

警告： 如果您嘗試「寫入」或「格式化」作業或是「DVD-RAM 讀取」作業，您將會看到下列一則錯誤訊息，必須接上外接式 AC 整流器才能完成這項作業。

您的電源配置不支援在 **IBM USB** 裝置上進行這項作業。您必須將外接式 **AC** 電源整流器接到 **IBM USB** 裝置，才能完成這項作業。

我的電腦
無法存取 D:\。
功能不正確。

插入磁片
將磁片插入磁碟機：x

使用配置 2 連接 Multi-Burner

如果要將 Multi-Burner 接到您的系統，請完成下列程序。在安裝期間，請參閱圖 1-2。



圖 1-2. 配置 2：USB 標準匯流排電源配置

1. 開啓電腦。
2. 壓住 USB 接線 **A** 接頭上的兩個按鈕，將接線插頭 **1** 插入光碟機的 USB 接頭。
3. 將標準 USB 接頭 **2** 插入電腦的 USB 埠。
4. 用 USB 接線 **B**，將接線插頭 **3** 插入光碟機的 DC IN 接頭。
5. 將標準 USB 接頭 **4** 插入電腦的 USB 埠。

配置 3：輔助 USB 電源配置

在選取配備 IBM 供應的 USB 2.0 埠的 IBM ThinkPad 電腦時，可以使用輔助 USB 匯流排電源配置。

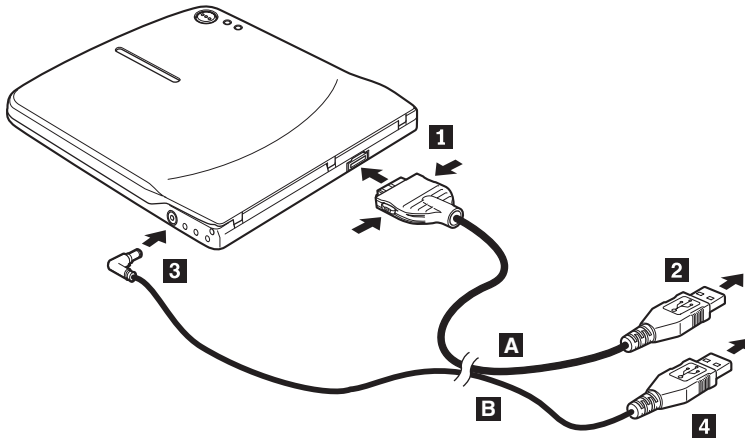
需求

- IBM 供應的 USB 2.0 接線配件（隨本選用設備一起出貨）；IBM 產品編號 22P9189
- IBM 供應的 USB 2.0 埠

規格

支援讀取和寫入 CD 和 DVD 媒體。

使用配置 3 連接 Multi-Burner

如果要將 Multi-Burner 接到您的系統，請完成下列程序。在安裝期間，請參閱圖 1-3。



圖 1-3. 配置 3：輔助 USB 電源配置

1. 開啓電腦。
2. 壓住 USB 接線 **A** 接頭上的兩個按鈕，將接線插頭 **1** 插入光碟機的 USB 接頭。
3. 將兩個接頭 **2** 靠在一起，然後將疊在一起的 USB 和輔助電源接頭插入電腦上的已接電 USB 2.0 埠（位於選取的 IBM ThinkPad 系統上）。
4. 將接線 **B** 的另一端接到光碟機，方法為將插頭 **3** 插入 Multi-Burner 上的 DC IN 接頭。

第 2 章 將 Multi-Burner 的接線連接至 ThinkPad 電腦

在將 Multi-Burner 的接線連接至 ThinkPad 電腦時，下圖可能非常有用。請注意，這些圖解可能與您的硬體稍有不同。

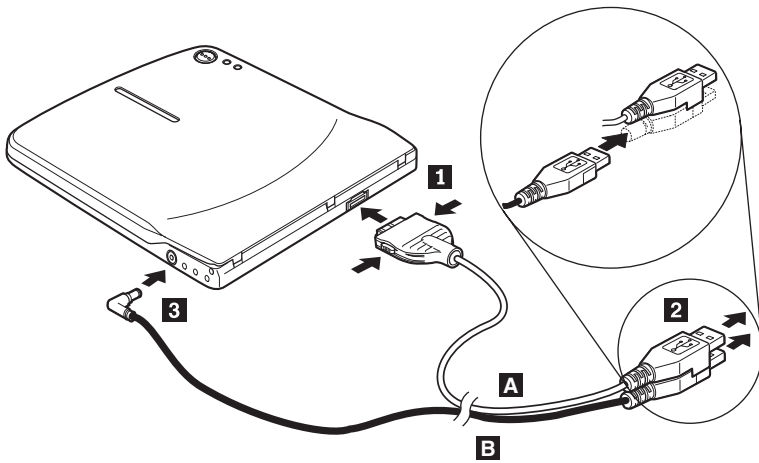
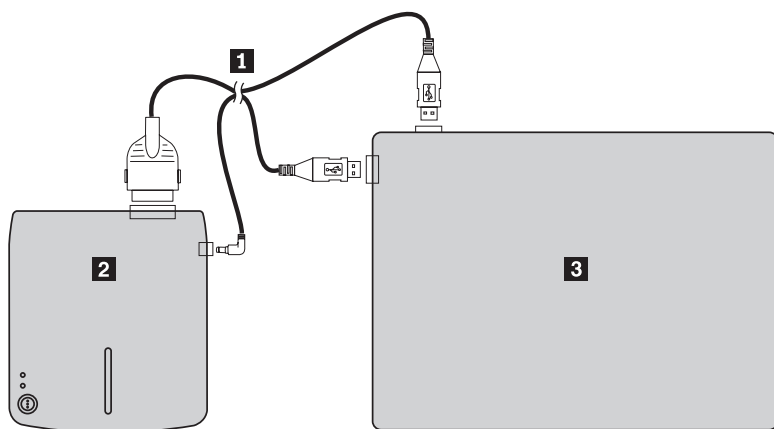

- 1** USB 接線和電源線配件
- 2** Multi-Burner
- 3** ThinkPad 電腦

圖 2-1. 標準 USB 接線配件（左邊）

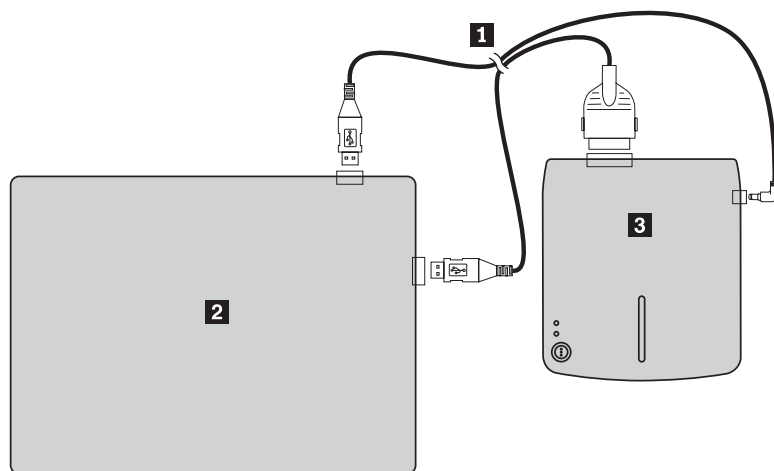

- 1** USB 接線和電源線配件
- 2** Multi-Burner
- 3** ThinkPad 電腦

圖 2-2. 標準 USB 接線配件（右邊）

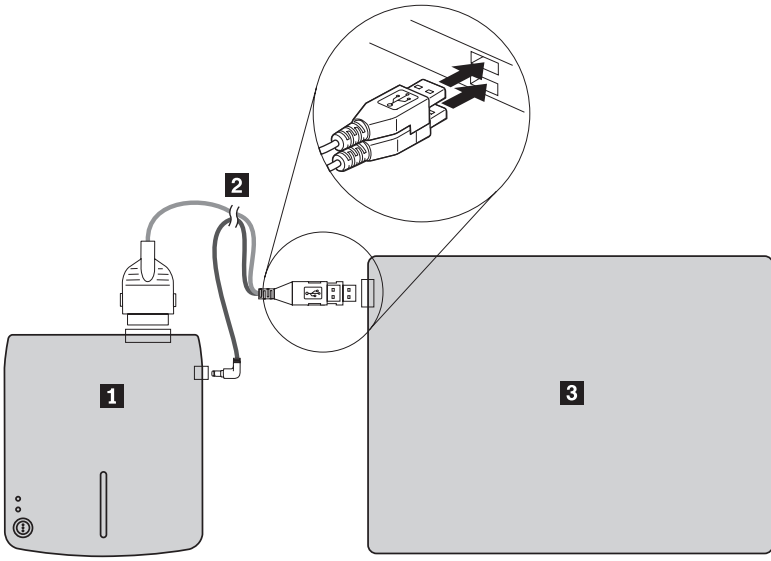

- 1** Multi-Burner
- 2** IBM 供應的 USB 2.0 接線配件
- 3** ThinkPad 電腦

圖 2-3. 選取具有輔助 USB 已接電連接埠的 IBM 系統

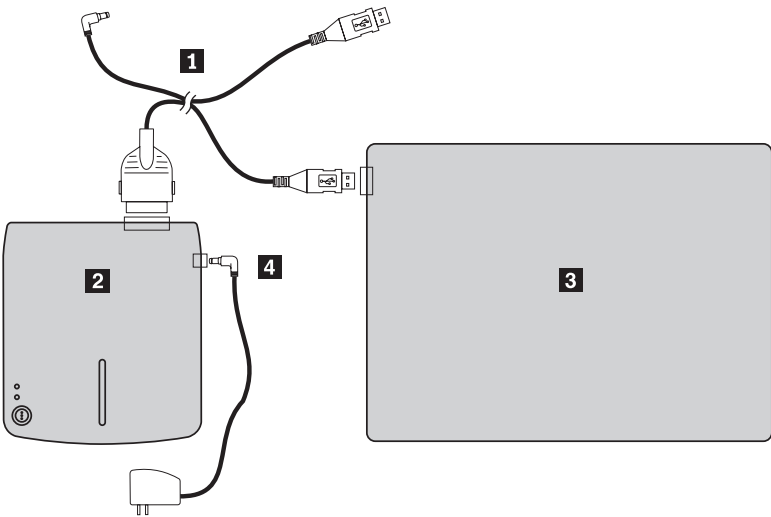

- 1** USB 接線和電源線配件
- 2** Multi-Burner
- 3** ThinkPad 電腦
- 4** 電源整流器

圖 2-4. 選取具有 AC 電源的 IBM 系統

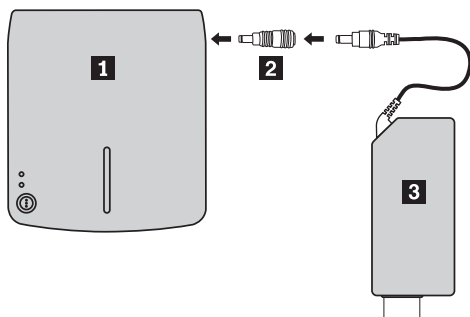

1 Multi-Burner

2 電源共用裝置

3 ThinkPad 56W AC 整流器、ThinkPad 72W AC 整流器，或 ThinkPad 72W AC/DC 複合式整流器

圖 2-5. 使用電源共用裝置

第 3 章 特性

下列清單含有 IBM USB 2.0 Portable Multi-Burner 光碟機的一些特性：

- **易於連接**

由於本產品納入符合 USB 2.0 High Speed 的介面，因此即使電腦的電源還開著，都可以將它接到電腦或從電腦拔除。支援具有 AC 電源的 IBM 擴充基座和連接埠整理器。

- **符合主要媒體製造廠商所產製的媒體**

本產品完美地契合主要媒體製造廠商所產製的大部份 CD 和 DVD 媒體，而本產品所寫入的媒體也能呈現極佳的寫入品質。因此，使用本光碟機時，無需顧慮太多相容性的問題。

註：以「寫入」作業而言，不支援 Ultra Speed CD-RW 媒體。

- **納入防護緩衝區不足功能**

本產品納入緩衝區不足預防功能，可協助防止導致寫入 CD 和 DVD 媒體失敗的緩衝區負載錯誤。

- **上掀式載入**

本產品具有上掀式載入機制，可讓您輕易放入及退出光碟。您可以手動方式或利用電腦的搭配軟體來打開上蓋。

- **符合多項標準**

本光碟機符合 DVD-RAM、DVD-RW、DVD-R、CD-RW 和 CD-R 媒體的業界標準規格。本光碟機符合 DVD+RW 和 DVD+R 規格（唯讀）。

- **電源配置**

本光碟機以下列電源配置操作：

- **完整操作**

當連接到 AC 電源（使用隨光碟機出貨的整流器）時

- **唯讀**

當連接到兩個標準 USB 埠（使用有兩個標準 USB 接頭的接線配件）時

- **完整操作**

當已接到選取 IBM 系統上的已接電 USB 2.0 埠時。使用具有選用設備內含的特殊 USB 疊置接頭的接線配件。

本選用設備隨附的 CD 上的這份使用者手冊說明如何設定 Multi-Burner、如何將它接到個人電腦，以及如何操作它。也請閱讀電腦的說明手冊。

該 CD 還包括與 Multi-Burner 搭配使用的軟體應用程式。按一下它們就會自動安裝。

在使用之前，請先仔細閱讀本說明手冊，才能適當處理及操作 Multi-Burner。

第 4 章 準備使用 Multi-Burner

在使用 Multi-Burner 之前，請遵循下列程序：

1. 確定 Multi-Burner 已適當接到 ThinkPad 電腦。
2. 檢查 Multi-Burner 上各功能的位置（請參閱下圖）。
3. 插入隨本選用設備一起出貨的 *IBM USB 2.0 Portable Multi-Burner Software and User's Guide Super CD* 來安裝 CD-R/CD-RW/DVD 寫入軟體。
4. 連按兩下您要的應用程式，然後遵循畫面上的指示。
5. 檢查光碟機是否正常運作，然後在填寫內附的保證後，將它保存在安全的地方。

請檢查退出 CD 或 DVD 時上蓋上面沒有放置任何物品。當無法正常退出時，電腦上可能會出現錯誤訊息。當無法正常執行退出時，請以手動方式打開上蓋，並移除蓋子上的任何物品，然後將它緊密關上。

以下是 Multi-Burner 上各功能的位置：

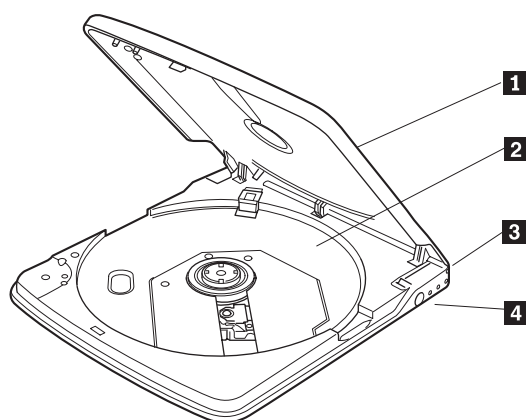

- 1 上蓋
- 2 光碟托盤
- 3 USB 接頭
- 4 DC IN 接頭

必須關上上蓋才能播放光碟。

設定媒體，使標籤在光碟托盤上面朝上。

插入 USB 接頭專用的插頭。

接上所提供的 AC 整流器或接線配件 DC IN 接頭。只有在某些限制因素下，才能以「僅使用 USB 電源」使用本光磁碟機（請參閱第 1-6 頁的『配置 3：輔助 USB 電源配置』。）

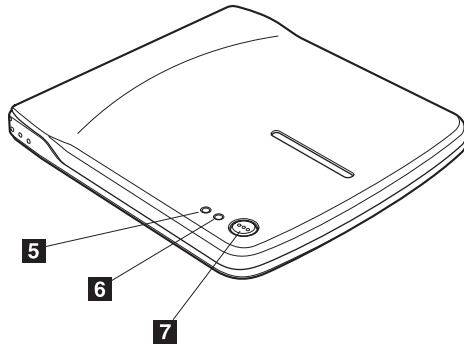

5 電源/忙碌指示燈

綠色 LED 指示光碟機的電源狀態以及作業狀態。

- **LED 亮起**：當光碟機接到任何受支援的電源配置以及電腦的 USB 埠時。

- **LED 亮起**：在資料寫入期間

- **LED 閃爍**：在資料讀取期間

- **LED 熄滅**：當光碟機未接到 USB 埠時
琥珀色 LED 表示光碟機的寫入狀態。

- **LED 閃爍**：在資料寫入期間

- **LED 熄滅**：沒有進行資料寫入時
按此按鈕可打開上蓋。

6 寫入指示燈

7 退出鈕

警告： 本光碟機使用電鎖機制，寫入期間，錯誤操作無法打上蓋。請先確定電源已經打開而且光碟機未運作，再按退出按鈕來打開上蓋。

如果按退出鈕無法打開上蓋，或者在電源不是由 AC 整流器提供時需要打開上蓋，請使用光碟機底端的緊急退出桿。

請檢查退出時上蓋上面沒有放置任何物品。當無法進行正常退出時，電腦上可能會出現錯誤訊息。當無法正常執行退出時，請以手動方式打開上蓋，並移除蓋子上的任何物品，然後將它緊密關上。

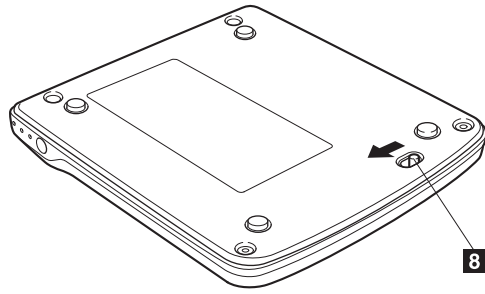

8 緊急退出桿

在電源關閉下退出媒體時，請滑動緊急退出桿來打開上蓋。

警告： 在使用緊急退出桿時，請確定電源已關閉。除了是緊急狀況才使用緊急退出桿之外，請使用退出鈕。

第 5 章 在 Windows 2000 和 Windows XP 中安裝及移除 Multi-Burner

Windows 2000 和 Windows XP 作業系統附有 Multi-Burner 的專屬驅動程式。因此，在連接本光碟機時，Windows 會自動安裝適當的驅動程式，而且光碟機立即可以使用。您不需要執行任何特殊的安裝或移除程序。

警告:

- Windows Device Manager 會將本光碟機辨識為 "IBM Multi-Burner"。
- 在 Windows 2000 作業系統中，必須安裝 Service Pack 4 或更新版。

移除 Multi-Burner 硬體

USB 接線與電腦之間的連接支援「熱插拔」；因此，在移除 Multi-Burner 時，無需關閉電腦。請遵循下列程序，以移除 Windows 2000 和 Windows XP 版的 Multi-Burner。

警告:

請勿在短時間內接連重新連接光碟機到電腦或從電腦移除光碟機。因為可能無法辨識光碟機。請在移除後大約 20 秒再重新連接光碟機。

請使用「托盤」圖示進行這項程序。

Windows 2000

1. 結束使用光碟機的程式。
2. 確認光碟機的「寫入」指示燈已熄滅。
3. 按一下資訊框上的**移除**圖示。



4. 選取要移除的光碟機。在此情況下，請選取指定給光碟機的光碟機名稱（此圖中的 D:）。



5. 這時會出現「可放心移除硬體」確認視窗。按一下**確定**按鈕。

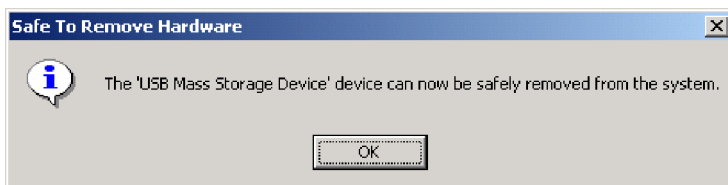

6. 從電腦的 USB 終端取下 USB 接線的插頭。

註：以上指出的訊息可能隨您作業系統的版本而異。請參閱電腦或作業系統的說明手冊以取得詳細資訊。

Windows XP

1. 結束使用光碟機的程式。
2. 確認光碟機的「寫入」指示燈已熄滅。
3. 按一下資訊框上的**移除**圖示。



4. 選取要移除的光碟機。在此情況下，請選取指定給光碟機的光碟機名稱（此圖中的 D:）。



5. 這時會出現「可放心移除硬體」確認視窗。按一下**確定**按鈕。

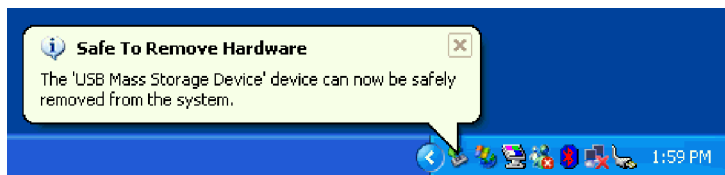

6. 從電腦的 USB 終端取下 USB 接線的插頭。

註：以上指出的訊息可能隨您作業系統的版本而異。請參閱電腦或作業系統的說明手冊以取得詳細資訊。

設定媒體

1. 按光碟機的退出鈕來打開上蓋。
2. 使標籤面朝上，將媒體置於托盤上。將光碟的中央小孔對齊托盤中央的夾子，然後按壓中央小孔的外圍附近，緊密地放入光碟。
3. 輕輕關上上蓋，然後按壓蓋子，直到完全鎖住為止。
4. 當上蓋正確關上時，在忙碌指示燈閃爍幾秒後，就會辨識媒體並可使用媒體。

退出媒體

1. 按光碟機的退出鈕來自動打開上蓋。
2. 按住夾子的上半部，從托盤小心提起光碟的邊緣。
3. 輕輕關上上蓋，直到上蓋完全關上為止。檢查蓋子是否緊密鎖住。

播放音效光碟

您可以利用 Windows Media Player 或音效光碟播放軟體（如 Microsoft CD Player），使用光碟機播放音效光碟。操作方法隨軟體和版本而異。請參閱電腦或軟體的操作手冊以取得詳細資訊。

Windows 2000

在 Windows Media Player 中，當您按一下「選項」視窗中的「CD 音效」標籤時，您會看到「數位播放」勾選框，如下圖所示。

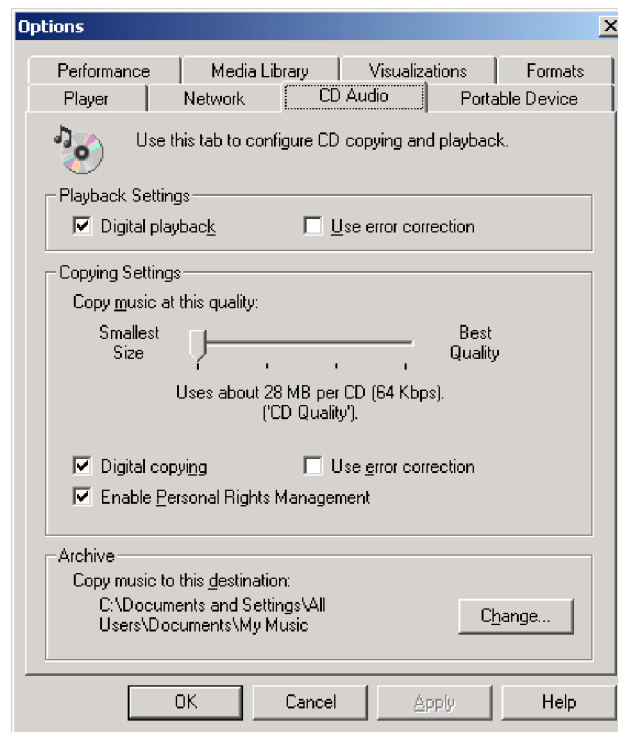

此外，您會在「裝置管理員」上的 Multi-Burner 內容上看到「使用此 Multi-Burner 光碟機啓用數位音樂 CD」勾選框，如下圖所示。當播放程式軟體中沒有用於數位播放的

設定項目時，請嘗試以上的設定。

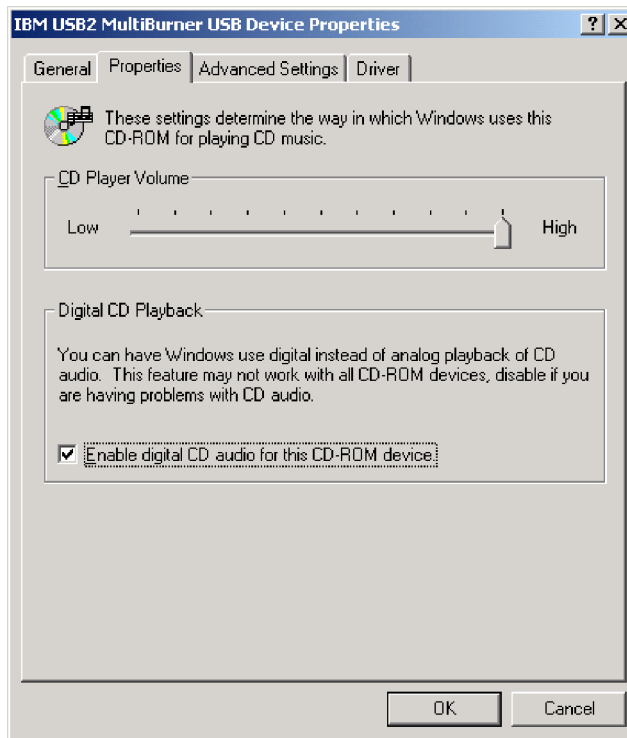

註： 以上的視窗可能隨您作業系統的版本而異。請參閱電腦或作業系統的說明手冊以取得詳細資訊。

Windows XP

在 Windows Media Player 中，當您按一下「內容」視窗中的「CD 音效」標籤時，您會看到「數位播放」勾選框，如下圖所示。

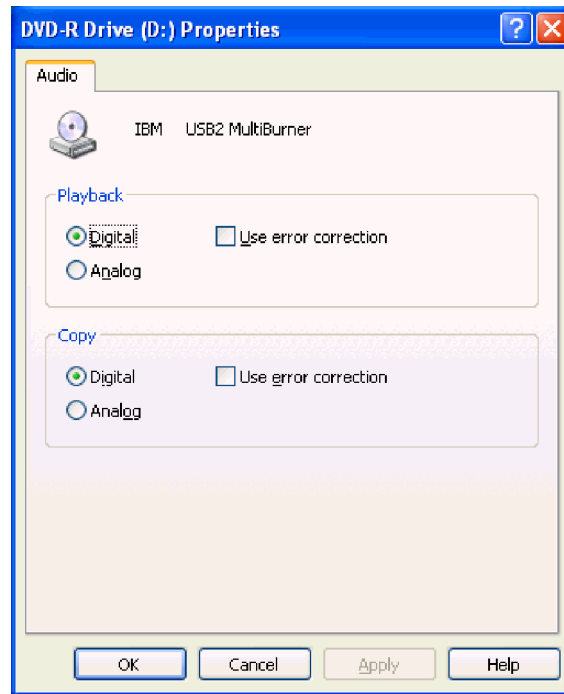

此外，您會在「裝置管理員」上的 Multi-Burner 內容上看到「使用此 Multi-Burner 光碟機啟用數位音樂 CD」勾選框，如下圖所示。當播放程式軟體中沒有用於數位播放的設定項目時，請嘗試以上的設定。

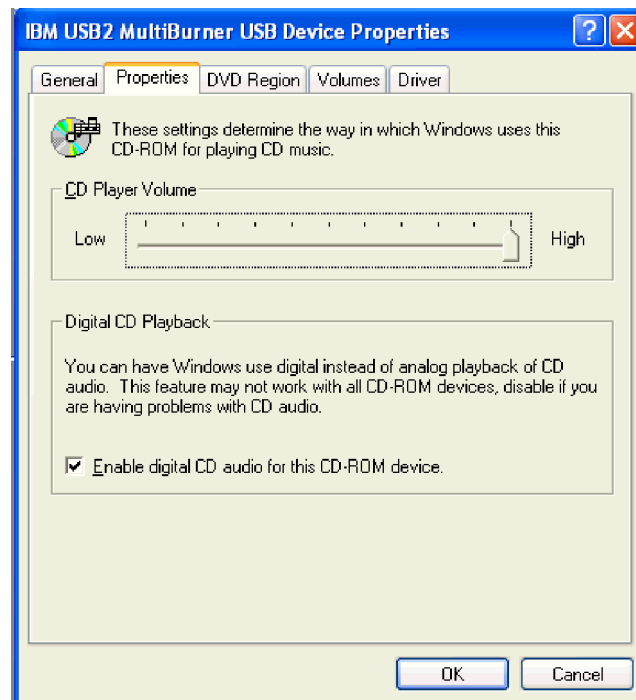

註： 以上的視窗可能隨您作業系統的版本而異。請參閱電腦或作業系統的說明手冊以取得詳細資訊。

第 6 章 應用軟體

IBM USB 2.0 Portable Multi-Burner Software and User's Guide Super CD 含有下列軟體：

- **Intervideo WinDVD Creator Plus**

電腦零件	最低要求	最佳
處理器	Intel Celeron 800Mhz	Intel Pentium® III 600Mhz 針對即時需求，Direct DVD 支援需要 P4 1.6GHz 或更高階處理器
RAM	64Mb	128Mb
作業系統	Windows 2000 或 Windows XP	Windows 2000 或 Windows XP
音效	支援 48KHz 播放的 Windows 相容音效卡	支援 48KHz 播放的 Windows 相容音效卡（建議採用 PCI）
視訊	Windows 相容 AGP 或 PCI 圖形卡	Windows 相容 AGP 或 PCI 圖形卡（建議採用覆蓋支援）
硬碟	<ul style="list-style-type: none">• 70 MB 用於安裝• 620 MB 用於每個小時的 VCD 品質 MPEG-1 影像• 2 GB 用於每個小時的 DVD 品質 MPEG-2 影像	<ul style="list-style-type: none">• 70 MB 用於安裝• 620 MB 用於每個小時的 VCD 品質 MPEG-1 影像• 2 GB 用於每個小時的 DVD 品質 MPEG-2 影像
其他		要燒錄 VCD 和 DVD，必須有 CD 或 DVD 燒錄器。要從外部來源匯入影像，必須有適當的硬體，如 DV 相機和攝影機

註： 在預先安裝了 DivX codec 的情況下，WinDVD Creator Plus 可以匯入及匯出 DivX 內容。DivX 是 DivXNetworks, Inc. 的商標。

這個軟體可讓您將視訊檔錄製到 DVD-RW 或 DVD-R 媒體，可在大部份的單機式 DVD 播放機上播放。您也可以錄製之前，使用這個軟體來編輯及修改您自己的珍貴影像。

如果您的電腦上安裝了類比或 IEEE 1394 擷取裝置，則可以利用這個軟體來從相機錄製影像。

- **IBM Drive Letter Access (DLA)**

這個軟體可讓您使用光碟機代號直接寫入 CD-RW、CD-R、DVD-RAM、DVD-RW 和 DVD-R 媒體，如同寫入磁片一樣。DLA 可以格式化所有的光碟格式類型。利用 DLA，您可以拖放檔案、建立新目錄，或是直接從任何應用程式儲存檔案至 Multi-Burner。

- **UDF 讀取器**

這個軟體可讓您安裝軟體，以用於在配備 DVD 光碟機的電腦上讀取 DVD-RAM、DVD-RW 和 CD-RW 媒體。它還可讓您在未安裝 DLA 的情況下，讀取系統上使用 DLA 建立的光碟。

- **IBM RecordNow**

IBM RecordNow 是一個光碟支配軟體，它可讓您從電腦上的檔案或是其他光碟媒體（如 CD 或 DVD）建立您自己的音樂或資料光碟。無論是家中或車內的，或是透過電腦的 CD 光碟機，任何 CD 播放機都可以播放使用 IBM RecordNow 所建立的音樂光碟。IBM RecordNow 還可讓您輕易建立可在任何適宜的 CD 或 DVD 光碟讀取機上讀取的資料光碟。

註： 某些 DVD 播放程式無法讀取 CD-R 媒體。請參閱光碟機隨附的說明文件，以取得有關受支援媒體的資訊。

IBM RecordNow 會以簡易的精靈和淺顯的使用者介面，逐步帶領您進行錄製程序。

使用 IBM RecordNow，您可以建立下列項目：

- 現有光碟的精確副本 - 「精確副本」功能可製作主要光碟的副本、將原始光碟的光碟配置轉換成 CD-R、CD-RW 或 DVD 媒體。
- 硬碟中的保存資料光碟 - 使用「製作資料光碟」功能來儲存電子形式資料，像是位於電腦硬碟上的檔案和應用程式。有別於音樂光碟，資料光碟是用來儲存只能以電腦讀取的檔案，即使光碟上有音效檔，也無法在家中或汽車音響上播放。
- 從 WAV、MP3 或 WMA 檔案或是現有的音樂光碟進行音樂編譯 - 「製作音樂光碟」功能可從硬碟或現有的音樂光碟建立自訂的音樂光碟。CD 音樂資料庫功能可以自動將追蹤資訊標示在檔案上，以協助您編排您的收藏作品。

註： 請參閱 IBM RecordNow 線上說明，以取得有關如何「製作精確副本」、「建立資料光碟」或「利用 IBM RecordNow 建立音效光碟」的相關資訊。

若要啟動 RecordNow，請完成下列程序：

1. 按一下**開始**。
2. 按一下**程式集**。
3. 按一下 **IBM RecordNow**。
4. 按一下 **RecordNow** 開啓錄製軟體主視窗。

- **IBM Simple Backup**

這個軟體可讓您在 DVD-RAM、DVD-RW、DVD-R、CD-R 或 CD-RW 媒體上建立系統檔的完整或遞增式備份，並可讓您在電腦毀損時加以還原。

- **Intervideo WinDVD**

這個軟體可讓您在電腦上播放 DVD 影像，或是從硬碟機播放視訊檔。

註： 某些圖形配接卡（如 FIREGL、Intergraph 和 3dLabs）不支援 DVD 影像播放。

第 7 章 使用 Multi-Burner

本節提供有關如何處置、載入及維護 DVD 和 CD 以及如何維護 Multi-Burner 光碟機的資訊。

準備工作

為獲取最佳的結果，在使用光碟機之前，請先複查下列準則：

- 在格式化或寫入光碟時，請勿移動 ThinkPad 電腦，因為這可能會導致資料錯誤。此外，在格式化或寫入光碟時也要盡量不要打字，因此這也會導致資料錯誤。
- 寫入光碟時，讓 ThinkPad 電腦置於平坦的表面上。
- 關閉螢幕保護裝置。使用螢幕保護裝置可能會中斷格式化和寫入程序。
- 在寫入光碟時，不要讓 ThinkPad 電腦進入休眠或暫停模式。

註：光碟機的讀寫結果是依照所使用的 DVD 或 CD 媒體品質與特性而定。

處置及維護光碟

請小心處置及清理光碟（特別是像是 CD-R 和 CD-RW 光碟等可寫入媒體），讓它們保持為可讀取。採取下列預防措施可延長光碟的壽命：

- 永遠將光碟存放在其原包裝內。
- 永遠將光碟存放在遠離日光直射的地方。
- 永遠將光碟存放在遠離熱源的地方。
- 不使用時，請取出電腦中的光碟。
- 每次使用前都先檢查光碟是否破裂。
重要事項：請勿使用破裂的光碟。
- 不要將光碟強行放入電腦或包裝盒中。
- 不要彎曲或扭曲光碟。
- 不要使用市售清潔劑清潔光碟。
- 不要在光碟表面上書寫。
- 握持光碟的邊緣或中孔。
- 不要觸摸光碟的表面。
- 清除灰塵或指紋時，使用沒有棉絮的軟布從中央向邊緣擦拭光碟。

請注意：用環形方式擦拭光碟可能導致資料流失。

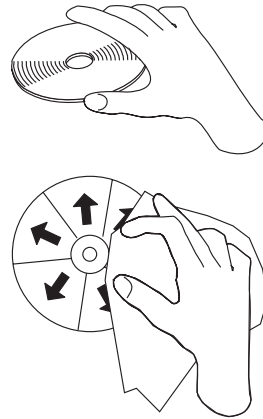

維護 Multi-Burner 光碟機

若要在作業期間保護光碟機，請採取下列預防措施：

- 在移動光碟機之前，請先取出光碟機中的光碟。
- 不要將異物插入光碟機。
- 不要在光碟機上方堆放物品。
- 不要取下光碟機蓋子或試圖維修光碟機。
- 在下列任何狀況下，請勿操作光碟機：
 - 高溫、高濕度，或日光直射
 - 過度震動、劇烈搖晃或傾斜的表面
 - 過多的灰塵

清潔光碟機

請使用軟布擦掉光碟機上的髒污。如果髒污仍然留存著，將所有的水都擰乾之後，使用沾上稀釋的中性清潔劑的布。如果液體流入光碟機中，可能會導致嚴重故障、電擊或起火。利用液體清潔時，請務必在將光碟機與電腦切斷連接之後，將所提供的 AC 整流器從插座上拔除。

請勿塗抹像是苯或松脂油等溶劑。家用或工業用化學清潔劑可能會損壞光碟機的塗層。

使用光碟機

本節包含有關使用 Multi-Burner 的資訊。

使用單面和雙面 DVD-RAM 媒體

DVD-RAM 媒體有單面和雙面兩種版本。

2.6 GB 和 4.7 GB 版本為單面。9.4 GB 版本為雙面。若要存取媒體雙面上的資料，您必須從光碟機中取出媒體、倒轉過來，然後將它重新插入光碟機。

處置的預防措施

請小心處理取出的光碟。殘屑、塵埃、指紋、污跡或刮痕可能會損害媒體的錄製和播放。如果要清理灰塵或其他殘屑，請使用 CD 清潔套件。請使用乾的軟布來清潔光碟。請勿使用溶劑來清潔光碟表面。在標示光碟時，請使用軟的毛氈頭麥克筆，在印出的標籤面或光碟匣上書寫。請避免日光直射、高溫及高濕度。請勿將標籤貼到光碟的任一面。

搭配使用光碟機與 CD 和 DVD

請完成下列程序來讀取資料光碟：

1. 開啓電腦的電源。
2. 按光碟機頂端的「開啓/關閉」按鈕。
3. 標籤面朝上，將光碟插入托盤。
4. 輕輕關上上蓋，來關閉光碟機。
5. 等待光碟機忙碌指示燈停止閃爍並持續亮著。
6. 連按兩下 CD 光碟機或 DVD-RAM/DVD-R/DVD-RW 圖示。

使用 DVD 播放程式軟體

本節說明如何使用及自訂 DVD 播放程式軟體。 *IBM USB 2.0 Portable Multi-Burner Software and User's Guide Super CD* 上的 ReadMe 檔案中載有有關 DVD 播放程式軟體的現行資訊。

使用 DVD 功能

若要使用 DVD 功能，您必須安裝 WinDVD（DVD 影片播放程式）。

啓用 driver letter access (DLA)

提供 Drive Letter Access (DLA)，讓您可以將資料寫入 CD-R、CD-RW、DVD-RAM、DVD-RW 和 DVD-R 媒體。DVD-RAM、DVD-RW、CD-RW、DVD-R 和 CD-R 媒體可以寫入多次（可以附加 DVD-R 和 CD-R 媒體上的資料，直到這些光碟滿載為止）。

若要格式化及寫入 DVD-R、CD-R、DVD-RAM、DVD-RW 或 CD-RW 媒體，請執行下列步驟：

1. 將光碟插入光碟機。
2. 連按兩下**我的電腦**。用滑鼠右鍵按一下 USB 2.0 Multi-Burner 光碟機代號。
3. 按一下**格式化**。格式化時間將會隨您使用的格式化程序（「快速」或「完整」）而異。
4. 在格式化完成之後，您可以將檔案拖放到 USB 2.0 Multi-Burner 光碟機圖示，也可以在「Windows 檔案總管」中移動檔案。

若要使 CD-R 媒體在其他電腦中相容，請執行下列步驟：

1. 連按兩下**我的電腦**。用滑鼠右鍵按一下 Multi-Burner 光碟機代號。
2. 按一下**製作相容**。

爲了在其他電腦中使用 UDF 格式化的 DVD-RAM、DVD-RW 或 CD-RW 媒體，*IBM USB 2.0 Portable Multi-Burner Software and User's Guide Super CD* 上包含有 UDF reader。若要使用 UDF 讀取器，請遵循下列程序：

1. 將 *IBM USB 2.0 Portable Multi-Burner Software and User's Guide Super CD* 插入要使用 UDF 格式化光碟之電腦的光碟機或 DVD 光碟機。
2. 按一下**開始**。
3. 按一下**執行**。
4. 輸入 `e:\UDF\language`，其中 *e* 是 USB 2.0 Multi-Burner 光碟機的光碟機代號，`language` 是您的語言。
5. 按一下**確定**。
6. 連按兩下 **SETUP.EXE**，然後遵循螢幕指示。

註： 只有未安裝另一個用於 CD-RW 或 DVD-RW 的 DLA 程式的系統才需要 UDF reader。

使用 Intervideo WinDVD Creator Plus

利用 Intervideo WinDVD Creator Plus，您可以擷取、編輯及錄製視訊檔和音效檔。您也可以利用 Intervideo WinDVD Creator Plus，使用您自己的視訊檔和音效檔來建立及錄製 DVD 影像。如需有關 Intervideo 的 WinDVD Creator Plus 裝置的更詳細資訊，請跳至 *IBM USB 2.0 Portable Multi-Burner Software and User's Guide Super CD* 上的 WinDVD Creator Plus User's Guide。

WinDVD Creator Plus 主視窗內的主要功能區爲「擷取」、「編輯」、「編撰」和「製作影片」。從這些功能中，您可以匯入及編輯您自己的視訊檔和音效檔，然後將它們儲存成任何受支援的格式。受支援的格式包括 MPEG-1、MPEG-2、ASF、WMV 和 AVI。當您透過「擷取」和「編輯」步驟準備好視訊檔和音效檔時，就可以從「編撰」功能內新增自訂的功能表。您可以匯入您自己的靜止影像來用來做爲功能表背景或選取其中一個範例影像。當影片備妥時，請進行「製作影片」，您可以在其中選取建立影片時使用的輸出格式和視訊標準。請將影片燒錄到光碟，或是將它儲存到硬碟，稍後再燒錄。如果您使用 WinDVD Creator Plus 在硬碟上建立 DVD 影像，您可以從「專案」功能表中選取「載入要燒錄的影像」。

WinDVD Creator Plus 也提供使用「磁碟管理程式」將影像直接錄製到可錄製 DVD 媒體的功能。執行這項作業不會使用硬碟上的任何額外的空間。利用「磁碟管理程式」，您可以擷取新的視訊或使用已有的視訊檔，然後建立自訂的功能表來完成影片。您可以 +VR 或 -VR 視訊格式建立影片。透過「磁碟管理程式」，您可以隨時編輯影片、新增或刪除視訊區段或更改自訂的功能表。

安裝 WinDVD 及觀看 DVD 影片

若要安裝 WinDVD，請跳至 *IBM USB 2.0 Portable Multi-Burner Software and User's Guide Super CD* 的「軟體」一節。

在安裝 Multi-Burner 光碟機和 WinDVD 軟體之後，就可以觀看 DVD 影片。但是您必須先設定 DVD 內容的 DVD 區碼。

DVD 區碼

DVD 區碼可協助保護 DVD 的內容。全球分成個六個區域，只有在適當的區域可以觀看特定的內容。例如，只有在美國和加拿大可以觀看第 1 區的內容。WinDVD 也和區域相關。

您可以驗證內容的區碼，方法為查看內容包裝盒背面上的區碼符號。

區碼	區域
1	美國、加拿大
2	歐洲、中東、南非、日本
3	東南亞、台灣、韓國
4	拉丁美洲、澳洲、紐西蘭
5	前蘇聯共和國、北非、印度
6	中華人民共和國

將 DVD 插入光碟機來啟動 WinDVD。這時會自動設定區碼，可以觀看影片。這是起始設定。

在設定了區碼之後，如果您插入不同區碼的 DVD，會提示您更改區碼。您可以從起始設定更改區碼，最多四次。

在從其起始設定更改區碼四次以後，它就已固定，再也無法更改。其後，您只能播放來自該區域的 DVD 內容。

若要顯示區碼狀態，請按一下 WinDVD 使用者介面上的 **WinDVD 內容** 按鈕。**一般事項** 標籤包含這項資訊。

若要變更區碼，請執行下列步驟：

1. 開啓電腦的電源並啓動作業系統。
2. 按一下**開始**。
3. 選取**程式集**。
4. 按一下 **Intervideo WinDVD**。
5. 按一下**內容**圖示，開啓**內容**視窗。
6. 按一下**一般內容**標籤。
7. 插入新區域的單區 DVD。
8. 選取您國家或地區的正確區碼。
9. 按一下**確定**。

啓動 WinDVD

若要啓動 WinDVD，請完成下列程序：

1. 按一下**開始**。
2. 按一下**程式集**。
3. 按一下 **InterVideo WinDVD**。
4. 按一下 **InterVideo WinDVD**，開啓 DVD 影片播放程式視窗。

如需有關如何播放 DVD 影片播放程式的相關資訊，請參閱 *IBM USB 2.0 Portable Multi-Burner Software and User's Guide Super CD* 上的 WinDVD 說明資訊。如果您想在電視上觀看 DVD 影片，請參閱隨電腦提供的線上資訊。

註：

1. 您的電腦業經配置為提供最高品質的音效和視訊播放，可利用可用的系統資源獲取。您可以改變預設設定，方法為在「控制台」內變更視訊解析度設定。某些系統沒有足夠的資源可提供所有解析度設定的完整品質音效和視訊播放。如果播放效能不佳，請將解析度調整成較低的設定。
2. 音訊或視訊串流由軟體解碼。音效和視訊子系統必須完全運作並啟用。

使用 CD-R 和 CD-RW 功能

Multi-Burner 光碟機可寫入 CD-R 與 CD-RW 兩種光碟。CD-R 光碟無法消除，但可用於標準 CD 光碟機以及 CD 播放機。

您可以使用 CD-R 光碟來錄製音軌、儲存資料、保存檔案，以及從另一片 CD 複製檔案。

CD-RW 光碟可消除及重複寫入，但只可用於較新款的 MR 且具有與 CD-RW 相容的 CD 光碟機及 DVD 光碟機。您可以使用 CD-RW 光碟來備份、儲存及更新檔案，或是從另一片 CD 複製檔案。

注意事項：

1. CD-R 光碟可在音效光碟播放機上播放。CD-RW 光碟在大部份的音效光碟播放機上都無法播放。
2. 此光碟機隨附的軟體不啟用 DOS、Windows 3.x 或 IBM OS/2® 作業系統的光碟機 CD 錄製功能。
3. 不支援 Ultra Speed CD-RW 媒體寫入。

如需有關使用此軟體的相關資訊，請參閱 *IBM USB 2.0 Portable Multi-Burner Software and User's Guide Super CD* 上的 IBM RecordNow 和 IBM DLA 說明資訊。

使用 DVD-R 和 DVD-RW 功能

Multi-Burner 光碟機可寫入 DVD-R 與 DVD-RW 兩種光碟。DVD-R 光碟無法消除，但可用於標準 DVD 光碟機以及 DVD 播放機。

您可以使用 DVD-R 光碟來錄製音軌、儲存資料、保存檔案，以及從另一片 DVD 複製檔案。

DVD-RW 光碟可消除及重複寫入，但只可用於較新款的 MR 且具有與 DVD-RW 相容的 DVD 光碟機。您可以使用 DVD-RW 光碟來備份、儲存及更新檔案，或是從另一片 DVD 複製檔案。

如需有關使用此軟體的相關資訊，請參閱 *IBM USB 2.0 Portable Multi-Burner Software and User's Guide Super CD* 上的 IBM RecordNow 和 IBM DLA 說明資訊。

使用 DVD+R 和 DVD+RW 功能（讀取）

Multi-Burner 光碟機可讀取 DVD+R 與 DVD+RW 兩種光碟。

備份 CD 或 DVD

如果要複製市售的 CD 或 DVD，您必須擁有著作權或向著作權擁有者取得許可權。如果您未擁有著作權或未向著作權擁有者取得許可權，則您可能會違反著作權法，須支付損害賠償或採取其他補救措施。如需有關著作權法的相關資訊，請諮詢您的法律顧問。

問題解決

硬體、軟體或使用者錯誤都可能導致電腦問題。本節中的資訊可能對於協助您解決問題或收集可提供給服務技術人員的有用資訊上非常有用。您可能還必須參閱電腦、作業系統或音效配接卡的出版品。

請複查下列清單，以取得任何可能適合您情況的問題說明。

無法建立多重階段作業光碟。

請確定光碟上還有足夠的空間可進行另一個階段作業。除了所錄製的資料之外，寫入階段作業還需要導入 (lead-in) 和導出 (lead-out) 空間 (大約 15 MB)。

無法順利寫入 CD-R、CD-RW、DVD-R、DVD-RW 或 DVD-RAM 光碟。

請採取下列動作：

1. 驗證該程序未被螢幕保護裝置、防毒程式、Internet 或電子郵件程式或其他軟體所中斷。請停用可能中斷寫入作業的功能。
2. 驗證硬碟是否已重整。
3. 如果有一部舊式硬碟機在寫入作業期間傳導熱能，請諮詢硬碟機製造廠商或供應商。
4. 更換損壞或刮傷的光碟。
5. 在您的 CD-ROM 和 CD-RW 光碟機上停用 Windows 的「自動插入通知」功能。

無法退出 CD 或 DVD 光碟。

在確定光碟機不是在進行寫入光碟的程序之後，採取下列動作：

1. 透過軟體退出光碟。
2. 使用「退出鈕」。
3. 關閉電腦的電源。等候 45 秒；然後開啓電腦，再嘗試使用「退出鈕」。
4. 如果其他方法也無效，請使用緊急退出桿。如需其他相關資訊，請參閱第 4-1 頁的第 4 章, 『準備使用 Multi-Burner』。

在順利寫入 CD 或 DVD 光碟後，無法從中讀取。

請採取下列動作：

1. 如果您可以在另一部 CD 或 DVD 播放機中讀取 CD 或 DVD 光碟，或是可以看到上一個階段作業，則容體上的目錄資訊可能損壞，導致它無法讀取。若要獲取疑難排解的概念，請查看軟體隨附的說明文件。
2. CD-R、CD-RW、DVD-R、DVD-RW 或 DVD-RAM 光碟可能已損壞。請試用新的光碟或其他品牌的 CD 或 DVD 光碟。

3. 如果您可以讀取寫入光碟機中的 CD-RW、DVD-RW 或 DVD-RAM 光碟，但是無法讀取另一部 MR 磁碟機中的光碟，請確定電腦中已安裝 UDF Reader 程式。
4. 除非電腦要求，否則請避免以較慢的 1X 速度寫入。

附錄 A. Product specifications

This appendix includes the following information:

- Physical specifications
- Power requirements
- Environmental requirements
- Read speeds
- Write speeds

Physical specifications

The physical specifications¹ of the drive are listed in the following table.

Physical specification	
Height	15 mm (0.6 in.)
Width	133 mm (5.2 in.)
Length	146 mm (5.7 in.)
Weight	290 g (0.6 lb)

Power requirements

The following table lists the power specifications by voltage level for the drive. The power specifications are measured at the drive power connector and are nominal values.

Power specifications	Voltage	Average	Maximum
AC/Aux Power	7.5V - 18V dc	1400 mA	2.5 A
USB Standard Bus Power	5V dc	850 mA	1.3 A

Environmental requirements

Specification	Operational	Nonoperational
Temperature (noncondensing)	+5° C to +35° C (+41° F to +90° F)	-20° C to +60° C (-4° F to +140° F)
Relative humidity (noncondensing)	8% to 80%	5% to 95%

1. Product-description data represents IBM's design objectives and is provided for comparative purposes; actual results might vary based on a variety of factors. This product data does not constitute a warranty. Data is subject to change without notice.

Read speeds

Media	Read Speed AC/Aux Power	USB Standard Bus Power
DVD-ROM (single layer)	8X Max.	4X Max.
DVD-ROM (dual layer)	4X Max.	4X Max.
DVD-R (4.7 GB)	4X Max.	4X Max.
DVD-RW (4.7 GB)	4X Max.	4X Max.
DVD-video	4X Max.	4X Max.
DVD-RAM (4.7/9.4 GB)	2X Max.	N/A
DVD-RAM (2.6 GB)	1X Max.	N/A
DVD+R	4X Max.	4X Max.
DVD+RW	4X Max.	4X Max.
CD-ROM	24X Max.	10X Max.
CD-R	24x Max.	10X Max.
CD-RW	16X Max.	10X Max.
CD-DA (DAE)	8X	4X

Write speeds

Media	Write speeds AC/AUX Power
DVD-R (for general, 650 nm)	2X
DVD-RW (Version 1.1)	1X
DVD-RAM (Version 2.1, 4.7/9.4 GB)	2X Max.
CD-R	16X Max.
CD-RW	10X

附錄 B. Service and Support

The following information describes the technical support that is available for your product, during the warranty period or throughout the life of the product. Refer to your IBM Statement of Limited Warranty for a full explanation of IBM warranty terms.

Online technical support

Online technical support is available during the life of your product through the Personal Computing Support Web site at:

www-3.ibm.com/pc/support/site.wss/

During the warranty period, assistance for replacement or exchange of defective components is available. In addition, if your IBM option is installed in an IBM computer, you might be entitled to service at your location. Your technical support representative can help you determine the best alternative.

Telephone technical support

Installation and configuration support through the IBM HelpCenter[®] will be withdrawn or made available for a fee, at IBM's discretion, 90 days after the option has been withdrawn from marketing. Additional support offerings, including step-by-step installation assistance, are available for a nominal fee.

To assist the technical support representative, have available as much of the following information as possible:

- Option name
- Option number
- Proof of purchase
- Computer manufacturer, model, serial number (if IBM), and manual
- Exact wording of the error message (if any)
- Description of the problem
- Hardware and software configuration information for your system

If possible, be at your computer. Your technical support representative might want to walk you through the problem during the call.

For the support telephone number and support hours by country, refer to the following table. If the number for your country or region is not listed, contact your IBM reseller or IBM marketing representative. Response time may vary depending on the number and nature of the calls received.

Phone numbers are subject to change without notice. For the latest phone number list, go to www-3.ibm.com/pc/support/site.wss/ and click **Support Phone List**.

Country or Region	Telephone Number	Country or Region	Telephone Number
Argentina	0800-666-0011	Malaysia	03-7727-7800
Australia	1300-130-426	Mexico	001-866-434-2080
Austria	01-24592-5901	Netherlands	020-514-5770
Belgium	Dutch 02-210-9820 French 02-210-9800	New Zealand	0800-446-149
Bolivia	0800-0189	Norway	66 81 11 00
Brazil	55-11-3889-8986	Peru	0-800-50-866
Canada	1-800-565-3344 Toronto 416-383-3344	Philippines	632-995-2225
Chile	800-224-488	Portugal	21-791 51 47
China (PRC)	800-810-1818	Russia	095-940-2000
China (Hong Kong S.A.R.)	852-2825-7799	Singapore	1800-840-9911
Columbia	980-912-3021	Spain	91-662 49 16
Denmark	45 20 82 00	Sweden	08-477 4420
Ecuador	1-800-426911 (option #4)	Switzerland	058-333-09-00
Finland	09-459 69 60	Taiwan	886-2-2725-9799
France	02 38 55 74 50	Thailand	66-2-273-4000
Germany	07032-1549 201	Turkey	00-800-446-32-041
Indonesia	021-523-8535	United Kingdom	0-1475-555 055
Ireland	01-815-9202	United States	1-800-426-7378
Italy	02-7031-6101	Uruguay	000-411-005-6649
Japan	Consumer customers 0120-887-870 Business customers 0120-887-874	Venezuela	0-800-100-2011
Luxembourg	298-977 5063	Vietnam	848-8295-160

附錄 C. IBM Statement of Limited Warranty - Z125-4753-07 - 11/2002

Part 1 - General Terms

*This Statement of Limited Warranty includes Part 1 - General Terms, Part 2 - Country-unique Terms, and Part 3 - Warranty Information. The terms of Part 2 replace or modify those of Part 1. The warranties provided by IBM in this Statement of Limited Warranty apply only to Machines you purchase for your use, and not for resale. The term "Machine" means an IBM machine, its features, conversions, upgrades, elements, or accessories, or any combination of them. The term "Machine" does not include any software programs, whether pre-loaded with the Machine, installed subsequently or otherwise. **Nothing in this Statement of Limited Warranty affects any statutory rights of consumers that cannot be waived or limited by contract.***

What this Warranty Covers

IBM warrants that each Machine 1) is free from defects in materials and workmanship and 2) conforms to IBM's Official Published Specifications ("Specifications") which are available on request. The warranty period for the Machine starts on the original Date of Installation and is specified in Part 3 - Warranty Information. The date on your invoice or sales receipt is the Date of Installation unless IBM or your reseller informs you otherwise. Many features, conversions, or upgrades involve the removal of parts and their return to IBM. A part that replaces a removed part will assume the warranty service status of the removed part. Unless IBM specifies otherwise, these warranties apply only in the country or region in which you purchased the Machine.

THESE WARRANTIES ARE YOUR EXCLUSIVE WARRANTIES AND REPLACE ALL OTHER WARRANTIES OR CONDITIONS, EXPRESS OR IMPLIED, INCLUDING, BUT NOT LIMITED TO, THE IMPLIED WARRANTIES OR CONDITIONS OF MERCHANTABILITY AND FITNESS FOR A PARTICULAR PURPOSE. SOME STATES OR JURISDICTIONS DO NOT ALLOW THE EXCLUSION OF EXPRESS OR IMPLIED WARRANTIES, SO THE ABOVE EXCLUSION MAY NOT APPLY TO YOU. IN THAT EVENT, SUCH WARRANTIES ARE LIMITED IN DURATION TO THE WARRANTY PERIOD. NO WARRANTIES APPLY AFTER THAT PERIOD. SOME STATES OR JURISDICTIONS DO NOT ALLOW LIMITATIONS ON HOW LONG AN IMPLIED WARRANTY LASTS, SO THE ABOVE LIMITATION MAY NOT APPLY TO YOU.

What this Warranty Does not Cover

This warranty does not cover the following:

- any software programs, whether pre-loaded or shipped with the Machine, or installed subsequently;
- failure resulting from misuse (including but not limited to use of any Machine capacity or capability, other than that authorized by IBM in writing), accident, modification, unsuitable physical or operating environment, or improper maintenance by you;

- failure caused by a product for which IBM is not responsible; and
- any non-IBM products, including those that IBM may procure and provide with or integrate into an IBM Machine at your request.

The warranty is voided by removal or alteration of identification labels on the Machine or its parts.

IBM does not warrant uninterrupted or error-free operation of a Machine.

Any technical or other support provided for a Machine under warranty, such as assistance via telephone with "how-to" questions and those regarding Machine set-up and installation, is provided **WITHOUT WARRANTIES OF ANY KIND**.

How to Obtain Warranty Service

If the Machine does not function as warranted during the warranty period, contact IBM or your reseller to obtain warranty service. If you do not register the Machine with IBM, you may be required to present proof of purchase as evidence of your entitlement to warranty service.

What IBM Will Do to Correct Problems

When you call for service, you must follow the problem determination and resolution procedures that IBM specifies. A technician will attempt to make an initial diagnosis of your problem and help you resolve it over the telephone.

The type of warranty service applicable to your Machine is specified in Part 3 - Warranty Information.

You are responsible for downloading and installing designated Machine Code (microcode, basic input/output system code (called "BIOS"), utility programs, device drivers, and diagnostics delivered with an IBM Machine) and other software updates from an IBM Internet Web site or from other electronic media, and following the instructions that IBM provides.

If your problem can be resolved with a Customer Replaceable Unit ("CRU") (e.g., keyboard, mouse, speaker, memory, hard disk drive and other easily replaceable parts), IBM will ship these parts to you for replacement by you.

If the Machine does not function as warranted during the warranty period and your problem cannot be resolved over the telephone, through your application of Machine Code or software updates, or with a CRU, IBM or your reseller, if approved by IBM to provide warranty service, will either, at its discretion, 1) repair it to make it function as warranted, or 2) replace it with one that is at least functionally equivalent. If IBM is unable to do either, you may return the Machine to your place of purchase and your money will be refunded.

IBM or your reseller will also manage and install selected engineering changes that apply to the Machine.

Exchange of a Machine or Part

When the warranty service involves the exchange of a Machine or part, the item IBM or your reseller replaces becomes its property and the replacement becomes yours. You represent that all removed items are genuine and unaltered. The replacement may not be new, but will be in good working order and at least functionally equivalent to the item replaced. The replacement assumes the warranty service status of the replaced item.

Your Additional Responsibilities

Before IBM or your reseller exchanges a Machine or part, you agree to remove all features, parts, options, alterations, and attachments not under warranty service.

You also agree to:

1. ensure that the Machine is free of any legal obligations or restrictions that prevent its exchange;
2. obtain authorization from the owner to have IBM or your reseller service a Machine that you do not own; and
3. where applicable, before service is provided:
 - a. follow the service request procedures that IBM or your reseller provides;
 - b. backup or secure all programs, data, and funds contained in the Machine;
 - c. IBM or your reseller with sufficient, free, and safe access to your facilities to permit IBM to fulfill its obligations; and
 - d. inform IBM or your reseller of changes in the Machine's location.
4. (a) ensure all information about identified or identifiable individuals (Personal Data) is deleted from the Machine (to the extent technically possible), (b) allow IBM, your reseller or an IBM supplier to process on your behalf any remaining Personal Data as IBM or your reseller considers necessary to fulfill its obligations under this Statement of Limited Warranty (which may include shipping the Machine for such processing to other IBM service locations around the world), and (c) ensure that such processing complies with any laws applicable to such Personal Data.

Limitation of Liability

IBM is responsible for loss of, or damage to, your Machine only while it is 1) in IBM's possession or 2) in transit in those cases where IBM is responsible for the transportation charges.

Neither IBM nor your reseller are responsible for any of your confidential, proprietary or personal information contained in a Machine which you return to IBM for any reason. You should remove all such information from the Machine prior to its return.

Circumstances may arise where, because of a default on IBM's part or other liability, you are entitled to recover damages from IBM. In each such instance, regardless of the basis on which you are entitled to claim damages from IBM (including fundamental breach, negligence, misrepresentation, or other contract or tort claim), except for any liability that cannot be waived or limited by applicable laws, IBM is liable for no more than

1. damages for bodily injury (including death) and damage to real property and tangible personal property; and

2. the amount of any other actual direct damages, up to the charges (if recurring, 12 months' charges apply) for the Machine that is subject of the claim. For purposes of this item, the term "Machine" includes Machine Code and Licensed Internal Code ("LIC").

This limit also applies to IBM's suppliers and your reseller. It is the maximum for which IBM, its suppliers, and your reseller are collectively responsible.

UNDER NO CIRCUMSTANCES IS IBM, ITS SUPPLIERS OR RESELLERS LIABLE FOR ANY OF THE FOLLOWING EVEN IF INFORMED OF THEIR POSSIBILITY: 1) THIRD PARTY CLAIMS AGAINST YOU FOR DAMAGES (OTHER THAN THOSE UNDER THE FIRST ITEM LISTED ABOVE); 2) LOSS OF, OR DAMAGE TO, DATA; 3) SPECIAL, INCIDENTAL, OR INDIRECT DAMAGES OR FOR ANY ECONOMIC CONSEQUENTIAL DAMAGES; OR 4) LOST PROFITS, BUSINESS REVENUE, GOODWILL OR ANTICIPATED SAVINGS. SOME STATES OR JURISDICTIONS DO NOT ALLOW THE EXCLUSION OR LIMITATION OF INCIDENTAL OR CONSEQUENTIAL DAMAGES, SO THE ABOVE LIMITATION OR EXCLUSION MAY NOT APPLY TO YOU. SOME STATES OR JURISDICTIONS DO NOT ALLOW LIMITATIONS ON HOW LONG AN IMPLIED WARRANTY LASTS, SO THE ABOVE LIMITATION MAY NOT APPLY TO YOU.

Governing Law

Both you and IBM consent to the application of the laws of the country in which you acquired the Machine to govern, interpret, and enforce all of your and IBM's rights, duties, and obligations arising from, or relating in any manner to, the subject matter of this Statement of Limited Warranty, without regard to conflict of law principles.

THESE WARRANTIES GIVE YOU SPECIFIC LEGAL RIGHTS AND YOU MAY ALSO HAVE OTHER RIGHTS WHICH VARY FROM STATE TO STATE OR JURISDICTION TO JURISDICTION.

Jurisdiction

All of our rights, duties, and obligations are subject to the courts of the country in which you acquired the Machine.

Part 2 - Country-unique Terms

AMERICAS

ARGENTINA

Governing Law: *The following is added after the first sentence:*

Any litigation arising from this Statement of Limited Warranty will be settled exclusively by the Ordinary Commercial Court of the city of Buenos Aires.

BRAZIL

Governing Law: *The following is added after the first sentence:*

Any litigation arising from this Statement of Limited Warranty will be settled exclusively by the court of Rio de Janeiro, RJ.

Peru

Limitation of Liability: *The following is added at the end of this section:*

In accordance with Article 1328 of the Peruvian Civil Code the limitations and exclusions specified in this section will not apply to damages caused by IBM's willful misconduct ("dolo") or gross negligence ("culpa inexcusable").

NORTH AMERICA

How to Obtain Warranty Service: *The following is added to this Section:*

To obtain warranty service from IBM in Canada or the United States, call 1-800-IBM-SERV (426-7378).

CANADA

Limitation of Liability: *The following replaces item 1 of this section:*

1. damages for bodily injury (including death) or physical harm to real property and tangible personal property caused by IBM's negligence; and

Governing Law: *The following replaces 『laws of the country in which you acquired the Machine』 in the first sentence:*
laws in the Province of Ontario.

UNITED STATES

Governing Law: *The following replaces 『laws of the country in which you acquired the Machine』 in the first sentence:*
laws of the State of New York.

ASIA PACIFIC

AUSTRALIA

What this Warranty Covers: *The following paragraph is added to this Section:*

The warranties specified in this Section are in addition to any rights you may have under the Trade Practices Act 1974 or other similar legislation and are only limited to the extent permitted by the applicable legislation.

Limitation of Liability: *The following is added to this Section:*

Where IBM is in breach of a condition or warranty implied by the Trade Practices Act 1974 or other similar legislation, IBM's liability is limited to the repair or replacement of the goods or the supply of equivalent goods. Where that condition or warranty relates to right to sell, quiet possession or clear title, or the goods are of a kind ordinarily acquired for personal, domestic or household use or consumption, then none of the limitations in this paragraph apply.

Governing Law: *The following replaces 『laws of the country in which you acquired the Machine』 in the first sentence:*
laws of the State or Territory.

CAMBODIA, LAOS, AND VIETNAM

Governing Law: *The following replaces 『laws of the country in which you acquired the Machine』 in the first sentence:*
laws of the State of New York, United States of America.

CAMBODIA, INDONESIA, LAOS, AND VIETNAM

Arbitration: The following is added under this heading:

Disputes arising out of or in connection with this Statement of Limited Warranty shall be finally settled by arbitration which shall be held in Singapore in accordance with the Arbitration Rules of Singapore International Arbitration Center ("SIAC Rules") then in effect. The arbitration award shall be final and binding for the parties without appeal and shall be in writing and set forth the findings of fact and the conclusions of law.

The number of arbitrators shall be three, with each side to the dispute being entitled to appoint one arbitrator. The two arbitrators appointed by the parties shall appoint a third arbitrator who shall act as chairman of the proceedings. Vacancies in the post of chairman shall be filled by the president of the SIAC. Other vacancies shall be filled by the respective nominating party. Proceedings shall continue from the stage they were at when the vacancy occurred.

If one of the parties refuses or otherwise fails to appoint an arbitrator within 30 days of the date the other party appoints its, the first appointed arbitrator shall be the sole arbitrator, provided that the arbitrator was validly and properly appointed.

All proceedings shall be conducted, including all documents presented in such proceedings, in the English language. The English language version of this Statement of Limited Warranty prevails over any other language version.

HONG KONG S.A.R. OF CHINA AND MACAU S.A.R. OF CHINA

Governing Law: *The following replaces 『laws of the country in which you acquired the Machine』 in the first sentence:*
laws of Hong Kong Special Administrative Region of China.

INDIA

Limitation of Liability: *The following replaces items 1 and 2 of this Section:*

1. liability for bodily injury (including death) or damage to real property and tangible personal property will be limited to that caused by IBM's negligence; and
2. as to any other actual damage arising in any situation involving nonperformance by IBM pursuant to, or in any way related to the subject of this Statement of Limited Warranty, , the charge paid by you for the individual Machine that is the subject of the claim. For purposes of this item, the term "Machine" includes Machine Code and Licensed Internal Code ("LIC").

Arbitration: *The following is added under this heading :*

Disputes arising out of or in connection with this Statement of Limited Warranty shall be finally settled by arbitration which shall be held in Bangalore, India in accordance with the laws of India then in effect. The arbitration award shall be final and binding for the parties without appeal and shall be in writing and set forth the findings of fact and the conclusions of law.

The number of arbitrators shall be three, with each side to the dispute being entitled to appoint one arbitrator. The two arbitrators appointed by the parties shall appoint a third arbitrator who shall act as chairman of the proceedings. Vacancies in the post of chairman shall be filled by the president of the Bar Council of India. Other vacancies shall be filled by the respective nominating party. Proceedings shall continue from the stage they were at when the vacancy occurred.

If one of the parties refuses or otherwise fails to appoint an arbitrator within 30 days of the date the other party appoints its, the first appointed arbitrator shall be the sole arbitrator, provided that the arbitrator was validly and properly appointed.

All proceedings shall be conducted, including all documents presented in such proceedings, in the English language. The English language version of this Statement of Limited Warranty prevails over any other language version.

JAPAN

Governing Law: *The following sentence is added to this section:*

Any doubts concerning this Statement of Limited Warranty will be initially resolved between us in good faith and in accordance with the principle of mutual trust.

MALAYSIA

Limitation of Liability: *The word "SPECIAL" in item 3 of the fifth paragraph is deleted.*

NEW ZEALAND

What this Warranty Covers: *The following paragraph is added to this section:*

The warranties specified in this section are in addition to any rights you may have under the Consumer Guarantees Act 1993 or other legislation which cannot be excluded or limited. The Consumer Guarantees Act 1993 will not apply in respect of any goods which IBM provides, if you require the goods for the purposes of a business as defined in that Act.

Limitation of Liability: *The following is added to this section:*

Where Machines are not acquired for the purposes of a business as defined in the Consumer Guarantees Act 1993, the limitations in this section are subject to the limitations in that Act.

PEOPLE'S REPUBLIC OF CHINA (PRC)

Governing Law: *The following replaces "laws of the country in which you acquired the Machine" in the first sentence:*

laws of the State of New York, United States of America (except when local law requires otherwise).

PHILIPPINES

Limitation of Liability: *Item 3 in the fifth paragraph is replaced by the following:*

SPECIAL (INCLUDING NOMINAL AND EXEMPLARY DAMAGES), MORAL, INCIDENTAL, OR INDIRECT DAMAGES FOR ANY ECONOMIC CONSEQUENTIAL DAMAGES; OR

Arbitration: The following is added under this heading

Disputes arising out of or in connection with this Statement of Limited Warranty shall be finally settled by arbitration which shall be held in Metro Manila, Philippines in accordance with the laws of the Philippines then in effect. The arbitration award shall be final and binding for the parties without appeal and shall be in writing and set forth the findings of fact and the conclusions of law.

The number of arbitrators shall be three, with each side to the dispute being entitled to appoint one arbitrator. The two arbitrators appointed by the parties shall appoint a third arbitrator who shall act as chairman of the proceedings. Vacancies in the post of chairman shall be filled by the president of the Philippine Dispute Resolution Center, Inc.. Other vacancies shall be filled by the respective nominating party. Proceedings shall continue from the stage they were at when the vacancy occurred.

If one of the parties refuses or otherwise fails to appoint an arbitrator within 30 days of the date the other party appoints its, the first appointed arbitrator shall be the sole arbitrator, provided that the arbitrator was validly and properly appointed.

All proceedings shall be conducted, including all documents presented in such proceedings, in the English language. The English language version of this Statement of Limited Warranty prevails over any other language version.

SINGAPORE

Limitation of Liability: The words "**SPECIAL**" and "**ECONOMIC**" in item 3 in the fifth paragraph are deleted.

EUROPE, MIDDLE EAST, AFRICA (EMEA)

THE FOLLOWING TERMS APPLY TO ALL EMEA COUNTRIES:

The terms of this Statement of Limited Warranty apply to Machines purchased from IBM or an IBM reseller.

Hot to Obtain Warranty Service: If you purchase a Machine in Austria, Belgium, Cyprus, Denmark, Estonia, Finland, France, Germany, Greece, Iceland, Ireland, Italy, Latvia, Liechtenstein, Lithuania, Luxembourg, Monaco, Netherlands, Norway, Portugal, Spain, San Marino, Sweden, Switzerland, United Kingdom or Vatican State, you may obtain warranty service for that Machine in any of those countries from either (1) an IBM reseller approved to perform warranty service or (2) from IBM, provided the Machine has been announced and made available by IBM in the country in which you wish to obtain service. If you

purchased a Personal Computer Machine in Albania, Armenia, Belarus, Bosnia and Herzegovina, Bulgaria, Croatia, Czech Republic, Georgia, Hungary, Kazakhstan, Kyrgyzstan, Federal Republic of Yugoslavia, Former Yugoslav Republic of Macedonia (FYROM), Moldova, Poland, Romania, Russia, Slovak Republic, Slovenia, or Ukraine, you may obtain warranty service for that Machine in any of those countries from either (1) an IBM reseller approved to perform warranty service or (2) from IBM.

If you purchase a Machine in a Middle Eastern or African country, you may obtain warranty service for that Machine from the IBM entity within the country of purchase, if that IBM entity provides warranty service in that country, or from an IBM reseller, approved by IBM to perform warranty service on that Machine in that country. Warranty service in Africa is available within 50 kilometers of an IBM approved service provider. You are responsible for transportation costs for Machines located outside 50 kilometers of an IBM approved service provider.

*Add the following paragraph in **Western Europe** (Austria, Belgium, Cyprus, Denmark, Finland, France, Germany, Greece, Iceland, Ireland, Italy, Liechtenstein, Luxembourg, Monaco, Netherlands, Norway, Portugal, Spain, San Marino, Sweden, Switzerland, United Kingdom, Vatican State):*

The warranty for Machines acquired in Western Europe shall be valid and applicable in all Western Europe countries provided the Machines have been announced and made available in such countries.

Governing Law:

The phrase "the laws of the country in which you acquired the Machine" is replaced by:

1) "the laws of Austria" in **Albania, Armenia, Azerbaijan, Belarus, Bosnia-Herzegovina, Bulgaria, Croatia, Georgia, Hungary, Kazakhstan, Kyrgyzstan, FYR Macedonia, Moldova, Poland, Romania, Russia, Slovakia, Slovenia, Tajikistan, Turkmenistan, Ukraine, Uzbekistan, and FR Yugoslavia;**
2) "the laws of France" in **Algeria, Benin, Burkina Faso, Cameroon, Cape Verde, Central African Republic, Chad, Comoros, Congo Republic, Djibouti, Democratic Republic of Congo, Equatorial Guinea, French Guiana, French Polynesia, Gabon, Gambia, Guinea, Guinea-Bissau, Ivory Coast, Lebanon, Madagascar, Mali, Mauritania, Mauritius, Mayotte, Morocco, New Caledonia, Niger, Reunion, Senegal, Seychelles, Togo, Tunisia, Vanuatu, and Wallis & Futuna;** 3) "the laws of Finland" in **Estonia, Latvia, and Lithuania;** 4) "the laws of England" in **Angola, Bahrain, Botswana, Burundi, Egypt, Eritrea, Ethiopia, Ghana, Jordan, Kenya, Kuwait, Liberia, Malawi, Malta, Mozambique, Nigeria, Oman, Pakistan, Qatar, Rwanda, Sao Tome, Saudi Arabia, Sierra Leone, Somalia, Tanzania, Uganda, United Arab Emirates, the United Kingdom, West Bank/Gaza, Yemen, Zambia, and Zimbabwe;** and 5) "the laws of South Africa" in **South Africa, Namibia, Lesotho and Swaziland.**

Jurisdiction: *The following exceptions are added to this section:*

1) **In Austria** the choice of jurisdiction for all disputes arising out of this Statement of Limited Warranty and relating thereto, including its existence, will be the competent court of law in Vienna, Austria (Inner-City); 2) **in Angola, Bahrain, Botswana, Burundi, Egypt, Eritrea, Ethiopia, Ghana, Jordan, Kenya, Kuwait, Liberia, Malawi, Malta, Mozambique, Nigeria, Oman, Pakistan, Qatar, Rwanda, Sao Tome, Saudi Arabia, Sierra Leone, Somalia, Tanzania, Uganda, United Arab Emirates, West Bank/Gaza, Yemen, Zambia, and Zimbabwe** all disputes arising out of this Statement of Limited Warranty or related to its execution, including summary proceedings, will be submitted to the exclusive jurisdiction of the English courts; 3) **in Belgium and Luxembourg**, all disputes arising out of this Statement of Limited Warranty or related to its interpretation or its execution, the law, and the courts of the capital city, of the country of your registered office and/or commercial site location only are competent; 4) **in France, Algeria, Benin, Burkina Faso, Cameroon, Cape Verde, Central African Republic, Chad, Comoros, Congo Republic, Djibouti, Democratic Republic of Congo, Equatorial Guinea, French Guiana, French Polynesia, Gabon, Gambia, Guinea, Guinea-Bissau, Ivory Coast, Lebanon, Madagascar, Mali, Mauritania, Mauritius, Mayotte, Morocco, New Caledonia, Niger, Reunion, Senegal, Seychelles, Togo, Tunisia, Vanuatu, and Wallis & Futuna** all disputes arising out of this Statement of Limited Warranty or related to its violation or execution, including summary proceedings, will be settled exclusively by the Commercial Court of Paris; 5) **in Russia**, all disputes arising out of or in relation to the interpretation, the violation, the termination, the nullity of the execution of this Statement of Limited Warranty shall be settled by Arbitration Court of Moscow; 6) **in South Africa, Namibia, Lesotho and Swaziland**, both of us agree to submit all disputes relating to this Statement of Limited Warranty to the jurisdiction of the High Court in Johannesburg; 7) **in Turkey** all disputes arising out of or in connection with this Statement of Limited Warranty shall be resolved by the Istanbul Central (Sultanahmet) Courts and Execution Directorates of Istanbul, the Republic of Turkey; 8) in each of the following specified countries, any legal claim arising out of this Statement of Limited Warranty will be brought before, and settled exclusively by, the competent court of a) Athens for **Greece**, b) Tel Aviv-Jaffa for **Israel**, c) Milan for **Italy**, d) Lisbon for **Portugal**, and e) Madrid for **Spain**; and 9) **in the United Kingdom**, both of us agree to submit all disputes relating to this Statement of Limited Warranty to the jurisdiction of the English courts.

Arbitration: *The following is added under this heading:*

In Albania, Armenia, Azerbaijan, Belarus, Bosnia-Herzegovina, Bulgaria, Croatia, Georgia, Hungary, Kazakhstan, Kyrgyzstan, FYR Macedonia, Moldova, Poland, Romania, Russia, Slovakia, Slovenia, Tajikistan, Turkmenistan, Ukraine, Uzbekistan, and FR Yugoslavia all disputes arising out of this Statement of Limited Warranty or related to its violation, termination or nullity will be finally settled under the Rules of Arbitration and Conciliation of the International Arbitral Center of the Federal Economic Chamber in Vienna (Vienna Rules) by three arbitrators appointed in accordance with these rules. The arbitration will be held in Vienna, Austria, and the official language of the proceedings will be English. The decision of the arbitrators will be final and binding upon both parties. Therefore, pursuant to paragraph 598 (2) of the Austrian Code of Civil Procedure, the parties expressly waive the application of paragraph 595 (1) figure 7 of the Code. IBM may, however, institute proceedings in a competent court in the country of installation.

In Estonia, Latvia and Lithuania all disputes arising in connection with this Statement of Limited Warranty will be finally settled in arbitration that will be held in Helsinki, Finland in accordance with the arbitration laws of Finland then in effect. Each party will appoint one arbitrator. The arbitrators will then jointly appoint the chairman. If arbitrators cannot agree on the chairman, then the Central Chamber of Commerce in Helsinki will appoint the chairman.

EUROPEAN UNION (EU)

THE FOLLOWING TERMS APPLY TO ALL EU COUNTRIES:

Consumers have legal rights under applicable national legislation governing the sale of consumer goods. Such rights are not affected by the warranties provided in this Statement of Limited Warranty.

How to Obtain Warranty Service: *The following is added to this section:*

To obtain warranty service from IBM in EU countries, see the telephone listing in Part 3 - Warranty Information.

You may contact IBM at the following address:

IBM Warranty & Service Quality Dept.

PO Box 30

Spango Valley

Greenock

Scotland PA 16 OAH

AUSTRIA, DENMARK, FINLAND, GREECE, ITALY, NETHERLANDS, PORTUGAL, SPAIN, SWEDEN AND SWITZERLAND

Limitation of Liability: *The following replaces the terms of this section in its entirety:*

Except as otherwise provided by mandatory law:

1. IBM's liability for any damages and losses that may arise as a consequence of the fulfillment of its obligations under or in connection with this Statement of Limited Warranty or due to any other cause related to this Statement of Limited Warranty is limited to the compensation of only those damages and losses proved and actually arising as an immediate and direct consequence of the non-fulfillment of such obligations (if IBM is at fault) or of such cause, for a maximum amount equal to the charges you paid for the Machine. For purposes of this item, the term "Machine" includes Machine Code and Licensed Internal Code ("LIC").

The above limitation shall not apply to damages for bodily injuries (including death) and damages to real property and tangible personal property for which IBM is legally liable.

2. **UNDER NO CIRCUMSTANCES IS IBM, ITS SUPPLIERS OR RESELLERS LIABLE FOR ANY OF THE FOLLOWING, EVEN IF INFORMED OF THEIR**

POSSIBILITY: 1) LOSS OF, OR DAMAGE TO, DATA; 2) INCIDENTAL OR INDIRECT DAMAGES, OR FOR ANY ECONOMIC CONSEQUENTIAL DAMAGES; 3) LOST PROFITS, EVEN IF THEY ARISE AS AN IMMEDIATE CONSEQUENCE OF THE EVENT THAT GENERATED THE DAMAGES; OR 4) LOSS OF BUSINESS, REVENUE, GOODWILL, OR ANTICIPATED SAVINGS.

FRANCE AND BELGIUM

Limitation of Liability: *The following replaces the terms of this section in its entirety:*

Except as otherwise provided by mandatory law:

1. IBM's liability for any damages and losses that may arise as a consequence of the fulfillment of its obligations under or in connection with this Statement of Limited Warranty is limited to the compensation of only those damages and losses proved and actually arising as an immediate and direct consequence of the non-fulfillment of such obligations (if IBM is at fault), for a maximum amount equal to the charges you paid for the Machine that has caused the damages. For purposes of this item, the term "Machine" includes Machine Code and Licensed Internal Code ("LIC").

The above limitation shall not apply to damages for bodily injuries (including death) and damages to real property and tangible personal property for which IBM is legally liable.

2. **UNDER NO CIRCUMSTANCES IS IBM, ITS SUPPLIERS OR RESELLERS LIABLE FOR ANY OF THE FOLLOWING, EVEN IF INFORMED OF THEIR POSSIBILITY: 1) LOSS OF, OR DAMAGE TO, DATA; 2) INCIDENTAL OR INDIRECT DAMAGES, OR FOR ANY ECONOMIC CONSEQUENTIAL DAMAGES; 3) LOST PROFITS, EVEN IF THEY ARISE AS AN IMMEDIATE CONSEQUENCE OF THE EVENT THAT GENERATED THE DAMAGES; OR 4) LOSS OF BUSINESS, REVENUE, GOODWILL, OR ANTICIPATED SAVINGS.**

THE FOLLOWING TERMS APPLY TO THE COUNTRY SPECIFIED:

AUSTRIA

What this Warranty Covers: *The following replaces the first sentence of the first paragraph of this section:*

The warranty for an IBM Machine covers the functionality of the Machine for its normal use and the Machine's conformity to its Specifications.

The following paragraphs are added to this Section:

The minimum warranty period for Machines is 12 months from the date of delivery. . The limitation period for consumers in action for breach of warranty is the statutory period as a minimum. In case IBM or your reseller is unable to repair an IBM Machine, you can alternatively ask for a partial refund as far as justified by the reduced value of the unrepaired Machine or ask for a cancellation of the respective agreement for such Machine and get your money refunded.

The second paragraph does not apply.

What IBM Will Do to Correct Problems: *The following is added to this section:*

During the warranty period, transportation for delivery of the failing Machine to IBM will be at IBM's expense.

Limitation of Liability: *The following paragraph is added to this section:*

The limitations and exclusions specified in the Statement of Limited Warranty will not apply to damages caused by IBM with fraud or gross negligence and for express warranty.

The following sentence is added to the end of item 2:

IBM's liability under this item is limited to the violation of essential contractual terms in cases of ordinary negligence.

EGYPT

Limitation of Liability: *The following replaces item 2 in this section:*

as to any other actual direct damages, IBM's liability will be limited to the total amount you paid for the Machine that is the subject of the claim. For purposes of this item, the term 『Machine』 includes Machine Code and Licensed Internal Code (LIC).

Applicability of suppliers and resellers (unchanged).

FRANCE

Limitation of Liability: *The following replaces the second sentence of the first paragraph of this section:*

In such instances, regardless of the basis on which you are entitled to claim damages from IBM, IBM is liable for no more than: *(items 1 and 2 unchanged).*

GERMANY

What this Warranty Covers: *The following replaces the first sentence of the first paragraph of this section:*

The warranty for an IBM Machine covers the functionality of the Machine for its normal use and the Machine's conformity to its Specifications.

The following paragraphs are added to this section:

The minimum warranty period for Machines is twelve months. In case IBM or your reseller is unable to repair an IBM Machine, you can alternatively ask for a partial refund as far as justified by the reduced value of the unrepaired Machine or ask for a cancellation of the respective agreement for such Machine and get your money refunded.

The second paragraph does not apply.

What IBM Will Do to Correct Problems: *The following is added to this section:*

During the warranty period, transportation for delivery of the failing Machine to IBM will be at IBM's expense.

Limitation of Liability: *The following paragraph is added to this section:*

The limitations and exclusions specified in the Statement of Limited Warranty will not apply to damages caused by IBM with fraud or gross negligence and for express warranty.

The following sentence is added to the end of item 2:

IBM's liability under this item is limited to the violation of essential contractual terms in cases of ordinary negligence.

HUNGARY

Limitation of Liability: *The following is added at the end of this section:*

The limitation and exclusion specified herein shall not apply to liability for a breach of contract damaging life, physical well-being, or health that has been caused intentionally, by gross negligence, or by a criminal act.

The parties accept the limitations of liability as valid provisions and state that the Section 314.(2) of the Hungarian Civil Code applies as the acquisition price as well as other advantages arising out of the present Statement of Limited Warranty balance this limitation of liability.

IRELAND

What this Warranty Covers: *The following is added to this section:*

Except as expressly provided in these terms and conditions, all statutory conditions, including all warranties implied, but without prejudice to the generality of the foregoing all warranties implied by the Sale of Goods Act 1893 or the Sale of Goods and Supply of Services Act 1980 are hereby excluded.

Limitation of Liability: *The following replaces the terms of this section in its entirety:*

For the purposes of this section, a "Default" means any act, statement, omission, or negligence on the part of IBM in connection with, or in relation to, the subject matter of this Statement of Limited Warranty in respect of which IBM is legally liable to you, whether in contract or tort. A number of Defaults which together result in, or contribute to, substantially the same loss or damage will be treated as one Default occurring on the date of occurrence of the last such Default.

Circumstances may arise where, because of a Default, you are entitled to recover damages from IBM.

This section sets out the extent of IBM's liability and your sole remedy.

1. IBM will accept unlimited liability for death or personal injury caused by the negligence of IBM.
2. Subject always to the Items for Which IBM is Not Liable below, IBM will accept unlimited liability for physical damage to your tangible property resulting from the negligence of IBM.
3. Except as provided in items 1 and 2 above, IBM's entire liability for actual damages for any one Default will not in any event exceed the greater of 1) EUR 125,000, or 2) 125% of the amount you paid for the Machine directly relating to the Default.

Items for Which IBM is Not Liable

Save with respect to any liability referred to in item 1 above, under no circumstances is IBM, its suppliers or resellers liable for any of the following, even if IBM or they were informed of the possibility of such losses:

1. loss of, or damage to, data;
2. special, indirect, or consequential loss; or
3. loss of profits, business, revenue, goodwill, or anticipated savings.

SLOVAKIA

Limitation of Liability: *The following is added to the end of the last paragraph:*

The limitations apply to the extent they are not prohibited under §§ 373-386 of the Slovak Commercial Code.

SOUTH AFRICA, NAMIBIA, BOTSWANA, LESOTHO AND SWAZILAND

Limitation of Liability: *The following is added to this section:*

IBM's entire liability to you for actual damages arising in all situations involving nonperformance by IBM in respect of the subject matter of this Statement of Warranty will be limited to the charge paid by you for the individual Machine that is the subject of your claim from IBM.

UNITED KINGDOM

Limitation of Liability: *The following replaces the terms of this section in its entirety:*

For the purposes of this section, a "Default" means any act, statement, omission, or negligence on the part of IBM in connection with, or in relation to, the subject matter of this Statement of Limited Warranty in respect of which IBM is legally liable to you, whether in contract or tort. A number of Defaults which together result in, or contribute to, substantially the same loss or damage will be treated as one Default.

Circumstances may arise where, because of a Default, you are entitled to recover damages from IBM.

This section sets out the extent of IBM's liability and your sole remedy.

1. IBM will accept unlimited liability for:
 - a. death or personal injury caused by the negligence of IBM; and
 - b. any breach of its obligations implied by Section 12 of the Sale of Goods Act 1979 or Section 2 of the Supply of Goods and Services Act 1982, or any statutory modification or re-enactment of either such Section.
2. IBM will accept unlimited liability, subject always to the Items for Which IBM is Not Liable below, for physical damage to your tangible property resulting from the negligence of IBM.

3. IBM's entire liability for actual damages for any one Default will not in any event, except as provided in items 1 and 2 above, exceed the greater of 1) Pounds Sterling 75,000, or 2) 125% of the total purchase price payable or the charges for the Machine directly relating to the Default.

These limits also apply to IBM's suppliers and resellers. They state the maximum for which IBM and such suppliers and resellers are collectively responsible.

Items for Which IBM is Not Liable

Save with respect to any liability referred to in item 1 above, under no circumstances is IBM or any of its suppliers or resellers liable for any of the following, even if IBM or they were informed of the possibility of such losses:

1. loss of, or damage to, data:
2. special, indirect, or consequential loss; or
3. loss of profits, business, revenue, goodwill, or anticipated savings.

Part 3 - Warranty Information

This Part 3 provides information regarding the warranty applicable to your Machine, including the warranty period and type of warranty service IBM provides.

Warranty Period

The warranty period may vary by country or region and is specified in the table below. NOTE: "Region" means either Hong Kong or Macau Special Administrative Region of China.

IBM USB 2.0 Portable Multi-Burner

Country or Region of Purchase	Warranty Period	Type of Warranty Service
Worldwide	1 year	1, 4

A warranty period of 1 year on parts and 1 year on labor means that IBM provides warranty service without charge for parts and labor during the 1 year warranty period.

Types of Warranty Service

If required, IBM provides repair or exchange service depending on the type of warranty service specified for your Machine in the above table and as described below. Warranty service may be provided by your reseller if approved by IBM to perform warranty service. Scheduling of service will depend upon the time of your call and is subject to parts availability. Service levels are response time objectives and are not guaranteed. The specified level of warranty service may not be available in all worldwide locations, additional charges may apply outside IBM's normal service area, contact your local IBM representative or your reseller for country and location specific information.

1. Customer Replaceable Unit ("CRU") Service

IBM will ship CRU parts to you for your replacement. If IBM instructs you to return the replaced CRU, you are responsible for returning it to IBM in accordance with IBM's instructions. If you do not return the defective CRU, if IBM so instructs, within 30 days of your receipt of the replacement CRU, IBM may charge you for the replacement.

2. On-site Service

IBM or your reseller will either repair or exchange the failing Machine at your location and verify its operation. You must provide suitable working area to allow disassembly and reassembly of the IBM Machine. The area must be clean, well lit and suitable for the purpose. **For some Machines, certain repairs may require sending the Machine to an IBM service center.**

3. Courier or Depot Service¹

You will disconnect the failing Machine for collection arranged by IBM. IBM will provide you with a shipping container for you to return your Machine to a designated service center. A courier will pick up your Machine and deliver it to the designated service center. Following its repair or exchange, IBM will arrange the return delivery of the Machine to your location. You are responsible for its installation and verification.

4. Customer Carry-In or Mail-In Service

You will deliver or mail as IBM specifies (prepaid unless IBM specifies otherwise) the failing Machine suitably packaged to a location IBM designates. After IBM has repaired or exchanged the Machine, IBM will make it available for your collection or, for Mail-in Service, IBM will return it to you at IBM's expense, unless IBM specifies otherwise. You are responsible for the subsequent installation and verification of the Machine.

The IBM Machine Warranty worldwide web site at http://www.ibm.com/servers/support/machine_warranties/ provides a worldwide overview of IBM's Limited Warranty for Machines, a Glossary of IBM definitions, Frequently Asked Questions (FAQs) and Support by Product (Machine) with links to Product Support pages. **The IBM Statement of Limited Warranty is also available on this site in 29 languages.**

To obtain warranty service contact IBM or your IBM reseller. In Canada or the United States, call 1-800-IBM-SERV (426-7378). For other countries, see the telephone numbers below.

Phone numbers are subject to change without notice. For the latest phone number list, go to www-3.ibm.com/pc/support/site.wss/ and click **Support Phone List**.

Country or Region	Telephone Number	Country or Region	Telephone Number
Argentina	0800-666-0011	Malaysia	03-7727-7800
Australia	1300-130-426	Mexico	001-866-434-2080
Austria	01-24592-5901	Netherlands	020-514-5770

1. This type of service is called ThinkPad EasyServ or EasyServ in some countries.

Country or Region	Telephone Number	Country or Region	Telephone Number
Belgium	Dutch 02-210-9820	New Zealand	0800-446-149
	French 02-210-9800		
Bolivia	0800-0189	Norway	66 81 11 00
Brazil	55-11-3889-8986	Peru	0-800-50-866
Canada	1-800-565-3344	Philippines	632-995-2225
	Toronto 416-383-3344		
Chile	800-224-488	Portugal	21-791 51 47
China (PRC)	800-810-1818	Russia	095-940-2000
China (Hong Kong S.A.R.)	852-2825-7799	Singapore	1800-840-9911
Columbia	980-912-3021	Spain	91-662 49 16
Denmark	45 20 82 00	Sweden	08-477 4420
Ecuador	1-800-426911 (option #4)	Switzerland	058-333-09-00
Finland	09-459 69 60	Taiwan	886-2-2725-9799
France	02 38 55 74 50	Thailand	66-2-273-4000
Germany	07032-1549 201	Turkey	00-800-446-32-041
Indonesia	021-523-8535	United Kingdom	0-1475-555 055
Ireland	01-815-9202	United States	1-800-426-7378
Italy	02-7031-6101	Uruguay	000-411-005-6649
Japan	Consumer customers 0120-887-870	Venezuela	0-800-100-2011
	Business customers 0120-887-874		
Luxembourg	298-977 5063	Vietnam	848-8295-160

附錄 D. Notices

IBM may not offer the products, services, or features discussed in this document in all countries. Consult your local IBM representative for information on the products and services currently available in your area. Any reference to an IBM product, program, or service is not intended to state or imply that only that IBM product, program, or service may be used. Any functionally equivalent product, program, or service that does not infringe any IBM intellectual property right may be used instead. However, it is the user's responsibility to evaluate and verify the operation of any non-IBM product, program, or service.

IBM may have patents or pending patent applications covering subject matter described in this document. The furnishing of this document does not give you any license to these patents. You can send license inquiries, in writing, to:

*IBM Director of Licensing
IBM Corporation
North Castle Drive
Armonk, NY 10504-1785
U.S.A.*

INTERNATIONAL BUSINESS MACHINES CORPORATION PROVIDES THIS PUBLICATION 『AS IS』 WITHOUT WARRANTY OF ANY KIND, EITHER EXPRESS OR IMPLIED, INCLUDING, BUT NOT LIMITED TO, THE IMPLIED WARRANTIES OF NON-INFRINGEMENT, MERCHANTABILITY OR FITNESS FOR A PARTICULAR PURPOSE. Some jurisdictions do not allow disclaimer of express or implied warranties in certain transactions, therefore, this statement may not apply to you.

This information could include technical inaccuracies or typographical errors. Changes are periodically made to the information herein; these changes will be incorporated in new editions of the publication. IBM may make improvements and/or changes in the product(s) and/or the program(s) described in this publication at any time without notice.

The products described in this document are not intended for use in implantation or other life support applications where malfunction may result in injury or death to persons. The information contained in this document does not affect or change IBM product specifications or warranties. Nothing in this document shall operate as an express or implied license or indemnity under the intellectual property rights of IBM or third parties. All information contained in this document was obtained in specific environments and is presented as an illustration. The result obtained in other operating environments may vary.

IBM may use or distribute any of the information you supply in any way it believes appropriate without incurring any obligation to you.

Any references in this publication to non-IBM Web sites are provided for convenience only and do not in any manner serve as an endorsement of those Web sites. The materials at those Web sites are not part of the materials for this IBM product, and use of those Web sites is at your own risk.

Any performance data contained herein was determined in a controlled environment. Therefore, the result obtained in other operating environments may vary significantly. Some measurements may have been made on development-level systems and there is no guarantee that these measurements will be the same on generally available systems. Furthermore, some measurements may have been estimated through extrapolation. Actual results may vary. Users of this document should verify the applicable data for their specific environment.

Trademarks

The following terms are trademarks of International Business Machines Corporation in the United States, other countries, or both:

HelpCenter
IBM
IBM logo
OS/2
ThinkPad

Microsoft and Windows are trademarks of Microsoft Corporation in the United States, other countries, or both.

Pentium is a trademark of Intel Corporation in the United States, other countries, or both.

Other company, product, or service names may be trademarks or service marks of others.

Electronic emission notices

IBM USB 2.0 Portable Multi-Burner

Federal Communications Commission (FCC) statement

Note: This equipment has been tested and found to comply with the limits for a Class B digital device, pursuant to Part 15 of the FCC Rules. These limits are designed to provide reasonable protection against harmful interference in a residential installation. This equipment generates, uses, and can radiate radio frequency energy and, if not installed and used in accordance with the instructions, may cause harmful interference to radio communications. However, there is no guarantee that interference will not occur in a particular installation. If this equipment does cause harmful interference to radio or television reception, which can be determined by turning the equipment off and on, the user is encouraged to try to correct the interference by one or more of the following measures:

- Reorient or relocate the receiving antenna.
- Increase the separation between the equipment and receiver.
- Connect the equipment into an outlet on a circuit different from that to which the receiver is connected.
- Consult an IBM authorized dealer or service representative for help.

Properly shielded and grounded cables and connectors must be used in order to meet FCC emission limits. Proper cables and connectors are available from IBM authorized dealers. IBM is not responsible for any radio or television interference caused by using other than

recommended cables and connectors or by unauthorized changes or modifications to this equipment. Unauthorized changes or modifications could void the user's authority to operate the equipment.

This device complies with Part 15 of the FCC Rules. Operation is subject to the following two conditions: (1) this device may not cause harmful interference, and (2) this device must accept any interference received, including interference that may cause undesired operation.

Responsible party:

International Business Machines Corporation
New Orchard Road
Armonk, NY 10504
Telephone: 1-919-543-2193

 Tested To Comply
With FCC Standards
FOR HOME OR OFFICE USE

Industry Canada Class B emission compliance statement

This Class B digital apparatus complies with Canadian ICES-003.

Avis de conformite a la reglementation d'Industrie Canada

Cet appareil numérique de la classe B est conforme à la norme NMB-003 du Canada.

Deutsche EMV-Direktive (electromagnetische Verträglichkeit)

Zulassungsbesccheinigung laut dem Deutschen Gesetz über die elektromagnetische Verträglichkeit von Geräten (EMVG) vom 30. August 1995 (bzw. der EMC EG Richtlinie 89/336):

Dieses Gerät ist berechtigt in Übereinstimmung mit dem Deutschen EMVG das EG-Konformitätszeichen - CE - zu führen. Verantwortlich für die Konformitätserklärung nach Paragraph 5 des EMVG ist die:

IBM Deutschland Informationssysteme GmbH, 70548 Stuttgart.

Informationen in Hinsicht EMVG Paragraph 3 Abs. (2) 2:

Das Gerät erfüllt die Schutzanforderungen nach EN 55024:1998 und EN 55022:1998 Klasse B.
--

EN 55022 Hinweis:

『Wird dieses Gerät in einer industriellen Umgebung betrieben (wie in EN 55022:B festgelegt), dann kann es dabei eventuell gestört werden. In solch einem FA11 ist der Abstand bzw. die Abschirmung zu der industriellen Störquelle zu vergrößern.』

Anmerkung:

Um die Einhaltung des EMVG sicherzustellen sind die Geräte, wie in den IBM Handbüchern angegeben, zu installieren und zu betreiben.

European Union - emission directive

This product is in conformity with the protection requirements of EU Council Directive 89/336/ECC on the approximation of the laws of the Member States relating to electromagnetic compatibility.

IBM can not accept responsibility for any failure to satisfy the protection requirements resulting from a non-recommended modification of the product, including the fitting of non-IBM option cards.

This product has been tested and found to comply with the limits for Class B Information Technology Equipment according to European Standard EN 55022. The limits for Class B equipment were derived for typical residential environments to provide reasonable protection against interference with licensed communication devices.

Union Européenne - Directive Conformité électromagnétique

Ce produit est conforme aux exigences de protection de la Directive 89/336/EEC du Conseil de l'UE sur le rapprochement des lois des États membres en matière de compatibilité électromagnétique.

IBM ne peut accepter aucune responsabilité pour le manquement aux exigences de protection résultant d'une modification non recommandée du produit, y compris l'installation de cartes autres que les cartes IBM.

Ce produit a été testé et il satisfait les conditions de l'équipement informatique de Classe B en vertu de Standard européen EN 55022. Les conditions pour l'équipement de Classe B ont été définies en fonction d'un contexte résidentiel ordinaire afin de fournir une protection raisonnable contre l'interférence d'appareils de communication autorisés.

Unione Europea - Directiva EMC (Conformidad electromagnética)

Este producto satisface los requisitos de protección del Consejo de la UE, Directiva 89/336/CEE en lo que a la legislación de los Estados Miembros sobre compatibilidad electromagnética se refiere.

IBM no puede aceptar responsabilidad alguna si este producto deja de satisfacer dichos requisitos de protección como resultado de una modificación no recomendada del producto, incluyendo el ajuste de tarjetas de opción que no sean IBM.

Este producto ha sido probado y satisface los límites para Equipos Informáticos Clase B de conformidad con el Estándar Europeo EN 55022. Los límites para los equipos de Clase B se han establecido para entornos residenciales típicos a fin de proporcionar una protección razonable contra las interferencias con dispositivos de comunicación licenciados.

Union Europea - Normativa EMC

Questo prodotto è conforme alle normative di protezione ai sensi della Direttiva del Consiglio dell'Unione Europea 89/336/CEE sull'armonizzazione legislativa degli stati membri in materia di compatibilità elettromagnetica.

IBM non accetta responsabilità alcuna per la mancata conformità alle normative di protezione dovuta a modifiche non consigliate al prodotto, compresa l'installazione di schede e componenti di marca diversa da IBM.

Le prove effettuate sul presente prodotto hanno accertato che esso rientra nei limiti stabiliti per le apparecchiature di informatica Classe B ai sensi della Norma Europea EN 55022. I limiti delle apparecchiature della Classe B sono stati stabiliti al fine di fornire ragionevole protezione da interferenze mediante dispositivi di comunicazione in concessione in ambienti residenziali tipici.

이 기기는 가정용으로 전자파 적합등록을 한 기기로서
주거지역에서는 물론 모든 지역에서 사용할 수 있습니다.

この装置は、情報処理装置等電波障害自主規制協議会（VCCI）の基準に基づきクラスB情報技術装置です。この装置は、家庭環境で使用することを目的としていますが、この装置がラジオやテレビジョン受信機に近接して使用されると、受信障害を引き起こすことがあります。
取扱説明書に従って正しい取り扱いをして下さい。

Japanese statement of compliance for products less than or equal to 20 A per phase

高調波ガイドライン適合品



Part Number: 22P9176

Printed in U.S.A.

(1P) P/N: 22P9176

