

***lenovo***

USB 2.0 Super Multi-Burner Drive  
User's Guide



***lenovo***

USB 2.0 Super Multi-Burner Drive  
User's Guide

**Note**

Before using this information and the product it supports, read Appendix B, "Service and Support," Appendix D, "Lenovo Statement of Limited Warranty," and Appendix C, "Notices."

**First Edition (March 2006)**

**© Copyright Lenovo 2006.**

**Portions © Copyright International Business Machines Corporation 2003.**

**All rights reserved.**

U.S. GOVERNMENT USERS – RESTRICTED RIGHTS: Our products and/or services are provided with RESTRICTED RIGHTS. Use, duplication or disclosure by the Government is subject to the GSA ADP Schedule contract with Lenovo Group Limited, if any, or the standard terms of this commercial license, or if the agency is unable to accept this Program under these terms, then we provide this Program under the provisions set forth in Commercial Computer Software–Restricted Rights at FAR 52.227-19, when applicable, or under Rights in Data-General, FAR 52.227.14 (Alternate III).

---

# Contents

<b>Safety</b> . . . . .	<b>v</b>	Before you begin . . . . .	5-1
<b>General safety guidelines.</b> . . . . .	<b>vii</b>	Caring for the USB 2.0 Super Multi-Burner drive	5-1
Service . . . . .	vii	Cleaning the drive . . . . .	5-1
Power cords and power adapters . . . . .	vii	Using Media . . . . .	5-1
Extension cords and related devices . . . . .	vii	Handling and caring for a disc. . . . .	5-1
Plugs and outlets . . . . .	vii	Using DVD-RAM media . . . . .	5-2
Batteries . . . . .	viii	Using CDs and DVDs . . . . .	5-2
Heat and product ventilation . . . . .	viii	Using CD-Rs and CD-RWs . . . . .	5-2
CD and DVD drive safety. . . . .	ix	Using DVD-Rs, DVD+Rs, DVD+RWs and	
		DVD-RWs . . . . .	5-3
		Installing Software . . . . .	5-3
		Using Direct-to-disc . . . . .	5-4
		Using Intervideo WinDVD Creator Plus. . . . .	5-4
		Playing audio CD's . . . . .	5-5
		Windows 2000 . . . . .	5-5
		Windows XP. . . . .	5-6
		Using WinDVD . . . . .	5-8
		Operating system support . . . . .	5-9
		DVD region codes . . . . .	5-9
		Starting WinDVD. . . . .	5-10
		Copying and imaging . . . . .	5-10
<b>About this book</b> . . . . .	<b>xi</b>		
Registering your option . . . . .	xi		
<b>Chapter 1. USB 2.0 Super Multi-Burner Drive</b> . . . . .	<b>1-1</b>	<b>Chapter 6. Troubleshooting</b> . . . . .	<b>6-1</b>
Product description . . . . .	1-1		
Application software . . . . .	1-2	<b>Appendix A. Product specifications</b> . . . . .	<b>A-1</b>
Hardware and software requirements . . . . .	1-4		
Preparing to use the USB 2.0 Super Multi-Burner Drive . . . . .	1-4	<b>Appendix B. Service and Support.</b> . . . . .	<b>B-1</b>
Power mode configurations. . . . .	1-6	Online technical support. . . . .	B-1
Configuration 1: Connecting the drive using self power with AC adapter (full operation). . . . .	1-6	Telephone technical support . . . . .	B-1
Configuration 2: Connecting the drive using standard USB bus power (Limited Speed Operation) . . . . .	1-7	<b>Appendix C. Notices</b> . . . . .	<b>C-1</b>
		Trademarks . . . . .	C-2
<b>Chapter 2. Cabling the USB 2.0 Super Multi-Burner Drive to the host computer</b> . . . . .	<b>2-1</b>	<b>Appendix D. Lenovo Statement of Limited Warranty</b> . . . . .	<b>D-1</b>
		Part 1 - General Terms . . . . .	D-1
<b>Chapter 3. Features</b> . . . . .	<b>3-1</b>	Part 2 - Country-unique Terms . . . . .	D-3
		Part 3 - Warranty Information . . . . .	D-13
<b>Chapter 4. USB 2.0 Super Multi-Burner hardware installation and removal in Windows 2000 and Windows XP</b> . . . . .	<b>4-1</b>	Warranty Period . . . . .	D-13
Removing the USB 2.0 Super Multi-Burner hardware . . . . .	4-1	Types of Warranty Service. . . . .	D-13
Windows 2000 . . . . .	4-1	Worldwide telephone list . . . . .	D-14
Windows XP. . . . .	4-2	Guarantee supplement for Mexico . . . . .	D-17
Setting the media . . . . .	4-2		
Ejecting the media . . . . .	4-2	<b>Appendix E. Electronic emissions notices</b> . . . . .	<b>E-1</b>
		Federal Communications Commission (FCC)	
<b>Chapter 5. Using the USB 2.0 Super Multi-Burner Drive</b> . . . . .	<b>5-1</b>	Declaration of Conformity . . . . .	E-1



---

## Safety

Before installing this product, read the Safety Information.

مج، يجب قراءة دات السلامة

Antes de instalar este produto, leia as Informações de Segurança.

在安装本产品之前，请仔细阅读 **Safety Information** (安全信息)。

Prije instalacije ovog produkta obavezno pročitajte Sigurnosne Upute.

Před instalací tohoto produktu si přečtěte příručku bezpečnostních instrukcí.

Læs sikkerhedsforskrifterne, før du installerer dette produkt.

Ennen kuin asennat tämän tuotteen, lue turvaohjeet kohdasta Safety Information.

Avant d'installer ce produit, lisez les consignes de sécurité.

Vor der Installation dieses Produkts die Sicherheitshinweise lesen.

Πριν εγκαταστήσετε το προϊόν αυτό, διαβάστε τις πληροφορίες ασφάλειας (safety information).

לפני שתתקינו מוצר זה, קראו את הוראות הבטיחות.

A termék telepítése előtt olvassa el a Biztonsági előírásokat!

Prima di installare questo prodotto, leggere le Informazioni sulla Sicurezza.

製品の設置の前に、安全情報をお読みください。

본 제품을 설치하기 전에 안전 정보를 읽으십시오.

Пред да се инсталира овој продукт, прочитајте информацијата за безбедност.

Lees voordat u dit product installeert eerst de veiligheidsvoorschriften.

Les sikkerhetsinformasjonen (Safety Information) før du installerer dette produktet.

Przed zainstalowaniem tego produktu, należy zapoznać się z książką "Informacje dotyczące bezpieczeństwa" (Safety Information).

Antes de instalar este produto, leia as Informações sobre Segurança.

Перед установкой продукта прочтите инструкции по технике безопасности.

Pred inštaláciou tohto zariadenia si prečítajte Bezpečnostné predpisy.

Pred namestitvijo tega proizvoda preberite Varnostne informacije.

Antes de instalar este producto lea la información de seguridad.

Läs säkerhetsinformationen innan du installerar den här produkten.

安裝本產品之前，請先閱讀「安全資訊」。



---

## General safety guidelines

Always observe the following precautions to reduce the risk of injury and property damage.

---

### Service

Do not attempt to service a product yourself unless instructed to do so by the Customer Support Center. Use only a service provider who is approved to repair your particular product.

**Note:** Some parts can be upgraded or replaced by the customer. These parts are referred to as Customer Replaceable Units, or CRUs. Lenovo expressly identifies CRUs as such, and provides documentation with instructions when it is appropriate for customers to replace those parts. You must closely follow all instructions when performing such replacements. Always make sure that the power is turned off and that the product is unplugged from any power source before you attempt the replacement. If you have any questions or concerns, contact the Customer Support Center.

---

### Power cords and power adapters

Use only the power cords and power adapters supplied by the product manufacturer.

Never wrap a power cord around the power adapter or other object. Doing so can stress the cord in ways that can cause the cord to fray, crack or crimp. This can present a safety hazard.

Always route power cords so that they will not be walked on, tripped over, or pinched by objects.

Protect the cord and power adapters from liquids. For instance, do not leave your cord or power adapter near sinks, tubs, toilets, or on floors that are cleaned with liquid cleansers. Liquids can cause a short circuit, particularly if the cord or power adapter has been stressed by misuse. Liquids can also cause gradual corrosion of the power cord terminals and/or the connector terminals on the adapter which can eventually result in overheating.

Always connect power cords and signal cables in the correct order and ensure that all power cord connectors are securely and completely plugged into receptacles.

Do not use any power adapter that shows corrosion at the ac input pins and/or shows signs of overheating (such as deformed plastic) at the ac input or anywhere on the power adapter.

Do not use any power cords where the electrical contacts on either end show signs of corrosion or overheating or where the power cord appears to have been damaged in any way.

---

### Extension cords and related devices

Ensure that extension cords, surge protectors, uninterruptible power supplies, and power strips that you use are rated to handle the electrical requirements of the product. Never overload these devices. If power strips are used, the load should not exceed the power strip input rating. Consult an electrician for more information if you have questions about power loads, power requirements, and input ratings.

---

### Plugs and outlets

If a receptacle (power outlet) that you intend to use with your computer equipment appears to be damaged or corroded, do not use the outlet until it is replaced by a qualified electrician.

Do not bend or modify the plug. If the plug is damaged, contact the manufacturer to obtain a replacement.

Some products are equipped with a three-pronged plug. This plug fits only into a grounded electrical outlet. This is a safety feature. Do not defeat this safety feature by trying to insert it into a non-grounded outlet. If you cannot insert the plug into the outlet, contact an electrician for an approved outlet adapter or to replace the outlet with one that enables this safety feature. Never overload an electrical outlet. The overall system load should not exceed 80 percent of the branch circuit rating. Consult an electrician for more information if you have questions about power loads and branch circuit ratings.

Be sure that the power outlet you are using is properly wired, easily accessible, and located close to the equipment. Do not fully extend power cords in a way that will stress the cords.

Connect and disconnect the equipment from the electrical outlet carefully

---

## Batteries

All personal computers manufactured by Lenovo contain a non-rechargeable coin cell battery to provide power to the system clock. In addition many mobile products such as notebook PCs utilize a rechargeable battery pack to provide system power when in portable mode. Batteries supplied by Lenovo for use with your product have been tested for compatibility and should only be replaced with Lenovo approved parts.

Never attempt to open or service any battery. Do not crush, puncture, or incinerate batteries or short circuit the metal contacts. Do not expose the battery to water or other liquids. Only recharge the battery pack strictly according to instructions included in the product documentation.

Battery abuse or mishandling can cause the battery to overheat, which can cause gasses or flame to “vent” from the battery pack or coin cell. If your battery is damaged, or if you notice any discharge from your battery or the buildup of foreign materials on the battery leads, stop using the battery and obtain a replacement from the battery manufacturer.

Batteries can degrade when they are left unused for long periods of time. For some rechargeable batteries (particularly Lithium Ion batteries), leaving a battery unused in a discharged state could increase the risk of a battery short circuit, which could shorten the life of the battery and can also pose a safety hazard. Do not let rechargeable Lithium-Ion batteries completely discharge or store these batteries in a discharged state.

---

## Heat and product ventilation

Computers generate heat when turned on and when batteries are charging. Notebook PCs can generate a significant amount of heat due to their compact size. Always follow these basic precautions:

- Do not leave the base of your computer in contact with your lap or any part of your body for an extended period when the computer is functioning or when the battery is charging. Your computer produces some heat during normal operation. Extended contact with the body could cause discomfort or, potentially, a skin burn.
- Do not operate your computer or charge the battery near flammable materials or in explosive environments.
- Ventilation slots, fans and/or heat sinks are provided with the product for safety, comfort, and reliable operation. These features might inadvertently become blocked by placing the product on a bed, sofa, carpet, or other flexible surface. Never block, cover or disable these features.

---

## **CD and DVD drive safety**

CD and DVD drives spin discs at a high speed. If a CD or DVD is cracked or otherwise physically damaged, it is possible for the disc to break apart or even shatter when the CD drive is in use. To protect against possible injury due to this situation, and to reduce the risk of damage to your machine, do the following:

- Always store CD/DVD discs in their original packaging
- Always store CD/DVD discs out of direct sunlight and away from direct heat sources
- Remove CD/DVD discs from the computer when not in use
- Do not bend or flex CD/DVD discs, or force them into the computer or their packaging
- Check CD/DVD discs for cracks before each use. Do not use cracked or damaged discs



---

## About this book

This user's manual on the CD included with this option describes how to set up the Lenovo USB 2.0 Super Multi-Burner Drive, how to connect it to a personal computer, and how to operate it. Read the instruction manual of your computer as well. The CD also includes software applications for use with the USB 2.0 Super Multi-Burner Drive. They will automatically install by clicking on them. Read this instruction manual carefully before use for proper handling and operations of the USB 2.0 Super Multi-Burner Drive.

This manual provides installation instructions in the following languages:

- Brazilian Portuguese
- Czech
- English
- French
- German
- Italian
- Japanese
- Simplified Chinese
- Slovak
- Spanish
- Traditional Chinese
- Turkish

---

## Registering your option

Thank you for purchasing this Lenovo™ product. Please take a few moments to register your product and provide us with information that will help Lenovo to better serve you in the future. Your feedback is valuable to us in developing products and services that are important to you, as well as in developing better ways to communicate with you. Register your option on the Lenovo Web site at:

[www.lenovo.com/register](http://www.lenovo.com/register)

Lenovo will send you information and updates on your registered product unless you indicate on the Web site questionnaire that you do not want to receive further information.



---

# Chapter 1. USB 2.0 Super Multi-Burner Drive

This chapter contains instructions for installing the Lenovo USB 2.0 Super Multi-Burner Drive.

---

## Product description

The USB 2.0 Super Multi-Burner Drive is a slimline DVD and CD recordable drive that attaches quickly and conveniently to your computer through a simple connection. This drive conforms with industry standard specifications for DVD-RAM, DVD-RW, DVD-R, DVD+RW, DVD+R, DVD-R (dual layer), DVD+R (double layer), CD-RW, and CD-R media. The drive is a USB 2.0 device and requires connection to two USB 2.0 ports. For more information on write and read speeds, go to Appendix A, "Product specifications," on page A-1.

**Note:** This device is intended for use only with UL Listed host computers when powered by the USB bus.

**Note:** The drive is capable of writing up to 5x DVD RAM and 4x DVD+RW Media. Higher speeds are supported in "read-only" mode.

The option package includes:

- USB 2.0 Super Multi-Burner Drive

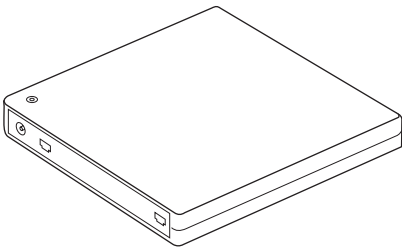

- 2 Standard USB cables

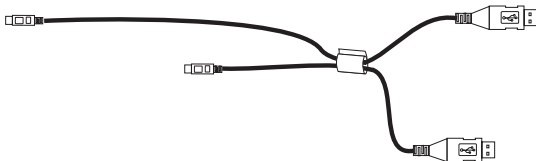

- AC adapter

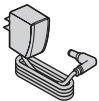

United States, Canada, Latin America, and Japan

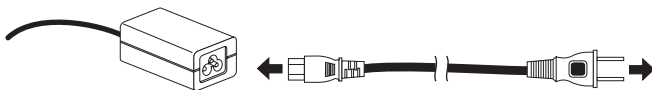

All other countries

- *USB 2.0 Super Multi-Burner Drive Software and Guide Super CD*



- USB 2.0 Super Multi-Burner Quick Installation Guide (one)



- Safety Information Manuals (two)



- Carrying case

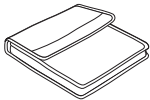

Contact your place of purchase if an item is missing or damaged. Be sure to retain your proof of purchase and packing material. They might be required to receive warranty service.

---

## Application software

Your *USB 2.0 Super Multi-Burner Software and User's Guide Super CD* contains the following software:

- **Intervideo WinDVD Creator Plus**

This software enables you to record video files to DVD-RW or DVD-R media that can be played in most stand-alone DVD players. You can also use this software to edit and modify your own video assets prior to recording. If you have an analog or IEEE 1394 capture device installed in your computer, you can use this software to record video from a camera.

Computer part	Minimum	Optimal
Processor	Intel Celeron 800MHz	Intel Pentium® III 600MHz  Direct DVD support requires P4 1.6GHz or higher for real-time requirement
RAM	64MB	128MB
Operating system	Windows 2000 or Windows XP	Windows 2000 or Windows XP
Sound	Windows-compatible sound card that supports 48KHz playback	Windows-compatible sound card that supports 48KHz playback (PCI recommended)
Video	Windows-compatible AGP or PCI graphic card	Windows-compatible AGP or PCI graphic card (overlay support recommended)
Hard drive	<ul style="list-style-type: none"><li>• 70 MB for installation</li><li>• 620 MB for every hour of VCD-quality MPEG-1 video</li><li>• 2 GB for every hour of DVD-quality MPEG-2 video</li></ul>	<ul style="list-style-type: none"><li>• 70 MB for installation</li><li>• 620 MB for every hour of VCD-quality MPEG-1 video</li><li>• 2 GB for every hour of DVD-quality MPEG-2 video</li></ul>



Computer part	Minimum	Optimal
Others		CD or DVD burner required for VCD and DVD burning. Appropriate hardware needed to import video from external sources, such as DV cameras and camcorders

**Note:** WinDVD Creator Plus can import and export DivX content with the DivX codec pre-installed. DivX is a trademark of DivX Networks, Inc.

- **Direct-to-Disc**

This software enables you to write directly to CD-RW, CD-R, DVD-RAM, DVD-RW, and DVD-R media using the drive letter like you would if you were writing to a diskette. All disc format types can be formatted by Direct-to-disc. With Direct-to-disc, you can drag-and-drop files, create new directories, or save files from any application directly to your USB 2.0 Super Multi-Burner. Direct-to-Disc is installed automatically as part of the Multimedia Center for Think Offerings.

- **UDF reader**

This software enables you to use DVD-RAM, DVD-RW, and CD-RW media on computers with DVD drives. It also allows you to read Direct-to-disc-created discs on systems without Direct-to-disc installed.

- **Multimedia Center for Think Offerings**

Multimedia Center for Think Offerings is a disc mastering software that allows you to create your own music or data discs from files on your computer, or from other disc media such as CDs or DVDs. Music discs created with Multimedia Center for Think Offerings, will play on any CD player, whether it's at home, in your car, or through your computer's CD-ROM. Multimedia Center for Think Offerings also makes it easy to create data discs that can be read on any appropriate CD or DVD disc reader.

**Note:** Some DVD players cannot read CD-R media. Refer to the documentation that accompanied your drive for information on supported media.

Multimedia Center for Think Offerings guides you, step-by-step, through the recording process with simple Wizards and an intuitive user-interface.

Using Multimedia Center for Think Offerings you can create:

- Exact copies of existing discs - The Exact Copy feature makes a duplicate of your master disc, transferring the disc layout of the original disc to your CD-R, CD-RW, or DVD media.
- Discs of archived data from your hard drive – The Make a Data Disc feature is used to store electronic data, such as the files and applications that reside on your computer's hard drive. Unlike music discs, data discs are used to store files that are readable only by a computer, and cannot be played on your home or car stereo—even if audio files are on the disc.
- Music compilations from WAV, MP3, or WMA files, or from existing music discs – The Make a Music Disc feature creates custom music discs from files on your hard drive or your existing music discs. The CD music database feature can automatically tag your files with track information to help you sort through your collection.

**Note:** Please reference the Multimedia Center for Think Offerings On-line Help, for more information on how to Make an Exact copy, Create a Data Disc, or to Create an Audio disc with Multimedia Center for Think Offerings.

To start Multimedia Center for Think Offerings, complete the following procedure:

1. Click **Start**.
2. Click **Programs**.
3. Click **Multimedia Center for Think Offerings** to open the main recording software window.

- **Intervideo WinDVD**

This software enables you to play back DVD videos on your computer or to play video files from your hard disk drive.

**Note:** Some graphics adapters such as the FIREGL, Intergraph, and 3dLabs, do not support DVD video playback.

---

## Hardware and software requirements

You must have the following hardware installed on your host computer in order to use this option:

- One or two available USB 2.0 ports

Your computer must have one of the following operating systems installed to use this option:

- Microsoft® Windows® XP
- Microsoft Windows 2000 Professional (Service Pack 4 or later)

**Note:** The drive will not operate correctly unless Service Pack 4 or later is installed.

---

## Preparing to use the USB 2.0 Super Multi-Burner Drive

Before using the USB 2.0 Super Multi-Burner Drive, follow the procedure below:

1. Make sure the USB 2.0 Super Multi-Burner Drive is properly connected to your host computer.
2. Check the locations of the functions on the USB 2.0 Super Multi-Burner Drive (refer to the figures below).
3. Insert the *USB 2.0 Super Multi-Burner Drive Software and User's Guide Super CD* that was shipped with this option to install the CD-R/CD-RW/DVD writing software.
4. Double-click on the application you want and follow the instructions on the screen.
5. Check that the drive operates normally and keep the enclosed warranty in a safe place after filling it in.

Following are the locations of the functions on the host USB 2.0 Super Multi-Burner Drive:

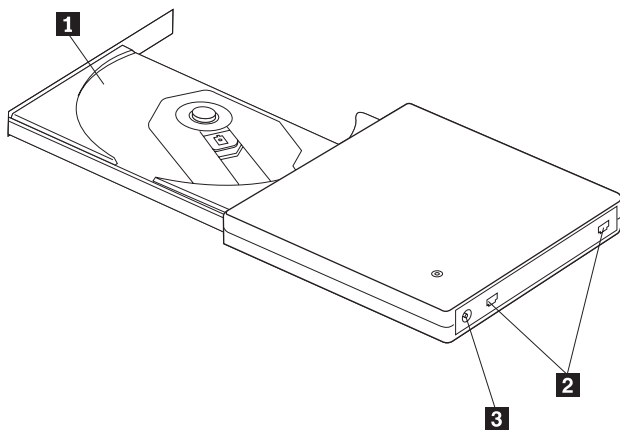

**1** Disc tray

Firmly seat the media with the label face up on the disc tray.

**Attention:** Push the CD/DVD media down until it clicks and is secure in the center.

**2** USB connectors

Insert the plug of the provided dedicated USB cable.

**3** DC IN connector

Connect the provided AC adapter into the DC IN connector.

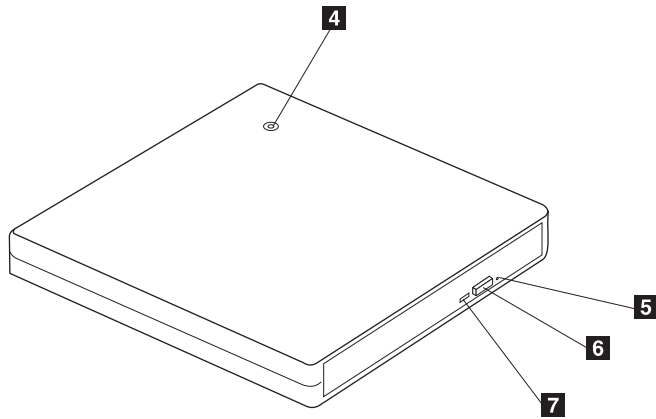

**4** Power indicator

The green LED indicates the power status and the operation states of the drive.

- **LED is on:** when the drive is connected in any of the supported power configurations and the USB port of your computer.
- **LED is off:** when the drive is not connected to the USB port.

**5** Emergency eject

When ejecting the media with the power off, insert paper clip into the emergency eject hole to open the disc tray.

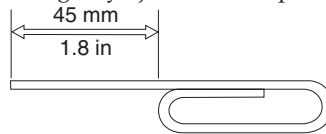

**6** Eject button

**Attention:** Be sure the power is off when using the emergency eject. Use the eject button instead of the emergency eject except in an emergency. Press this button to open the disc tray.

**Attention:** An electrical locking mechanism is used in this drive so that an erroneous operation does not open the disc tray during write. Make sure that the power is on and the drive is not in operation before pressing the eject button to open the disc tray.

If the disc tray cannot be opened even when the eject button is pressed or if the disc tray needs to be opened when power is not supplied from the AC adapter, use the emergency eject hole **5** in front of the drive.

Check that nothing is placed in front of the disc tray when ejecting. When normal ejection is impossible, an error message may appear on your computer. When ejection is not performed normally, open the disc tray manually and close it securely.

**7** Busy indicator

**LED blinks:** during data read or write.

## Power mode configurations

This section provides installation instructions for the following configurations:

- Configuration 1: Connecting the drive using self power with AC adapter (full operation)
- Configuration 2: Connecting the drive using USB standard bus power (limited speed operation)

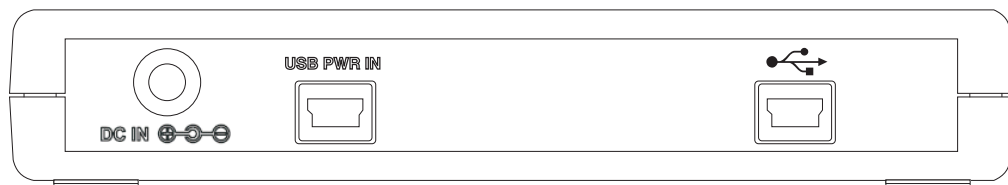

Refer to the diagram above when configuring your drive

### Configuration 1: Connecting the drive using self power with AC adapter (full operation)

This configuration is used when connecting to AC power (use adapter shipped with the drive).

#### Requirements

- One standard USB cable (shipped with this option).
- AC adapter (shipped with this option).

#### Specifications

Read and write CD and DVD media are supported.

#### Read speeds for Configuration 1

Media	Max Speed w/AC Adapter
DVD-ROM (Single layer)	8x CAV
DVD-R (4.7 GB)	8x
DVD+R	8x
CD-ROM	24x
CD-R	24x
CD-RW	20x
CD-DA (DAE)	20x CAV

#### Write speeds for Configuration 1

Media	Write speed w/ AC Adapter
DVD-R	8x ZCLV
DVD-RW	4x ZCLV
DVD+R	8x ZCLV
DVD+RW	4x ZCLV
DVD+RW	4x ZCLV
CD-R	24x ZCLV
CD-RW	16x ZCLV

**Note:** For more information refer to Appendix A, "Product specifications," on page A-1.

To connect the USB 2.0 Super Multi-Burner Drive to your system using self power with AC adapters, do the following:

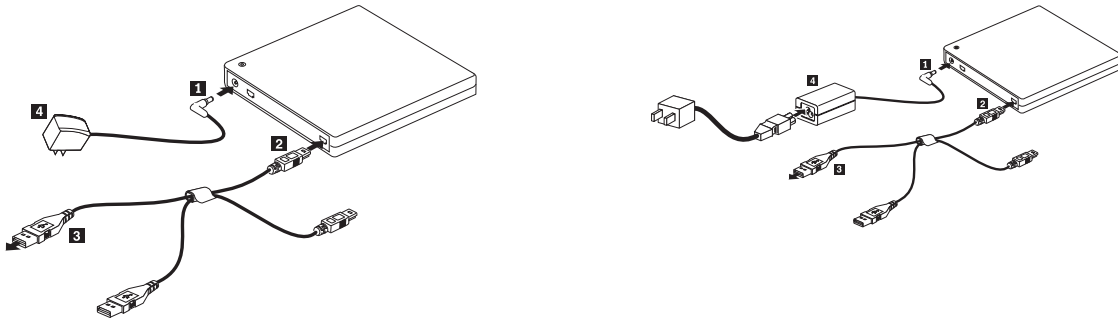



Figure 1-1. Configuration 1: self power (AC adapter) configuration

**Note:** The illustration on the left applies to US/Canada/Latin America/Japan.

**Note:** The illustration on the right applies to all other countries.

1. Turn on your computer.
2. Using the USB cable, insert the cable plug **2** into the USB connector  of the drive. Plug the power supply **4** into an outlet.
3. Connect the AC adapter to the DC IN connector **1** on the USB 2.0 Super Multi-Burner Drive.
4. Plug the standard USB connector **3** into the USB port of your computer.

## Configuration 2: Connecting the drive using standard USB bus power (Limited Speed Operation)

### Requirements

- Two Standard USB cables (shipped with this option).
- Two free USB ports available on your system.

### Specifications

Read and write of CD and DVD media are supported.

#### Read speeds for Configuration 2

Media	Max speed with USB Standard Bus Power
DVD-ROM (Single layer)	4x CAV
DVD-R (4.7 GB)	4x
DVD+R	4x
CD-ROM	10x
CD-R	10x
CD-RW	10x
CD-DA (DAE)	10x CAV

## Write speeds for Configuration 2

Media	USB Standard Bus Power
DVD-R	2x CLV
DVD-RW	2x CLV
DVD+R	2.4x CLV
DVD+RW	2.4x CLV
CD-R	4x CLV
CD-RW	10x CLV

This configuration is used when connecting two standard USB ports on the host to the standard USB port

 and USB power **USB PWR IN** port on the drive.

Refer to the figure below during installation.

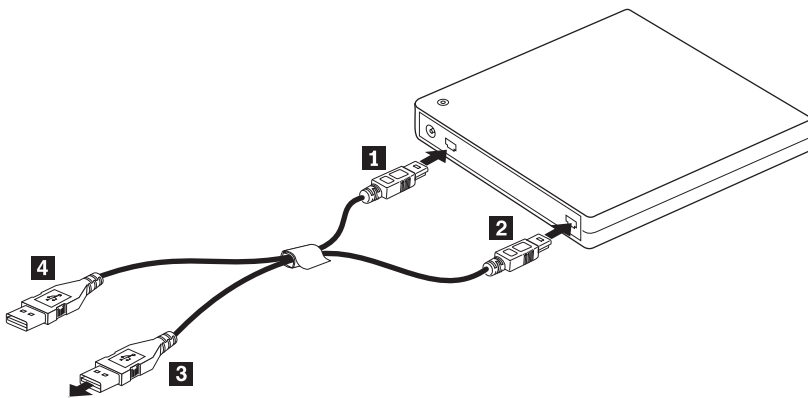

Figure 1-2. Configuration 2: USB standard bus power configuration

1. Turn on your computer.
2. Plug the standard USB connectors **3**, **4** into the USB port of your computer.
3. Using the USB cable, insert the cable plugs **1**, **2** into the USB connectors of the drive.

**Note:** Be sure that you connect cable plug **2** into the USB connector of the drive last.

---

## Chapter 2. Cabling the USB 2.0 Super Multi-Burner Drive to the host computer

The following diagrams may be helpful when cabling the USB 2.0 Super Multi-Burner Drive to your host computer. Please note that these diagrams might differ slightly from your hardware.

### Cabling using the AC power adapter

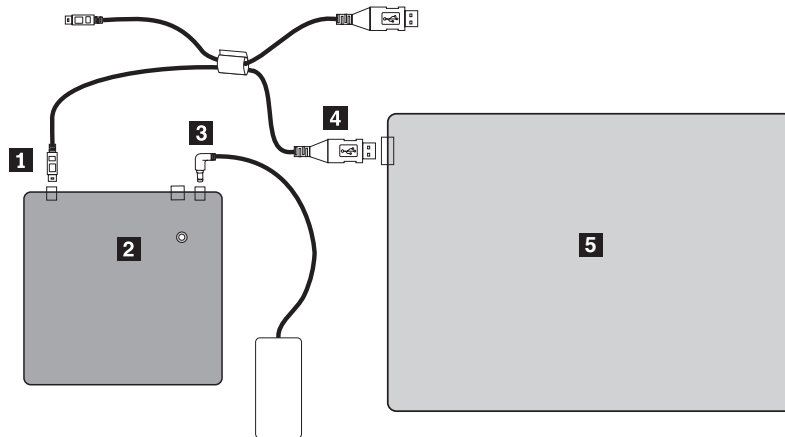

- 1** USB connector
- 2** USB 2.0 Super Multi-Burner Drive
- 3** AC adapter
- 4** Standard USB cable assembly
- 5** Typical ThinkPad computer

Figure 2-1. AC power adapter configuration

## Cabling the USB bus power

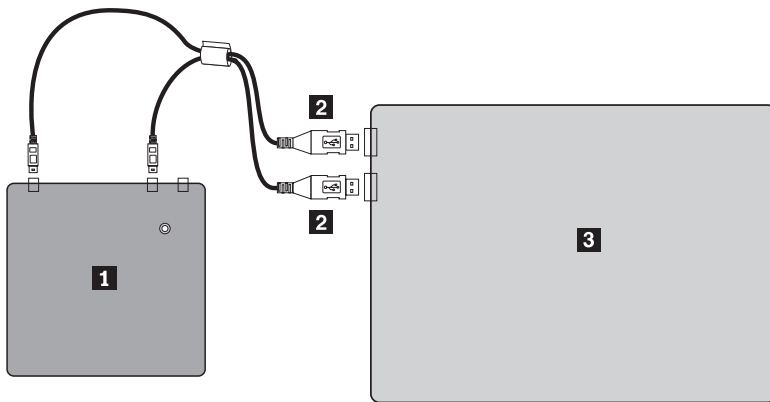

- 1** USB 2.0 Super Multi-Burner Drive
- 2** USB connectors
- 3** Typical ThinkPad computer

Figure 2-2. For typical cabling configuration

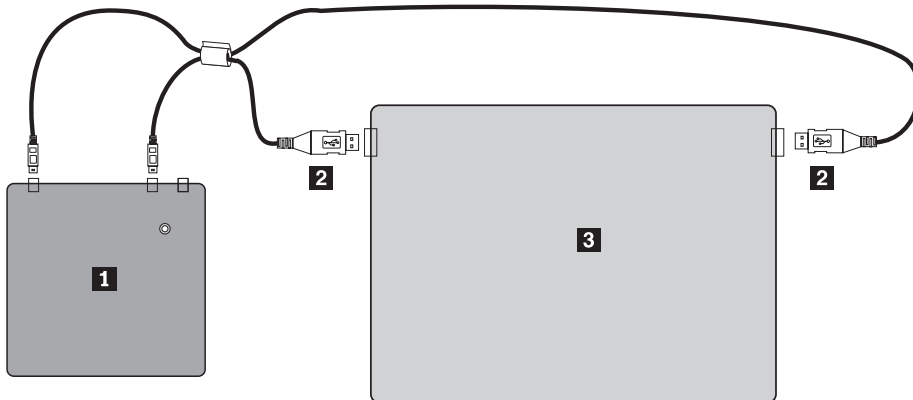

- 1** USB 2.0 Super Multi-Burner Drive
- 2** Standard USB cable assembly
- 3** ThinkPad Xseries computer

Figure 2-3. For cabling to a ThinkPad Xseries notebook computer



---

## Chapter 3. Features

The following list contains features of the **USB 2.0 Super Multi-Burner Drive**:

- **Easy connection**

Since this product incorporates the interface conforming to the USB 2.0 High Speed standard, it can be connected or disconnected to or from your computer easily even when the power of the computer is on. Docks and port replicators with AC power are supported.

- **Conformance to media manufactured by major media manufacturers**

This product is best tuned to almost all the CD and DVD media manufactured by major media manufacturers and the media written by this product realizes a very high write quality. Therefore, this drive can be used with little concern for compatibility issues.

- **Incorporation of the buffer underrun prevention function**

This product incorporates the buffer underrun prevention function which helps to prevent buffer underrun errors that cause a write failure onto the CD and DVD media.

- **Tray loading**

This product has a tray-loading mechanism that allows easy loading and ejection of a disc. The Tray can be opened manually or by using software that works with the computer.

- **Power configurations**

This drive operates with the following power configurations:

- **Full Operation**

When connected to AC power (use adapter shipped with the drive)

- **Limited Speed Operation**

When connected to two standard USB ports (use cable assembly with two standard USB connectors)



---

## Chapter 4. USB 2.0 Super Multi-Burner hardware installation and removal in Windows 2000 and Windows XP

Windows 2000 and Windows XP operating systems have the native drivers for the USB 2.0 Super Multi-Burner. Therefore, when this drive is connected, Windows will automatically install the appropriate driver and the drive will be ready to be used. You do not have to perform any special installation or removal procedures.

**Attention:**

- This drive will be recognized as "USB 2.0 Super Multi-Burner" by Windows Device Manager.
- In Windows 2000 operating systems, Service Pack 4 or later *must* be installed.

---

### Removing the USB 2.0 Super Multi-Burner hardware

"Hot plug" is supported for the connection between the USB cable and the computer; therefore you don't need to turn off the computer when you remove the USB 2.0 Super Multi-Burner. Follow the procedure below for removing the USB 2.0 Super Multi-Burner for Windows 2000 and Windows XP.

**Attention:**

Do not remove and reconnect the drive from or to the computer in rapid succession. The drive may not be recognized. Reconnect the drive approximately 20 seconds after removing.

Use the Tray icon for this procedure.

### Windows 2000

1. Exit the program that uses the drive.
2. Confirm that the Write indicator of the drive is off.
3. Click the **Remove** icon on the tray.



4. Select removing drive. In this case, select the drive name assigned to the drive (D: in this figure).



5. The Safe to Remove Hardware confirmation window appears. Click the **OK** button.

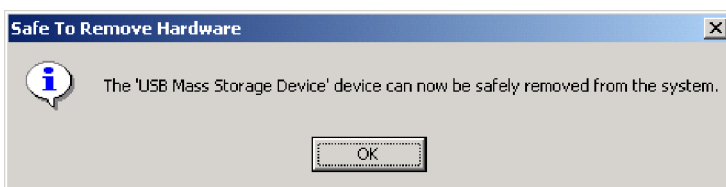

6. Remove the plug of the USB cable from the USB terminal of the computer.

**Note:** The message indicated above may differ depending on the versions of your operating system. Refer to the instruction manual for your computer or operating system for details.

## Windows XP

1. Exit the program that uses the drive.
2. Confirm that the Write indicator of the drive is off.
3. Click the **Remove** icon on the tray.



4. Select removing drive. In this case, select the drive name assigned to the drive (D: in this figure).



5. The Safe to Remove Hardware confirmation window appears. Click the **OK** button.

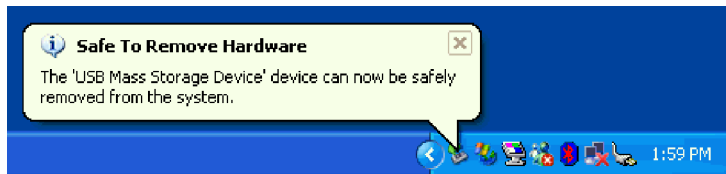

6. Remove the plug of the USB cable from the USB terminal of the computer.

**Note:** The message indicated above may differ depending on the versions of your operating system. Refer to the instruction manual for your computer or operating system for details.

---

## Setting the media

1. Press the eject button of the drive to open the disc tray.
2. Place the media on the tray with the label face upward. Align the center hole of the disc with the clamp at the center of the tray and fit the disc in securely by pressing the outer vicinity of the center hole.
3. Close the disc tray gently and press the tray in until it is completely locked.
4. When the disc tray is correctly closed, the media is recognized and made usable after the busy indicator blinks for some seconds.

---

## Ejecting the media

1. Press the eject button of the drive to automatically open the disc tray.
2. Lift the edge of the disc carefully from the tray while pressing the center section of the clamp.
3. Close the disc tray gently until the cover is completely closed. Check that the cover is securely locked.

---

## Chapter 5. Using the USB 2.0 Super Multi-Burner Drive

This section provides information on how to handle, load, and care for your media and your USB 2.0 Super Multi-Burner drive.

---

### Before you begin

For best results, review the following guidelines before using the drive:

- Do not move your host computer or drive while formatting or writing a disc as this might cause data errors. Also, minimize typing while formatting or writing to a disc, as this might also cause data errors.
- Keep the host computer and USB drive on a flat surface when writing to a disc.
- Turn screensavers off. Using a screensaver might interrupt the formatting and writing process.
- Do not put your Host computer into hibernation or suspend mode while writing to a disc.

**Note:** The read and write results of the drive depend upon the quality and characteristics of the DVD or CD media used.

### Caring for the USB 2.0 Super Multi-Burner drive

To protect your drive during operation, observe the following precautions:

- Remove the disc from the drive before moving the drive.
- Do not insert foreign objects into the drive.
- Do not stack objects on the drive.
- Do not remove the drive cover or attempt to service the drive.
- Do not push hard on the top of the drive.
- Do not operate the drive under any of the following conditions:
  - High temperature, high humidity, or direct sunlight
  - Excessive vibration, sudden shock, or inclined surface
  - Excessive dust

### Cleaning the drive

Wipe off soil on the drive using a soft cloth. If soil is persistent, use a cloth dampened with a diluted neutral detergent after squeezing all the water out. If liquid is allowed into the drive, it may cause a serious malfunction, an electric shock or a fire. When cleaning with liquid, be sure to remove the provided AC adapter from the wall outlet after disconnecting the drive from your computer.

Do not apply solvents such as benzene or thinner. Chemical cleaners for home or industrial use may damage the coating of the drive.

---

### Using Media

This section contains information on using the USB 2.0 Super Multi-Burner.

#### Handling and caring for a disc

Carefully handle and clean discs, especially writable media types such as CD-R and CD-RW discs, so that they remain readable. You can prolong the life of your discs by using the following precautions:

- Always store discs in their original packaging.
- Always store discs out of direct sunlight.

- Always store discs away from direct heat sources.
- Remove discs from the computer when not in use.
- Check discs for cracks BEFORE each use.

**IMPORTANT:** Do not use discs that are cracked.

- Do not force discs into the computer or packaging.
- Do not bend or flex discs.
- Do not use commercial cleaners to clean discs.
- Do not write on the surface of discs.
- Handle discs by the edges or the center hole.
- Do not touch the surface of discs.
- To remove dust or fingerprints, wipe discs from the center to the edge with a soft, lint-free cloth.

**Attention:** Wiping a disc using a circular motion can cause data loss.

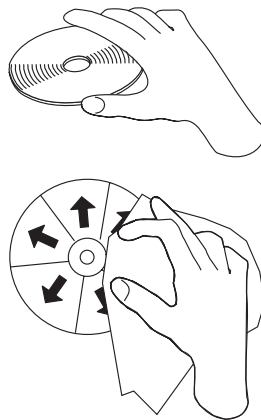

## Using DVD-RAM media

DVD-RAM media is available in single-sided and double-sided versions.

The 2.6 GB and 4.7 GB versions are single-sided. The 9.4 GB version is double-sided. To access the data on both sides of the media, you must remove the media from the drive, turn it over, and re-insert it into the drive. DVD-RAM media must be removed from the cartridge before using this drive.

## Using CDs and DVDs

Complete the following procedure to read a data disc:

1. Turn on the computer.
2. Press the **Eject** button on the front of the drive.
3. Insert a disc in the tray with the label facing up.
4. Close the drive by gently closing the disc tray.
5. Wait for the drive busy indicator to stop blinking and is continuously on.
6. Double-click the CD-ROM or DVD-RAM/DVD-R/DVD-RW icon.

## Using CD-Rs and CD-RWs

The host USB 2.0 Super Multi-Burner drive can write to both CD-R and CD-RW discs. CD-R discs cannot be erased, but can be used with standard CD-ROM drives and CD players.

You can use CD-R discs to record audio tracks, store data, archive files, and copy files from another CD.

CD-RW discs can be erased and rewritten, but can be used only with newer Multi-Read and CD-RW-compatible CD-ROM and DVD-ROM drives. You can use CD-RW discs to back up, store, and update files or to copy files from another CD.

**Notes:**

1. CD-R discs are playable on audio CD players. CD-RW discs are not playable on most audio CD players.
2. The software included with this drive does **not** enable the drive CD-recording capabilities with DOS, Windows 3.x, or OS/2<sup>®</sup> operating systems.
3. Ultra Speed CD-RW media writing is supported.

For more information on using the software, refer to the Multimedia Center for Think Offerings and Direct-to-disk help information on the *USB 2.0 Super Multi-Burner Software and User's Guide Super CD*.

## Using DVD-Rs, DVD+Rs, DVD+RWs and DVD-RWs

The USB 2.0 Super Multi-Burner drive can write to both DVD-R and DVD-RW discs. DVD-R discs cannot be erased, but can be used with standard DVD-ROM drives and DVD players.

You can use DVD-R discs to record audio tracks, store data, archive files, and copy files from another DVD. Double or dual layer media allows you to store up to 8.5GB.

DVD-RW discs can be erased and rewritten, but can be used only with newer Multi-Read and DVD-RW-compatible DVD-ROM drives. You can use DVD-RW discs to back up, store, and update files or to copy files from another DVD.

For more information on using the software, refer to the Multimedia Center for Think Offerings and Direct-to-disc help information on the *USB 2.0 Super Multi-Burner Software and User's Guide Super CD*.

---

## Installing Software

Once you have connected the USB 2.0 Super Multi-burner drive, you can install the application software from the USB 2.0 Super Multi-burner Drive User's Guide and Software CD. To do so, follow this procedure:

1. Insert the *USB 2.0 Super Multi-burner User's Guide and Software CD* into the Super Multi-burner drive.
2. The CD should automatically start. If it does, proceed to Step 5.
3. If the CD does not automatically start, click **Start** then **Run**.
4. In the Run box type `e:\launch.bat` where *e* is the drive letter of the USB 2.0 Combo drive.
5. If you get a warning from Internet Explorer about malicious scripts, right-click on the **warning bar** and select **Allow Blocked Content**.
6. Select **Software** from the left-hand navigator bar.
7. Check the boxes by the software applications that you wish to install.
8. Click **Go**. The software you selected will install instantly.
9. Reboot after the completion message.

**Note:** The UDF reader software is provided to allow other computers to read Direct-to-Disc discs made by the USB 2.0 Super Multi-burner. Do not install it into the same computer as the USB 2.0 Super Multi-burner.

**Note:** If the software fails to install silently, you can select interactive installs of individual packages from the bottom line on the installer page.

**Note:** Direct-to-disc is installed as part of the Multimedia Center for Think Offerings. It can be separately uninstalled if not needed.

---

## Using Direct-to-disc

Direct-to-disc is provided so that you can write data to CD-R, CD-RW, DVD-RAM, DVD-RW, and DVD-R media. DVD-RAM, DVD-RW, CD-RW, DVD-R, and CD-R media can be written to many times (data on DVD-R and CD-R media may be appended until these discs are full).

To format and write to DVD-R, CD-R, DVD-RAM, DVD-RW, or CD-RW media:

1. Insert a disc into the drive.
2. Double-click **My Computer**. Right-click the Host USB 2.0 Super Multi-Burner drive letter.
3. Click **Format**. Formatting time will vary depending on the format process you use (Quick or Full).
4. After formatting is complete, you can drag and drop files to the Host USB 2.0 Super Multi-Burner drive icon, or you can move files in Windows Explorer.

To make CD-R media compatible in other computers:

1. Double-click **My Computer**. Right-click the USB 2.0 Super Multi-Burner drive letter.
2. Click **Make Compatible**.

To use UDF formatted DVD-RAM, DVD-RW, or CD-RW media in other computers, a UDF reader is included on the *USB 2.0 Super Multi-Burner Software and User's Guide Super CD*. To use the UDF reader, follow this procedure:

1. Insert the *USB 2.0 Super Multi-Burner Software and User's Guide Super CD* into the CD or DVD drive of the computer you want to use the UDF formatted discs with.
2. Click **Start**.
3. Click **Run**.
4. Type `e:\UDF\language` where *e* is the drive letter of the USB 2.0 Super Multi-Burner drive, and language is your language.
5. Click **OK**.
6. Double-click **SETUP.EXE** and follow the on-screen instructions.

**Note:** The UDF reader is only needed on systems that do not have another Direct-to-disc program for CD-RW or DVD-RW installed.

---

## Using Intervideo WinDVD Creator Plus

With Intervideo WinDVD Creator Plus, you can capture, edit, and record video and audio files. You can also use Intervideo WinDVD Creator Plus to create and record DVD videos using your own video and audio files. For more detailed information on Intervideo's WinDVD Creator Plus features, go to the WinDVD Creator Plus User's Guide on the *USB 2.0 Super Multi-Burner Software and User's Guide Super CD*.

The main function areas within the WinDVD Creator Plus main window are "Capture," "Edit," "Author," and "Make Movie". From these functions, you can import and edit your own video and audio files, then save them into any supported format. The supported formats include MPEG-1, MPEG-2, ASF, WMV, and AVI. When you have prepared your video and audio files, by going through the "Capture" and "Edit" steps, you can then add a customized menu from within the "Author" function. You can import your own still images to use as menu backgrounds or select one of the sample images. When your movie is ready, proceed to "Make Movie" where you can select the output format and video standard used in creating your movie. Burn your movie to disc or save it to the hard disk for burning later. If you use WinDVD Creator Plus to create a DVD image on your hard disk, you can select "Load Image to Burn" from the Project menu.

WinDVD Creator Plus also offers the capability to record video directly to DVD recordable media using "Disk Manager." This is done without using any additional space on your hard disk. With Disk Manager,



you can capture new video or use video files you already have, and then finish your movie by creating a customized menu. Your movie can be created in either +VR or -VR video formats. Through Disk Manager, you can edit your movie at any time, adding or deleting video segments or changing your customized menu.

**Note:** Rendering large layouts can take several hours, depending on the processor power and hard disc speed of your host pc.

---

## Playing audio CD's

Use Windows Media Player or audio CD playback software such as Microsoft CD Player for playing back the audio CD using the drive. The operation method differs depending on the software and versions. Refer to the operation manual of your computer or software for details.

## Windows 2000

In the Windows Media player, you will find Digital Playback check box when you click the CD Audio tab in the Options window, as shown in the following figure.

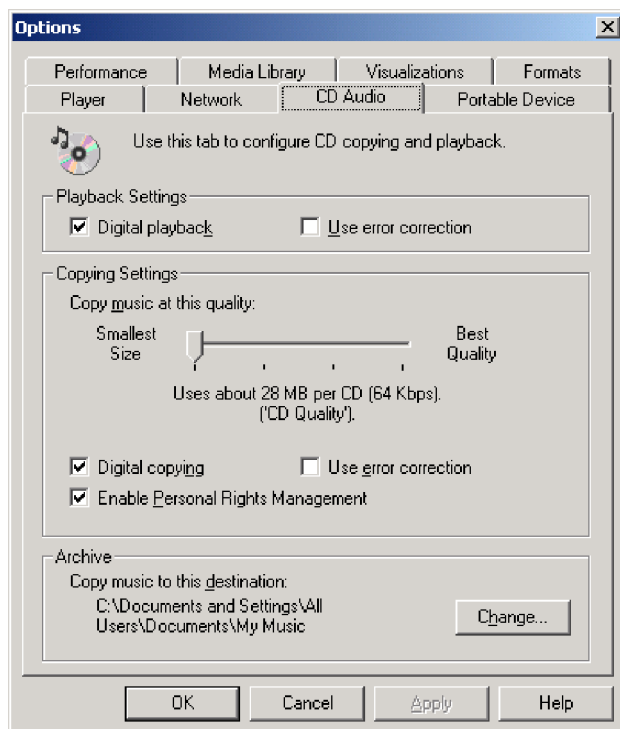

In addition, you will find the Enable digital audio for this CD-ROM device with this USB 2.0 Super Multi-Burner Drive check box, on the USB 2.0 Super Multi-Burner property on Device Manager, as shown in the figure below. When there is no setting item for the digital playback in your player software, try the above setting.

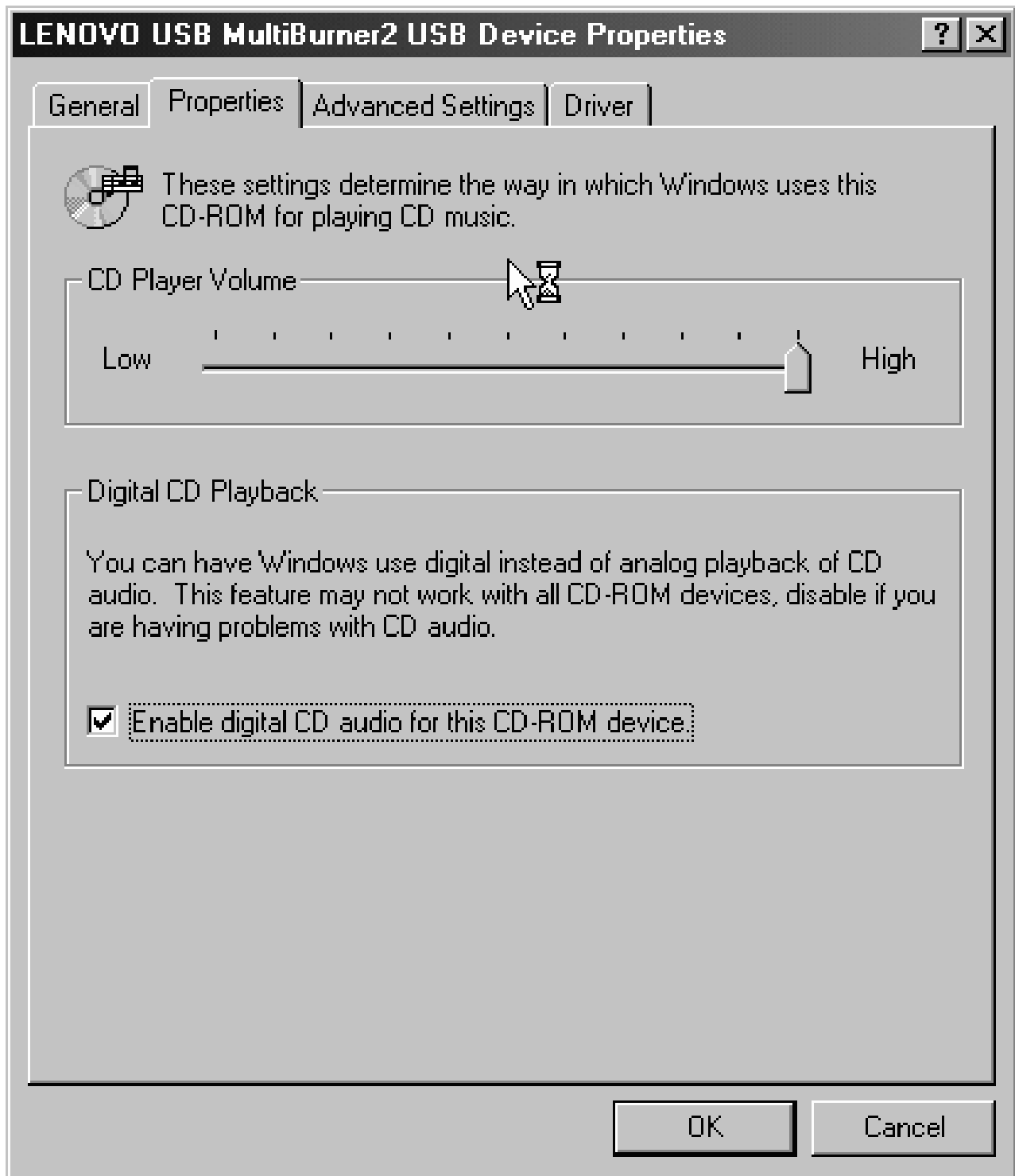

**Note:** The windows above may differ depending on the versions of your operating system. Refer to the instruction manual for your computer or operating system for details.

## Windows XP

In Windows Media Player, you will find Digital Playback check box when you click the CD Audio tab in the Properties window, as shown in the following figure.

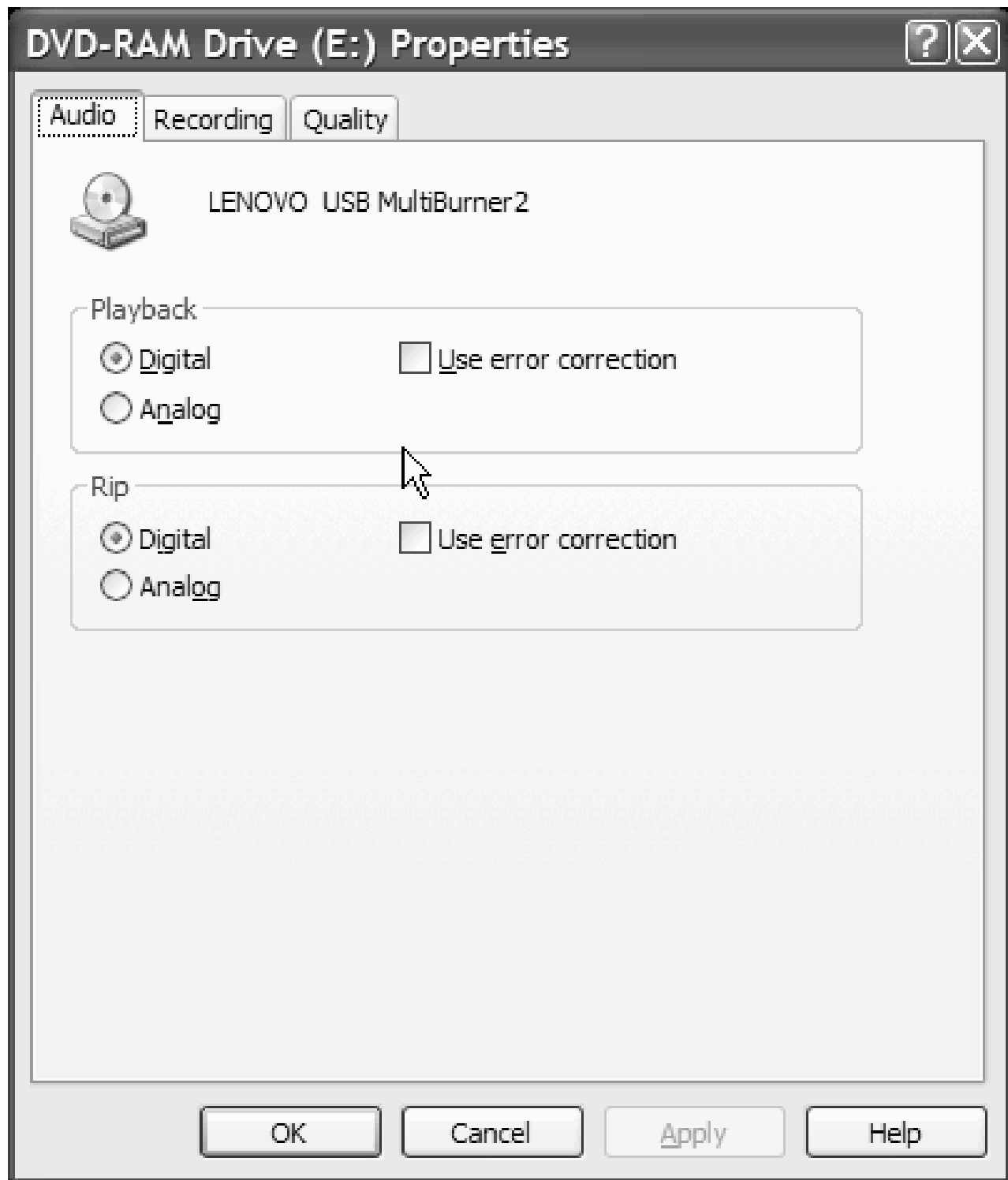

In addition, you will find the Enable Digital Music CD with this USB 2.0 Super Multi-Burner Drive check box on the USB 2.0 Super Multi-Burner property on Device Manager, as shown in the figure below. When there is no setting item for the digital playback in your player software, try the above setting.

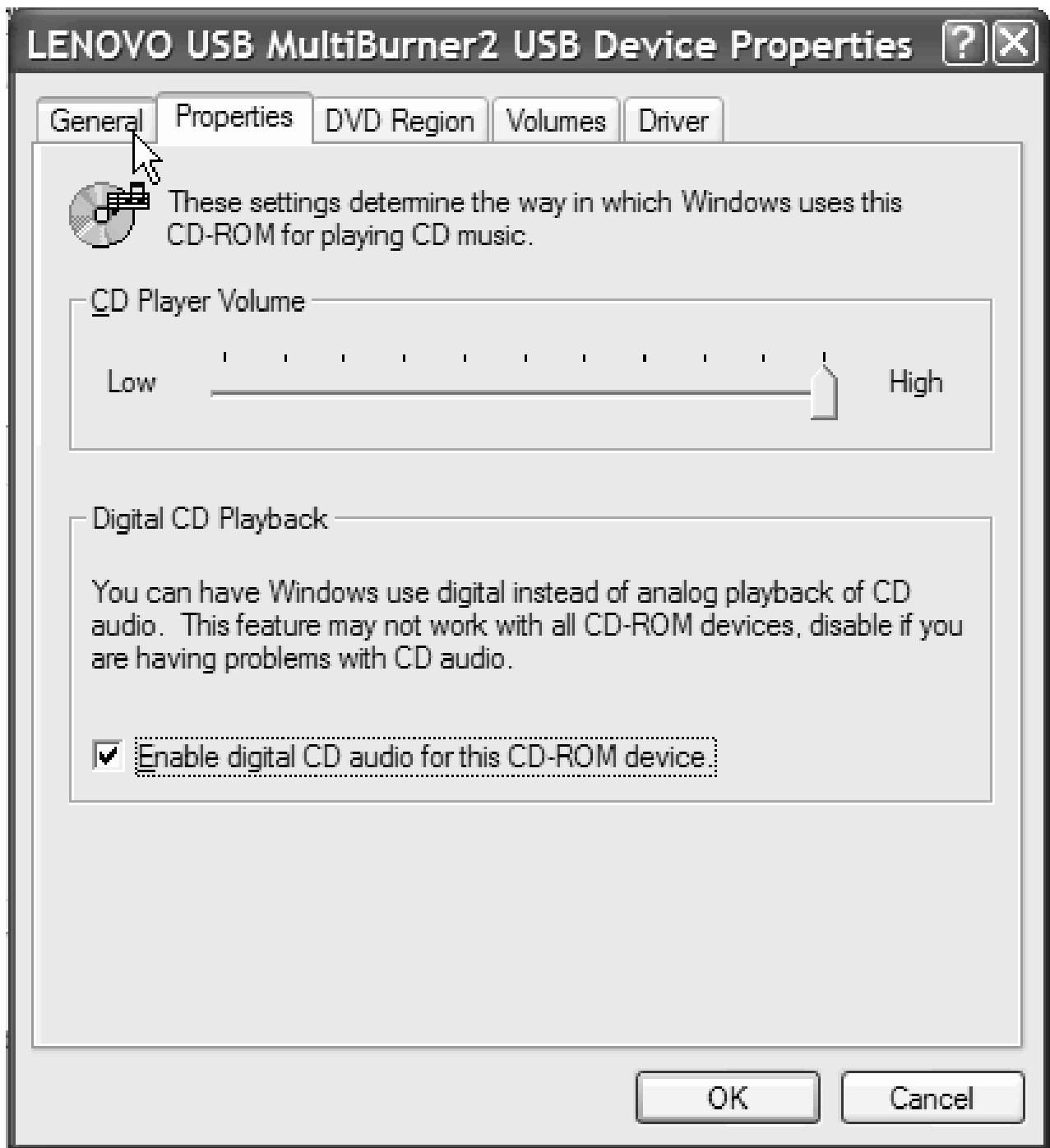

**Note:** The windows above may differ depending on the versions of your operating system. Refer to the instruction manual for your computer or operating system for details.

## Using WinDVD

After you install the Super Multi-burner drive and WinDVD software, you can view a DVD movie. Before viewing, you may need to update your operating system software and you may need to set the DVD region code.

## Operating system support

The prerequisites for WinDVD to work are Internet Explorer 5 and DirectX 8.1. These components are not present in all Microsoft Operating systems. This section lists steps that are required to update the different operating systems to allow DVD playback.

1. Windows Server 2003 and Windows Server 2000: You must install the latest service pack, Internet Explorer 5 and DirectX.
2. Windows 98 Second Edition and Windows Me: You must install DirectX.
3. Windows 2000: You must install service pack 4 or higher, and DirectX.

## DVD region codes

DVD region codes help protect the contents of a DVD. The world is divided into six regions and specific content can be viewed only in the appropriate region. For example, content for Region 1 can be viewed only in the U.S. and Canada. WinDVD is also region-specific.

You can verify the region code of the content by looking at the region code symbol on the back of the content packaging.

Region code	Region
1	U.S., Canada
2	Europe, Middle East, South Africa, Japan
3	Southeast Asia, Taiwan, Korea
4	Latin America, Australia, New Zealand
5	Former Soviet Union, North Africa, India
6	People's Republic of China

Start WinDVD by inserting the DVD into the drive. The region code is automatically set and you can view the movie. This is the initial setting.

After the region code has been set, if you insert a DVD with a different region code, you are prompted to change the region code. You can change the region code from your initial setting up to four times.

After the region code has been changed from its initial setting four times, it is fixed and can no longer be changed. Thereafter, you can play DVD content only from that region.

To display the region code status, click the **WinDVD Properties** button on the WinDVD user interface. The **General** tab contains this information.

To change the region code, do the following:

1. Turn on your computer and start your operating system.
2. Click **Start**.
3. Select **Programs**.
4. Click **Intervideo WinDVD**.
5. Click the **Properties** icon to open the **Properties** window.
6. Click the **General Properties** tab.
7. Insert a single region DVD of the new region.
8. Select the correct region code for your country.
9. Click **OK**.

## Starting WinDVD

To start WinDVD, complete the following procedure:

1. Click **Start**.
2. Click **Programs**.
3. Click **InterVideo WinDVD** to open the DVD movie player window.

For more information on how to play the DVD movie player, refer to the WinDVD help information on the *USB 2.0 Super Multi-Burner Software and User's Guide Super CD*. If you want to watch a DVD movie on your TV, refer to the online information provided with your computer.

### Notes:

1. Your computer has been configured to provide the highest quality audio and video playback obtainable with the available system resources. You can alter the default settings by changing the video resolution setting within the Control Panel. Some systems do not have enough resources to provide full-quality audio and video playback at all resolution settings. If you experience poor playback performance, adjust the resolution to a lower setting.
2. Audio or video streams are decoded by software. The audio and video subsystems need to be fully functional and enabled.

---

## Copying and imaging

You can use the Multimedia Center for Think Offerings to make copies and save images of your CDs and DVDs. You can also create CDs and DVDs from images that you have previously saved on your hard disk. The Multimedia Center can only save images in ISO and GI formats. ISO formats can only be used for data CDs. All other disc formats require GI images. Saved DVD images can be as large as 9GB, and CD images as large as 730MB. Ensure that you have adequate hard disk space before proceeding.

To make a CD or DVD image:

1. To start the Multimedia Center for Think Offerings.
2. Select the **Copy** page.
3. Select the task **Save Image to Hard Disk**.
4. Give your image file a name. A random name is created for you.
5. Insert the disc which you are imaging.
6. Press the **Record** button.

**Note:** Direct-to-disc CDs cannot be saved as image files.

**Note:** Copy protected commercial DVDs cannot be imaged or copied.

To burn previously saved image:

1. Start the Multimedia Center for Think Offerings.
2. Select the **Copy** page.
3. Select the task **Burn Image to CD or DVD**.
4. Explore to the image which you would like to burn.
5. Insert a blank or erasable disc.
6. Press the **Record** button.

To copy a disc:

1. Start the Multimedia Center for Think Offerings.
2. Select the **Copy** page.
3. Select the task **Copy a disc**.

4. Insert the disc which you are copying.
5. Press the **Record** button.

**Note:** Copy protected commercial DVDs cannot be copied.

**Note:** Copying or imaging discs without the copyright owner's permission can result in legal penalties. For more information on copyright law, consult your legal advisor.





---

## Chapter 6. Troubleshooting

Computer problems can be caused by hardware, software, or user error. The information in this section might be useful to help you solve problems or to gather helpful information you can pass on to a service technician. You might also need to refer to your computer, operating-system, or sound-adapter publications.

Review the following list for any problem descriptions that might fit your situation.

### **USB Super Multi-burner drive is not recognized by operating system or power indicator is not lit.**

1. Ensure that a USB signal cable goes from the host pc to the USB signal . Ensure that either the AC adapter is plugged in or a second USB cable goes to the host pc and the USB power end connector of the drive. Power indicator on the top of the drive should light up.
2. Ensure that all of the cables are seated properly and if used, the AC adapter is plugged into a powered outlet.

### **You cannot create a multi-session disc.**

Be sure that there is enough space left on the disc for another session. Writing a session requires lead-in and lead-out space (about 15 MB) in addition to the data that is recorded.

### **You cannot successfully write to a CD-R, CD-RW, DVD-R, DVD-RW, or DVD-RAM disc.**

Take the following actions:

1. Use AC adapter mode as shown in Configuration 1.
2. Verify that the process is not being interrupted by a screen saver, an antivirus program, an Internet or e-mail program, or other software. Disable the functions that might interrupt the write operation.

**Note:** Replace the disc if it is bad or scratched.

3. Verify that the hard disk has been defragmented.
4. Consult the hard disk drive manufacturer or vendor if an older hard disk drive is conducting a thermal recalibration during a write operation.
5. Disable the Windows Auto Insert Notify function on your CD-ROM and CD-RW drives
6. Remove the UDF Reader if installed by mistake on your computer, with the USB 2.0 Multi-burner drive.

### **You cannot eject a CD or DVD disc.** (See Emergency eject procedure on page 1-5).

Take the following actions after ensuring that the drive is not in the process of writing to a disc:

1. Eject the disc through software.
2. Use the Eject button.
3. Turn off the computer. Wait 45 seconds; then turn on the computer and try using the Eject button again.
4. If other methods do not work, use the emergency eject.

### **You cannot read from the CD or DVD disc after successfully writing to it.**

Take the following actions:

1. If you can read the CD or DVD disc in another CD or DVD player or you can see previous sessions, the directory information might be damaged on the volume, making it unreadable. To get ideas for troubleshooting, check the documentation that comes with the software.
2. You might have a damaged CD-R, CD-RW, DVD-R, DVD-RW, or DVD-RAM disc. Try a new disc or another brand of CD or DVD disc.
3. If you can read from a CD-RW, DVD-RW, or DVD-RAM disc in the writing drive, but not in another Multi-Read drive, be sure that a UDF Reader program is installed in the computer.
4. Avoid writing at the slower 1X speed unless required by your computer.
5. Use the AC adapter mode as shown in Configuration 1.

---

## Appendix A. Product specifications

This appendix includes the following information:

- Physical specifications
- Power requirements
- Environmental requirements
- Read speeds
- Write speeds

### Physical specifications

The physical specifications<sup>1</sup> of the drive are listed in the following table.

Physical specification	
Height	24 mm (0.9 in.)
Width	142 mm (5.6 in.)
Length	160 mm (6.3 in.)
Weight	Approx. 430 g (0.95 lb)

### Power requirements

The following table lists the power specifications by voltage level for the drive. The power specifications are measured at the drive power connector and are nominal values.

Power specifications	Voltage	Average	Maximum
AC/Aux Power	16Vdc	1000 mA	1200mA
USB Standard Bus Power	5Vdc	850mA	1300mA

### Environmental requirements

Specification	Operational	Nonoperational (storage by)	Nonoperational (Shipping)
Temperature	+5C to +35° C	-10C to +60C	-40C to +60C
Relative humidity	8% to 80%	5% to 95%	5% to 95%

### Read Speed

Media	Max Speed w/AC Adapter (Configuration 1)	Max speed with USB Standard Bus Power (Configuration 2)
DVD-ROM (Single layer)	8x CAV	4x CAV
DVD-ROM (Dual layer)	4x CAV	4x CAV
DVD-R (4.7 GB)	8x	4x
DVD-RW (4.7 GB)	4x	4x

---

1. Product-description data represents Lenovo's design objectives and is provided for comparative purposes; actual results might vary based on a variety of factors. This product data does not constitute a warranty. Data is subject to change without notice.

DVD-video	4x	4x
DVD-RAM (4.7/9.4 GB)	5x/3x ZCLV	5x/3x ZCLV
DVD-RAM (2.6 GB)	1x ZCLV	1x ZCLV
DVD+R	8x	4x
DVD+RW	4x	4x
CD-ROM	24x	10x
CD-R	24x	10x
CD-RW	20x	10x
CD-DA (DAE)	20x CAV	10x CAV
DVD-R DL	4X CAV	4X CAV
DVD+R DL	4X CAV	4X CAV

### Write Speed

Media	Write speed w/ AC Adapter (Configuration 1)	USB Standard Bus Power (Configuration 2)
DVD-R	8x ZCLV	2x CLV
DVD-R DL	2x CLV	2x CLV
DVD-RW	4x ZCLV	2x CLV
DVD-RAM (4.7/9.4G)	5x/3x/1x ZCLV	5x/3x/1x ZCLV
DVD+R	8x ZCLV	2.4x CLV
DVD+R DL	2.4x CLV	2.4x CLV
DVD+RW	4x ZCLV	2.4x CLV
CD-R	24x ZCLV	4x CLV
CD-RW	16x ZCLV	10x CLV

**Note:** Up to 5x DVD-RAM media. 12x RAM media is Read Only.

**Note:** Up to 4x DVD+RW media. 8x +RW media is Read Only.

---

## Appendix B. Service and Support

The following information describes the technical support that is available for your product, during the warranty period or throughout the life of the product. Refer to your Lenovo Statement of Limited Warranty for a full explanation of Lenovo warranty terms.

---

### Online technical support

Online technical support is available during the life of your product through the Lenovo Support Web site at <http://www.lenovo.com/think/support>.

During the warranty period, assistance for replacement or exchange of defective components is available. In addition, if your option is installed in a Lenovo computer, you might be entitled to service at your location. Your technical support representative can help you determine the best alternative.

---

### Telephone technical support

Installation and configuration support through the Customer Support Center will be withdrawn or made available for a fee, at Lenovo's discretion, 90 days after the option has been withdrawn from marketing. Additional support offerings, including step-by-step installation assistance, are available for a nominal fee.

To assist the technical support representative, have available as much of the following information as possible:

- Option name
- Option number
- Proof of purchase
- Computer manufacturer, model, serial number, and manual
- Exact wording of the error message (if any)
- Description of the problem
- Hardware and software configuration information for your system

If possible, be at your computer. Your technical support representative might want to walk you through the problem during the call.

For a list of Service and Support phone numbers, see "Worldwide telephone list" on page D-14. Phone numbers are subject to change without notice. For the most current phone numbers, go to <http://www.lenovo.com/think/support> and click **Support phone list**. If the number for your country or region is not listed, contact your reseller or Lenovo marketing representative.



---

## Appendix C. Notices

Lenovo may not offer the products, services, or features discussed in this document in all countries. Consult your local Lenovo representative for information on the products and services currently available in your area. Any reference to a Lenovo product, program, or service is not intended to state or imply that only that Lenovo product, program, or service may be used. Any functionally equivalent product, program, or service that does not infringe any Lenovo intellectual property right may be used instead. However, it is the user's responsibility to evaluate and verify the operation of any other product, program, or service.

Lenovo may have patents or pending patent applications covering subject matter described in this document. The furnishing of this document does not give you any license to these patents. You can send license inquiries, in writing, to:

*Lenovo (United States), Inc.  
500 Park Offices Drive, Hwy. 54  
Research Triangle Park, NC 27709  
U.S.A.  
Attention: Lenovo Director of Licensing*

LENOVO GROUP LTD. PROVIDES THIS PUBLICATION "AS IS" WITHOUT WARRANTY OF ANY KIND, EITHER EXPRESS OR IMPLIED, INCLUDING, BUT NOT LIMITED TO, THE IMPLIED WARRANTIES OF NON-INFRINGEMENT, MERCHANTABILITY OR FITNESS FOR A PARTICULAR PURPOSE. Some jurisdictions do not allow disclaimer of express or implied warranties in certain transactions, therefore, this statement may not apply to you.

This information could include technical inaccuracies or typographical errors. Changes are periodically made to the information herein; these changes will be incorporated in new editions of the publication. Lenovo may make improvements and/or changes in the product(s) and/or the program(s) described in this publication at any time without notice.

The products described in this document are not intended for use in implantation or other life support applications where malfunction may result in injury or death to persons. The information contained in this document does not affect or change Lenovo product specifications or warranties. Nothing in this document shall operate as an express or implied license or indemnity under the intellectual property rights of Lenovo or third parties. All information contained in this document was obtained in specific environments and is presented as an illustration. The result obtained in other operating environments may vary.

Lenovo may use or distribute any of the information you supply in any way it believes appropriate without incurring any obligation to you.

Any references in this publication to non-Lenovo Web sites are provided for convenience only and do not in any manner serve as an endorsement of those Web sites. The materials at those Web sites are not part of the materials for this Lenovo product, and use of those Web sites is at your own risk.

Any performance data contained herein was determined in a controlled environment. Therefore, the result obtained in other operating environments may vary significantly. Some measurements may have been made on development-level systems and there is no guarantee that these measurements will be the same on generally available systems. Furthermore, some measurements may have been estimated through extrapolation. Actual results may vary. Users of this document should verify the applicable data for their specific environment.

---

## Trademarks

The following terms are trademarks of Lenovo in the United States, other countries, or both:

- Lenovo
- Lenovo logo
- ThinkPad

IBM is a trademark of International Business Machines Corporation in the United States, other countries, or both, and is used under license.

Microsoft and Windows are trademarks of Microsoft Corporation in the United States, other countries, or both.

Intel and Pentium are trademarks of Intel Corporation in the United States, other countries, or both.

Other company, product, or service names may be trademarks or service marks of others.



---

# Appendix D. Lenovo Statement of Limited Warranty

LSOLW-00 05/2005

---

## Part 1 - General Terms

*This Statement of Limited Warranty includes Part 1 - General Terms, Part 2 - Country-unique Terms, and Part 3 - Warranty Information. The terms of Part 2 replace or modify those of Part 1. The warranties provided by Lenovo Group Limited or one of its subsidiaries (called "Lenovo") in this Statement of Limited Warranty apply only to Machines you purchase for your use, and not for resale. The term "Machine" means a Lenovo machine, its options, features, conversions, upgrades or peripheral products, or any combination of them. The term "Machine" does not include any software programs, whether pre-loaded with the Machine, installed subsequently or otherwise. **Nothing in this Statement of Limited Warranty affects any statutory rights of consumers that cannot be waived or limited by contract.***

### What this Warranty Covers

Lenovo warrants that each Machine 1) is free from defects in materials and workmanship and 2) conforms to Lenovo's Official Published Specifications ("Specifications") which are available on request. The warranty period for the Machine starts on the original date of installation and is specified in Part 3 - Warranty Information. The date on your invoice or sales receipt is the date of installation unless Lenovo or your reseller informs you otherwise. Unless Lenovo specifies otherwise, these warranties apply only in the country or region in which you purchased the Machine.

**THESE WARRANTIES ARE YOUR EXCLUSIVE WARRANTIES AND REPLACE ALL OTHER WARRANTIES OR CONDITIONS, EXPRESS OR IMPLIED, INCLUDING, BUT NOT LIMITED TO, THE IMPLIED WARRANTIES OR CONDITIONS OF MERCHANTABILITY AND FITNESS FOR A PARTICULAR PURPOSE. SOME STATES OR JURISDICTIONS DO NOT ALLOW THE EXCLUSION OF EXPRESS OR IMPLIED WARRANTIES, SO THE ABOVE EXCLUSION MAY NOT APPLY TO YOU. IN THAT EVENT, SUCH WARRANTIES ARE LIMITED IN DURATION TO THE WARRANTY PERIOD. NO WARRANTIES APPLY AFTER THAT PERIOD. SOME STATES OR JURISDICTIONS DO NOT ALLOW LIMITATIONS ON HOW LONG AN IMPLIED WARRANTY LASTS, SO THE ABOVE LIMITATION MAY NOT APPLY TO YOU.**

### What this Warranty Does not Cover

This warranty does not cover the following:

- any software programs, whether pre-loaded or shipped with the Machine, or installed subsequently;
- failure resulting from misuse, accident, modification, unsuitable physical or operating environment, or improper maintenance by you;
- failure caused by a product for which Lenovo is not responsible; and
- any non-Lenovo products, including those that Lenovo may procure and provide with or integrate into a Lenovo Machine at your request.

The warranty is voided by removal or alteration of identification labels on the Machine or its parts.

Lenovo does not warrant uninterrupted or error-free operation of a Machine.

Any technical or other support provided for a Machine under warranty, such as assistance with "how-to" questions and those regarding Machine set-up and installation, is provided **WITHOUT WARRANTIES OF ANY KIND.**

### How to Obtain Warranty Service

Warranty service may be provided by Lenovo, IBM, your reseller if authorized to perform warranty service, or an authorized warranty service provider. Each of them is referred to as a "Service Provider."

If the Machine does not function as warranted during the warranty period, contact a Service Provider. If you do not register the Machine with Lenovo, you may be required to present proof of purchase as evidence of your entitlement to warranty service.

### **What Lenovo Will Do to Correct Problems**

When you contact a Service Provider for service, you must follow the problem determination and resolution procedures that we specify. An initial diagnosis of your problem can be made either by a technician over the telephone or electronically by access to a support website.

The type of warranty service applicable to your Machine is specified in Part 3 - Warranty Information.

You are responsible for downloading and installing designated software updates from a support web site or from other electronic media, and following the instructions that your Service Provider provides. Software updates may include basic input/output system code (called "BIOS"), utility programs, device drivers, and other software updates.

If your problem can be resolved with a Customer Replaceable Unit ("CRU") (e.g., keyboard, mouse, speaker, memory, hard disk drive), your Service Provider will ship the CRU to you for you to install.

If the Machine does not function as warranted during the warranty period and your problem cannot be resolved over the telephone or electronically, through your application of software updates, or with a CRU, your Service Provider, will either, at its discretion, 1) repair it to make it function as warranted, or 2) replace it with one that is at least functionally equivalent. If your Service Provider is unable to do either, you may return the Machine to your place of purchase and your money will be refunded.

As part of the warranty service, your Service Provider may also install selected engineering changes that apply to the Machine.

### **Exchange of a Machine or Part**

When the warranty service involves the exchange of a Machine or part, the item your Service Provider replaces becomes Lenovo's property and the replacement becomes yours. You represent that all removed items are genuine and unaltered. The replacement may not be new, but will be in good working order and at least functionally equivalent to the item replaced. The replacement assumes the warranty service status of the replaced item.

### **Your Additional Responsibilities**

Before your Service Provider exchanges a Machine or part, you agree to remove all features, parts, options, alterations, and attachments not under warranty service.

You also agree to:

1. ensure that the Machine is free of any legal obligations or restrictions that prevent its exchange;
2. obtain authorization from the owner to have your Service Provider service a Machine that you do not own; and
3. where applicable, before service is provided:
  - a. follow the service request procedures that your Service Provider provides;
  - b. backup or secure all programs, data, and funds contained in the Machine; and
  - c. provide your Service Provider with sufficient, free, and safe access to your facilities to permit Lenovo to fulfill its obligations.
4. (a) ensure all information about identified or identifiable individuals (Personal Data) is deleted from the Machine (to the extent technically possible), (b) allow your Service Provider or a supplier to process on your behalf any remaining Personal Data as your Service Provider considers necessary to fulfill its obligations under this Statement of Limited Warranty (which may include shipping the Machine for such processing to other service locations around the world), and (c) ensure that such processing complies with any laws applicable to such Personal Data.

### **Limitation of Liability**

Lenovo is responsible for loss of, or damage to, your Machine only while it is 1) in your Service Provider's possession or 2) in transit in those cases where Lenovo is responsible for the transportation charges.

Neither Lenovo nor your Service Provider are responsible for any of your confidential, proprietary or personal information contained in a Machine which you return for any reason. You should remove all such information from the Machine prior to its return.

Circumstances may arise where, because of a default on Lenovo's part or other liability, you are entitled to recover damages from Lenovo. In each such instance, regardless of the basis on which you are entitled to claim damages from Lenovo (including fundamental breach, negligence, misrepresentation, or other contract or tort claim), except for any liability that cannot be waived or limited by applicable laws, Lenovo is liable for no more than

1. damages for bodily injury (including death) and damage to real property and tangible personal property for which Lenovo is legally liable; and
2. the amount of any other actual direct damages, up to the charges for the Machine that is subject of the claim.

This limit also applies to Lenovo's suppliers, resellers and your Service Provider. It is the maximum for which Lenovo, its suppliers, resellers, and your Service Provider are collectively responsible.

**UNDER NO CIRCUMSTANCES IS LENOVO, ITS SUPPLIERS, RESELLERS OR SERVICE PROVIDERS LIABLE FOR ANY OF THE FOLLOWING EVEN IF INFORMED OF THEIR POSSIBILITY: 1) THIRD PARTY CLAIMS AGAINST YOU FOR DAMAGES (OTHER THAN THOSE UNDER THE FIRST ITEM LISTED ABOVE); 2) LOSS OF, OR DAMAGE TO, DATA; 3) SPECIAL, INCIDENTAL, OR INDIRECT DAMAGES OR FOR ANY ECONOMIC CONSEQUENTIAL DAMAGES; OR 4) LOST PROFITS, BUSINESS REVENUE, GOODWILL OR ANTICIPATED SAVINGS. SOME STATES OR JURISDICTIONS DO NOT ALLOW THE EXCLUSION OR LIMITATION OF INCIDENTAL OR CONSEQUENTIAL DAMAGES, SO THE ABOVE LIMITATION OR EXCLUSION MAY NOT APPLY TO YOU.**

### **Governing Law**

Both you and Lenovo consent to the application of the laws of the country in which you acquired the Machine to govern, interpret, and enforce all of your and Lenovo's rights, duties, and obligations arising from, or relating in any manner to, the subject matter of this Statement of Limited Warranty, without regard to conflict of law principles.

**THESE WARRANTIES GIVE YOU SPECIFIC LEGAL RIGHTS AND YOU MAY ALSO HAVE OTHER RIGHTS WHICH VARY FROM STATE TO STATE OR JURISDICTION TO JURISDICTION.**

### **Jurisdiction**

All of our rights, duties, and obligations are subject to the courts of the country in which you acquired the Machine.

---

## **Part 2 - Country-unique Terms**

### **AMERICAS**

#### **ARGENTINA**

**Jurisdiction:** *The following is added after the first sentence:*

Any litigation arising from this Statement of Limited Warranty will be settled exclusively by the Ordinary Commercial Court of the city of Buenos Aires.

## **BOLIVIA**

**Jurisdiction:** *The following is added after the first sentence:*

Any litigation arising from this Statement of Limited Warranty will be settled exclusively by the courts of the city of La Paz.

## **BRAZIL**

**Jurisdiction:** *The following is added after the first sentence:*

Any litigation arising from this Statement of Limited Warranty will be settled exclusively by the court of Rio de Janeiro, RJ.

## **CHILE**

**Jurisdiction:** *The following is added after the first sentence:*

Any litigation arising from this Statement of Limited Warranty will be settled exclusively by the Civil Courts of Justice of Santiago.

## **COLOMBIA**

**Jurisdiction:** *The following is added after the first sentence:*

Any litigation arising from this Statement of Limited Warranty will be settled exclusively by the Judges of the Republic of Colombia.

## **ECUADOR**

**Jurisdiction:** *The following is added after the first sentence:*

Any litigation arising from this Statement of Limited Warranty will be settled exclusively by the Judges of Quito.

## **MEXICO**

**Jurisdiction:** *The following is added after the first sentence:*

Any litigation arising from this Statement of Limited Warranty will be settled exclusively by the Federal Courts of Mexico City, Federal District.

## **PARAGUAY**

**Jurisdiction:** *The following is added after the first sentence:*

Any litigation arising from this Statement of Limited Warranty will be settled exclusively by the courts of the city of Asuncion.

## **PERU**

**Jurisdiction:** *The following is added after the first sentence:*

Any litigation arising from this Statement of Limited Warranty will be settled exclusively by the Judges and Tribunals of the Judicial District of Lima, Cercado.

**Limitation of Liability:** *The following is added at the end of this section:*

In accordance with Article 1328 of the Peruvian Civil Code the limitations and exclusions specified in this section will not apply to damages caused by Lenovo's willful misconduct ("dolo") or gross negligence ("culpa inexcusable").

## **URUGUAY**

**Jurisdiction:** *The following is added after the first sentence:*

Any litigation arising from this Statement of Limited Warranty will be settled exclusively by the City of Montevideo Court's Jurisdiction.

## **VENEZUELA**

**Jurisdiction:** *The following is added after the first sentence:*

Any litigation arising from this Statement of Limited Warranty will be settled exclusively by the Courts of the Metropolitan Area Of the City of Caracas.

## **NORTH AMERICA**

**How to Obtain Warranty Service:** *The following is added to this Section:*

To obtain warranty service from IBM service in Canada or the United States, call 1-800-IBM-SERV (426-7378).

#### **CANADA**

**Limitation of Liability:** *The following replaces item 1 of this section:*

1. damages for bodily injury (including death) or physical harm to real property and tangible personal property caused by Lenovo's negligence; and

**Governing Law:** *The following replaces "laws of the country in which you acquired the Machine" in the first sentence:*

laws in the Province of Ontario.

#### **UNITED STATES**

**Governing Law:** *The following replaces "laws of the country in which you acquired the Machine" in the first sentence:*

laws of the State of New York.

#### **ASIA PACIFIC**

##### **AUSTRALIA**

**What this Warranty Covers:** *The following paragraph is added to this section:*

The warranties specified in this Section are in addition to any rights you may have under the Trade Practices Act 1974 or other similar legislation and are only limited to the extent permitted by the applicable legislation.

**Limitation of Liability:** *The following is added to this section:*

Where Lenovo is in breach of a condition or warranty implied by the Trade Practices Act 1974 or other similar legislation, Lenovo's liability is limited to the repair or replacement of the goods or the supply of equivalent goods. Where that condition or warranty relates to right to sell, quiet possession or clear title, or the goods are of a kind ordinarily acquired for personal, domestic or household use or consumption, then none of the limitations in this paragraph apply.

**Governing Law:** *The following replaces "laws of the country in which you acquired the Machine" in the first sentence:*

laws of the State or Territory.

##### **CAMBODIA AND LAOS**

**Governing Law:** *The following replaces "laws of the country in which you acquired the Machine" in the first sentence:*

laws of the State of New York, United States of America.

##### **CAMBODIA, INDONESIA, AND LAOS**

**Arbitration:** *The following is added under this heading:*

Disputes arising out of or in connection with this Statement of Limited Warranty shall be finally settled by arbitration which shall be held in Singapore in accordance with the Arbitration Rules of Singapore International Arbitration Center ("SIAC Rules") then in effect. The arbitration award shall be final and binding for the parties without appeal and shall be in writing and set forth the findings of fact and the conclusions of law.

The number of arbitrators shall be three, with each side to the dispute being entitled to appoint one arbitrator. The two arbitrators appointed by the parties shall appoint a third arbitrator who shall act as chairman of the proceedings. Vacancies in the post of chairman shall be filled by the president of the SIAC. Other vacancies shall be filled by the respective nominating party. Proceedings shall continue from the stage they were at when the vacancy occurred.

If one of the parties refuses or otherwise fails to appoint an arbitrator within 30 days of the date the other party appoints its, the first appointed arbitrator shall be the sole arbitrator, provided that the arbitrator was validly and properly appointed.

All proceedings shall be conducted, including all documents presented in such proceedings, in the English language. The English language version of this Statement of Limited Warranty prevails over any other language version.

#### **HONG KONG S.A.R. OF CHINA AND MACAU S.A.R. OF CHINA**

**Governing Law:** *The following replaces "laws of the country in which you acquired the Machine" in the first sentence:*

laws of Hong Kong Special Administrative Region of China.

#### **INDIA**

**Limitation of Liability:** *The following replaces items 1 and 2 of this section:*

1. liability for bodily injury (including death) or damage to real property and tangible personal property will be limited to that caused by Lenovo's negligence; and
2. as to any other actual damage arising in any situation involving nonperformance by Lenovo pursuant to, or in any way related to the subject of this Statement of Limited Warranty, the charge paid by you for the individual Machine that is the subject of the claim.

**Arbitration:** *The following is added under this heading*

Disputes arising out of or in connection with this Statement of Limited Warranty shall be finally settled by arbitration which shall be held in Bangalore, India in accordance with the laws of India then in effect. The arbitration award shall be final and binding for the parties without appeal and shall be in writing and set forth the findings of fact and the conclusions of law.

The number of arbitrators shall be three, with each side to the dispute being entitled to appoint one arbitrator. The two arbitrators appointed by the parties shall appoint a third arbitrator who shall act as chairman of the proceedings. Vacancies in the post of chairman shall be filled by the president of the Bar Council of India. Other vacancies shall be filled by the respective nominating party. Proceedings shall continue from the stage they were at when the vacancy occurred.

If one of the parties refuses or otherwise fails to appoint an arbitrator within 30 days of the date the other party appoints its, the first appointed arbitrator shall be the sole arbitrator, provided that the arbitrator was validly and properly appointed.

All proceedings shall be conducted, including all documents presented in such proceedings, in the English language. The English language version of this Statement of Limited Warranty prevails over any other language version.

#### **JAPAN**

**Governing Law:** *The following sentence is added to this section:*

Any doubts concerning this Statement of Limited Warranty will be initially resolved between us in good faith and in accordance with the principle of mutual trust.

#### **MALAYSIA**

**Limitation of Liability:** The word "*SPECIAL*" in item 3 of the fifth paragraph is deleted.

#### **NEW ZEALAND**

**What this Warranty Covers:** *The following paragraph is added to this section:*

The warranties specified in this section are in addition to any rights you may have under the Consumer Guarantees Act 1993 or other legislation which cannot be excluded or limited. The Consumer Guarantees Act 1993 will not apply in respect of any goods which Lenovo provides, if you require the goods for the purposes of a business as defined in that Act.

**Limitation of Liability:** *The following is added to this section:*

Where Machines are not acquired for the purposes of a business as defined in the Consumer Guarantees Act 1993, the limitations in this Section are subject to the limitations in that Act.

#### **PEOPLE'S REPUBLIC OF CHINA (PRC)**

**Governing Law:** *The following replaces "laws of the country in which you acquired the Machine" in the first sentence:*

laws of the State of New York, United States of America (except when local law requires otherwise).

#### **PHILIPPINES**

**Limitation of Liability:** *Item 3 in the fifth paragraph is replaced by the following:*

**SPECIAL (INCLUDING NOMINAL AND EXEMPLARY DAMAGES), MORAL, INCIDENTAL, OR INDIRECT DAMAGES FOR ANY ECONOMIC CONSEQUENTIAL DAMAGES; OR**

**Arbitration:** The following is added: under this heading

Disputes arising out of or in connection with this Statement of Limited Warranty shall be finally settled by arbitration which shall be held in Metro Manila, Philippines in accordance with the laws of the Philippines then in effect. The arbitration award shall be final and binding for the parties without appeal and shall be in writing and set forth the findings of fact and the conclusions of law.

The number of arbitrators shall be three, with each side to the dispute being entitled to appoint one arbitrator. The two arbitrators appointed by the parties shall appoint a third arbitrator who shall act as chairman of the proceedings. Vacancies in the post of chairman shall be filled by the president of the Philippine Dispute Resolution Center, Inc.. Other vacancies shall be filled by the respective nominating party. Proceedings shall continue from the stage they were at when the vacancy occurred.

If one of the parties refuses or otherwise fails to appoint an arbitrator within 30 days of the date the other party appoints its, the first appointed arbitrator shall be the sole arbitrator, provided that the arbitrator was validly and properly appointed.

All proceedings shall be conducted, including all documents presented in such proceedings, in the English language. The English language version of this Statement of Limited Warranty prevails over any other language version.

#### **SINGAPORE**

**Limitation of Liability:** *The words "SPECIAL" and "ECONOMIC" in item 3 in the fifth paragraph are deleted.*

#### **EUROPE, MIDDLE EAST, AFRICA (EMEA)**

**THE FOLLOWING TERMS APPLY TO ALL EMEA COUNTRIES:**

The terms of this Statement of Limited Warranty apply to Machines purchased from Lenovo or a Lenovo reseller.

#### **How to Obtain Warranty Service:**

*Add the following paragraph in **Western Europe** (Andorra, Austria, Belgium, Cyprus, Czech Republic, Denmark, Estonia, Finland, France, Germany, Greece, Hungary, Iceland, Ireland, Italy, Latvia, Liechtenstein, Lithuania, Luxembourg, Malta, Monaco, Netherlands, Norway, Poland, Portugal, San Marino, Slovakia, Slovenia, Spain, Sweden, Switzerland, United Kingdom, Vatican State, and any country subsequently added to the European Union, as from the date of accession):*

The warranty for Machines acquired in Western Europe shall be valid and applicable in all Western Europe countries provided the Machines have been announced and made available in such countries.

If you purchase a Machine in one of the Western European countries, as defined above, you may obtain warranty service for that Machine in any of those countries from a Service Provider, provided the Machine has been announced and made available by Lenovo in the country in which you wish to obtain service.

If you purchased a Personal Computer Machine in Albania, Armenia, Belarus, Bosnia and Herzegovina, Bulgaria, Croatia, Czech Republic, Georgia, Hungary, Kazakhstan, Kyrgyzstan, Federal Republic of Yugoslavia, Former Yugoslav Republic of Macedonia (FYROM), Moldova, Poland, Romania, Russia, Slovak Republic, Slovenia, or Ukraine, you may obtain warranty service for that Machine in any of those countries from a Service Provider, provided the Machine has been announced and made available by Lenovo in the country in which you wish to obtain service.

If you purchase a Machine in a Middle Eastern or African country, you may obtain warranty service for that Machine from a Service Provider within the country of purchase, provided the Machine has been announced and made available by Lenovo in that country. Warranty service in Africa is available within 50 kilometers of a Service Provider. You are responsible for transportation costs for Machines located outside 50 kilometers of a Service Provider.

#### **Governing Law:**

*The phrase "the laws of the country in which you acquired the Machine" is replaced by:*

1) "the laws of Austria" in **Albania, Armenia, Azerbaijan, Belarus, Bosnia-Herzegovina, Bulgaria, Croatia, Georgia, Hungary, Kazakhstan, Kyrgyzstan, FYR Macedonia, Moldova, Poland, Romania, Russia, Slovakia, Slovenia, Tajikistan, Turkmenistan, Ukraine, Uzbekistan, and FR Yugoslavia;** 2) "the laws of France" in **Algeria, Benin, Burkina Faso, Cameroon, Cape Verde, Central African Republic, Chad, Comoros, Congo Republic, Djibouti, Democratic Republic of Congo, Equatorial Guinea, French Guiana, French Polynesia, Gabon, Gambia, Guinea, Guinea-Bissau, Ivory Coast, Lebanon, Madagascar, Mali, Mauritania, Mauritius, Mayotte, Morocco, New Caledonia, Niger, Reunion, Senegal, Seychelles, Togo, Tunisia, Vanuatu, and Wallis & Futuna;** 3) "the laws of Finland" in **Estonia, Latvia, and Lithuania;** 4) "the laws of England" in **Angola, Bahrain, Botswana, Burundi, Egypt, Eritrea, Ethiopia, Ghana, Jordan, Kenya, Kuwait, Liberia, Malawi, Malta, Mozambique, Nigeria, Oman, Pakistan, Qatar, Rwanda, Sao Tome, Saudi Arabia, Sierra Leone, Somalia, Tanzania, Uganda, United Arab Emirates, the United Kingdom, West Bank/Gaza, Yemen, Zambia, and Zimbabwe;** and 5) "the laws of South Africa" in **South Africa, Namibia, Lesotho and Swaziland.**

*Jurisdiction: The following exceptions are added to this section:*

1) **In Austria** the choice of jurisdiction for all disputes arising out of this Statement of Limited Warranty and relating thereto, including its existence, will be the competent court of law in Vienna, Austria (Inner-City); 2) **in Angola, Bahrain, Botswana, Burundi, Egypt, Eritrea, Ethiopia, Ghana, Jordan, Kenya, Kuwait, Liberia, Malawi, Malta, Mozambique, Nigeria, Oman, Pakistan, Qatar, Rwanda, Sao Tome, Saudi Arabia, Sierra Leone, Somalia, Tanzania, Uganda, United Arab Emirates, West Bank/Gaza, Yemen, Zambia, and Zimbabwe** all disputes arising out of this Statement of Limited Warranty or related to its execution, including summary proceedings, will be submitted to the exclusive jurisdiction of the English courts; 3) **in Belgium and Luxembourg**, all disputes arising out of this Statement of Limited Warranty or related to its interpretation or its execution, the law, and the courts of the capital city, of the country of your registered office and/or commercial site location only are competent; 4) **in France, Algeria, Benin, Burkina Faso, Cameroon, Cape Verde, Central African Republic, Chad, Comoros, Congo Republic, Djibouti, Democratic Republic of Congo, Equatorial Guinea, French Guiana, French Polynesia, Gabon, Gambia, Guinea, Guinea-Bissau, Ivory Coast, Lebanon, Madagascar, Mali, Mauritania, Mauritius, Mayotte, Morocco, New Caledonia, Niger, Reunion, Senegal, Seychelles, Togo, Tunisia, Vanuatu, and Wallis & Futuna** all disputes arising out of this Statement of Limited Warranty or related to its violation or execution, including summary proceedings, will be settled exclusively by the Commercial Court of Paris; 5) **in Russia**, all disputes arising out of or in relation to the interpretation, the violation, the termination, the nullity of the execution of this Statement of Limited Warranty shall be settled by Arbitration Court of Moscow; 6) **in South Africa, Namibia, Lesotho and Swaziland**, both of us agree to submit all disputes relating to this Statement of Limited Warranty to the jurisdiction of the High Court in Johannesburg; 7) **in Turkey** all disputes arising out of or in connection with this Statement of



Limited Warranty shall be resolved by the Istanbul Central (Sultanahmet) Courts and Execution Directorates of Istanbul, the Republic of Turkey; 8) in each of the following specified countries, any legal claim arising out of this Statement of Limited Warranty will be brought before, and settled exclusively by, the competent court of a) Athens for **Greece**, b) Tel Aviv-Jaffa for **Israel**, c) Milan for **Italy**, d) Lisbon for **Portugal**, and e) Madrid for **Spain**; and 9) **in the United Kingdom**, both of us agree to submit all disputes relating to this Statement of Limited Warranty to the jurisdiction of the English courts.

**Arbitration:** *The following is added under this heading:*

**In Albania, Armenia, Azerbaijan, Belarus, Bosnia-Herzegovina, Bulgaria, Croatia, Georgia, Hungary, Kazakhstan, Kyrgyzstan, FYR Macedonia, Moldova, Poland, Romania, Russia, Slovakia, Slovenia, Tajikistan, Turkmenistan, Ukraine, Uzbekistan, and FR Yugoslavia** all disputes arising out of this Statement of Limited Warranty or related to its violation, termination or nullity will be finally settled under the Rules of Arbitration and Conciliation of the International Arbitral Center of the Federal Economic Chamber in Vienna (Vienna Rules) by three arbitrators appointed in accordance with these rules. The arbitration will be held in Vienna, Austria, and the official language of the proceedings will be English. The decision of the arbitrators will be final and binding upon both parties. Therefore, pursuant to paragraph 598 (2) of the Austrian Code of Civil Procedure, the parties expressly waive the application of paragraph 595 (1) figure 7 of the Code. Lenovo may, however, institute proceedings in a competent court in the country of installation.

**In Estonia, Latvia and Lithuania** all disputes arising in connection with this Statement of Limited Warranty will be finally settled in arbitration that will be held in Helsinki, Finland in accordance with the arbitration laws of Finland then in effect. Each party will appoint one arbitrator. The arbitrators will then jointly appoint the chairman. If arbitrators cannot agree on the chairman, then the Central Chamber of Commerce in Helsinki will appoint the chairman.

## EUROPEAN UNION (EU)

### **THE FOLLOWING TERMS APPLY TO ALL EU COUNTRIES:**

The warranty for Machines acquired in EU countries is valid and applicable in all EU countries provided the Machines have been announced and made available in such countries.

**How to Obtain Warranty Service:** *The following is added to this section:*

To obtain warranty service from IBM service in EU countries, see the telephone listing in Part 3 - Warranty Information.

You may contact IBM service at the following address:

IBM Warranty & Service Quality Dept.  
PO Box 30  
Spango Valley  
Greenock  
Scotland PA16 0AH

## CONSUMERS

Consumers have legal rights under applicable national legislation governing the sale of consumer goods. Such rights are not affected by the warranties provided in this Statement of Limited Warranty.

## **AUSTRIA, DENMARK, FINLAND, GREECE, ITALY, NETHERLANDS, NORWAY, PORTUGAL, SPAIN, SWEDEN AND SWITZERLAND**

**Limitation of Liability:** *The following replaces the terms of this section in its entirety:*

Except as otherwise provided by mandatory law:

1. Lenovo's liability for any damages and losses that may arise as a consequence of the fulfillment of its obligations under or in connection with this Statement of Limited Warranty or due to any other cause related to this Statement of Limited Warranty is limited to the compensation of only those damages and losses proved and actually arising as an immediate and direct consequence of the non-fulfillment of such obligations (if Lenovo is at fault) or of such cause, for a maximum amount equal to the charges you paid for the Machine.

The above limitation shall not apply to damages for bodily injuries (including death) and damages to real property and tangible personal property for which Lenovo is legally liable.

2. **UNDER NO CIRCUMSTANCES IS LENOVO, ITS SUPPLIERS, RESELLERS OR SERVICE PROVIDERS LIABLE FOR ANY OF THE FOLLOWING, EVEN IF INFORMED OF THEIR POSSIBILITY: 1) LOSS OF, OR DAMAGE TO, DATA; 2) INCIDENTAL OR INDIRECT DAMAGES, OR FOR ANY ECONOMIC CONSEQUENTIAL DAMAGES; 3) LOST PROFITS, EVEN IF THEY ARISE AS AN IMMEDIATE CONSEQUENCE OF THE EVENT THAT GENERATED THE DAMAGES; OR 4) LOSS OF BUSINESS, REVENUE, GOODWILL, OR ANTICIPATED SAVINGS.**

#### **FRANCE AND BELGIUM**

**Limitation of Liability:** *The following replaces the terms of this section in its entirety:*

Except as otherwise provided by mandatory law:

1. Lenovo's liability for any damages and losses that may arise as a consequence of the fulfillment of its obligations under or in connection with this Statement of Limited Warranty is limited to the compensation of only those damages and losses proved and actually arising as an immediate and direct consequence of the non-fulfillment of such obligations (if Lenovo is at fault), for a maximum amount equal to the charges you paid for the Machine that has caused the damages.

The above limitation shall not apply to damages for bodily injuries (including death) and damages to real property and tangible personal property for which Lenovo is legally liable.

2. **UNDER NO CIRCUMSTANCES IS LENOVO, ITS SUPPLIERS, RESELLERS OR SERVICE PROVIDERS LIABLE FOR ANY OF THE FOLLOWING, EVEN IF INFORMED OF THEIR POSSIBILITY: 1) LOSS OF, OR DAMAGE TO, DATA; 2) INCIDENTAL OR INDIRECT DAMAGES, OR FOR ANY ECONOMIC CONSEQUENTIAL DAMAGES; 3) LOST PROFITS, EVEN IF THEY ARISE AS AN IMMEDIATE CONSEQUENCE OF THE EVENT THAT GENERATED THE DAMAGES; OR 4) LOSS OF BUSINESS, REVENUE, GOODWILL, OR ANTICIPATED SAVINGS.**

#### **THE FOLLOWING TERMS APPLY TO THE COUNTRY SPECIFIED:**

##### **AUSTRIA**

**The provisions of this Statement of Limited Warranty replace any applicable statutory warranties.**

**What this Warranty Covers:** *The following replaces the first sentence of the first paragraph of this section:*

The warranty for a Lenovo Machine covers the functionality of the Machine for its normal use and the Machine's conformity to its Specifications.

*The following paragraphs are added to this section:*

The limitation period for consumers in action for breach of warranty is the statutory period as a minimum. In case your Service Provider is unable to repair a Lenovo Machine, you can alternatively ask for a partial refund as far as justified by the reduced value of the unrepaired Machine or ask for a cancellation of the respective agreement for such Machine and get your money refunded.

*The second paragraph does not apply.*

**What Lenovo Will Do to Correct Problems:** *The following is added to this section:*

During the warranty period, Lenovo will reimburse you for the transportation charges for the delivery of the failing Machine to IBM Service.

**Limitation of Liability:** *The following paragraph is added to this section:*

The limitations and exclusions specified in the Statement of Limited Warranty will not apply to damages caused by Lenovo with fraud or gross negligence and for express warranty.

*The following sentence is added to the end of item 2:*

Lenovo's liability under this item is limited to the violation of essential contractual terms in cases of ordinary negligence.

## EGYPT

**Limitation of Liability:** *The following replaces item 2 in this section:*

as to any other actual direct damages, Lenovo's liability will be limited to the total amount you paid for the Machine that is the subject of the claim.

*Applicability of suppliers, resellers, and Service Providers (unchanged).*

## FRANCE

**Limitation of Liability:** *The following replaces the second sentence of the first paragraph of this section:*

In such instances, regardless of the basis on which you are entitled to claim damages from Lenovo, Lenovo is liable for no more than: (items 1 and 2 unchanged).

## GERMANY

**What this Warranty Covers:** *The following replaces the first sentence of the first paragraph of this section:*

The warranty for a Lenovo Machine covers the functionality of the Machine for its normal use and the Machine's conformity to its Specifications.

*The following paragraphs are added to this section:*

The minimum warranty period for Machines is twelve months. In case your Service Provider is unable to repair a Lenovo Machine, you can alternatively ask for a partial refund as far as justified by the reduced value of the unrepaired Machine or ask for a cancellation of the respective agreement for such Machine and get your money refunded.

*The second paragraph does not apply.*

**What Lenovo Will Do to Correct Problems:** *The following is added to this section:*

During the warranty period, transportation for delivery of the failing Machine to Lenovo or IBM service will be at Lenovo's expense.

**Limitation of Liability:** *The following paragraph is added to this section:*

The limitations and exclusions specified in the Statement of Limited Warranty will not apply to damages caused by Lenovo with fraud or gross negligence and for express warranty.

*The following sentence is added to the end of item 2:*

Lenovo's liability under this item is limited to the violation of essential contractual terms in cases of ordinary negligence.

## HUNGARY

**Limitation of Liability:** *The following is added at the end of this section:*

The limitation and exclusion specified herein shall not apply to liability for a breach of contract damaging life, physical well-being, or health that has been caused intentionally, by gross negligence, or by a criminal act.

The parties accept the limitations of liability as valid provisions and state that the Section 314.(2) of the Hungarian Civil Code applies as the acquisition price as well as other advantages arising out of the present Statement of Limited Warranty balance this limitation of liability.

## IRELAND

**What this Warranty Covers:** *The following is added to this section:*

Except as expressly provided in these terms and conditions, all statutory conditions, including all warranties implied, but without prejudice to the generality of the foregoing all warranties implied by the Sale of Goods Act 1893 or the Sale of Goods and Supply of Services Act 1980 are hereby excluded.

**Limitation of Liability:** *The following replaces the terms of section in its entirety:*

For the purposes of this section, a "Default" means any act, statement, omission, or negligence on the part of Lenovo in connection with, or in relation to, the subject matter of this Statement of Limited

Warranty in respect of which Lenovo is legally liable to you, whether in contract or tort. A number of Defaults which together result in, or contribute to, substantially the same loss or damage will be treated as one Default occurring on the date of occurrence of the last such Default.

Circumstances may arise where, because of a Default, you are entitled to recover damages from Lenovo.

This section sets out the extent of Lenovo's liability and your sole remedy.

1. Lenovo will accept unlimited liability for death or personal injury caused by the negligence of Lenovo.
2. Subject always to the **Items for Which Lenovo is Not Liable** below, Lenovo will accept unlimited liability for physical damage to your tangible property resulting from the negligence of Lenovo.
3. Except as provided in items 1 and 2 above, Lenovo's entire liability for actual damages for any one Default will not in any event exceed 125% of the amount you paid for the Machine directly relating to the Default.

#### **Items for Which Lenovo is Not Liable**

Save with respect to any liability referred to in item 1 above, under no circumstances is Lenovo, its suppliers, resellers or Service Providers liable for any of the following, even if Lenovo or they were informed of the possibility of such losses:

1. loss of, or damage to, data;
2. special, indirect, or consequential loss; or
3. loss of profits, business, revenue, goodwill, or anticipated savings.

#### **SLOVAKIA**

**Limitation of Liability:** *The following is added to the end of the last paragraph:*

The limitations apply to the extent they are not prohibited under §§ 373-386 of the Slovak Commercial Code.

#### **SOUTH AFRICA, NAMIBIA, BOTSWANA, LESOTHO AND SWAZILAND**

**Limitation of Liability:** *The following is added to this section:*

Lenovo's entire liability to you for actual damages arising in all situations involving nonperformance by Lenovo in respect of the subject matter of this Statement of Warranty will be limited to the charge paid by you for the individual Machine that is the subject of your claim from Lenovo.

#### **UNITED KINGDOM**

**Limitation of Liability:** *The following replaces the terms of this section in its entirety:*

For the purposes of this section, a "Default" means any act, statement, omission, or negligence on the part of Lenovo in connection with, or in relation to, the subject matter of this Statement of Limited Warranty in respect of which Lenovo is legally liable to you, whether in contract or tort. A number of Defaults which together result in, or contribute to, substantially the same loss or damage will be treated as one Default.

Circumstances may arise where, because of a Default, you are entitled to recover damages from Lenovo.

This section sets out the extent of Lenovo's liability and your sole remedy.

1. Lenovo will accept unlimited liability for:
  - a. death or personal injury caused by the negligence of Lenovo; and
  - b. any breach of its obligations implied by Section 12 of the Sale of Goods Act 1979 or Section 2 of the Supply of Goods and Services Act 1982, or any statutory modification or re-enactment of either such Section.
2. Lenovo will accept unlimited liability, subject always to the **Items for Which Lenovo is Not Liable** below, for physical damage to your tangible property resulting from the negligence of Lenovo.
3. Lenovo's entire liability for actual damages for any one Default will not in any event, except as provided in items 1 and 2 above, exceed 125% of the total purchase price payable or the charges for the Machine directly relating to the Default.

These limits also apply to Lenovo's suppliers, resellers and Service Providers. They state the maximum for which Lenovo and such suppliers, resellers and Service Providers are collectively responsible.

#### Items for Which Lenovo is Not Liable

Save with respect to any liability referred to in item 1 above, under no circumstances is Lenovo or any of its suppliers, resellers or Service Providers liable for any of the following, even if Lenovo or they were informed of the possibility of such losses:

1. loss of, or damage to, data;
2. special, indirect, or consequential loss; or
3. loss of profits, business, revenue, goodwill, or anticipated savings.

---

## Part 3 - Warranty Information

This Part 3 provides information regarding the warranty applicable to your Machine, including the warranty period and type of warranty service Lenovo provides.

### Warranty Period

The warranty period may vary by country or region and is specified in the table below. NOTE: "Region" means either Hong Kong or Macau Special Administrative Region of China.

A warranty period of 1 year on parts and 1 year on labor means that Lenovo provides warranty service during the first year of the warranty period.

#### USB 2.0 Super Multi-Burner Drive

Country or Region of Purchase	Warranty Period	Type of Warranty Service
Worldwide	1 year	7

### Types of Warranty Service

If required, your Service Provider will provide repair or exchange service depending on the type of warranty service specified for your Machine in the above table and as described below. Scheduling of service will depend upon the time of your call and is subject to parts availability. Service levels are response time objectives and are not guaranteed. The specified level of warranty service may not be available in all worldwide locations, additional charges may apply outside your Service Provider's normal service area, contact your local Service Provider representative or your reseller for country and location specific information.

#### 1. Customer Replaceable Unit ("CRU") Service

Lenovo will ship CRUs to you for you to install, Tier 1 CRUs are easy to install whereas Tier 2 CRUs require some technical skill and tools. CRU information and replacement instructions are shipped with your Machine and are available from Lenovo at any time on your request. You may request that a Service Provider install CRUs, at no additional charge, under the type of warranty service designated for your Machine. Lenovo specifies in the materials shipped with a replacement CRU whether a defective CRU must be returned. When return is required, 1) return instructions and a container are shipped with the replacement CRU, and 2) you may be charged for the replacement CRU if Lenovo does not receive the defective CRU within 30 days of your receipt of the replacement.

#### 2. On-site Service

Your Service Provider will either repair or exchange the failing Machine at your location and verify its operation. You must provide suitable working area to allow disassembly and reassembly of the Lenovo Machine. The area must be clean, well lit and suitable for the purpose. For some Machines, certain repairs may require sending the Machine to a designated service center.

#### 3. Courier or Depot Service \*

You will disconnect the failing Machine for collection arranged by your Service Provider. A shipping container will be provided to you for you to return your Machine to a designated service center. A courier will pick up your Machine and deliver it to the designated service center. Following its repair or exchange, the service center will arrange the return delivery of the Machine to your location. You are responsible for its installation and verification.

**4. Customer Carry-In or Mail-In Service**

You will deliver or mail as your Service Provider specifies (prepaid unless specified otherwise) the failing Machine suitably packaged to a designated location. After the Machine has been repaired or exchanged, it will be made available for your collection or, for Mail-in Service, the Machine will be returned to you at Lenovo’s expense, unless your Service Provider specifies otherwise. You are responsible for the subsequent installation and verification of the Machine.

**5. CRU and On-site Service**

This type of Warranty Service is a combination of Type 1 and Type 2 (see above).

**6. CRU and Courier or Depot Service**

This type of Warranty Service is a combination of Type 1 and Type 3 (see above).

**7. CRU and Customer Carry-In or Mail-In Service**

This type of Warranty Service is a combination of Type 1 and Type 4 (see above).

**When a 5, 6 or 7 type of warranty service is listed, your Service Provider will determine which type of warranty service is appropriate for the repair.**

\* This type of service is called ThinkPad EasyServ or EasyServ in some countries.

To obtain warranty service contact a Service Provider. In Canada or the United States, call 1-800-IBM-SERV (426-7378). In other countries, see the telephone numbers below.

**Worldwide telephone list**

Phone numbers are subject to change without notice. For the most current phone numbers, go to <http://www.lenovo.com/think/support> and click **Support phone list**.

Country or Region	Telephone Number
Africa	Africa: +44 (0)1475-555-055 South Africa: +27-11-3028888 and 0800110756 Central Africa: Contact your Lenovo service provider
Argentina	0800-666-0011 (Spanish)
Australia	131-426 (English)
Austria	Up and running support: 01-24592-5901 Warranty service and support: 01-211-454-610 (German)
Belgium	Up and running support: 02-210-9820 (Dutch) Up and running support: 02-210-9800 (French) Warranty service and support: 02-225-3611 (Dutch, French)
Bolivia	0800-0189 (Spanish)
Brazil	Sao Paulo region: (11) 3889-8986 Toll free outside Sao Paulo region: 0800-7014-815 (Brazilian Portuguese)
Canada	1-800-565-3344 (English, French) In Toronto only call: 416-383-3344
Chile	800-224-488 (Spanish)
China	800-810-1818 (Mandarin)

Country or Region	Telephone Number
China (Hong Kong S.A.R.)	Home PC: 852-2825-7799 Commercial PC: 852-8205-0333 ThinkPad and WorkPad: 852-2825-6580 (Cantonese, English, Putonghua)
Colombia	1-800-912-3021 (Spanish)
Costa Rica	284-3911 (Spanish)
Croatia	0800-0426
Cyprus	+357-22-841100
Czech Republic	+420-2-7213-1316
Denmark	Up and running support: 4520-8200 Warranty service and support: 7010-5150 (Danish)
Dominican Republic	566-4755 566-5161 ext. 8201 Toll Free within the Dominican Republic: 1-200-1929 (Spanish)
Ecuador	1-800-426911 (Spanish)
El Salvador	250-5696 (Spanish)
Estonia	+386-61-1796-699
Finland	Up and running support: 09-459-6960 Warranty service and support: +358-800-1-4260 (Finnish)
France	Up and running support: 0238-557-450 Warranty service and support (hardware): 0810-631-213 Warranty service and support (software): 0810-631-020 (French)
Germany	Up and running support: 07032-15-49201 Warranty service and support: 01805-25-35-58 (German)
Greece	+30-210-680-1700
Guatemala	335-8490 (Spanish)
Honduras	Tegucigalpa & San Pedro Sula: 232-4222 San Pedro Sula: 552-2234 (Spanish)
Hungary	+36-1-382-5720
India	1600-44-6666 Alternate Toll Free: +91-80-2678-8940 (English)
Indonesia	800-140-3555 +62-21-251-2955 (English, Bahasa Indonesian)
Ireland	Up and running support: 01-815-9202 Warranty service and support: 01-881-1444 (English)
Israel	Hebrew +972-3-531-3900 English +972-3-531-3900 8:30AM - 5:00PM Sunday - Thursday (Local time)

Country or Region	Telephone Number
Italy	Up and running support: 02-7031-6101 Warranty service and support: +39-800-820094 (Italian)
Japan	Desktop: Toll free: 0120-887-870 For International: +81-46-266-4724  ThinkPad: Toll free: 0120-887-874 For International: +81-46-266-4724  Both of the above numbers will be answered with a Japanese language voice prompt. For telephone support in English, please wait for the Japanese voice prompt to end, and an operator will answer. Please ask for "English support please," and your call will be transferred to an English speaking operator.  PC Software: 0120-558-695 Overseas calls: +81-44-200-8666 (Japanese)
Korea	1588-5801 (Korean)
Latvia	+386-61-1796-699
Lithuania	+386-61-1796-699
Luxembourg	+352-298-977-5063 (French)
Malaysia	1800-88-8558 (English, Bahasa Melayu)
Malta	+356-23-4175
Mexico	001-866-434-2080 (Spanish)
Middle East	+44 (0)1475-555-055
Netherlands	+31-20-514-5770 (Dutch)
New Zealand	0800-446-149 (English)
Nicaragua	255-6658 (Spanish)
Norway	Up and running support: 6681-1100 Warranty service and support: 8152-1550 (Norwegian)
Panama	206-6047 (Spanish)
Peru	0-800-50-866 (Spanish)
Philippines	1800-1888-1426 +63-2-995-8420 (English, Philipino)
Poland	+48-22-878-6999
Portugal	+351-21-892-7147 (Portuguese)
Romania	+4-021-224-4015
Russian Federation	+7-095-940-2000 (Russian)
Singapore	1800-3172-888 (English, Bahasa, Melayu)
Slovakia	+421-2-4954-1217
Slovenia	+386-1-4796-699



Country or Region	Telephone Number
Spain	91-714-7983 91-397-6503 (Spanish)
Sri Lanka	+94-11-2448-442 (English)
Sweden	Up and running support: 08-477-4420 Warranty service and support: 077-117-1040 (Swedish)
Switzerland	Up and running support: 058-333-0900 Warranty service and support: 0800-55-54-54 (German, French, Italian)
Taiwan	886-2-8723-9799 (Mandarin)
Thailand	1-800-299-229 (Thai)
Turkey	00800-4463-2041 (Turkish)
United Kingdom	Up and running support: 01475-555-055 Warranty service and support (hardware): 08705-500-900 Warranty service and support (software): 08457-151-516 (English)
United States	1-800-426-7378 (English)
Uruguay	000-411-005-6649 (Spanish)
Venezuela	0-800-100-2011 (Spanish)
Vietnam	For northern area and Hanoi: 84-4-8436675 For southern area and Ho Chi Minh City: 84-8-829-5160 (English, Vietnamese)

---

## Guarantee supplement for Mexico

This supplement is considered part of Lenovo's Statement of Limited Warranty and shall be effective solely and exclusively for products distributed and commercialized within Territory of the Mexican United States. In the event of a conflict, the terms of this supplement shall apply.

All software programs pre-loaded in the equipment shall only have a thirty- (30) day guarantee for installation defects from the date of purchase. Lenovo is not responsible for the information in such software programs and/or any additional software programs installed by you or installed after purchase of the product.

Services not chargeable to the guarantee shall be charged to the final user, prior an authorization.

In the event that warranty repair is required please call the Customer Support Center at 001-866-434-2080, where you will be directed to the nearest Authorized Service Center. Should no Authorized Service Center exist in your city, location or within 70 kilometers of your city or location, the guarantee includes any reasonable delivery charges related to the transportation of the product to our nearest Authorized Service Center. Please call the nearest Authorized Service Center to obtain the necessary approvals or information concerning the shipment of the product and the shipment address.

To obtain a list of Authorized Service Centers, please visit:

<http://www.lenovo.com/mx/es/servicios>

**Manufactured by:**  
SCI Systems de México, S.A. de C.V.  
Av. De la Solidaridad Iberoamericana No. 7020  
Col. Club de Golf Atlas  
El Salto, Jalisco, México  
C.P. 45680,  
Tel. 01-800-3676900

**Marketing by:**  
Lenovo de México, Comercialización y  
Servicios, S. A. de C. V.  
Alfonso Nápoles Gándara No 3111  
Parque Corporativo de Peña Blanca  
Delegación Álvaro Obregón  
México, D.F., México  
C.P. 01210,  
Tel. 01-800-00-325-00

---

## Appendix E. Electronic emissions notices

The following information refers to the USB 2.0 Super Multi-Burner Drive.

---

### Federal Communications Commission (FCC) Declaration of Conformity

This equipment has been tested and found to comply with the limits for a Class B digital device, pursuant to Part 15 of the FCC Rules. These limits are designed to provide reasonable protection against harmful interference in a residential installation. This equipment generates, uses, and can radiate radio frequency energy and, if not installed and used in accordance with the instructions, may cause harmful interference to radio communications. However, there is no guarantee that interference will not occur in a particular installation. If this equipment does cause harmful interference to radio or television reception, which can be determined by turning the equipment off and on, the user is encouraged to try to correct the interference by one or more of the following measures:

- Reorient or relocate the receiving antenna.
- Increase the separation between the equipment and receiver.
- Connect the equipment into an outlet on a circuit different from that to which the receiver is connected.
- Consult an authorized dealer or service representative for help.

Lenovo is not responsible for any radio or television interference caused by using other than recommended cables or connectors or by unauthorized changes or modifications to this equipment. Unauthorized changes or modifications could void the user's authority to operate the equipment.

This device complies with Part 15 of the FCC Rules. Operation is subject to the following two conditions: (1) this device may not cause harmful interference, and (2) this device must accept any interference received, including interference that may cause undesired operation.

Responsible party:

Lenovo (United States) Incorporated  
One Manhattanville Road  
Purchase, New York 10577  
Telephone: (919) 254-0532



Tested To Comply  
With FCC Standards

FOR HOME OR OFFICE USE

#### Industry Canada Class B emission compliance statement

This Class B digital apparatus complies with Canadian ICES-003.

#### Avis de conformité à la réglementation d'Industrie Canada

Cet appareil numérique de la classe B est conforme à la norme NMB-003 du Canada.

#### EU-EMC Directive (89/336/EG) EN 55022 class B Statement of Compliance

#### Deutschsprachiger EU Hinweis:

**Hinweis für Geräte der Klasse B EU-Richtlinie zur Elektromagnetischen Verträglichkeit** Dieses Produkt entspricht den Schutzanforderungen der EU-Richtlinie 89/336/EWG zur Angleichung der Rechtsvorschriften über die elektromagnetische Verträglichkeit in den EU-Mitgliedsstaaten.

und hält die Grenzwerte der EN 55022 Klasse B ein.

Um dieses sicherzustellen, sind die Geräte wie in den Handbüchern beschrieben zu installieren und zu betreiben. Des Weiteren dürfen auch nur von der Lenovo empfohlene Kabel angeschlossen werden. Lenovo übernimmt keine Verantwortung für die Einhaltung der Schutzanforderungen, wenn das Produkt ohne Zustimmung der Lenovo verändert bzw. wenn Erweiterungskomponenten von Fremdherstellern ohne Empfehlung der Lenovo gesteckt/eingebaut werden.

**Deutschland: Einhaltung des Gesetzes über die elektromagnetische Verträglichkeit von Geräten** Dieses Produkt entspricht dem "Gesetz über die elektromagnetische Verträglichkeit von Geräten (EMVG)". Dies ist die Umsetzung der EU-Richtlinie 89/336/EWG in der Bundesrepublik Deutschland.

**Zulassungsbescheinigung laut dem Deutschen Gesetz über die elektromagnetische Verträglichkeit von Geräten (EMVG) vom 18. September 1998 (bzw. der EMC EG Richtlinie 89/336) für Geräte der Klasse B** Dieses Gerät ist berechtigt, in Übereinstimmung mit dem Deutschen EMVG das EG-Konformitätszeichen - CE - zu führen.

Verantwortlich für die Konformitätserklärung nach Paragraf 5 des EMVG ist die Lenovo (Deutschland) GmbH, Pascalstr. 100, D-70569 Stuttgart. Informationen in Hinsicht EMVG Paragraf 4 Abs. (1) 4:

**Das Gerät erfüllt die Schutzanforderungen nach EN 55024 und EN 55022 Klasse B.)**

#### **European Union - Compliance to the Electromagnetic Compatibility Directive**

This product is in conformity with the protection requirements of EU Council Directive 89/336/ECC on the approximation of the laws of the Member States relating to electromagnetic compatibility. Lenovo cannot accept responsibility for any failure to satisfy the protection requirements resulting from a non-recommended modification of the product, including the fitting of option cards from other manufacturers.

This product has been tested and found to comply with the limits for Class B Information Technology Equipment according to European Standard EN 55022. The limits for Class B equipment were derived for typical residential environments to provide reasonable protection against interference with licensed communication devices.

#### **Avis de conformité à la directive de l'Union Européenne**

Le présent produit satisfait aux exigences de protection énoncées dans la directive 89/336/CEE du Conseil concernant le rapprochement des législations des Etats membres relatives à la compatibilité électromagnétique. Lenovo décline toute responsabilité en cas de non-respect de cette directive résultant d'une modification non recommandée du produit, y compris l'ajout de cartes en option non Lenovo.

Ce produit respecte les limites des caractéristiques d'immunité des appareils de traitement de l'information définies par la classe B de la norme européenne EN 55022 (CISPR 22). La conformité aux spécifications de la classe B offre une garantie acceptable contre les perturbations avec les appareils de communication agréés, dans les zones résidentielles.

#### **Unión Europea - Normativa EMC**

Este producto satisface los requisitos de protección del Consejo de la UE, Directiva 89/336/CEE en lo que a la legislación de los Estados Miembros sobre compatibilidad electromagnética se refiere.

Lenovo no puede aceptar responsabilidad alguna si este producto deja de satisfacer dichos requisitos de protección como resultado de una modificación no recomendada del producto, incluyendo el ajuste de tarjetas de opción que no sean Lenovo.

Este producto ha sido probado y satisface los límites para Equipos Informáticos Clase B de conformidad con el Estándar Europeo EN 55022. Los límites para los equipos de Clase B se han establecido para entornos residenciales típicos a fin de proporcionar una protección razonable contra las interferencias con dispositivos de comunicación licenciados.

#### **Unione Europea - Directiva EMC (Conformidad electromagnética)**

Questo prodotto è conforme alle normative di protezione ai sensi della Direttiva del Consiglio dell'Unione Europea 89/336/CEE sull'armonizzazione legislativa degli stati membri in materia di compatibilità elettromagnetica.

Lenovo non accetta responsabilità alcuna per la mancata conformità alle normative di protezione dovuta a modifiche non consigliate al prodotto, compresa l'installazione di schede e componenti di marca diversa da Lenovo.

Le prove effettuate sul presente prodotto hanno accertato che esso rientra nei limiti stabiliti per le apparecchiature di informatica Classe B ai sensi del Norma Europea EN 55022. I limiti delle apparecchiature della Classe B sono stati stabiliti al fine di fornire ragionevole protezione da interferenze mediante dispositivi di comunicazione in concessione in ambienti residenziali tipici.

#### **Korea Class B Compliance**

이 기기는 가정용으로 전자파 적합등록을 한 기기로서  
주거지역에서는 물론 모든 지역에서 사용할 수 있습니다.

#### **Japan VCCI Class B Compliance**

この装置は、情報処理装置等電波障害自主規制協議会（VCCI）の基準に基づきクラスB情報技術装置です。この装置は、家庭環境で使用することを目的としていますが、この装置がラジオやテレビジョン受信機に近接して使用されると、受信障害を引き起こすことがあります。  
取扱説明書に従って正しい取り扱いをして下さい。

Japanese statement of compliance for products less than or equal to 20 A per phase

高調波ガイドライン適合品





**lenovo**

Part Number: 40Y8699

Printed in USA

(1P) P/N: 40Y8699

