



**Hardware Maintenance Service
for Service Level A**

For Micro Tower Model
Machine Type 2275

For Desktop Model
Machine Type 2255

Note

Before using this information and the product it supports, be sure to read the general information under "Notices" on page 5.

First Edition (March 2001)

The following paragraph does not apply to any state or country where such provisions are inconsistent with local law:

INTERNATIONAL BUSINESS MACHINES CORPORATION PROVIDES THIS PUBLICATION "AS IS" WITHOUT WARRANTY OF ANY KIND, EITHER EXPRESSED OR IMPLIED, INCLUDING, BUT NOT LIMITED TO, THE IMPLIED WARRANTIES OF MERCHANTABILITY OR FITNESS FOR A PARTICULAR PURPOSE. References to IBM products, programs, or services do not imply that IBM intends to make them available outside the United States. This publication could include technical inaccuracies or typographical errors. Changes are periodically made to the information herein; these changes will be made in later editions. IBM may make improvements and/or changes in the product(s) and/or the program(s) at any time. Address comments about this publication to IBM Corporation, Dept. E23/962-2, 455 Park Place, Lexington, KY 40511-1856, USA. IBM may use information you supply without obligation. For copies of publications related to this product, call toll free 1-800-IBM-7282 in the Continental U.S.A. In Canada, call toll free 1-800-465-7999.

**© Copyright International Business Machines Corporation 2000.
All rights reserved.**

Note to U.S. Government Users – Documentation related to restricted rights – Use, duplication or disclosure is subject to restrictions set forth in GSA ADP Schedule Contract with IBM Corp.

Contents

| | |
|---|-----------|
| Notices | 5 |
| Voltage Supply Switch Settings | 5 |
| Safety Information | 6 |
| Laser Compliance Statement | 30 |
| Trademarks | 31 |
| Preface | 32 |
| General Information | 33 |
| Introduction | 34 |
| Product Overview | 35 |
| Hardware Interfaces | 38 |
| Flash (BIOS) Update Procedure..... | 40 |
| BIOS-contained Model Number and Serial Number | 41 |
| BIOS Setup Utility..... | 42 |
| Working with the Setup Menus..... | 42 |
| Start Options | 45 |
| Advanced Setup..... | 47 |
| Power Management Setup..... | 47 |
| Set Administrator Password | 48 |
| Set Password..... | 48 |
| Specifications | 49 |
| Operating Requirements..... | 50 |
| Special Tools | 51 |
| Check Procedures | 53 |
| Introduction | 54 |
| Start | 55 |
| Index of Symptoms, Messages, Error Codes, or Beeps..... | 60 |
| Troubleshooting..... | 70 |
| Factory-Installed Storage Devices | 71 |
| Factory-Installed Modem Card..... | 73 |
| Audio (Not Supported by Diagnostics Program)..... | 75 |
| CD-ROM Drive..... | 76 |
| Memory | 78 |
| Keyboard..... | 78 |
| Mouse..... | 79 |
| Power Supply..... | 81 |
| Monitor | 83 |
| Undetermined Problems..... | 84 |
| Diagnostic Aids | 85 |
| Introduction..... | 86 |
| Power-On Self Test..... | 87 |
| Diagnostics Tools..... | 88 |
| Using Diagnostics Program from Recovery CD | 88 |
| Diagnostics Program Features..... | 89 |
| Repair Information | 91 |
| Removals and Replacements of machine type 2275 | 92 |
| Identifying the Parts of the System Unit..... | 93 |
| Top Cover..... | 95 |
| Adapter Cards..... | 96 |
| Diskette Drive..... | 98 |
| CD-ROM Drive..... | 99 |
| Hard Disk Drive | 100 |
| System Board..... | 101 |
| Power Supply | 102 |
| Removals and Replacements of machine type 2255 | 104 |

| | |
|---|------------|
| Identifying the Parts of the System Unit..... | 105 |
| Top Cover..... | 107 |
| Adapter Cards..... | 108 |
| Diskette Drive..... | 110 |
| CD-ROM Drive..... | 111 |
| Hard Disk Drive..... | 112 |
| System Board..... | 113 |
| Power Supply..... | 115 |
| Memory (DIMM)..... | 116 |
| Parts/Test Point Locations | 117 |
| Introduction..... | 118 |
| Layout of the System Board for Machine Types 2255 and 2275 | 119 |
| Jumper Settings of the System Board of the Machine Types 2255 and 2275 | 120 |
| Connectors and Functions for the System Board of Machine Types 2255 and 2275..... | 121 |
| Power Supply Cable Connector Specifications..... | 122 |
| Main Output Pin Assignment..... | 123 |
| Factory-Installed Modem Card Layout | 125 |
| Factory-Installed Modem Card Connector Functions..... | 125 |
| 3.5-In. Hard Disk Drive Jumper Locations & Settings..... | 126 |
| CD-ROM Drive | 127 |
| CD-ROM Drive Rear Panel Connectors and Features..... | 128 |
| CD-ROM Drive Jumper Settings..... | 128 |
| DIMM Configurations..... | 129 |
| System Board Connector Pin Signals | 130 |
| Monitor Port Signals..... | 130 |
| Serial Port Signals | 130 |
| Parallel Port Signals..... | 130 |
| Mouse Port Signals..... | 131 |
| Keyboard Port Signals..... | 131 |
| Diskette Drive Cable Connector Signals..... | 132 |
| IDE Cable Connector Signals..... | 133 |
| Safety Inspection Guide | 135 |
| General Guidelines..... | 136 |
| Parts Catalog | 139 |
| Parts Catalog of machine type 2275..... | 140 |
| Assembly 1: System Unit | 140 |
| Assembly 2: Diskette Drive, Hard Disk Drive | 142 |
| Assembly 3: CD-ROM, Modem Card | 143 |
| Assembly 4: Keyboard and Mouse | 145 |
| Parts Catalog of machine type 2255..... | 146 |
| Assembly 1: System Unit | 146 |
| Assembly 2: Diskette Drive, Hard Disk Drive | 148 |
| Assembly 3: CD-ROM, Modem Card | 149 |
| Assembly 4: Keyboard and Mouse..... | 150 |
| Appendix A. Online Support Information | 151 |
| Index | 152 |

Notices

References in this publication to IBM products, programs, or services do not imply that IBM intends to make these available in all countries in which IBM operates. Any reference to an IBM product, program, or service is not intended to state or imply that only IBM's product, program, or service may be used. Any functionally equivalent product, program, or service that does not infringe any of IBM's intellectual property rights, or other legally prosecutable rights, may be used instead of the IBM product, program, or service. References in this publication to IBM products, programs, or services are purely hardware-related and do not cover circumstances of software problems. Evaluation and verification of operation in conjunction with other products, program, or services, except those expressly designated by IBM is the user's responsibility. IBM may have patents or pending patent applications covering subject matter in this document. The featuring of these patents, pending or otherwise, in this document does not give you any license to these patents. You can send license inquires, in writing, to the IBM Director of Commercial Relations, IBM Corporation, Purchase, NY10577.

Voltage Supply Switch Settings

Your IBM Personal Computer *might* have voltage switches, which must be set correctly for your voltage supply. If your monitor or system unit has a voltage switch, complete these steps to make sure each switch is set correctly:

1. Determine the correct voltage switch setting for your area:

| <u>Voltage Supply Range</u> | <u>Voltage Switch Setting</u> |
|-----------------------------|-------------------------------|
| 100-127 V | 110 V |
| 200-240 V | 220 V |

2. Locate the voltage switch on the back of your monitor or system unit. If the setting shown on the switch is:

- Correct: start setting up your IBM personal computer.
- Incorrect: change the voltage switch setting.

Safety Information



DANGER

To avoid a shock hazard, do not connect or disconnect any cables or perform installation, maintenance, or reconfiguration of this product during an electrical storm.

To avoid shock hazard:

- The power cord must be connected to a properly wired and grounded receptacle.
- Any equipment to which this product will be attached must also be connected to properly wired receptacles.

When possible, use one hand to connect or disconnect signal cables to prevent a possible shock from touching two surfaces with different electrical potentials.

Electrical current from power, telephone, and communications cables is hazardous. To avoid shock hazard, connect and disconnect cables as described following when installing, moving, or opening covers of this product or attached devices.

To Connect

1. Turn Everything OFF.
2. First, attach all cables to devices.
3. Attach signal cables to receptacles.
4. Attach power cord(s) to outlet.
5. Turn device ON

To Disconnect

1. Turn Everything OFF.
2. First, remove power cord(s) from outlet
3. Remove signal cables from receptacles.
4. Remove all cables from devices.



Caution:

When replacing the battery, use only IBM Part Number 36L9077 or an equivalent type battery recommended by the manufacturer. If your system has a module containing a lithium battery, replace it only with the same module type made by the same manufacturer. The battery contains lithium and can explode if not properly used, handled, or disposed of.

Do not:

- Throw or immerse into water
- Heat to more than 100°C (212°F)
- Repair or disassemble

Dispose of the battery as required by local ordinances or regulations.



Caution:

When a CD-ROM drive is installed, note the following.

Use of controls or adjustments or performance of procedures other than those specified herein might result in hazardous radiation exposure.

Removing the covers of the CD-ROM drive could result in exposure to hazardous laser radiation. There are no serviceable parts inside the CD-ROM drive. Do not remove the CD-ROM drive covers.

DANGER

Some CD-ROM drives contain an embedded Class 3A or Class 3B-laser diode. Note the following.

Laser radiation when open. Do not stare into the beam, do not view directly with optical instruments, and avoid direct exposure to the beam.



≥32 Kg ≥55Kg
(70.5 (121.2
lbs) lbs)

Caution:
Use safe lifting practices when lifting your machine.



Caution:
Electrical current from power, telephone, and communication cables can be hazardous. To avoid personal injury or equipment damage, disconnect the attached power cords, telecommunications systems, networks, and modems before you open the covers, unless instructed otherwise in the installation and configuration procedures.

**PERIGO**

Para evitar choques elétricos, não conecte ou desconecte nenhum cabo, nem efetue instalação, manutenção ou reconfiguração deste produto durante uma tempestade com raios.

Para evitar choques elétricos:

- O cabo de alimentação deve ser conectado a um receptáculo corretamente instalado e aterrado.
- Todos os equipamentos aos quais este produto será conectado devem também ser conectados a receptáculos corretamente instalados.

Quando possível, utilize uma das mãos para conectar ou desconectar cabos de sinal, para evitar um possível choque ao tocar duas superfícies com potenciais elétricos diferentes.

A corrente elétrica proveniente de cabos de alimentação, de telefone e de comunicação é perigosa. Para evitar choques elétricos, conecte e desconecte os cabos conforme descriptor a seguir, ao instalar, movimentar ou abrir tampas deste produto ou de dispositivos conectados.

| Para Conectar | Para Desconectar |
|--|---|
| 1. DESLIGUE tudo. | 1. DESLIGUE tudo. |
| 2. Conecte primeiro todos os cabos nos dispositivos. | 2. Remova primeiro o(s) cabo(s) de alimentação das tomadas. |
| 3. Conecte os cabos de sinal nos receptáculos. | 3. Remova os cabos de sinal dos receptáculos. |
| 4. Conecte o(s) cabo(s) de alimentação nas tomadas. | 4. Remova todos os cabos dos dispositivos. |
| 5. LIGUE o dispositivo. | |



cuidado:

Ao substituir a bateria, utilize apenas o Número de Peça IBM 36L9077 ou um tipo de bateria equivalente recomendado pelo fabricante. Se seu sistema possuir um módulo com uma bateria de lítio, substitua-o apenas pelo mesmo tipo de módulo, produzido pelo mesmo fabricante. A bateria contém lítio e pode explodir se não for utilizada, manuseada e descartada de forma adequada.

Não:

- Jogue ou coloque na água
- Aqueça a mais de 100°C (212°F)
- Conserte nem desmonte.

Descarte a bateria conforme requerido pelas disposições e regulamentações locais.



cuidado:

Quando uma unidade de CD-ROM estiver instalada, observe o seguinte.

A utilização de controles ou ajustes ou a execução de procedimentos diferentes daqueles especificados nesta publicação pode resultar em exposição perigosa à radiação.

A remoção das tampas da unidade de CD-ROM pode resultar em exposição a radiação perigosa de laser. Não existem peças que possam ser consertadas no interior da unidade de CD-ROM. Não remova as tampas da unidade de CD-ROM.

PERIGO

Algumas unidades de CD-ROM contém um diodo de laser da Classe 3A ou da Classe 3B. Observe o seguinte.

Radiação de laser quando aberto. Não olhe diretamente para o feixe de laser, não olhe diretamente com instrumentos óticos, e evite exposição direta ao raio.



| | |
|-------------------------|-------------------------|
| ≥32 Kg (70,5 lbs) | ≥55Kg (121,2 lbs) |
|-------------------------|-------------------------|

cuidado:

Utilize práticas seguras para levantamento de peso ao levantar sua máquina.



cuidado:

A corrente elétrica proveniente de cabos de alimentação, de telefone e de comunicação é perigosa. Para evitar ferimentos pessoais ou danos aos equipamentos, desconecte os cabos de alimentação, sistemas de telecomunicação, redes e modems antes de abrir as tampas, a menos que receba outras instruções nos procedimentos de instalação e configuração.

声明 1



危险！

为避免电击危险，请不要在暴风雨期间连接或断开任何电缆，或是进行此产品的安装、维护或重新配置操作。

为避免电击危险：

- 电源线必须连接到适当的电线及接地插座。
- 此产品将要连接的所有设备也必须连接到正确接线的插座上。

如果可能，请使用一只手连接或断开连接信号电缆，以避免在接触两个具有不同电势的表面时遭到电击。

电源线、电话线以及通信电缆中的电流非常危险。为避免电击，请在安装、移动或打开本产品或连接设备的外盖时，按照下述步骤连接或断开电缆。

要连接电缆

1. 关闭所有设备。
2. 首先将所有电缆与设备连接。
3. 将信号线连接到插座。
4. 将电源线连接到电源插座。
5. 打开设备。

要断开电缆

1. 关闭所有设备。
2. 首先从电源插座拔下电源线。
3. 从插座拔下信号电缆。
4. 从设备上拔下所有电缆。

声明 2



注意！

当更换电池时，仅可使用 IBM 部件号为 33F8354 的产品或由制造商推荐的同等电池。如果系统中有包含锂电池的模块，则只能使用由相同制造商制造的相同类型模块更换。该电池含有锂，如果使用、操作或处理不当会发生爆炸。

不要：

- 将其投入或浸于水中
- 加热超过100 °C (212 °F)
- 修理或拆卸

应按照当地法规和条例对此电池进行处理。

声明 3



注意！

在已安装 CD-ROM 驱动器的情况下，请注意下面的内容。

不遵循此处指定的控制、调整、或操作过程的操作将可能导致危险的辐射泄漏。

取下 CD-ROM 驱动器的外盖会导致危险的激光辐射泄漏。CD-ROM 驱动器内没有可以使用的部件。请不要取下 CD-ROM 驱动器的外盖。

声明 4

危险！

一些 CD-ROM 驱动器中包含内置的 3A 类或 3B 类激光二极管。
请注意下述内容。

打开驱动器会产生激光辐射。请不要凝视激光束，请不要使用光学仪器直接观看激光束，同时也要避免人体直接暴露在激光束下。

声明 5



32 kg (70.5 磅)



55 kg (121.2 磅)

注意！

搬运机器时，请进行安全搬运操作。

声明 10



注意！

电源线、电话线以及通信电缆中的电流非常危险。为避免人身伤害或设备损坏，除非在安装和配置过程中特别指明，请在打开服务器外盖前断开已连接的全部电源线、电信系统、网络及调制解调器。

• 聲明 1



危險

為了避免雷擊，在閃電期間，請勿連接或拔掉本裝置上的任何電纜線，或請勿安裝、維修或重新架構本產品。

為了避免雷擊：

- 電源線必須連接到接線及接地正確的插座。
- 本產品所連接的設備也必須連接到接線正確的插座。

儘可能使用單手來連接或拔掉信號電纜，以避免因接觸兩不同電位的平面，而受到電擊。

電源、電話及通信電纜上均有電流通過。為了避免電擊，在安裝、移動本產品，或開啓本產品的蓋子或與本產品連接之裝置的蓋子時，請依照下列「連接」及「拔掉」電纜線的步驟操作。

• 聲明 2



注意：

更換電池時，只可使用 IBM 零件編號 33F8354 的電池，或廠商建議的相當類型的電池。如您系統中的模組含有鋰電池，更換時，請使用相同廠商製造的相同模組類型。如未正常使用、處理或捨棄含有鋰的電池時，可能會造成爆炸。

嚴禁：

- 丟入或浸入水中
- 加熱超過攝氏 100 度（華氏 212 度）
- 修補或拆解

處理廢棄電池時，請遵照當地法令規章處理。

連接

1. 關掉所有開關。
2. 首先，將所有電纜線連接到裝置。
3. 將信號電纜連接到信號插座。
4. 將電源線連接到電源插座。
5. 開啓裝置電源。

拔掉

1. 關掉所有開關。
2. 首先，自電源插座拔掉電源線。
3. 拔掉信號插座上的所有信號電纜。
4. 拔掉裝置上的所有電纜線。

• 聲明 3



注意：
安裝光碟機時，請注意下列事項：

不依此處所指示的控制、調整或處理步驟，恐有遭致輻射之虞。

移開光碟機蓋子，恐有遭致雷射輻射之虞。光碟機中沒有需要維修的部分。請勿移開光碟機的蓋子。

• 聲明 4



危險

光碟機含有內嵌式 Class 3A 或 Class 3B 雷射二極體時，請注意下列事項：

開啓時會產生雷射輻射。請勿凝視光束，不要使用光學儀器直接觀察，且應避免直接暴露在光束下。

• 聲明 5

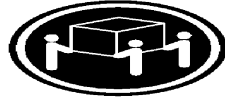

≥ 32 公斤 (70.5 磅)



≥ 55 公斤 (121.2 磅)

注意：
提昇機器時，請使用安全提昇措施。

• 聲明 10



注意：
電源、電話及通信電纜上均有電流通過。在安裝及架構之時，若非專家指導，為了避免人員受傷、設備受損，在開啓伺服器蓋子之前，請切斷電源線、電信系統、網路及數據機。



DANGER

Pour éviter tout risque de choc électrique, ne manipulez aucun câble et n'effectuez aucune opération d'installation, d'entretien ou de reconfiguration de ce produit au cours d'un orage.

Pour éviter tout risque de choc électrique :

- Les cordons d'alimentation du présent produit et de tous les appareils qui lui sont connectés doivent être branchés sur des socles de prise de courant correctement câblés et mis à la terre.

Afin d'éviter tout risque de choc électrique provenant d'une différence de potentiel de terre, n'utilisez qu'une main, lorsque cela est possible, pour connecter ou déconnecter les cordons d'interface.

Le courant électrique passant dans les câbles de communication, ou les cordons téléphoniques et d'alimentation peut être dangereux. Pour éviter tout risque de choc électrique, lorsque vous installez ou que vous déplacez le présent produit ou des périphériques qui lui sont raccordés, reportez-vous aux instructions ci-dessous pour connecter et déconnecter les différents cordons.

| Connexion | Déconnexion |
|--|--|
| 1. Mettez les unités hors tension. | 1. Mettez les unités hors tension. |
| 2. Commencez par brancher tous les cordons sur les unités. | 2. Commencez pas débrancher les cordons alimentation des socles de prise de courant. |
| 3. Branchez les câbles d'interface sur les prises. | 3. Débranchez les câbles d'interface des prises. |
| 4. Branchez les cordons d'alimentation sur un socle de prise de courant. | 4. Débranchez tous les câbles des unités. |
| 5. Mettez les unités sous tension. | |



Attention:

Remplacez la pile usagée par une pile de référence identique exclusivement - voir la référence IBM 36L9077 - ou par une pile équivalente recommandée par le fabricant. Si votre système est doté d'un module contenant une pile au lithium, vous devez le remplacer uniquement par un module identique, produit par le même fabricant. La pile contient du lithium et présente donc un risque d'explosion en cas de mauvaise manipulation ou utilisation.

- Ne la jetez pas à l'eau.
- Ne l'exposez pas à une température supérieure à 100°C.
- Ne cherchez pas à la réparer ou à la démonter.

Pour la mise au rebut, reportez-vous à la réglementation en vigueur.



Attention:

Si une unité de CD-ROM est installée, prenez connaissance des informations suivantes :

Pour éviter tout risque d'exposition au rayon laser, respectez les consignes de réglage et d'utilisation des commandes, ainsi que les procédures décrites dans le présent document.

Pour éviter une exposition directe au rayon laser, n'ouvrez pas l'unité de CD-ROM. Vous ne pouvez effectuer aucune opération de maintenance à l'intérieur.

DANGER

Certaines unités de CD-ROM contiennent une diode laser de classe 3A ou 3B. Prenez connaissance des informations suivantes :

Rayonnement laser lorsque le carter est ouvert. Évitez de regarder fixement le faisceau ou de l'observer à l'aide d'instruments optiques. Évitez une exposition directe au rayon.



≥32 Kg ≥55Kg

Attention:

Ce produit pèse un poids considérable. Faites-vous aider pour le soulever.



Le courant électrique circulant dans les câbles de communication et les cordons téléphoniques et d'alimentation peut être dangereux. Pour votre sécurité et celle de l'équipement, avant de retirer les carters, mettez celui-ci hors tension et déconnectez ses cordons d'alimentation, ainsi que les câbles qui le relient aux réseaux, aux systèmes de télécommunication et aux modems (sauf instruction contraire mentionnée dans les procédures d'installation et de configuration).



VORSICHT

Aus Sicherheitsgründen bei Gewitter an diesem Gerät keine Kabel anschließen oder lösen. Ferner keine Installations-, Wartungs- oder Rekonfigurationsarbeiten durchführen.

Aus Sicherheitsgründen:

- Gerät nur an eine Schutzkontaktsteckdose mit ordnungsgemäß geerdetem Schutzkontakt anschließen.
- Alle angeschlossenen Geräte ebenfalls an Schutzkontaktsteckdosen mit ordnungsgemäß geerdetem Schutzkontakt anschließen.

Signalkabel möglichst einhändig anschließen oder lösen, um einen Stromschlag durch Berühren von Oberflächen mit unterschiedlichem elektrischem Potential zu vermeiden.

Elektrische Spannungen von Netz-, Telefon- und Datenübertragungsleitungen sind gefährlich. Um einen Stromschlag zu vermeiden, nur nach den Anweisungen arbeiten, die für Installation, Transport oder Öffnen von Gehäusen dieses Produkts oder angeschlossenen Einheiten gelten.

| Kabel anschließen | Kabel lösen |
|--|--|
| 1. Alle Geräte ausschalten und Netzstecker ziehen. | 1. Alle Geräte ausschalten. |
| 2. Zuerst alle Kabel an Einheiten anschließen. | 2. Zuerst Netzstecker von Steckdose lösen. |
| 3. Signalkabel an Anschlußbuchsen anschließen. | 3. Signalkabel von Anschlußbuchsen lösen. |
| 4. Netzstecker an Steckdose anschließen. | |
| 5. Gerät einschalten. | 4. Alle Kabel von Einheiten lösen. |



achtung:

Eine verbrauchte Batterie nur durch eine Batterie mit der IBM Teilenummer 36L9077 oder durch eine vom Hersteller empfohlene Batterie ersetzen. Wenn Ihr System ein Modul mit einer Lithium-Batterie enthält, ersetzen Sie es immer mit dem selben Modultyp vom selben Hersteller. Die Batterie enthält Lithium und kann bei unsachgemäßer Verwendung, Handhabung oder Entsorgung explodieren.

Die Batterie nicht

- mit Wasser in Berührung bringen.
- über 100 C erhitzen.
- reparieren oder zerlegen.

Die örtlichen Bestimmungen für die Entsorgung von Sondermüll beachten.



achtung:

Wenn ein CD-ROM-Laufwerk installiert ist, beachten Sie folgendes. Steuer- und Einstellelemente sowie Verfahren nur entsprechend den Anweisungen im vorliegenden Handbuch einsetzen. Andernfalls kann gefährliche Laserstrahlung auftreten.

Das Entfernen der Abdeckungen des CD-ROM-Laufwerks kann zu gefährlicher Laserstrahlung führen. Es befinden sich keine Teile innerhalb des CD-ROM-Laufwerks, die vom Benutzer gewartet werden müssen. Die Verkleidung des CD-ROM-Laufwerks nicht öffnen.

VORSICHT

Manche CD-ROM-Laufwerke enthalten eine eingebaute Laserdiode der Klasse 3A oder 3B. Die nachfolgend aufgeführten Punkte beachten.

Laserstrahlung bei geöffneter Tür. Niemals direkt in den Laserstrahl sehen, nicht direkt mit optischen Instrumenten betrachten und den Strahlungsbereich meiden.



≥32 Kg ≥55Kg

achtung:

Beim Anheben der Maschine die vorgeschriebenen Sicherheitsbestimmungen beachten.



achtung:

An Netz-, Telefon- und Datenleitungen können gefährliche elektrische Spannungen anliegen. Um eine Gefährdung des Benutzers oder Beschädigung des Geräts zu vermeiden, ist der Server auszuschalten. Die Verbindung zu den angeschlossenen Netzkabeln, Telekommunikationssystemen, Netzwerken und Modems ist vor dem Öffnen des Servergehäuses zu unterbrechen (in Installations- und Konfigurationsanweisungen nicht anders angegeben).



PERICOLO

Per evitare il pericolo di scosse elettriche durante i temporali, non collegare o scollegare cavi, non effettuare l'installazione, la manutenzione o la riconfigurazione di questo prodotto.

Per evitare il pericolo di scosse elettriche:

- collegare il cavo di alimentazione ad una presa elettrica correttamente cablata e munita di terra di sicurezza;
- collegare qualsiasi apparecchiatura collegata a questo prodotto ad una presa elettrica correttamente cablata e munita di terra di sicurezza.

Quando possibile, collegare o scollegare i cavi di segnale con una sola mano per evitare il rischio di scosse derivanti dal contatto con due superfici a diverso potenziale elettrico.

La corrente elettrica circolante nei cavi di alimentazione, del telefono e di segnale è pericolosa. Per evitare scosse elettriche, collegare e scollegare i cavi come descritto quando si effettuano l'installazione, la rimozione o l'apertura dei coperchi di questo prodotto o durante il collegamento delle unità.

| Per collegare | Per scollegare |
|---|--|
| 1. SPEGNERE tutti i dispositivi. | 1. SPEGNERE tutti i dispositivi. |
| 2. Collegare prima tutti i cavi alle unità. | 2. Rimuovere prima il(i) cavo(i) di alimentazione dalla presa elettrica. |
| 3. Collegare i cavi di segnale alle prese. | 3. Rimuovere i cavi di segnale dalle prese. |
| 4. Collegare il(i) cavo(i) di alimentazione alla presa elettrica. | 4. Rimuovere tutti i cavi dalle unità. |
| 5. ACCENDERE le unità. | |



ATTENZIONE:

Quando si sostituisce la batteria, utilizzare solo una batteria IBM 36L9077o batterie dello stesso tipo o di tipo equivalente consigliate dal produttore. Se il sistema di cui si dispone è provvisto di un modulo contenente una batteria al litio, sostituire tale batteria solo con un tipo di modulo uguale a quello fornito dal produttore. La batteria contiene litio e può esplodere se utilizzata, maneggiata o smaltita impropriamente.

Evitare di:

- Gettarla o immergerla in acqua
- Riscaldarla ad una temperatura superiore ai 100°C
- Cercare di ripararla o smaltirla

Smaltire secondo la normativa in vigore (D.Lgs 22 del 5/2/97) e successive disposizioni nazionali e locali.



ATTENZIONE:

Quando è installata un'unità CD-ROM, notare quanto segue:

L'utilizzo di controlli, regolazioni o l'esecuzione di procedure non descritti nel presente manuale possono provocare l'esposizione a radiazioni pericolose.

L'apertura di un'unità CD-ROM può determinare l'esposizione a radiazioni laser pericolose. All'interno dell'unità CD-ROM non vi sono parti su cui effettuare l'assistenza tecnica. Non rimuovere i coperchi dell'unità CD-ROM.

PERICOLO

Alcune unità CD-ROM contengono all'interno un diodo laser di Classe 3A o Classe 3B. Prestare attenzione a quanto segue:

Aperto l'unità vengono emesse radiazioni laser. Non fissare il fascio, non guardarlo direttamente con strumenti ottici ed evitare l'esposizione diretta al fascio.



≥32 Kg ≥55Kg

ATTENZIONE:

Durante il sollevamento della macchina seguire delle norme di di sicurezza.



ATTENZIONE:

La corrente circolante nei cavi di alimentazione, del telefono e di segnale è pericolosa. Per evitare situazioni pericolose per le persone o danneggiamenti all'apparecchiatura, scollegare i cavi di alimentazione, i sistemi di telecomunicazioni, le reti e ed i modem prima di aprire i coperchi se non diversamente indicato nelle procedure di installazione e configurazione.

경고문 1



위험

전기 충격을 피하려면 날씨가 나쁠 때(예: 눈 또는 비가 오거나 천둥 번개가 칠 때)는 케이블을 연결하거나 끊지 않도록 하고 이 제품의 설치, 유지보수 또는 재구성 등의 작업을 수행하지 않도록 하십시오.

전기 충격을 피하려면 다음과 같아야 합니다.

- 고압선은 적절한 배선 및 접지 상태의 콘센트로 연결되어야 합니다.
- 이 제품이 접속될 모든 장비도 적절한 배선 상태의 콘센트로 연결되어야 합니다.

다른 전위를 가진 두 표면을 만졌을 때 발생할 수 있는 전기 충격을 피하려면 한 손으로 신호선을 연결하거나 끊으십시오.

전원, 전화 및 통신 케이블로부터 흘러 나오는 전류는 위험합니다. 전기 충격을 피하려면 이 제품이나 접속 장치를 설치, 이동 및 덮개를 열 때 다음 설명에 따라 케이블을 연결하고 끊도록 하십시오.

| 연결하려면 | 연결해제하려면 |
|-------------------------|-------------------------|
| 1. 모든 스위치를 켜다. | 1. 모든 스위치를 끈다. |
| 2. 먼저 모든 케이블을 장치에 연결한다. | 2. 먼저 모든 케이블을 장치에 제거한다. |
| 3. 신호선을 콘센트에 연결한다. | 3. 신호선을 콘센트에서 제거한다. |
| 4. 전원을 콘센트에 연결한다. | 4. 장치에서 모든 케이블을 제거한다. |
| 5. 장치 스위치를 켜다. | |

경고문 2



주의:

배터리를 교체할 때는 IBM 부품 번호 &PN. 또는 제조업체에서 추천하는 동등한 유형의 배터리를 사용하십시오. 시스템에 리튬 배터리를 포함하는 모듈이 있으면 이것은 동일한 제조업체에서 생산된 동일한 모듈 유형으로만 교체하십시오. 배터리에 리튬이 포함되어 있으므로 제대로 사용, 처리 또는 처분하지 않으면 폭발할 수 있습니다.

다음은 주의하십시오.

- 먼지거나 물에 닿지 않도록 하십시오.
- 100°C(212°F) 이상으로 가열하지 않도록 하십시오.
- 수리하거나 분해하지 않도록 하십시오.

지역 법령이나 규정의 요구에 따라 배터리를 처분하십시오.

경고문 3



주의:

CD-ROM 드라이브가 설치되어 있으면 다음 사항을 명심하십시오.

여기에서 지정하지 않은 방식으로 CD-ROM 드라이브를 제어 또는 조절하거나 다른 절차로 사용하면 위험한 방사능 노출이 발생할 수 있습니다.

CD-ROM 드라이브의 덮개를 제거하면 위험한 레이저 방사능이 노출될 수 있습니다.

CD-ROM 드라이브 내에는 정비할 수 있는 부품이 없습니다. CD-ROM 드라이브 덮개를 제거하지 않도록 하십시오.

경고문 4

위험

일부 CD-ROM 드라이브에는 클래스 3A 또는 3B 레이저 2급
진공관(다이오드)이 들어 있습니다. 다음 사항을 명심하십시오.
열면 레이저 방사능이 노출됩니다. 광선을 주시하거나 광학 기계를
직접 쳐다보지 않도록 하고 광선에 노출되지 않도록 하십시오.

경고문 5



32kg(70.5 파운드)



55kg(121.2 파운드)

주의:
기계를 들 때는 안전하게 들어 올리십시오.

경고문 10



주의:
전원, 전화 및 통신 케이블로부터 흘러 나오는 전류는 위험합니다. 설치 및 구성 절차에
다른 지시가 없으면, 다치거나 장비 손상이 생기지 않게 하기 위해 서버 덮개를 열기
전에 접속된 전선, 원격 통신 시스템, 네트워크 및 모뎀의 연결을 끊으십시오.



PELIGRO

Para evitar una posible descarga eléctrica, no conecte ni desconecte los cables ni lleve a cabo ninguna operación de instalación, de mantenimiento o de reconfiguración de este producto durante una tormenta eléctrica.

Para evitar una posible descarga:

- El cable de alimentación debe conectarse a un receptáculo con una instalación eléctrica correcta y con toma de tierra.
- Los aparatos a los que se conecte este producto también deben estar conectados a receptáculos con la debida instalación eléctrica.

Cuando sea posible, utilice una sola mano para conectar o desconectar los cables de señal a fin de evitar una posible descarga al tocar dos superficies con distinto potencial eléctrico.

La corriente eléctrica de los cables de comunicaciones, teléfono y alimentación puede resultar peligrosa. Para evitar una posible descarga, siga las indicaciones de conexión y desconexión de los cables siempre que tenga que instalar, mover o abrir las cubiertas de este producto o de los dispositivos acoplados.

| Instrucciones de conexión | Instrucciones de desconexión |
|--|--|
| <ol style="list-style-type: none">1. Apague todos los componentes (OFF).2. En primer lugar, conecte todos los cables a los dispositivos.3. Conecte los cables de señal a los receptáculos.4. Conecte los cables de alimentación a las tomas.5. Encienda el dispositivo (ON). | <ol style="list-style-type: none">1. Encienda todos los componentes (ON).2. En primer lugar, retire los cables de alimentación de las tomas.3. Retire los cables de señal de los receptáculos.4. Retire todos los cables de los dispositivos. |



Caution:

Al cambiar la batería, utilice únicamente la batería IBM Número de pieza 36L9077 o un tipo de batería equivalente recomendado por el fabricante. Si el sistema tiene un módulo que contiene una batería de litio, sustitúyalo únicamente por el mismo tipo de módulo del mismo fabricante. La batería contiene litio y puede explotar si no se utiliza, manipula o desecha correctamente.

Lo que no debe hacer

- Tirar o sumergir el producto en agua.
- Exponer el producto a una temperatura superior a 100°C.
- Reparar o desmontar el producto.

Cuando quiera desechar la batería, siga las disposiciones y reglamentaciones locales.



Caution:

Cuando instale una unidad de CD-ROM, tenga en cuenta la siguiente información.

Si se llevan a cabo controles o ajustes o se utilizan métodos que no se atengan a lo aquí especificado, se puede producir una exposición peligrosa a las radiaciones.

Si se retiran las cubiertas de la unidad de CD-ROM, se puede producir una peligrosa exposición a radiaciones de láser. Dentro de la unidad de CD-ROM no existen piezas reparables. No retire las cubiertas de la unidad de CD-ROM.

PELIGRO

Algunas unidades de CD-ROM tienen incorporado un diodo de láser de Clase 3A o de Clase 3B Tenga en cuenta la siguiente información.

Cuando la unidad está abierta se generan emisiones de rayos láser. No dirija la mirada al haz, no lo observe directamente con instrumentos ópticos y evite la exposición directa.



Caution:

Alce la máquina con cuidado; el sobrepeso podría causar alguna lesión.



Caution:

La corriente eléctrica de los cables de comunicaciones, de teléfono y de alimentación puede resultar peligrosa. Para evitar posibles lesiones o daños del aparato, desconecte los cables de alimentación, los sistemas de telecomunicaciones, las redes y los módems antes de abrir las cubiertas del servidor, salvo que se indique lo contrario en las instrucciones de las operaciones de instalación y configuración.

Laser Compliance Statement

The CD/DVD-ROM drive in the computer is a laser product. The CD/DVD-ROM drive's classification label (sample shown below) is located on the drive.

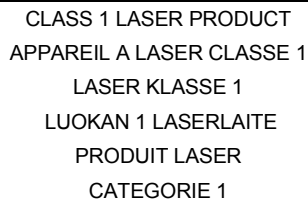

CLASS 1 LASER PRODUCT
APPAREIL A LASER CLASSE 1
LASER KLASSE 1
LUOKAN 1 LASERLAITE
PRODUIT LASER
CATEGORIE 1

The CD/DVD-ROM drive is certified in the U.S. to conform to the requirements of the Department of Health and Human Services 21 Code of Federal Regulations (DHHS 21 CFR) Subchapter J for Class 1 laser products.

In other countries, the drive is certified to conform to the requirements of EN60825.

Class 1 laser products are not considered to be hazardous. The CD/DVD-ROM drive has an internal Class 1, 0.5-milliwatt, aluminum gallium-arsenide laser that operates at a wavelength of 760 to 810 nanometers.

The design of the laser system and the CD/DVD-ROM drive ensures that there is no exposure to laser radiation above a Class 1 level during normal operation, user maintenance, or servicing conditions.

Trademarks

The following are trademarks of the IBM Corporation in the United States or other countries or both:

| | |
|--------------------|------------------|
| Operating System/2 | OS/2 |
| AT | Personal System2 |
| HelpCente | PS/1 |
| IBM | PS/2 |

AMD Duron and AMD Athlon are trademarks of Advance Micro Device, Inc.

Microsoft, MS-DOS, Windows, and Windows NT are trademarks or registered trademarks of Microsoft Corporation.

Other company, product, and service names may be trademarks or service marks of others.

Preface

This manual contains service information for the **Service Level A (SL-A)** model of the IBM Personal Computer, worldwide.

This manual is intended to be used as a stand-alone document to service Machine Types 2255 and 2275 product. It is divided into the following chapters:

Notices contain important safety information and notices required to service this computer.

General Information contains a brief description of this manual.

Check Procedures provide step-by-step instructions that aid in locating the failure Field Replaceable Unit (FRU).

Diagnostic Aids explain how to use the diagnostics tools for isolating failures.

Repairing Information contains illustrations and descriptions to disassemble and reassemble the computer.

Parts/Test Point Locations contains illustrations and descriptions of the locations of the major parts, jumpers, and connectors.

Safety Inspection Guide contains information about inspecting a machine for safety problems before putting the machine under a Maintenance Agreement.

Parts Catalog contains descriptions, illustrations, and part numbers for individual FRUs.

Appendix A, Online Support Information contains online support information.

Index contains specific terms and words in alphabetical order.

General Information

| | |
|--|-----------|
| General Information | 33 |
| Introduction..... | 34 |
| Product Overview..... | 35 |
| Hardware Interfaces..... | 38 |
| CMOS Reset..... | 39 |
| Flash (BIOS) Update Procedure..... | 40 |
| BIOS-contained Model Number and Serial Number..... | 41 |
| BIOS Setup Utility..... | 42 |
| Working with the Setup Menus..... | 42 |
| Start Options..... | 45 |
| Advanced Setup..... | 47 |
| Power Management Setup..... | 47 |
| Set Administrator Password..... | 48 |
| Set Password..... | 48 |
| Specifications..... | 49 |
| Operating Requirements..... | 50 |
| Special Tools..... | 51 |

Introduction

This chapter gives a general overview of the Machine Types 2255 and 2275, describes the standard and optional features, and details functional and environmental specifications. Machine Type 2275 is a micro tower model, and machine Type 2255 is a desktop model.

Product Overview

All machine Types mentioned above contain three PCI slots, and the system board supports AMD Duron microprocessor with 128KB L1 cache and 64KB L2 cache or AMD Athlon microprocessor with 128KB L1 cache and 256 L2 cache memory.

Listed below are system features:

Processors (Machine Types 2255 and 2275)

- Socket A (462 pins)
- Detachable CPU heat sink with fan.
- One of the following processors:
 - AMD Duron 700 MHZ CPU
 - AMD Duron 750 MHZ CPU
 - AMD Duron 800 MHZ CPU
 - AMD Duron 850 MHZ CPU
 - AMD Duron 900 MHZ CPU
 - AMD Athlon 1 GHZ CPU, Low Power

Memory

- 168-pin synchronous dynamic random access memory (SDRAM), dual inline memory module (DIMM) sockets.
 - 2 memory sockets.
 - 64-MB or 128-MB DIMM.
 - Maximum memory is 512MB.

External Ports

- Video port (15-pin D-sub connector)
- Parallel port (25-pin D-sub connector)
- Serial port (9-pin D-sub connector)
- Game/MIDI port (15-pin D-sub connector), some models only
- Keyboard port (6-pin PS/2 mini-din connector)
- Mouse port (6-pin PS/2 mini-din connector)
- Three or four USB ports
- 10/100 Mbps Ethernet port
- Microphone-in jack
- Line-out jack
- Line-in jack
- Speaker out connector (some models only)

- S/PDIF connector (some models only)
- IEEE 1394 port (some models only)

Diskette Drive

- AT-type
- 3.5-in. 1.44MB diskette drive.

Hard Disk Drive

- 3.5-in., 1-in.height IDE AT drive.
- 512 KB cache buffer in hard disk drive.
- Average and minimum 11.1 ms seek-time, access time varies for the hard disk drive and the hard disk drive manufacturer.

CD-ROM Drive

- 5.25-in. high-performance, 48X CD-ROM IDE/AT drive.
- Read data and play audio from standard and mini CD-ROM and audio compact discs (audio CDs).

Power Management

- Compliant to ACPI and supports display power management signaling (DPMS) monitor.
- Software shutdown by Windows Millennium.
- System enters standby mode if any of following conditions are met:
 - Execute standby from the Windows Millennium Start menu
 - Press system power button if it is set to act as standby function. See "Power Management Setup" on page 47.
 - Standby timer set in the Windows Millennium Power Utility Timer elapses without system activity.
- Monitor enters standby mode if:
 - Windows Millennium Power Utility Timer elapses
 - System sleep timer elapses.
- Hard Disk shutdown by Windows Millennium to reduce power consumption.

Power Supply

- 120-watt switchable high/low voltage power supply for desktop model (machine type 2255).
- 155-watt switchable high/low voltage power supply for micro-tower model (machine type 2275).

Internal Cabling

- 40-pin ribbon cable for CD-ROM and 80-pin ATA-100 signal cable for hard disk drive.
- One 34-pin ribbon cable for AT diskette drive.

- One 4-pin (2-wire) cable for hard disk drive light-emitting diode (LED) and (3-wire) cable for power light-emitting diode (LED).
- One 2-pin (2-wire) cable for power switch.
- One 4-pin (3-wire) cable for CD-ROM audio-in.
- One 20-pin ribbon cable for daughter board bezel supports USB, S/PDIF, Volume Control, Head Phone jack, and Microphone jack (or USB, USB, S/PDIF, Volume Control, Head Phone jack, and Microphone jack). (On some models only)
- One 4-pin (3-wire) cable for passive speaker.
- One cable for S/PDIF and speaker out. (On some models only)
- Dual USB cable
- One 40-pin ribbon cable for PCMCIA. (On some models only)
- One 6-pin (6-wire) cable connected to IEEE 1394 PCI adapter card for IEEE 1394 port in front panel. (On some models only)

Modem

- 56Kbps PCI Plug and Play modem adapter card with data/fax features.
- Telephone line-out (RJ-11) connector.
- Telephone line-in (RJ-11) connector.

IBM Monitor

- Super video graphics array (SVGA) monitor.
- Compliant to VESA power saving mode.
- Connector for a detachable grounded 3-wire power cord.
- 1.8-m (5.8-ft) attached signal cable.
- Auto-sensing power input for 100 V ac to 240 V ac.

Keyboard

- USB RAK3e, w/o Hub, w/Palm Rest, Stealth Black IBM Keyboard. Keyboard is Geography/Model dependent.

Mouse

- PS/2 mouse (some models), standard 2-button mouse (some models) connected to the mouse port with 1.8-m (5.8-ft) cable.

Hardware Interfaces

The following peripheral interfaces for adapters, options, and drives are supported in the system unit.

| Table 1-1 System Board Hardware Interfaces | |
|--|--|
| Item | Interface |
| Expansion slot for I/O adapter cards | Three PCI (peripheral component interconnect) v2.1 compatible expansion slots that operate at 33 MHz bus speed. PCI slot 1 can hold a short (175mm) PCI adapter card. PCI slot 2 can hold a PCI adapter card measuring 165 mm in length (or less). PCI slot 3 can hold a PCI adapter card measuring 236 mm in length (or less). The desktop model (machine type 2255) only supports low profile PCI interface. (169mm) |
| Hard Disk Drives | Dual UltraDMA33/66 interface for hard disk drive that supports up to ATA100. |
| CD-ROM/CD-RW/DVD-ROM Drive | 5.25-in. high-performance, forty speed (48X) CD-ROM IDE/AT drive Support Bootable CD-ROM Format specification version 1.0. Compliant to Audio-CD, Video-CD, CD-ROM/XA, Karaoke-CD, and Photo-CD (both single and multi-session) format. |
| Diskette Drive | AT diskette interface |
| Video | Physical interface is compatible with the IBM Personal System/2 (PS/2) VGA interface. VIA VT8364 VGA Onboard. |
| Modem | One 56Kbps PCI Plug and Play modem adapter card with data/fax features. |
| Audio | All models use Cirrus Logic 4299 Codec. |
| Pointing device | IBM PS/2-compatible mouse |
| Keyboard device | IBM USB RAK3E keyboard |
| Serial port | 9-pin connector with RS232D electrical interface |
| Parallel port | Supports SPP (IBM PC/AT, PS/2) compatible, EPP (IEEE 1284 compliance), ECP (IEEE 1284 compliance) interface. |
| Game port | Game port interface for joystick. |
| Ethernet Port | Ethernet Onboard |
| USB | USB controller integrated in core logic chip set. |

CMOS Reset

This system does not deny access to the BIOS Setup Utility. Execute "Load BIOS Default Settings" in BIOS Setup to clear the corrupted CMOS data. See "Load Optimized Defaults" on page 48.

Flash (BIOS) Update Procedure

NOTE: The flash update procedure does not change the model number and serial number information in BIOS.

The following procedure is for the models come with the diskette.

1. Prepare a bootable DOS diskette with AWDFLASH.EXE and VXXYYZZ.BIN files

NOTE: The AWDFLASH.EXE is a flash utility program. The VXXYYZZ.BIN is a BIOS source code binary file.

2. Insert the diskette and boot from drive A.

WARNING: Do not boot with any memory related driver such as HIMEM.SYS, EMS.SYS .

3. At the DOS prompt, type **A: > AWDFLASH VXXYYZZ.BIN** and then press **Enter**.
4. The screen shows: "Do You Want To Save Bios (Y/N)". Type **Y** if you want to save old bios data and **N** if you do not.
5. When the screen shows: "Are You Sure To Program (y/n)", type **Y** to flash and update the system bios.
6. The program updates the BIOS automatically.
7. Wait for the update to complete.

WARNING: Do not turn off the system power while the BIOS is programming, or the flash ROM will be destroyed.

8. Press **F1** to Reset (or press **F10** to exit) the system after the BIOS is completely updated.

The following procedure is for the FDDless models.

For the FDDless models, there is a factory-executed program run before F2 (functional test 2) to load FDDless default setting and the startup sequence will be USB FDD, HDD and then CD-ROM. That's to say, servicer should bring USB FDD as fixture and follow the procedure stated (step 1 ~ step 8) above to flash the BIOS.

BIOS-contained Model Number and Serial Number

The model number and serial number information is stored in BIOS ROM and displayed in the “Product Data” of BIOS Setup main menu. If a repair is completed by replacing the system board or installing a new BIOS ROM, then you need to enter the original system model number and serial number in the new BIOS ROM.

To enter the model number and serial number into BIOS:

The following procedure is for the models come with the diskette.

1. Prepare a bootable DOS diskette with VPD.EXE files.
2. Insert the diskette and boot from drive A.
WARNING: Do not boot with any memory related driver such as HIMEM.SYS, EMS.SYS.
3. At the DOS prompt, type **A: >VPD** then press **Enter**. You will be asked if you want to update the serial number, type **Y** to continue. When the screen shows:

Serial Number:

Enter the serial number and press **Enter** to continue. You can type a maximum of 7 characters (without spaces).

Follow the instructions on the screen to complete the procedure.

4. Type **A: >VPD** and press **Enter** to display and verify your input model number and serial number information.

The following procedure is for the FDDless models.

For the FDDless models, there is a factory-executed program run before F2 (functional test 2) to load FDDless default setting and the startup sequence will be USB FDD, HDD and then CD-ROM. That's to say, servicer should bring USB FDD as fixture and follow the procedure stated (step 1 ~ step 4) above to verify the model number and serial number information.

BIOS Setup Utility

The Setup Utility lets you review and change important information about the computer and its hardware.

Working with the Setup Menus

Starting the Setup Utility

Follow these steps to enter Setup when the computer is off:

1. Turn on your monitor.
2. Turn on the system unit.
3. When you see the IBM logo, press **F1** to enter Setup and display the Main Menu.

Refer to the Setup Utility Main Menu below.

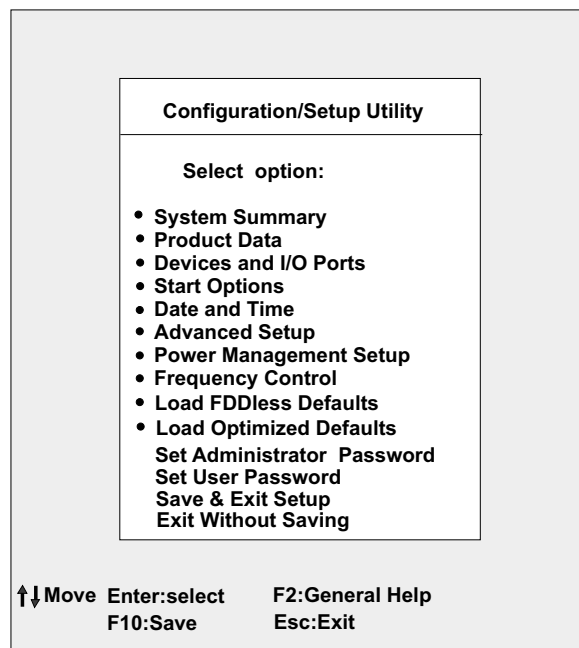

The following table lists specific keys on the keyboard that will help you move through the Setup menus:

| Keys | Function |
|--------------------------|---|
| Down- or up-arrow key | Use these arrow keys to highlight an option on the menu. (Press the Enter key to choose the option.) |
| Left- or right-arrow key | Use these arrow keys to make a selection and change an option's setting. In some menus, you can use these keys to move from one field to another. |
| F10 | Press this key to save your changes. |
| Enter | Press this key to select a highlighted option from a menu. |
| F2 | Press this key if you want help for a selected item in a menu. |
| Esc | After viewing or making changes to the settings on a menu, press this key to exit the menu. |
| + - | Use the + and – keys to change the value in the Date and Time setting. |

Changing Parameter Settings

In the Setup menus, the configuration information that you can change is enclosed in brackets like these: []. You cannot change any information that is not enclosed in brackets. Use the up- or down-arrow keys to highlight options then press Enter to display a menu. When changing the setting of a particular parameter, highlight the setting then use the left- or right-arrow key to change the setting.

System Summary

Choose this option to learn the system configuration of this machine. The pop-up menu will show the processor type, processor speed, L1 cache status, L2 cache status, system memory speed, Drive A type, Drive B type, IDE Primary Master, IDE Primary slave, IDE Secondary Master, IDE Secondary Slave and system memory total.

Product Data

This pop-up menu will show the following information of the system.

Machine Type/Model

Flash EEPROM Revision Level

System Serial Number

BIOS Date

BIOS Mode

Device and I/O Ports

Select this option to configure the onboard I/O, IRQ, and DMA assignment of the system.

Drive A

Determines the type of Drive A. (Optional items: None; 720K, 3.5 in.; 1.44M, 3.5 in.)

Drive B

Determines the type of Drive B. (Optional items: None; 720K, 3.5 in.; 1.44M, 3.5 in.)

PS/2 Mouse Function Control

Disabled: Remove any installed PS/2 mouse from functioning but frees up IRQ 12.

Enabled: Allow the operating system to determine whether to enable or disable the mouse.

Serial Port Setup

Select this option to configure serial port. The initial setting is [2F8/IRQ3].

Parallel Port Setup

Select this option to configure parallel port. There are sub-options on the pop-up menu shown as following.

Onboard Parallel Port (Optional items: Disabled; 3BC/IRQ 7; 378/IRQ7; 278/IRQ5)

Onboard Parallel Mode (Optional items: Normal; EPP; ECP; ECP/EPP)

USB Setup

Select this option to configure the Universal Serial Bus. There are sub-options on the pop-up menu shown as following. You can choose the proper settings of this option once there is USB device attached to the system.

OnChip USB

Legacy USB Keyboard Support

Legacy USB Mouse Support

IDE Drives Setup

Select this option to enable or disable the IDE controller.

Video Setup

Select this menu item to modify the video settings.

AGP Aperture Size (Optional items:4/8/16/32/64/128 M)

AGP-4X Mode (Enable or Disable this option to get the difference performance of video)

AGP Master 1 WS Write

AGP Master 1 WS Read

Init Display First

Specify which video subsystem to initialize first. Select [PCI Slot] to enable video on the PCI slot first. Select [OnBoard] to enable on board VGA first.

Frame Buffer Size

Select this item to specify the frame buffer size of 8M/16M/32M.

Assign IRQ for VGA

Select this option to have the VGA IRQ assignment.

VIA OnChip PCI Device

Select this option to enable or disable the AC97 Audio function, OnBoard LAN function, OnBoard Legacy Audio, Sound Blaster, Game Port, and so on.

PS/2 Mouse Detect Function

Determines whether the power-on selftest will check if there is a mouse attached to the mouse connector.

Onboard FDD Controller

Allow you to enable or disable the diskette drive (floppy disk drive) controller.

Startup Sequence

This setting controls which devices your computer will attempt to read data from when it is started.

Your computer can be started from several devices, including the hard disk drive, diskette drive, and CD-ROM drive. The startup program looks for these devices in a selected sequence. The startup sequence on your computer is preset from the factory to have the computer start up from a diskette, hard disk and CD-ROM. The startup sequence allows you to start the diagnostic and recovery programs from the Product Recovery and Diagnostics CD, use emergency diskettes to recover from a startup failure, and start from your hard disk for normal day-to-day operation. In order to boot from the CD-ROM, place CD Drive before HDD in the boot sequence list.

Start Options

Setup automatically updates this menu when you do either of the following:

- Add or change hardware on your computer
- Make changes to other menus in Setup and save those changes

To view the computer information such as the model number, serial number, and BIOS version and date, select the **Standard CMOS Setup** option from the Setup main menu. The items displayed are not configurable.

Virus Warning

Determines if the BIOS will monitor the boot sector and partition table of the hard disk drive for any attempt at modification. If any attempt is made, the BIOS will halt the system and an error message will appear.

Afterwards, if necessary, you will be able to run an anti-virus program to locate and remove the problem before any damage is done.

CPU L2 Cache ECC Checking

Select this option to set the CPU L2 cache ECC (Error Checking Correcting) control.

Quick Power On Self Test

Speeds up Power On Self Test (POST) after you power up the computer. If it is set to Enabled, BIOS will shorten or skip some check items during POST.

Swap Floppy Drive

If the system has two floppy drives, choose enable to assign physical drive B to logical drive A and vice-versa.

Boot Up Floppy Seek

Select **Enabled** to test the Floppy drive during **POST**.

Boot Up Numlock Status

Determines the default state of the numeric keypad. By default, the system boots up with NumLock on.

Gate A20 Option

This setting allows you to select how gate A20 is handled. Initially, gate A20 was handled via a pin on the keyboard. Today, the system chipset provide more common and much faster support than keyboards.

Typematic Rate Setting

Determines if the typematic rate is to be used. When disabled, continually holding down a key on your keyboard generates only one instance. In other words, the BIOS will only report that the key is down. When the typematic rate is enabled, the BIOS will report as before, but will wait a moment. If the key is still down, it will report that the key has been depressed repeatedly. You might use this feature to accelerate cursor movements with the arrow keys.

Typematic Rate (Chars/Sec)

When the typematic rate is enabled, you can select the rate at which the keys are accelerated.

Typematic Delay (Msec)

When the typematic rate is enabled, you can select the delay between when the key was first depressed and when the acceleration begins.

Report No FDD For WIN 95

Select [Yes] will report no floppy drive to the operating system.

Halt When Error Occurrence

This option allows system halt when POST error occurs. Select "Enabled" system will halt and "Disable" system will halt for 5 seconds then POST continues.

Halt on

Use this setting to determine under what conditions the power-on self test (POST) will halt when errors are detected.

| | |
|-------------------|--|
| ALL errors | System halts in case of any errors |
| No errors | System won't halt in case of any errors |
| ALL, But keyboard | System halts except for the keyboard error |
| ALL, But diskette | System halts except for the diskette error |
| ALL, But disk/key | System halts except for the diskette or keyboard error |

Date and Time

Allow you to set the date and time.

Advanced Setup

You can set up some advanced hardware features in this function. If they are configured incorrectly, the system might malfunction.

Cache Control

Determines whether the internal or external cache will be enabled or disabled. If enabled, the memory access will speed up.

ROM Shadowing

- **Video BIOS Shadowing** option determines whether video BIOS will be copied to RAM. However, it is optional depending on chipset design. Video Shadow will increase the video speed.

Chipset feature

Select this line to see the chipset menu.

Power Management Setup

The Power Management Setup allows you to configure your system to most effectively save energy while operating in a manner consistent with your own style of computer use.

APM

Select this item to set APM options. There are several items could be chosen for power saving settings. You can choose the proper time frame of Power management, HDD Power Down and Doze Mode. Select [Yes] or [No] on PM by APM to define whether the power management is controlled by APM.

Activity Monitor

Select this item to set up those system activities that will be monitored for automatic power management.

Automatic power on

Select this item to control Automatic power on when your system is unattended.

ACPI Suspend Type

Select this option to set mode S1 or S3 when entering StandBy.

Frequency Control

This setting allows you to change the clock rate of CPU, SDRAM, DIMM and PCI bus.

Load FDDless Defaults

For models that do not include a diskette drive, this option allows you to reload optimized settings for operating without a diskette drive.

If you have made changes in Setup but would like to restore the default settings, follow these steps:

1. From the Configuration/Setup Utility menu, highlight the option, then press Enter. A dialog box appears confirming if you want to Load FDDless Defaults.
2. Type Y to select Yes, then press Enter.

3. Highlight the Save & Exit Setup Option, then press Enter. A dialog box appears
SAVE to CMOS and EXIT(Y/N)?

Load Optimized Defaults

When you purchase an IBM personal computer, it is already configured for use. The original configuration settings, also called factory or default settings, are stored in the CMOS. Setup includes an option Load Optimized Default Settings that allows you to reload the original configuration at any time.

If you have made changes in Setup but would like to restore the default settings, follow these steps:

1. From the main menu, highlight the option Load Optimized Default Settings then press Enter. A dialog box appears confirming if you want to load the default settings.
2. Type **Y** to select YES, then press **Enter**
3. Highlight the option **Save & Exit Setup**, then press **Enter**.
4. Type **Y** to select Yes, then press **Enter** to save the changes in CMOS.

You must load the Setup default settings in the following instances:

- When you replace the system battery
- When you customize your system configuration settings and some resource assignments conflict causing the computer to hang.

Set Administrator Password

Supervisor password controls the access to the setup utility.

Set Password

In this option, you can create a password to restrict access to the Setup Utility or to your System. You can also change or remove the password.

If you set up a password for entering setup, you must type this password each time you want to enter the Setup utility. If you do not type the correct password, you cannot enter Setup.

If you set up a system password, you must type this password each time you power on your system.

Exiting Setup (Save & Exit Setup/Exit Without Saving)

Press Esc to return to the main menu when you have finished viewing settings and making changes. From this location, you can exit Setup and save your changes or exit without saving your changes.

Follow these steps to exit Setup:

1. From the main menu, press the **Esc** key.
2. The Exit Setup dialog box appears saying Quit Without Saving (Y/N)? Type **Y** if you want to quit directly.

You also can Exit the Setup via highlighting the **Save & Exit Setup** option or **Exit without Saving** option and follow the dialog box directions.

Specifications

Dimensions (width x depth x height):

- System unit:
 - For machine type 2255:
 - 305 mm (12.2 in.) x 88 mm (3.5 in.) x 380 mm (14.9 in.)
 - For machine type 2275:
 - 385 mm (15 in.) x 192 mm (7.5 in.) x 388 mm (15.2 in.)

Weight:

- System unit:
 - For machine type 2255:
 - 8.5 kg (18 lb)
 - For machine type 2275:
 - 9.3 kg (20 lb)

Environment:

- Temperature for system unit:
 - Power on: 10° to 35°C (50° to 95°F)
 - Power off: 10° to 43°C (50° to 110°F)
- Humidity for system unit:
 - Power on: 8% to 80%
 - Power off: 8% to 80%
- Altitude for system unit:
 - 7,000 feet

Power consumption:

- System unit:
 - Maximum: 120-watts for machine type 2255.
 - Maximum: 155-watts for machine type 2275.

Electrical input:

- Input voltage for system unit (Sine-wave input is required) :
 - Low Range: 90 V ac to 137 V ac
 - High Range: 180 V ac to 265 V ac

Operating Requirements

All machines require two power inputs: one on the system unit and one on the monitor display.

The system unit comes with a voltage selector switch, allowing selection of either 115 V ac or 230 V ac. This switch must be in the 230 V ac position when the machine is plugged into a 230 V ac electrical outlet.

Special Tools

The following special tool is required to service this system when running the diagnostics program (PC-Doctor):

- Wrap plug, P/N 72X854

Check Procedures

| | |
|---|-----------|
| Check Procedures | 53 |
| Introduction..... | 54 |
| Start..... | 55 |
| Index of Symptoms, Messages, Error Codes, or Beeps..... | 60 |
| Troubleshooting..... | 70 |
| Factory-Installed Storage Devices..... | 71 |
| Factory-Installed Modem Card..... | 73 |
| Audio (Not Supported by Diagnostics Program)..... | 75 |
| CD-ROM Drive..... | 76 |
| Memory..... | 78 |
| Keyboard..... | 78 |
| Mouse..... | 79 |
| Power Supply..... | 81 |
| Monitor..... | 83 |
| Undetermined Problems..... | 84 |

Introduction

This chapter contains the check procedures used to diagnose the causes of product failures. The diagnostic information consists of:

Start: This is the starting point for any diagnostic action. Based on high-level symptoms, the check procedure directs you to more detailed procedures to help resolve machine failures.

Index of Symptoms, Messages, Error Codes, or Beeps: The tables for BIOS Error Messages, Codes, Beeps, and Error Symptoms list symptoms along with their probable causes, and direct you to the applicable check procedures to help resolve machine failures. These tables also list the field replaceable units (FRUs) most likely to cause a particular problem.

Check Procedures: When the Start check procedure or the Index of Symptoms, Messages, Error Codes, or Beeps tables point you to a specific check procedure, proceed to that section. If there are any notes or instructions at the top of the page, read them before you begin with the procedure. Carefully read each step of the check procedure and perform the steps as instructed. If you do not remember the location of a specific part or test point, or an adjustment or removal procedure, see the chapter that contains that information. Always return to the check procedure after you do this. In some cases, you are referred to other check procedures to detect the cause of the failure.

Start

This is the entry point for all check procedures. The check procedures use failure symptoms, Power-On Self Test (POST) error codes, or beeps to help determine the defective field replaceable unit (FRU). Follow the suggested check procedures or use the diagnostics diskette to determine the problem FRU.

IMPORTANT: Replace FRUs ONLY when it is determined that the error is not a result of software, loose contacts, or dirty component surfaces. Any FRU change should be verified by running a complete test (**Diagnostics - All Tests** in PC-Doctor diagnostics program).

This book comes with a diagnostic program diskette. This diskette should be used ONLY with **Machine Types 2255 and 2275**. Do not use this diskette on other models.

POST error codes and error messages are displayed on the screen after the IBM logo. A beep will precede each error code or message. Please refer to "Index of Symptoms, Messages, Error Codes, or Beeps" on page 60 for additional help.

All voltages in the check procedures are positive unless otherwise indicated. Use frame ground for all voltage checks unless otherwise specified.

IMPORTANT: There is a voltage selector on the rear panel of the machine. Use a flat-head screwdriver to turn the voltage selector to the voltage setting for the area in which you will be using the system.

NOTE: If the check procedures instruct you to replace a FRU and the error message persists, an option adapter card might be causing the failure. Remove all option adapter cards, one at a time, until the error changes or the problem is no longer apparent. The problem may be in the last card that you removed or something associated with it.

The Recovery CD contains pre-loaded software that may reinstall the original software and recover the system. Ensure that data and programs on the hard drive have a backup copy.

How to Diagnose Combined FRUs: If an adapter or device consists of more than one FRU, any of the FRUs might cause an error code. Before replacing the device or adapter, remove the FRUs one by one to see if the symptoms change.

If a newly replaced FRU does not correct the problem: If you have reached this point of the check procedures and were instructed to replace a FRU but doing so did not correct the problem, reinstall the original FRU and go through "Start" again.

If you want to print a copy of a BIOS Setup Utility screen to an attached printer, press **Print Screen** key, while the screen is displayed.

PLEASE READ THE FOLLOWING:

Human Error is a cause for concern when applied to check procedures. It exists in every first time set of analysis procedures. It is therefore essential for effective and time-efficient servicing that each stage of every procedure be verified. (For example: When a symptom is found, or when a symptom appears to have been cured; the preceding steps should be repeated for accuracy of analysis.)

001 - START

To begin, note the following:

- Disable the setting of "Quick Power-On Self Test" from BIOS Setup.
- Disconnect all external cables and devices including speakers and microphone from the system unit, except for the keyboard, mouse, and monitor.
- Power off the system unit before moving it or when replacing FRUs.
- Remove all adapter cards, except for the factory-installed modem adapter card and any other IBM factory-installed adapter cards.
- Disconnect any drives except:
 - 3.5-in. diskette drive
 - Hard disk drive
 - Factory-installed devices (such as a CD-ROM drive)
- Make sure that all power cords and cables are connected properly.
- Make sure that the monitor brightness and contrast controls are not turned down.
- Power on the system unit.

NOTE: Some monitors have a detachable system I/O signal cable between the monitor and the system unit. In this case, check this signal cable before replacing the unit. See "Monitor Port Signals" on page 130 for pin identification.

- Make sure that the monitor refresh rate is correct.
- Note any symptoms, messages, error codes, or beeps.
- Make sure that there are no diskettes or CDs in the drives.

002 - DOES AN IBM LOGO SCREEN APPEAR? (YES, READ AHEAD. NO, GO TO STEP 004.)

- Insert the diagnostics diskette in the diskette drive.

003 - DOES SYSTEM LOAD THE DIAGNOSTICS PROGRAM FROM THE DISKETTE DRIVE? (YES, READ AHEAD. NO, GO TO STEP 004.)

- Follow the instructions on the screen and select **Utility** from the diagnostics program menu.
- Select **Tech Support Form** from the menu, press F5 to execute, then generate a system configuration report.
- Compare the system configuration list with the actual devices installed in system.

NOTE: If necessary, remove the machine cover and visually compare the devices installed in system to those shown in the system configuration report.

- Go to step 006.

004 - DO ANY MESSAGES, ERROR CODES, OR SYMPTOMS APPEAR? (YES, READ AHEAD. NO, GO TO STEP 005)

- Go to "Index of Symptoms, Messages, Error Codes, or Beeps" on page 60.
- End.

005 -

- If the keyboard responds incorrectly, go to "Keyboard" on page 78.

006 - DOES THE SYSTEM CONFIGURATION REPORT CORRECTLY IDENTIFY THE DEVICES INSTALLED IN SYSTEM? (YES, READ AHEAD. NO, GO TO STEP 007.)

- Select **Diagnostics** from the diagnostics program menu.
- Select and execute **All Tests**.
- Go to step 008.

007 -

The system configuration report shows only those devices supported by the diagnostics diskette.

If a device is missing from the list and is not factory installed, refer to the service manual provided for that device.

008 - DOES THE DIAGNOSTICS FINISH WITHOUT ANY ERRORS? (YES, READ AHEAD. NO, GO TO STEP 009.)

- If the **Diagnostics \ All Tests** did not detect a failure but the system still indicates a failure:
- Check all adapter card jumper settings.
- Check all adapter card switch settings.
- Check all adapter card cables and connectors.
- Make sure that all of the above are set correctly and show the correct voltages and continuity. Replace any defective cables or adapter cards. See "Power Supply Cable Connector Specifications" on page 122 and "Layout of the System Board for Machine Types 2255 and 2275" on page 119.
- Run the **Diagnostics \ All Tests** again.
- If an error or other symptom is displayed, go to "Index of Symptoms, Messages, Error Codes, or Beeps" on page 60.
- If no error can be detected or the symptom is intermittent, go to "Undetermined Problems" on page 84.
- End

009 -

- If the last test stops and you cannot continue, first make sure all switches, power connectors, cables, and jumpers are set correctly and show the correct voltages and continuity.
- Take note of any messages, error codes, beeps, or new symptoms. Go to "Index of Symptoms, Messages, Error Codes, or Beeps" on page 60.
- If there is no error symptom or the error symptom is intermittent, go to "Undetermined Problems" on page 84.

Index of Symptoms, Messages, Error Codes, or Beeps

How to Use Error Messages: Use the messages, error codes, and beeps combinations that occur to diagnose failures. If more than one failure occurs, diagnose from the first failure that appears. The cause of the first failure can result in false messages, error codes, or beeps. If you did not receive any messages, error codes, or beeps, see if the symptom is listed in Table 2-3, "Error Symptoms List" on page 65.

ATTENTION: When you have replaced a FRU, you must run the diagnostics to ensure that no other activity has been affected by the change. This system check can be done through the diagnostics program (Select **Diagnostics**, then select and execute **All Tests** from PC-Doctor).

POST: Some diagnostic aids are resident in the machine, such as the Power-On Self Test (POST). The machine performs the POST each time it is powered on. Use this information throughout the diagnostic procedures. The POST is a series of system checks and initializations that verify the correct operation of the base system.

After a successful POST, the system attempts to load the operating system. The system can be customized for different startup (boot) methods by the BIOS Setup Utility. See "Advanced Setup" on page 47.

The system's default startup sequence automatically looks for the operating system files in the hard disk if these files are not found in the diskette.

NOTE: Remember that POST does not test all areas, but only those that allow the system to operate well enough to run the diagnostics program.

Table 2-1 lists BIOS error codes, messages, and beeps and their possible causes, table 2-3 lists error symptoms and their possible causes. The most likely cause is listed first. Make sure you complete all items in the cause or "Action/FRU" column. When servicing a system, always begin with "Start" on page 55.

If the problem cannot be corrected using these two index tables, go to "Undetermined Problems" on page 84.

NOTES:

If an error message and incorrect audio response occur, diagnose the error message first.

If you cannot run the diagnostics program tests but did receive a POST error code, diagnose the POST error message.

If you did not receive any error message, look for a description of your error symptoms in "Error Symptoms List" on page 65.

Check all power supply voltages, switch, and jumper settings before you replace the system board. Also check the power supply voltages if you have a "system no-power" condition. ("Power Supply Cable Connector Specifications" on page 122 and "Layout of the System Board for Machine Types 2255 and 2275" on page 119.)

If the problem cannot be corrected by using the "BIOS Error Codes, Messages, And Beeps List" table and "Error Symptoms List" table, go to "Undetermined Problems" on page 84.

| Table 2-1 BIOS Error Codes, Messages, and Beeps List | |
|---|---|
| BIOS Error Codes, Messages, beeps | Action/FRU |
| NOTE: To diagnose a problem, first find the BIOS error messages, codes, or beeps in left column. If directed to a check procedure, replace the FRU indicated in the check procedure. If no check procedure is indicated, the first Action/FRU listed in right column is the most likely cause. | |
| POST Error Codes and Messages | |
| 161 CMOS battery failed | Loads default settings in Setup and reboot the system. CMOS battery. System board. |
| 162 CMOS checksum error - Defaults loaded | Make sure the equipment (diskette drive, hard disk drive, keyboard, mouse, etc.) is connected properly and are set correctly in BIOS Setup. Load default settings in setup. CMOS battery should be replaced. System board. |
| 164 Memory size error | Make sure the DIMMs are inserted properly. System board. |
| 201 Memory test failure. | Insert the memory modules in the DIMM sockets properly, and then reboot the system. Memory module. See the "Step 005" of "Memory" on page 78 to replace memory module. System board. |
| 301 Keyboard error or no keyboard present. | Make sure the keyboard is connected properly and are set correctly in BIOS Setup. System board. |
| 662 FLOPPY DISK(S) failure (80) | Unable to reset floppy subsystem. |
| 662 FLOPPY DISK(S) failure (40) | Floppy Type mismatches. |
| 1701 Hard disk(s) Diagnosis failure | Make sure the hard disks are set correctly in BIOS setup. Hard disk drives cable/connection. Hard disk drives. System board. |

| Table 2-1 BIOS Error Codes, Messages, and Beeps List | |
|---|--|
| BIOS Error Codes, Messages, beeps | Action/FRU |
| NOTE: To diagnose a problem, first find the BIOS error messages, codes, or beeps in left column. If directed to a check procedure, replace the FRU indicated in the check procedure. If no check procedure is indicated, the first Action/FRU listed in right column is the most likely cause. | |
| 1762 Primary master IDE has changed Primary slave IDE has changed Secondary master IDE has changed Secondary slave IDE has changed | Make sure that the System Boot Drive parameter in the Startup Options of BIOS Setup is not set to [Drive A only]. Load default settings in Setup. Insert a system diskette into diskette drive and reboot system. Make sure the diskette drive configuration setting in BIOS Setup is correct. Hard disk drives power. Diskette drive. System board. |
| 1780 Primary master hard disk failure 1781 Primary slave hard disk failure | A warning message to indicate there has been a change of IDE Primary (Secondary) Channel Master (Slave) device. Load default settings in Setup. Check IDE drive jumper. See "3.5-In. Hard Disk Drive Jumper Locations" on page 126. IDE drive power. IDE drive cable/connection. IDE drive. |
| 1782 Secondary master hard disk failure 1783 Secondary slave hard disk failure | A warning message to indicate there has been change of IDE Primary (Secondary) Channel Master (Slave) device. Load default settings in Setup. Check IDE drive jumper. See "3.5-In. Hard Disk Drive Jumper Locations" on page 126. IDE drive power. IDE drive cable/connection. IDE drive. |
| 8602 Mouse error on no Mouse present | Make sure the Mouse is connected properly and is set correctly in BIOS Setup. Mouse. System board. |
| SYSTEM HALTED, (CTRL-ALT-DEL) TO REBOOT... | Indicates the present boot attempt has been aborted and the system must be rebooted. Press and hold down the CTRL and ALT key and DEL. |
| Hard Disk(s) failure (80) | Hard Disk Drive reset failed. |
| Hard Disk(s) failure (40) | Hard Disk Drive controller diagnostics failed. |
| Hard Disk(s) failure (20) | Hard Disk Drive initialization error. |
| Hard Disk(s) failure (10) | Unable to recalibrate fixed disk. |
| Non-System disk or disk error Replace and strike any key when ready | Insert a system disk into Drive A: and press <Enter>. If you assumed the system would boot from the hard drive, make sure the controller is inserted correctly and all cables are properly attached. Be sure the disk is formatted as a boot device. Then reboot the system. |
| OFFENDING SEGMENT: | This message is used in conjunction with the I/O CHANNEL CHECK and RAM PARITY ERROR messages when the segment that has caused the problem has been isolated. |
| PRESS A KEY TO REBOOT | This will be displayed at the bottom of the screen when an error occurs that requires you to reboot. Press any key and the system will reboot. |

Table 2-1 BIOS Error Codes, Messages, and Beeps List

| BIOS Error Codes, Messages, beeps | Action/FRU |
|--|---|
| <p>NOTE: To diagnose a problem, first find the BIOS error messages, codes, or beeps in left column. If directed to a check procedure, replace the FRU indicated in the check procedure. If no check procedure is indicated, the first Action/FRU listed in right column is the most likely cause.</p> | |
| PRESS F1 TO DISABLE NMI, F2 TO REBOOT | When BIOS detects a Non-maskable Interrupt condition during boot, this will allow you to disable the NMI and continue to boot, or you can reboot the system with the NMI enabled. |
| RAM PARITY ERROR – CHECKING FOR SEGMENT ... | Indicates a parity error in Random Access Memory. |
| Memory parity Error at ... | Indicates a memory parity error at a specific location. You can use this location along with the memory map for your system to find and replace the bad memory chips. |
| Memory Verify Error at ... | Indicates an error verifying a value already written to memory. Use the location along with your system's memory map to locate the bad chip. |
| OFFENDING ADDRESS NOT FOUND | This message is used in conjunction with the I/O CHANNEL CHECK and RAM PARITY ERROR messages when the segment that has caused the problem cannot be isolated. |
| ERROR ENCOUNTERED INITIALIZING HARD DRIVE | Hard drive cannot be initialized. Be sure the adapter is installed correctly and all cables are correctly and firmly attached. Also be sure the correct hard drive type is selected in Setup. |
| ERROR INITIALIZING HARD DISK CONTROLLER | Cannot initialize controller. Make sure the cord is correctly and firmly installed in the bus. Be sure the correct hard drive type is selected in Setup. Also check to see if any jumper needs to be set correctly on the hard drive. |
| FLOPPY DISK CNTRLR ERROR OR NO CNTRLR PRESENT | Cannot find or initialize the floppy drive controller. Make sure the controller is installed correctly and firmly. If there are no floppy drives installed, be sure the Diskette Drive selection in Setup is set to NONE. |

| Table 2-2 BIOS Error Codes, Messages, and Beeps List | |
|--|--|
| BIOS Error Codes, Messages, beeps | Action/FRU |
| <p>NOTE: To diagnose a problem, first find the BIOS error messages, codes, or beeps in left column. If directed to a check procedure, replace the FRU indicated in the check procedure. If no check procedure is indicated, the first Action/FRU listed in right column is the most likely cause.</p> | |
| Beeps | |
| (2: long, 1: short) 2-1-1 | <p>This code indicates that a video error has occurred and the BIOS cannot initialize the video screen to display any additional information.</p> <p>The code indicates that DRAM error has occurred. See "Memory (DIMM)" on page 103 to get more information.</p> |
| 2- (repeatedly) | |

| Table 2-3 Error Symptoms List | |
|--|--|
| Error Symptoms | Action/FRU |
| NOTE: To diagnose a problem, first find the error symptom in the left column. If directed to a check procedure, replace the FRU indicated in the check procedure. If no check procedure is indicated, the first Action/FRU listed in right column is the most likely cause. | |
| Processor | |
| NOTE: Normally, the processor fan should be operative, and the processor clock setting should be exactly set to match its speed requirement before diagnosing any processor problems. | |
| Processor fan does not run but power supply fan runs. | Make sure that the system is not in power saving mode. See "Power Management Setup" on page 47. With the system power on, measure the voltage of processor fan connector FN. (See "Power Supply Cable Connector Specifications" on page 122 and refer to the "Connectors and Functions for the System Board of Machine Types 2255 and 2275" on page 121.) It's reading should be +12Vdc. Processor fan. System board. |
| Processor test failed. | Processor. System board. |
| System Board | |
| NOTE: Ensure that the memory modules are installed properly and the contact lead is clean before diagnosing any system problems. | |
| Memory test failed. | "Memory" on page 78 System board |
| Incorrect memory size shown or repeated during POST. | Insert the memory modules in the DIMM sockets properly, and then reboot the system. Memory module. See the "Step 005" of "Memory" on page 78 to replace memory module. System board. |
| System works but fails to enter power saving mode when the "Power Management" is set to [Enabled], and power saving timer set in BIOS has elapsed. | Load default settings. In Windows Millennium, check settings in Control Panel Power utility. Reload software from Recovery CD. |
| System hangs before system boot. | "Index of Symptoms, Messages, Error Codes, or Beeps" on page 60. "Undetermined Problems" on page 84. |
| System hangs after system boot. | Execute a system test ("Diagnostics/All Tests" in PC-Doctor diagnostics program) and set it to stop at "Halt on Error" to see the potential cause of the problem. "Undetermined Problems" on page 84. |
| Blinking cursor only; system does not work. | "Start" on page 55. Diskette/IDE drive connection/cables Diskette/IDE disk drives "Undetermined Problems" on page 84. System board |
| Diskette Drive | |
| NOTE: Ensure that the diskette drive is configured correctly in BIOS Setup and its read/write head is clean before diagnosing any diskette drive problems. | |

| Table 2-3 Error Symptoms List | |
|--|---|
| Error Symptoms | Action/FRU |
| NOTE: To diagnose a problem, first find the error symptom in the left column. If directed to a check procedure, replace the FRU indicated in the check procedure. If no check procedure is indicated, the first Action/FRU listed in right column is the most likely cause. | |
| Media and drive are mismatched. | Make sure that the diskette drive is configured correctly in the Disk Drives of BIOS Setup. Make sure that the diskette drive is correctly formatted. Diskette drive connection/cable Diskette drive System board |
| Diskette drive does not work. | Make sure that the diskette drive is not set to [None] in the "Standard CMOS Setup" of BIOS Setup. Diskette drive power Diskette drive connection/cable Diskette drive System board |
| Diskette drive test failed. | Diskette Diskette drive Diskette drive cable System board |
| Hard Disk Drive | |
| NOTE: Ensure hard disk drive is configured correctly in BIOS Setup, cable/jumper are set correctly before diagnosing any hard disk drive problems. | |
| Hard disk drive test failed. | Load default settings. Hard disk drives cable. Hard disk drives. System board. |
| Hard disk drive formats error. | Load default settings. Hard disk drives cable. Hard disk drives. System board. |
| Hard disk drive writes error. | Load default settings. Hard disk drives. |
| Hard disk drive LED fails to light, but system operates normally. | With the system power on, measure the voltage of hard disk LED connector JP9 (Please refer to the "Connectors and Functions for the System Board of Machine Types 2255 and 2275" on page 121). |
| CD-ROM Drive | |
| NOTE: Make sure CD-ROM drive is configured correctly in BIOS Setup, cable/jumper are set correctly and its laser beam is clean before diagnosing any CD-ROM drive problems. | |

| Table 2-3 Error Symptoms List | |
|--|---|
| Error Symptoms | Action/FRU |
| NOTE: To diagnose a problem, first find the error symptom in the left column. If directed to a check procedure, replace the FRU indicated in the check procedure. If no check procedure is indicated, the first Action/FRU listed in right column is the most likely cause. | |
| CD-ROM drive LED flashes for more than 30 seconds before LED shutting off. Software asks to reinstall disc. Software displays a reading CD error. | CD may have dirt or foreign material on it. Check with a known good disc. CD is not inserted properly. CD is damaged. |
| CD-ROM drive LED doesn't come on but works normally. | CD-ROM drive |
| CD-ROM drive cannot load or eject when the system is turned on and its eject button is pressed and held. | CD-ROM drives power. "CD-ROM Drive" on page 76. CD-ROM drive |
| CD-ROM drive does not read and there are no error codes or messages are displayed. | CD may have dirt or foreign material on it. Check with a known good disc. Make sure that the CD-ROM driver is installed properly. CD-ROM drive. |
| CD-ROM drive can play audio CD but no sound output. | Make sure that the headphone jack of the CD-ROM has an output, then check if the audio cable from CD-ROM drive to system board CD audio connector is connected properly. Turn up the sound volume. Speaker power/connection/cable. CD-ROM drive. |
| Real-Time Clock | |
| Real-time clock is inaccurate. | Make sure that the information in the Date and Time of BIOS Setup is set correctly. Load default settings. RTC battery. System board |
| Audio | |
| Audio software program invokes but no sound comes from speakers. | Speaker power/connection/cable. |
| Modem | |
| Data/fax modem software program invokes but cannot receive/send data/fax. | "Factory-Installed Modem Card" on page 73. |
| Video and Monitor | |
| Video memory test failed. Video adapter failed. | Remove all non-factory cards. Loads default settings (if screen is readable). System board |

| Table 2-3 Error Symptoms List | |
|--|---|
| Error Symptoms | Action/FRU |
| NOTE: To diagnose a problem, first find the error symptom in the left column. If directed to a check procedure, replace the FRU indicated in the check procedure. If no check procedure is indicated, the first Action/FRU listed in right column is the most likely cause. | |
| Display problem: - Incorrect colors - No high intensity - Missing, broken, or incorrect characters - Blank monitor(dark) - Blank monitor(bright) - Distorted image - Unreadable monitor - Other monitor problems | Monitor signal connection/cable. Monitor System board |
| Display changing colors. | Monitor signal connection/cable Monitor System board |
| Display problem not listed above (including blank or illegible monitor). | "Monitor" on page 83. Loads default settings (if screen is readable). System board |
| Parallel | |
| NOTE: Execute "Load BIOS Default Settings" in BIOS Setup to confirm ports' presence before diagnosing any parallel/serial ports problems. | |
| Serial or parallel port loop-back test failed. | Make sure that the LPT# or COM# you test is the same as is set in BIOS Setup. Loop-back. System board. |
| Printing failed. | Make sure that the printer driver is properly installed. Refer to the service manual for the printer. Printer. Printer cable. System board. |
| Printer problems. | Refer to the service manual for the printer. |
| Joystick | |
| Game port does not respond or does not work. | Connect a joystick to the game port, and then execute "Interactive Test/Joystick test" in PC-Doctor diagnostics program. System board. |
| Diagnostic Program | |
| Diagnostics programs cannot be executed. | Reboot the system from the diagnostics diskette. Load default settings. Diagnostics diskette. Memory module. System board. |
| Missing diagnostics files(s). | Diagnostics diskette. |

| Table 2-3 Error Symptoms List | |
|--|---|
| Error Symptoms | Action/FRU |
| NOTE: To diagnose a problem, first find the error symptom in the left column. If directed to a check procedure, replace the FRU indicated in the check procedure. If no check procedure is indicated, the first Action/FRU listed in right column is the most likely cause. | |
| Keyboard | |
| Some or all keys on keyboard do not work. | "Keyboard" on page 78. |
| Power Supply | |
| Pressing power switch cannot turn off system. (Only unplug power cord from electrical outlet can turn off system.) | See "Power Management Setup" on page 47. Power switch cable assembly "Power Supply" on page 81. System board |
| Pressing power switch cannot turn on system. | Check the voltage selector on the power supply if it is off. Power switch cable assembly. |
| Executing software shutdown from Windows98 Start menu cannot turn off system. (Only pressing power switch can force system to turn off). | Load default settings. Reload software from Recovery CD. |
| No system power, or power supply fan is not running. | "Power Supply" on page 81. System board. |
| Other Problems | |
| Any other problems. | "Undetermined Problems" on page 84. |

Troubleshooting

Failing Parts or Assemblies: The check procedures generally help you trace a problem to one part or assembly. The last step of the specific check procedure you are using indicates that a part or assembly is failing. You should inspect the part or assembly before you decide to replace it. It might be loose, dirty, or in need of a small repair. The check procedures might lead you to two, or even three, possible failing parts or assemblies. The parts that might be failing are listed in order of the most probable failure. Also, the FRU parts are defined as replaced units and are not repaired in the field.

Measuring Voltages: Some check procedure steps instruct you to measure voltages on cable plugs and electronic board connectors. If you are asked to measure voltage at several places on a plug or connector, a chart next to or near the instruction indicates the number of the plug or connector, the pin numbers you should measure, the signal name, and the correct voltage for the condition you are measuring. Measure the voltage only at the pins listed in the chart. Remember to set the meter on the correct scale and to put the meter leads in the correct position for the voltage you are asked to measure.

NOTE: Use frame ground as the ground reference. Attach the black (ground) lead of meter to frame ground, except where specified otherwise.

Factory-Installed Storage Devices

Use this check procedure to test any factory-installed drives.

ATTENTION: The customer may have customized settings in the Setup Utility (other than default settings) on the computer you are servicing. Running the Setup Utility might alter those settings. Take note of the current settings and verify that the customer settings are in place when service is complete.

NOTE: If you cannot access the hard disk drive or load a diskette from Drive A or load a CD from the CD-ROM drive, make sure that the BIOS Setup Utility has the startup sequence set with diskette, CD-ROM, and hard disk drives.

001 - START

- Insert the diagnostics diskette into the diskette drive.
- Power-off then power-on the system unit.

002 - DO ANY POST MESSAGES, ERROR CODES, BEEPS, OR SYMPTOMS OCCUR? (YES, READ AHEAD. NO, GO TO STEP 003)

- Go to "Index of Symptoms, Messages, Error Codes, or Beeps" on page 60.
- End.

003 -

- Select **Utility** from the menu.
- Select and execute **Tech Support Form** from the menu to generate a system configuration report.
- Compare the system configuration list with the actual devices installed in system.

NOTE: If necessary, remove the cover and visually compare the devices installed in the system unit to those shown in the Tech Support Form.

004 - IF THE NUMBER OF DISKETTE, HARD DISK, OR CD-ROM DRIVE IS NOT CORRECT, READ AHEAD; OR GO TO STEP 005.

- Check the cable installation of all disk drives.
- Diskette drive should be connected to the system board Floppy connector. (Please refer to the "Connectors and Functions for the System Board of Machine Types 2255 and 2275" on page 121.)
- IDE Primary Channel Master and Slave Drives in BIOS Setup should be connected to the system board primary IDE connector. (Please refer to the "Connectors and Functions for the System Board of Machine Types 2255 and 2275")
- IDE Secondary Channel Master and Slave Drives in BIOS Setup should be connected to the system board secondary IDE connector. (Please refer to the Connectors and Functions for the System Board of Machine Types 2255 and 2275.)

NOTE: The CD-ROM drive that comes with system unit should be configured as IDE Secondary Channel Master device.

- Check the hard disk and CD-ROM drives jumper settings. See "3.5-In. Hard Disk Drive Jumper Locations" on page 126 and "CD-ROM Drive" on page 76.
- Check the voltages of all disk drive power connectors. See "Power Supply Cable Connector Specifications" on page 122.
- Correct the parameter settings under Disk Drives in the BIOS Setup. See "IDE Drives Setup" on page 44.
- In the BIOS Setup, check that the correct drive size is set for the flagged drive shown in the Installed Devices list.
- Load default settings.
- If the problem remains, check the continuity on the drive and the cable and replace it if necessary. If that does not fix the problem, replace the system board.
- End.

005 -

- ❑ Select **Diagnostics** from the PC-Doctor diagnostics program main menu. Select and execute **Floppy Disk Test** if you want to test the diskette drive. Select and execute **Hard Disk Test** if you want to test the hard disk drive.
- ❑ Select **Interactive Tests** from the PC-Doctor diagnostics program main menu, then select and execute **CD-ROM/DVD Test** if you want to test the CD-ROM drive.
- ❑ If the diagnostics program did not detect a failure, but the system still displays a failure:
- ❑ If an error or other symptom appears, go to “Index of Symptoms, Messages, Error Codes, or Beeps” on page 60.
- ❑ If no error can be detected or the symptom is intermittent, go to “Undetermined Problems” on page 84.
- ❑ End.

Factory-Installed Modem Card

001 - START

- Power off the system unit.
- In Windows Device Manager, make sure that the modem is not configured with a conflicting COM port and IRQ setting.
- Make sure that the communication software is configured with the correct COM and IRQ settings (same COM port and IRQ as the modem).
- Make sure that all communication parameters (baud rate, data, stop and parity bits) are properly configured and are identical on both sides.
- Connect the phone line to the LINE port of the modem card.

NOTE: Check the outside phone line by connecting a working telephone to the telephone wall jack. Listen for a dial tone to ensure that the phone line is good.

002 -

- Insert the diagnostics diskette into the diskette drive.
- Power on the system unit.
- Select **Diagnostics** menu.
- Select **All Tests**, then execute **Modem** test.

003 - DOES THE MODEM PASS THE TEST? (YES, READ AHEAD. NO, GO TO STEP 004.)

- Power off the system unit.
- Remove all adapter cards.
- Connect a hard disk drive with pre-loaded Windows Millennium.
- Power on the system unit.
- Perform the following steps under Windows Millennium.

NOTE: If an operating system other than Microsoft Windows Millennium is installed, the program screens and icons may differ from these instructions.

- 1. Start Microsoft Windows Millennium.
- 2. Select the **Start** icon.
- 3. Select **Program**, then select **Accessories, Hyper Terminal**.
- 4. Select an **on-line service station**, dial and connect to it.

004 - CAN THE MODEM DIAL OUT AND CONNECT TO ANY BBS SUCCESSFULLY? (YES, READ AHEAD. NO, GO TO STEP 005.)

- The modem adapter functions normally.
- End.

005 -

- Make sure that Windows Millennium is properly installed, and then power off the system unit.
- Plug the modem adapter card into a different PCI slot.
- Go to step 002.
- If the error symptom still remains, replace the modem adapter card.
- End.

Audio (Not Supported by Diagnostics Program)

NOTE: Audio tests for the sound card cannot be carried out in the PC Doctor DOS diagnostics program. It is, however, possible to carry out a dial tone test for the modem.

While performing this check, you may need to enter and exit Microsoft Windows Millennium several times. When instructed to select an icon or button, double-click on the item with the mouse.

For more information about using Microsoft Windows Millennium, see the user's guide that came with the computer.

If an operating system other than Microsoft Windows Millennium is installed, the program screens and icons may differ from these instructions.

001 - START

- Power off the system unit.
- Remove all adapter cards.
- Connect a hard disk drive with pre-loaded Windows Millennium.
- Power on the system unit.
- Load default settings in setup (audio may be disabled).

002 - DO ANY POST MESSAGES, ERROR CODES, BEEPS, OR SYMPTOMS APPEAR? (YES, READ AHEAD. NO, GO TO STEP 003)

- Go to "Index of Symptoms, Messages, Error Codes, or Beeps" on page 60.
- End.

003 - DO ANY MESSAGES OR ERROR CODES DISPLAY AFTER POST COMPLETES BUT BEFORE MICROSOFT WINDOWS MILLENNIUM STARTS? (YES, READ AHEAD. NO, GO TO STEP 004)

NOTE: If POST does not complete, answer this question "No".

- Make sure that Windows Millennium is properly installed.
- End.

004 -

- Perform the following under Windows Millennium.

NOTE: If an operating system other than Microsoft Windows Millennium is installed, the program screens and icons may differ from these instructions.

1. Start Microsoft Windows Millennium.
2. Select the **Start** icon.
3. Select **Settings**, then select **Control Panel**.
4. Select the **Sound** icon.
5. In the Sound window, select **chimes** from the **Names** field. (To test other adapter card software, select an action from a menu in that software.)

005 - IS THE PREVIEW BUTTON, OR ACTION IN OTHER SOFTWARE, SELECTABLE ON THE SCREEN (SHOWN IN BLACK AND NOT GRAY)? (YES, GO TO STEP 006. NO, READ AHEAD.)

- Make sure that Windows Millennium is properly installed.
- Go to step 001.

006 -

- Select the **Preview** button from the Sound window.

007 - DO YOU HEAR ANY SOUND FROM THE SPEAKER? (YES, READ AHEAD. NO, GO TO STEP 008.)

- The audio feature is functioning normally. Click **Cancel** to close the dialog box. Exit Microsoft Windows Millennium.
- If the symptom remains or has changed, go to "Index of Symptoms, Messages, Error Codes, or Beeps" on page 60.
- End.

008 -

- Make sure that the volume control is not turned low.
- Make sure that the speaker and its adapter are not damaged.
- Make sure that the speaker is plugged into speak-out jack. Refer to the "Connectors and Functions for the System Board of Machine Types 2255 and 2275" on page 121.
- If the error cannot be resolved, replace the system board.
- End.

CD-ROM Drive

001 - START

- Insert the diagnostics diskette into the diskette drive and make sure that there is no CD in the CD-ROM drive.
- Select **Interactive Tests** menu, then select and execute **CD-ROM Test**.

002 - DO YOU SEE A MESSAGE "NO CD-ROM DRIVE OR MSCDEX DEVICE DRIVER INSTALLED."? (YES, READ AHEAD. NO, GO TO STEP 003.)

- Exit the diagnostics program and power off the system.
- Check and make sure that the CD-ROM drive power cable and audio and data cables are not damaged and are connected properly.
- Check and make sure that the CD-ROM drive driver is loaded correctly.
- Load default settings.

003 - DO THE TESTS OF OPEN/CLOSE TRAY BY DIAGNOSTICS PROGRAM AND BY DEPRESSING CD-ROM DRIVE BUTTON WORK? (YES, READ AHEAD. NO, GO TO STEP 006.)

- Load a known good data CD into the CD-ROM drive and try to read its content by typing DIR at DOS prompt.

004 - CAN A CD BE READ FROM THE CD-ROM DRIVE? (YES, THEN THE CD-ROM DRIVE FUNCTIONS NORMALLY. NO, READ AHEAD.)

- Try reading the CD with a known good CD-ROM drive.

005 - IS THE CD STILL NOT READABLE? (YES, READ AHEAD. NO, GO TO STEP 006.)

- Replace system board.
- End.

006 -

- Replace CD-ROM drive.
- End.

Memory

001 - START

- Power off the system unit.
- Insert the diagnostics diskette into the diskette drive.
- Make sure that all DIMMs are installed correctly.
- Power on the system unit.
- Take note of any messages, error codes, or symptoms.

002 - DO YOU RECEIVE POST MEMORY ERROR MESSAGE? (YES, READ AHEAD. NO, GO TO STEP 003)

- Enter **BIOS Setup Utility** then reboot the system. Take note of any messages, error codes, or symptoms. If the error message remains, go to step 005.

003 -

- Follow the screen instructions to run the **Memory test**.

004 - DOES THE MEMORY TEST COMPLETE WITHOUT AN ERROR? (YES, READ AHEAD. NO, GO TO STEP 005.)

- The system memory is now functioning correctly. If you suspect an intermittent problem, run the **Memory test** again.
- End.

005 -

- Replace each DIMM, one at a time, with a known working DIMM of the same size and type.
- If the problem does not appear, it means that the last DIMM replaced is defective. If all DIMMs on the system board have been replaced and the problem remains, replace system board.
- Go to step 001.

NOTE: If on startup, there is no memory inserted onto the system board, you will hear 2 long beeps.

Keyboard

001 - START

- Power off the system unit and make sure that the keyboard plug is connected properly.

002 -

- Insert the diagnostics diskette into the diskette drive and power on the system unit.
- Select **Interactive Tests** menu, then execute **Keyboard test**.

003 - DOES THE KEYBOARD FUNCTION CORRECTLY? (YES, READ AHEAD. NO, GO TO STEP 004.)

- Keyboard is functioning normally.
- End.

004 - ARE THERE ANY STUCK KEYS OR ANY GRIME IN THE GAP OF KEYCAPS? (YES, READ AHEAD. NO, GO TO STEP 005.)

- Power off the system unit. Carefully remove the grime and solve the stuck key problem.
- Go to step 001.

005 - ARE THERE ANY BROKEN PINS IN THE KEYBOARD PLUG? (YES, GO TO STEP 007. NO, READ AHEAD.)

- Try with a known good keyboard.

006 - DOES THE ERROR SYMPTOM STILL REMAIN? (YES, READ AHEAD. NO, GO TO STEP 007.)

- Replace the system board.
- End.

007 -

- Replace the keyboard.
- End.

Mouse

NOTE: A sticking key button can cause the mouse to operate incorrectly. If you suspect this, go to "Keyboard" on page 78.

001 - START

- Make sure that the mouse ball turns freely.
- Make sure that the mouse plug connects properly.

002 -

- Power off the system unit.
- Insert the diagnostics diskette into the diskette drive.
- Power on the system unit.
- Select **Interactive Tests** menu, then execute **Mouse** test.

003 - DO YOU SEE THE MOUSE CURSOR IN THE DIAGNOSTICS PROGRAM? (YES, READ AHEAD. NO, GO TO STEP 011)

- Test right (left) button and check if right (left) button works.

004 - DOES THE MOUSE BUTTON WORK? (YES, READ AHEAD. NO, GO TO STEP 007)

- Test mouse cursor movement.

005 - DOES THE MOUSE MOVE SMOOTHLY AND KEEP X AND Y COORDINATES CHANGED? (YES, READ AHEAD. NO, GO TO STEP 006)

- Mouse is functioning normally.
- End.

006 -

- Power off the system unit.
- Open mouse bottom cover and clean track ball.
- Go to step 002.

007

- Power off the system unit.
- Check the mouse plug.

008 - ARE THERE ANY BROKEN PINS IN THE MOUSE PLUG? (YES, GO TO STEP 010. NO, READ AHEAD.)

- Try with a known good mouse.

009 - DO THE ERROR SYMPTOMS STILL REMAIN? (YES, READ AHEAD. NO, GO TO STEP 010.)

- Replace the system board.
- End

010 -

- Replace the mouse.
- End.

011 -

- Exit diagnostics program.
- Make sure that the mouse driver is properly installed.
- Go to step 002.

Power Supply

001 - START

- Power off the system unit.
- Check the power cord for continuity. Replace if necessary.
- Check for the correct line voltage from the power outlet, and verify that the voltage selector switch is set to the correct voltage.
- Power on the system unit.

002 - DOES THE POWER SUPPLY FAN RUN? (YES, GO TO STEP 003. NO, GO TO STEP 004)

003 - DOES THE SYSTEM FAIL TO SHUT OFF WHEN THE ON/OFF SWITCH IS PRESSED? (YES, READ AHEAD. NO, GO TO STEP 005)

- You might have a damaged on/off switch cable assembly.
- Disconnect the on/off switch cable assembly connector from the power supply connector and take an ohm reading.
- Go to step 007.

004 -

- Disconnect the power cord from the back of the system unit.
- Disconnect all power and switch cable connectors from the system board and the power supply.
- Disconnect the power connectors to all drives.
- Connect the power connector to system board as a power load for driving up power supply.
- Reconnect the power cord.

005 - DOES THE POWER SUPPLY FAN RUN? (YES, READ AHEAD. NO, GO TO STEP 009)

- With the system powered on and the power supply fan running, check the voltages of the power supply connectors for the system board and all drive connectors, as shown in the following figures.

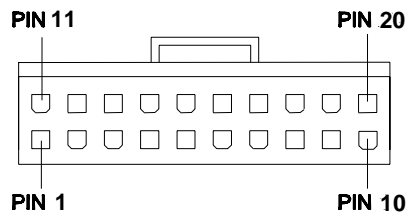

Power Supply Connectors (Bottom View)

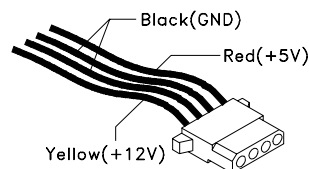

Hard Drive or CD-ROM End of Power Cable

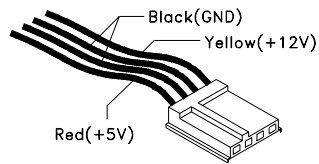

3.5-In. Diskette Drive End of Power Cable

006 - ARE THE VOLTAGES CORRECT AND DOES THE FAN RUN? (YES, READ AHEAD. NO, GO TO STEP 009)

- The power supply is working normally.
- If you suspect the on/off switch cable assembly, see Step 003.
- If the fan continues to run when all connectors are plugged back in, go to "Undetermined Problems" on page 84. If the fan stops running when a drive connector is plugged back in, go to "Start" on page 55.

007 - DO YOU HAVE AN OHM READING WHEN THE SWITCH IS PRESSED AND AN OPEN READING WHEN THE SWITCH IS RELEASED? (YES, READ AHEAD. NO, GO TO STEP 008)

- Replace the on/off switch cable assembly.

008 -

- Replace the system board.
- End.

009 -

- Replace the power supply.
- End.

Monitor

First, set the system to VGA mode. To do this in Windows Millennium, press the **F8** function key during startup. Safe mode (VGA) will be set for Windows Millennium. Use the operating system's video setup to change the monitor resolution.

If the monitor type is set to the power saving mode, the screen remains black and the LED lights or flashes in amber color. When the monitor is turned on alone, or is turned on and connected to a powered-off system unit, the monitor LED blinks in amber color. Under the normal operating conditions, the LED lights in green color.

NOTE: Some monitors have a detachable system I/O signal cable between the monitor and the system unit. Check the line voltage, power cord, and continuity for the system I/O signal cable before replacing the monitor. See "Monitor Port Signals" on page 130 for pin identification.

001 - START

- Power off the system unit and monitor.
- Remove all adapter cards.
- Make sure that the monitor I/O signal cable is properly connected to the system unit and monitor.
- Make sure that the power cords are properly connected to the system unit and monitor, and that the line voltage is correct.
- Make sure that the monitor contrast and brightness controls are not turned too low.
- Make sure that the diagnostics diskette is in the diskette drive.
- Power on the monitor, and wait 20 seconds.
- Power on the system unit.

NOTE: If the monitor was not sold together with the system unit, you may need to refer to the service information provided with the monitor.

002 - IS THE SCREEN READABLE? (YES, READ AHEAD. NO, GO TO STEP 004)

NOTE: If the screen shows a blinking cursor with no memory count running, answer this question "No".

- Select **Interactive Tests** from the Main Menu.
- Select and execute **Video** test from the menu.
- Follow the prompts and perform the video test.
- Go to "Index of Symptoms, Messages, Error Codes, or Beeps" on page 60.

NOTE: You might have to adjust the monitor controls to obtain the best image.

003 - DOES THE MONITOR SUCCESSFULLY PASS ALL TESTS? (YES, READ AHEAD. NO, GO TO STEP 004)

- You have successfully completed the video diagnostics tests. If the problem remains, go to "Index of Symptoms, Messages, Error Codes, or Beeps" on page 60.
- End.

004 -

- Power off the system unit.
- Remove the hard disk drive system cable.
- Power on the system unit.

005 - IS THE SCREEN READABLE?

- Replace the monitor. If the symptom remains, replace the system board.
- End.

Undetermined Problems

If an error code is present, go to "Index of Symptoms, Messages, Error Codes, or Beeps" on page 60. If no error code is present, continue with this check. Check the power supply voltages (see "Power Supply Cable Connector Specifications" on page 122). If the voltages are correct, return here and continue with the following steps:

1. Power off the system unit.
2. Perform the following checks, one by one, until you have isolated the problem FRU (refer to "Parts/Test Point Locations" on page 117 for locations):
 - Load default settings in setup.
 - Check all system board jumper positions and switch settings.
 - Check all adapter card jumper positions.
 - Check all device jumper positions.
 - Check all cables and connectors for proper installation.

If the jumpers, switch, and voltage settings are correct, return here and continue:

3. Remove or disconnect the following, one at a time:
 - Non-IBM devices
 - External devices
 - Any adapters
 - Modem card, if installed
 - CD-ROM drive
 - Diskette drive
 - Hard disk drive
 - DIMM
 - Processor
 - System board
4. Power on the system unit.
5. Repeat steps 1 through 4 until you find the failed device or adapter.
6. If software related, reload software from Recovery CD.

If the symptom changes, go to "Index of Symptoms, Messages, Error Codes, or Beeps" on page 60 or to the check procedure for the last item tested.

Replace the last item tested if the system operates normally after removing the last item.

Diagnostic Aids

| | |
|--|-----------|
| Diagnostic Aids | 85 |
| Introduction..... | 86 |
| Power-On Self Test..... | 87 |
| Diagnostics Tools..... | 88 |
| Using Diagnostics Program from Recovery CD | 88 |
| Diagnostics Program Features..... | 89 |

Introduction

This section explains the diagnostic aids, power-on self test (POST) and diagnostics program (PC-Doctor), that are available for troubleshooting problems on the system.

Power-On Self Test

Each time you power-on the system, the power-on self test (POST) is initiated. Several items are tested during POST, but is for the most part transparent to the user.

POST checks the following:

- System Board
- Memory
- SVGA Controller
- Hard Disk Drive(s)
- Floppy Diskette Drive(s)
- Keyboard
- Mouse
- Parallel Port(s)
- Serial Port(s)
- CD-ROM Drive(s)
- Sound Controller

To start POST, turn on the monitor and then the system unit. The following will happen:

1. The IBM logo will appear on center of the screen.
2. At this time one of two hot-keys may be used. The F1 key, as described on screen, will cause the system Setup Utility menu to appear. The F9 key will switch the graphical IBM logo screen to the traditional text-based system startup screen, which displays BIOS version and system memory tested.
3. If an error is detected during POST, the IBM logo screen will automatically switch to the text-based screen and display the error message or code with a beep. Depending on the criticality of the POST error, the system may halt and/or display the message "Press F1 to go to the Setup or Enter to continue".

If this message appears, pressing the Enter key will allow the system to attempt to proceed despite the reported error; pressing F1 will cause the system Setup Utility menu to appear.

4. If no keyboard keys are pressed, and if POST is completed without errors, the system will then proceed with the loading of DOS or other operating system from diskette drive A or a hard disk drive or CD-ROM drive, depending on the options selected in the Setup Utility.

If any errors are detected by POST, there will be an error message accompanied with an error code shown on display screen and a beep. See "Index of Symptoms, Messages, Error Codes, or Beeps" on page 60 to find the most likely cause and countermeasure.

Diagnostics Tools

IMPORTANT: This manual is intended to test the IBM Machine Types 2255 and 2275 only. Testing devices, which are not included with the original product package, including other IBM products, prototype cards, or modifying hardware settings may give false errors and invalid system responses. The diagnostics not specifically made for this model may also report incorrect errors and information.

The diagnostics program comes on a CD (compact disc) along with this book. This version of PC-Doctor diagnostics program, developed by Watergate for IBM, is the primary method of testing the computer. You can use it to test the IBM components of the system and some external devices. The amount of time required to test components depends on the number of components installed and selected. The more devices you have attached to your system and selected in PC-Doctor, the longer the testing will take.

Using Diagnostics Program from Recovery CD

1. Insert the recovery CD into the CD-ROM drive then restart computer.
2. Press **F1** during POST to enter BIOS Setup menu. Select and enter "**BIOS Features Setup**", set "**Boot Sequence to CD-ROM, A, C**". Save and exit from BIOS Setup.
3. When screen prompts to install original software, type **N** to exit the installation program. Then type **PCDR** and press **Enter** to start the diagnostics program. Follow the instructions on the screen to operate the diagnostics program.

Diagnostics Program Features

Diagnostics program (PC-Doctor for DOS) includes the following features:

| Table 3-1. Diagnostics Program Features | |
|---|---|
| Main Menu Selections | Submenu Selections |
| Diagnostics | <ul style="list-style-type: none"> • Memory Test • Hard Disk Test • Floppy Disk Test |
| Interactive Tests | <ul style="list-style-type: none"> • Keyboard • Video • Internal Speaker • Mouse • Joystick Test • Diskette • Printer Test • SCSI Test • CD-ROM/DVD Test • Stereo Speaker |
| Hardware Info | <ul style="list-style-type: none"> • USB Port • System Configuration • Memory Contents • IRQ and DMA Use • Device Drivers • COM and LPT Ports • Physical Disk Drives • Logical Disk Drives • VGA Information • Software Interrupts • SCSI Devices • I/O Use • IDE Drive Info • PCI Information • PNPISA Info |
| Utility | <ul style="list-style-type: none"> • Surface Scan Hard Disk • Tech Support Form • Select Language |
| Quit | <ul style="list-style-type: none"> • Exit Diags • Park HD • Reboot • Upgrade Now |

Repair Information

| | |
|--|-----------|
| Repair Information | 91 |
| Removals and Replacements of machine type 2275 | 92 |
| Identifying the Parts of the System Unit..... | 93 |
| Top Cover..... | 95 |
| Adapter Cards..... | 96 |
| Diskette Drive..... | 98 |
| CD-ROM Drive..... | 99 |
| Hard Disk Drive..... | 100 |
| System Board | 101 |
| Power Supply | 102 |
| Memory (DIMM)..... | 103 |
| Removals and Replacements of machine type 2255 | 104 |
| Identifying the Parts of the System Unit..... | 105 |
| Top Cover..... | 107 |
| Adapter Cards..... | 108 |
| Diskette Drive..... | 110 |
| CD-ROM Drive..... | 111 |
| Hard Disk Drive..... | 112 |
| System Board | 113 |
| Power Supply..... | 115 |
| Memory (DIMM)..... | 116 |

Removals and Replacements of machine type 2275

BEFORE REMOVING ANY FRU, POWER-OFF THE COMPUTER UNPLUG ALL POWER CORDS FROM ELECTRICAL OUTLETS, THEN DISCONNECT ANY INTERCONNECTING CABLES.

ATTENTION: The System board, processors, adapter cards, DIMMs, and upgrade processors can be damaged by electrostatic discharge. Use an electrostatic discharge (ESD) strap to establish personal grounding. If you don't have an ESD strap, establish personal grounding by touching a ground point with one hand before touching the static-sensitive FRUs.

The Arrows in the removals and replacements procedures show the direction of movement to remove a field-replaceable unit (FRU), to turn a screw, or the direction to press a tab to release the FRU.

Begin all removals by removing the cover (and rear cover, if applicable). When other FRUs must be removed prior to removing the failing FRU, they are listed at the top of the page. Go to the removal procedure for each FRU listed. Remove the FRU, and then continue with the removal of failing FRU.

To replace a FRU, reverse the removal procedure and follow any notes that pertain to replacement.

Before disconnecting any cables, note their location and orientation. Reinstall any new FRUs with cabling in their original location.

Identifying the Parts of the System Unit

This computer system has 4 bays, 3 of 4 bays have a factory-installed drive. The devices are 3.5" Diskette, optical drive (48X CD-ROM, 8x4x32x CDRW or 12x40x DVD-ROM drive) and 10GB hard disk (some models may have hard disk of 20, 30, 60 or 80 GB capacity).

Diskette drives in this unit use the standard diskette advanced technology (AT) Interface. Hard disk and CD-ROM drives in this unit use an integrated drive Electronics (IDE) AT interface. This computer supports the American National Standard Institute (ANSI) standard for AT attachment disk drives and CD-ROMs.

This system has 3 interface cards slots for adapter card expansion. All of them are Peripheral Component Interconnect (PCI) interfaces.

All models have a 10/100 Mbps Ethernet port onboard.



1. Expansion slots

On the rear panel of the system unit are 3 slot openings for installation of adapter card.

2. System board

3. Hard Disk Drive

This machine has a factory-installed 3.5" (10, 20 or 30 GB) hard disk drive.

4. Power Supply

This is a 155-watt switching power supply.

5. Diskette drive

This machine has a factory-installed 3.5" 1.44MB Floppy drive.

6. Optional drive bay

This drive can accommodate a 5.25-inch device.

7. Optical drive bay

This machine has a factory-installed 5.25-inch device (CD-ROM or CDRW or DVD-ROM).

Top Cover

To remove the top cover of this system unit:

- Remove the 3 screws that secure the top cover at the back of the system unit.
- Hold both sides of the system unit cover and push it backward about 25 inches.
- Lift the top cover up to remove it completely.
- Touch the bare metal frame of your system unit to dissipate the static electricity from your body. Do not touch any of the components inside the frame before you touch the frame. Do not touch any of the components that have a voltage-warning label.

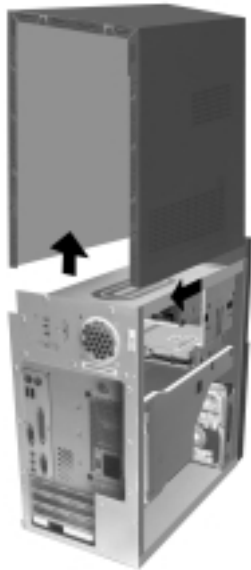

Adapter Cards

Installing Adapter Cards

- Remove the top cover first.
- Remove the slot screw and slot cover for the appropriate expansion slot.
- Align and insert the adapter card into the adapter card connector.
- Secure the card with the screw to the system chassis.
- Reinstall all hardware and screws that you removed prior to the installation of the adapter card.



Removing Adapter Cards

Follow these steps to remove an adapter card:

- Position the system unit so that the card is accessible to you.
- If the adapter card has cables, disconnect them. Be sure to take note of where the cable is connected. You will have to reconnect these cables when you reinstall the card.
- Remove the adapter card screw
- Firmly hold the adapter card and carefully pull it from the card connector.
- If you are not reinstalling the card, reinstall all other hardware and screws that were removed prior to the removal of the adapter card.

Diskette Drive

To remove the diskette drive:

- ❑ Remove the screw that secures the power at the back of the system unit.

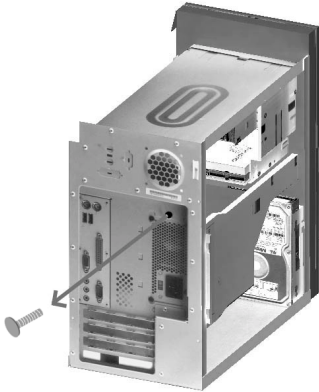

- ❑ Pull the latch on the drive mounting tray and the power upward to remove it completely.



- ❑ Disconnect the power and signal cables from the back of the diskette drive.
- ❑ Remove the two screws that hold the diskette drive to the mounting tray.
- ❑ Open the door on the front of the computer.
- ❑ Pull the diskette drive toward the front of the computer to remove it.
- ❑ Reverse the procedure to install a new drive.



CD-ROM Drive

To remove CD-ROM Drive:

- Disconnect the power, sound and signal cables from the CD-ROM.
- Remove the two screws that secure the CD-ROM drive

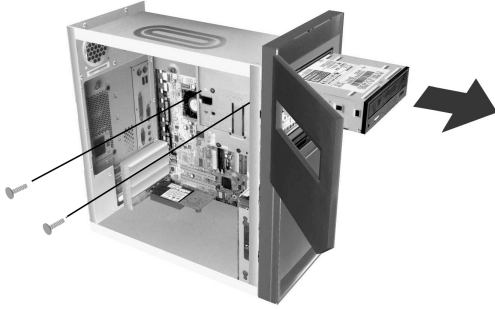

- Open the door on the front of the computer.
- Slide the CD-ROM drive forward through the front opening and remove it.
Reverse the procedure to install a new drive.

Hard Disk Drive

To remove or replace the hard disk drive:

- Disconnect the power and signal cables from the diskette drive.
- Remove the two screws that secure the mounting tray at the bottom of the system unit.
- Pull the drive mounting tray upward and remove it.

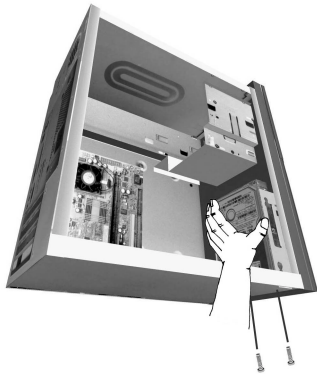

- Remove the four screws (two on each side) that secure the hard diskette drive to the mounting tray.
- Pull the hard disk drive from the mounting tray to remove.
- Reverse the procedure to install a drive.

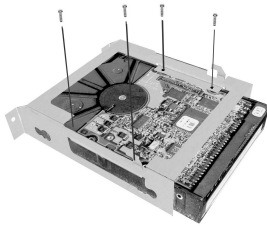

System Board

To remove the system board from the system:

- To remove the system board, you must remove the adapter cards first.
- Disconnect the power cable, CD-ROM cable, Diskette Drive cable, Hard Disk Drive cable, audio cable, power switch cable, speaker cable and LED cable from system board.
- Remove the four screws on system board.

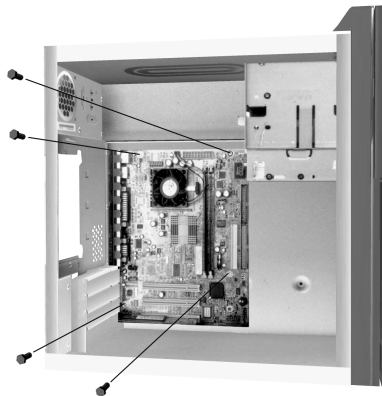

Power Supply

This system has a 155-watt switching power supply.

1. To remove the power supply. You must remove the top cover first.
2. Disconnect the power cable from the riser board and all drives.
3. Remove the screws in the machine rear that secure the power supply.

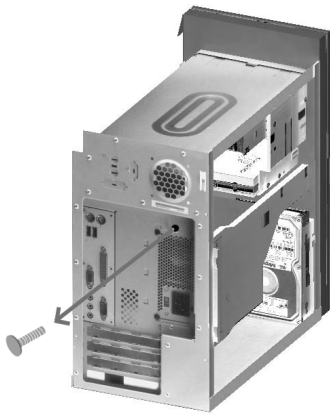

4. Rotate the power supply outward as shown.
5. Pull the power supply forward and carefully rotate it toward the front of the chassis. Lay it to the side.

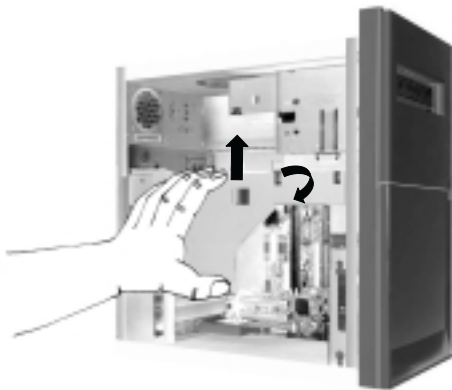

Memory (DIMM)

This system has 2 system memory module sockets, DIMM 0 and DIMM 1. These sockets hold dual in line memory modules (DIMM) that provide up to maximum of 512 MB of system memory. Fill each system memory connector sequentially, starting at DIMM 0. Using 3.3V, 133 MHz, unbuffered, SDRAM DIMMs.

The maximum memory size is 512 MB total.

Removals and Replacements of machine type 2255

BEFORE REMOVING ANY FRU, POWER-OFF THE COMPUTER, UNPLUG ALL POWER CORDS FROM ELECTRICAL OUTLETS, THEN DISCONNECT ANY INTERCONNECTING CABLES.

ATTENTION: The System board, processors, adapter cards, DIMMs, and upgrade processors can be damaged by electrostatic discharge. Use an electrostatic discharge (ESD) strap to establish personal grounding. If you don't have an ESD strap, establish personal grounding by touching a ground point with one hand before touching the static-sensitive FRUs.

The Arrows in the removals and replacements procedures show the direction of movement to remove a field-replaceable unit (FRU), to turn a screw, or the direction to press a tab to release the FRU.

Begin all removals by removing the cover (and rear cover, if applicable). When other FRUs must be removed prior to removing the failing FRU, they are listed at the top of the page. Go to the removal procedure for each FRU listed. Remove the FRU, and then continue with the removal of failing FRU.

To replace a FRU, reverse the removal procedure and follow any notes that pertain to replacement.

Before disconnecting any cables, note their location and orientation. Reinstall any new FRUs with cabling in their original location.

Identifying the Parts of the System Unit

This computer system has 3 bays, each bay has a factory-installed drive in it. There will be some model with 3.5" diskette device. For no-FDD model, there will be one 3.5" bay that is open. There will be front accessible PCMCIA /Card bus supported by optional PCMCIA low profile PCI card (some models only). System could have 48X CD-ROM drive or Combo drive or DVD-ROM or CDRW. System could have 20GB hard disk. (Some models may have hard disk of 60 or 80 GB capacity.)

Diskette drives in this unit use the standard diskette advanced technology (AT) Interface. Hard disk and CD-ROM drives in this unit use an integrated drive Electronics (IDE) AT interface. This computer supports the American National Standard Institute (ANSI) standard for AT attachment disk drives and CD-ROMs.

This system has 3 interface cards slots for adapter card expansion. All of them are low profile Peripheral Component Interconnect (PCI) interfaces.

All models of this system have a 10/100 Mbps Ethernet port onboard.

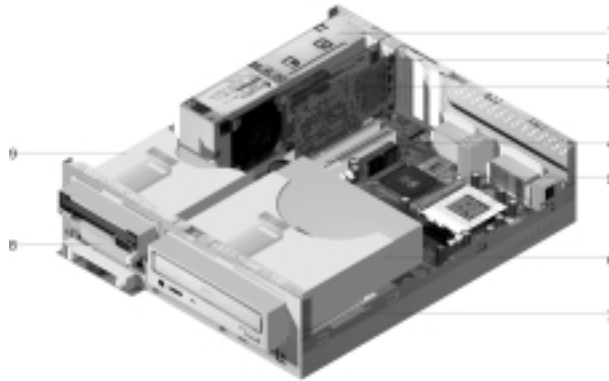

1. Power Supply
This is a 120-watt switching power supply.
2. Modem card
This system may include a V.90 56Kbps Data/Fax modem.
3. PCMCIA drive adapter card
This device is only available only on some selected models.
4. IEEE 1394 adapter card
The opening slot may be occupied by IEEE 1394 adapter card only on some selected models.
5. System board
6. Optical Drive
This machine has a factory-installed 48X CDROM or CDRW or DVD-ROM or Combo drive.
7. Hard Disk Drive
This machine has a factory-installed 3.25" (20, 60 or 80) GB hard disk drive.
8. PCMCIA drive
The optional device is only available only on some selected models.
9. Diskette Drive
This machine has a factory-installed 3.5" 1.44MB floppy drive on some selected models.

Top Cover

To remove the top cover of this system unit:

- Shut down your operating system, then remove any media (diskettes, CDs) from the drives, and turn off all attached devices and the computer.
- Unplug all power cords from electrical outlets.
- Disconnect all cables attached to the computer. This includes power cords, input/output (I/O) cables, and any other cables that are connected to the computer.
- Remove the screws that secure the top cover at the back of the system unit.
- Hold both sides of the system unit top cover and push it forward about 5 inch (12.7 cm).
- Lift the top cover up to remove it completely.
- Touch the bare metal frame of your system unit to dissipate the static electricity from your body. Do not touch any of the components inside the frame before you touch the frame. Do not touch any of the components that have a voltage-warning label.

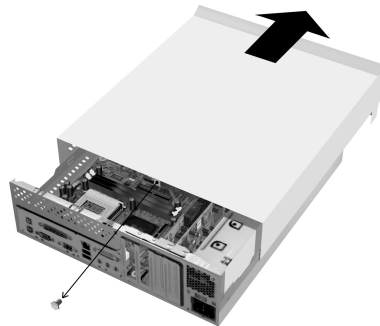

Adapter Cards

Installing Adapter Cards

- Remove the screw that secures the adapter card retainer and slot cover. Then remove the card retainer and slot cover.
- Align and insert the adapter card into the adapter card slot.
- Secure the card with the screw that you removed in the first step.
- Reinstall all hardware (except for the slot cover, which cannot be reinstalled) and screws that you removed prior to the installation of the adapter card.

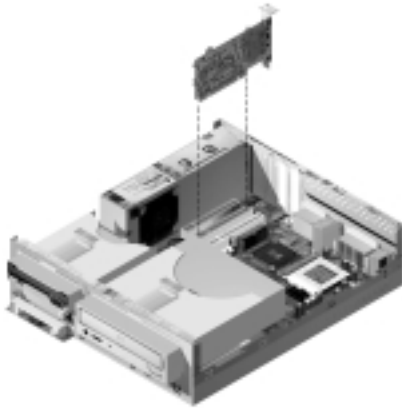

Removing Adapter Cards

Follow these steps to remove an adapter card:

- Position the system unit so that the card is accessible to you.
- If the adapter card has cables, disconnect them. Be sure to take note of where the cable is connected. You will have to reconnect these cables when you reinstall the card.
- Remove the adapter card screw
- Firmly hold the adapter card and carefully pull it from the card slot.
- If you are not reinstalling the card, reinstall all other hardware and screws that were removed prior to the removal of the adapter card.

Diskette Drive

To remove the diskette drive:

- Disconnect the power and signal cables from the rear of the diskette drive.
- Pull up the latch that secures the drive-mounting tray.

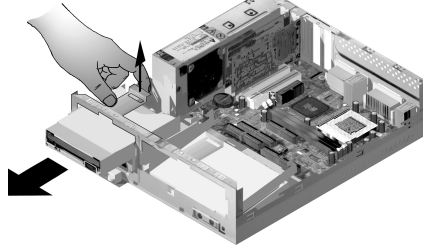

- Slide the drive-mounting tray toward the front of the computer and remove it.
- Remove the four screws (two on each side) that secure the bay holder.
- Pull the Diskette Drive from the mounting tray to remove it.
- Reverse the procedure to install a new drive.

CD-ROM Drive

To remove CD-ROM Drive:

- Disconnect the power, sound and signal cables from the CD-ROM.
- Pull up the latch that secures the CD-ROM drive-mounting tray.

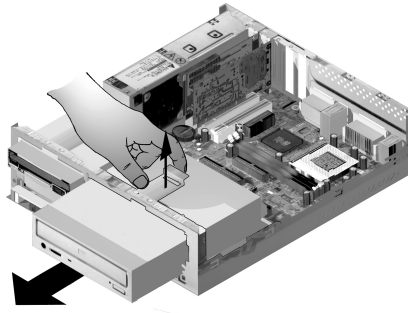

- Slide the drive-mounting tray toward the front of the computer and remove it.
- Remove four screws (two on each side) that secure the bay holder.
- Pull the bay holder backward and lift it up to remove it completely.
- Reverse the procedure to install a new drive.

Hard Disk Drive

To remove or replace the hard disk drive:

- Follow the above steps to remove the CD-ROM.
- Make sure to disconnect the power cord and signal cables from the hard disk drive.
- Remove the screws that secure the bay holder that holds the hard disk drive.

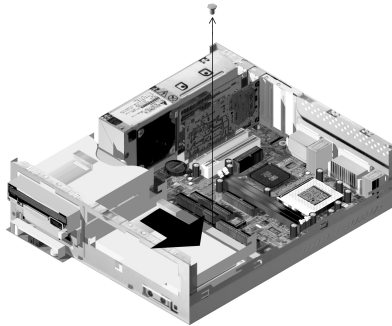

- Pull the bay holder right to uncouple it from the chassis completely and lift it up.

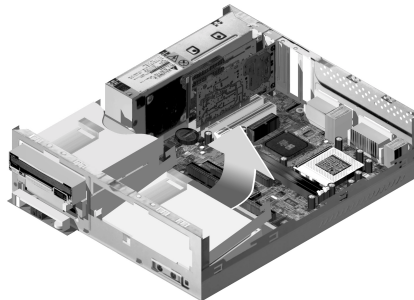

System Board

To remove the system board from the system:

- To remove the system board, you must remove the adapter cards first.
- Disconnect the power cable, CD-ROM cable, Diskette Drive cable, Hard Disk Drive cable, audio cable, power switch cable, speaker cable and LED cable from system board.
- Remove the screws on system board.

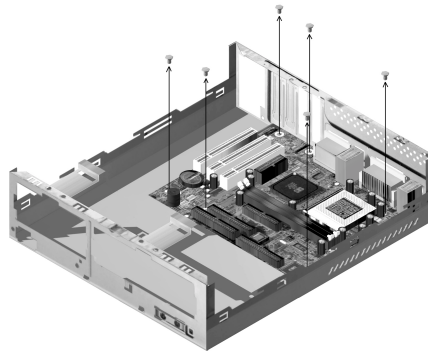

Layout of system board of machine type 2255 and 2275

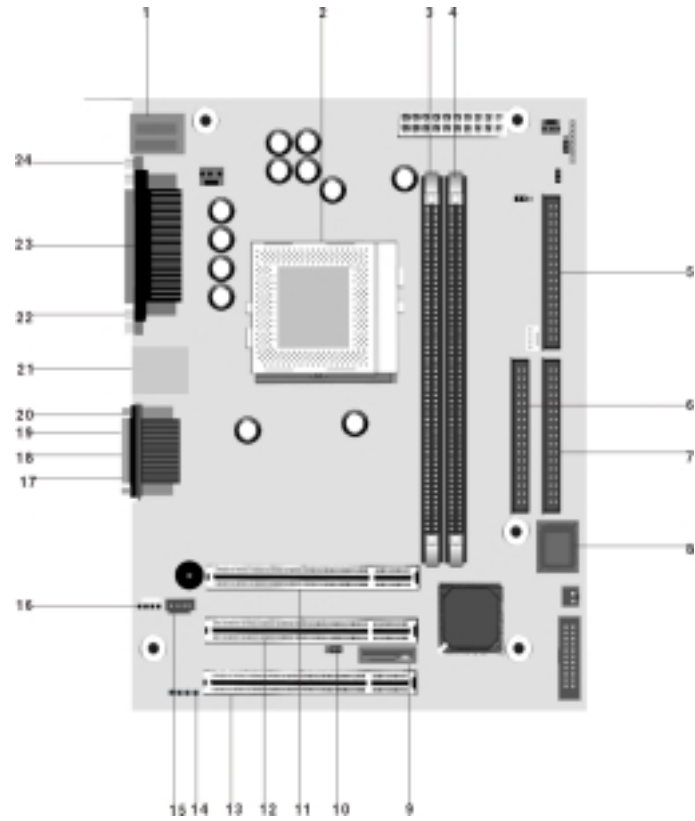

- | | |
|--|--|
| 1. PS/2 keyboard and mouse connector | 13. PCI Slot 3 |
| 2. CPU 462 pin socket | 14. S/PDIF connector |
| 3. DIMM 0 | 15. CD-ROM audio connector |
| 4. DIMM 1 | 16. Speaker-out connector |
| 5. Diskette drive connector | 17. Microphone connector |
| 6. Primary IDE connector | 18. Audio line-in connector |
| 7. Secondary IDE Connector | 19. Audio line-out connector |
| 8. Flash ROM | 20. Game Port (some models only) |
| 9. CMOS battery connector | 21. 2 USB connectors and LAN connector |
| 10. JP7: 1-2:normal(default) 2-3:CMOS clear | 22. Monitor connector |
| 11. PCI Slot 1 | 23. Parallel connector |
| 12. PCI Slot 2 | 24. Serial connector |

Power Supply

This system has a 120-watt switching power supply.

1. To remove the power supply. You must remove the top cover first.
2. Disconnect the power cable from the riser board and all drives.
3. Remove the screws in the machine rear that secure the power supply.

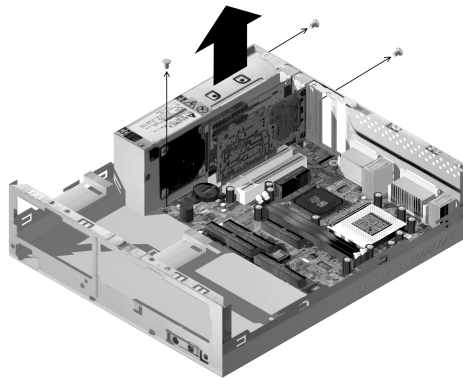

Memory (DIMM)

This system has 2 system memory module sockets, DIMM 0 and DIMM 1. These sockets hold Dual Inline Memory Modules (DIMMs) that contain a 3.3V signal, 133MHz, unbuffered, SDRAM.

The maximum memory size is 512 MB total of system memory.

Parts/Test Point Locations

| | |
|--|------------|
| Parts/Test Point Locations | 117 |
| Introduction | 118 |
| Layout of the System Board for Machine Types 2255 and 2275 | 119 |
| Jumper Settings of the System Board of the Machine Types 2255 and 2275 | 120 |
| Connectors and Functions for the System Board of Machine Types 2255 and 2275 | 121 |
| Power Supply Cable Connector Specifications | 122 |
| Main Output Pin Assignment | 123 |
| Factory-Installed Modem Card Layout | 125 |
| Factory-Installed Modem Card Connector Functions | 125 |
| 3.5-In. Hard Disk Drive Jumper Locations & Settings | 126 |
| CD-ROM Drive | 127 |
| CD-ROM Drive Rear Panel Connectors and Features | 128 |
| CD-ROM Drive Jumper Settings | 128 |
| DIMM Configurations | 129 |
| System Board Connector Pin Signals | 130 |
| Monitor Port Signals | 130 |
| Serial Port Signals | 130 |
| Parallel Port Signals | 130 |
| Mouse Port Signals | 131 |
| Keyboard Port Signals | 131 |
| Diskette Drive Cable Connector Signals | 132 |
| IDE Cable Connector Signals | 133 |

Introduction

This chapter contains system board layouts and jumper settings. It is useful when you are asked to measure voltages. Use this information to help you locate parts such as electronic boards, connectors, pin numbers, and test points. This chapter also contains jumper settings for the hard disk drive, CD-ROM (compact Disc - Read Only Memory) drive, and the connector information for modem adapter card.

Layout of the System Board for Machine Types 2255 and 2275

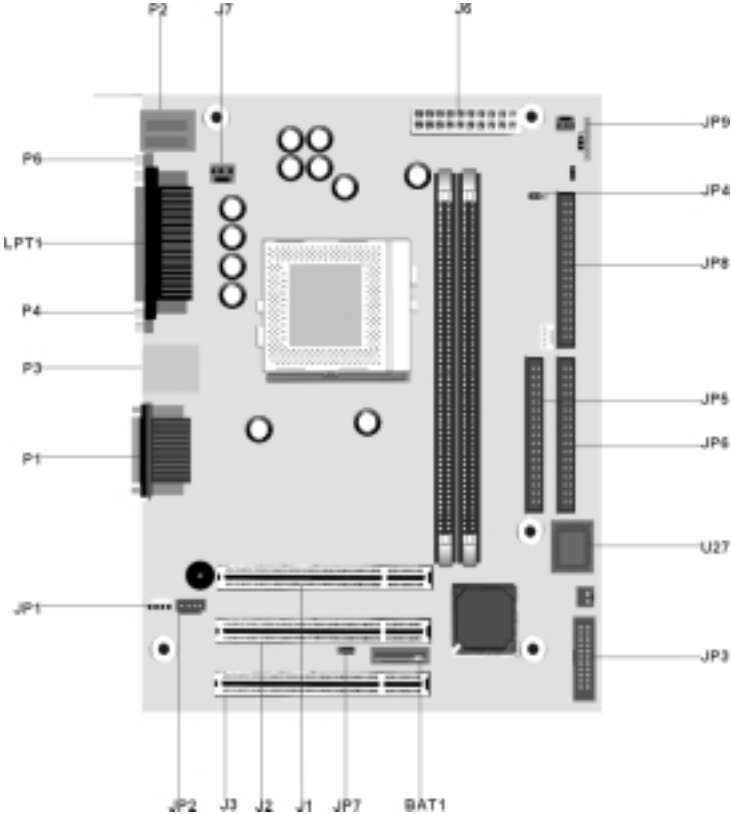

Jumpers and Connectors Locations on System Board for machine types 2255 and 2275

Jumper Settings of the System Board of the Machine Types 2255 and 2275

| Table 5-1. Jumper settings of the System Board of the Machine Types 2255 and 2275 | |
|---|--|
| Jumper/Settings | Function |
| <u>JP4</u> 1-2 2-3 | Bus Frequency(MHz) CPUCLK 133 100 |
| <u>JP7</u> CMOS data clear-up Jumper connected 1-2 2-3 | Function Normal CMOS Clear |
| <u>JP9</u> Jumper connected to Front Panel 1-2 3-4 5-8 | Indication Hard Disk Drive LED Power LED Power Button |

Connectors and Functions for the System Board of Machine Types 2255 and 2275

| Table 5-2. Connectors and Functions for the System Board of Machine Types 2255 and 2275 | |
|--|--|
| Connector | Function |
| JP1 | Passive speaker connector |
| JP2 | CD Audio connector |
| P1 | Game port, audio in, audio out and MIC connector |
| P2 | PS/2 Keyboard and Mouse connector |
| P3 | LAN and USB connector |
| P4 | VGA connector |
| P5 | LPT1 connector |
| P6 | COM 1 connector |
| J1 | PCI Slot 1 |
| J2 | PCI Slot 2 |
| J3 | PCI Slot 3 |
| BAT 1 | Battery socket |
| J7 | CPU FAN |
| JP5 | Hard Disk connector (Primary IDE) |
| JP6 | CD-ROM Drive connector (Secondary IDE) |
| JP8 | Floppy connector |
| JP9 | Front Panel Connector (power/IDE indicator and power button) |
| J6 | ATX Power connector |
| JP3 | Front USB, S/PDIF, Audio In, Audio Out and Volume control |
| U27 | Flash ROM BIOS |

Power Supply Cable Connector Specifications

Refer to the following figures when checking for voltages on power supply cable connectors.

When checking voltages, the power supply fan must be running. To power on the power supply without using the on/off switch, use a screwdriver or other tools to short the power supply connector (with the switch cable disconnected from the connector on the system board) or use a connection (jumper) to short the black and green wires of the 20-pin connector on power supply.

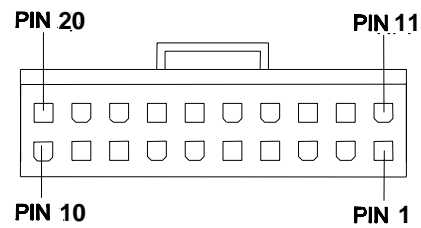

System Board Power Supply Connectors

Main Output Pin Assignment

| Pin | Function | Color |
|-----|------------|--------|
| 1 | +3.3 V | Orange |
| 2 | 3.3 V | Orange |
| 3 | COMMON | BLACK |
| 4 | +5Vdc | RED |
| 5 | COMMON | BLACK |
| 6 | +5Vdc | RED |
| 7 | COMMON | BLACK |
| 8 | POWER GOOD | GRAY |
| 9 | +5Vs | PURPLE |
| 10 | +12Vdc | YELLOW |
| 11 | 3.3V | Orange |
| 12 | -12Vdc | BLUE |
| 13 | COMMON | BLACK |
| 14 | P.S-on | GREEN |
| 15 | COMMON | BLACK |
| 16 | COMMON | BLACK |
| 17 | COMMON | BLACK |
| 18 | NC | NC |
| 19 | +5Vdc | RED |
| 20 | +5Vdc | RED |

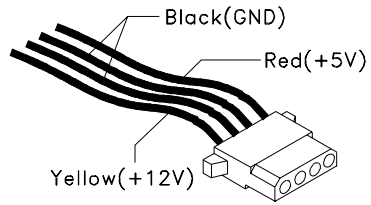

Hard Drive or CD-ROM Power Cable Connector

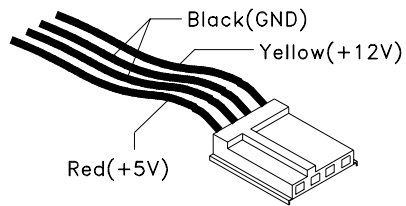

3.5-In. Diskette Drive Power Cable Connector

Factory-Installed Modem Card Layout

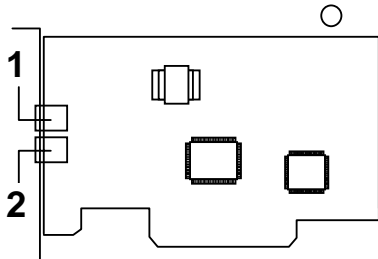

Factory-Installed Modem Card Layout

Factory-Installed Modem Card Connector Functions

| Item | Function | Connect to |
|------|---|----------------|
| 1 | Telephone line-out Some modem adapters may come without this jack. | Telephone set |
| 2 | Telephone line-in | Telephone line |

NOTE: Care should be taken while connecting the voice-in/speaker-out connector. The longer exposed end (approx. 15mm) of the cable should be connected to the modem card. The other end should be connected to the system board.

3.5-In. Hard Disk Drive Jumper Locations & Settings

3.5-in Hard Disk (Quantum) Jumper Settings Locations

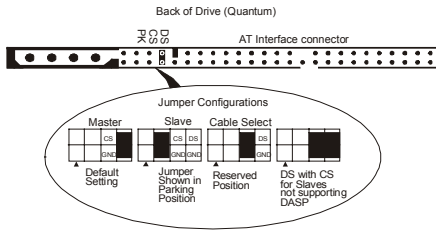

3.5-in Hard Disk (Maxtor) Jumper Settings Locations

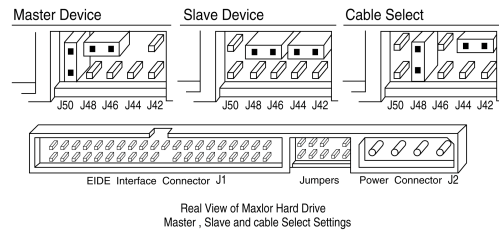

3.5-in Hard Disk (Fujitsu) Jumper Settings Locations

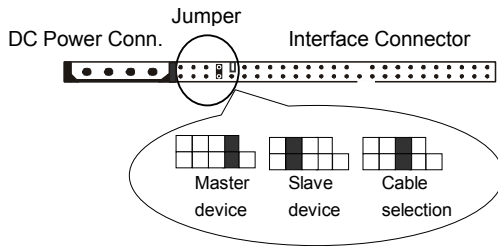

3.5-in Hard Disk (IBM) Jumper Settings Locations

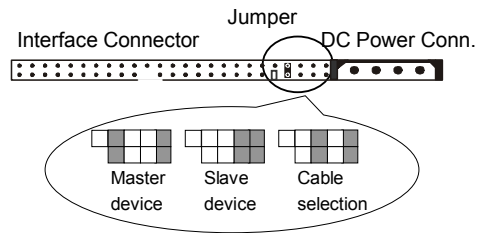

3.5-in Hard Disk (Seagate) Jumper Settings Locations

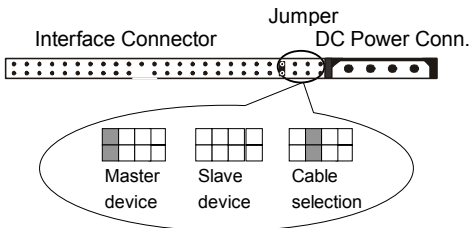

CD-ROM Drive

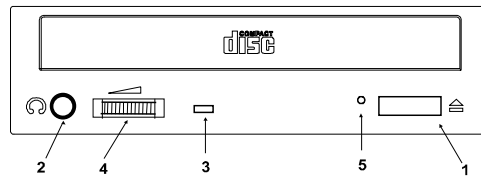

CD-ROM Front Panel

NOTE: Position of CD-ROM switches and LEDs may vary from illustration.

| Item | Description |
|------|--|
| 1 | Load / eject button |
| 2 | Headphone jack (Some optical drive will not have this jack.) |
| 3 | Power-on / busy indicator, lights up in green color while disc is set in ready state; lights up and flashes in amber color during data read or seek operation. |
| 4 | Headphone volume control |
| 5 | Emergency eject hole. See CD-ROM Emergency-exit below. |

CD-ROM Emergency-exit

If for any reason the tray does not eject automatically, insert and press an eject-bar inside the emergency eject hole to manually eject the tray. A straightened paper clip with a diameter of 1.2 mm (typical) can be used as an eject-bar.

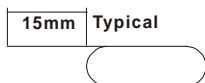

NOTE: Make sure to turn off the power before manual disc eject operation.

CD-ROM Drive Rear Panel Connectors and Features

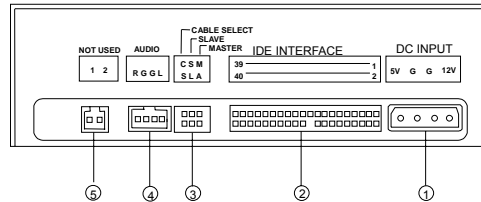

CD-ROM Rear Panel

| Item | Function | Connect to... |
|------|--------------------------------------|---------------|
| 1 | Power supply connector | Power supply |
| 2 | Configuration jumper. See Table 5-9. | -- |
| 3 | NOT USED | -- |

CD-ROM Drive Jumper Settings

| CS | SL | MA | DESCRIPTION |
|----|----|----|---|
| -- | -- | On | Drive configured as a Master. (default) |
| -- | On | -- | Drive configured as a Slave. |
| On | -- | -- | Cable select |

DIMM Configurations

The system board has two DIMM sockets. A maximum of 256KB memory may be installed.

You can install 64MB, 128MB or 256

MB DIMM in any sockets and with any combinations.

System Board Connector Pin Signals**Monitor Port Signals**

| Pin | Signal Name | I/O | Pin | Signal Name | I/O |
|-----|---------------|-----|-----|------------------|-----|
| 1 | Red Video | O | 9 | +5 V dc | N/A |
| 2 | Green Video | O | 10 | Synch Ground | N/A |
| 3 | Blue Video | O | 11 | No Connection | N/A |
| 4 | No Connection | N/A | 12 | Monitor ID Bit 1 | I |
| 5 | Synch Ground | N/A | 13 | Horizontal Synch | O |
| 6 | Red Ground | N/A | 14 | Vertical Synch | O |
| 7 | Green Ground | N/A | 15 | Monitor ID Bit 3 | I |
| 8 | Blue Ground | N/A | | | |

Serial Port Signals

| Pin | Signal Name | I/O | Pin | Signal Name | I/O |
|-----|---------------------|-----|-----|-----------------|-----|
| 1 | Data Carrier Detect | I | 6 | Data Set Ready | I |
| 2 | Receive Data | I | 7 | Request To Send | O |
| 3 | Transmit Data | O | 8 | Clear To Send | I |
| 4 | Data Terminal Ready | O | 9 | Ring Indicator | I |
| 5 | Signal Ground | N/A | | | |

Parallel Port Signals

| Pin | Signal Name | I/O | Pin | Signal Name | I/O |
|-----|-------------|-----|-----|-------------|-------|
| 1 | Strobe | O | 14 | Auto Feed | N/A |
| 2 | Data Bit 0 | I/O | 15 | Error | I |
| 3 | Data Bit 1 | I/O | 16 | Initialize | O |
| 4 | Data Bit 2 | I/O | 17 | Select (In) | O |
| 5 | Data Bit 3 | I/O | 18 | Ground | Power |
| 6 | Data Bit 4 | I/O | 19 | Ground | Power |
| 7 | Data Bit 5 | I/O | 20 | Ground | Power |
| 8 | Data Bit 6 | I/O | 21 | Ground | Power |
| 9 | Data Bit 7 | I/O | 22 | Ground | Power |
| 10 | Acknowledge | I | 23 | Ground | Power |
| 11 | Busy | I | 24 | Ground | Power |
| 12 | Paper Empty | I | 25 | Ground | Power |
| 13 | Select | O | | | |

Mouse Port Signals

| Pin | Signal Name | I/O | Pin | Signal Name | I/O |
|-----|---------------|-------|-----|---------------|-------|
| 1 | Mouse Data | I/O | 4 | +5 V dc | Power |
| 2 | No Connection | N/A | 5 | Mouse Clock | I/O |
| 3 | Ground | Power | 6 | No Connection | N/A |

Keyboard Port Signals

| Pin | Signal Name | I/O | Pin | Signal Name | I/O |
|-----|---------------|-------|-----|----------------|-------|
| 1 | Keyboard Data | I/O | 4 | +5 V dc | Power |
| 2 | Mouse Data | N/A | 5 | Keyboard Clock | I/O |
| 3 | Ground | Power | 6 | Mouse Clock | N/A |

Diskette Drive Cable Connector Signals

| Pin | Signal Name | I/O | Pin | Signal Name | I/O |
|-----|------------------|-----|-----|------------------|-----|
| 1 | No Connection | N/A | 18 | Direction SELECT | O |
| 2 | Density Select | O | 19 | Ground | N/A |
| 3 | No Connection | N/A | 20 | Step | O |
| 4 | High Density Out | I | 21 | Ground | N/A |
| 5 | Ground | N/A | 22 | Write Data | O |
| 6 | No Connection | N/A | 23 | Ground | N/A |
| 7 | Ground | N/A | 24 | Write GATE | O |
| 8 | Index | I | 25 | Ground | N/A |
| 9 | Ground | N/A | 26 | Track 0 | I |
| 10 | No Connection | N/A | 27 | Ground | N/A |
| 11 | Ground | N/A | 28 | Write Protect | I |
| 12 | Drive Select 1 | O | 29 | Ground | N/A |
| 13 | Ground | N/A | 30 | Read Data | I |
| 14 | No Connection | N/A | 31 | Ground | N/A |
| 15 | Ground | N/A | 32 | SIDE 1 SELECT | O |
| 16 | Motor On | O | 33 | Ground | N/A |
| 17 | Ground | N/A | 34 | Diskette Change | I |

IDE Cable Connector Signals

| Pin | Signal Name | I/O | Pin | Signal Name | I/O |
|-----|---------------|-------|-----|-------------------|-------|
| 1 | Host Reset | O | 21 | DMA Request | I |
| 2 | Ground | N/A | 22 | Ground | Power |
| 3 | Host Data 7 | I/O | 23 | Host IOW | O |
| 4 | Host Data 8 | I/O | 24 | Ground | Power |
| 5 | Host Data 6 | I/O | 25 | Host IOR | O |
| 6 | Host Data 9 | I/O | 26 | Ground | Power |
| 7 | Host Data 5 | I/O | 27 | I/O Channel Ready | I |
| 8 | Host Data 10 | I/O | 28 | No Connection | N/A |
| 9 | Host Data 4 | I/O | 29 | DMA Acknowledge | O |
| 10 | Host Data 11 | I/O | 30 | Ground | Power |
| 11 | Host Data 3 | I/O | 31 | Host IRQ | I |
| 12 | Host Data 12 | I/O | 32 | No Connection | N/A |
| 13 | Host Data 2 | I/O | 33 | Host A1 | O |
| 14 | Host Data 13 | I/O | 34 | No Connection | N/A |
| 15 | Host Data 1 | I/O | 35 | Host A0 | O |
| 16 | Host Data 14 | I/O | 36 | Host A2 | O |
| 17 | Host Data 0 | I/O | 37 | Host CS0 | O |
| 18 | Host Data 15 | I/O | 38 | Host CS1 | O |
| 19 | Ground | Power | 39 | ACTIVE bar | I |
| 20 | No Connection | N/A | 40 | Ground | Power |

Safety Inspection Guide

| | |
|--------------------------------------|------------|
| Safety Inspection Guide | 135 |
| General Guidelines..... | 136 |

General Guidelines

The purpose of this Safety Inspection Guide is to help you identify possible unsafe conditions on machines that are being inspected for a Maintenance Agreement. Each machine has necessary functions items installed to provide the operators and service personnel with an acceptable level of safety. This guide lists only these items. Good judgment should be used to identify possible safety conditions not covered by this Safety Inspection Guide.

If any unsafe conditions are present, you must find out how serious the hazard is and if you can continue before you correct the hazard.

All current IBM service supplements outlining feature/model changes, along with the machine history, should be reviewed.

Check the following items:

- Damaged, missing, or changed parts, especially in the area of the On/Off switch and the power supply.
- Damaged, missing, or changed covers.
- Possible safety exposure from any non-IBM attachments.

Parts Catalog

| | |
|---|-----|
| Parts Catalog of machine type 2275..... | 140 |
| Assembly 1: System Unit | 140 |
| Assembly 2: Diskette Drive, Hard Disk Drive | 142 |
| Assembly 3: CD-ROM, Modem Card | 143 |
| Assembly 4: Keyboard and Mouse | 145 |
| Parts Catalog of machine type 2255..... | 146 |
| Assembly 1: System Unit | 146 |
| Assembly 2: Diskette Drive, Hard Disk Drive | 148 |
| Assembly 3: CD-ROM, Modem Card | 149 |
| Assembly 4: Keyboard and Mouse | 150 |

Parts Catalog of machine type 2275

Assembly 1: System Unit

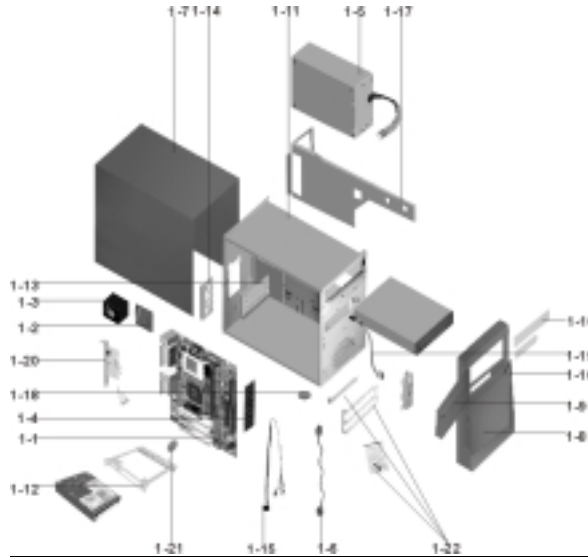

| Asm-Index | FRU Number | Description |
|-----------|------------|---|
| 1-1 | 22P2446 | Pro290E, AMD Socket 462, Supports AMD, Ethernet Down |
| 1-2 | 22P2437 | AMD Duron 700MHz (Includes Fansink) |
| 1-2 | 22P2438 | AMD Duron 750MHz (Includes Fansink) |
| 1-2 | 22P2439 | AMD Duron 800MHz (Includes Fansink) |
| 1-2 | 22P2440 | AMD Duron 850MHz (Includes Fansink) |
| 1-2 | 24P6093 | AMD Duron 900MHz (Includes Fansink) |
| 1-3 | 24P6007 | Fansink, Supports AMD Duron Processors |
| 1-4 | 19K3293 | 64MB module (PC133) |
| 1-4 | 19K3294 | 128MB module (PC133) |
| 1-5 | 00N7685 | 155W (Micro-tower) Power Supply |
| 1-6 | 6952301 | Power Cord US, LA (Lo Volt), Canada, Mexico, Peru, Colombia, Ecuador, Venezuela, Bolivia, Panama, El Salvador, Honduras, Nicaragua, Dominican Republic, Guatemala, Taiwan, Saudi Arabia, Thailand |

| | | |
|------|---------|---|
| 1-6 | 36L8879 | Power Cord APU Countries |
| 1-6 | 14F0032 | Power Cord UK/HK/Singapore/United Arab Emirate (Dubai) |
| 1-6 | 13F9978 | Power Cord (Euro) France, Germany, Sweden, Norway, Netherlands, Finland, Belgium, Bosnia, Croatia, Egypt, Greece, Hungary, Poland, Portugal, Romania, Slovenia, Spain, Sweden, Turkey, LA (HI Volt) |
| 1-6 | 13F9939 | Power Cord ANZ |
| 1-7 | 19K7810 | Top Cover, Black |
| 1-8 | 19K7812 | Front Bezel Asm, Black |
| 1-9 | 19K7815 | Door Asm |
| 1-10 | 09N1749 | Blank Bezel 5.25" BAY - BLACK |
| 1-10 | 20L3073 | EMC Shield for 5.25" Bay |
| 1-11 | 19K7811 | Chassis Asm |
| 1-12 | 22P2315 | HDD Mounting Bracket |
| 1-13 | 24P6084 | Port Bracket (Includes Passive Speaker Jack and S/PDIF Jack) |
| 1-13 | 24P6057 | Port Bracket w/Speaker Out |
| 1-14 | 24P6062 | Planar I/O EMC Shield |
| 1-15 | 19K7814 | LED/Power Switch Asm |
| 1-16 | 19K7813 | Power Button |
| 1-17 | 37L2502 | Power Supply Bracket |
| 1-18 | 03K9655 | Foot(4) |
| 1-19 | 24P6000 | Dual USB Cable, 100Mil Pin Pitch |
| 1-20 | 24P6044 | Cable assembly S/PDIF & speaker Out |
| 1-21 | 36L9077 | CMOS Backup Battery (CR2032) |
| 1-22 | 09N5764 | Misc. Hardware Kit |

Assembly 2: Diskette Drive, Hard Disk Drive

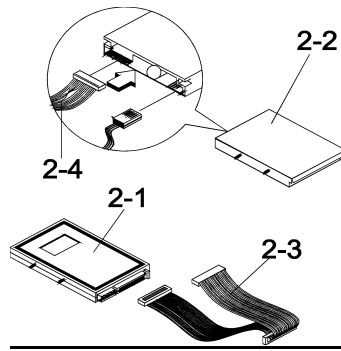

| Asm-Index | FRU Number | Description |
|-----------|------------|---|
| 2-1 | 24P6001 | 10 GB Hard Disk Drive, 3.5", 5400RPM, ATA 100, 20GB/Platter |
| 2-1 | 24P6003 | 20 GB Hard Disk Drive, 3.5", 5400RPM, ATA 100, 20GB/Platter |
| 2-1 | 24P6004 | 30 GB Hard Disk Drive, 3.5", 5400RPM, ATA 100, 20GB/Platter |
| 2-2 | 76H4091 | 3.5", Diskette Drive, 2 Mode, Black Bezel, For FFE Mechanical |
| 2-3 | 37L4525 | HDD IDE Cable – ATA 66/100 |
| 2-4 | 01K1513 | FDD Cable |

Assembly 3: CD-ROM, Modem Card

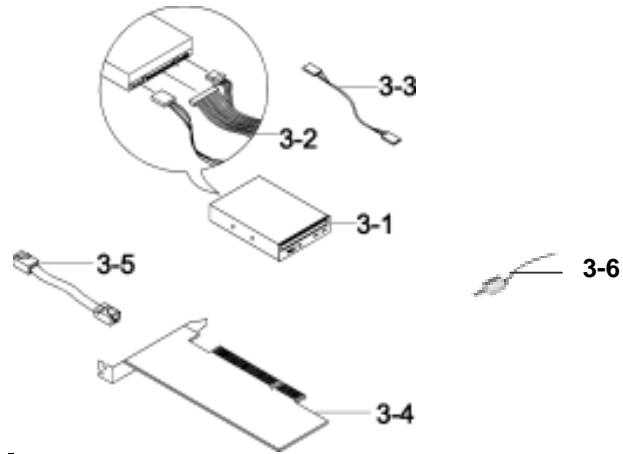

| Asm-Index | FRU Number | Description |
|-----------|------------|---|
| 3-1 | 19K3643 | 48X CD-ROM, Black |
| 3-1 | 22P2448 | 8X4X32X CD-RW, Black |
| 3-1 | 22P2404 | 12X-40X DVD-ROM, Black Bezel |
| 3-2 | 19K3358 | CD-ROM Cable |
| 3-3 | 09N5406 | CD-ROM Audio Cable |
| 3-3 | 19K3580 | CD-ROM Audio 'Y' Cable |
| 3-4 | 22P2288 | Modem 56K, GVC F-1156IV/R9C NA/LA/SA/TW/HK/China/Japan; Askey 1456VQH87, NA/LA/SA/TW/HK/China/Japan (low profile modem with full height bracket) |
| 3-4 | 22P2428 | Modem 56K, GVC F-1156IV/R9C Argentina (low profile modem with full height bracket) |
| 3-4 | 22P2289 | Modem 56K, GVC F-1156IV+/R9C, EMEA/ANZ/Singapore/India; Askey, 1456VQH87 (INT1), EMEA/ANZ/Singapore/India, (low profile modem with full height bracket) |
| 3-5 | 36L9016 | 7FT Phone Cord |
| 3-5 | 09N5423 | 7FT Phone Cord, HK |

| | | |
|------------|---------|---|
| 3-6 | 01N1872 | Modem Phone Cable Adapter Australia |
| 3-6 | 01N1874 | Modem Phone Cable Adapter New Zealand |
| 3-6 | 60H6043 | Modem Phone Cable Adapter, Spain/Southern Ireland |
| 3-6 | 60H6045 | Modem Phone Cable Adapter, Austria |
| 3-6 | 60H6046 | Modem Phone Cable Adapter, Belgium |
| 3-6 | 60H6047 | Modem Phone Cable Adapter, Denmark |
| 3-6 | 60H6048 | Modem Phone Cable Adapter, Norway/Finland |
| 3-6 | 60H6049 | Modem Phone Cable Adapter, France |
| 3-6 | 60H6050 | Modem Phone Cable Adapter, Germany |
| 3-6 | 60H6051 | Modem Phone Cable Adapter, UK/Northern Ireland |
| 3-6 | 60H6052 | Modem Phone Cable Adapter, Italy |
| 3-6 | 60H6053 | Modem Phone Cable Adapter, Netherlands |
| 3-6 | 60H6054 | Modem Phone Cable Adapter, Sweden |
| 3-6 | 60H6055 | Modem Phone Cable Adapter, Switzerland |

Assembly 4: Keyboard and Mouse



4-3



4-2

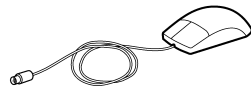

4-1

| Asm-Index | FRU Number | Description |
|-----------|------------|--|
| 4-1 | 10L6149 | Logitech Badger (2 Button), Black |
| 4-1 | 28L1868 | Scroll Point II, Black |
| 4-2 | 19K1910 | 106 US ENGLISH 103P US/ANZ/CH |
| 4-2 | 19K1920 | 107 FR CANADIAN 445 (Consumer) |
| 4-2 | 19K1930 | 107 LA SPANISH 171 |
| 4-2 | 19K1915 | 106 Chinese/US 467 HK/TW |
| 4-3 | 24P6014 | Passive, Zylux Tier 3S (No Adapter Req'd) No Logo, Black w/Sapphire Blue Grill |

Parts Catalog of machine type 2255

Assembly 1: System Unit

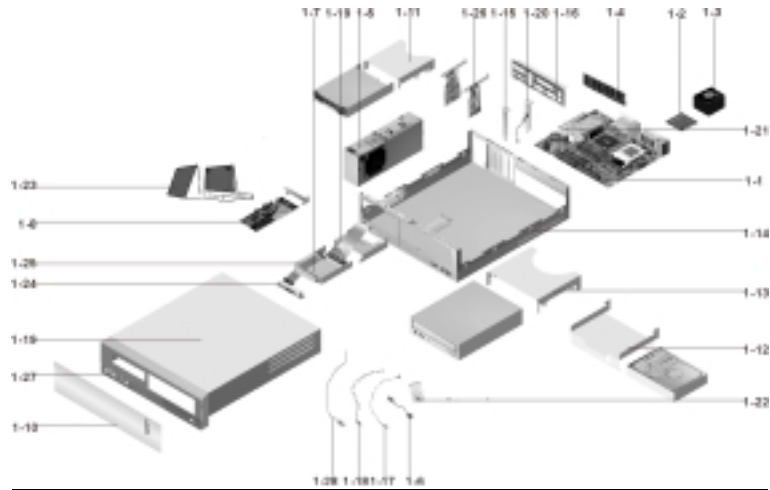

| Asm-Index | FRU Number | Description |
|-----------|------------|---|
| 1-1 | 22P2446 | Pro290E, AMD Socket 462, Supports AMD, Ethernet Down |
| 1-2 | 22P2437 | AMD Duron 700MHz (Includes Fansink) |
| 1-2 | 22P2439 | AMD Duron 800MHz (Includes Fansink) |
| 1-2 | 22P2440 | AMD Duron 850MHz (Includes Fansink) |
| 1-2 | 24P6055 | AMD Athlon 1 GHz, Low Power (Includes Fansink) |
| 1-3 | 24P6007 | Fansink, Supports AMD Duron Processors |
| 1-3 | 24P6056 | Fansink, Supports AMD Athlon Processors |
| 1-4 | 19K3293 | 64MB module (PC133) |
| 1-4 | 19K3294 | 128MB module (PC133) |
| 1-5 | 22P2442 | 120W (Desk-top), SFF, PFC, All Mdls |
| 1-6 | 6952301 | Power Cord US, LA (Lo Volt), Canada, Mexico, Peru, Colombia, Ecuador, Venezuela, Bolivia, Panama, El Salvador, Honduras, Nicaragua, Dominican Republic, Guatemala, Taiwan, Saudi Arabia, Thailand |
| 1-6 | 14F0032 | Power Cord UK/HK/Singapore/United Arab Emirate (Dubai) |
| 1-6 | 36L9015 | Power Cord Japan |
| 1-7 | 24P6045 | PCMCIA Device (Drive), w/Black Door |
| 1-8 | 19K3297 | PCMCIA Card |

| | | |
|------|---------|--|
| 1-9 | 22P2294 | Top Cover, Black, SFF |
| 1-10 | 22P2443 | Main (Bezel) Panel, Recyclable Material, Black, PIKA/VEGAS III |
| 1-10 | 22P2449 | Main (Bezel) Door, Recyclable Material, Sapphire Blue, Netvista, PIKA/VEGAS III |
| 1-10 | 22P6031 | Main (Bezel) Door, Recyclable Material, Sapphire Blue, Aptiva, PIKA/VEGAS III |
| 1-10 | 24P6020 | Bezel Blanks, FDD/PCMCIA/CD-ROM/Daughter Board, Black Pika/Vegas III |
| 1-11 | 19K3327 | FDD DASD (Holder) Bracket, DT, Used with PCMCIA bracket |
| 1-11 | 19K3642 | FDD DASD (Holder) Bracket, DT |
| 1-12 | 19K3328 | HDD DASD (Holder) Bracket, DT |
| 1-13 | 19K3329 | CD-ROM DASD (Holder) Bracket, DT |
| 1-14 | 22P2311 | Chassis (wo/power supply), DT, Black |
| 1-15 | 19K3333 | Port Bracket LP/PCI, DT |
| 1-16 | 19K3334 | Planar I/O Port EMC Shield |
| 1-17 | 19K3335 | Power Switch Cable Assembly, DT |
| 1-18 | 19K3336 | LED Cable Assembly, DT |
| 1-19 | 19K3339 | PCMCIA Cable |
| 1-20 | 19K3344 | Speaker PCI Port Bracket w/Cable, DT |
| 1-21 | 36L9077 | CMOS Backup Battery (CR2032) |
| 1-22 | 19K3346 | Screw Pack |
| 1-23 | 24P6077 | System Stand, black |
| 1-24 | 24P6033 | Daughter Card, 1 USB, 1394, S/PDIF, Volume Control, Head Phone Jack, Microphone Jack, Pika |
| 1-24 | 24P6034 | Daughter Card, 2 USB, S/PDIF, Volume Control, Head Phone Jack, Microphone Jack, Pika |
| 1-25 | 22P2296 | Cable Assembly, supports USB, SPDIF, Volume Control, Head Phone Jack, Microphone Jack |
| 1-26 | 22P2447 | IEEE 1394 Card, 6 Pin w/Low Profile Bracket |
| 1-27 | 24P6021 | Daughter Board Bezel, supports 1 USB, 1394, SPDIF, Volume Control, Head Phone Jack, Microphone Jack, Black, Pika/Vegas III |
| 1-27 | 24P6022 | Daughter Board Bezel, supports 2 USB, SPDIF, Volume Control, Head Phone Jack Microphone Jack, Black, Pika/Vegas III |
| 1-28 | 22P2297 | Cable, Supports IEEE 1394 (Firewire) |

Assembly 2: Diskette Drive, Hard Disk Drive

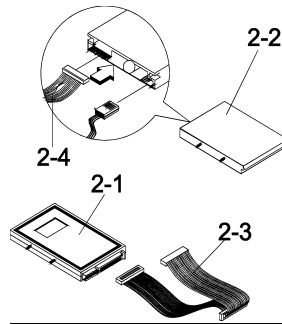

| Asm-Index | FRU Number | Description |
|-----------|------------|---|
| 2-1 | 24P6003 | 20GB HDD, 3.5", 5400RPM, ATA100, 20GB/Platter |
| 2-1 | 24P6006 | 60GB HDD, 3.5", 5400 RPM, ATA 100, 20GB/Platter, Pika/Vegas III |
| 2-1 | 24P6024 | 80GB HDD, 3.5" 5400 RPM, ATA 100, 20GB/Platter |
| 2-2 | 24P6035 | 3.5", FDD , 2 Mode w/Black Bezel |
| 2-3 | 24P6079 | HDD Cable, DT |
| 2-4 | 19K3340 | Diskette Drive Cable |

Assembly 3: CD-ROM, Modem Card

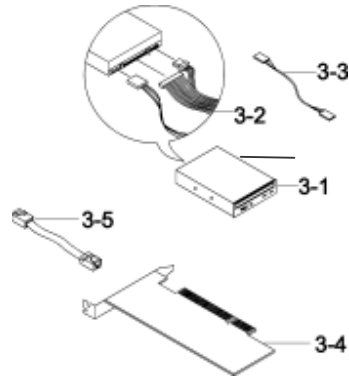

| Asm-Index | FRU Number | Description |
|-----------|------------|--|
| 3-1 | 19K3643 | 48X CD-ROM, Black Bezel |
| 3-1 | 22P2448 | 8X4X32X CD-RW, Black Bezel |
| 3-1 | 22P2404 | 12X-40X DVD-ROM, Black Bezel |
| 3-1 | 06P5289 | 8X CD-R/4X CD-RW/32X CD-ROM/8X DVD-ROM DRIVE, BLACK |
| 3-2 | 19K3342 | CD-ROM Cable |
| 3-2 | 24P6081 | CD-ROM Cable |
| 3-3 | 09N5406 | Audio Cable, CD-ROM, Used w/MSI-6188 810E Planar |
| 3-4 | 22P2286 | Modem 56K, For SFF GVC F-1156IV/R9C NA/LA/SA/Japan/China/TW/HK Askey, 1456VQH87, NA/LA/SA/Japan/China/TW/HK, (Low profile modem with short bracket) |
| 3-5 | 36L9016 | 7FT Phone Cord |
| 3-5 | 09N5423 | 7FT Phone Cord, Hong Kong |

Assembly 4: Keyboard and Mouse

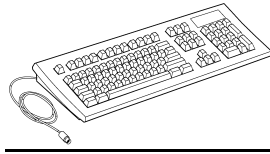

4-2

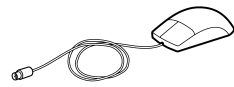

4-1



4-3

| Asm-Index | FRU Number | Description |
|------------------|-------------------|---|
| 4-1 | 10L6149 | BADGER, Black |
| 4-1 | 28L1868 | Scroll Point II, Black |
| 4-2 | 19K1915 | 106 Chinese/US/ 467 HK/TW |
| 4-2 | 19K1928 | 111 Japanese 194 |
| 4-3 | 24P6014 | Passive, Zylux Tier 3S (No Adapter Req'd) No Logo, Black w/Sapphire BlueGrill |

Appendix A. Online Support Information

This section describes online technical support services available to help repair the computer.

This section covers:

- IBM PC Company Fax-Back Service
- IBM useful sites on the World Wide Web (WWW)
- IBM Online Assistant
- Discussion Forums

The IBM PC Company offers online resources including several Internet World Wide Web sites, the IBM Online HelpCenter support areas, and a Fax-Back service.

The IBM Automated Fax-Back System offers a variety of IBM computer-related articles. To access this service, call 800-IBM-3395. The Fax-Back system file library can also be accessed through the PC Company BBS.

The IBM Online Assistant will help you to diagnose and resolve technical problems by giving you access to the same tools used by IBM PC HelpCenter specialists. IBM Online Assistant guides you from symptom to resolution, by asking simple questions based on the collective experience of IBM senior support specialists. In addition many recommended next steps link to the extensive IBM online library, providing access to supporting information during the diagnostic process. To access the Online Assistant go to the IBM support web site, (<http://www.ibm.com/support>) press the profile button and set up your personal profile. Your profile will give you access to the IBM Online Assistant through your personalized page.

For other technical questions your personalized page will also give you access to IBM Discussion Forums. The forums are monitored by IBM HelpCenter technicians to answer your technical questions.

Here is useful IBM Internet addresses for information:

<http://www.ibm.com/support>

IBM Home Page on the World Wide Web

Index

A

Adapter Cards
 Installing, 96
 Removing, 97

Audio

 Check Procedure, 75
 Error Symptoms, 67

B

Beeps, 54, 60, 61
BIOS
 Flash Update Procedure, 40
 Model Number and Serial Number, 41
BIOS setup Utility, 42

C

Cabling, 36
CD-ROM Drive, 36, 38, 99, 127
 Check Procedure, 76
 Connectors and Features, 128
 Emergency-exit, 127
 Error Symptoms, 66
 Front Panel, 127
Jumper Settings, 128
Check Procedures, 53
CMOS Reset, 39

D

Diagnostic Aids, 85
Diagnostic Diskette, 68
Diagnostic Program
 Error symptoms, 68
Diagnostic Program
 Using from Recovery CD, 88
Diagnostic Tools, 88
Diskette Drive, 36, 38, 98
 Connector Signals, 132
 Error Symptoms, 65

E

Electrical Input, 49
Error Codes, 60, 61
Error Messages, 60, 61
Error Symptoms, 60, 65
External Ports, 35
 Ethernet Port, 38
 Game Port, 38
 Parallel Port, 38
 Serial Port, 38
 USB port, 38

F

Fan
 Error Symptoms 65, 81

H

Hard Disk Drive 36, 100
 3.5-In. Jumper Locations & Settings, 126
 32-bit Access, 38
 Check Procedure, 71
 Error Symptoms, 66
 PIO Mode, 38
 Hard Disk Drive, 38

I

IDE
 Connector Signals, 133

J

Joystick, 38, 89
 Error Symptoms, 68

K

Keyboard, 37
 Check Procedure, 78
 Error Symptoms, 69
Keyboard Port
 Port Signals, 131

M

- Memory, 35
 - Check Procedure, 78
 - DIMM Configurations, 129
 - Error Symptoms, 65
- Model Number, 41
- Modem, 37
 - Check Procedure, 73
 - Connector Functions, 125
 - Error Symptoms, 67
 - Layout, 125
- Monitor, 37
 - Check Procedure, 83
 - Error Symptoms, 67
 - Port Signals, 130
- Mouse, 37
 - Check Procedure, 79
- Mouse Port
 - Port Signals, 131

O

- Online Support Information, 151

P

- Parallel Port, 38, 130
 - Error Symptoms, 68
 - Port Signals, 130
- Parts Catalog of machine type 2275, 140
 - CD-ROM, Modem Card, 143
 - Diskette Drive, Hard Disk Drive, 142
 - Keyboard and Mouse, 145
 - System Unit, 140
- Parts Catalog of machine type 2255, 146
 - CD-ROM, Modem Card, 149
 - Diskette Drive, Hard Disk Drive, 148
 - Keyboard and Mouse, 150
 - System Unit, 146
- Parts/Test Point Locations, 117
- Password
 - Setting, 48
- PCI, 38
 - PIO Mode, 38
 - Plug and Play, 37
- POST, 55
- Power Consumption, 49
- Power Management, 36, 47

Power Supply, 36

- Check Procedure, 81
 - Connector Specifications, 122
 - Error Symptoms, 69
- ## **Processor**
- Error Symptom, 65

R

- Real-Time Clock
 - Error Symptoms 67
- Removals and Replacements of the machine 2175, 92
 - Adapter Cards, 96
 - CD-ROM Drive, 99
 - Diskette Drive, 98
 - Hard Disk Drive, 100
 - Memory (DIMM), 103
 - Power Supply, 102
 - System Board, 101
 - Top Cover, 95
- Repair Information, 91
- Removals and Replacements of the machine type 2255, 104
 - Adapter Cards, 108
 - CD-ROM Drive, 111
 - Diskette Drive, 110
 - Hard Disk Drive, 112
 - Memory (DIMM), 116
 - Power Supply, 115
 - System Board, 113
 - Top Cover, 107
- Repair Information, 91

S

- Safety Inspection Guide, 135
- Serial Number, 41
- Serial Port, 35, 38,44
 - Error Symptoms, 68
 - Port Signals, 130
- Specifications, 49
 - Dimensions, 49
 - Electrical Input, 49
 - Environment, 49
 - Power Consumption, 49
 - Weight, 49
- System Board,101
 - Layout of the System Board for Machine Types 2255 and 2275,119
 - Jumper Settings of the System Board of the Machine Types 2255 and 2275,120
 - Connectors and Functions for the System Board of Machine Types 2255 and 2275,121
 - Error Symptoms, 65

T

- Tools, 51

U

Undetermined Problems
 Check Procedure, 84
USB, 38

V

Video, 35
 Error Symptoms, 67



Printed in U.S.A.

International Business Machines Corporation
Old Orchard Road,
Armonk, New York 10504

Part Number: 24P2908
Pub Number: S24P-2900-00
04/06