

Bull

AIX 5L Performance Management Guide

AIX

ORDER REFERENCE
86 A2 54EM 02



Bull

AIX 5L Performance Management Guide

AIX

Software

October 2005

**BULL CEDOC
357 AVENUE PATTON
B.P.20845
49008 ANGERS CEDEX 01
FRANCE**

ORDER REFERENCE
86 A2 54EM 02

The following copyright notice protects this book under the Copyright laws of the United States of America and other countries which prohibit such actions as, but not limited to, copying, distributing, modifying, and making derivative works.

Copyright © Bull S.A. 1992, 2005

Printed in France

Suggestions and criticisms concerning the form, content, and presentation of this book are invited. A form is provided at the end of this book for this purpose.

To order additional copies of this book or other Bull Technical Publications, you are invited to use the Ordering Form also provided at the end of this book.

Trademarks and Acknowledgements

We acknowledge the right of proprietors of trademarks mentioned in this book.

AIX[®] is a registered trademark of International Business Machines Corporation, and is being used under licence.

UNIX is a registered trademark in the United States of America and other countries licensed exclusively through the Open Group.

Linux is a registered trademark of Linus Torvalds.

Contents

| | |
|--|-----|
| About This Book | vii |
| Highlighting | vii |
| Case-Sensitivity in AIX. | vii |
| ISO 9000 | vii |
| Related Publications | vii |
| | |
| Chapter 1. Performance overview | 1 |
| System workload | 1 |
| Performance objectives. | 2 |
| Program execution model | 2 |
| Hardware hierarchy | 3 |
| Software hierarchy | 4 |
| System Tuning | 6 |
| | |
| Chapter 2. Performance tuning | 7 |
| Introduction to the performance-tuning process | 7 |
| Performance benchmarking | 11 |
| | |
| Chapter 3. Performance tuning enhancements for AIX 5.2 | 15 |
| AIX kernel tuning parameter modifications | 15 |
| Replacements for the vmtune and schedtune commands | 15 |
| Enhancements to the no and nfso commands | 18 |
| AIX 5.2 compatibility mode | 19 |
| AIX 5.2 system recovery procedures | 20 |
| | |
| Chapter 4. System performance monitoring | 21 |
| Advantages of continuous system performance monitoring | 21 |
| Continuous system-performance monitoring with the vmstat, iostat, netstat, and sar commands. | 21 |
| Continuous system-performance monitoring with the topas monitor | 23 |
| Continuous system-performance monitoring with the Performance Toolbox | 25 |
| | |
| Chapter 5. Initial performance diagnosis | 27 |
| Types of reported performance problems | 27 |
| Performance-Limiting Resource identification | 30 |
| Workload Management Diagnosis | 35 |
| | |
| Chapter 6. Resource Management Overview | 37 |
| Performance Overview of the processor Scheduler | 37 |
| Performance Overview of the Virtual Memory Manager (VMM) | 43 |
| Performance overview of fixed-disk storage management. | 51 |
| Support for pinned memory | 53 |
| | |
| Chapter 7. Introduction to Multiprocessing | 55 |
| Symmetrical Multiprocessor (SMP) Concepts and Architecture | 55 |
| SMP Performance Issues | 61 |
| SMP Workloads | 62 |
| SMP Thread Scheduling | 65 |
| Thread Tuning | 67 |
| SMP Tools | 72 |
| | |
| Chapter 8. Planning and Implementing for Performance | 75 |
| Identifying the Components of the Workload | 75 |
| Documenting Performance Requirements | 76 |

| | |
|---|------------|
| Estimating the resource requirements of the workload | 76 |
| Designing and Implementing Efficient Programs | 82 |
| Using Performance-Related Installation Guidelines | 90 |
| Chapter 9. POWER4-based systems | 95 |
| POWER4 performance enhancements. | 95 |
| Scalability enhancements for POWER4-based systems | 95 |
| 64-bit kernel | 96 |
| Enhanced Journaled File System (JFS2) | 97 |
| Related information. | 97 |
| Chapter 10. CPU performance | 99 |
| CPU performance monitoring | 99 |
| Use of the time command to measure CPU use. | 106 |
| Identification of CPU-intensive programs | 107 |
| Use of the pprof command to measure CPU usage of kernel threads | 109 |
| Detection of instruction emulation with the emstat tool | 111 |
| Detection of alignment exceptions with the alstat tool | 112 |
| Restructure of executable programs with the fdpr program | 113 |
| Controlling contention for the CPU. | 114 |
| CPU-efficient user id administration with the mkpasswd command | 119 |
| Chapter 11. Memory performance | 121 |
| Memory usage | 121 |
| Memory-leaking programs | 133 |
| Memory requirements assessment with the rmss command | 134 |
| VMM memory load control tuning with the schedo command | 140 |
| VMM page replacement tuning | 143 |
| Page space allocation | 148 |
| Paging-space thresholds tuning | 149 |
| Paging space garbage collection | 150 |
| Shared memory | 152 |
| AIX memory affinity support | 153 |
| Large page feature on AIX. | 155 |
| Chapter 12. Logical volume and disk I/O performance | 159 |
| Monitoring Disk I/O | 159 |
| LVM performance monitoring with the lvmstat command. | 177 |
| Changing Logical Volume Attributes That Affect Performance | 178 |
| LVM performance tuning with the lvmo command | 181 |
| Physical Volume Considerations | 182 |
| Volume Group Recommendations | 182 |
| Reorganizing Logical Volumes | 183 |
| Tuning Logical Volume Striping | 185 |
| Using Raw Disk I/O | 187 |
| Using sync/fsync Calls | 187 |
| Setting SCSI-Adapter and Disk-Device Queue Limits | 188 |
| Expanding the Configuration | 188 |
| Using RAID | 189 |
| Using SSA | 191 |
| Using Fast Write Cache | 192 |
| Chapter 13. File system performance | 193 |
| File system overview. | 193 |
| Potential performance inhibitors for JFS and Enhanced JFS | 198 |
| File system performance enhancements | 198 |

| | |
|--|------------|
| Summary of file system tunable parameters | 201 |
| File system attributes that affect performance. | 201 |
| Reorganization of file systems | 203 |
| File system performance tuning | 205 |
| Reorganization of file system logs and log logical volumes | 211 |
| Disk I/O pacing | 212 |
| Chapter 14. Network performance | 215 |
| TCP and UDP performance tuning. | 215 |
| Tuning mbuf pool performance | 242 |
| ARP cache tuning | 245 |
| Name resolution tuning | 246 |
| Network performance analysis | 247 |
| Tuning the SP Network | 278 |
| Chapter 15. NFS performance | 283 |
| NFS overview | 283 |
| NFS performance monitoring and tuning | 287 |
| NFS performance monitoring on the server | 294 |
| NFS performance tuning on the server | 295 |
| NFS performance monitoring on the client | 297 |
| NFS tuning on the client | 299 |
| Cache file system | 304 |
| NFS references. | 307 |
| Chapter 16. LPAR performance | 311 |
| Performance considerations with logical partitioning | 311 |
| Workload management in a partition | 312 |
| LPAR performance impacts | 313 |
| CPUs in a partition | 313 |
| Virtual processor management within a partition. | 314 |
| Application considerations | 315 |
| Chapter 17. Dynamic logical partitioning | 317 |
| DLPAR overview | 317 |
| DLPAR performance implications | 318 |
| DLPAR tuning tools | 318 |
| DLPAR guidelines for adding CPUs or memory | 319 |
| Chapter 18. Micro-Partitioning | 321 |
| Micro-Partitioning overview | 321 |
| Implementation of Micro-Partitioning | 322 |
| Micro-Partitioning performance implications | 322 |
| Chapter 19. Application Tuning | 323 |
| Compiler Optimization Techniques | 323 |
| Optimizing Preprocessors for FORTRAN and C | 331 |
| Code-Optimization Techniques | 331 |
| Chapter 20. Java performance monitoring | 333 |
| Advantages of Java | 333 |
| Java performance guidelines | 333 |
| Java monitoring tools | 334 |
| Java tuning for AIX | 334 |
| Garbage collection impacts to Java performance | 335 |

| | |
|---|-----|
| Chapter 21. Analyzing Performance with the Trace Facility | 337 |
| Understanding the Trace Facility | 337 |
| Example of Trace Facility Use | 339 |
| Starting and Controlling Trace from the Command Line | 341 |
| Starting and Controlling Trace from a Program | 342 |
| Using the trcrpt Command to Format a Report | 342 |
| Adding New Trace Events | 344 |
| Chapter 22. Reporting Performance Problems | 349 |
| Measuring the Baseline | 349 |
| What is a Performance Problem | 350 |
| Performance Problem Description | 350 |
| Reporting a Performance Problem | 350 |
| Appendix A. Monitoring and Tuning Commands and Subroutines | 353 |
| Performance Reporting and Analysis Commands | 353 |
| Performance Tuning Commands | 356 |
| Performance-Related Subroutines | 357 |
| Appendix B. Efficient Use of the ld Command | 359 |
| Rebindable Executable Programs | 359 |
| Prebound Subroutine Libraries | 359 |
| Examples | 359 |
| Appendix C. Accessing the Processor Timer | 361 |
| POWER-based-Architecture-Unique Timer Access | 362 |
| Accessing Timer Registers in PowerPC Systems | 363 |
| Example of the second Subroutine. | 363 |
| Appendix D. Determining CPU Speed | 365 |
| Appendix E. National Language Support: Locale versus Speed | 369 |
| Programming Considerations | 369 |
| Some Simplifying Rules | 370 |
| Setting the Locale | 370 |
| Appendix F. Summary of Tunable Parameters | 371 |
| Environment Variables | 371 |
| Kernel Tunable Parameters | 383 |
| Network Tunable Parameters | 390 |
| Appendix G. Test Case Scenarios | 395 |
| Improving NFS Client Large File Writing Performance | 395 |
| Improve Tivoli Storage Manager (TSM) Backup Performance | 396 |
| Streamline Security Subroutines with Password Indexing | 397 |
| Index | 403 |

About This Book

The Performance Management Guide provides application programmers, customer engineers, system engineers, system administrators, experienced end users, and system programmers with complete information about how to perform such tasks as assessing and tuning the performance of processors, file systems, memory, disk I/O, NFS, JAVA, and communications I/O. The guide also addresses efficient system and application design, including their implementation. This publication is also available on the documentation CD that is shipped with the operating system.

Highlighting

The following highlighting conventions are used in this book:

| | |
|----------------|---|
| Bold | Identifies commands, subroutines, keywords, files, structures, directories, and other items whose names are predefined by the system. Also identifies graphical objects such as buttons, labels, and icons that the user selects. |
| <i>Italics</i> | Identifies parameters whose actual names or values are to be supplied by the user. |
| Monospace | Identifies examples of specific data values, examples of text similar to what you might see displayed, examples of portions of program code similar to what you might write as a programmer, messages from the system, or information you should actually type. |

Case-Sensitivity in AIX

Everything in the AIX[®] operating system is case-sensitive, which means that it distinguishes between uppercase and lowercase letters. For example, you can use the **ls** command to list files. If you type **LS**, the system responds that the command is "not found." Likewise, **FILEA**, **FiLea**, and **filea** are three distinct file names, even if they reside in the same directory. To avoid causing undesirable actions to be performed, always ensure that you use the correct case.

ISO 9000

ISO 9000 registered quality systems were used in the development and manufacturing of this product.

Related Publications

The following books contain information about or related to performance monitoring:

- *AIX 5L Version 5.3 Commands Reference*
- *AIX 5L Version 5.3 Technical Reference*
- *AIX 5L Version 5.3 Files Reference*
- *AIX 5L Version 5.3 System User's Guide: Operating System and Devices*
- *AIX 5L Version 5.3 System User's Guide: Communications and Networks*
- *AIX 5L Version 5.3 System Management Guide: Operating System and Devices*
- *AIX 5L Version 5.3 System Management Guide: Communications and Networks*
- *AIX 5L Version 5.3 General Programming Concepts: Writing and Debugging Programs*
- *Performance Toolbox Version 2 and 3 for AIX: Guide and Reference*
- *PCI Adapter Placement Reference*, order number SA38-0538

Chapter 1. Performance overview

This topic includes information on the dynamics of program execution and provides a conceptual framework for evaluating system performance. It contains the following sections:

- System workload
- Performance objectives
- Program execution model
- Hardware hierarchy
- Software hierarchy
- System tuning

System workload

An accurate and complete definition of a system's workload is critical to predicting or understanding its performance. A difference in workload can cause far more variation in the measured performance of a system than differences in CPU clock speed or random access memory (RAM) size. The workload definition must include not only the type and rate of requests sent to the system, but also the exact software packages and in-house application programs to be executed.

It is important to include the work that a system is doing in the background. For example, if a system contains file systems that are NFS-mounted and frequently accessed by other systems, handling those accesses is probably a significant fraction of the overall workload, even though the system is not officially a server.

A workload that has been standardized to allow comparisons among dissimilar systems is called a *benchmark*. However, few real workloads duplicate the exact algorithms and environment of a benchmark. Even industry-standard benchmarks that were originally derived from real applications have been simplified and homogenized to make them portable to a wide variety of hardware platforms. The only valid use for industry-standard benchmarks is to narrow the field of candidate systems that will be subjected to a serious evaluation. Therefore, you should not solely rely on benchmark results when trying to understand the workload and performance of your system.

It is possible to classify workloads into the following categories:

Multiuser

A workload that consists of a number of users submitting work through individual terminals. Typically, the performance objectives of such a workload are either to maximize system throughput while preserving a specified worst-case response time or to obtain the best possible response time for a constant workload.

Server

A workload that consists of requests from other systems. For example, a file-server workload is mostly disk read and disk write requests. It is the disk-I/O component of a multiuser workload (plus NFS or other I/O activity), so the same objective of maximum throughput within a given response-time limit applies. Other server workloads consist of items such as math-intensive programs, database transactions, printer jobs.

Workstation

A workload that consists of a single user submitting work through a keyboard and receiving results on the display of that system. Typically, the highest-priority performance objective of such a workload is minimum response time to the user's requests.

Performance objectives

After defining the workload that your system will have to process, you can choose performance criteria and set performance objectives based on those criteria. The overall performance criteria of computer systems are response time and throughput.

Response time is the elapsed time between when a request is submitted and when the response from that request is returned. Examples include:

- The amount of time a database query takes
- The amount of time it takes to echo characters to the terminal
- The amount of time it takes to access a Web page

Throughput is a measure of the amount of work that can be accomplished over some unit of time.

Examples include:

- Database transactions per minute
- Kilobytes of a file transferred per second
- Kilobytes of a file read or written per second
- Web server hits per minute

The relationship between these metrics is complex. Sometimes you can have higher throughput at the cost of response time or better response time at the cost of throughput. In other situations, a single change can improve both. Acceptable performance is based on reasonable throughput combined with reasonable response time.

In planning for or tuning any system, make sure that you have clear objectives for both response time and throughput when processing the specified workload. Otherwise, you risk spending analysis time and resource dollars improving an aspect of system performance that is of secondary importance.

Program execution model

To clearly examine the performance characteristics of a workload, a dynamic rather than a static model of program execution is necessary, as shown in the following figure.

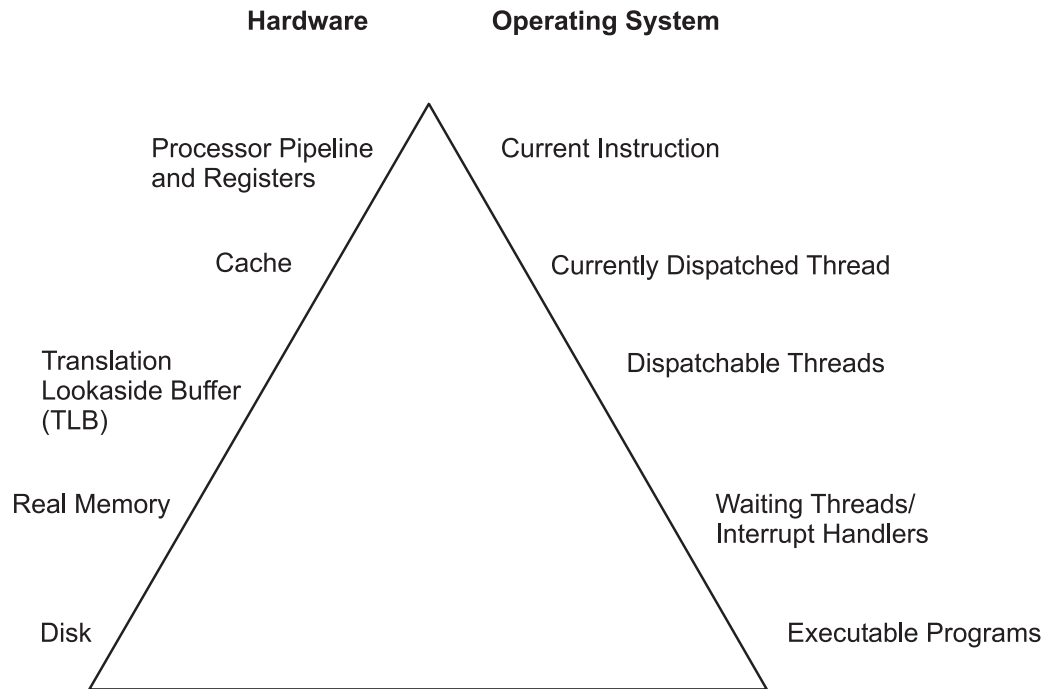

Figure 1. Program Execution Hierarchy. The figure is a triangle on its base. The left side represents hardware entities that are matched to the appropriate operating system entity on the right side. A program must go from the lowest level of being stored on disk, to the highest level being the processor running program instructions. For instance, from bottom to top, the disk hardware entity holds executable programs; real memory holds waiting operating system threads and interrupt handlers; the translation lookaside buffer holds dispatchable threads; cache contains the currently dispatched thread and the processor pipeline and registers contain the current instruction.

To run, a program must make its way up both the hardware and operating-system hierarchies in parallel. Each element in the hardware hierarchy is more scarce and more expensive than the element below it. Not only does the program have to contend with other programs for each resource, the transition from one level to the next takes time. To understand the dynamics of program execution, you need a basic understanding of each of the levels in the hierarchy.

Hardware hierarchy

Usually, the time required to move from one hardware level to another consists primarily of the latency of the lower level (the time from the issuing of a request to the receipt of the first data).

Fixed disks

The slowest operation for a running program on a standalone system is obtaining code or data from a disk, for the following reasons:

- The disk controller must be directed to access the specified blocks (queuing delay).
- The disk arm must seek to the correct cylinder (seek latency).
- The read/write heads must wait until the correct block rotates under them (rotational latency).
- The data must be transmitted to the controller (transmission time) and then conveyed to the application program (interrupt-handling time).

Slow disk operations can have many causes besides explicit read or write requests in the program. System-tuning activities frequently prove to be hunts for unnecessary disk I/O.

Real memory

Real memory, often referred to as Random Access Memory, or RAM, is faster than disk, but much more expensive per byte. Operating systems try to keep in RAM only the code and data that are currently in use, storing any excess onto disk, or never bringing them into RAM in the first place.

RAM is not necessarily faster than the processor though. Typically, a RAM latency of dozens of processor cycles occurs between the time the hardware recognizes the need for a RAM access and the time the data or instruction is available to the processor.

If the access is going to a page of virtual memory that is stored over to disk, or has not been brought in yet, a page fault occurs, and the execution of the program is suspended until the page has been read from disk.

Translation Lookaside Buffer (TLB)

Programmers are insulated from the physical limitations of the system by the implementation of virtual memory. You design and code programs as though the memory were very large, and the system takes responsibility for translating the program's virtual addresses for instructions and data into the real addresses that are needed to get the instructions and data from RAM. Because this address-translation process can be time-consuming, the system keeps the real addresses of recently accessed virtual-memory pages in a cache called the translation lookaside buffer (TLB).

As long as the running program continues to access a small set of program and data pages, the full virtual-to-real page-address translation does not need to be redone for each RAM access. When the program tries to access a virtual-memory page that does not have a TLB entry, called a *TLB miss*, dozens of processor cycles, called the *TLB-miss latency* are required to perform the address translation.

Caches

To minimize the number of times the program has to experience the RAM latency, systems incorporate caches for instructions and data. If the required instruction or data is already in the cache, a cache hit results and the instruction or data is available to the processor on the next cycle with no delay. Otherwise, a cache miss occurs with RAM latency.

In some systems, there are two or three levels of cache, usually called L1, L2, and L3. If a particular storage reference results in an L1 miss, then L2 is checked. If L2 generates a miss, then the reference goes to the next level, either L3, if it is present, or RAM.

Cache sizes and structures vary by model, but the principles of using them efficiently are identical.

Pipeline and registers

A pipelined, superscalar architecture makes possible, under certain circumstances, the simultaneous processing of multiple instructions. Large sets of general-purpose registers and floating-point registers make it possible to keep considerable amounts of the program's data in registers, rather than continually storing and reloading the data.

The optimizing compilers are designed to take maximum advantage of these capabilities. The compilers' optimization functions should always be used when generating production programs, however small the programs are. The *Optimization and Tuning Guide for XL Fortran, XL C and XL C++* describes how programs can be tuned for maximum performance.

Software hierarchy

To run, a program must also progress through a series of steps in the software hierarchy.

Executable programs

When you request a program to run, the operating system performs a number of operations to transform the executable program on disk to a running program. First, the directories in the your current **PATH** environment variable must be scanned to find the correct copy of the program. Then, the system loader (not to be confused with the **ld** command, which is the binder) must resolve any external references from the program to shared libraries.

To represent your request, the operating system creates a process, or a set of resources, such as a private virtual address segment, which is required by any running program.

The operating system also automatically creates a single thread within that process. A *thread* is the current execution state of a single instance of a program. In AIX, access to the processor and other resources is allocated on a thread basis, rather than a process basis. Multiple threads can be created within a process by the application program. Those threads share the resources owned by the process within which they are running.

Finally, the system branches to the entry point of the program. If the program page that contains the entry point is not already in memory (as it might be if the program had been recently compiled, executed, or copied), the resulting page-fault interrupt causes the page to be read from its backing storage.

Interrupt handlers

The mechanism for notifying the operating system that an external event has taken place is to interrupt the currently running thread and transfer control to an interrupt handler. Before the interrupt handler can run, enough of the hardware state must be saved to ensure that the system can restore the context of the thread after interrupt handling is complete. Newly invoked interrupt handlers experience all of the delays of moving up the hardware hierarchy (except page faults). Unless the interrupt handler was run very recently (or the intervening programs were very economical), it is unlikely that any of its code or data remains in the TLBs or the caches.

When the interrupted thread is dispatched again, its execution context (such as register contents) is logically restored, so that it functions correctly. However, the contents of the TLBs and caches must be reconstructed on the basis of the program's subsequent demands. Thus, both the interrupt handler and the interrupted thread can experience significant cache-miss and TLB-miss delays as a result of the interrupt.

Waiting threads

Whenever an executing program makes a request that cannot be satisfied immediately, such as a synchronous I/O operation (either explicit or as the result of a page fault), that thread is put in a waiting state until the request is complete. Normally, this results in another set of TLB and cache latencies, in addition to the time required for the request itself.

Dispatchable threads

When a thread is dispatchable but not running, it is accomplishing nothing useful. Worse, other threads that are running may cause the thread's cache lines to be reused and real memory pages to be reclaimed, resulting in even more delays when the thread is finally dispatched.

Currently dispatched threads

The scheduler chooses the thread that has the strongest claim to the use of the processor. The considerations that affect that choice are discussed in Performance Overview of the CPU Scheduler. When the thread is dispatched, the logical state of the processor is restored to the state that was in effect when the thread was interrupted.

Current machine instructions

Most of the machine instructions are capable of executing in a single processor cycle if no TLB or cache miss occurs. In contrast, if a program branches rapidly to different areas of the program and accesses data from a large number of different areas causing high TLB and cache-miss rates, the average number of processor cycles per instruction (CPI) executed might be much greater than one. The program is said to exhibit poor locality of reference. It might be using the minimum number of instructions necessary to do its job, but it is consuming an unnecessarily large number of cycles. In part because of this poor correlation between number of instructions and number of cycles, reviewing a program listing to calculate path length no longer yields a time value directly. While a shorter path is usually faster than a longer path, the speed ratio can be very different from the path-length ratio.

The compilers rearrange code in sophisticated ways to minimize the number of cycles required for the execution of the program. The programmer seeking maximum performance must be primarily concerned with ensuring that the compiler has all of the information necessary to optimize the code effectively, rather than trying to second-guess the compiler's optimization techniques (see Effective Use of Preprocessors and the Compilers). The real measure of optimization effectiveness is the performance of an authentic workload.

System Tuning

After efficiently implementing application programs, further improvements in the overall performance of your system becomes a matter of system tuning. The main components that are subject to system-level tuning are:

Communications I/O

Depending on the type of workload and the type of communications link, it might be necessary to tune one or more of the following communications device drivers: TCP/IP, or NFS.

Fixed Disk

The Logical Volume Manager (LVM) controls the placement of file systems and paging spaces on the disk, which can significantly affect the amount of seek latency the system experiences. The disk device drivers control the order in which I/O requests are acted upon.

Real Memory

The Virtual Memory Manager (VMM) controls the pool of free real-memory frames and determines when and from where to steal frames to replenish the pool.

Running Thread

The scheduler determines which dispatchable entity should next receive control. In AIX, the dispatchable entity is a thread. See Thread Support.

Chapter 2. Performance tuning

This topic is an introduction to performance tuning of the system and workload and contains the following sections:

- Introduction to the performance-tuning process
- Performance benchmarking

Introduction to the performance-tuning process

Performance tuning is primarily a matter of resource management and correct system-parameter setting. Tuning the workload and the system for efficient resource use consists of the following steps:

1. Identifying the workloads on the system
2. Setting objectives:
 - a. Determining how the results will be measured
 - b. Quantifying and prioritizing the objectives
3. Identifying the critical resources that limit the system's performance
4. Minimizing the workload's critical-resource requirements:
 - a. Using the most appropriate resource, if there is a choice
 - b. Reducing the critical-resource requirements of individual programs or system functions
 - c. Structuring for parallel resource use
5. Modifying the allocation of resources to reflect priorities
 - a. Changing the priority or resource limits of individual programs
 - b. Changing the settings of system resource-management parameters
6. Repeating steps 3 through 5 until objectives are met (or resources are saturated)
7. Applying additional resources, if necessary

There are appropriate tools for each phase of system performance management (see Appendix A. Monitoring and Tuning Commands and Subroutines). Some of the tools are available from IBM®; others are the products of third parties. The following figure illustrates the phases of performance management in a simple LAN environment.

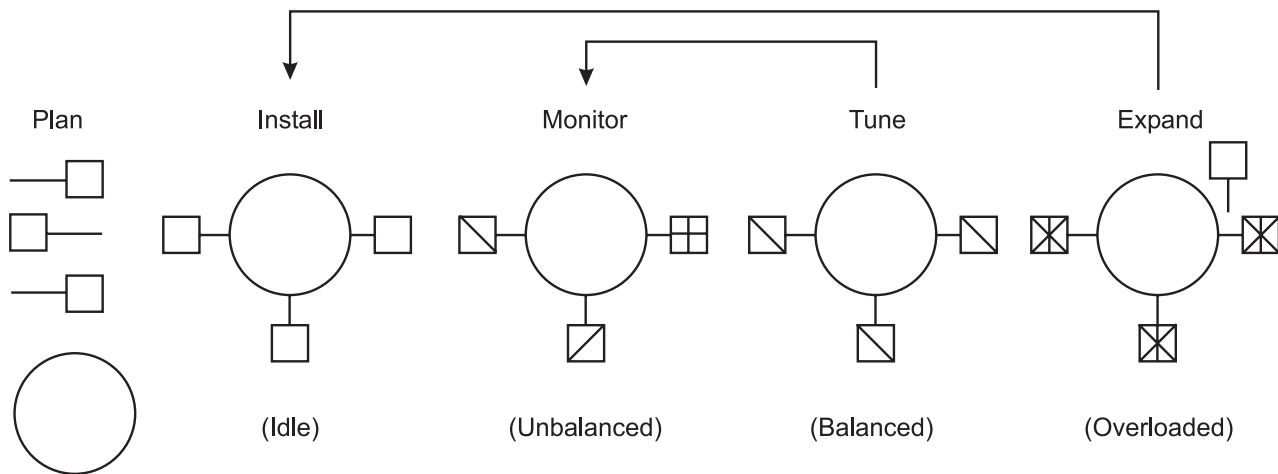

Figure 2. Performance Phases. The figure uses five weighted circles to illustrate the steps of performance tuning a system; plan, install, monitor, tune, and expand. Each circle represents the system in various states of performance; idle, unbalanced, balanced, and overloaded. Essentially, you expand a system that is overloaded, tune a system until it is balanced, monitor an unbalanced system and install for more resources when an expansion is necessary.

Identification of the workloads

It is essential that all of the work performed by the system be identified. Especially in LAN-connected systems, a complex set of cross-mounted file systems can easily develop with only informal agreement among the users of the systems. These file systems must be identified and taken into account as part of any tuning activity.

With multiuser workloads, the analyst must quantify both the typical and peak request rates. It is also important to be realistic about the proportion of the time that a user is actually interacting with the terminal.

An important element of this identification stage is determining whether the measurement and tuning activity has to be done on the production system or can be accomplished on another system (or off-shift) with a simulated version of the actual workload. The analyst must weigh the greater authenticity of results from a production environment against the flexibility of the nonproduction environment, where the analyst can perform experiments that risk performance degradation or worse.

Importance of setting objectives

Although you can set objectives in terms of measurable quantities, the actual desired result is often subjective, such as satisfactory response time. Further, the analyst must resist the temptation to tune what is measurable rather than what is important. If no system-provided measurement corresponds to the desired improvement, that measurement must be devised.

The most valuable aspect of quantifying the objectives is not selecting numbers to be achieved, but making a public decision about the relative importance of (usually) multiple objectives. Unless these priorities are set in advance, and understood by everyone concerned, the analyst cannot make trade-off decisions without incessant consultation. The analyst is also apt to be surprised by the reaction of users or management to aspects of performance that have been ignored. If the support and use of the system crosses organizational boundaries, you might need a written service-level agreement between the providers and the users to ensure that there is a clear common understanding of the performance objectives and priorities.

Identification of critical resources

In general, the performance of a given workload is determined by the availability and speed of one or two critical system resources. The analyst must identify those resources correctly or risk falling into an endless trial-and-error operation.

Systems have both real, logical, and possibly virtual resources. Critical real resources are generally easier to identify, because more system performance tools are available to assess the utilization of real resources. The real resources that most often affect performance are as follows:

- CPU cycles
- Memory
- I/O bus
- Various adapters
- Disk space
- Network access

Logical resources are less readily identified. Logical resources are generally programming abstractions that partition real resources. The partitioning is done to share and manage the real resource.

Starting with AIX 5.3, you can use virtual resources on POWER5-based pSeries systems, including Micro-Partitioning, virtual Serial Adapter, virtual SCSI and virtual Ethernet.

Some examples of real resources and the logical and virtual resources built on them are as follows:

CPU

- Processor time slice
- CPU entitlement or Micro-Partitioning
- Virtual Ethernet

Memory

- Page frames
- Stacks
- Buffers
- Queues
- Tables
- Locks and semaphores

Disk space

- Logical volumes
- File systems
- Files
- Logical partitions
- Virtual SCSI

Network access

- Sessions
- Packets
- Channels
- Shared Ethernet

It is important to be aware of logical and virtual resources as well as real resources. Threads can be blocked by a lack of logical resources just as for a lack of real resources, and expanding the underlying real resource does not necessarily ensure that additional logical resources will be created. For example, the NFS server daemon, or **nfsd** daemon on the server is required to handle each pending NFS remote I/O request. The number of **nfsd** daemons therefore limits the number of NFS I/O operations that can be in progress simultaneously. When a shortage of **nfsd** daemons exists, system instrumentation might indicate that various real resources, like the CPU, are used only slightly. You might have the false impression that your system is under-used and slow, when in fact you have a shortage of **nfsd** daemons which constrains the rest of the resources. A **nfsd** daemon uses processor cycles and memory, but you cannot fix this problem simply by adding real memory or upgrading to a faster CPU. The solution is to create more of the logical resource, the **nfsd** daemons.

Logical resources and bottlenecks can be created inadvertently during application development. A method of passing data or controlling a device may, in effect, create a logical resource. When such resources are created by accident, there are generally no tools to monitor their use and no interface to control their allocation. Their existence may not be appreciated until a specific performance problem highlights their importance.

Minimizing critical-resource requirements

Consider minimizing the workload's critical-resource requirements at three levels, as discussed below.

Using the appropriate resource

The decision to use one resource over another should be done consciously and with specific goals in mind. An example of a resource choice during application development would be a trade-off of increased memory consumption for reduced CPU consumption. A common system configuration decision that demonstrates resource choice is whether to place files locally on an individual workstation or remotely on a server.

Reducing the requirement for the critical resource

For locally developed applications, the programs can be reviewed for ways to perform the same function more efficiently or to remove unnecessary function. At a system-management level, low-priority workloads that are contending for the critical resource can be moved to other systems, run at other times, or controlled with the Workload Manager.

Structuring for parallel use of resources

Because workloads require multiple system resources to run, take advantage of the fact that the resources are separate and can be consumed in parallel. For example, the operating system read-ahead algorithm detects the fact that a program is accessing a file sequentially and schedules additional sequential reads to be done in parallel with the application's processing of the previous data. Parallelism applies to system management as well. For example, if an application accesses two or more files at the same time, adding an additional disk drive might improve the disk-I/O rate if the files that are accessed at the same time are placed on different drives.

Resource allocation priorities

The operating system provides a number of ways to prioritize activities. Some, such as disk pacing, are set at the system level. Others, such as process priority, can be set by individual users to reflect the importance they attach to a specific task.

Repeating the tuning steps

A truism of performance analysis is that there is always a next bottleneck. Reducing the use of one resource means that another resource limits throughput or response time. Suppose, for example, we have a system in which the utilization levels are as follows:

CPU: 90% Disk: 70% Memory 60%

This workload is CPU-bound. If we successfully tune the workload so that the CPU load is reduced from 90 to 45 percent, we might expect a two-fold improvement in performance. Unfortunately, the workload is now I/O-limited, with utilizations of approximately the following:

CPU: 45% Disk: 90% Memory 60%

The improved CPU utilization allows the programs to submit disk requests sooner, but then we hit the limit imposed by the disk drive's capacity. The performance improvement is perhaps 30 percent instead of the 100 percent we had envisioned.

There is always a new critical resource. The important question is whether we have met the performance objectives with the resources at hand.

Attention: Improper system tuning with the **vmo**, **ioo**, **schedo**, **no**, and **nfso** tuning commands might result in unexpected system behavior like degraded system or application performance, or a system hang. Changes should only be applied when a bottleneck has been identified by performance analysis.

Note: There is no such thing as a general recommendation for performance dependent tuning settings.

Applying additional resources

If, after all of the preceding approaches have been exhausted, the performance of the system still does not meet its objectives, the critical resource must be enhanced or expanded. If the critical resource is logical and the underlying real resource is adequate, the logical resource can be expanded at no additional cost. If the critical resource is real, the analyst must investigate some additional questions:

- How much must the critical resource be enhanced or expanded so that it ceases to be a bottleneck?
- Will the performance of the system then meet its objectives, or will another resource become saturated first?
- If there will be a succession of critical resources, is it more cost-effective to enhance or expand all of them, or to divide the current workload with another system?

Performance benchmarking

When we attempt to compare the performance of a given piece of software in different environments, we are subject to a number of possible errors, some technical, some conceptual. This section contains mostly cautionary information. Other sections of this book discuss the various ways in which elapsed and process-specific times can be measured.

When we measure the elapsed (wall-clock) time required to process a system call, we get a number that consists of the following:

- The actual time during which the instructions to perform the service were executing
- Varying amounts of time during which the processor was stalled while waiting for instructions or data from memory (that is, the cost of cache and TLB misses)
- The time required to access the clock at the beginning and end of the call
- Time consumed by periodic events, such as system timer interrupts
- Time consumed by more or less random events, such as I/O interrupts

To avoid reporting an inaccurate number, we normally measure the workload a number of times. Because all of the extraneous factors add to the actual processing time, the typical set of measurements has a curve of the form shown in the following illustration.

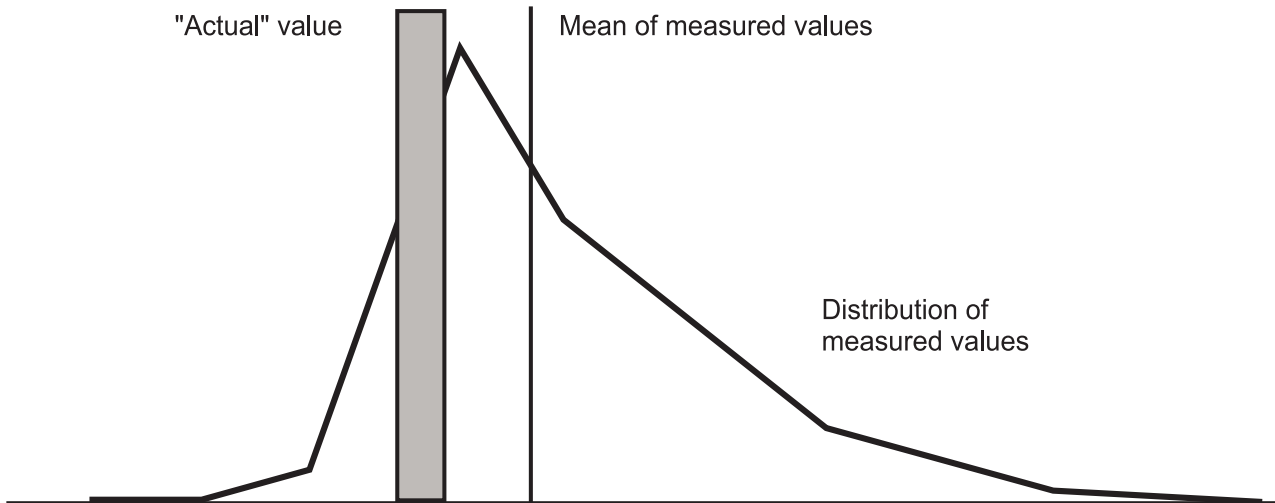

Figure 3. Curve for Typical Set of Measurement.

The extreme low end may represent a low-probability optimum caching situation or may be a rounding effect.

A regularly recurring extraneous event might give the curve a bimodal form (two maxima), as shown in the following illustration.

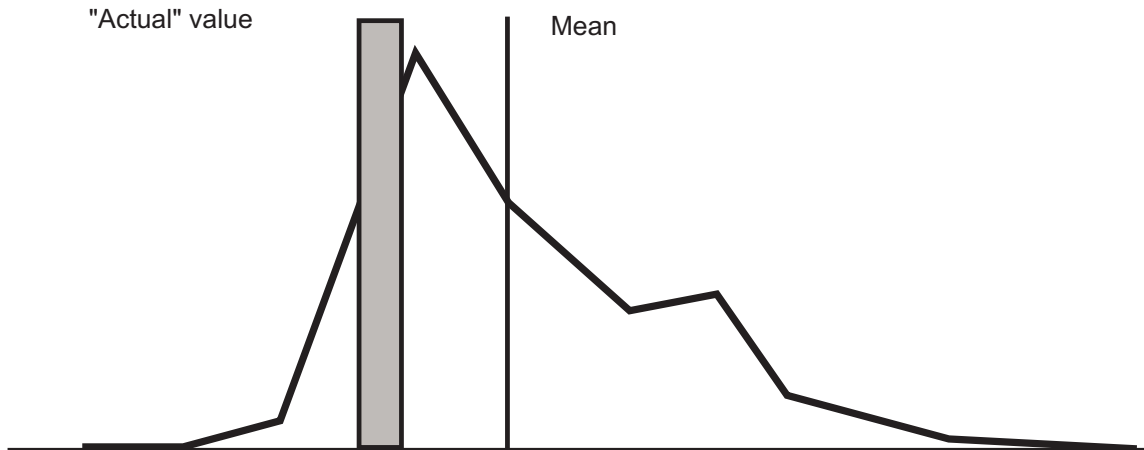

Figure 4. Bimodal Curve

One or two time-consuming interrupts might skew the curve even further, as shown in the following illustration:

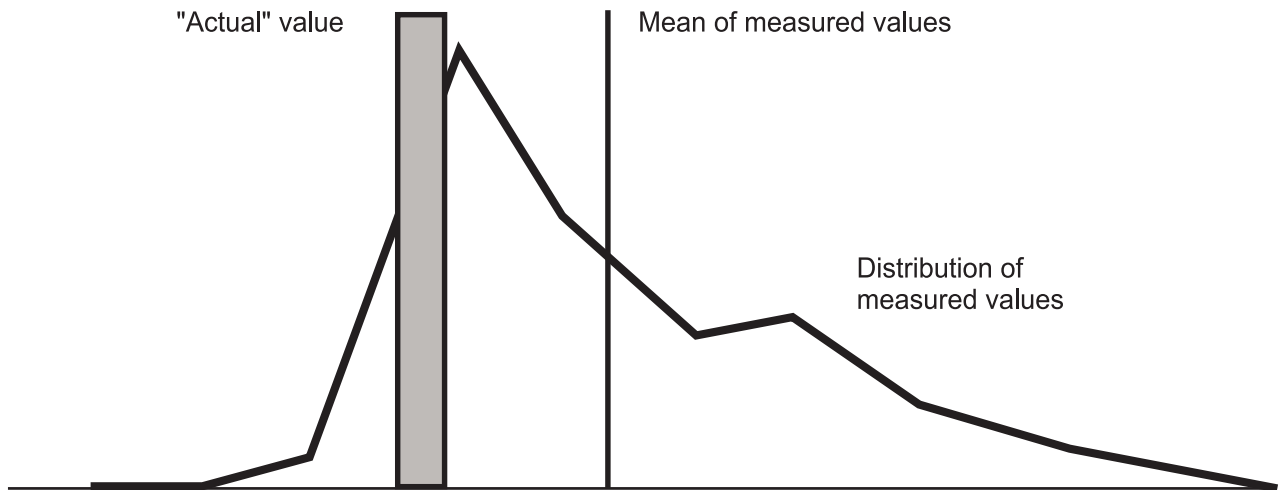

Figure 5. Skewed Curve

The distribution of the measurements about the actual value is not random, and the classic tests of inferential statistics can be applied only with great caution. Also, depending on the purpose of the measurement, it may be that neither the mean nor the actual value is an appropriate characterization of performance.

Chapter 3. Performance tuning enhancements for AIX 5.2

This section includes the following performance tuning changes introduced in AIX 5.2:

- AIX kernel tuning parameter modifications
- Replacements for the `vm tune` and `sched tune` commands
- Enhancements to the `no` and `nfso` commands
- AIX 5.2 compatibility mode
- AIX 5.2 system recovery procedures

AIX kernel tuning parameter modifications

AIX 5.2 introduces a more flexible and centralized mode for setting most of the AIX kernel tuning parameters. It is now possible to make permanent changes without editing any `rc` files. This is achieved by placing the reboot values for all tunable parameters in a new `/etc/tunables/nextboot` stanza file. When the machine is rebooted, the values in that file are automatically applied.

The `/etc/tunables/lastboot` stanza file is automatically generated with all the values that were set immediately after the reboot. This provides the ability to return to those values at any time. The `/etc/tunables/lastboot.log` log file records any changes made or that could not be made during reboot. There are sets of SMIT panels and a Web-based System Manager plug-in also available to manipulate current and reboot values for all tuning parameters, as well as the files in the `/etc/tunables` directory.

The following commands were introduced in AIX 5.2 to modify the tunables files:

| Command | Purpose |
|-------------------------|--|
| <code>tunsave</code> | Saves values to a stanza file |
| <code>tunchange</code> | Updates values in a stanza file |
| <code>tunrestore</code> | Applies applicable parameter values that are specified in a file |
| <code>tuncheck</code> | Validates files that are created manually |
| <code>tundefault</code> | Resets tunable parameters to their default values |

All of the above commands work on both current and reboot tunables parameters values. For more information, see their respective man pages.

For more information about any of these kernel tuning parameter modifications, see the Kernel Tuning section in *AIX 5L Version 5.3 Performance Tools Guide and Reference*.

Replacements for the `vm tune` and `sched tune` commands

The `vm tune` and `sched tune` commands are being replaced by the `vmo`, `ioo`, and `schedo` commands. Both the `vmo` and `ioo` commands together replace `vm tune`, while the `schedo` command replaces `sched tune`. All existing parameters are used by the new commands.

The `ioo` command manages all the I/O-related tuning parameters, while the `vmo` command manages all the other Virtual Memory Manager, or VMM, parameters previously managed by the `vm tune` command. All three commands are part of the `bos.perf.tune` fileset, which also contains the `tunsave`, `tunrestore`, `tuncheck`, and `tundefault` commands. The `bos.adt.samples` fileset in AIX 5.2 still includes the `vm tune` and `sched tune` commands, which are compatibility shell scripts calling the `vmo`, `ioo`, and `schedo` commands as appropriate. These compatibility scripts only support changes to parameters which can be changed interactively. Parameters that need `bosboot` and then require a reboot of the machine to be effective are no longer supported by the `vm tune` script. To change those parameters, users must now use

the **vmo -r** command. The **vmtune** command options and parameters in question are as follows:

| The previous vmtune option | Usage | New command |
|------------------------------|---|--|
| -C 011 | page coloring | vmo -r -o pagecoloring=011 |
| -g <i>n1</i> -L <i>n2</i> | large page size number of large pages to reserve | vmo -r -o lgpg_size=<i>n1</i> -o lgpg_regions=<i>n2</i> |
| -m <i>n</i> | memory pools | vmo -r -o mempools=<i>n</i> |
| -v <i>n</i> | number of frames per memory pool | vmo -r -o framesets=<i>n</i> |
| -i <i>n</i> | interval for special data segment identifiers | vmo -r -o spec_dataseg_int=<i>n</i> |
| -V <i>n</i> | number of special data segment identifiers to reserve | vmo -r -o num_spec_dataseg=<i>n</i> |
| -y 011 | p690 memory affinity | vmo -r -o memory_affinity=011 |

The **vmtune** and **schedtune** compatibility scripts do not ship with AIX 5.3. You can refer to the following tables to migrate your settings to the new commands:

| The schedtune option | The schedo equivalent | Function |
|----------------------|----------------------------------|--|
| -a number | -o affinity_lim=number | Sets the number of context switches after which the SCHED_FIFO2 policy no longer favors a thread. |
| -b number | -o idle_migration_barrier=number | Sets the idle migration barrier. |
| -c number | -o %usDelta=number | Controls the adjustment of the clock drift. |
| -d number | -o sched_D=number | Sets the factor used to decay CPU usage. |
| -e number | -o v_exempt_seconds=number | Sets the time before a recently suspended and resumed process is eligible for resuspension. |
| -f number | -o pacefork=number | Sets the number of clock ticks to delay before retrying a failed fork call. |
| -F number | -o fixed_pri_global=number | Keeps fixed priority threads in the global run queue. |
| -h number | -o v_repage_hi=number | Changes the system-wide criterion used to determine when process suspension begins and ends. |
| -m number | -o v_min_process=number | Sets the minimum multiprogramming level. |
| -p number | -o v_repage_proc=number | Changes the per process criterion used to determine which processes to suspend. |
| -r number | -o sched_R=number | Sets the rate at which to accumulate CPU usage. |
| -s number | -o maxspin=number | Sets the number of times to spin on a lock before sleeping. |
| -t number | -o timeslice=number | Sets the number of 10 ms time slices. |
| -w number | -o v_sec_wait=number | Sets the number of seconds to wait after thrashing ends before adding processes back into the mix. |

| The vmtune option | The vmo equivalent | The ioo equivalent | Function |
|-------------------|--------------------|--------------------|--|
| -b number | | -o numfsbuf=number | Sets the number of file system bufstructs. |

| | | | |
|-----------|-------------------------------|--|---|
| -B number | | -o hd_pbuf_cnt=number | Beginning with AIX 5.3, this parameter has been replaced with the pv_min_pbuf parameter. |
| -c number | | -o numclust=number | Sets the number of 16 KB clusters processed by write behind. |
| -C 0 1 | -r -o pagecoloring=0 1 | | Disables or enables page coloring for specific hardware platforms. |
| -d 0 1 | -o deffps=0 1 | | Turns deferred paging space allocation on and off. |
| -e 0 1 | | -o jfs_cread_enabled=0 1 | Controls whether JFS uses clustered reads on all files. |
| -E 0 1 | | -o jfs_use_read_lock=0 1 | Controls whether JFS uses a shared lock when reading from a file. |
| -f number | -o minfree=number | | Sets the number of frames on the free list. |
| -F number | -o maxfree=number | | Sets the number of frames on the free list at which to stop frame stealing. |
| -g number | -o lgpg_size number | | Sets the size, in bytes, of the hardware-supported large pages |
| -h 0 1 | -o strict_maxperm=0 1 | | Specifies whether maxperm% should be a hard limit. |
| -H number | | -o pgahd_scale_thresh=number | Sets the number of free pages in a mempool under which the system scales back read-ahead. |
| -i number | -r -o spec_dataseg_int=number | | Sets the interval to use when reserving the special data segment identifiers. |
| -j number | | -o j2_nPagesPerWriteBehindCluster=number | Sets the number of pages per write-behind cluster. |
| -J number | | -o j2_maxRandomWrite=number | Sets the random-write threshold count. |
| -k number | -o npskill=number | | Sets the number of paging space pages at which to begin killing processes. |
| -l number | -o lrubucket=number | | Sets the size of the least recently used page replacement bucket size. |
| -L number | -o lgpg_regions=number | | Sets the number of large pages to be reserved. |
| -m number | -r -o mempools=number | | Beginning with AIX 5.3, this parameter does not exist. |
| -M number | -o maxpin=number | | Sets the maximum percentage of real memory that can be pinned. |
| -n number | -o nokilluid=number | | Specifies the uid range of processes that should not be killed when paging space is low. |
| -N number | | -o pd_npages=number | Sets the number of pages that should be deleted in one chunk from RAM when a file is deleted. |

| | | | |
|-----------|---------------------------------|------------------------------------|---|
| -p number | -o minperm%=number | | Sets the point below which file pages are protected from the repage algorithm. |
| -P number | -o maxperm%=number | | Sets the point above which the page stealing algorithm steals only file pages. |
| -q number | | -o j2_minPageReadAhead=number | Sets the minimum number of pages to read ahead. |
| -Q number | | -o j2_maxPageReadAhead=number | Sets the maximum number of pages to read ahead. |
| -r number | | -o minpgahead=number | Sets the number of pages with which sequential read-ahead starts. |
| -R number | | -o maxpgahead=number | Sets the maximum number of pages to be read-ahead. |
| -s 0 1 | | -o sync_release_ilock=0 1 | Enables or disables the code that minimizes the time spent holding the inode lock during sync . |
| -S 0 1 | -o v_pinshm=0 1 | | Enables or disables the SHM_PIN flag on the shmget system call. |
| -t number | -o maxclient%=number | | Sets the point above which the page stealing algorithm steals only client file pages. |
| -T number | -o pta_balance_threshold=number | | Sets the point at which a new PTA segment is allocated. |
| -u number | -o lvm_bufcnt=number | | Sets the number of LVM buffers for raw physical I/Os. |
| -v number | -r -o framesets=number | | Sets the number of framesets per memory pool. |
| -V number | -r -o num_spec_dataseg=number | | Sets the number of special data segment identifiers to reserve |
| -w number | -o npswarn=number | | Sets the number of free paging space pages at which the SIGDANGER signal is sent to processes. |
| -W number | | -o maxrandwrt=number | Sets a threshold for random writes to accumulate in RAM before pages are synchronized to disk using a write-behind algorithm. |
| -y 0 1 | -r -o memory_affinity=0 1 | | Beginning with AIX 5.3, this parameter does not exist. Memory affinity is always on if the hardware supports it. |
| -z number | | -o j2_nRandomCluster=number | Sets random write threshold distance. |
| -Z number | | -o j2_nBufferPerPagerDevice=number | Sets the number of buffers per pager device. |

Enhancements to the no and nfsd commands

The **no** and **nfsd** commands have been enhanced so that you can make permanent changes to tunable parameters with the **/etc/tunables/nextboot** file. They both also have a new **-h** flag which can be used to display help about any parameter. The content of the help information includes:

- Purpose of the parameter

- Possible values such as default, range, and type
- Diagnostic and tuning information to decide when to change the parameter value

All of these new tuning commands, **ioo**, **nfso**, **no**, **vmo**, and **schedo**, use a common syntax. For more details and the complete list of tuning parameters supported, see the man pages for each command.

AIX 5.2 compatibility mode

When you migrate a system from a previous version of AIX to AIX 5.2, it is automatically set to run in compatibility mode, which means that the current behavior of the tuning commands is completely preserved, with the exception of the previously described **vm tune** parameters. When migrating to AIX 5.3, the compatibility mode only applies to the **no** and **nfso** commands because the **vm tune** and **sched tune** commands no longer exist. You can use the compatibility mode to migrate to the new tuning framework, but it is not recommended for use with AIX releases later than AIX 5.2.

Contrary to the normal AIX 5.2 tuning mode where permanent tunable parameter settings are set by applying values from the **/etc/tunables/nextboot** file, compatibility mode allows you to make permanent changes to tunable parameters by embedding calls to tuning commands in scripts called during the boot process. The only perceivable difference is that the **/etc/tunables/lastboot** and **/etc/tunables/lastboot.log** files are created during reboot. The **lastboot.log** file contains a warning that says that AIX is currently running in compatibility mode and that the **nextboot** file has not been applied.

Except for parameters of type *Bosboot* (see “Replacements for the **vm tune** and **sched tune** commands” on page 15), neither the new reboot and permanent options, the **-r** and **-p** flags respectively, of the tuning commands are meaningful because the content of the file is not applied at reboot time. The tuning commands are not controlling the reboot values of parameters like they would in non-compatibility mode. Parameters of type *Bosboot* are preserved during migration, stored in the **/etc/tunables/nextboot** file, and can be modified using the **-r** option, whether you are running in compatibility mode or not. Do not delete the **/etc/tunables/nextboot** file.

Compatibility mode is controlled by a new *sys0* attribute called **pre520tune**, which is automatically set to **enable** during a migration installation. In the case of a fresh installation of AIX 5.2, the attribute is set to **disable**. In the **disable** mode, embedded calls to tuning commands in scripts called during reboot are overwritten by the content of the **nextboot** file. The current setting of the **pre520tune** attribute can be viewed by running the following command:

```
# lsattr -E -l sys0
```

and changed either by using the following command:

```
# chdev -l sys0 -a pre520tune=disable
```

or using SMIT or Web-based System Manager.

When the compatibility mode is disabled, the following **no** command parameters, which are all of type *Reboot*, which means that they can only be changed during reboot, cannot be changed without using the **-r** flag:

- arptab_bsiz
- arptab_nb
- extendednetstats
- ifsize
- inet_stack_size
- ipqmaxlen
- nstrpush
- pseintrstack

Switching to non-compatibility mode while preserving the current reboot settings can be done by first changing the **pre520tune** attribute, and then by running the following command:

```
# tunrestore -r -f lastboot
```

This copies the content of the **lastboot** file to the **nextboot** file. For details about the new AIX 5.2 tuning mode, see the Kernel tuning section in the *AIX 5L Version 5.3 Performance Tools Guide and Reference*.

AIX 5.2 system recovery procedures

If a machine is unstable after rebooting and the **pre520tune** attribute is set to enable, delete the offending calls to tuning commands from scripts called during reboot. To detect the parameters that are set during reboot, look at the **/etc/tunables/lastboot** file and search for parameters not marked with # DEFAULT VALUE. For more information on the content of tunable files, see the tunables File Format section in *AIX 5L Version 5.3 Files Reference*.

Alternatively, to reset all of the tunable parameters to their default values, take the following steps:

1. Delete the **/etc/tunables/nextboot** file.
2. Set the **pre520tune** attribute to disable.
3. Run the **bosboot** command.
4. Reboot the machine.

Chapter 4. System performance monitoring

This topic includes information on tools and techniques for monitoring performance-related system activity in the following sections:

- Advantages of continuous system performance monitoring
- Continuous system-performance monitoring with the `vmstat`, `iostat`, `netstat`, and `sar` commands
- Continuous system-performance monitoring with the `topas` monitor
- Continuous system-performance monitoring with the Performance Toolbox

Advantages of continuous system performance monitoring

Continuous system performance monitoring can do the following:

- Sometimes detect underlying problems before they have an adverse effect
- Detect problems that affect a user's productivity
- Collect data when a problem occurs for the first time
- Allow you to establish a baseline for comparison

Successful monitoring involves the following:

- Periodically obtaining performance-related information from the operating system
- Storing the information for future use in problem diagnosis
- Displaying the information for the benefit of the system administrator
- Detecting situations that require additional data collection or responding to directions from the system administrator to collect such data, or both
- Collecting and storing the necessary detail data
- Tracking changes made to the system and applications

Continuous system-performance monitoring with the `vmstat`, `iostat`, `netstat`, and `sar` commands

The `vmstat`, `iostat`, `netstat`, and `sar` commands provide the basic foundation upon which you can construct a performance-monitoring mechanism.

You can write shell scripts to perform data reduction on the command output, warn of performance problems, or record data on the status of a system when a problem is occurring. For example, a shell script can test the CPU idle percentage for zero, a saturated condition, and execute another shell script for when the CPU-saturated condition occurred. The following script records the 15 active processes that consumed the most CPU time other than the processes owned by the user of the script:

```
# ps -ef | egrep -v "STIME|$LOGNAME" | sort +3 -r | head -n 15
```

Continuous performance monitoring with the `vmstat` command

The `vmstat` command is useful for obtaining an overall picture of CPU, paging, and memory usage. The following is a sample report produced by the `vmstat` command:

```
# vmstat 5 2
kthr      memory          page          faults          cpu
-----
 r  b   avm    fre re  pi  po  fr   sr  cy  in  sy  cs us  sy id wa
 1  1 197167 477552   0   0   0   7   21   0 106 1114 451   0   0 99   0
 0  0 197178 477541   0   0   0   0   0   0 443 1123 442   0   0 99   0
```

Remember that the first report from the `vmstat` command displays cumulative activity since the last system boot. The second report shows activity for the first 5-second interval.

For detailed discussions of the **vmstat** command, see The **vmstat** Command (CPU), The **vmstat** Command (Memory), and Assessing Disk Performance with the **vmstat** Command.

Continuous performance monitoring with the **iostat** command

The **iostat** command is useful for determining disk and CPU usage. The following is a sample report produced by the **iostat** command:

```
# iostat 5 2

tty:      tin          tout  avg-cpu: % user   % sys    % idle  % iowait
          0.1          102.3  0.5     0.2     99.3    0.1
          " Disk history since boot not available. "

tty:      tin          tout  avg-cpu: % user   % sys    % idle  % iowait
          0.2          79594.4  0.6     6.6     73.7    19.2

Disks:    % tm_act    Kbps    tps    Kb_read  Kb_wrtn
hdisk1    0.0          0.0     0.0     0        0
hdisk0    78.2         1129.6  282.4    5648     0
cd1       0.0          0.0     0.0     0        0
```

Remember that the first report from the **iostat** command shows cumulative activity since the last system boot. The second report shows activity for the first 5-second interval.

The system maintains a history of disk activity. In the example above, you can see that the history is disabled by the appearance of the following message:

```
Disk history since boot not available.
```

To disable or enable disk I/O history with **smitty**, type the following at the command line:

```
# smitty chgsys
```

```
Continuously maintain DISK I/O history [value]
```

and set the *value* to either *false* to disable disk I/O history or *true* to enable disk I/O history. The interval disk I/O statistics are unaffected by this setting.

For detailed discussion of the **iostat** command, see The **iostat** Command and Assessing Disk Performance with the **iostat** Command.

Continuous performance monitoring with the **netstat** command

The **netstat** command is useful in determining the number of sent and received packets. The following is a sample report produced by the **netstat** command:

```
# netstat -I en0 5
   input      (en0)      output      input      (Total)      output
 packets  errs  packets  errs  colls  packets  errs  packets  errs  colls
8305067   0  7784711   0    0  20731867   0  20211853   0    0
      3    0      1    0    0      7    0      5    0    0
      24   0     127   0    0     28    0     131   0    0
CTRL C
```

Remember that the first report from the **netstat** command shows cumulative activity since the last system boot. The second report shows activity for the first 5-second interval.

Other useful **netstat** command options are **-s** and **-v**. For details, see The **netstat** Command.

Continuous performance monitoring with the sar command

The **sar** command is useful in determining CPU usage. The following is a sample report produced by the **sar** command:

```
# sar -P ALL 5 2
```

```
AIX aixhost 2 5 00040B0F4C00    01/29/04

10:23:15 cpu      %usr    %sys    %wio    %idle
10:23:20  0         0        0        1       99
          1         0        0        0       100
          2         0        1        0        99
          3         0        0        0       100
          -         0        0        0        99
10:23:25  0         4        0        0       96
          1         0        0        0       100
          2         0        0        0       100
          3         3        0        0        97
          -         2        0        0        98

Average  0         2        0        0       98
          1         0        0        0       100
          2         0        0        0       99
          3         1        0        0        99
          -         1        0        0        99
```

The **sar** command does not report the cumulative activity since the last system boot.

For details on the **sar** command, see *The sar Command and Assessing Disk Performance with the sar Command*.

Continuous system-performance monitoring with the topas monitor

The **topas** program reports vital statistics about the activity on the local system on a character terminal. The **bos.perf.tools** fileset must be installed on the system to run the **topas** program.

The **topas** program extracts and displays statistics from the system with a default interval of 2 seconds. The **topas** program offers the following alternate screens:

- Overall system statistics
- List of busiest processes
- WLM statistics

For more information on the **topas** program, please refer to *The topas Command in AIX 5L Version 5.3 Commands Reference, Volume 5*.

Overall system statistics screen of the topas monitor

The output of the overall system statistics screen consists of one fixed section and one variable section. The top two lines at the left of the output shows the name of the system that the **topas** program is running on, the date and time of the last observation, and the monitoring interval. Below this section is a variable section which lists the following subsections:

- CPU utilization
- Network interfaces
- Physical disks
- WLM classes
- Processes

To the right of this section is the fixed section which contains the following subsections of statistics:

- EVENTS/QUEUES
- FILE/TTY
- PAGING
- MEMORY
- PAGING SPACE
- NFS

The following is a sample output of the overall system statistics screen:

```

Topas Monitor for host:   aixhost           EVENTS/QUEUES   FILE/TTY
Wed Feb  4 11:23:41 2004 Interval:  2         Cswitch        53 Readch        6323
                                           Syscall        152 Writech       431
Kernel   0.0 |                               Reads          3 Rawin         0
User     0.9 |                               Writes         0 Ttyout        0
Wait     0.0 |                               Forks          0 Igets         0
Idle     99.0 | #####                               Execs          0 Namei         10
                                           Runqueue       0.0 Dirblk        0
                                           Waitqueue      0.0

Network  KBPS   I-Pack  O-Pack  KB-In  KB-Out
en0      0.8     0.4    0.9    0.0    0.8
lo0      0.0     0.0    0.0    0.0    0.0
Disk     Busy%   KBPS    TPS  KB-Read  KB-Writ
hdisk0   0.0    0.0    0.0   0.0    0.0
hdisk1   0.0    0.0    0.0   0.0    0.0
WLM-Class (Active)  CPU%   Mem%   Disk-I/O%
System              0      0      0
Shared              0      0      0
Default             0      0      0
Name                PID CPU% PgSp Class
topas                10442 3.0 0.8 System
ksh                  13438 0.0 0.4 System
gil                  1548 0.0 0.0 System
PAGING              MEMORY
Faults              2 Real,MB          4095
Steals              0 % Comp           8.0
PgspIn              0 % Noncomp       15.8
PgspOut              0 % Client        14.7
PageIn              0
PageOut             0 PAGING SPACE
Sios                 0 Size,MB          512
                    % Used           1.2
NFS (calls/sec)    % Free           98.7
ServerV2            0
ClientV2             0 Press:
ServerV3             0 "h" for help
ClientV3             0 "q" to quit

```

Except for the variable Processes subsection, you can sort all of the subsections by any column by moving the cursor to the top of the desired column. All of the variable subsections, except the Processes subsection, have the following views:

- List of top resource users
- One-line report presenting the sum of the activity

For example, the one-line-report view might show just the total disk or network throughput.

For the CPU subsection, you can select either the list of busy processors or the global CPU utilization, as shown in the above example.

List of busiest processes screen of the topas monitor

To view the screen that lists the busiest processes, use the **-P** flag of the **topas** command. This screen is similar to the Processes subsection of the overall system statistics screen, but with additional detail. You can sort this screen by any of the columns by moving the cursor to the top of the desired column. The following is an example of the output of the busiest processes screen:

```

Topas Monitor for host:   aixhost           Interval:  2   Wed Feb  4 11:24:05 2004

USER      PID    PPID  PRI  NI   DATA  TEXT  PAGE  TIME CPU%  PGFAULTS
root      1       0    60  20   202    9    202   0:04 0.0    111 1277  init
root     774     0    17  41    4     0     4    0:00 0.0     0   2  reaper
root    1032    0    60  41    4     0     4    0:00 0.0     0   2  xmgc
root    1290    0    36  41    4     0     4    0:01 0.0     0  530  netm
root    1548    0    37  41   17    0    17   1:24 0.0     0   23  gil
root    1806    0    16  41    4     0     4    0:00 0.0     0   12  wlmsched

```

| | | | | | | | | | | | | |
|------|------|------|----|----|-----|----|-----|------|-----|------|------|-----------|
| root | 2494 | 0 | 60 | 20 | 4 | 0 | 4 | 0:00 | 0.0 | 0 | 6 | rtcmd |
| root | 2676 | 1 | 60 | 20 | 91 | 10 | 91 | 0:00 | 0.0 | 20 | 6946 | cron |
| root | 2940 | 1 | 60 | 20 | 171 | 22 | 171 | 0:00 | 0.0 | 15 | 129 | errdemon |
| root | 3186 | 0 | 60 | 20 | 4 | 0 | 4 | 0:00 | 0.0 | 0 | 125 | kbiod |
| root | 3406 | 1 | 60 | 20 | 139 | 2 | 139 | 1:23 | 0.0 | 1542 | 187 | syncd |
| root | 3886 | 0 | 50 | 41 | 4 | 0 | 4 | 0:00 | 0.0 | 0 | 2 | jfsz |
| root | 4404 | 0 | 60 | 20 | 4 | 0 | 4 | 0:00 | 0.0 | 0 | 2 | lvmbb |
| root | 4648 | 1 | 60 | 20 | 17 | 1 | 17 | 0:00 | 0.0 | 1 | 24 | sa_daemon |
| root | 4980 | 1 | 60 | 20 | 97 | 13 | 97 | 0:00 | 0.0 | 37 | 375 | srcmstr |
| root | 5440 | 1 | 60 | 20 | 15 | 2 | 15 | 0:00 | 0.0 | 7 | 28 | shlap |
| root | 5762 | 1 | 60 | 20 | 4 | 0 | 4 | 0:00 | 0.0 | 0 | 2 | random |
| root | 5962 | 4980 | 60 | 20 | 73 | 10 | 73 | 0:00 | 0.0 | 22 | 242 | syslogd |
| root | 6374 | 4980 | 60 | 20 | 63 | 2 | 63 | 0:00 | 0.0 | 2 | 188 | rpc.lockd |
| root | 6458 | 4980 | 60 | 20 | 117 | 12 | 117 | 0:00 | 0.0 | 54 | 287 | portmap |

WLM statistics screen of the topas monitor

To view the screen that shows the WLM statistics, use the **-W** flag of the **topas** command. This screen is divided into the following sections:

- The top section is the list of busiest WLM classes, as presented in the WLM subsection of the overall system statistics screen, which you can also sort by any of the columns.
- The second section of this screen is a list of hot processes within the WLM class you select by using the arrow keys or the *f* key.

The following is an example of the WLM full screen report:

| | | | | | |
|-------------------------|---------|-----------|-----------|---------|-----------------|
| Topas Monitor for host: | aixhost | Interval: | 2 | Wed Feb | 4 11:24:29 2004 |
| WLM-Class (Active) | CPU% | Mem% | Disk-I/O% | | |
| System | 0 | 0 | 0 | | |
| Shared | 0 | 0 | 0 | | |
| Default | 0 | 0 | 0 | | |
| Unmanaged | 0 | 0 | 0 | | |
| Unclassified | 0 | 0 | 0 | | |

```
=====
```

| USER | PID | PPID | PRI | NI | DATA RES | TEXT RES | PAGE SPACE | TIME | CPU% | I/O | OTH | COMMAND |
|------|------|------|-----|----|----------|----------|------------|------|------|-----|-----|----------|
| root | 1 | 0 | 60 | 20 | 202 | 9 | 202 | 0:04 | 0.0 | 0 | 0 | init |
| root | 774 | 0 | 17 | 41 | 4 | 0 | 4 | 0:00 | 0.0 | 0 | 0 | reaper |
| root | 1032 | 0 | 60 | 41 | 4 | 0 | 4 | 0:00 | 0.0 | 0 | 0 | xmgc |
| root | 1290 | 0 | 36 | 41 | 4 | 0 | 4 | 0:01 | 0.0 | 0 | 0 | netm |
| root | 1548 | 0 | 37 | 41 | 17 | 0 | 17 | 1:24 | 0.0 | 0 | 0 | gil |
| root | 1806 | 0 | 16 | 41 | 4 | 0 | 4 | 0:00 | 0.0 | 0 | 0 | wlmsched |
| root | 2494 | 0 | 60 | 20 | 4 | 0 | 4 | 0:00 | 0.0 | 0 | 0 | rtcmd |
| root | 2676 | 1 | 60 | 20 | 91 | 10 | 91 | 0:00 | 0.0 | 0 | 0 | cron |
| root | 2940 | 1 | 60 | 20 | 171 | 22 | 171 | 0:00 | 0.0 | 0 | 0 | errdemon |
| root | 3186 | 0 | 60 | 20 | 4 | 0 | 4 | 0:00 | 0.0 | 0 | 0 | kbiod |

Continuous system-performance monitoring with the Performance Toolbox

The Performance Toolbox (PTX[®]) is a licensed product that graphically displays a variety of performance-related metrics. One of the prime advantages of PTX is that you can check current system performance by taking a glance at the graphical display rather than looking at a screen full of numbers. PTX also facilitates the compilation of information from multiple performance-related commands and allows the recording and playback of data.

PTX contains tools for local and remote system-activity monitoring and tuning. The PTX tools that are best suited for continuous monitoring are the following:

- The **ptxrlog** command produces recordings in ASCII format, which allows you to either print the output or post-process it. You can also use the **ptxrlog** command to produce a recording file in binary that can be viewed with the **azizo** or **xmperf** commands.
- The **xmservd** daemon acts as a recording facility and is controlled through the **xmservd.cf** configuration file. This daemon simultaneously provides near real-time network-based data monitoring and local recording on a given node.
- The **xmtrend** daemon, much like the **xmservd** daemon, acts as a recording facility. The main difference between the **xmtrend** daemon and the **xmservd** daemon is in the storage requirements for each daemon. Typically, the **xmservd** daemon recordings can consume several megabytes of disk storage every hour. The **xmtrend** daemon provides manageable and perpetual recordings of large metric sets.
- The **jazizo** tool is a Java™ version of the **azizo** command. The **jazizo** command is a tool for analyzing the long-term performance characteristics of a system. It analyzes recordings created by the **xmtrend** daemon and provides displays of the recorded data that can be customized.
- The **wlmparf** tools provide graphical views of Workload Manager (WLM) resource activities by class. This tool can generate reports from trend recordings made by the PTX daemons covering a period of minutes, hours, days, weeks, or months.

For more information about PTX, see *Performance Toolbox Version 2 and 3 for AIX: Guide and Reference* and *Customizing Performance Toolbox and Performance Toolbox Extensions for AIX*.

Chapter 5. Initial performance diagnosis

This topic includes information on diagnosing performance problems. The major sections are:

- Types of reported performance problems
- Performance-limiting resource identification
- Workload Management Diagnosis

Types of reported performance problems

When a performance problem is reported, it is helpful to determine the kind of performance problem by narrowing the list of possibilities. The following is a list of the types of potential performance problems:

- A particular program runs slowly
- Everything runs slowly at a particular time of day
- Everything runs slowly at unpredictable times
- Everything that an individual user runs is slow
- A number of LAN-connected systems slow down simultaneously
- Everything on a particular service or device slows down at times
- Everything runs slowly when connected remotely

We discuss each of these issues in more detail in the following sections.

A particular program runs slowly

Although this situation might seem trivial, there are still questions to answer:

- Has the program always run slowly?

If the program has just started running slowly, a recent change might be the cause.

- Has the source code changed or a new version installed?

If so, check with the programmer or vendor.

- Has something in the environment changed?

If a file used by the program, including its own executable program, has been moved, it may now be experiencing network delays that did not exist previously. Or, files may be contending for a single-disk accessor that were on different disks previously.

If the system administrator changed system-tuning parameters, the program may be subject to constraints that it did not experience previously. For example, if the system administrator changed the way priorities are calculated, programs that used to run rather quickly in the background may now be slowed down, while foreground programs have sped up.

- Is the program written in the **perl**, **awk**, **csh**, or some other interpretive language?

Unfortunately, interpretive languages are not optimized by a compiler. Also, it is easy in a language like **perl** or **awk** to request an extremely compute- or I/O-intensive operation with a few characters. It is often worthwhile to perform a desk check or informal peer review of such programs with the emphasis on the number of iterations implied by each operation.

- Does the program always run at the same speed or is it sometimes faster?

The file system uses some of system memory to hold pages of files for future reference. If a disk-limited program is run twice in quick succession, it will normally run faster the second time than the first. Similar behavior might be observed with programs that use NFS. This can also occur with large programs, such as compilers. The program's algorithm might not be disk-limited, but the time needed to load a large executable program might make the first execution of the program much longer than subsequent ones.

- If the program has always run slowly, or has slowed down without any obvious change in its environment, look at its dependency on resources.

Performance-limiting resource identification describes techniques for finding the bottleneck.

Everything runs slowly at a particular time of day

Most people have experienced the rush-hour slowdown that occurs because a large number of people in the organization habitually use the system at one or more particular times each day. This phenomenon is not always simply due to a concentration of load. Sometimes it is an indication of an imbalance that is only a problem when the load is high. Other sources of recurring situations in the system should be considered.

- If you run the **iostat** and **netstat** commands for a period that spans the time of the slowdown, or if you have previously captured data from your monitoring mechanism, are some disks much more heavily used than others? Is the CPU idle percentage consistently near zero? Is the number of packets sent or received unusually high?
 - If the disks are unbalanced, see Monitoring and Tuning Disk I/O Use.
 - If the CPU is saturated, use the **ps** or **topas** commands to identify the programs being run during this period. The sample script given in Continuous system-performance monitoring with the **vmstat**, **iostat**, **netstat**, and **sar** commands simplifies the search for the heaviest CPU users.
 - If the slowdown is counter-intuitive, such as paralysis during lunch time, look for a pathological program such as a graphic **xlock** or game program. Some versions of the **xlock** program are known to use huge amounts of CPU time to display graphic patterns on an idle display. It is also possible that someone is running a program that is a known CPU burner and is trying to run it at the least intrusive time.
- Unless your **/var/adm/cron/cron.allow** file is null, you may want to check the contents of the **/var/adm/cron/crontab** directory for expensive operations.

If you find that the problem stems from conflict between foreground activity and long-running, CPU-intensive programs that are, or should be, run in the background, consider changing the way priorities are calculated using the **schedo** command to give the foreground higher priority. See Tuning the Thread-Priority-Value Calculation.

Everything runs slowly at unpredictable times

The best tool for this situation is an overload detector, such as the **filtd** daemon, a component of PTX. The **filtd** daemon can be set up to execute shell scripts or collect specific information when a particular condition is detected. You can construct a similar, but more specialized, mechanism using shell scripts containing the **vmstat**, **iostat**, **netstat**, **sar**, and **ps** commands.

If the problem is local to a single system in a distributed environment, there is probably a pathological program at work, or perhaps two that intersect randomly.

Everything that an individual user runs is slow

Sometimes a system seems to affect a particular individual.

- The solution in this case is to quantify the problem. Ask the user which commands they use frequently, and run those commands with the **time** command, as in the following example:

```
# time cp .profile testjunk
real    0m0.08s
user    0m0.00s
sys     0m0.01s
```

Then run the same commands under a user ID that is not experiencing performance problems. Is there a difference in the reported **real** time?

- A program should not show much CPU time (**user+sys**) difference from run to run, but may show a real time difference because of more or slower I/O. Are the user's files on an NFS-mounted directory? Or on a disk that has high activity for other reasons?
- Check the user's **.profile** file for unusual **\$PATH** specifications. For example, if you always search a few NFS-mounted directories before searching **/usr/bin**, everything will take longer.

A number of LAN-connected systems slow down simultaneously

There are some common problems that arise in the transition from independent systems to distributed systems. The problems usually result from the need to get a new configuration running as soon as possible, or from a lack of awareness of the cost of certain functions. In addition to tuning the LAN configuration in terms of maximum transmission units (MTU) and mbufs (see Monitoring and Tuning Network Performance), look for LAN-specific pathologies or nonoptimal situations that may have evolved through a sequence of individually reasonable decisions.

- Use network statistics to ensure that there are no physical network problems. Ensure that commands such as **netstat -v**, **entstat**, **tokstat**, **atmstat**, or **fdlistat** do not show excessive errors or collision on the adapter.
- Some types of software or firmware bugs can sporadically saturate the LAN with broadcast or other packets.

When a broadcast storm occurs, even systems that are not actively using the network can be slowed by the incessant interrupts and by the CPU resource consumed in receiving and processing the packets. These problems are better detected and localized with LAN analysis devices than with the normal performance tools.

- Do you have two LANs connected through a system?

Using a system as a router consumes large amounts of CPU time to process and copy packets. It is also subject to interference from other work being processed by the system. Dedicated hardware routers and bridges are usually a more cost-effective and robust solution.

- Is there a clear purpose for each NFS mount?

At some stages in the development of distributed configurations, NFS mounts are used to give users on new systems access to their home directories on their original systems. This situation simplifies the initial transition, but imposes a continuing data communication cost. It is not unknown to have users on system A interacting primarily with data on system B and vice versa.

Access to files through NFS imposes a considerable cost in LAN traffic, client and server CPU time, and end-user response time. A general guideline is that user and data should normally be on the same system. The exceptions are those situations in which an overriding concern justifies the extra expense and time of remote data. Some examples are a need to centralize data for more reliable backup and control, or a need to ensure that all users are working with the most current version of a program.

If these and other needs dictate a significant level of NFS client-server interchange, it is better to dedicate a system to the role of server than to have a number of systems that are part-server, part-client.

- Have programs been ported correctly and justifiably to use remote procedure calls (RPCs)?

The simplest method of porting a program into a distributed environment is to replace program calls with RPCs on a 1:1 basis. Unfortunately, the disparity in performance between local program calls and RPCs is even greater than the disparity between local disk I/O and NFS I/O. Assuming that the RPCs are really necessary, they should be batched whenever possible.

Everything on a particular service or device slows down at times

If everything that uses a particular device or service slows down at times, refer to the topic that covers that particular device or service:

- Monitoring and Tuning CPU Performance
- Monitoring and Tuning Memory Performance
- Monitoring and Tuning Physical and Logical Volume Performance
- Monitoring and Tuning File System Performance
- Monitoring and Tuning Network Performance
- Monitoring and Tuning NFS Performance

Everything runs slowly when connected remotely

Local and remote authentication to a system can behave very differently. By default, the local authentication files are consulted first when a user logs in with their user id. This has a faster response time than network-based authentication mechanisms.

If a user logs in and authenticates with some kind of network-authentication mechanism, that will be the first mechanism searched when looking up user ids. This will affect any command that performs lookups of user login names. It will also impact the following commands:

- **ps -ef**
- **ls -l**
- **ipcs -a**

The specific authentication programs are defined in the `/usr/lib/security/methods.cfg` file. The default value is `compat`, which is the local authentication method. To view your current authentication setting for a particular user id, login with the user id and at the command line, type:

```
# echo $AUTHSTATE
```

If you want to ensure that you are using a local authentication mechanism first and then the network-based authentication mechanism, like DCE for example, type the following at the command line:

```
# export AUTHSTATE="compat,DCE"
```

Performance-Limiting Resource identification

The best tool for an overall look at resource utilization while running a multiuser workload is the **vmstat** command. The **vmstat** command reports CPU and disk-I/O activity, as well as memory utilization data. The following instantiation of the **vmstat** command produces a one-line summary report of system activity every 5 seconds:

```
# vmstat 5
```

In the example above, because there is no count specified following the interval, reporting continues until you cancel the command.

The following **vmstat** report was created on a system running AIXwindows and several synthetic applications (some low-activity intervals have been removed for example purposes):

| kthr | | memory | | | | page | | | | faults | | | | cpu | | | |
|------|---|--------|------|----|----|------|-----|------|----|--------|-----|-----|----|-----|----|----|--|
| r | b | avm | fre | re | pi | po | fr | sr | cy | in | sy | cs | us | sy | id | wa | |
| 0 | 0 | 8793 | 81 | 0 | 0 | 0 | 1 | 7 | 0 | 125 | 42 | 30 | 1 | 2 | 95 | 2 | |
| 0 | 0 | 8793 | 80 | 0 | 0 | 0 | 0 | 0 | 0 | 155 | 113 | 79 | 14 | 8 | 78 | 0 | |
| 0 | 0 | 8793 | 57 | 0 | 3 | 0 | 0 | 0 | 0 | 178 | 28 | 69 | 1 | 12 | 81 | 6 | |
| 0 | 0 | 9192 | 66 | 0 | 0 | 16 | 81 | 167 | 0 | 151 | 32 | 34 | 1 | 6 | 77 | 16 | |
| 0 | 0 | 9193 | 65 | 0 | 0 | 0 | 0 | 0 | 0 | 117 | 29 | 26 | 1 | 3 | 96 | 0 | |
| 0 | 0 | 9193 | 65 | 0 | 0 | 0 | 0 | 0 | 0 | 120 | 30 | 31 | 1 | 3 | 95 | 0 | |
| 0 | 0 | 9693 | 69 | 0 | 0 | 53 | 100 | 216 | 0 | 168 | 27 | 57 | 1 | 4 | 63 | 33 | |
| 0 | 0 | 9693 | 69 | 0 | 0 | 0 | 0 | 0 | 0 | 134 | 96 | 60 | 12 | 4 | 84 | 0 | |
| 0 | 0 | 10193 | 57 | 0 | 0 | 0 | 0 | 0 | 0 | 124 | 29 | 32 | 1 | 3 | 94 | 2 | |
| 0 | 0 | 11194 | 64 | 0 | 0 | 38 | 201 | 1080 | 0 | 168 | 29 | 57 | 2 | 8 | 62 | 29 | |
| 0 | 0 | 11194 | 63 | 0 | 0 | 0 | 0 | 0 | 0 | 141 | 111 | 65 | 12 | 7 | 81 | 0 | |
| 0 | 0 | 5480 | 755 | 3 | 1 | 0 | 0 | 0 | 0 | 154 | 107 | 71 | 13 | 8 | 78 | 2 | |
| 0 | 0 | 5467 | 5747 | 0 | 3 | 0 | 0 | 0 | 0 | 167 | 39 | 68 | 1 | 16 | 79 | 5 | |
| 0 | 1 | 4797 | 5821 | 0 | 21 | 0 | 0 | 0 | 0 | 191 | 192 | 125 | 20 | 5 | 42 | 33 | |
| 0 | 1 | 3778 | 6119 | 0 | 24 | 0 | 0 | 0 | 0 | 188 | 170 | 98 | 5 | 8 | 41 | 46 | |
| 0 | 0 | 3751 | 6139 | 0 | 0 | 0 | 0 | 0 | 0 | 145 | 24 | 54 | 1 | 10 | 89 | 0 | |

In this initial assessment, pay particular attention to the `pi` and `po` columns of the page category and the four columns in the `cpu` category.

The `pi` and `po` entries represent the paging-space page-ins and page-outs, respectively. If you observe any instances of paging-space I/O, the workload may be approaching or beyond the system's memory limits.

If the sum of the user and system CPU-utilization percentages, `us` and `sy`, is greater than 90 percent in a given 5-second interval, the workload is approaching the CPU limits of the system during that interval.

If the I/O wait percentage, `wa`, is close to zero and the `pi` and `po` values are zero, the system is spending time waiting on nonoverlapped file I/O, and some part of the workload is I/O-limited.

If the **vmstat** command indicates a significant amount of I/O wait time, use the **iostat** command to gather more detailed information.

The following instantiation of the **iostat** command produces summary reports of I/O activity and CPU utilization every 5 seconds, and because we specify a count of 3 following the interval, reporting will stop after the third report:

```
# iostat 5 3
```

The following **iostat** report was created on a system running the same workload as the one in the **vmstat** example above, but at a different time. The first report represents the cumulative activity since the preceding boot, while subsequent reports represent the activity during the preceding 5-second interval:

```
tty:      tin          tout    avg-cpu:  % user   % sys    % idle   %iowait
          0.0          4.3          0.2     0.6     98.8     0.4
```

```
Disks:    % tm_act    Kbps     tps     Kb_read  Kb_wrtn
hdisk0    0.0         0.2      0.0     7993     4408
hdisk1    0.0         0.0      0.0     2179     1692
hdisk2    0.4         1.5      0.3     67548    59151
cd0       0.0         0.0      0.0      0         0
```

```
tty:      tin          tout    avg-cpu:  % user   % sys    % idle   %iowait
          0.0          30.3         8.8     7.2     83.9     0.2
```

```
Disks:    % tm_act    Kbps     tps     Kb_read  Kb_wrtn
hdisk0    0.2         0.8      0.2      4         0
hdisk1    0.0         0.0      0.0      0         0
hdisk2    0.0         0.0      0.0      0         0
cd0       0.0         0.0      0.0      0         0
```

```
tty:      tin          tout    avg-cpu:  % user   % sys    % idle   %iowait
          0.0          8.4          0.2     5.8     0.0     93.8
```

```
Disks:    % tm_act    Kbps     tps     Kb_read  Kb_wrtn
hdisk0    0.0         0.0      0.0      0         0
hdisk1    0.0         0.0      0.0      0         0
hdisk2    98.4        575.6    61.9     396      2488
cd0       0.0         0.0      0.0      0         0
```

The first report shows that the I/O on this system is unbalanced. Most of the I/O (86.9 percent of kilobytes read and 90.7 percent of kilobytes written) goes to `hdisk2`, which contains both the operating system and the paging space. The cumulative *CPU utilization since boot* statistic is usually meaningless, unless you use the system consistently, 24 hours a day.

The second report shows a small amount of disk activity reading from `hdisk0`, which contains a separate file system for the system's primary user. The CPU activity arises from two application programs and the **iostat** command itself.

In the third report, you can see that we artificially created a near-thrashing condition by running a program that allocates and stores a large amount of memory, which is about 26 MB in the above example. Also in the above example, `hdisk2` is active 98.4 percent of the time, which results in 93.8 percent I/O wait.

The limiting factor for a single program

If you are the sole user of a system, you can get a general idea of whether a program is I/O or CPU dependent by using the **time** command as follows:

```
# time cp foo.in foo.out
```

```
real    0m0.13s
user    0m0.01s
sys     0m0.02s
```

Note: Examples of the **time** command use the version that is built into the Korn shell, **ksh**. The official **time** command, **/usr/bin/time**, reports with a lower precision.

In the above example, the fact that the **real** elapsed time for the execution of the **cp** program (0.13 seconds) is significantly greater than the sum (.03 seconds) of the user and system CPU times indicates that the program is I/O bound. This occurs primarily because the **foo.in** file has not been read recently.

On an SMP, the output takes on a new meaning. See **time** and **timex** Cautions for more information.

Running the same command a few seconds later against the same file gives the following output:

```
real    0m0.06s
user    0m0.01s
sys     0m0.03s
```

Most or all of the pages of the **foo.in** file are still in memory because there has been no intervening process to cause them to be reclaimed and because the file is small compared with the amount of RAM on the system. A small **foo.out** file would also be buffered in memory, and a program using it as input would show little disk dependency.

If you are trying to determine the disk dependency of a program, you must be sure that its input is in an authentic state. That is, if the program will normally be run against a file that has not been accessed recently, you must make sure that the file used in measuring the program is not in memory. If, on the other hand, a program is usually run as part of a standard sequence in which it gets its input from the output of the preceding program, you should prime memory to ensure that the measurement is authentic. For example, the following command would have the effect of priming memory with the pages of the **foo.in** file:

```
# cp foo.in /dev/null
```

The situation is more complex if the file is large compared to RAM. If the output of one program is the input of the next and the entire file will not fit in RAM, the second program will read pages at the head of the file, which displaces pages at the end. Although this situation is very hard to simulate authentically, it is nearly equivalent to one in which no disk caching takes place.

The case of a file that is perhaps just slightly larger than RAM is a special case of the RAM versus disk analysis discussed in the next section.

Disk or memory-related problem

Just as a large fraction of real memory is available for buffering files, the system's page space is available as temporary storage for program working data that has been forced out of RAM. Suppose that you have a program that reads little or no data and yet shows the symptoms of being I/O dependent. Worse, the ratio of real time to user + system time does not improve with successive runs. The program is probably memory-limited, and its I/O is to, and possibly from the paging space. A way to check on this possibility is shown in the following **vmstat** shell script:

```

vmstat -s >temp.file # cumulative counts before the command
time $1 # command under test
vmstat -s >>temp.file # cumulative counts after execution
grep "pagi.*ins" temp.file >>results # extract only the data
grep "pagi.*outs" temp.file >>results # of interest

```

The **vmstatit** script summarizes the voluminous **vmstat -s** report, which gives cumulative counts for a number of system activities since the system was started.

If the shell script is run as follows:

```
# vmstatit "cp file1 file2" 2>results
```

the result is as follows:

```

real    0m0.03s
user    0m0.01s
sys     0m0.02s
      2323 paging space page ins
      2323 paging space page ins
      4850 paging space page outs
      4850 paging space page outs

```

The before-and-after paging statistics are identical, which confirms our belief that the **cp** command is not paging-bound. An extended variant of the **vmstatit** shell script can be used to show the true situation, as follows:

```

vmstat -s >temp.file
time $1
vmstat -s >>temp.file
echo "Ordinary Input:" >>results
grep "[ 0-9]*page ins" temp.file >>results
echo "Ordinary Output:" >>results
grep "[ 0-9]*page outs" temp.file >>results
echo "True Paging Output:" >>results
grep "pagi.*outs" temp.file >>results
echo "True Paging Input:" >>results
grep "pagi.*ins" temp.file >>results

```

Because file I/O in the operating system is processed through the VMM, the **vmstat -s** command reports ordinary program I/O as page ins and page outs. When the previous version of the **vmstatit** shell script was run against the **cp** command of a large file that had not been read recently, the result was as follows:

```

real    0m2.09s
user    0m0.03s
sys     0m0.74s
Ordinary Input:
  46416 page ins
  47132 page ins
Ordinary Output:
 146483 page outs
 147012 page outs
True Paging Output:
  4854 paging space page outs
  4854 paging space page outs
True Paging Input:
  2527 paging space page ins
  2527 paging space page ins

```

The **time** command output confirms the existence of an I/O dependency. The increase in page ins shows the I/O necessary to satisfy the **cp** command. The increase in page outs indicates that the file is large enough to force the writing of dirty pages (not necessarily its own) from memory. The fact that there is no change in the cumulative paging-space-I/O counts confirms that the **cp** command does not build data structures large enough to overload the memory of the test machine.

The order in which this version of the **vmstatit** script reports I/O is intentional. Typical programs read file input and then write file output. Paging activity, on the other hand, typically begins with the writing out of a working-segment page that does not fit. The page is read back in only if the program tries to access it. The fact that the test system has experienced almost twice as many paging space page outs as paging space page ins since it was booted indicates that at least some of the programs that have been run on this system have stored data in memory that was not accessed again before the end of the program. Memory-Limited Programs provides more information. See also Monitoring and Tuning Memory Performance.

To show the effects of memory limitation on these statistics, the following example observes a given command in an environment of adequate memory (32 MB) and then artificially shrinks the system using the **rmss** command (see Assessing Memory Requirements Through the **rmss** Command). The following command sequence

```
# cc -c ed.c
# vmstatit "cc -c ed.c" 2>results
```

first primes memory with the 7944-line source file and the executable file of the C compiler, then measures the I/O activity of the second execution:

```
real    0m7.76s
user    0m7.44s
sys     0m0.15s
Ordinary Input:
  57192 page ins
  57192 page ins
Ordinary Output:
 165516 page outs
 165553 page outs
True Paging Output:
 10846 paging space page outs
 10846 paging space page outs
True Paging Input:
  6409 paging space page ins
  6409 paging space page ins
```

Clearly, this is not I/O limited. There is not even any I/O necessary to read the source code. If we then issue the following command:

```
# rmss -c 8
```

to change the effective size of the machine to 8 MB, and perform the same sequence of commands, we get the following output:

```
real    0m9.87s
user    0m7.70s
sys     0m0.18s
Ordinary Input:
  57625 page ins
  57809 page ins
Ordinary Output:
 165811 page outs
 165882 page outs
True Paging Output:
 11010 paging space page outs
 11061 paging space page outs
True Paging Input:
  6623 paging space page ins
  6701 paging space page ins
```

The following symptoms of I/O dependency are present:

- Elapsed time is longer than total CPU time
- Significant amounts of ordinary I/O on the *n*th execution of the command

The fact that the elapsed time is longer than in the memory-unconstrained situation, and the existence of significant amounts of paging-space I/O, make it clear that the compiler is being hampered by insufficient memory.

Note: This example illustrates the effects of memory constraint. No effort was made to minimize the use of memory by other processes, so the absolute size at which the compiler was forced to page in this environment does not constitute a meaningful measurement.

To avoid working with an artificially shrunken machine until the next restart, run

```
# rmss -r
```

to release back to the operating system the memory that the **rmss** command had sequestered, thus restoring the system to its normal capacity.

Workload Management Diagnosis

When you have exhausted the program performance-improvement and system-tuning possibilities, and performance is still unsatisfactory at times, you have three choices:

- Let the situation remain as is
- Upgrade the performance-limiting resource
- Adopt workload-management techniques

The first approach leads to frustration and decreased productivity for some of your users. If you choose to upgrade a resource, you have to be able to justify the expenditure. Thus the obvious solution is to investigate the possibilities of workload management.

Workload management simply means assessing the priority of each of the components of the workload. Usually, there are jobs that you can postpone. For example, a report that you need first thing in the morning is equally useful when run at 3 a.m. as at 4 p.m. on the preceding day. The difference is that it uses CPU cycles and other resources that are most likely idle at 3 a.m. You can use the **at** or **crontab** command to request a program to run at a specific time or at regular intervals.

Similarly, some programs that have to run during the day can run at reduced priority. They will take longer to complete, but they will be in less competition with really time-critical processes.

Another technique is to move work from one machine to another; for example, if you run a compilation on the machine where the source code resides. This kind of workload balancing requires more planning and monitoring because reducing the load on the network and increasing the CPU load on a server might result in a net loss.

The AIX Workload Manager (WLM) is part of the operating system kernel. WLM is designed to give the system administrator greater control over how the scheduler and virtual memory manager (VMM) allocate CPU and physical memory resources to processes. Disk usage can also be controlled by WLM. This can prevent different classes of jobs from interfering with each other and to explicitly apply resources based on the requirements of different groups of users. For further information, see *Server Consolidation on RS/6000®*.

Chapter 6. Resource Management Overview

This chapter describes the components of the operating system that manage the resources that have the most effect on system performance, and the ways in which these components can be tuned. This chapter contains the following major sections:

- Performance Overview of the CPU Scheduler.
- Performance Overview of the Virtual Memory Manager (VMM).
- Performance Overview of Fixed-Disk Storage Management.

Specific tuning recommendations appear in the following:

- Chapter 6. Monitoring and Tuning CPU Use.
- Chapter 7. Monitoring and Tuning Memory Use.
- Chapter 8. Monitoring and Tuning Disk I/O Use.
- Chapter 9. Monitoring and Tuning Communications I/O Use.
- Chapter 10. Monitoring and Tuning NFS Use.

Performance Overview of the processor Scheduler

This section discusses performance related topics for the processor Scheduler.

Thread Support

A *thread* can be thought of as a low-overhead process. It is a dispatchable entity that requires fewer resources to create than a process. The fundamental dispatchable entity of the AIX Version 4 scheduler is the thread.

Processes are composed of one or more threads. In fact, workloads migrated directly from earlier releases of the operating system continue to create and manage processes. Each new process is created with a single thread that has its parent process priority and contends for the processor with the threads of other processes. The process owns the resources used in execution; the thread owns only its current state.

When new or modified applications take advantage of the operating system's thread support to create additional threads, those threads are created within the context of the process. They share the process's private segment and other resources.

A user thread within a process has a specified *contention scope*. If the contention scope is *global*, the thread contends for processor time with all other threads in the system. The thread that is created when a process is created has global contention scope. If the contention scope is *local*, the thread contends with the other threads within the process to be the recipient of the process's share of processor time.

The algorithm for determining which thread should be run next is called a *scheduling policy*.

Processes and Threads

A process is an activity within the system that is started by a command, a shell program, or another process.

Process properties are as follows:

- pid
- pgid
- uid
- gid

- environment
- cwd
- file descriptors
- signal actions
- process statistics
- nice

These properties are defined in `/usr/include/sys/proc.h`.

Thread properties are as follows:

- stack
- scheduling policy
- scheduling priority
- pending signals
- blocked signals
- thread-specific data

These thread properties are defined in `/usr/include/sys/thread.h`.

Each process is made up of one or more threads. A thread is a single sequential flow of control. Multiple threads of control allow an application to overlap operations, such as reading from a terminal and writing to a file.

Multiple threads of control also allow an application to service requests from multiple users at the same time. Threads provide these capabilities without the added overhead of multiple processes such as those created through the `fork()` system call.

AIX 4.3.1 introduced a fast fork routine called `f_fork()`. This routine is very useful for multithreaded applications that will call the `exec()` subroutine immediately after they would have called the `fork()` subroutine. The `fork()` subroutine is slower because it has to call fork handlers to acquire all the library locks before actually forking and letting the child run all child handlers to initialize all the locks. The `f_fork()` subroutine bypasses these handlers and calls the `kfork()` system call directly. Web servers are a good example of an application that can use the `f_fork()` subroutine.

Process and Thread Priority

The priority management tools manipulate process priority. In AIX Version 4, process priority is simply a precursor to thread priority. When the `fork()` subroutine is called, a process and a thread to run in it are created. The thread has the priority that would have been attributed to the process.

The kernel maintains a *priority value* (sometimes termed the *scheduling priority*) for each thread. The priority value is a positive integer and varies inversely with the importance of the associated thread. That is, a smaller priority value indicates a more important thread. When the scheduler is looking for a thread to dispatch, it chooses the dispatchable thread with the smallest priority value.

A thread can be fixed-priority or nonfixed priority. The priority value of a fixed-priority thread is constant, while the priority value of a nonfixed-priority thread varies based on the minimum priority level for user threads (a constant 40), the thread's nice value (20 by default, optionally set by the `nice` or `renice` command), and its processor-usage penalty.

The priority of a thread can be fixed at a certain value, which can have a priority value less than 40, if their priority is set (fixed) through the `setpri()` subroutine. These threads are immune to the scheduler

recalculation algorithms. If their priority values are fixed to be less than 40, these threads will run and complete before any user threads can run. For example, a thread with a fixed value of 10 will run before a thread with a fixed value of 15.

Users can apply the **nice** command to make a thread's nonfixed priority less favorable. The system manager can apply a negative nice value to a thread, thus giving it a better priority.

The following illustration shows some of the ways in which the priority value can change.

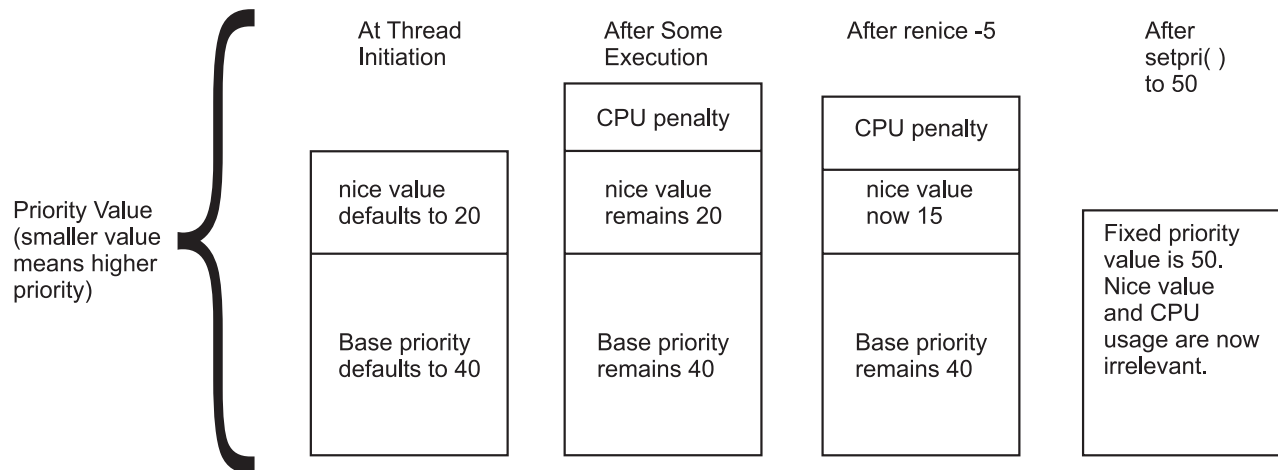

Figure 6. How the Priority Value is Determined. The illustration shows how the scheduling priority value of a thread can change during execution or after applying the nice command. The smaller the priority value, the higher the thread priority. At initiation, the nice value defaults to 20 and the base priority defaults to 40. After some execution and a processor penalty, the nice value remains 20 and the base priority remains 40. After running the renice —5 command and with the same processor usage as before, the nice value is now 15 and the base priority remains 40. After issuing the setpri() subroutine with a value of 50, fixed priority is now 50 and the nice value and processor usage is irrelevant.

The nice value of a thread is set when the thread is created and is constant over the life of the thread, unless explicitly changed by the user through the **renice** command or the **setpri()**, **setpriority()**, **thread_setsched()**, or **nice()** system calls.

The processor penalty is an integer that is calculated from the recent processor usage of a thread. The recent processor usage increases by approximately 1 each time the thread is in control of the processor at the end of a 10 ms clock tick, up to a maximum value of 120. The actual priority penalty per tick increases with the **nice** value. Once per second, the recent processor usage values for all threads are recalculated.

The result is the following:

- The priority of a nonfixed-priority thread becomes less favorable as its recent processor usage increases and vice versa. This implies that, on average, the more time slices a thread has been allocated recently, the less likely it is that the thread will be allocated the next time slice.
- The priority of a nonfixed-priority thread becomes less favorable as its nice value increases, and vice versa.

Note: With the use of multiple processor run queues and their load balancing mechanism, **nice** or **renice** values might not have the expected effect on thread priorities because less favored priorities might have equal or greater run time than favored priorities. Threads requiring the expected effects of **nice** or **renice** should be placed on the global run queue.

You can use the **ps** command to display the priority value, nice value, and short-term processor-usage values for a process.

See Controlling Contention for the processor for a more detailed discussion on using the **nice** and **renice** commands.

See Tuning the Thread-Priority-Value Calculation, for the details of the calculation of the processor penalty and the decay of the recent processor usage values.

The priority mechanism is also used by AIX Workload Manager to enforce processor resource management. Because threads classified under the Workload Manager have their priorities managed by the Workload Manager, they might have different priority behavior over threads not classified under the Workload Manager.

Scheduling Policy for Threads

The following are the possible values for thread scheduling policy:

SCHED_FIFO

After a thread with this policy is scheduled, it runs to completion unless it is blocked, it voluntarily yields control of the processor, or a higher-priority thread becomes dispatchable. Only fixed-priority threads can have a SCHED_FIFO scheduling policy.

SCHED_RR

When a SCHED_RR thread has control at the end of the time slice, it moves to the tail of the queue of dispatchable threads of its priority. Only fixed-priority threads can have a SCHED_RR scheduling policy.

SCHED_OTHER

This policy is defined by POSIX Standard 1003.4a as implementation-defined. The recalculation of the running thread's priority value at each clock interrupt means that a thread may lose control because its priority value has risen above that of another dispatchable thread.

SCHED_FIFO2

The policy is the same as for SCHED_FIFO, except that it allows a thread which has slept for only a short amount of time to be put at the head of its run queue when it is awakened. This time period is the affinity limit (tunable with **schedo -o affinity_lim**). This policy is only available beginning with AIX 4.3.3.

SCHED_FIFO3

A thread whose scheduling policy is set to SCHED_FIFO3 is always put at the head of a run queue. To prevent a thread belonging to SCHED_FIFO2 scheduling policy from being put ahead of SCHED_FIFO3, the run queue parameters are changed when a SCHED_FIFO3 thread is enqueued, so that no thread belonging to SCHED_FIFO2 will satisfy the criterion that enables it to join the head of the run queue. This policy is only available beginning with AIX 4.3.3.

SCHED_FIFO4

A higher priority SCHED_FIFO4 scheduling class thread does not preempt the currently running low priority thread as long as their priorities differ by a value of 1. The default behavior is the preemption of the currently running low priority thread on a given CPU by a high priority thread that becomes eligible to run on the same CPU. This policy is only available beginning with AIX 5L Version 5100-01 + APAR IY22854.

The scheduling policies are set with the **thread_setsched()** system call and are only effective for the calling thread. However, a thread can be set to the SCHED_RR scheduling policy by issuing a **setpri()** call specifying the process ID; the caller of **setpri()** and the target of **setpri()** do not have to match.

Only processes that have root authority can issue the **setpri()** system call. Only threads that have root authority can change the scheduling policy to any of the SCHED_FIFO options or SCHED_RR. If the scheduling policy is SCHED_OTHER, the priority parameter is ignored by the **thread_setsched()** subroutine.

Threads are primarily of interest for applications that currently consist of several asynchronous processes. These applications might impose a lighter load on the system if converted to a multithreaded structure.

Scheduler Run Queue

The scheduler maintains a run queue of all of the threads that are ready to be dispatched. The following illustration depicts the run queue symbolically.

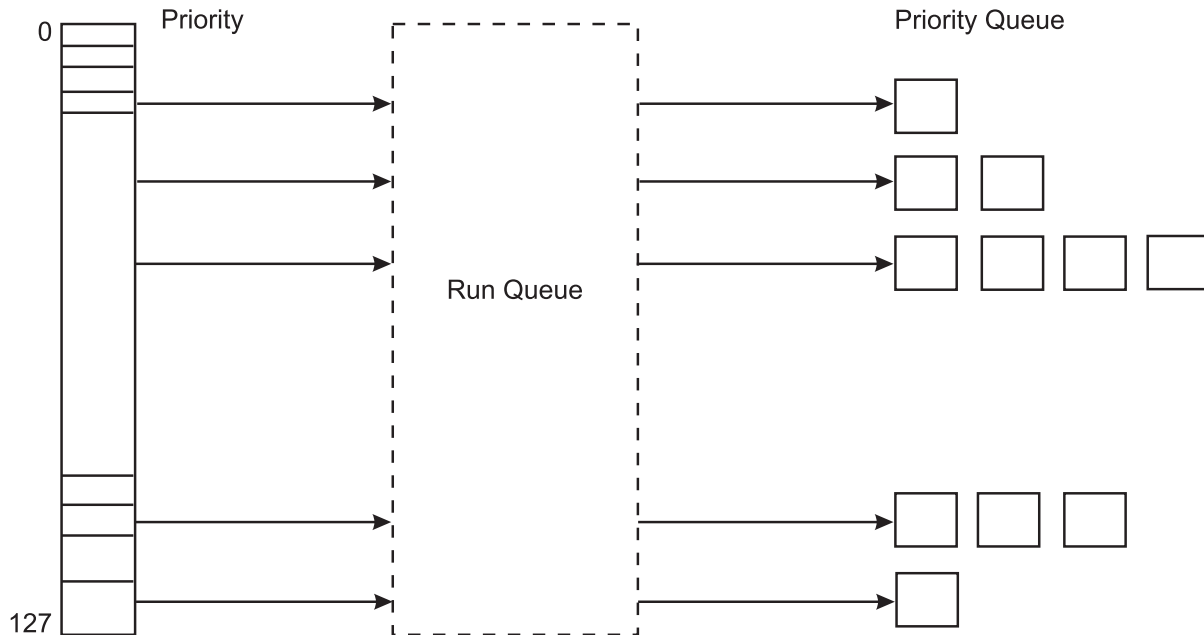

Figure 7. Run Queue. This illustration simply shows how threads with a lower priority value are passed through the run queue before threads with a higher priority value. The range of possible priority values is 0 to 127 which directly relate to a total of 128 total run queues.

All the dispatchable threads of a given priority occupy positions in the run queue.

The fundamental dispatchable entity of the scheduler is the thread. AIX 5.1 maintains 256 run queues (128 in AIX 4.3 and prior releases). In AIX 5.1, run queues relate directly to the range of possible values (0 through 255) for the priority field for each thread. This method makes it easier for the scheduler to determine which thread is most favored to run. Without having to search a single large run queue, the scheduler consults a mask where a bit is on to indicate the presence of a ready-to-run thread in the corresponding run queue.

The priority value of a thread changes rapidly and frequently. The constant movement is due to the way that the scheduler recalculates priorities. This is not true, however, for fixed-priority threads.

Starting with AIX 4.3.3, each processor has its own run queue. The run queue values reported in the performance tools will be the sum of all the threads in each run queue. Having a per-processor run queue saves overhead on dispatching locks and improves overall processor affinity. Threads will tend to stay on the same processor more often. If a thread becomes runnable because of an event on another processor than the one in which the newly runnable thread had been running on, then this thread would only get dispatched immediately if there was an idle processor. No preemption occurs until the processor's state can be examined (such as an interrupt on this thread's processor).

On multiprocessor systems with multiple run queues, transient priority inversions can occur. It is possible at any point in time that one run queue could have several threads having more favorable priority than another run queue. AIX has mechanisms for priority balancing over time, but if strict priority is required (for

example, for real-time applications) an environment variable called `RT_GRQ` exists, that, if set to `ON`, will cause this thread to be on a global run queue. In that case, the global run queue is searched to see which thread has the best priority. This can improve performance for threads that are interrupt driven. Threads that are running at fixed priority are placed on the global run queue if the `fixed_pri_global` parameter of the `schedo` command is set to 1.

The average number of threads in the run queue can be seen in the first column of the `vmstat` command output. If you divide this number by the number of processors, the result is the average number of threads that can be run on each processor. If this value is greater than one, these threads must wait their turn for the processor (the greater the number, the more likely it is that performance delays are noticed).

When a thread is moved to the end of the run queue (for example, when the thread has control at the end of a time slice), it is moved to a position after the last thread in the queue that has the same priority value.

Scheduler processor time slice

The processor time slice is the amount of time a `SCHED_RR` thread can absorb before the scheduler switches to another thread at the same priority. You can use the `timeslice` option of the `schedo` command to increase the number of clock ticks in the time slice by 10 millisecond increments (see *Modifying the scheduler time slice with the schedo command*).

Note: The time slice is not a guaranteed amount of processor time. It is the longest time that a thread can be in control before it faces the possibility of being replaced by another thread. There are many ways in which a thread can lose control of the processor before it has had control for a full time slice.

Mode Switching

A user process undergoes a mode switch when it needs access to system resources. This is implemented through the system call interface or by interrupts such as page faults. There are two modes:

- User mode
- Kernel mode

Processor time spent in user mode (application and shared libraries) is reflected as user time in the output of commands such as the `vmstat`, `iostat`, and `sar` commands. Processor time spent in kernel mode is reflected as system time in the output of these commands.

User Mode

Programs that execute in the user protection domain are user processes. Code that executes in this protection domain executes in user execution mode, and has the following access:

- Read/write access to user data in the process private region
- Read access to the user text and shared text regions
- Access to shared data regions using the shared memory functions

Programs executing in the user protection domain do not have access to the kernel or kernel data segments, except indirectly through the use of system calls. A program in this protection domain can only affect its own execution environment and executes in the process or unprivileged state.

Kernel Mode

Programs that execute in the kernel protection domain include interrupt handlers, kernel processes, the base kernel, and kernel extensions (device driver, system calls and file systems). This protection domain implies that code executes in kernel execution mode, and has the following access:

- Read/write access to the global kernel address space
- Read/write access to the kernel data in the process region when executing within a process

Kernel services must be used to access user data within the process address space.

Programs executing in this protection domain can affect the execution environments of all programs, because they have the following characteristics:

- They can access global system data
- They can use kernel services
- They are exempt from all security restraints
- They execute in the processor privileged state.

Mode Switches

The use of a system call by a user-mode process allows a kernel function to be called from user mode. Access to functions that directly or indirectly invoke system calls is typically provided by programming libraries, which provide access to operating system functions.

Mode switches should be differentiated from the context switches seen in the output of the **vmstat** (cs column) and **sar** (cswch/s) commands. A context switch occurs when the currently running thread is different from the previously running thread on that processor.

The scheduler performs a context switch when any of the following occurs:

- A thread must wait for a resource (voluntarily), such as disk I/O, network I/O, sleep, or locks
- A higher priority thread wakes up (involuntarily)
- The thread has used up its time slice (usually 10 ms).

Context switch time, system calls, device interrupts, NFS I/O, and any other activity in the kernel is considered as system time.

Performance Overview of the Virtual Memory Manager (VMM)

The virtual address space is partitioned into segments. A segment is a 256 MB, contiguous portion of the virtual-memory address space into which a data object can be mapped.

Process addressability to data is managed at the segment (or object) level so that a segment can be shared between processes or maintained as private. For example, processes can share code segments yet have separate and private data segments.

Real-Memory Management

Virtual-memory segments are partitioned into fixed-size units called *pages*. The default page size is 4096 bytes. Some systems also support a larger page size, typically accessed only through the **shmat** system call. Each page in a segment can be in real memory (RAM), or stored on disk until it is needed. Similarly, real memory is divided into 4096-byte page frames. The role of the VMM is to manage the allocation of real-memory page frames and to resolve references by the program to virtual-memory pages that are not currently in real memory or do not yet exist (for example, when a process makes the first reference to a page of its data segment).

Because the amount of virtual memory that is in use at any given instant can be larger than real memory, the VMM must store the surplus on disk. From the performance standpoint, the VMM has two, somewhat opposed, objectives:

- Minimize the overall processor-time and disk-bandwidth cost of the use of virtual memory
- Minimize the response-time cost of page faults

In pursuit of these objectives, the VMM maintains a *free list* of page frames that are available to satisfy a page fault. The VMM uses a page-replacement algorithm to determine which virtual-memory pages currently in memory will have their page frames reassigned to the free list. The page-replacement algorithm uses several mechanisms:

- Virtual-memory segments are classified into either persistent segments or working segments.
- Virtual-memory segments are classified as containing either computational or file memory.
- Virtual-memory pages whose access causes a page fault are tracked.
- Page faults are classified as new-page faults or as repage faults.
- Statistics are maintained on the rate of repage faults in each virtual-memory segment.
- User-tunable thresholds influence the page-replacement algorithm's decisions.

The following sections describe the free list and the page-replacement mechanisms in more detail.

Free List

The VMM maintains a logical list of free page frames that it uses to accommodate page faults. In most environments, the VMM must occasionally add to the free list by reassigning some page frames owned by running processes. The virtual-memory pages whose page frames are to be reassigned are selected by the VMM's page-replacement algorithm. The VMM thresholds determine the number of frames reassigned.

Persistent versus Working Segments

The pages of a persistent segment have permanent storage locations on disk. Files containing data or executable programs are mapped to persistent segments. Because each page of a persistent segment has a permanent disk storage location, the VMM writes the page back to that location when the page has been changed and can no longer be kept in real memory. If the page has not changed when selected for placement on a free list, no I/O is required. If the page is referenced again later, a new copy is read in from its permanent disk-storage location.

Working segments are transitory, exist only during their use by a process, and have no permanent disk-storage location. Process stack and data regions are mapped to working segments, as are the kernel text segment, the kernel-extension text segments, as well as the shared-library text and data segments. Pages of working segments must also have disk-storage locations to occupy when they cannot be kept in real memory. The disk-paging space is used for this purpose.

The following illustration shows the relationship between some of the types of segments and the locations of their pages on disk. It also shows the actual (arbitrary) locations of the pages when they are in real memory.

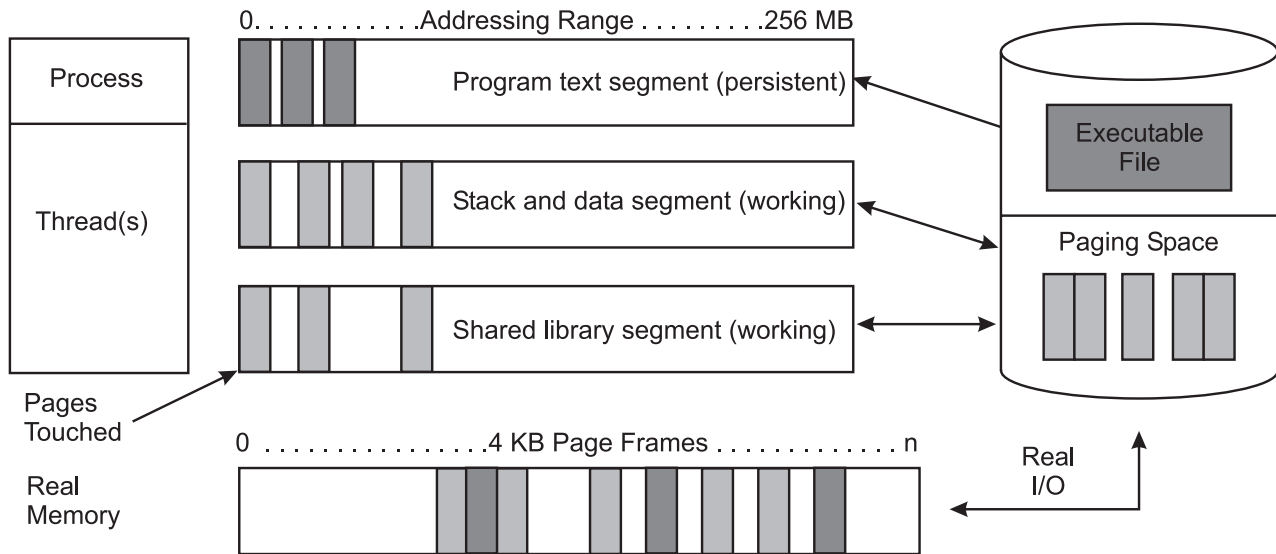

Figure 8. Persistent and Working Storage Segments. This illustration shows the relationship between some of the types of segments and the locations of their pages on disk. It also shows the actual (arbitrary) locations of the pages when they are in real memory. Working segments are transitory, meaning they exist only during their use by a process and have no permanent disk-storage location. Process stack and data regions are mapped to working segments, as are the kernel text segment, the kernel-extension text segments, and the shared-library text and data segments. Pages of working segments must also have disk-storage locations to occupy when they cannot be kept in real memory. The disk-paging space is used for this purpose.

Persistent-segment types are further classified. *Client segments* are used to map remote files (for example, files that are being accessed through NFS), including remote executable programs. Pages from client segments are saved and restored over the network to their permanent file location, not on the local-disk paging space. *Journalled and deferred segments* are persistent segments that must be atomically updated. If a page from a journalled or deferred segment is selected to be removed from real memory (paged out), it must be written to disk paging space unless it is in a state that allows it to be committed (written to its permanent file location).

Computational versus File Memory

Computational memory, also known as computational pages, consists of the pages that belong to working-storage segments or program text (executable files) segments.

File memory (or file pages) consists of the remaining pages. These are usually pages from permanent data files in persistent storage.

Page Replacement

When the number of available real memory frames on the free list becomes low, a page stealer is invoked. A page stealer moves through the Page Frame Table (PFT), looking for pages to steal.

The PFT includes flags to signal which pages have been referenced and which have been modified. If the page stealer encounters a page that has been referenced, it does not steal that page, but instead, resets the reference flag for that page. The next time the clock hand (page stealer) passes that page and the reference bit is still off, that page is stolen. A page that was not referenced in the first pass is immediately stolen.

The modify flag indicates that the data on that page has been changed since it was brought into memory. When a page is to be stolen, if the modify flag is set, a pageout call is made before stealing the page. Pages that are part of working segments are written to paging space; persistent segments are written to disk.

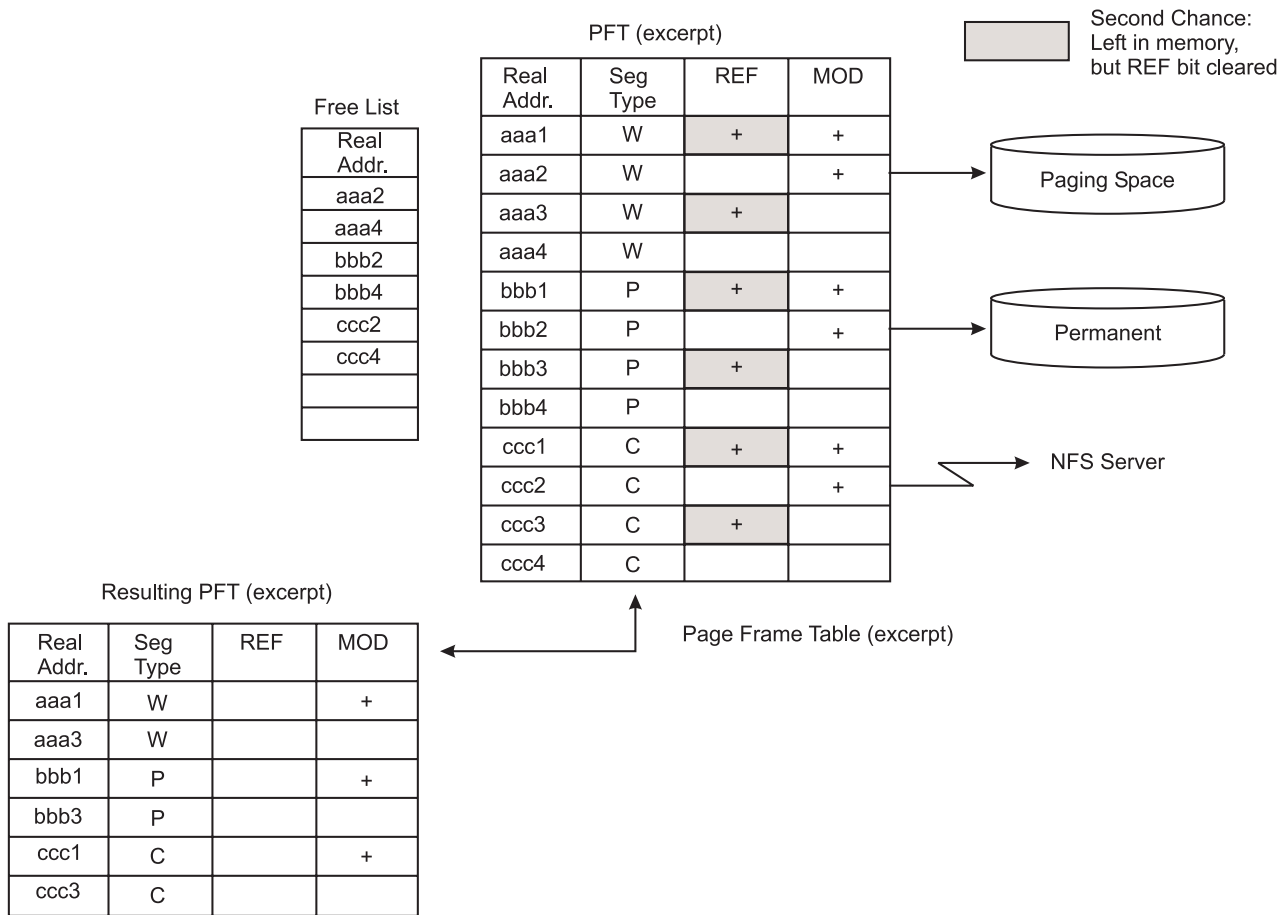

Figure 9. Page Replacement Example. The illustration consists of excerpts from three tables. The first table is the page frame table with four columns that contain the real address, the segment type, a reference flag, and a modify flag. A second table is called the free list table and contains addresses of all free pages. The last table represents the resulting page frame table after all of the free addresses have been removed.

In addition to the page-replacement, the algorithm keeps track of both new page faults (referenced for the first time) and repage faults (referencing pages that have been paged out), by using a history buffer that contains the IDs of the most recent page faults. It then tries to balance file (persistent data) page outs with computational (working storage or program text) page outs.

When a process exits, its working storage is released immediately and its associated memory frames are put back on the free list. However, any files that the process may have opened can stay in memory.

Page replacement is done directly within the scope of the thread if running on a uniprocessor. On a multiprocessor system, page replacement is done through the **lrud** kernel process, which is dispatched to a CPU when the **minfree** threshold has been reached. Starting with AIX 4.3.3, the **lrud** kernel process is multithreaded with one thread per memory pool. Real memory is split into evenly sized memory pools based on the number of CPUs and the amount of RAM. The number of memory pools on a system can be determined by running the **vmstat -v** command.

You can use the **vmo -r -o mempools= <number of memory pools>** command to change the number of memory pools that will be configured at system boot. The values for the **minfree** and **maxfree** parameters in the **vmo** command output is the sum of the **minfree** and **maxfree** parameters for each memory pool.

Repaging

A page fault is considered to be either a new page fault or a repage fault. A new page fault occurs when there is no record of the page having been referenced recently. A repage fault occurs when a page that is

known to have been referenced recently is referenced again, and is not found in memory because the page has been replaced (and perhaps written to disk) since it was last accessed.

A perfect page-replacement policy would eliminate repage faults entirely (assuming adequate real memory) by always stealing frames from pages that are not going to be referenced again. Thus, the number of repage faults is an inverse measure of the effectiveness of the page-replacement algorithm in keeping frequently reused pages in memory, thereby reducing overall I/O demand and potentially improving system performance.

To classify a page fault as new or repage, the VMM maintains a repage history buffer that contains the page IDs of the N most recent page faults, where N is the number of frames that the memory can hold. For example, 512 MB memory requires a 128 KB repage history buffer. At page-in, if the page's ID is found in the repage history buffer, it is counted as a repage. Also, the VMM estimates the computational-memory repaging rate and the file-memory repaging rate separately by maintaining counts of repage faults for each type of memory. The repaging rates are multiplied by 0.9 each time the page-replacement algorithm runs, so that they reflect recent repaging activity more strongly than historical repaging activity.

VMM Thresholds

Several numerical thresholds define the objectives of the VMM. When one of these thresholds is breached, the VMM takes appropriate action to bring the state of memory back within bounds. This section discusses the thresholds that the system administrator can alter through the **vmo** command.

The number of page frames on the free list is controlled by the following parameters:

minfree

Minimum acceptable number of real-memory page frames in the free list. When the size of the free list falls below this number, the VMM begins stealing pages. It continues stealing pages until the size of the free list reaches **maxfree**.

maxfree

Maximum size to which the free list will grow by VMM page-stealing. The size of the free list may exceed this number as a result of processes terminating and freeing their working-segment pages or the deletion of files that have pages in memory.

The VMM attempts to keep the size of the free list greater than or equal to **minfree**. When page faults or system demands cause the free list size to fall below **minfree**, the page-replacement algorithm runs. The size of the free list must be kept above a certain level (the default value of **minfree**) for several reasons. For example, the operating system's sequential-prefetch algorithm requires several frames at a time for each process that is doing sequential reads. Also, the VMM must avoid deadlocks within the operating system itself, which could occur if there were not enough space to read in a page that was required to free a page frame.

The following thresholds are expressed as percentages. They represent the fraction of the total real memory of the machine that is occupied by file pages (pages of noncomputational segments).

minperm

If the percentage of real memory occupied by file pages falls below this level, the page-replacement algorithm steals both file and computational pages, regardless of repage rates.

maxperm

If the percentage of real memory occupied by file pages rises above this level, the page-replacement algorithm steals only file pages.

maxclient

If the percentage of real memory occupied by file pages is above this level, the page-replacement algorithm steals only client pages.

When the percentage of real memory occupied by file pages is between the **minperm** and **maxperm** parameter values, the VMM normally steals only file pages, but if the repaging rate for file pages is higher than the repaging rate for computational pages, computational pages are stolen as well.

The main intent of the page-replacement algorithm is to ensure that computational pages are given fair treatment. For example, the sequential reading of a long data file into memory should not cause the loss of program text pages that are likely to be used again soon. The page-replacement algorithm's use of the thresholds and repaging rates ensures that both types of pages get treated fairly, with a slight bias in favor of computational pages.

VMM Memory Load Control Facility

A process requires real-memory pages to execute. When a process references a virtual-memory page that is on disk, because it either has been paged-out or has never been read, the referenced page must be paged-in and, on average, one or more pages must be paged out (if replaced pages had been modified), creating I/O traffic and delaying the progress of the process.

The operating system attempts to steal real memory from pages that are unlikely to be referenced in the near future, through the page-replacement algorithm. A successful page-replacement algorithm allows the operating system to keep enough processes active in memory to keep the CPU busy. But at some level of competition for memory, no pages are good candidates for paging out to disk because they will all be reused in the near future by the active set of processes. This situation depends on the following:

- Total amount of memory in the system
- The number of processes
- The time-varying memory requirements of each process
- The page-replacement algorithm

When this happens, continuous paging-in and paging-out occurs. This condition is called *thrashing*. Thrashing results in incessant I/O to the paging disk and causes each process to encounter a page fault almost as soon as it is dispatched, with the result that none of the processes make any significant progress.

The most destructive aspect of thrashing is that, although thrashing may have been triggered by a brief, random peak in workload (such as all of the users of a system happening to press Enter in the same second), the system might continue thrashing for an indefinitely long time.

The operating system has a memory load-control algorithm that detects when the system is starting to thrash and then suspends active processes and delays the initiation of new processes for a period of time. Five parameters set rates and bounds for the algorithm. The default values of these parameters have been chosen to be "fail safe" across a wide range of workloads. In AIX Version 4, memory load control is disabled by default on systems that have available memory frames that add up to greater than or equal to 128 MB.

Memory Load Control Algorithm

The memory load control mechanism assesses, once per second, whether sufficient memory is available for the set of active processes. When a memory-overcommitment condition is detected, some processes are suspended, decreasing the number of active processes and thereby decreasing the level of memory overcommitment.

When a process is suspended, all of its threads are suspended when they reach a suspendable state. The pages of the suspended processes quickly become stale and are paged out by the page-replacement algorithm, releasing enough page frames to allow the remaining active processes to progress. During the interval in which existing processes are suspended, newly created processes are also suspended, preventing new work from entering the system. Suspended processes are not reactivated until a subsequent interval passes during which no potential thrashing condition exists. Once this safe interval has passed, the threads of the suspended processes are gradually reactivated.

Memory load-control **schedo** parameters specify the following:

- The system memory overcommitment threshold (**v_repage_hi**)
- The number of seconds required to make a safe interval (**v_sec_wait**)
- The individual process memory overcommitment threshold by which an individual process is qualified as a suspension candidate (**v_repage_proc**)
- The minimum number of active processes when processes are being suspended (**v_min_process**)
- The minimum number of elapsed seconds of activity for a process after reactivation (**v_exempt_secs**)

For information on setting and tuning these parameters, see Tuning VMM Memory Load Control with the **schedo** Command.

Once per second, the scheduler (process 0) examines the values of all the above measures that have been collected over the preceding one-second interval, and determines if processes are to be suspended or activated. If processes are to be suspended, every process eligible for suspension by the **-p** and **-e** parameter test is marked for suspension. When that process next receives the CPU in user mode, it is suspended (unless doing so would reduce the number of active processes below the **-m** value). The user-mode criterion is applied so that a process is ineligible for suspension during critical system activities performed on its behalf. If, during subsequent one-second intervals, the thrashing criterion is still being met, additional process candidates meeting the criteria set by **-p** and **-e** are marked for suspension. When the scheduler subsequently determines that the safe-interval criterion has been met and processes are to be reactivated, some number of suspended processes are put on the run queue (made active) every second.

Suspended processes are reactivated by:

1. Priority
2. The order in which they were suspended

The suspended processes are not all reactivated at once. A value for the number of processes reactivated is selected by a formula that recognizes the number of then-active processes and reactivates either one-fifth of the number of then-active processes or a monotonically increasing lower bound, whichever is greater. This cautious strategy results in increasing the degree of multiprogramming roughly 20 percent per second. The intent of this strategy is to make the rate of reactivation relatively slow during the first second after the safe interval has expired, while steadily increasing the reintroduction rate in subsequent seconds. If the memory-overcommitment condition recurs during the course of reactivating processes, the following occur:

- Reactivation is halted
- The marked-to-be reactivated processes are again marked suspended
- Additional processes are suspended in accordance with the above rules

Allocation and Reclamation of Paging Space Slots

The operating system supports three allocation methods for working storage, also referred to as *paging-space slots*, as follows:

- Late allocation
- Early allocation
- Deferred allocation

Note: Paging-space slots are only released by process (not thread) termination or by the **disclaim()** system call. The slots are not released by the **free()** system call.

Late Allocation Algorithm

Prior to AIX 4.3.2 with the late allocation algorithm, a paging slot is allocated to a page of virtual memory only when that page is first touched. That is the first time that the page's content is of interest to the executing program.

Many programs exploit late allocation by allocating virtual-memory address ranges for maximum-sized structures and then only using as much of the structure as the situation requires. The pages of the virtual-memory address range that are never accessed never require real-memory frames or paging-space slots.

This technique does involve some degree of risk. If all of the programs running in a machine happened to encounter maximum-size situations simultaneously, paging space might be exhausted. Some programs might not be able to continue to completion.

Early Allocation Algorithm

The second operating system's paging-space-slot-allocation method is intended for use in installations where this situation is likely, or where the cost of failure to complete is intolerably high. Aptly called early allocation, this algorithm causes the appropriate number of paging-space slots to be allocated at the time the virtual-memory address range is allocated, for example, with the **malloc()** subroutine. If there are not enough paging-space slots to support the **malloc()** subroutine, an error code is set. The early-allocation algorithm is invoked as follows:

```
# export PSALLOC=early
```

This example causes all future programs to be executed in the environment to use early allocation. The currently executing shell is not affected.

Early allocation is of interest to the performance analyst mainly because of its paging-space size implications. If early allocation is turned on for those programs, paging-space requirements can increase many times. Whereas the normal recommendation for paging-space size is at least twice the size of the system's real memory, the recommendation for systems that use **PSALLOC=early** is at least four times the real memory size. Actually, this is just a starting point. Analyze the virtual storage requirements of your workload and allocate paging spaces to accommodate them. As an example, at one time, the AIXwindows server required 250 MB of paging space when run with early allocation.

When using **PSALLOC=early**, the user should set a handler for the following SIGSEGV signal by pre-allocating and setting the memory as a stack using the **sigaltstack** function. Even though **PSALLOC=early** is specified, when there is not enough paging space and a program attempts to expand the stack, the program may receive the SIGSEGV signal.

Deferred Allocation Algorithm

The third operating system's paging-space-slot-allocation method is the default beginning with AIX 4.3.2 Deferred Page Space Allocation (DPSA) policy delays allocation of paging space until it is necessary to page out the page, which results in no wasted paging space allocation. This method can save huge amounts of paging space, which means disk space.

On some systems, paging space might not ever be needed even if all the pages accessed have been touched. This situation is most common on systems with very large amount of RAM. However, this may result in overcommitment of paging space in cases where more virtual memory than available RAM is accessed.

To disable DPSA and preserve the Late Page Space Allocation policy, run the following command:

```
# vmo -o defps=0
```

To activate DPSA, run the following command:

```
# vmo -o defps=1
```

In general, system performance can be improved by DPSA, because the overhead of allocating page space after page faults is avoided. Paging space devices need less disk space if DPSA is used.

For further information, see [Choosing a Page Space Allocation Method and Placement and Sizes of Paging Spaces](#).

Performance overview of fixed-disk storage management

The following illustration shows the hierarchy of structures used by the operating system to manage fixed-disk storage. Each individual disk drive, called a physical volume (PV), has a name, such as **/dev/hdisk0**. If the physical volume is in use, it belongs to a volume group (VG). All of the physical volumes in a volume group are divided into physical partitions (PPs) of the same size (by default, 4 MB in volume groups that include physical volumes smaller than 4 GB; 8 MB or more with bigger disks).

For space-allocation purposes, each physical volume is divided into five regions. See [Position on Physical Volume](#) for more information. The number of physical partitions in each region varies, depending on the total capacity of the disk drive.

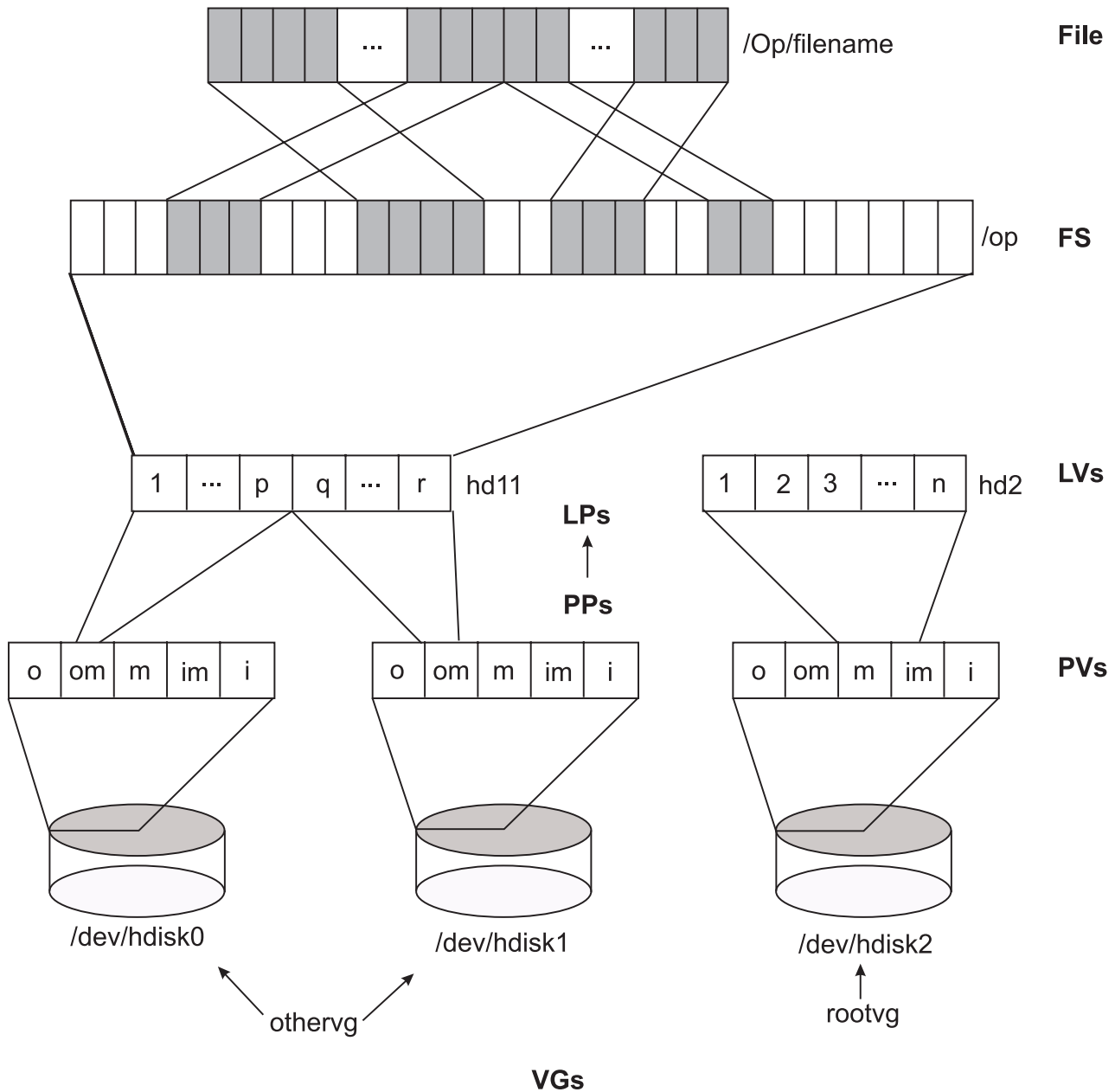

Figure 10. Organization of Fixed-Disk Data (Unmirrored). The illustration shows the hierarchy of a physical volume that is partitioned into one or more logical volumes. These partitions or logical volumes contain file systems with directory structures which contain individual files. Files are written to blocks contained in tracks on the storage media and these blocks are usually not contiguous. Disk fragmenting occurs when data gets erased and new data files are written to the empty blocks that are randomly scattered around multiple tracks on the media.

Within each volume group, one or more logical volumes (LVs) are defined. Each logical volume consists of one or more logical partitions. Each logical partition corresponds to at least one physical partition. If mirroring is specified for the logical volume, additional physical partitions are allocated to store the additional copies of each logical partition. Although the logical partitions are numbered consecutively, the underlying physical partitions are not necessarily consecutive or contiguous.

Logical volumes can serve a number of system purposes, such as paging, but each logical volume that holds ordinary system data or user data or programs contains a single journaled file system (JFS or Enhanced JFS). Each JFS consists of a pool of page-size (4096-byte) blocks. When data is to be written to a file, one or more additional blocks are allocated to that file. These blocks may or may not be contiguous with one another and with other blocks previously allocated to the file.

For purposes of illustration, the previous figure shows a bad (but not the worst possible) situation that might arise in a file system that had been in use for a long period without reorganization. The **/op/filename** file is physically recorded on a large number of blocks that are physically distant from one another. Reading the file sequentially would result in many time-consuming seek operations.

While an operating system's file is conceptually a sequential and contiguous string of bytes, the physical reality might be very different. Fragmentation may arise from multiple extensions to logical volumes as well as allocation/release/reallocation activity within a file system. A file system is fragmented when its available space consists of large numbers of small chunks of space, making it impossible to write out a new file in contiguous blocks.

Access to files in a highly fragmented file system may result in a large number of seeks and longer I/O response times (seek latency dominates I/O response time). For example, if the file is accessed sequentially, a file placement that consists of many, widely separated chunks requires more seeks than a placement that consists of one or a few large contiguous chunks. If the file is accessed randomly, a placement that is widely dispersed requires longer seeks than a placement in which the file's blocks are close together.

The effect of a file's placement on I/O performance diminishes when the file is buffered in memory. When a file is opened in the operating system, it is mapped to a persistent data segment in virtual memory. The segment represents a virtual buffer for the file; the file's blocks map directly to segment pages. The VMM manages the segment pages, reading file blocks into segment pages upon demand (as they are accessed). There are several circumstances that cause the VMM to write a page back to its corresponding block in the file on disk; but, in general, the VMM keeps a page in memory if it has been accessed recently. Thus, frequently accessed pages tend to stay in memory longer, and logical file accesses to the corresponding blocks can be satisfied without physical disk accesses.

At some point, the user or system administrator can choose to reorganize the placement of files within logical volumes and the placement of logical volumes within physical volumes to reduce fragmentation and to more evenly distribute the total I/O load. Logical volume and disk I/O performance contains further details about detecting and correcting disk placement and fragmentation problems.

Support for pinned memory

AIX 4.3.3 and AIX 5.1 enable memory pages to be maintained in real memory all the time. This mechanism is called pinning memory. Pinning a memory region prohibits the pager from stealing pages from the pages backing the pinned memory region. Memory regions defined in either system space or user space may be pinned. After a memory region is pinned, accessing that region does not result in a page fault until the region is subsequently unpinned. While a portion of the kernel remains pinned, many regions are pageable and are only pinned while being accessed.

The advantage of having portions of memory pinned is that, when accessing a page that is pinned, you can retrieve the page without going through the page replacement algorithm. An adverse side effect of having too many pinned memory pages is that it can increase paging activity for unpinned pages, which would degrade performance.

To tune pinned memory, use the **vmo** command to dedicate a number of pages at boot time for pinned memory. The following flags affect how AIX manages pinned memory:

maxpin

Specifies the maximum percentage of real memory that can be pinned.

v_pinshm

Setting the **v_pinshm** parameter to 1 causes pages in shared memory segments to be pinned by VMM, if the application, which does the **shmget()**, specifies SHM_PIN as part of the flags. The default value is 0.

Chapter 7. Introduction to Multiprocessing

At any given time, a technological limit exists on the speed with which a single processor chip can operate. If a system's workload cannot be handled satisfactorily by a single processor, one response is to apply multiple processors to the problem.

The success of this response depends not only on the skill of the system designers, but also on whether the workload is amenable to multiprocessing. In terms of human tasks, adding people might be a good idea if the task is answering calls to a toll-free number, but is dubious if the task is driving a car.

If improved performance is the objective of a proposed migration from a uniprocessor to a multiprocessor system, the following conditions must be true:

- The workload is processor-limited and has saturated its uniprocessor system.
- The workload contains multiple processor-intensive elements, such as transactions or complex calculations, that can be performed simultaneously and independently.
- The existing uniprocessor cannot be upgraded or replaced with another uniprocessor of adequate power.

Although unchanged single-thread applications normally function correctly in a multiprocessor environment, their performance often changes in unexpected ways. Migration to a multiprocessor can improve the throughput of a system, and can improve the execution time of complex, multithreaded applications, but seldom improves the response time of individual, single-thread commands.

Getting the best possible performance from a multiprocessor system requires an understanding of the operating-system and hardware-execution dynamics that are unique to the multiprocessor environment.

This chapter includes the following major sections:

- Symmetrical Multiprocessor (SMP) Concepts and Architecture
- SMP Performance Issues
- SMP Workloads
- SMP Thread Scheduling
- Thread Tuning
- SMP Tools

Symmetrical Multiprocessor (SMP) Concepts and Architecture

As with any change that increases the complexity of the system, the use of multiple processors generates design considerations that must be addressed for satisfactory operation and performance. The additional complexity gives more scope for hardware/software tradeoffs and requires closer hardware/software design coordination than in uniprocessor systems. The different combinations of design responses and tradeoffs give rise to a wide variety of multiprocessor system architectures.

This section describes the main design considerations of multiprocessor systems and the hardware responses to those considerations.

Types of Multiprocessing

Several categories of multiprocessing (MP) systems exist, as described below:

Shared Nothing MP (pure cluster)

Each processor is a complete stand-alone machine and runs a copy of the operating system. The processors share nothing (each has its own memory, caches, and disks), but they are interconnected.

When LAN-connected, processors are loosely coupled. When connected by a switch, the processors are tightly coupled. Communication between processors is done through message-passing.

The advantages of such a system are very good scalability and high availability. The disadvantages of such a system are an unfamiliar programming model (message passing).

Shared Disks MP

Processors have their own memory and cache. The processors run in parallel and share disks. Each processor runs a copy of the operating system and the processors are loosely coupled (connected through LAN). Communication between processors is done through message-passing.

The advantages of shared disks are that part of a familiar programming model is retained (disk data is addressable and coherent, memory is not), and high availability is much easier than with shared-memory systems. The disadvantages are limited scalability due to bottlenecks in physical and logical access to shared data.

Shared Memory Cluster (SMC)

All of the processors in a shared memory cluster have their own resources (main memory, disks, I/O) and each processor runs a copy of the operating system. Processors are tightly coupled (connected through a switch). Communication between the processors is done through shared memory.

Shared Memory MP

All of the processors are tightly coupled inside the same box with a high-speed bus or a switch. The processors share the same global memory, disks, and I/O devices. Only one copy of the operating system runs across all of the processors, and the operating system must be designed to exploit this architecture (multithreaded operating system).

SMPs have several advantages:

- They are a cost-effective way to increase throughput.
- They offer a single system image since the Operating System is shared between all the processors (administration is easy).
- They apply multiple processors to a single problem (parallel programming).
- Load balancing is done by the operating system.
- The uniprocessor (UP) programming model can be used in an SMP.
- They are scalable for shared data.
- All data is addressable by all the processors and kept coherent by the hardware snooping logic.
- There is no need to use message-passing libraries to communicate between processors because communication is done through the global shared memory.
- More power requirements can be solved by adding more processors to the system. However, you must set realistic expectations about the increase in performance when adding more processors to an SMP system.
- More and more applications and tools are available today. Most UP applications can run on or are ported to SMP architecture.

There are some limitations of SMP systems, as follows:

- There are limits on scalability due to cache coherency, locking mechanism, shared objects, and others.
- There is a need for new skills to exploit multiprocessors, such as threads programming and device drivers programming.

Parallelizing an Application

An application can be parallelized on an SMP in two ways, as follows:

- The traditional way is to break the application into multiple processes. These processes communicate using inter-process communication (IPC) such as pipes, semaphores or shared memory. The processes must be able to block waiting for events such as messages from other processes, and they must coordinate access to shared objects with something like locks.
- Another way is to use the portable operating system interface for UNIX[®] (POSIX) threads. Threads have similar coordination problems as processes and similar mechanisms to deal with them. Thus a single process can have any number of its threads running simultaneously on different processors. Coordinating them and serializing access to shared data are the developer's responsibility.

Consider the advantages of both threads and processes when you are determining which method to use for parallelizing an application. Threads may be faster than processes and memory sharing is easier. On another hand, a process implementation will distribute more easily to multiple machines or clusters. If an application needs to create or delete new instances, then threads are faster (more overhead in forking processes). For other functions, the overhead of threads is about the same as that of processes.

Data Serialization

Any storage element that can be read or written by more than one thread may change while the program is running. This is generally true of multiprogramming environments as well as multiprocessing environments, but the advent of multiprocessors adds to the scope and importance of this consideration in two ways:

- Multiprocessors and thread support make it attractive and easier to write applications that share data among threads.
- The kernel can no longer solve the serialization problem simply by disabling interrupts.

Note: To avoid serious problems, programs that share data must arrange to access that data serially, rather than in parallel. Before a program updates a shared data item, it must ensure that no other program (including another copy of itself running on another thread) will change the item. Reads can usually be done in parallel.

The primary mechanism that is used to keep programs from interfering with one another is the *lock*. A lock is an abstraction that represents permission to access one or more data items. Lock and unlock requests are atomic; that is, they are implemented in such a way that neither interrupts nor multiprocessor access affect the outcome. All programs that access a shared data item must obtain the lock that corresponds to that data item before manipulating it. If the lock is already held by another program (or another thread running the same program), the requesting program must defer its access until the lock becomes available.

Besides the time spent waiting for the lock, serialization adds to the number of times a thread becomes nondispatchable. While the thread is nondispatchable, other threads are probably causing the nondispatchable thread's cache lines to be replaced, which results in increased memory-latency costs when the thread finally gets the lock and is dispatched.

The operating system's kernel contains many shared data items, so it must perform serialization internally. Serialization delays can therefore occur even in an application program that does not share data with other programs, because the kernel services used by the program have to serialize shared kernel data.

Types of Locks

The Open Software Foundation/1 (OSF/1) 1.1 locking methodology was used as a model for the AIX multiprocessor lock functions. However, because the system is preemptable and pageable, some characteristics have been added to the OSF/1 1.1 Locking Model. Simple locks and complex locks are preemptable. Also, a thread may sleep when trying to acquire a busy simple lock if the owner of the lock is not currently running. In addition, a simple lock becomes a sleep lock when a processor has been spinning on a simple lock for a certain amount of time (this amount of time is a systemwide variable).

AIX Version 4 Simple Locks

A simple lock in operating system version 4 is a spin lock that will sleep under certain conditions preventing a thread from spinning indefinitely. Simple locks are preemptable, meaning that a kernel thread can be preempted by another higher priority kernel thread while it holds a simple lock. On a multiprocessor system, simple locks, which protect thread-interrupt critical sections, must be used in conjunction with interrupt control in order to serialize execution both within the executing processor and between different processors.

On a uniprocessor system, interrupt control is sufficient; there is no need to use locks. Simple locks are intended to protect thread-thread and thread-interrupt critical sections. Simple locks will spin until the lock becomes available if in an interrupt handler. They have two states: locked or unlocked.

AIX Version 4 Complex Locks

The complex locks in AIX are read-write locks which protect thread-thread critical sections. These locks are preemptable. Complex locks are spin locks that will sleep under certain conditions. By default, they are not recursive, but can become recursive through the `lock_set_recursive()` kernel service. They have three states: exclusive-write, shared-read, or unlocked.

Lock Granularity

A programmer working in a multiprocessor environment must decide how many separate locks must be created for shared data. If there is a single lock to serialize the entire set of shared data items, lock contention is comparatively likely. The existence of widely used locks places an upper limit on the throughput of the system.

If each distinct data item has its own lock, the probability of two threads contending for that lock is comparatively low. Each additional lock and unlock call costs processor time, however, and the existence of multiple locks makes a deadlock possible. At its simplest, deadlock is the situation shown in the following illustration, in which Thread 1 owns Lock A and is waiting for Lock B. Meanwhile, Thread 2 owns Lock B and is waiting for Lock A. Neither program will ever reach the `unlock()` call that would break the deadlock. The usual preventive for deadlock is to establish a protocol by which all of the programs that use a given set of locks must always acquire them in exactly the same sequence.

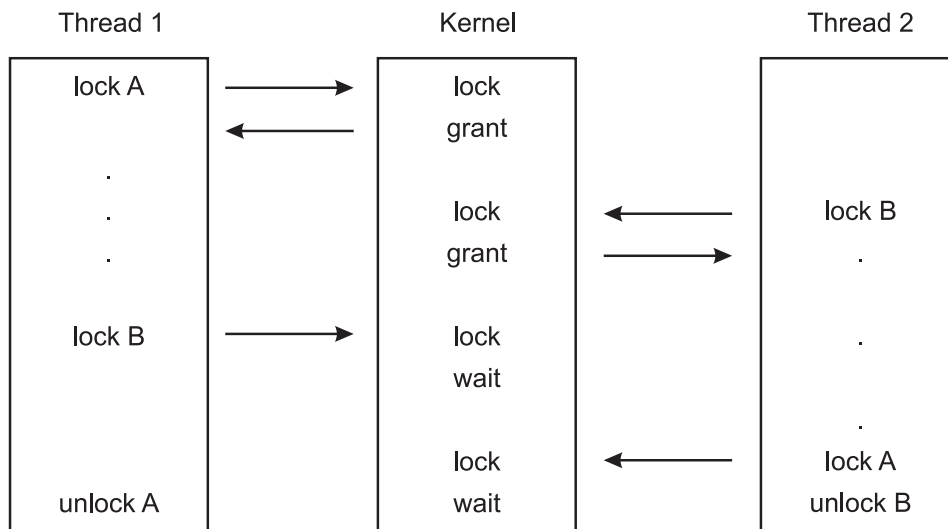

Figure 11. Deadlock. Shown in the following illustration is a deadlock in which a column named Thread 1 owns Lock A and is waiting for Lock B. Meanwhile, the column named Thread 2 owns Lock B and is waiting for Lock A. Neither program thread will ever reach the unlock call that would break the deadlock.

According to queuing theory, the less idle a resource, the longer the average wait to get it. The relationship is nonlinear; if the lock is doubled, the average wait time for that lock more than doubles.

The most effective way to reduce wait time for a lock is to reduce the size of what the lock is protecting. Here are some guidelines:

- Reduce the frequency with which any lock is requested.
- Lock just the code that accesses shared data, not all the code in a component (this will reduce lock holding time).
- Lock only specific data items or structures and not entire routines.
- Always associate locks with specific data items or structures, not with routines.
- For large data structures, choose one lock for each element of the structure rather than one lock for the whole structure.
- Never perform synchronous I/O or any other blocking activity while holding a lock.
- If you have more than one access to the same data in your component, try to move them together so they can be covered by one lock-unlock action.
- Avoid double wake-up. If you modify some data under a lock and have to notify someone that you have done it, release the lock before you post the wake-up.
- If you must hold two locks simultaneously, request the busiest one last.

On the other hand, a too-fine granularity will increase the frequency of locks requests and locks releases, which therefore will add additional instructions. You must locate a balance between a too-fine and too-coarse granularity. The optimum granularity will have to be found by trial and error, and is one of the big challenges in an MP system. The following graph shows the relation between the throughput and the granularity of locks.

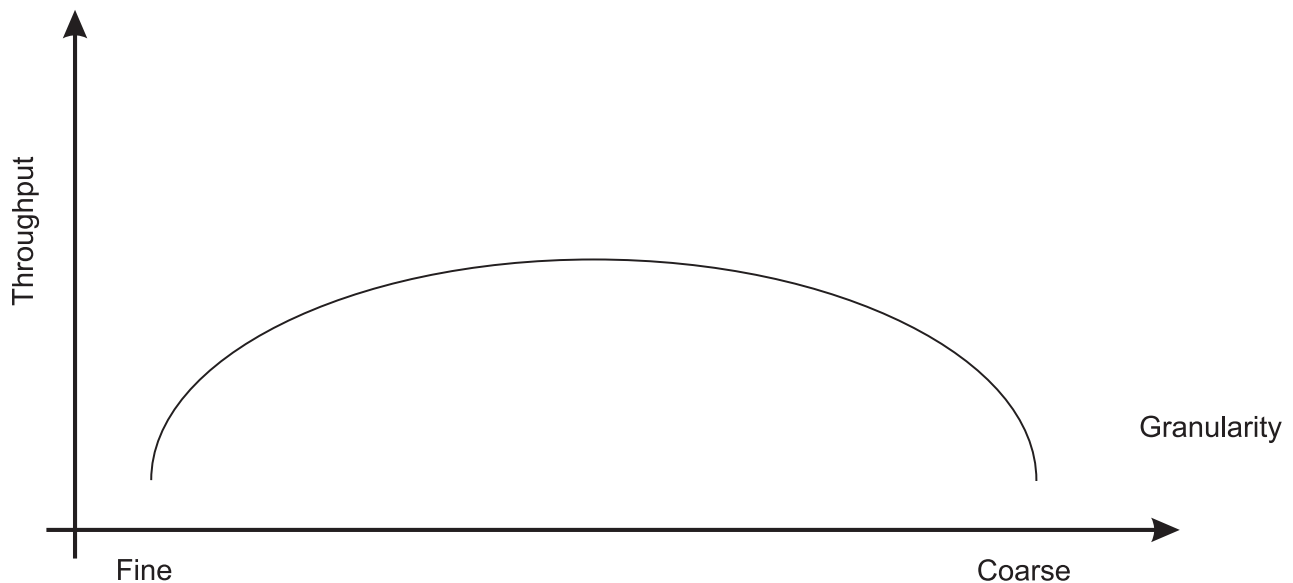

Figure 12. Relationship Between Throughput and Granularity. This illustration is a simple two axis chart. The vertical, or y axis, represents throughput. The horizontal, or x axis, represents granularity going from fine to coarse as it moves out on the scale. An elongated bell curve shows the relationship of granularity on throughput. As granularity goes from fine to coarse, throughput gradually increases to a maximum level and then slowly starts to decline. It shows that a compromise in granularity is necessary to reach maximum throughput.

Locking Overhead

Requesting locks, waiting for locks, and releasing locks add processing overhead in several ways:

- A program that supports multiprocessing always does the same lock and unlock processing, even though it is running in a uniprocessor or is the only user in a multiprocessor system of the locks in question.
- When one thread requests a lock held by another thread, the requesting thread may spin for a while or be put to sleep and, if possible, another thread dispatched. This consumes processor time.
- The existence of widely used locks places an upper bound on the throughput of the system. For example, if a given program spends 20 percent of its execution time holding a mutual-exclusion lock, at most five instances of that program can run simultaneously, regardless of the number of processors in the system. In fact, even five instances would probably never be so nicely synchronized as to avoid waiting for one another (see Multiprocessor Throughput Scalability).

Waiting for Locks

When a thread wants a lock already owned by another thread, the thread is blocked and must wait until the lock becomes free. There are two different ways of waiting:

- Spin locks are suitable for locks that are held only for very short times. It allows the waiting thread to keep its processor, repeatedly checking the lock bit in a tight loop (spin) until the lock becomes free. Spinning results in increased CPU time (system time for kernel or kernel extension locks).
- Sleeping locks are suitable for locks that may be held for longer periods. The thread sleeps until the lock is free and is put back in the run queue when the lock becomes free. Sleeping results in more idle time.

Waiting always decreases system performance. If a spin lock is used, the processor is busy, but it is not doing useful work (not contributing to throughput). If a sleeping lock is used, the overhead of context switching and dispatching as well as the consequent increase in cache misses is incurred.

Operating system developers can choose between two types of locks: mutually exclusive simple locks that allow the process to spin and sleep while waiting for the lock to become available, and complex read-write locks that can spin and block the process while waiting for the lock to become available.

Conventions govern the rules about using locks. Neither hardware nor software has an enforcement or checking mechanism. Although using locks has made the AIX Version 4 "MP Safe," developers are responsible to define and implement an appropriate locking strategy to protect their own global data.

Cache Coherency

In designing a multiprocessor, engineers give considerable attention to ensuring cache coherency. They succeed; but cache coherency has a performance cost. We need to understand the problem being attacked:

If each processor has a cache that reflects the state of various parts of memory, it is possible that two or more caches may have copies of the same line. It is also possible that a given line may contain more than one lockable data item. If two threads make appropriately serialized changes to those data items, the result could be that both caches end up with different, incorrect versions of the line of memory. In other words, the system's state is no longer coherent because the system contains two different versions of what is supposed to be the content of a specific area of memory.

The solutions to the cache coherency problem usually include invalidating all but one of the duplicate lines when the line is modified. Although the hardware uses snooping logic to invalidate, without any software intervention, any processor whose cache line has been invalidated will have a cache miss, with its attendant delay, the next time that line is addressed.

Snooping is the logic used to resolve the problem of cache consistency. Snooping logic in the processor broadcasts a message over the bus each time a word in its cache has been modified. The snooping logic also snoops on the bus looking for such messages from other processors.

When a processor detects that another processor has changed a value at an address existing in its own cache, the snooping logic invalidates that entry in its cache. This is called *cross invalidate*. Cross invalidate reminds the processor that the value in the cache is not valid, and it must look for the correct value somewhere else (memory or other cache). Since cross invalidates increase cache misses and the snooping protocol adds to the bus traffic, solving the cache consistency problem reduces the performance and scalability of all SMPs.

Processor Affinity and Binding

If a thread is interrupted and later redispached to the same processor, the processor's cache might still contain lines that belong to the thread. If the thread is dispatched to a different processor, it will probably experience a series of cache misses until its cache working set has been retrieved from RAM or the other processor's cache. On the other hand, if a dispatchable thread has to wait until the processor that it was previously running on is available, the thread may experience an even longer delay.

Processor affinity is the probability of dispatching of a thread to the processor that was previously executing it. The degree of emphasis on processor affinity should vary directly with the size of the thread's cache working set and inversely with the length of time since it was last dispatched. The AIX Version 4 dispatcher enforces affinity with the processors, so affinity is done implicitly by the operating system.

The highest possible degree of processor affinity is to bind a thread to a specific processor. Binding means that the thread will be dispatched to that processor only, regardless of the availability of other processors. The **bindprocessor** command and the **bindprocessor()** subroutine bind the thread (or threads) of a specified process to a particular processor (see The bindprocessor Command). Explicit binding is inherited through **fork()** and **exec()** system calls.

The binding can be useful for CPU-intensive programs that experience few interrupts. It can sometimes be counterproductive for ordinary programs, because it may delay the redispach of a thread after an I/O until the processor to which the thread is bound becomes available. If the thread has been blocked for the duration of an I/O operation, it is unlikely that much of its processing context remains in the caches of the processor to which it is bound. The thread would probably be better served if it were dispatched to the next available processor.

Memory and Bus Contention

In a uniprocessor, contention for some internal resources, such as banks of memory and I/O or memory buses, is usually a minor component using time. In a multiprocessor, these effects can become more significant, particularly if cache-coherency algorithms add to the number of accesses to RAM.

SMP Performance Issues

To effectively use an SMP, take the following into account when you are attempting to enhance performance:

Workload Concurrency

The primary performance issue that is unique to SMP systems is workload concurrency, which can be expressed as, "Now that we have n processors, how do we keep them all usefully employed"? If only one processor in a four-way multiprocessor system is doing useful work at any given time, it is no better than a uniprocessor. It could possibly be worse, because of the extra code to avoid interprocessor interference.

Workload concurrency is the complement of serialization. To the extent that the system software or the application workload (or the interaction of the two) require serialization, workload concurrency suffers.

Workload concurrency may also be decreased, more desirably, by increased processor affinity. The improved cache efficiency gained from processor affinity may result in quicker completion of the program. Workload concurrency is reduced (unless there are more dispatchable threads available), but response time is improved.

A component of workload concurrency, *process concurrency*, is the degree to which a multithreaded process has multiple dispatchable threads at all times.

Throughput

The throughput of an SMP system is mainly dependent on:

- A consistently high level of workload concurrency. More dispatchable threads than processors at certain times cannot compensate for idle processors at other times.
- The amount of lock contention.
- The degree of processor affinity.

Response Time

The response time of a particular program in an SMP system is dependent on:

- The process-concurrency level of the program. If the program consistently has two or more dispatchable threads, its response time will probably improve in an SMP environment. If the program consists of a single thread, its response time will be, at best, comparable to that in a uniprocessor of the same speed.
- The amount of lock contention of other instances of the program or with other programs that use the same locks.
- The degree of processor affinity of the program. If each dispatch of the program is to a different processor that has none of the program's cache lines, the program may run more slowly than in a comparable uniprocessor.

SMP Workloads

The effect of additional processors on performance is dominated by certain characteristics of the specific workload being handled. This section discusses those critical characteristics and their effects.

The following terms are used to describe the extent to which an existing program has been modified, or a new program designed, to operate in an SMP environment:

SMP safe

Avoidance in a program of any action, such as unserialized access to shared data, that would cause functional problems in an SMP environment. This term, when used alone, usually refers to a program that has undergone only the minimum changes necessary for correct functioning in an SMP environment.

SMP efficient

Avoidance in a program of any action that would cause functional or performance problems in an SMP environment. A program that is described as SMP-efficient is SMP-safe as well. An SMP-efficient program has usually undergone additional changes to minimize incipient bottlenecks.

SMP exploiting

Adding features to a program that are specifically intended to make effective use of an SMP environment, such as multithreading. A program that is described as SMP-exploiting is generally assumed to be SMP-safe and SMP-efficient as well.

Workload Multiprocessing

Multiprogramming operating systems running heavy workloads on fast computers give our human senses the impression that several things are happening simultaneously. In fact, many demanding workloads do

not have large numbers of dispatchable threads at any given instant, even when running on a single-processor system where serialization is less of a problem. Unless there are always at least as many dispatchable threads as there are processors, one or more processors will be idle part of the time.

The number of dispatchable threads is the total number of threads in the system

- Minus the number of threads that are waiting for I/O,
- Minus the number of threads that are waiting for a shared resource,
- Minus the number of threads that are waiting for the results of another thread,
- Minus the number of threads that are sleeping at their own request.

A workload can be said to be multiprocessable to the extent that it presents at all times as many dispatchable threads as there are processors in the system. Note that this does not mean simply an average number of dispatchable threads equal to the processor count. If the number of dispatchable threads is zero half the time and twice the processor count the rest of the time, the average number of dispatchable threads will equal the processor count, but any given processor in the system will be working only half the time.

Increasing the multiprocessability of a workload involves one or both of the following:

- Identifying and resolving any bottlenecks that cause threads to wait
- Increasing the total number of threads in the system

These solutions are not independent. If there is a single, major system bottleneck, increasing the number of threads of the existing workload that pass through the bottleneck will simply increase the proportion of threads waiting. If there is not currently a bottleneck, increasing the number of threads may create one.

Multiprocessor Throughput Scalability

Real workloads do not scale perfectly on an SMP system. Some factors that inhibit perfect scaling are as follows:

- Bus/switch contention increases while the number of processors increases
- Memory contention increases (all the memory is shared by all the processors)
- Increased cost of cache misses as memory gets farther away
- Cache cross-invalidates and reads from another cache to maintain cache coherency
- Increased cache misses because of higher dispatching rates (more processes/threads need to be dispatched on the system)
- Increased cost of synchronization instructions
- Increased cache misses because of larger operating system and application data structures
- Increased operating system and application path lengths for lock-unlock
- Increased operating system and application path lengths waiting for locks

All of these factors contribute to what is called the *scalability* of a workload. Scalability is the degree to which workload throughput benefits from the availability of additional processors. It is usually expressed as the quotient of the throughput of the workload on a multiprocessor divided by the throughput on a comparable uniprocessor. For example, if a uniprocessor achieved 20 requests per second on a given workload and a four-processor system achieved 58 requests per second, the scaling factor would be 2.9. That workload is highly scalable. A workload that consisted exclusively of long-running, compute-intensive programs with negligible I/O or other kernel activity and no shared data might approach a scaling factor of 3.2 to 3.9 on a 4-way system. However, most real-world workloads would not. Because scalability is very difficult to estimate, scalability assumptions should be based on measurements of authentic workloads.

The following figure illustrates the problems of scaling. The workload consists of a series of hypothetical commands. Each command is about one-third normal processing, one-third I/O wait, and one-third processing with a lock held. On the uniprocessor, only one command can actually be processing at a time,

regardless of whether the lock is held. In the time interval shown (five times the standalone execution time of the command), the uniprocessor handles 7.67 of the commands.

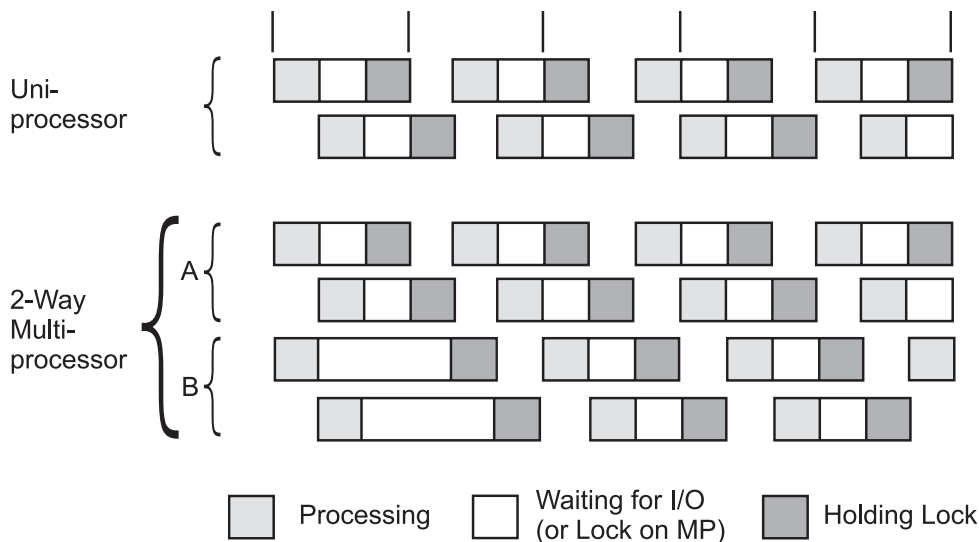

Figure 13. Multiprocessor Scaling. This figure illustrates the problems of scaling. The workload consists of a series of hypothetical commands. Each command is about one-third normal processing, one-third I/O wait, and one-third processing with a lock held. On the uniprocessor, only one command can actually be processing at a time, regardless of whether the lock is held. In the same time interval, the uniprocessor handles 7.67 of the commands. In that same period, the multiprocessor handles 14 commands for a scaling factor of 1.83..

On the multiprocessor, two processors handle program execution, but there is still only one lock. For simplicity, all of the lock contention is shown affecting processor B. In the period shown, the multiprocessor handles 14 commands. The scaling factor is thus 1.83. We stop at two processors because more would not change the situation. The lock is now in use 100 percent of the time. In a four-way multiprocessor, the scaling factor would be 1.83 or less.

Real programs are seldom as symmetrical as the commands in the illustration. In addition we have only taken into account one dimension of contention: locking. If we had included cache-coherency and processor-affinity effects, the scaling factor would almost certainly be lower.

This example illustrates that workloads often cannot be made to run faster simply by adding processors. It is also necessary to identify and minimize the sources of contention among the threads.

Scaling is workload-dependent. Some published benchmark results imply that high levels of scalability are easy to achieve. Most such benchmarks are constructed by running combinations of small, CPU-intensive programs that use almost no kernel services. These benchmark results represent an upper bound on scalability, not a realistic expectation.

Another interesting point to note for benchmarks is that in general, a one-way SMP will run slower (about 5-15 percent) than the equivalent uniprocessor running the UP version of the operating system.

Multiprocessor Response Time

A multiprocessor can only improve the execution time of an individual program to the extent that the program can run in multithreaded mode. There are several ways to achieve parallel execution of parts of a single program:

- Making explicit calls to **libpthreads.a** subroutines (or, in older programs, to the **fork()** subroutine) to create multiple threads that run simultaneously.

- Processing the program with a parallelizing compiler or preprocessor that detects sequences of code that can be executed simultaneously and generates multiple threads to run them in parallel.
- Using a software package that is itself multithreaded.

Unless one or more of these techniques is used, the program will run no faster in a multiprocessor system than in a comparable uniprocessor. In fact, because it may experience more locking overhead and delays due to being dispatched to different processors at different times, it may be slower.

Even if all of the applicable techniques are exploited, the maximum improvement is limited by a rule that has been called Amdahl's Law:

- If a fraction x of a program's uniprocessor execution time, t , can only be processed sequentially, the improvement in execution time in an n -way multiprocessor over execution time in a comparable uniprocessor (the speed-up) is given by the equation:

$$\text{speed up} = \frac{\text{uniprocessor time}}{\text{seq time} + \text{mp time}} = \frac{t}{xt + \frac{(x-1)t}{n}} = \frac{1}{x + \frac{x}{n}}$$

$$\lim_{n \rightarrow \infty} \text{speed-up} = \frac{1}{x}$$

Figure 14. Amdahl's Law. Amdahl's Law says speed-up equals uniprocessor time divided by sequence time plus multiprocessor time or 1 divided by x plus $(x$ over n). Lim speed-up equals 1 divided by x and n equals infinity.

As an example, if 50 percent of a program's processing must be done sequentially, and 50 percent can be done in parallel, the maximum response-time improvement is less than a factor of 2 (in an otherwise-idle 4-way multiprocessor, it is at most 1.6).

SMP Thread Scheduling

Thread support divides program-execution control into two elements:

- A *process* is a collection of physical resources required to run the program, such as memory and access to files.
- A *thread* is the execution state of an instance of the program, such as the current contents of the instruction-address register and the general-purpose registers. Each thread runs within the context of a given process and uses that process's resources. Multiple threads can run within a single process, sharing its resources.

In the SMP environment, the availability of thread support makes it easier and less expensive to implement SMP-exploiting applications. Forking multiple processes to create multiple flows of control is cumbersome and expensive, because each process has its own set of memory resources and requires considerable system processing to set up. Creating multiple threads within a single process requires less processing and uses less memory.

Thread support exists at two levels:

- **libpthreads.a** support in the application program environment
- Kernel thread support

Although threads are normally a convenient and efficient mechanism to exploit multiprocessing, there are scalability limits associated with threads. Because threads share process resources and state, locking and serialization of these resources can sometimes limit scalability.

Default Scheduler Processing of Migrated Workloads

The division between processes and threads is invisible to existing programs. In fact, workloads migrated directly from earlier releases of the operating system create processes as they have always done. Each new process is created with a single thread (the initial thread) that contends for the CPU with the threads of other processes.

The default attributes of the initial thread, in conjunction with the new scheduler algorithms, minimize changes in system dynamics for unchanged workloads.

Priorities can be manipulated with the **nice** and **renice** commands and the **setpri()** and **setpriority()** system calls, as before. The scheduler allows a given thread to run for at most one time slice (normally 10 ms) before forcing it to yield to the next dispatchable thread of the same or higher priority. See Controlling Contention for the CPU for more detail.

Scheduling Algorithm Variables

Several variables affect the scheduling of threads. Some are unique to thread support; others are elaborations of process-scheduling considerations:

Priority

A thread's priority value is the basic indicator of its precedence in the contention for processor time.

Scheduler run queue position

A thread's position in the scheduler's queue of dispatchable threads reflects a number of preceding conditions.

Scheduling policy

This thread attribute determines what happens to a running thread at the end of the time slice.

Contention scope

A thread's contention scope determines whether it competes only with the other threads within its process or with all threads in the system. A pthread created with process contention scope is scheduled by the library, while those created with system scope are scheduled by the kernel. The library scheduler utilizes a pool of kernel threads to schedule pthreads with process scope. Generally, create pthreads with system scope, if they are performing I/O. Process scope is useful, when there is a lot of intra-process synchronizations. Contention scope is a **libpthread.a** concept.

Processor affinity

The degree to which affinity is enforced affects performance.

The combinations of these considerations can seem complex, but you can choose from three distinct approaches when you are managing a given process:

Default

The process has one thread, whose priority varies with CPU consumption and whose scheduling policy is SCHED_OTHER.

Process-level control

The process can have one or more threads, but the scheduling policy of those threads is left as the default SCHED_OTHER, which permits the use of the existing methods of controlling nice values and fixed priorities. All of these methods affect all of the threads in the process identically. If the **setpri()** subroutine is used, the scheduling policy of all of the threads in the process is set to SCHED_RR.

Thread-level control

The process can have one or more threads. The scheduling policy of these threads is set to SCHED_RR or SCHED_FIFO, as appropriate. The priority of each thread is fixed and is manipulated with thread-level subroutines.

The scheduling policies are described in Scheduling Policy for Threads.

Thread Tuning

User threads provide independent flow of control within a process. If the user threads need to access kernel services (such as system calls), the user threads will be serviced by associated kernel threads. User threads are provided in various software packages with the most notable being the pthreads shared library (**libpthreads.a**). With the libpthreads implementation, user threads sit on top of virtual processors (VP) which are themselves on top of kernel threads. A multithreaded user process can use one of two models, as follows:

1:1 Thread Model

The 1:1 model indicates that each user thread will have exactly one kernel thread mapped to it. This is the default model on AIX 4.1, AIX 4.2, and AIX 4.3. In this model, each user thread is bound to a VP and linked to exactly one kernel thread. The VP is not necessarily bound to a real CPU (unless binding to a processor was done). A thread which is bound to a VP is said to have system scope because it is directly scheduled with all the other user threads by the kernel scheduler.

M:N Thread Model

The M:N model was implemented in AIX 4.3.1 and is also now the default model. In this model, several user threads can share the same virtual processor or the same pool of VPs. Each VP can be thought of as a virtual CPU available for executing user code and system calls. A thread which is not bound to a VP is said to be a local or process scope because it is not directly scheduled with all the other threads by the kernel scheduler. The pthreads library will handle the scheduling of user threads to the VP and then the kernel will schedule the associated kernel thread. As of AIX 4.3.2, the default is to have one kernel thread mapped to eight user threads. This is tunable from within the application or through an environment variable.

Thread Environment Variables

Within the **libpthreads.a** framework, a series of tuning knobs have been provided that might impact the performance of the application. If possible, the application developer should provide a front-end shell script to invoke the binary executable programs, in which the developer may specify new values to override the system defaults. These environment variables are as follows:

AIXTHREAD_COND_DEBUG (AIX 4.3.3 and subsequent versions)

The AIXTHREAD_COND_DEBUG variable maintains a list of condition variables for use by the debugger. If the program contains a large number of active condition variables and frequently creates and destroys condition variables, this may create higher overhead for maintaining the list of condition variables. Setting the variable to **OFF** will disable the list. Leaving this variable turned on makes debugging threaded applications easier, but may impose some overhead.

AIXTHREAD_ENRUSG

The AIXTHREAD_ENRUSG variable enables or disables the pthread resource collection. Turning it on allows for resource collection of all pthreads in a process, but will impose some overhead.

AIXTHREAD_GUARDPAGES=n

For AIX 4.3 and later:

```
*      +-----+
*      | pthread attr |
*      +-----+ <--- pthread->pt_attr
*      | pthread struct |
*      +-----+ <--- pthread->pt_stk.st_limit
*      | pthread stack |
*      |   |           |
*      |   v           |
*      +-----+ <--- pthread->pt_stk.st_base
*      | RED ZONE   |
*      +-----+
```

```

*      +-----+ <--- pthread->pt_guardaddr
*      | pthread private data |
*      +-----+ <--- pthread->pt_data

```

The RED ZONE on this illustration is called the Guardpage.

Starting with AIX 5.2, the pthread attr, pthread, and ctx represent the PTH_FIXED part of the memory allocated for a pthread.

The approximate byte sizes in the diagram below are in [] for 32-bit. For 64-bit, expect the pieces comprising PTH_FIXED to be slightly larger and the key data to be 8 Kb, but otherwise the same.

```

*      +-----+
*      | page alignment 2 |
*      | [8K-4K+PTH_FIXED-a1] |
*      +-----+
*      | pthread ctx [368] |
*      +-----+ <--- pthread->pt_attr
*      | pthread attr [112] | <--- pthread->pt_attr
*      +-----+ <--- pthread
*      | pthread struct [960] | pthread->pt_stk.st_limit
*      +-----+
*      | pthread stack |
*      | | [96K+4K-PTH_FIXED] |
*      | | v |
*      +-----+ <--- pthread->pt_stk.st_base
*      | RED ZONE [4K] | <--- pthread->pt_guardaddr
*      +-----+ <--- pthread->pt_data
*      | pthread key data [4K] |
*      +-----+
*      | page alignment 1 (a1) |
*      | [<4K] |
*      +-----+

```

The RED ZONE on this illustration is called the Guardpage.

The decimal number of guard pages to add to the end of the pthread stack is *n*. It overrides the attribute values that are specified at pthread creation time. If the application specifies its own stack, no guard pages are created. The default is 0 and *n* must be a positive value.

The guardpage size in bytes is determined by multiplying *n* by the PAGESIZE. Pagesize is a system determined size.

AIXTHREAD_MNRATIO (AIX 4.3 and later)

The AIXTHREAD_MNRATIO variable controls the scaling factor of the library. This ratio is used when creating and terminating pthreads. It may be useful for applications with a very large number of threads. However, always test a ratio of 1:1 because it may provide for better performance.

AIXTHREAD_MUTEX_DEBUG (AIX 4.3.3 and later)

The AIXTHREAD_MUTEX_DEBUG variable maintains a list of active mutexes for use by the debugger. If the program contains a large number of active mutexes and frequently creates and destroys mutexes, this may create higher overhead for maintaining the list of mutexes. Setting the variable to ON makes debugging threaded applications easier, but may impose the additional overhead. Leaving the variable off will disable the list.

AIXTHREAD_READ_GUARDPAGES (AIX 5.3 with 5300-03 and later)

The AIXTHREAD_READ_GUARDPAGES variable enables or disables read access to the guard pages that are added to the end of the pthread stack. For more information about guard pages that are created by the pthread, see "AIXTHREAD_GUARDPAGES=*n*" on page 67.

AIXTHREAD_RWLOCK_DEBUG (AIX 4.3.3 and later)

Maintains a list of read-write locks for use by the debugger. If the program contains a large number of active read-write locks and frequently creates and destroys read-write locks, this may create higher overhead for maintaining the list of read-write locks. Setting the variable to OFF will disable the list.

AIXTHREAD_SCOPE={PIS} (AIX 4.3.1 and later)

P signifies process-wide contention scope (M:N) and *S* signifies system-wide contention scope (1:1). Either *P* or *S* should be specified and the current default is process-wide scope.

The use of this environment variable impacts only those threads created with the default attribute. The default attribute is employed, when the *attr* parameter to the **pthread_create()** subroutine is NULL.

If a user thread is created with system-wide scope, it is bound to a kernel thread and it is scheduled by the kernel. The underlying kernel thread is not shared with any other user thread.

If a user thread is created with process-wide scope, it is subject to the user scheduler. It does not have a dedicated kernel thread; it sleeps in user mode; it is placed on the user run queue when it is waiting for a processor; and it is subjected to time slicing by the user scheduler.

Tests on AIX 4.3.2 have shown that certain applications can perform much better with the 1:1 model.

AIXTHREAD_SLPRATIO (AIX 4.3 and later)

This thread tuning variable controls the number of kernel threads that should be held in reserve for sleeping threads. In general, fewer kernel threads are required to support sleeping pthreads because they are generally woken one at a time. This conserves kernel resources.

AIXTHREAD_STK=*n* (AIX 4.3.3 ML 09 and AIX 5.1.1)

The decimal number number of bytes that should be allocated for each pthread. This value may be overridden by **pthread_attr_setstacksize**.

MALLOCBUCKETS

Malloc buckets provides an optional buckets-based extension of the default allocator. It is intended to improve malloc performance for applications that issue large numbers of small allocation requests. When malloc buckets is enabled, allocation requests that fall within a predefined range of block sizes are processed by malloc buckets. All other requests are processed in the usual manner by the default allocator.

Malloc buckets is not enabled by default. It is enabled and configured prior to process startup by setting the **MALLOCTYPE** and **MALLOCBUCKETS** environment variables.

For more information on mallos buckets, see General Programming Concepts: Writing and Debugging Programs.

MALLOCMULTIHEAP={considersize,heaps:*n*} (AIX 4.3.1 and later)

Multiple heaps are required so that a threaded application can have more than one thread issuing **malloc()**, **free()**, and **realloc()** subroutine calls. With a single heap, all threads trying to do a **malloc()**, **free()**, or **realloc()** call would be serialized (that is only one thread can do malloc/free/realloc at a time). The result is a serious impact on multi-processor machines. With multiple heaps, each thread gets its own heap. If all heaps are being used then any new threads trying to malloc/free/realloc will have to wait (that is serialize) until one or more of the heaps becomes available again. We still have serialization, but its likelihood and impact are greatly reduced.

The thread-safe locking has been changed to handle this approach. Each heap has its own lock, and the locking routine "intelligently" selects a heap to try to prevent serialization. If **considersize** is set in the **MALLOCMULTIHEAP** environment variable, then the selection will also try to select any available heap that has enough free space to handle the request instead of just selecting the next unlocked heap.

More than one option can be specified (and in any order) as long as they are comma-separated, for example, **MALLOCMULTIHEAP=considersize,heaps:3**. The options are:

heaps:*n*

The number of heaps used can be changed with this option. If *n* is not valid (that is, $n \leq 0$ or $n > 32$), 32 is used.

considersize

Uses a different heap-selection algorithm that tries to minimize the working set size of the process. The default is not to consider it and use the faster algorithm.

The default for **MALLOCMULTIHEAP** is NOT SET™ (only the first heap is used). If the environment variable **MALLOCMULTIHEAP** is set (for example, **MALLOCMULTIHEAP=1**) then the threaded application will be able to use all of the 32 heaps. Setting **MALLOCMULTIHEAP=heaps:*n*** will limit the number of heaps to *n* instead of the 32 heaps.

For more information, see the Malloc Multiheap section in *AIX 5L Version 5.3 General Programming Concepts: Writing and Debugging Programs*.

SPINLOOPTIME=*n*

Controls the number of times that the system will try to get a busy mutex or spin lock without taking a secondary action such as calling the kernel to yield the process. This control is intended for MP systems, where it is hoped that the lock being held by another actively running pthread will be released. The parameter works only within libpthreads (user threads). The **MAXSPIN** kernel parameter affects spinning in the kernel lock routines (see Use of the schedo command to modify the MAXSPIN parameter). If locks are usually available within a short amount of time, you may want to increase the spin time by setting this environment variable. The number of times to retry a busy lock before yielding to another pthread is *n*. The default is 40 and *n* must be a positive value.

YIELDLOOPTIME=*n*

Controls the number of times that the system yields the processor when trying to acquire a busy mutex or spin lock before actually going to sleep on the lock. The processor is yielded to another kernel thread, assuming there is another runnable one with sufficient priority. This variable has been shown to be effective in complex applications, where multiple locks are in use. The number of times to yield the processor before blocking on a busy lock is *n*. The default is 0 and *n* must be a positive value.

Variables for Process-Wide Contention Scope

The following environment variables impact the scheduling of pthreads created with process-wide contention scope.

AIXTHREAD_MNRATIO=*p:k*

where *k* is the number of kernel threads that should be employed to handle *p* runnable pthreads. This environment variable controls the scaling factor of the library. This ratio is used when creating and terminating pthreads. The variable is only valid with process-wide scope; with system-wide scope, this environment variable is ignored. The default setting is 8:1.

AIXTHREAD_SLPRATIO=*k:p*

where *k* is the number of kernel threads that should be held in reserve for *p* sleeping pthreads. The sleep ratio is the number of kernel threads to keep on the side in support of sleeping pthreads. In general, fewer kernel threads are required to support sleeping pthreads, since they are generally woken one at a time. This conserves kernel resources. Any positive integer value may be specified for *p* and *k*. If $k > p$, then the ratio is treated as 1:1. The default is 1:12.

AIXTHREAD_MINKTHREADS=*n*

where *n* is the minimum number of kernel threads that should be used. The library scheduler will not reclaim kernel threads below this figure. A kernel thread may be reclaimed at virtually any point. Generally, a kernel thread is targeted for reclaim as a result of a pthread terminating. The default is 8.

Thread Debug Options

The pthreads library maintains a list of active mutexes, condition variables, and read-write locks for use by the debugger.

When a lock is initialized, it is added to the list, assuming that it is not already on the list. The list is held as a linked list, so determining that a new lock is not already on the list has a performance implication when the list gets large. The problem is compounded by the fact that the list is protected by a lock (`dbx__mutexes`), which is held across the search of the list. In this case other calls to the `pthread_mutex_init()` subroutine are held while the search is done.

If the following environment variables are set to OFF, which is the default, then the appropriate debugging list will be disabled completely. That means the `dbx` command (or any debugger using the pthread debug library) will show no objects in existence.

- `AIXTHREAD_MUTEX_DEBUG`
- `AIXTHREAD_COND_DEBUG`
- `AIXTHREAD_RWLOCK_DEBUG`

To set any of these environment variables to ON, use the following command:

```
# export variable_name=ON
```

Thread Tuning Summary

Depending on the type of application, the administrator can choose to use a different thread model. Tests on AIX 4.3.2 have shown that certain applications can perform much better with the 1:1 model. This is an important point because the default as of AIX 4.3.1 is M:N. By simply setting the environment variable `AIXTHREAD_SCOPE=S` for that process, we can set the thread model to 1:1 and then compare the performance to its previous performance when the thread model was M:N.

If you see an application creating and deleting threads, it could be the kernel threads are being *harvested* because of the 8:1 default ratio of user threads to kernel threads. This harvesting along with the overhead of the library scheduling can affect the performance. On the other hand, when thousands of user threads exist, there may be less overhead to schedule them in user space in the library rather than manage thousands of kernel threads. You should always try changing the scope if you encounter a performance problem when using pthreads; in many cases, the system scope can provide better performance.

If an application is running on an SMP system, then if a user thread cannot acquire a mutex, it will attempt to spin for up to 40 times. It could easily be the case that the mutex was available within a short amount of time, so it may be worthwhile to spin for a longer period of time. As you add more CPUs, if the performance goes down, this usually indicates a locking problem. You might want to increase the spin time by setting the environment variable `SPINLOOPTIME=n`, where *n* is the number of spins. It is not unusual to set the value as high as in the thousands depending on the speed of the CPUs and the number of CPUs. Once the spin count has been exhausted, the thread can go to sleep waiting for the mutex to become available or it can issue the `yield()` system call and simply give up the CPU but stay in a runnable state rather than going to sleep. By default, it will go to sleep, but by setting the `YIELDLOOPTIME` environment variable to a number, it will yield up to that many times before going to sleep. Each time it gets the CPU after it yields, it can try to acquire the mutex.

Certain multithreaded user processes that use the malloc subsystem heavily may obtain better performance by exporting the environment variable `MALLOCMULTIHEAP=1` before starting the application. The potential performance improvement is particularly likely for multithreaded C++ programs, because these may make use of the malloc subsystem whenever a constructor or destructor is called. Any available performance improvement will be most evident when the multithreaded user process is running on an SMP system, and particularly when system scope threads are used (M:N ratio of 1:1). However, in some cases, improvement may also be evident under other conditions, and on uniprocessors.

SMP Tools

All performance tools of the operating system support SMP machines. Some performance tools provide individual processor utilization statistics. Other performance tools average out the utilization statistics for all processors and display only the averages.

This section describes the tools that are only supported on SMP. For details on all other performance tools, see the appropriate chapters.

The `bindprocessor` Command

Use the `bindprocessor` command to bind or unbind the kernel threads of a process to a processor. Root authority is necessary to bind or unbind threads in processes that you do not own.

Note: The `bindprocessor` command is meant for multiprocessor systems. Although it will also work on uniprocessor systems, binding has no effect on such systems.

To query the available processors, run the following:

```
# bindprocessor -q
The available processors are: 0 1 2 3
```

The output shows the logical processor numbers for the available processors, which are used with the `bindprocessor` command as will be seen.

To bind a process whose PID is 14596 to processor 1, run the following:

```
# bindprocessor 14596 1
```

No return message is given if the command was successful. To verify if a process is bound or unbound to a processor, use the `ps -mo THREAD` command as explained in Using the `ps` Command:

```
# ps -mo THREAD
USER  PID  PPID   TID ST  CP PRI SC   WCHAN      F    TT  BND  COMMAND
root  3292  7130   -  A   1  60  1      -    240001 pts/0 -  -ksh
-    -    -    14309 S   1  60  1      -     400   -  -  -
root  14596  3292   -  A   73 100  1      -    200001 pts/0  1  /tmp/cpubound
-    -    -    15629 R   73 100  1      -     0   -  1  -
root  15606  3292   -  A   74 101  1      -    200001 pts/0 -  /tmp/cpubound
-    -    -    16895 R   74 101  1      -     0   -  -  -
root  16634  3292   -  A   73 100  1      -    200001 pts/0 -  /tmp/cpubound
-    -    -    15107 R   73 100  1      -     0   -  -  -
root  18048  3292   -  A   14  67  1      -    200001 pts/0 -  ps -mo THREAD
-    -    -    17801 R   14  67  1      -     0   -  -  -
```

The column `BND` shows the number of the processor that the process is bound to or a dash (-) if the process is not bound at all.

To unbind a process whose PID is 14596, use the following command:

```
# bindprocessor -u 14596
# ps -mo THREAD
USER  PID  PPID   TID ST  CP PRI SC   WCHAN      F    TT  BND  COMMAND
root  3292  7130   -  A   2  61  1      -    240001 pts/0 -  -ksh
-    -    -    14309 S   2  61  1      -     400   -  -  -
root  14596  3292   -  A  120 124  1      -    200001 pts/0 -  /tmp/cpubound
-    -    -    15629 R  120 124  1      -     0   -  -  -
root  15606  3292   -  A  120 124  1      -    200001 pts/0 -  /tmp/cpubound
-    -    -    16895 R  120 124  1      -     0   -  -  -
root  16634  3292   -  A  120 124  0      -    200001 pts/0 -  /tmp/cpubound
-    -    -    15107 R  120 124  0      -     0   -  -  -
root  18052  3292   -  A   12  66  1      -    200001 pts/0 -  ps -mo THREAD
-    -    -    17805 R   12  66  1      -     0   -  -  -
```

When the **bindprocessor** command is used on a process, all of its threads will then be bound to one processor and unbound from their former processor. Unbinding the process will also unbind all its threads. You cannot bind or unbind an individual thread using the **bindprocessor** command.

However, within a program, you can use the **bindprocessor()** function call to bind individual threads. If the **bindprocessor()** function is used within a piece of code to bind threads to processors, the threads remain with these processors and cannot be unbound. If the **bindprocessor** command is used on that process, all of its threads will then be bound to one processor and unbound from their respective former processors. An unbinding of the whole process will also unbind all the threads.

A process cannot be bound until it is started; that is, it must exist in order to be bound. When a process does not exist, the following error displays:

```
# bindprocessor 7359 1
1730-002: Process 7359 does not match an existing process
```

When a processor does not exist, the following error displays:

```
# bindprocessor 7358 4
1730-001: Processor 4 is not available
```

Note: Do not use the **bindprocessor** command on the wait processes **kproc**.

Binding considerations

Binding can be useful for CPU-intensive programs that experience few interrupts. It can sometimes be counterproductive for ordinary programs because it may delay the redispach of a thread after an I/O until the processor to which the thread is bound becomes available. If the thread has been blocked for the duration of an I/O operation, it is unlikely that much of its processing context remains in the caches of the processor to which it is bound. The thread would probably be better served if it were dispatched to the next available processor.

Binding does not prevent other processes from being dispatched on the processor on which you bound your process. Binding is different from partitioning. Without Workload Manager (WLM), introduced in AIX 4.3.3, it is not possible to dedicate a set of processors to a specific workload and another set of processors to another workload. Therefore, a higher priority process might be dispatched on the processor where you bound your process. In this case, your process will not be dispatched on other processors, and therefore, you will not always increase the performance of the bound process. Better results may be achieved if you increase the priority of the bound process.

If you bind a process on a heavily loaded system, you might decrease its performance because when a processor becomes idle, the process will not be able to run on the idle processor if it is not the processor on which the process is bound.

If the process is multithreaded, binding the process will bind all its threads to the same processor. Therefore, the process does not take advantage of the multiprocessing, and performance will not be improved.

Note: Use process binding with care, because it disrupts the natural load balancing provided by AIX Version 4, and the overall performance of the system could degrade. If the workload of the machine changes from that which is monitored when making the initial binding, system performance can suffer. If you use the **bindprocessor** command, take care to monitor the machine regularly because the environment might change, making the bound process adversely affect system performance.

Use of the **schedo** command to modify the **MAXSPIN** parameter

If a thread wants to acquire a lock when another thread currently owns that lock and is running on another CPU, the thread that wants the lock will spin on the CPU until the owner thread releases the lock up to a certain value as specified by a tunable parameter called **MAXSPIN**.

The default value of **MAXSPIN** is 0x4000 (16384) for SMP systems and at 1 on UP systems. If you notice more idle or I/O wait time on a system that had not shown this previously, it could be that threads are going to sleep more often. If this is causing a performance problem, then tune **MAXSPIN** such that it is a higher value or set to -1 which means to spin up to 0xFFFFFFFF times.

To revise the number of times to spin before going to sleep use the **maxspin** option of the **schedo** command. To reduce CPU usage that might be caused by excessive spins, reduce the value of **MAXSPIN** as follows:

```
# schedo -o maxspin=8192
```

You might observe an increase in context-switching. If context-switching becomes the bottleneck, increase **MAXSPIN**.

To change the value, you must be the root user.

Chapter 8. Planning and Implementing for Performance

A program that does not perform acceptably is not functional. Every program must satisfy a set of users, sometimes a large and diverse set. If the performance of the program is truly unacceptable to a significant number of those users, it will not be used. A program that is not being used is not performing its intended function.

This situation is true of licensed software packages as well as user-written applications, although most developers of software packages are aware of the effects of poor performance and take pains to make their programs run as fast as possible. Unfortunately, they cannot anticipate all of the environments and uses that their programs will experience. Final responsibility for acceptable performance falls on the people who select or write, plan for, and install software packages.

This chapter describes the stages by which a programmer or system administrator can ensure that a newly written or purchased program has acceptable performance. (Wherever the word *programmer* appears alone, the term includes system administrators and anyone else who is responsible for the ultimate success of a program.)

To achieve acceptable performance in a program, identify and quantify acceptability at the start of the project and never lose sight of the measures and resources needed to achieve it. Although this method sounds elementary, some programming projects consciously reject it. They adopt a policy that might be fairly described as design, code, debug, maybe document, and if we have time, fix the performance.

The only way that programs can predictably be made to function in time, not just in logic, is by integrating performance considerations in the software planning and development process. Advance planning is perhaps more critical when existing software is being installed, because the installer has less freedom than the developer.

Although the detail of this process might seem burdensome for a small program, remember that we have a second "agenda." Not only must the new program have satisfactory performance, we must also ensure that the addition of that program to an existing system does not degrade the performance of other programs run on that system.

This chapter includes the following major sections:

- Identifying the Components of the Workload
- Documenting Performance Requirements
- Estimating the Resource Requirements of the Workload
- Designing and Implementing Efficient Programs
- Using Performance-Related Installation Guidelines

Identifying the Components of the Workload

Whether the program is new or purchased, small or large, the developers, the installers, and the prospective users have assumptions about the use of the program, such as:

- Who will be using the program
- Situations in which the program will be run
- How often those situations will arise and at what times of the hour, day, month, or year
- Whether those situations will also require additional uses of existing programs
- Which systems the program will run on
- How much data will be handled, and from where
- Whether data created by or for the program will be used in other ways

Unless these ideas are elicited as part of the design process, they will probably be vague, and the programmers will almost certainly have different assumptions than the prospective users. Even in the apparently trivial case in which the programmer is also the user, leaving the assumptions unarticulated makes it impossible to compare design to assumptions in any rigorous way. Worse, it is impossible to identify performance requirements without a complete understanding of the work being performed.

Documenting Performance Requirements

In identifying and quantifying performance requirements, it is important to identify the reasoning behind a particular requirement. This is part of the general capacity planning process. Users might be basing their statements of requirements on assumptions about the logic of the program that do not match the programmer's assumptions. At a minimum, a set of performance requirements should document the following:

- The maximum satisfactory response time to be experienced most of the time for each distinct type of user-computer interaction, along with a definition of *most of the time*. Response time is measured from the time that the user performs the action that says "Go" until the user receives enough feedback from the computer to continue the task. It is the user's subjective wait time. It is not from entry to a subroutine until the first write statement.

If the user denies interest in response time and indicates that only the result is of interest, you can ask whether "ten times your current estimate of stand-alone execution time" would be acceptable. If the answer is "yes," you can proceed to discuss throughput. Otherwise, you can continue the discussion of response time with the user's full attention.

- The response time that is minimally acceptable the rest of the time. A longer response time can cause users to think the system is down. You also need to specify *rest of the time*; for example, the peak minute of a day, 1 percent of interactions. Response time degradations can be more costly or painful at a particular time of the day.
- The typical throughput required and the times it will be taking place. This is not a casual consideration. For example, the requirement for one program might be that it runs twice a day: at 10:00 a.m. and 3:15 p.m. If this is a CPU-limited program that runs for 15 minutes and is planned to run on a multiuser system, some negotiation is in order.
- The size and timing of maximum-throughput periods.
- The mix of requests expected and how the mix varies with time.
- The number of users per machine and total number of users, if this is a multiuser application. This description should include the times these users log on and off, as well as their assumed rates of keystrokes, completed requests, and think times. You may want to investigate whether think times vary systematically with the preceding and following request.
- Any assumptions that the user is making about the machines the workload will run on. If the user has a specific existing machine in mind, make sure you know that early on. Similarly, if the user is assuming a particular type, size, cost, location, interconnection, or any other variable that will constrain your ability to satisfy the preceding requirements, that assumption also becomes part of the requirements. Satisfaction will probably not be assessed on the system where the program is developed, tested, or first installed.

Estimating the resource requirements of the workload

Unless you are purchasing a software package that comes with detailed resource-requirement documentation, estimating resources can be the most difficult task in the performance-planning process. The difficulty has several causes, as follows:

- There are several ways to do any task. You can write a C (or other high-level language) program, a shell script, a **perl** script, an **awk** script, a **sed** script, an AIXwindows dialog, and so on. Some techniques that may seem particularly suitable for the algorithm and for programmer productivity are extraordinarily expensive from the performance perspective.

A useful guideline is that, the higher the level of abstraction, the more caution is needed to ensure that one does not receive a performance surprise. Consider carefully the data volumes and number of iterations implied by some apparently harmless constructs.

- The precise cost of a single process is difficult to define. This difficulty is not merely technical; it is philosophical. If multiple instances of a given program run by multiple users are sharing pages of program text, which process should be charged with those pages of memory? The operating system leaves recently used file pages in memory to provide a caching effect for programs that reaccess that data. Should programs that reaccess data be charged for the space that was used to retain the data? The granularity of some measurements such as the system clock can cause variations in the CPU time attributed to successive instances of the same program.

Two approaches deal with resource-report ambiguity and variability. The first is to ignore the ambiguity and to keep eliminating sources of variability until the measurements become acceptably consistent. The second approach is to try to make the measurements as realistic as possible and describe the results statistically. Note that the latter yields results that have some correlation with production situations.

- Systems are rarely dedicated to running a single instance of a single program. There are almost always daemons running, there is frequently communications activity, and often workload from multiple users. These activities seldom add up linearly. For example, increasing the number of instances of a given program may result in few new program text pages being used, because most of the program was already in memory. However, the additional processes may result in more contention for the processor's caches, so that not only do the other processes have to share processor time with the newcomer, but all processes may experience more cycles per instruction. This is, in effect, a slowdown of the processor, as a result of more frequent cache misses.

Make your estimate as realistic as the specific situation allows, using the following guidelines:

- If the program exists, measure the existing installation that most closely resembles your own requirements. The best method is to use a capacity planning tool such as BEST/1.
- If no suitable installation is available, do a trial installation and measure a synthetic workload.
- If it is impractical to generate a synthetic workload that matches the requirements, measure individual interactions and use the results as input to a simulation.
- If the program does not exist yet, find a comparable program that uses the same language and general structure, and measure it. Again, the more abstract the language, the more care is needed in determining comparability.
- If no comparable program exists, develop a prototype of the main algorithms in the planned language, measure the prototype, and model the workload.
- Only if measurement of any kind is impossible or infeasible should you make an educated guess. If it is necessary to guess at resource requirements during the planning stage, it is critical that the actual program be measured at the earliest possible stage of its development.

Keep in mind that independent software vendors (ISV) often have sizing guidelines for their applications.

In estimating resources, we are primarily interested in four dimensions (in no particular order):

CPU time

Processor cost of the workload

Disk accesses

Rate at which the workload generates disk reads or writes

LAN traffic

Number of packets the workload generates and the number of bytes of data exchanged

Real memory

Amount of RAM the workload requires

The following sections discuss how to determine these values in various situations.

Measuring workload resources

If the real program, a comparable program, or a prototype is available for measurement, the choice of technique depends on the following:

- Whether the system is processing other work in addition to the workload we want to measure.
- Whether we have permission to use tools that may degrade performance. For example, is this system in production or is it dedicated to our use for the duration of the measurement?
- The degree to which we can simulate or observe an authentic workload.

Measuring a complete workload on a dedicated system

Using a dedicated system is the ideal situation because we can use measurements that include system overhead as well as the cost of individual processes.

To measure overall system performance for most of the system activity, use the **vmstat** command:

```
# vmstat 5 >vmstat.output
```

This gives us a picture of the state of the system every 5 seconds during the measurement run. The first set of **vmstat** output contains the cumulative data from the last boot to the start of the **vmstat** command. The remaining sets are the results for the preceding interval, in this case 5 seconds. A typical set of **vmstat** output on a system looks similar to the following:

```
kthr      memory          page          faults          cpu
-----
 r  b  avm  fre  re  pi  po  fr  sr  cy  in  sy  cs  us  sy  id  wa
 0  1 75186 192  0  0  0  0  1  0 344 1998 403  6  2 92  0
```

To measure CPU and disk activity, use the **iostat** command:

```
# iostat 5 >iostat.output
```

This gives us a picture of the state of the system every 5 seconds during the measurement run. The first set of **iostat** output contains the cumulative data from the last boot to the start of the **iostat** command. The remaining sets are the results for the preceding interval, in this case 5 seconds. A typical set of **iostat** output on a system looks similar to the following:

```
tty:      tin          tout  avg-cpu:  % user  % sys  % idle  % iowait
          0.0          0.0          19.4    5.7    70.8    4.1

Disks:    % tm_act    Kbps    tps    Kb_read  Kb_wrtn
hdisk0    8.0        34.5    8.2    12       164
hdisk1    0.0        0.0    0.0    0        0
cd0       0.0        0.0    0.0    0        0
```

To measure memory, use the **svmon** command. The **svmon -G** command gives a picture of overall memory use. The statistics are in terms of 4 KB pages (example from AIX 5.2):

```
# svmon -G
```

```
          size      inuse      free      pin      virtual
memory   65527    65406    121     5963    74711
pg space 131072    37218

          work      pers      clnt      lpage
pin      5972      0        0        0
in use   54177    9023    2206     0
```

In this example, the machine's 256 MB memory is fully used. About 83 percent of RAM is in use for working segments, the read/write memory of running programs (the rest is for caching files). If there are long-running processes in which we are interested, we can review their memory requirements in detail. The following example determines the memory used by a process of user hoetzel.

```
# ps -fu hoetzel
  UID  PID  PPID  C   STIME   TTY  TIME CMD
hoetzel 24896 33604  0 09:27:35 pts/3 0:00 /usr/bin/ksh
hoetzel 32496 25350  6 15:16:34 pts/5 0:00 ps -fu hoetzel

# svmon -P 24896
```

```
-----
  Pid Command      Inuse   Pin    Pgspace  Virtual  64-bit  Mthrd  LPage
24896 ksh           7547   4045   1186     7486     N       N      N

  Vsid   Esid  Type  Description      LPage  Inuse   Pin Pgspace  Virtual
    0    0    work kernel seg      -     6324  4041 1186  6324
6a89aa  d    work shared library text -     1064   0    0  1064
72d3cb  2    work process private  -      75    4    0    75
401100  1    pers code,/dev/hd2:6250 -      59    0    -    -
 3d40f  f    work shared library data -      23    0    0    23
16925a -    pers /dev/hd4:447     -      2     0    -    -
```

The working segment (5176), with 4 pages in use, is the cost of this instance of the **ksh** program. The 2619-page cost of the shared library and the 58-page cost of the **ksh** program are spread across all of the running programs and all instances of the **ksh** program, respectively.

If we believe that our 256 MB system is larger than necessary, use the **rmss** command to reduce the effective size of the machine and remeasure the workload. If paging increases significantly or response time deteriorates, we have reduced memory too much. This technique can be continued until we find a size that runs our workload without degradation. See *Assessing Memory Requirements Through the rmss Command* for more information on this technique.

The primary command for measuring network usage is the **netstat** program. The following example shows the activity of a specific Token-Ring interface:

```
# netstat -I tr0 5
  input      (tr0)      output      input      (Total)      output
  packets  errs  packets  errs  colls  packets  errs  packets  errs  colls
35552822 213488 30283693    0    0  35608011 213488 30338882    0    0
   300    0    426    0    0    300    0    426    0    0
   272    2    190    0    0    272    2    190    0    0
   231    0    192    0    0    231    0    192    0    0
   143    0    113    0    0    143    0    113    0    0
   408    1    176    0    0    408    1    176    0    0
```

The first line of the report shows the cumulative network traffic since the last boot. Each subsequent line shows the activity for the preceding 5-second interval.

Measuring a complete Workload on a production system

The techniques of measurement on production systems are similar to those on dedicated systems, but we must be careful to avoid degrading system performance.

Probably the most cost-effective tool is the **vmstat** command, which supplies data on memory, I/O, and CPU usage in a single report. If the **vmstat** intervals are kept reasonably long, for example, 10 seconds, the average cost is relatively low. See *Identifying the performance-limiting resource* for more information on using the **vmstat** command.

Measuring a partial workload on a production system

By partial workload, we mean measuring a part of the production system's workload for possible transfer to or duplication on a different system. Because this is a production system, we must be as unobtrusive as possible. At the same time, we must analyze the workload in more detail to distinguish between the parts we are interested in and those we are not. To do a partial measurement, we must discover what the workload elements of interest have in common. Are they:

- The same program or a small set of related programs?

- Work performed by one or more specific users of the system?
- Work that comes from one or more specific terminals?

Depending on the commonality, we could use one of the following

```
# ps -ef | grep pgmname
# ps -fuusername, . . .
# ps -ftttyname, . . .
```

to identify the processes of interest and report the cumulative CPU time consumption of those processes. We can then use the **svmon** command (judiciously) to assess the memory use of the processes.

Measuring an individual program

Many tools are available for measuring the resource consumption of individual programs. Some of these programs are capable of more comprehensive workload measurements as well, but are too intrusive for use on production systems. Most of these tools are discussed in depth in the chapters that discuss tuning for minimum consumption of specific resources. Some of the more prominent are:

svmon

Measures the real memory used by a process. Discussed in Memory usage.

time Measures the elapsed execution time and CPU consumption of an individual program. Discussed in Using the time command to measure CPU use.

tprof Measures the relative CPU consumption of programs, subroutine libraries, and the operating system's kernel. Discussed in The tprof command section of the *AIX 5L Version 5.3 Performance Tools Guide and Reference*.

vmstat -s

Measures the I/O load generated by a program. Discussed in Assessing overall disk I/O with the vmstat command.

Estimating resources required by a new program

It is impossible to make precise estimates of unwritten programs. The invention and redesign that take place during the coding phase defy prediction, but the following guidelines can help you to get a general sense of the requirements. As a starting point, a minimal program would need the following:

- About 50 milliseconds of CPU time, mostly system time.
- Real Memory
 - One page for program text
 - About 15 pages (of which 2 are pinned) for the working (data) segment
 - Access to **libc.a**. Normally this is shared with all other programs and is considered part of the base cost of the operating system.
- About 12 page-in Disk I/O operations, if the program has not been compiled, copied, or used recently. Otherwise, none required.

To the above, add the basic cost allowances for demands implied by the design (the units given are for example purposes only):

- CPU time
 - The CPU consumption of an ordinary program that does not contain high levels of iteration or costly subroutine calls is almost immeasurably small.
 - If the proposed program contains a computationally expensive algorithm, develop a prototype and measure the algorithm.
 - If the proposed program uses computationally expensive library subroutines, such as X or Motif constructs or the **printf()** subroutine, measure their CPU consumption with otherwise trivial programs.
- Real Memory

- Allow approximately 350 lines of code per page of program text, which is about 12 bytes per line. Keep in mind that coding style and compiler options can make a difference of a factor or two in either direction. This allowance is for pages that are touched in your typical scenario. If your design places infrequently executed subroutines at the end of the executable program, those pages do not normally consume real memory.
- References to shared libraries other than **libc.a** increase the memory requirement only to the extent that those libraries are not shared with other programs or instances of the program being estimated. To measure the size of these libraries, write a trivial, long-running program that refers to them and use the **svmon -P** command against the process.
- Estimate the amount of storage that will be required by the data structures identified in the design. Round up to the nearest page.
- In the short run, each disk I/O operation will use one page of memory. Assume that the page has to be available already. Do not assume that the program will wait for another program's page to be freed.
- Disk I/O
 - For sequential I/O, each 4096 bytes read or written causes one I/O operation, unless the file has been accessed recently enough that some of its pages are still in memory.
 - For random I/O, each access, however small, to a different 4096-byte page causes one I/O operation, unless the file has been accessed recently enough that some of its pages are still in memory.
 - Each sequential read or write of a 4 KB page in a large file takes about 100 units. Each random read or write of a 4 KB page takes about 300 units. Remember that real files are not necessarily stored sequentially on disk, even though they are written and read sequentially by the program. Consequently, the typical CPU cost of an actual disk access will be closer to the random-access cost than to the sequential-access cost.
- Communications I/O
 - If disk I/O is actually to Network File System (NFS) remote-mounted file systems, the disk I/O is performed on the server, but the client experiences higher CPU and memory demands.
 - RPCs of any kind contribute substantially to the CPU load. The proposed RPCs in the design should be minimized, batched, prototyped, and measured in advance.
 - Each sequential NFS read or write of an 4 KB page takes about 600 units on the client. Each random NFS read or write of a 4 KB page takes about 1000 units on the client.
 - Web browsing and Web serving implies considerable network I/O, with TCP connections opening and closing quite frequently.

Transforming program-level estimates to workload estimates

The best method for estimating peak and typical resource requirements is to use a queuing model such as BEST/1. Static models can be used, but you run the risk of overestimating or underestimating the peak resource. In either case, you need to understand how multiple programs in a workload interact from the standpoint of resource requirements.

If you are building a static model, use a time interval that is the specified worst-acceptable response time for the most frequent or demanding program (usually they are the same). Determine which programs will typically be running during each interval, based on your projected number of users, their think time, their key entry rate, and the anticipated mix of operations.

Use the following guidelines:

- CPU time
 - Add together the CPU requirements for the all of the programs that are running during the interval. Include the CPU requirements of the disk and communications I/O the programs will be doing.
 - If this number is greater than 75 percent of the available CPU time during the interval, consider fewer users or more CPUs.

- Real Memory
 - The operating system memory requirement scales with the amount of physical memory. Start with 6 to 8 MB for the operating system itself. The lower figure is for a standalone system. The latter figure is for a system that is LAN-connected and uses TCP/IP and NFS.
 - Add together the working segment requirements of all of the instances of the programs that will be running during the interval, including the space estimated for the program's data structures.
 - Add to that total the memory requirement of the text segment of each distinct program that will be running (one copy of the program text serves all instances of that program). Remember that any (and only) subroutines that are from unshared libraries will be part of the executable program, but the libraries themselves will not be in memory.
 - Add to the total the amount of space consumed by each of the shared libraries that will be used by any program in the workload. Again, one copy serves all.
 - To allow adequate space for some file caching and the free list, your total memory projection should not exceed 80 percent of the size of the machine to be used.
- Disk I/O
 - Add the number of I/Os implied by each instance of each program. Keep separate totals for I/Os to small files (or randomly to large files) versus purely sequential reading or writing of large files (more than 32 KB).
 - Subtract those I/Os that you believe will be satisfied from memory. Any record that was read or written in the previous interval is probably still available in the current interval. Beyond that, examine the size of the proposed machine versus the total RAM requirements of the machine's workload. Any space remaining after the operating system's requirement and the workload's requirements probably contains the most recently read or written file pages. If your application's design is such that there is a high probability that you will reuse recently accessed data, you can calculate an allowance for the caching effect. Remember that the reuse is at the page level, not at the record level. If the probability of reuse of a given record is low, but there are a lot of records per page, it is likely that some of the records needed in any given interval will fall in the same page as other, recently used, records.
 - Compare the net I/O requirements (disk I/Os per second per disk) to the approximate capabilities of current disk drives. If the random or sequential requirement is greater than 75 percent of the total corresponding capability of the disks that will hold application data, tuning (and possibly expansion) will be needed when the application is in production.
- Communications I/O
 - Calculate the bandwidth consumption of the workload. If the total bandwidth consumption of all of the nodes on the LAN is greater than 70 percent of nominal bandwidth (50 percent for Ethernet), you might want to use a network with higher bandwidth.
 - Perform a similar analysis of CPU, memory, and I/O requirements of the added load that will be placed on the server.

Note: Remember that these guidelines are intended for use *only* when no extensive measurement is possible. Any application-specific measurement that can be used in place of a guideline will considerably improve the accuracy of the estimate.

Designing and Implementing Efficient Programs

If you have determined which resource will limit the speed of your program, you can go directly to the section that discusses appropriate techniques for minimizing the use of that resource. Otherwise, assume that the program will be balanced and that all of the recommendations in this chapter apply. Once the program is implemented, proceed to Identifying the Performance-Limiting Resource.

CPU-Limited Programs

The maximum speed of a truly processor-limited program is determined by:

- The algorithm used

- The source code and data structures created by the programmer
- The sequence of machine-language instructions generated by the compiler
- The sizes and structures of the processor's caches
- The architecture and clock rate of the processor itself (see Appendix D. Determining CPU Speed)

If the program is CPU-limited because it consists almost entirely of numerical computation, the chosen algorithm will have a major effect on the performance of the program. A discussion of alternative algorithms is beyond the scope of this book. It is assumed that computational efficiency has been considered in choosing the algorithm.

Given an algorithm, the only items in the preceding list that the programmer can affect are the source code, the compiler options used, and possibly the data structures. The following sections deal with techniques that can be used to improve the efficiency of an individual program for which the user has the source code. If the source code is not available, attempt to use tuning or workload-management techniques.

Design and Coding for Effective Use of Caches

In Performance Concepts, we indicated that processors have a multilevel hierarchy of memory:

1. Instruction pipeline and the CPU registers
2. Instruction and data cache(s) and the corresponding translation lookaside buffers
3. RAM
4. Disk

As instructions and data move up the hierarchy, they move into storage that is faster than the level below it, but also smaller and more expensive. To obtain the maximum possible performance from a given machine, therefore, the programmer must make the most effective use of the available storage at each level.

Effective use of storage means keeping it full of instructions and data that are likely to be used. An obstacle to achieving this objective is the fact that storage is allocated in fixed-length blocks such as cache lines and real memory pages that usually do not correspond to boundaries within programs or data structures. Programs and data structures that are designed without regard to the storage hierarchy often make inefficient use of the storage allocated to them, with adverse performance effects in small or heavily loaded systems.

Taking the storage hierarchy into account means understanding and adapting to the general principles of efficient programming in a cached or virtual-memory environment. Repackaging techniques can yield significant improvements without recoding, and any new code should be designed with efficient storage use in mind.

Two terms are essential to any discussion of the efficient use of hierarchical storage: *locality of reference* and *working set*.

- The locality of reference of a program is the degree to which its instruction-execution addresses and data references are clustered in a small area of storage during a given time interval.
- The working set of a program during that same interval is the set of storage blocks that are in use, or, more precisely, the code or data that occupy those blocks.

A program with good locality of reference has a minimal working set, because the blocks that are in use are tightly packed with executing code or data. A functionally equivalent program with poor locality of reference has a larger working set, because more blocks are needed to accommodate the wider range of addresses being accessed.

Because each block takes a significant amount of time to load into a given level of the hierarchy, the objective of efficient programming for a hierarchical-storage system is to design and package code in such a way that the working set remains as small as practical.

The following figure illustrates good and bad practice at a subroutine level. The first version of the program is packaged in the sequence in which it was probably written. The first subroutine **PriSub1** contains the entry point of the program. It always uses primary subroutines **PriSub2** and **PriSub3**. Some infrequently used functions of the program require secondary subroutines **SecSub1** and **SecSub2**. On rare occasions, the error subroutines **ErrSub1** and **ErrSub2** are needed.

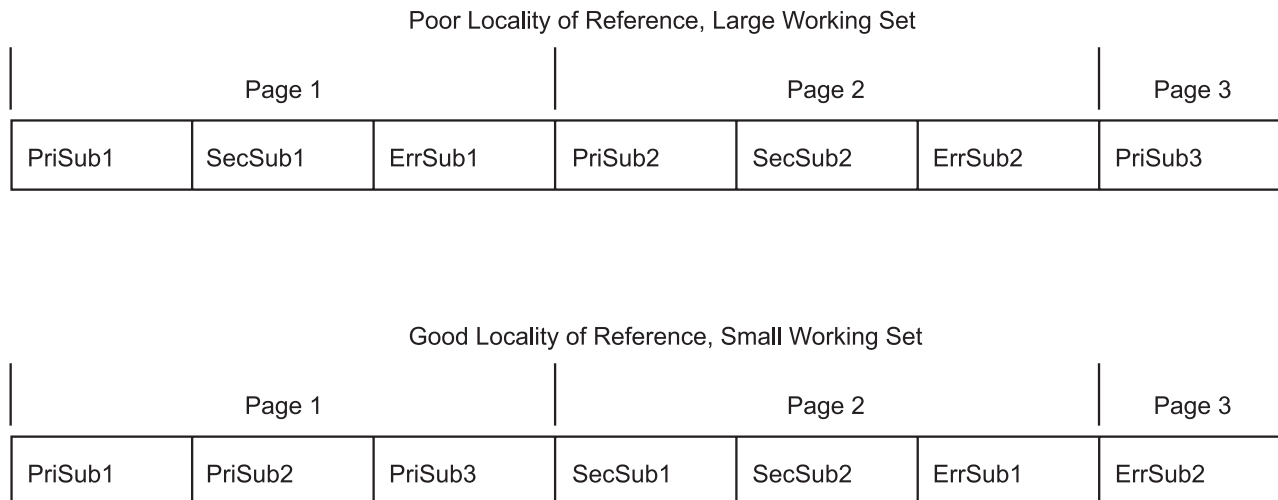

Figure 15. Locality of Reference. The top half of the figure describes how a binary program is packaged which shows low locality of reference. The instructions for PriSub1 is in the binary executable first, followed by the instructions for SecSub1, ErrSub1, PriSub2, SecSub2, ErrSub2, and PriSub3. In this executable, the instructions for PriSub1, SecSub1, and ErrSub1 occupy into the first page of memory. The instructions for PriSub2, SecSub2, and ErrSub2 occupy the second page of memory, and the instructions for PriSub3 occupy the third page of memory. SecSub1 and SecSub2 are infrequently used; also ErrSub1 and ErrSub2 are rarely used, if ever. Therefore, the packaging of this program exhibits poor locality of reference and may use more memory than required. In the second half of the figure, PriSub1, PriSub2, and PriSub3 are located next to each other and occupy the first page of memory. Following PriSub3 is SecSub1, SecSub2, and ErrSub1 which all occupy the second page of memory. Finally, ErrSub2 is at the end and occupies the third page of memory. Because ErrSub2 may never be needed, it would reduce the memory requirements by one page in this case.

The initial version of the program has poor locality of reference because it takes three pages of memory to run in the normal case. The secondary and error subroutines separate the main path of the program into three, physically distant sections.

The improved version of the program places the primary subroutines adjacent to one another and puts the low-frequency function after that. The necessary error subroutines (which are rarely-used) are left at the end of the executable program. The most common functions of the program can now be handled with only one disk read and one page of memory instead of the three previously required.

Remember that locality of reference and working set are defined with respect to time. If a program works in stages, each of which takes a significant time and uses a different set of subroutines, try to minimize the working set of each stage.

Registers and Pipeline

In general, allocating and optimizing of register space and keeping the pipeline full are the responsibilities of the compilers. The programmer's main obligation is to avoid structures that defeat compiler-optimization techniques. For example, if you use one of your subroutines in one of the critical loops of your program, it

may be appropriate for the compiler to inline that subroutine to minimize execution time. If the subroutine has been packaged in a different .c module, however, it cannot be inlined by the compiler.

Cache and TLBs

Depending on the processor architecture and model, processors have from one to several caches to hold the following:

- Parts of executing programs
- Data used by executing programs
- Translation lookaside buffers (TLBs), which contain the mapping from virtual address to real address of recently used pages of instruction text or data

If a cache miss occurs, loading a complete cache line can take dozens of processor cycles. If a TLB miss occurs, calculating the virtual-to-real mapping of a page can take several dozen cycles. The exact cost is implementation-dependent.

Even if a program and its data fit in the caches, the more lines or TLB entries used (that is, the lower the locality of reference), the more CPU cycles it takes to get everything loaded in. Unless the instructions and data are reused many times, the overhead of loading them is a significant fraction of total program execution time, resulting in degraded system performance.

Good programming techniques keep the main-line, typical-case flow of the program as compact as possible. The main procedure and all of the subroutines it calls frequently should be contiguous. Low-probability conditions, such as obscure errors, should be tested for only in the main line. If the condition actually occurs, its processing should take place in a separate subroutine. All such subroutines should be grouped together at the end of the module. This arrangement reduces the probability that low-usage code will take up space in a high-usage cache line. In large modules, some or all of the low-usage subroutines might occupy a page that almost never has to be read into memory.

The same principle applies to data structures, although it is sometimes necessary to change the code to compensate for the compiler's rules about data layout.

For example, some matrix operations, such as matrix multiplication, involve algorithms that, if coded simplistically, have poor locality of reference. Matrix operations generally involve accessing the matrix data sequentially, such as row elements acting on column elements. Each compiler has specific rules about the storage layout of matrixes. The FORTRAN compiler lays out matrixes in column-major format (that is, all of the elements of column 1, followed by all the elements of column 2, and so forth). The C compiler lays out matrixes in row-major format. If the matrixes are small, the row and column elements can be contained in the data cache, and the processor and floating-point unit can run at full speed. However, as the size of the matrixes increases, the locality of reference of such row/column operations deteriorates to a point where the data can no longer be maintained in the cache. In fact, the natural access pattern of the row/column operations generates a thrashing pattern for the cache where a string of elements accessed is larger than the cache, forcing the initially accessed elements out and then repeating the access pattern again for the same data.

The general solution to such matrix access patterns is to partition the operation into blocks, so that multiple operations on the same elements can be performed while they remain in the cache. This general technique is given the name *strip mining*.

Experts in numerical analysis were asked to code versions of the matrix-manipulation algorithms that made use of strip mining and other optimization techniques. The result was a 30-fold improvement in matrix-multiplication performance. The tuned routines are in the Basic Linear Algebra Subroutines (BLAS) library, `/usr/lib/libblas.a`. A larger set of performance-tuned subroutines is the Engineering and Scientific Subroutine Library (ESSL) licensed program.

The functions and interfaces of the Basic Linear Algebra Subroutines are documented in *AIX 5L Version 5.3 Technical Reference*. The FORTRAN run-time environment must be installed to use the library. Users should generally use this library for their matrix and vector operations because its subroutines are tuned to a degree that users are unlikely to achieve by themselves.

If the data structures are controlled by the programmer, other efficiencies are possible. The general principle is to pack frequently used data together whenever possible. If a structure contains frequently accessed control information and occasionally accessed detailed data, make sure that the control information is allocated in consecutive bytes. This will increase the probability that all of the control information will be loaded into the cache with a single (or at least with the minimum number of) cache misses.

Effective Use of Preprocessors and the Compilers

The programmer who wants to obtain the highest possible performance from a given program running on a given machine must deal with several considerations:

- There are preprocessors that can rearrange some source code structures to form a functionally equivalent source module that can be compiled into more efficient executable code.
- Just as there are several variants of the architecture, there are several compiler options to allow optimal compilation for a specific variant or set of variants.
- The programmer can use the **#pragma** feature to inform the C compiler of certain aspects of the program that will allow the compiler to generate more efficient code by relaxing some of its worst-case assumptions.
- There are several levels of optimization that give the compiler different degrees of freedom in instruction rearrangement.

Programmers who are unable to experiment, should always optimize. The difference in performance between optimized and unoptimized code is almost always so large that basic optimization (the **-O** option of the compiler commands) should always be used. The only exceptions are testing situations in which there is a specific need for straightforward code generation, such as statement-level performance analysis using the **tprof** tool.

These techniques yield additional performance improvement for some programs, but the determination of which combination yields the best performance for a specific program might require considerable recompilation and measurement.

For an extensive discussion of the techniques for efficient use of compilers, see *Optimization and Tuning Guide for XL Fortran, XL C and XL C++*.

Levels of Optimization

The levels of optimization in the compilers are as follows:

No Optimization

In the absence of any version of the **-O** flag, the compiler generates straightforward code with no instruction reordering or other attempt at performance improvement.

-O or **-O2**

These equivalent flags cause the compiler to optimize on the basis of conservative assumptions about code reordering. Only explicit relaxations such as the **#pragma** directives are used. This level performs no software pipelining, loop unrolling, or simple predictive commoning. It also constrains the amount of memory the compiler can use.

-O3

This flag directs the compiler to be aggressive about the optimization techniques used and to use as much memory as necessary for maximum optimization.

This level of optimization may result in functional changes to the program if the program is sensitive to the following:

- Floating-point exceptions
- The sign of zero
- Precision effects of reordering calculations

These side effects can be avoided, at some performance cost, by using the **-qstrict** option in combination with **-O3**.

The **-qhot** option, in combination with **-O3**, enables predictive commoning and some unrolling.

The result of these changes is that large or complex routines should have the same or better performance with the **-O3** option (possibly in conjunction with **-qstrict** or **-qhot**) that they had with the **-O** option in earlier versions of the compiler.

-O4

This flag is equivalent to **-O3 -qipa** with automatic generation of architecture and tuning option ideal for that platform.

-O5

This flag is similar to **-O4**, except in this case, **-qipa = level = 2**.

Compiling for Specific Hardware Platforms (-qarch, -qtune)

Systems can use several type of processors. By using the **-qarch** and **-qtune** options, you can optimize programs for the special instructions and particular strengths of these processors.

Follow these guidelines:

- If your program will be run only on a single system, or on a group of systems with the same processor type, use the **-qarch** option to specify the processor type.
- If your program will be run on systems with different processor types, and you can identify one processor type as the most important, use the appropriate **-qarch** and **-qtune** settings. FORTRAN and HPF users can use the **xxlf** and **xxlhpf** commands to select these settings interactively.
- If your program is intended to run on the full range of processor implementations, and is not intended primarily for one processor type, do not use either **-qarch** or **-qtune**.

C Options for string.h Subroutine Performance

The operating system provides the ability to embed the string subroutines in the application program rather than using them from **libc.a**, saving call and return linkage time. To embed the string subroutines, the source code of the application must have the following statement prior to the use of the subroutine(s):

```
#include <string.h>
```

C and C++ Coding Style for Best Performance

In many cases, the performance cost of a C construct is not obvious, and sometimes is even counter-intuitive. Some of these situations are as follows:

- Whenever possible, use *int* instead of *char* or *short*.
In most cases, *char* and *short* data items take more instructions to manipulate. The extra instructions cost time, and, except in large arrays, any space that is saved by using the smaller data types is more than offset by the increased size of the executable program.
- If you have to use a *char*, make it *unsigned*, if possible.
A *signed char* takes another two instructions more than an *unsigned char* each time the variable is loaded into a register.
- Use local (automatic) variables rather than global variables whenever possible.

Global variables require more instructions to access than local variables. Also, in the absence of information to the contrary, the compiler assumes that any global variable may have been changed by a subroutine call. This change has an adverse effect on optimization because the value of any global variable used after a subroutine call will have to be reloaded.

- When it is necessary to access a global variable (that is not shared with other threads), copy the value into a local variable and use the copy.

Unless the global variable is accessed only once, it is more efficient to use the local copy.

- Use binary codes rather than strings to record and test for situations. Strings consume both data and instruction space. For example, the sequence:

```
#define situation_1 1
#define situation_2 2
#define situation_3 3
int situation_val;

situation_val = situation_2;
. . .
if (situation_val == situation_1)
. . .
```

is much more efficient than the following sequence:

```
char situation_val[20];

strcpy(situation_val,"situation_2");
. . .
if ((strcmp(situation_val,"situation_1"))==0)
. . .
```

- When strings are necessary, use fixed-length strings rather than null-terminated variable-length strings wherever possible.

The **mem*()** family of routines, such as **memcpy()**, is faster than the corresponding **str*()** routines, such as **strcpy()**, because the **str*()** routines must check each byte for null and the **mem*()** routines do not.

Compiler Execution Time

In the operating system, the C compiler can be invoked by two different commands: **cc** and **xlc**. The **cc** command, which has historically been used to invoke the system's C compiler, causes the C compiler to run in **language=extended** mode. This mode allows the compilation of existing C programs that are not ANSI-compliant. It also consumes processor time.

If the program being compiled is, in fact, ANSI-compliant, it is more efficient to invoke the C compiler by using the **xlc** command.

Use of the **-O3** flag implicitly includes the **-qmaxmem** option. This option allows the compiler to use as much memory as necessary for maximum optimization. This situation can have two effects:

- On a multiuser system, a large **-O3** compilation may consume enough memory to have an adverse effect on the performance experienced by other users.
- On a system with small real memory, a large **-O3** compilation may consume enough memory to cause high paging rates, making compilation slow.

Memory-Limited Programs

To programmers accustomed to struggling with the addressing limitations of, for instance, the DOS environment, 256 MB virtual memory segments seem effectively infinite. The programmer is tempted to ignore storage constraints and code for minimum path length and maximum simplicity. Unfortunately, there is a drawback to this attitude. Virtual memory is large, but it is variable-speed. The more memory used, the slower it becomes, and the relationship is not linear. As long as the total amount of virtual storage actually being touched by all programs (that is, the sum of the working sets) is slightly less than the amount of unpinned real memory in the machine, virtual memory performs at about the speed of real memory. As the sum of the working sets of all executing programs passes the number of available page

frames, memory performance degrades rapidly (if VMM memory load control is turned off) by up to two orders of magnitude. When the system reaches this point, it is said to be *thrashing*. It is spending almost all of its time paging, and no useful work is being done because each process is trying to steal back from other processes the storage necessary to accommodate its working set. If VMM memory load control is active, it can avoid this self-perpetuating thrashing, but at the cost of significantly increased response times.

The degradation caused by inefficient use of memory is much greater than that from inefficient use of the caches because the difference in speed between memory and disk is so much higher than the difference between cache and memory. Where a cache miss can take a few dozen CPU cycles, a page fault typically takes 10 milliseconds or more, which is at least 400[®],000 CPU cycles.

Although VMM memory load control can ensure that incipient thrashing situations do not become self-perpetuating, unnecessary page faults still exact a cost in degraded response time and reduced throughput (see Tuning VMM Memory Load Control with the **schedo** Command).

Structuring of Pageable Code

To minimize the code working set of a program, the general objective is to pack code that is frequently executed into a small area, separating it from infrequently executed code. Specifically:

- Do not put long blocks of error-handling code in line. Place them in separate subroutines, preferably in separate source-code modules. This applies not only to error paths, but to any functional option that is infrequently used.
- Do not structure load modules arbitrarily. Try to ensure that frequently called object modules are located as close to their callers as possible. Object modules consisting (ideally) of infrequently called subroutines should be concentrated at the end of the load module. The pages they inhabit will seldom be read in.

Structuring of Pageable Data

To minimize the data working set, try to concentrate the frequently used data and avoid unnecessary references to virtual-storage pages. Specifically:

- Use the **malloc()** or **calloc()** subroutines to request only as much space as you actually need. Never request and then initialize a maximum-sized array when the actual situation uses only a fraction of it. When you touch a new page to initialize the array elements, you effectively force the VMM to steal a page of real memory from someone. Later, this results in a page fault when the process that owned that page tries to access it again. The difference between the **malloc()** and **calloc()** subroutines is not just in the interface.
- Because the **calloc()** subroutine zeroes the allocated storage, it touches every page that is allocated, whereas the **malloc()** subroutine touches only the first page. If you use the **calloc()** subroutine to allocate a large area and then use only a small portion at the beginning, you place an unnecessary load on the system. Not only do the pages have to be initialized; if their real-memory frames are reclaimed, the initialized and never-to-be-used pages must be written out to paging space. This situation wastes both I/O and paging-space slots.
- Linked lists of large structures (such as buffers) can result in similar problems. If your program does a lot of chain-following looking for a particular key, consider maintaining the links and keys separately from the data or using a hash-table approach instead.
- Locality of reference means locality in time, not just in address space. Initialize data structures just prior to when they are used (if at all). In a heavily loaded system, data structures that are resident for a long time between initialization and use risk having their frames stolen. Your program would then experience an unnecessary page fault when it began to use the data structure.
- Similarly, if a large structure is used early and then left untouched for the remainder of the program, it should be released. It is not sufficient to use the **free()** subroutine to free the space that was allocated with the **malloc()** or **calloc()** subroutines. The **free()** subroutine releases only the address range that the structure occupied. To release the real memory and paging space, use the **disclaim()** subroutine to disclaim the space as well. The call to **disclaim()** should be before the call to **free()**.

Misuse of Pinned Storage

To avoid circularities and time-outs, a small fraction of the system must be pinned in real memory. For this code and data, the concept of working set is meaningless, because all of the pinned information is in real storage all the time, whether or not it is used. Any program (such as a user-written device driver) that pins code or data must be carefully designed (or scrutinized, if ported) to ensure that only minimal amounts of pinned storage are used. Some cautionary examples are as follows:

- Code is pinned on a load-module (executable file) basis. If a component has some object modules that must be pinned and others that can be pageable, package the pinned object modules in a separate load module.
- Pinning a module or a data structure because there might be a problem is irresponsible. The designer should understand the conditions under which the information could be required and whether a page fault could be tolerated at that point.
- Pinned structures whose required size is load-dependent, such as buffer pools, should be tunable by the system administrator.

Using Performance-Related Installation Guidelines

This topic provides recommended actions you should take (or not take) before and during the installation process.

Operating System Preinstallation Guidelines

Two situations require consideration, as follows:

- Installing the Operating System on a New System
Before you begin the installation process, be sure that you have made decisions about the size and location of disk file systems and paging spaces, and that you understand how to communicate those decisions to the operating system.
- Installing a New Level of the Operating System on an Existing System
If you are upgrading to a new level of the operating system, do the following:
 - Check to see if you are using a `/etc/tunables/nextboot` file.
 - If you do use the `/etc/tunables/nextboot` file, inspect the `/etc/tunables/lastboot.log` file after the first reboot.

CPU Preinstallation Guidelines

Use the default CPU scheduling parameters, such as the time-slice duration. Unless you have extensive monitoring and tuning experience with the same workload on a nearly identical configuration, leave these parameters unchanged at installation time.

See Monitoring and Tuning CPU Use for post-installation recommendations.

Memory Preinstallation Guidelines

Do not make any memory-threshold changes until you have had experience with the response of the system to the actual workload.

See Monitoring and Tuning Memory Use for post-installation recommendations.

Disk Preinstallation Guidelines

The mechanisms for defining and expanding logical volumes attempt to make the best possible default choices. However, satisfactory disk-I/O performance is much more likely if the installer of the system tailors the size and placement of the logical volumes to the expected data storage and workload requirements. Recommendations are as follows:

- If possible, the default volume group, rootvg, should consist only of the physical volume on which the system is initially installed. Define one or more other volume groups to control the other physical volumes in the system. This recommendation has system management, as well as performance, advantages.
- If a volume group consists of more than one physical volume, you may gain performance by:
 - Initially defining the volume group with a single physical volume.
 - Defining a logical volume within the new volume group. This definition causes the allocation of the volume group's journal logical volume on the first physical volume.
 - Adding the remaining physical volumes to the volume group.
 - Defining the high-activity file systems on the newly added physical volumes.
 - Defining only very-low-activity file systems, if any, on the physical volume containing the journal logical volume. This affects performance only if I/O would cause journaled file system (JFS) log transactions.

This approach separates journaled I/O activity from the high-activity data I/O, increasing the probability of overlap. This technique can have an especially significant effect on NFS server performance, because both data and journal writes must be complete before NFS signals I/O complete for a write operation.

- At the earliest opportunity, define or expand the logical volumes to their maximum expected sizes. To maximize the probability that performance-critical logical volumes will be contiguous and in the desired location, define or expand them first.
- High-usage logical volumes should occupy parts of multiple disk drives. If the **RANGE of physical volumes** option on the Add a Logical Volume screen of the SMIT program (fast path: **smitty mklv**) is set to **maximum**, the new logical volume will be divided among the physical volumes of the volume group (or the set of physical volumes explicitly listed).
- If the system has drives of different types (or you are trying to decide which drives to order), consider the following guidelines:
 - Place large files that are normally accessed sequentially on the fastest available disk drive.
 - If you expect frequent sequential accesses to large files on the fastest disk drives, limit the number of disk drivers per disk adapter.
 - When possible, attach drives with critical, high-volume performance requirements to a high speed adapter. These adapters have features, such as back-to-back write capability, that are not available on other disk adapters.
 - On the smaller disk drives, logical volumes that will hold large, frequently accessed sequential files should be allocated in the outer edge of the physical volume. These disks have more blocks per track in their outer sections, which improves sequential performance.
 - On the original SCSI bus, the highest-numbered drives (those with the numerically largest SCSI addresses, as set on the physical drives) have the highest priority. Subsequent specifications usually attempt to maintain compatibility with the original specification. Thus, the order from highest to lowest priority is as follows: 7-6-5-4-3-2-1-0-15-14-13-12-11-10-9-8.

In most situations this effect is not noticeable, but large sequential file operations have been known to exclude low-numbered drives from access to the bus. You should probably configure the disk drives holding the most response-time-critical data at the highest addresses on each SCSI bus.

The **lsdev -Cs scsi** command reports on the current address assignments on each SCSI bus. For the original SCSI adapter, the SCSI address is the first number in the fourth pair of numbers in the output. In the following output example, one 400 GB disk is at SCSI address 4, another at address 5, the 8mm tape drive at address 1, and the CDROM drive is at address 3.

```
cd0    Available 10-80-00-3,0 SCSI Multimedia CD-ROM Drive
hdisk0 Available 10-80-00-4,0 16 Bit SCSI Disk Drive
hdisk1 Available 10-80-00-5,0 16 Bit SCSI Disk Drive
rmt0   Available 10-80-00-1,0 2.3 GB 8mm Tape Drive
```

- Large files that are heavily used and are normally accessed randomly, such as data bases, should be spread across two or more physical volumes.

See Monitoring and Tuning Disk I/O Use for post-installation recommendations.

Placement and Sizes of Paging Spaces

The general recommendation is that the sum of the sizes of the paging spaces should be equal to at least twice the size of the real memory of the machine, up to a memory size of 256 MB (512 MB of paging space).

Note: For memories larger than 256 MB, the following is recommended:

```
total paging space = 512 MB + (memory size - 256 MB) * 1.25
```

However, starting with AIX 4.3.2 and Deferred Page Space Allocation, this guideline may tie up more disk space than actually necessary. See Choosing a Page Space Allocation Method for more information.

Ideally, there should be several paging spaces of roughly equal size, each on a different physical disk drive. If you decide to create additional paging spaces, create them on physical volumes that are more lightly loaded than the physical volume in rootvg. When allocating paging space blocks, the VMM allocates four blocks, in turn, from each of the active paging spaces that has space available. While the system is booting, only the primary paging space (hd6) is active. Consequently, all paging-space blocks allocated during boot are on the primary paging space. This means that the primary paging space should be somewhat larger than the secondary paging spaces. The secondary paging spaces should all be of the same size to ensure that the algorithm performed in turn can work effectively.

The **lspcs -a** command gives a snapshot of the current utilization level of all the paging spaces on a system. You can also use the **psdanger()** subroutine to determine how closely paging-space utilization is approaching critical levels. As an example, the following program uses the **psdanger()** subroutine to provide a warning message when a threshold is exceeded:

```
/* psmonitor.c
   Monitors system for paging space low conditions. When the condition is
   detected, writes a message to stderr.
   Usage:  psmonitor [Interval [Count]]
   Default: psmonitor 1 1000000
*/
#include <stdio.h>
#include <signal.h>
main(int argc, char **argv)
{
    int interval = 1;      /* seconds */
    int count = 1000000;  /* intervals */
    int current;          /* interval */
    int last;             /* check */
    int kill_offset;      /* returned by psdanger() */
    int danger_offset;    /* returned by psdanger() */

    /* are there any parameters at all? */
    if (argc > 1) {
        if ( (interval = atoi(argv[1])) < 1 ) {
            fprintf(stderr, "Usage: psmonitor [ interval [ count ] ]\n");
            exit(1);
        }
        if (argc > 2) {
            if ( (count = atoi( argv[2])) < 1 ) {
                fprintf(stderr, "Usage: psmonitor [ interval [ count ] ]\n");
                exit(1);
            }
        }
    }
    last = count - 1;
    for(current = 0; current < count; current++) {
        kill_offset = psdanger(SIGKILL); /* check for out of paging space */
    }
}
```



```

if (kill_offset < 0)
    fprintf(stderr,
        "OUT OF PAGING SPACE! %d blocks beyond SIGKILL threshold.\n",
        kill_offset*(-1));
else {
    danger_offset = psdanger(SIGDANGER); /* check for paging space low */
    if (danger_offset < 0) {
        fprintf(stderr,
            "WARNING: paging space low. %d blocks beyond SIGDANGER threshold.\n",
            danger_offset*(-1));
        fprintf(stderr,
            "
                %d blocks below SIGKILL threshold.\n",
                kill_offset);
    }
}
if (current < last)
    sleep(interval);
}
}

```

Performance Implications of Disk Mirroring

If mirroring is being used and Mirror Write Consistency is on (as it is by default), consider locating the copies in the outer region of the disk, because the Mirror Write Consistency information is always written in Cylinder 0. From a performance standpoint, mirroring is costly, mirroring with Write Verify is costlier still (extra disk rotation per write), and mirroring with both Write Verify and Mirror Write Consistency is costliest of all (disk rotation plus a seek to Cylinder 0). From a fiscal standpoint, only mirroring with writes is expensive. Although an **lslv** command will usually show Mirror Write Consistency to be on for non-mirrored logical volumes, no actual processing is incurred unless the COPIES value is greater than one. Write Verify defaults to off, because it does have meaning (and cost) for non-mirrored logical volumes.

Beginning in AIX 5.1, a mirror write consistency option called Passive Mirror Write Consistency (MWC) is available. The default mechanism for ensuring mirror write consistency is Active MWC. Active MWC provides fast recovery at reboot time after a crash has occurred. However, this benefit comes at the expense of write performance degradation, particularly in the case of random writes. Disabling Active MWC eliminates this write-performance penalty, but upon reboot after a crash you must use the **syncvg -f** command to manually synchronize the entire volume group before users can access the volume group. To achieve this, automatic vary-on of volume groups must be disabled.

Enabling Passive MWC not only eliminates the write-performance penalty associated with Active MWC, but logical volumes will be automatically resynchronized as the partitions are being accessed. This means that the administrator does not have to synchronize logical volumes manually or disable automatic vary-on. The disadvantage of Passive MWC is that slower read operations may occur until all the partitions have been resynchronized.

You can select either mirror write consistency option within SMIT when creating or changing a logical volume. The selection option takes effect only when the logical volume is mirrored (copies > 1).

Performance Implications of Mirrored Striped LVs

Prior to AIX 4.3.3, logical volumes could not be mirrored and striped at the same time. Logical volume mirroring and striping combines the data availability of RAID 1 with the performance of RAID 0 entirely through software. Volume groups that contain striped and mirrored logical volumes cannot be imported into AIX 4.3.2 or earlier.

Communications Preinstallation Guidelines

See the summary of communications tuning recommendations in Tuning TCP and UDP Performance and Tuning mbuf Pool Performance.

For correct placement of adapters and various performance guidelines, see *PCI Adapter Placement Reference*.

Chapter 9. POWER4-based systems

This topic discusses performance issues related to POWER4-based servers and contains the following major sections:

- POWER4™ performance enhancements
- Scalability enhancements for POWER4-based systems
- 64-bit kernel
- Enhanced JFS
- Related information

POWER4 performance enhancements

The POWER4 microprocessor includes the following performance enhancements:

- It is optimized for symmetric multiprocessing (SMP), thus providing better instruction parallelism.
- It employs better scheduling for instructions and data prefetching and a more effective branch-prediction mechanism.
- It provides higher memory bandwidth than the POWER3™ microprocessor, and is designed to operate at much higher frequencies.

Microprocessor comparison

The following table compares key aspects of different IBM microprocessors:

Table 1. Processor Comparisons

| | POWER3 | RS64 | POWER4 |
|----------------------|------------|----------------|----------------------------------|
| Frequency | 450 MHz | 750 MHz | > 1 GHz |
| Fixed Point Units | 3 | 2 | 2 |
| Floating Point Units | 2 | 1 | 2 |
| Load/Store Units | 2 | 1 | 2 |
| Branch/Other Units | 1 | 1 | 2 |
| Dispatch Width | 4 | 4 | 5 |
| Branch Prediction | Dynamic | Static | Dynamic |
| I-cache size | 32 KB | 128 KB | 64 KB |
| D-cache size | 128 KB | 128 KB | 32 KB |
| L2-cache size | 1, 4, 8 MB | 2, 4, 8, 16 MB | 1.44 |
| L3-cache size | N/A | N/A | Scales with number of processors |
| Data Prefetch | Yes | No | Yes |

Scalability enhancements for POWER4-based systems

Beginning with AIX 5.1 running on POWER4-based systems, the operating system provides several scalability advantages over previous systems, both in terms of workload and performance. *Workload scalability* refers to the ability to handle an increasing application-workload. *Performance scalability* refers to maintaining an acceptable level of performance as software resources increase to meet the demands of larger workloads.

The following are some of the most important scalability changes introduced in AIX 5.1.

Pinned shared memory for database

AIX 4.3.3 and AIX 5.1 enable memory pages to be maintained in real memory all the time. This mechanism is called *pinning memory*. Pinning a memory region prohibits the pager from stealing pages from the pages that back the pinned memory region.

For more information on pinned memory, see Resource Management Overview.

Larger memory support

The maximum real-memory size supported by the 64-bit kernel is 256 GB. This size is based upon the boot-time real memory requirements of hardware systems and possible I/O configurations that the 64-bit kernel supports. No minimum paging-space size requirement exists for the 64-bit kernel. This is because deferred paging-space allocation support was introduced into the kernel base in AIX 4.3.3.

64-bit kernel

Beginning with AIX 5.1, the operating system provides a 64-bit kernel that addresses bottlenecks which could have limited throughput on 32-way systems. POWER4 systems are optimized for the 64-bit kernel, which is intended to increase scalability of RS/6000 IBM eServer pSeries systems. It is optimized for running 64-bit applications on POWER4 systems. The code base for the 64-bit kernel is almost identical to that for the 32-bit kernel. However, 64-bit code is built using a more advanced compiler.

The 64-bit kernel also improves scalability by allowing you to use larger sizes of physical memory. The 32-bit kernel is limited to 96 GB of physical memory.

64-bit applications on 32-bit kernel

The performance of 64-bit applications running on the 64-bit kernel on POWER4-based systems should be greater than, or equal to, the same application running on the same hardware with the 32-bit kernel. The 64-bit kernel allows 64-bit applications to be supported without requiring system call parameters to be remapped or reshaped. The 64-bit kernel applications use a more advanced compiler that is optimized specifically for the POWER4 system.

32-bit applications on 64-bit kernel

In most instances, 32-bit applications can run on the 64-bit kernel without performance degradation. However, 32-bit applications on the 64-bit kernel will typically have slightly lower performance than on the 32-bit call because of parameter reshaping. This performance degradation is typically not greater than 5%. For example, calling the **fork()** command might result in significantly more overhead.

64-bit applications on 64-bit Kernel, non-POWER4 systems

The performance of 64-bit applications under the 64-bit kernel on non-POWER4 systems may be lower than that of the same applications on the same hardware under the 32-bit kernel. The non-POWER4 systems are intended as a bridge to POWER4 systems and lack some of the support that is needed for optimal 64-bit kernel performance.

64-bit kernel extensions on non-POWER4 systems

The performance of 64-bit kernel extensions on POWER4 systems should be the same or better than their 32-bit counterparts on the same hardware. However, performance of 64-bit kernel extensions on non-POWER4 machines may be lower than that of 32-bit kernel extensions on the same hardware because of the lack of optimization for 64-bit kernel performance on non-POWER4 systems.

Enhanced Journaled File System (JFS2)

Enhanced JFS (also known as JFS2) provides better scalability than JFS. Additionally JFS2 is the default file system for the 64-bit kernel. You can choose to use either JFS, which is the recommended file system for 32-bit environments, or Enhanced JFS, which is recommended for 64-bit kernel. For more information on Enhanced JFS, see [Monitoring and Tuning File Systems](#).

Related information

[Monitoring and Tuning File Systems](#)

[Resource Management Overview](#)

[IBM Redbook The POWER4 Processor Introduction and Tuning Guide](#)

Chapter 10. CPU performance

This topic includes information on techniques for detecting runaway or CPU-intensive programs and minimizing their adverse affects on system performance.

If you are not familiar with CPU scheduling, you may want to refer to the Performance Overview of the CPU scheduler topic before continuing.

The following sections describe the different aspects of CPU tuning:

- CPU performance monitoring
- Use of the time command to measure CPU use
- Identification of CPU-intensive programs
- Use of the pprof command to measure CPU usage of kernel threads
- Detection of instruction emulation with the emstat tool
- Detection of alignment exceptions with the alstat tool
- Restructure of executable programs with the fdpr program
- Controlling contention for the CPU
- CPU-efficient user id administration with the mkpasswd command

CPU performance monitoring

The processing unit is one of the fastest components of the system. It is comparatively rare for a single program to keep the CPU 100 percent busy (that is, 0 percent idle and 0 percent wait) for more than a few seconds at a time. Even in heavily loaded multiuser systems, there are occasional 10 milliseconds (ms) periods that end with all threads in a wait state. If a monitor shows the CPU 100 percent busy for an extended period, there is a good chance that some program is in an infinite loop. Even if the program is "merely" expensive, rather than broken, it needs to be identified and dealt with.

The vmstat command (CPU)

The first tool to use is the **vmstat** command, which quickly provides compact information about various system resources and their related performance problems. The **vmstat** command reports statistics about kernel threads in the run and wait queue, memory, paging, disks, interrupts, system calls, context switches, and CPU activity. The reported CPU activity is a percentage breakdown of user mode, system mode, idle time, and waits for disk I/O.

Note: If the **vmstat** command is used without any options or only with the interval and optionally, the count parameter, such as **vmstat 2 10**; then the first line of numbers is an average since system reboot.

As a CPU monitor, the **vmstat** command is superior to the **iostat** command in that its one-line-per-report output is easier to scan as it scrolls and there is less overhead involved if there are a lot of disks attached to the system. The following example can help you identify situations in which a program has run away or is too CPU-intensive to run in a multiuser environment.

```
# vmstat 2
kthr      memory          page        faults          cpu
-----
 r  b   avm    fre  re  pi  po  fr  sr  cy  in  sy  cs  us  sy  id  wa
1  0 22478  1677   0   0   0   0   0   0 188 1380 157 57 32   0 10
1  0 22506  1609   0   0   0   0   0   0 214 1476 186 48 37   0 16
0  0 22498  1582   0   0   0   0   0   0 248 1470 226 55 36   0  9

 2  0 22534  1465   0   0   0   0   0   0 238  903 239 77 23   0  0
 2  0 22534  1445   0   0   0   0   0   0 209 1142 205 72 28   0  0
```

```

2 0 22534 1426 0 0 0 0 0 0 189 1220 212 74 26 0 0
3 0 22534 1410 0 0 0 0 0 0 255 1704 268 70 30 0 0
2 1 22557 1365 0 0 0 0 0 0 383 977 216 72 28 0 0

2 0 22541 1356 0 0 0 0 0 0 237 1418 209 63 33 0 4
1 0 22524 1350 0 0 0 0 0 0 241 1348 179 52 32 0 16
1 0 22546 1293 0 0 0 0 0 0 217 1473 180 51 35 0 14

```

This output shows the effect of introducing a program in a tight loop to a busy multiuser system. The first three reports (the summary has been removed) show the system balanced at 50-55 percent user, 30-35 percent system, and 10-15 percent I/O wait. When the looping program begins, all available CPU cycles are consumed. Because the looping program does no I/O, it can absorb all of the cycles previously unused because of I/O wait. Worse, it represents a process that is always ready to take over the CPU when a useful process relinquishes it. Because the looping program has a priority equal to that of all other foreground processes, it will not necessarily have to give up the CPU when another process becomes dispatchable. The program runs for about 10 seconds (five reports), and then the activity reported by the **vmstat** command returns to a more normal pattern.

Optimum use would have the CPU working 100 percent of the time. This holds true in the case of a single-user system with no need to share the CPU. Generally, if *us* + *sy* time is below 90 percent, a single-user system is not considered CPU constrained. However, if *us* + *sy* time on a multiuser system exceeds 80 percent, the processes may spend time waiting in the run queue. Response time and throughput might suffer.

To check if the CPU is the bottleneck, consider the four *cpu* columns and the two *kthr* (kernel threads) columns in the **vmstat** report. It may also be worthwhile looking at the *faults* column:

- **cpu**

Percentage breakdown of CPU time usage during the interval. The *cpu* columns are as follows:

- **us**

The *us* column shows the percent of CPU time spent in user mode. A UNIX process can execute in either user mode or system (kernel) mode. When in user mode, a process executes within its application code and does not require kernel resources to perform computations, manage memory, or set variables.

- **sy**

The *sy* column details the percentage of time the CPU was executing a process in system mode. This includes CPU resource consumed by kernel processes (**kprocs**) and others that need access to kernel resources. If a process needs kernel resources, it must execute a system call and is thereby switched to system mode to make that resource available. For example, reading or writing of a file requires kernel resources to open the file, seek a specific location, and read or write data, unless memory mapped files are used.

- **id**

The *id* column shows the percentage of time which the CPU is idle, or waiting, without pending local disk I/O. If there are no threads available for execution (the run queue is empty), the system dispatches a thread called **wait**, which is also known as the **idle kproc**. On an SMP system, one **wait** thread per processor can be dispatched. The report generated by the **ps** command (with the **-k** or **-g 0** option) identifies this as *kproc* or *wait*. If the **ps** report shows a high aggregate time for this thread, it means there were significant periods of time when no other thread was ready to run or waiting to be executed on the CPU. The system was therefore mostly *idle* and *waiting* for new tasks.

- **wa**

The *wa* column details the percentage of time the CPU was *idle* with pending local disk I/O and NFS-mounted disks. If there is at least one outstanding I/O to a disk when **wait** is running, the time is classified as waiting for I/O. Unless asynchronous I/O is being used by the process, an I/O request to disk causes the calling process to block (or sleep) until the request has been completed. Once an I/O request for a process completes, it is placed on the run queue. If the I/Os were completing faster, more CPU time could be used.

A `wa` value over 25 percent could indicate that the disk subsystem might not be balanced properly, or it might be the result of a disk-intensive workload.

For information on the change made to `wa`, see Wait I/O Time Reporting.

- **kthr**

Number of kernel threads in various queues averaged per second over the sampling interval. The `kthr` columns are as follows:

- **r**

Average number of kernel threads that are runnable, which includes threads that are running and threads that are waiting for the CPU. If this number is greater than the number of CPUs, there is at least one thread waiting for a CPU and the more threads there are waiting for CPUs, the greater the likelihood of a performance impact.

- **b**

Average number of kernel threads in the VMM wait queue per second. This includes threads that are waiting on filesystem I/O or threads that have been suspended due to memory load control.

If processes are suspended due to memory load control, the blocked column (`b`) in the **vmstat** report indicates the increase in the number of threads rather than the run queue.

- **p**

For **vmstat -l** The number of threads waiting on I/Os to raw devices per second. Threads waiting on I/Os to filesystems would not be included here.

- **faults**

Information about process control, such as trap and interrupt rate. The `faults` columns are as follows:

- **in**

Number of device interrupts per second observed in the interval. Additional information can be found in Assessing Disk Performance with the `vmstat` Command.

- **sy**

The number of system calls per second observed in the interval. Resources are available to user processes through well-defined system calls. These calls instruct the kernel to perform operations for the calling process and exchange data between the kernel and the process. Because workloads and applications vary widely, and different calls perform different functions, it is impossible to define how many system calls per-second are too many. But typically, when the `sy` column raises over 10000 calls per second on a uniprocessor, further investigations is called for (on an SMP system the number is 10000 calls per second per processor). One reason could be "polling" subroutines like the **select()** subroutine. For this column, it is advisable to have a baseline measurement that gives a count for a normal `sy` value.

- **cs**

Number of context switches per second observed in the interval. The physical CPU resource is subdivided into logical time slices of 10 milliseconds each. Assuming a thread is scheduled for execution, it will run until its time slice expires, until it is preempted, or until it voluntarily gives up control of the CPU. When another thread is given control of the CPU, the context or working environment of the previous thread must be saved and the context of the current thread must be loaded. The operating system has a very efficient context switching procedure, so each switch is inexpensive in terms of resources. Any significant increase in context switches, such as when `cs` is a lot higher than the disk I/O and network packet rate, should be cause for further investigation.

The `iostat` command

The **`iostat`** command is the fastest way to get a first impression, whether or not the system has a disk I/O-bound performance problem (see Assessing Disk Performance with the `iostat` Command). The tool also reports CPU statistics.

The following example shows a part of an **`iostat`** command output. The first stanza shows the summary statistic since system startup.

```
# iostat -t 2 6
tty:      tin          tout   avg-cpu:  % user   % sys    % idle   % iowait
          0.0          0.8    8.4      2.6      88.5     0.5
          0.0          80.2   4.5      3.0      92.1     0.5
          0.0          40.5   7.0      4.0      89.0     0.0
          0.0          40.5   9.0      2.5      88.5     0.0
          0.0          40.5   7.5      1.0      91.5     0.0
          0.0          40.5  10.0     3.5      80.5     6.0
```

The CPU statistics columns (% user, % sys, % idle, and % iowait) provide a breakdown of CPU usage. This information is also reported in the **vmstat** command output in the columns labeled us, sy, id, and wa. For a detailed explanation for the values, see The vmstat Command. Also note the change made to %iowait described in Wait I/O Time Reporting.

The sar command

The **sar** command gathers statistical data about the system. Though it can be used to gather some useful data regarding system performance, the **sar** command can increase the system load that can exacerbate a pre-existing performance problem if the sampling frequency is high. But compared to the accounting package, the **sar** command is less intrusive. The system maintains a series of system activity counters which record various activities and provide the data that the **sar** command reports. The **sar** command does not cause these counters to be updated or used; this is done automatically regardless of whether or not the **sar** command runs. It merely extracts the data in the counters and saves it, based on the sampling rate and number of samples specified to the **sar** command.

With its numerous options, the **sar** command provides queuing, paging, TTY, and many other statistics. One important feature of the **sar** command is that it reports either system-wide (global among all processors) CPU statistics (which are calculated as averages for values expressed as percentages, and as sums otherwise), or it reports statistics for each individual processor. Therefore, this command is particularly useful on SMP systems.

There are three situations to use the **sar** command:

Real-time sampling and display

To collect and display system statistic reports immediately, use the following command:

```
# sar -u 2 5
AIX aixhost 2 5 00049FDF4C00    02/21/04
18:11:12   %usr   %sys   %wio   %idle
18:11:14     4     6     0     91
18:11:16     2     7     0     91
18:11:18     3     6     0     92
18:11:20     2     7     0     92
18:11:22     2     7     1     90
Average     2     6     0     91
```

This example is from a single user workstation and shows the CPU utilization.

Display previously captured data

The **-o** and **-f** options (write and read to/from user given data files) allow you to visualize the behavior of your machine in two independent steps. This consumes less resources during the problem-reproduction period. You can use a separate machine to analyze the data by transferring the file because the collected binary file keeps all data the **sar** command needs.

```
# sar -o /tmp/sar.out 2 5 > /dev/null
```

The above command runs the **sar** command in the background, collects system activity data at 2-second intervals for 5 intervals, and stores the (unformatted) **sar** data in the **/tmp/sar.out** file. The redirection of standard output is used to avoid a screen output.

The following command extracts CPU information from the file and outputs a formatted report to standard output:

```
# sar -f/tmp/sar.out
AIX aixhost 2 5 00049FDF4C00    02/21/04

18:10:18    %usr    %sys    %wio    %idle
18:10:20         9         2         0        88
18:10:22        13        10         0        76
18:10:24        37         4         0        59
18:10:26         8         2         0        90
18:10:28        20         3         0        77

Average         18         4         0        78
```

The captured binary data file keeps all information needed for the reports. Every possible **sar** report could therefore be investigated. This also allows to display the processor-specific information of an SMP system on a single processor system.

System activity accounting via cron daemon

The **sar** command calls a process named **sadc** to access system data. Two shell scripts (**/usr/lib/sa/sa1** and **/usr/lib/sa/sa2**) are structured to be run by the **cron** daemon and provide daily statistics and reports. Sample stanzas are included (but commented out) in the **/var/spool/cron/crontabs/adm** crontab file to specify when the **cron** daemon should run the shell scripts.

The following lines show a modified crontab for the adm user. Only the comment characters for the data collections were removed:

```
#####
#          SYSTEM ACTIVITY REPORTS
# 8am-5pm activity reports every 20 mins during weekdays.
# activity reports every an hour on Saturday and Sunday.
# 6pm-7am activity reports every an hour during weekdays.
# Daily summary prepared at 18:05.
#####
0 8-17 * * 1-5 /usr/lib/sa/sa1 1200 3 &
0 * * * 0,6 /usr/lib/sa/sa1 &
0 18-7 * * 1-5 /usr/lib/sa/sa1 &
5 18 * * 1-5 /usr/lib/sa/sa2 -s 8:00 -e 18:01 -i 3600 -ubcwyavm &
#####
```

Collection of data in this manner is useful to characterize system usage over a period of time and to determine peak usage hours.

Useful CPU options: The most useful CPU-related options for the **sar** command are:

- **sar -P**

The **-P** option reports per-processor statistics for the specified processors. By specifying the **ALL** keyword, statistics for each individual processor and an average for all processors is reported. Of the flags which specify the statistics to be reported, only the **-a**, **-c**, **-m**, **-u**, and **-w** flags are meaningful with the **-P** flag.

The following example shows the per-processor statistic while a CPU-bound program was running on processor number 0:

```
# sar -P ALL 2 3
AIX aixsmphost 2 5 00049FDF4D01    02/22/04
```

```

17:30:50 cpu    %usr    %sys    %wio    %idle
17:30:52 0         8       92       0        0
          1         0        4        0       96
          2         0        1        0       99
          3         0        0        0      100
          -         2       24        0       74
17:30:54 0        12      88       0        0
          1         0        3        0       97
          2         0        1        0       99
          3         0        0        0      100
          -         3       23        0       74
17:30:56 0        11      89       0        0
          1         0        3        0       97
          2         0        0        0      100
          3         0        0        0      100
          -         3       23        0       74

Average 0        10      90       0        0
          1         0        4        0       96
          2         0        1        0       99
          3         0        0        0      100
          -         3       24        0       74

```

The last line of every stanza, which starts with a dash (-) in the `cpu` column, is the average for all processors. An average (-) line displays only if the **-P ALL** option is used. It is removed if processors are specified. The last stanza, labeled with the word `Average` instead of a time stamp, keeps the averages for the processor-specific rows over all stanzas.

The following example shows the **vmstat** output during this time:

```

# vmstat 2 5
kthr      memory          page          faults          cpu
-----
 r b avm    fre    re pi po fr sr cy in sy  cs us sy id wa
0 0 255636 16054  0 0 0 0 0 0 0 116 266 5  0 1 99 0
1 1 255733 15931  0 0 0 0 0 0 0 476 50781 35 2 27 70 0
1 1 255733 15930  0 0 0 0 0 0 0 476 49437 27 2 24 74 0
1 1 255733 15930  0 0 0 0 0 0 0 473 48923 31 3 23 74 0
1 1 255733 15930  0 0 0 0 0 0 0 466 49383 27 3 23 74 0

```

The first numbered line is the summary since startup of the system. The second line reflects the start of the **sar** command, and with the third row, the reports are comparable. The **vmstat** command can only display the average CPU utilization over all processors. This is comparable with the dashed (-) rows from the CPU utilization output from the **sar** command.

- **sar -u**

This displays the CPU utilization. It is the default if no other flag is specified. It shows the same information as the CPU statistics of the **vmstat** or **iostat** commands.

During the following example, a copy command was started:

```

# sar -u -P ALL 1 5

AIX aixsmphost 2 5 00049FDF4D01    02/22/04

13:33:42 cpu    %usr    %sys    %wio    %idle
13:33:43 0         0        0        0      100
          1         0        0        0      100
          2         0        0        0      100
          3         0        0        0      100
          -         0        0        0      100
13:33:44 0         2       66        0       32
          1         0        1        0       99
          2         0        0        0      100
          3         0        1        0       99
          -         0       17        0       82
13:33:45 0         1       52       44        3
          1         0        1        0       99
          2         0        4        0       96

```

| | | | | | |
|----------|---|---|----|----|-----|
| | 3 | 0 | 0 | 0 | 100 |
| | - | 0 | 14 | 11 | 74 |
| 13:33:46 | 0 | 0 | 8 | 91 | 1 |
| | 1 | 0 | 0 | 0 | 100 |
| | 2 | 0 | 0 | 0 | 100 |
| | 3 | 0 | 1 | 0 | 99 |
| | - | 0 | 2 | 23 | 75 |
| 13:33:47 | 0 | 0 | 7 | 93 | 0 |
| | 1 | 0 | 0 | 0 | 100 |
| | 2 | 0 | 1 | 0 | 99 |
| | 3 | 0 | 0 | 0 | 100 |
| | - | 0 | 2 | 23 | 75 |
| Average | 0 | 1 | 27 | 46 | 27 |
| | 1 | 0 | 0 | 0 | 100 |
| | 2 | 0 | 1 | 0 | 99 |
| | 3 | 0 | 0 | 0 | 100 |
| | - | 0 | 7 | 11 | 81 |

The **cp** command is working on processor number 0, and the three other processors are idle. See Wait I/O Time Reporting for more information.

- **sar -c**

The **-c** option shows the system call rate.

```
# sar -c 1 3
19:28:25 scall/s sread/s swrit/s fork/s exec/s rchar/s wchar/s
19:28:26 134 36 1 0.00 0.00 2691306 1517
19:28:27 46 34 1 0.00 0.00 2716922 1531
19:28:28 46 34 1 0.00 0.00 2716922 1531

Average 75 35 1 0.00 0.00 2708329 1527
```

While the **vmstat** command shows system call rates as well, the **sar** command can also show if these system calls are **read()**, **write()**, **fork()**, **exec()**, and others. Pay particular attention to the **fork/s** column. If this is high, then further investigation might be needed using the accounting utilities, the **trace** command, or the **tprof** command.

- **sar -q**

The **-q** option shows the run-queue size and the swap-queue size.

```
# sar -q 5 3

19:31:42 runq-sz %runocc swpq-sz %swpocc
19:31:47 1.0 100 1.0 100
19:31:52 2.0 100 1.0 100
19:31:57 1.0 100 1.0 100

Average 1.3 95 1.0 95
```

runq-sz

The average number of threads that are runnable per second and the percentage of time that the run queue was occupied (the % field is subject to error).

swpq-sz

The average number of threads in the VMM wait queue and the % of time that the swap queue was occupied. (The % field is subject to error.)

The **-q** option can indicate whether you have too many jobs running (**runq-sz**) or have a potential paging bottleneck. In a highly transactional system, for example Enterprise Resource Planning (ERP), the run queue can be in the hundreds, because each transaction uses small amounts of CPU time. If paging is the problem, run the **vmstat** command. High I/O wait indicates that there is significant competing disk activity or excessive paging due to insufficient memory.

The xmp perf program

Using the **xmp perf** program displays CPU use as a moving skyline chart. The **xmp perf** program is described in detail in the *Performance Toolbox Version 2 and 3 for AIX: Guide and Reference*.

Use of the time command to measure CPU use

Use the **time** command to understand the performance characteristics of a single program and its synchronous children. It reports the *real* time, that is the elapsed time from beginning to end of the program. It also reports the amount of CPU time used by the program. The CPU time is divided into user and sys. The user value is the time used by the program itself and any library subroutines it calls. The sys value is the time used by system calls invoked by the program (directly or indirectly).

The sum of user + sys is the total direct CPU cost of executing the program. This does not include the CPU costs of parts of the kernel that can be said to run on behalf of the program, but which do not actually run on its thread. For example, the cost of stealing page frames to replace the page frames taken from the free list when the program started is not reported as part of the program's CPU consumption.

On a uniprocessor, the difference between the real time and the total CPU time, that is:

```
real - (user + sys)
```

is the sum of all of the factors that can delay the program, plus the program's own unattributed costs. On an SMP, an approximation would be as follows:

```
real * number_of_processors - (user + sys)
```

In approximately the order of diminishing size, the factors can be:

- I/O required to bring in the program's text and data
- I/O required to acquire real memory for the program's use
- CPU time consumed by other programs
- CPU time consumed by the operating system

In the following example, the program used in the preceding section has been compiled with **-O3** to make it run more quickly. There is very little difference between the real (wall-clock) time required to run the program and the sum of its user and system CPU times. The program is getting all the time it wants, probably at the expense of other programs in the system.

```
# time looper
real    0m3.58s
user    0m3.16s
sys     0m0.04s
```

In the next example, we run the program at a less favorable priority by adding 10 to its nice value. It takes almost twice as long to run, but other programs are also getting a chance to do their work:

```
# time nice -n 10 looper
real    0m6.54s
user    0m3.17s
sys     0m0.03s
```

Note that we placed the **nice** command within the **time** command, rather than the reverse. If we had entered

```
# nice -n 10 time looper
```

we would have gotten a different **time** command (**/usr/bin/time**) with a lower-precision report, rather than the version of the **time** command we have been using, which is built into the **ksh** shell. If the **time** command comes first, you get the built-in version, unless you specify the fully qualified name of **/usr/bin/time**. If the **time** command is invoked from another command, you get **/usr/bin/time**.

Considerations of the time and timex commands

Take several considerations into account when you use either the **time** or the **timex** command:

- The use of the **/usr/bin/time** and **/usr/bin/timex** commands is not recommended. When possible, use the time subcommand of the Korn or C shell.
- The **timex -s** command uses the **sar** command to acquire additional statistics. Because the **sar** command is intrusive, the **timex -s** command is also. Especially for brief runs, the data reported by the **timex -s** command may not precisely reflect the behavior of a program in an unmonitored system.
- Because of the length of the system clock tick (10 milliseconds) and the rules used by the scheduler in attributing CPU time use to threads, the results of the **time** command are not completely deterministic. Because the time is sampled, there is a certain amount of unavoidable variation between successive runs. This variation is in terms of clock ticks. The shorter the run time of the program, the larger the variation as a percentage of the reported result (see Accessing the Processor Timer).
- Use of the **time** or **timex** command (whether from **/usr/bin** or through the built-in shell **time** function) to measure the user or system time of a sequence of commands connected by pipes, entered on the command line, is not recommended. One potential problem is that syntax oversights can cause the **time** command to measure only one of the commands, without any indication of a user error. The syntax is technically correct; it just does not produce the answer that the user intended.
- Although the **time** command syntax did not change, its output takes on a new meaning in an SMP environment:

On an SMP the real, or elapsed time may be smaller than the user time of a process. The user time is now the sum of all the times spent by the threads or the process on all processors.

If a process has four threads, running it on a uniprocessor (UP) system shows that the real time is greater than the user time:

```
# time 4threadedprog
real    0m11.70s
user    0m11.09s
sys     0m0.08s
```

Running it on a 4-way SMP system could show that the real time is only about 1/4 of the user time. The following output shows that the multithreaded process distributed its workload on several processors and improved its real execution time. The throughput of the system was therefore increased.

```
# time 4threadedprog
real    0m3.40s
user    0m9.81s
sys     0m0.09s
```

Identification of CPU-intensive programs

To locate the processes dominating CPU usage, there are two standard tools, the **ps** command and the **acctcom** command. Another tool to use is the **topas** monitor, which is described in Using the topas Monitor.

Using the ps command

The **ps** command is a flexible tool for identifying the programs that are running on the system and the resources they are using. It displays statistics and status information about processes on the system, such as process or thread ID, I/O activity, CPU and memory utilization. In this chapter, we discuss only the options and output fields that are relevant for CPU.

Three of the possible **ps** output columns report CPU use, each in a different way.

Column

Value Is:

C Recently used CPU time for the process (in units of clock ticks).

TIME Total CPU time used by the process since it started (in units of minutes and seconds).

%CPU Total CPU time used by the process since it started, divided by the elapsed time since the process started. This is a measure of the CPU dependence of the program.

CPU intensive

The following shell script:

```
# ps -ef | egrep -v "STIME|$LOGNAME" | sort +3 -r | head -n 15
```

is a tool for focusing on the highest recently used CPU-intensive user processes in the system (the header line has been reinserted for clarity):

```
UID  PID  PPID  C   STIME  TTY  TIME CMD
mary 45742 54702 120 15:19:05 pts/29 0:02 ./looper
root 52122 1 11 15:32:33 pts/31 58:39 xhogger
root 4250 1 3 15:32:33 pts/31 26:03 xmconsole allcon
root 38812 4250 1 15:32:34 pts/31 8:58 xmconstats 0 3 30
root 27036 6864 1 15:18:35 - 0:00 rlogind
root 47418 25926 0 17:04:26 - 0:00 coelogin <d29dbms:0>
bick 37652 43538 0 16:58:40 pts/4 0:00 /bin/ksh
bick 43538 1 0 16:58:38 - 0:07 aixterm
luc 60062 27036 0 15:18:35 pts/18 0:00 -ksh
```

Recent CPU use is the fourth column (C). The looping program's process easily heads the list. Observe that the C value may understate the looping process' CPU usage, because the scheduler stops counting at 120.

CPU time ratio

The **ps** command, run periodically, displays the CPU time under the TIME column and the ratio of CPU time to real time under the %CPU column. Look for the processes that dominate usage. The **au** and **v** options give similar information on user processes. The options **aux** and **vg** display both user and system processes.

The following example is taken from a four-way SMP system:

```
# ps au
USER      PID %CPU %MEM  SZ  RSS  TTY STAT   STIME  TIME  COMMAND
root      19048 24.6  0.0   28   44 pts/1 A    13:53:00 2:16 /tmp/cpubound
root      19388 0.0  0.0   372 460 pts/1 A      Feb 20 0:02 -ksh
root      15348 0.0  0.0   372 460 pts/4 A      Feb 20 0:01 -ksh
root      20418 0.0  0.0   368 452 pts/3 A      Feb 20 0:01 -ksh
root      16178 0.0  0.0   292 364 0 A      Feb 19 0:00 /usr/sbin/getty
root      16780 0.0  0.0   364 392 pts/2 A      Feb 19 0:00 -ksh
root      18516 0.0  0.0   360 412 pts/0 A      Feb 20 0:00 -ksh
root      15746 0.0  0.0   212 268 pts/1 A    13:55:18 0:00 ps au
```

The %CPU is the percentage of CPU time that has been allocated to that process since the process was started. It is calculated as follows:

$$(\text{process CPU time} / \text{process duration}) * 100$$

Imagine two processes: The first starts and runs five seconds, but does not finish; then the second starts and runs five seconds but does not finish. The **ps** command would now show 50 percent %CPU for the first process (five seconds CPU for 10 seconds of elapsed time) and 100 percent for the second (five seconds CPU for five seconds of elapsed time).

On an SMP, this value is divided by the number of available CPUs on the system. Looking back at the previous example, this is the reason why the %CPU value for the **cpubound** process will never exceed 25, because the example is run on a four-way processor system. The **cpubound** process uses 100 percent of one processor, but the %CPU value is divided by the number of available CPUs.

The THREAD option

The **ps** command can display threads and the CPUs that threads or processes are bound to by using the **ps -mo THREAD** command. The following is an example:

```
# ps -mo THREAD
USER PID  PPID  TID   ST CP PRI SC WCHAN F      TT   BND COMMAND
root 20918 20660 -     A  0  60  1  -     240001 pts/1 -   -ksh
-     -     -     20005 S  0  60  1  -     400   -   -   -
```

The TID column shows the thread ID, the BND column shows processes and threads bound to a processor.

It is normal to see a process named `kproc` (PID of 516 in operating system version 4) using CPU time. When there are no threads that can be run during a time slice, the scheduler assigns the CPU time for that time slice to this kernel process (`kproc`), which is known as the *idle* or *wait* `kproc`. SMP systems will have an *idle* `kproc` for each processor.

For complete details about the `ps` command, see the *AIX 5L Version 5.3 Commands Reference*.

The acctcom command

The **acctcom** command displays historical data on CPU usage if the accounting system is activated. Starting the accounting system puts a measurable overhead on the system. Therefore, activate accounting only if absolutely needed. To activate the accounting system, do the following:

1. Create an empty accounting file:

```
# touch acctfile
```

2. Turn on accounting:

```
# /usr/sbin/acct/accton acctfile
```

3. Allow accounting to run for a while and then turn off accounting:

```
# /usr/sbin/acct/accton
```

4. Display what accounting captured, as follows:

```
# /usr/sbin/acct/acctcom acctfile
COMMAND          START      END      REAL      CPU      MEAN
NAME             USER      TTYNAME  TIME      TIME     (SECS)   (SECS)   SIZE(K)
#accton          root      pts/2    19:57:18 19:57:18 0.02      0.02     184.00
#ps              root      pts/2    19:57:19 19:57:19 0.19      0.17     35.00
#ls              root      pts/2    19:57:20 19:57:20 0.09      0.03     109.00
#ps              root      pts/2    19:57:22 19:57:22 0.19      0.17     34.00
#accton          root      pts/2    20:04:17 20:04:17 0.00      0.00     0.00
#who             root      pts/2    20:04:19 20:04:19 0.02      0.02     0.00
```

If you reuse the same file, you can see when the newer processes were started by looking for the `accton` process (this was the process used to turn off accounting the first time).

Use of the pprof command to measure CPU usage of kernel threads

The **pprof** command reports CPU usage on all kernel threads running within an interval using the trace utility. The raw process information is saved to **pprof.flow** and five reports are generated. If no flags are specified, all reports are generated.

To determine whether the **pprof** program is installed and available, run the following command:

```
# ls1pp -lI bos.perf.tools
```

The types of reports are as follows:

pprof.cpu

Lists all kernel level threads sorted by actual CPU time. Contains: Process Name, Process ID, Parent Process ID, Process State at Beginning and End, Thread ID, Parent Thread ID, Actual CPU Time, Start Time, Stop Time, Stop - Start.

pprof.famcpu

Lists the information for all families (processes with a common ancestor). The Process Name and Process ID for the family is not necessarily the ancestor. Contains: Start Time, Process Name, Process ID, Number of Threads, Total CPU Time.

pprof.famind

Lists all processes grouped by families (processes with a common ancestor). Child process names are indented with respect to the parent. Contains: Start Time, Stop Time, Actual CPU Time, Process ID, Parent Process ID, Thread ID, Parent Thread ID, Process State at Beginning and End, Level, Process Name.

pprof.namecpu

Lists information about each type of kernel thread (all executable with the same name). Contains: Process Name, Number of Threads, CPU Time, % of Total CPU Time.

pprof.start

Lists all kernel threads sorted by start time that were dispatched during the the **pprof** command interval. Contains: Process Name, Process ID, Parent Process ID, Process State Beginning and End, Thread ID, Parent Thread ID, Actual CPU Time, Start Time, Stop Time, Stop - Start.

Following is a sample **pprof.namecpu** file that was generated by running the **tthreads32** program, which forks off four threads, which in turn each fork off a process of their own. These processes then execute several **ksh** and **sleep** programs:

```
Pprof PROCESS NAME Report

Sorted by CPU Time

From: Thu Oct 19 17:53:07 2000
To:   Thu Oct 19 17:53:22 2000

Pname #ofThreads CPU_Time %
=====
tthreads32      13    0.116  37.935
  sh             8     0.092  30.087
  Idle          2     0.055  17.987
  ksh           12     0.026   8.503
  trace         3     0.007   2.289
  java          3     0.006   1.962
  kproc         5     0.004   1.308
  xmservd       1     0.000   0.000
  trcstop       1     0.000   0.000
  swapper       1     0.000   0.000
  gil           1     0.000   0.000
  ls            4     0.000   0.000
  sleep         9     0.000   0.000
  ps            4     0.000   0.000
  syslogd       1     0.000   0.000
  nfsd          2     0.000   0.000
=====
              70    0.306 100.000
```

The corresponding **pprof.cpu** is as follows:

```
Pprof CPU Report

Sorted by Actual CPU Time

From: Thu Oct 19 17:53:07 2000
To:   Thu Oct 19 17:53:22 2000
```

E = Exec'd F = Forked
X = Exited A = Alive (when traced started or stopped)

C = Thread Created

| Pname | PID | PPID | BE | TID | PTID | ACC_time | STT_time | STP_time | STP-STT |
|------------|-------|-------|------|-------|-------|----------|----------|----------|---------|
| ===== | ===== | ===== | ==== | ===== | ===== | ===== | ===== | ===== | ===== |
| Idle | 774 | 0 | AA | 775 | 0 | 0.052 | 0.000 | 0.154 | 0.154 |
| tthreads32 | 5490 | 11982 | EX | 18161 | 22435 | 0.040 | 0.027 | 0.154 | 0.126 |
| sh | 11396 | 5490 | EE | 21917 | 5093 | 0.035 | 0.082 | 0.154 | 0.072 |
| sh | 14106 | 5490 | EE | 16999 | 18867 | 0.028 | 0.111 | 0.154 | 0.043 |
| sh | 13792 | 5490 | EE | 20777 | 18179 | 0.028 | 0.086 | 0.154 | 0.068 |
| ksh | 5490 | 11982 | FE | 18161 | 22435 | 0.016 | 0.010 | 0.027 | 0.017 |
| tthreads32 | 5490 | 11982 | CX | 5093 | 18161 | 0.011 | 0.056 | 0.154 | 0.098 |
| tthreads32 | 5490 | 11982 | CX | 18179 | 18161 | 0.010 | 0.054 | 0.154 | 0.099 |
| tthreads32 | 14506 | 5490 | FE | 17239 | 10133 | 0.010 | 0.128 | 0.143 | 0.015 |
| ksh | 11982 | 13258 | AA | 22435 | 0 | 0.010 | 0.005 | 0.154 | 0.149 |
| tthreads32 | 13792 | 5490 | FE | 20777 | 18179 | 0.010 | 0.059 | 0.086 | 0.027 |
| tthreads32 | 5490 | 11982 | CX | 18867 | 18161 | 0.010 | 0.057 | 0.154 | 0.097 |
| tthreads32 | 11396 | 5490 | FE | 21917 | 5093 | 0.009 | 0.069 | 0.082 | 0.013 |
| tthreads32 | 5490 | 11982 | CX | 10133 | 18161 | 0.008 | 0.123 | 0.154 | 0.030 |
| tthreads32 | 14106 | 5490 | FE | 16999 | 18867 | 0.008 | 0.088 | 0.111 | 0.023 |
| trace | 5488 | 11982 | AX | 18159 | 0 | 0.006 | 0.001 | 0.005 | 0.003 |
| kproc | 1548 | 0 | AA | 2065 | 0 | 0.004 | 0.071 | 0.154 | 0.082 |
| Idle | 516 | 0 | AA | 517 | 0 | 0.003 | 0.059 | 0.154 | 0.095 |
| java | 11612 | 11106 | AA | 14965 | 0 | 0.003 | 0.010 | 0.154 | 0.144 |
| java | 11612 | 11106 | AA | 14707 | 0 | 0.003 | 0.010 | 0.154 | 0.144 |
| trace | 12544 | 5488 | AA | 20507 | 0 | 0.001 | 0.000 | 0.001 | 0.001 |
| sh | 14506 | 5490 | EE | 17239 | 10133 | 0.001 | 0.143 | 0.154 | 0.011 |
| trace | 12544 | 5488 | CA | 19297 | 20507 | 0.000 | 0.001 | 0.154 | 0.153 |
| ksh | 4930 | 2678 | AA | 5963 | 0 | 0.000 | 0.154 | 0.154 | 0.000 |
| kproc | 6478 | 0 | AA | 3133 | 0 | 0.000 | 0.154 | 0.154 | 0.000 |
| ps | 14108 | 5490 | EX | 17001 | 18867 | 0.000 | 0.154 | 0.154 | 0.000 |
| tthreads32 | 13794 | 5490 | FE | 20779 | 18179 | 0.000 | 0.154 | 0.154 | 0.000 |
| sh | 13794 | 5490 | EE | 20779 | 18179 | 0.000 | 0.154 | 0.154 | 0.000 |
| ps | 13794 | 5490 | EX | 20779 | 18179 | 0.000 | 0.154 | 0.154 | 0.000 |
| sh | 14108 | 5490 | EE | 17001 | 18867 | 0.000 | 0.154 | 0.154 | 0.000 |
| tthreads32 | 14108 | 5490 | FE | 17001 | 18867 | 0.000 | 0.154 | 0.154 | 0.000 |
| ls | 13792 | 5490 | EX | 20777 | 18179 | 0.000 | 0.154 | 0.154 | 0.000 |
| : | | | | | | | | | |
| : | | | | | | | | | |
| : | | | | | | | | | |

Detection of instruction emulation with the emstat tool

To maintain compatibility with older binaries, the AIX kernel includes emulation routines that provide support for instructions that might not be included in a particular chip architecture. Attempting to execute a non-supported instruction results in an illegal instruction exception. The kernel decodes the illegal instruction, and if it is a non-supported instruction, the kernel runs an emulation routine that functionally emulates the instruction.

However, depending upon the execution frequency of non-supported instructions and the their emulation path lengths, emulation can result in varying degrees of performance degradation due to kernel context switch and instruction emulation overhead. Even a very small percentage of emulation might result in a big performance difference. The following table shows estimated instruction path lengths for several of the non-supported instructions:

| Instruction | Emulated in | Estimated Path Length (instructions) |
|-------------|-------------|--------------------------------------|
| abs | assembler | 117 |
| doz | assembler | 120 |
| mul | assembler | 127 |
| rlmi | C | 425 |

| Instruction | Emulated in | Estimated Path Length (instructions) |
|-------------|-------------|--------------------------------------|
| sle | C | 447 |
| clf | C | 542 |
| div | C | 1079 |

Instructions that are not common on all platforms must be removed from code written in assembler, because recompilation is only effective for high-level source code. Routines coded in assembler must be changed so that they do not use missing instructions, because recompilation has no effect in this case.

The first step is to determine if instruction emulation is occurring by using the **emstat** tool.

To determine whether the **emstat** program is installed and available, run the following command:

```
# ls1pp -lI bos.perf.tools
```

The **emstat** command works similarly to the **vmstat** command in that you specify an interval time in seconds, and optionally, the number of intervals. The value in the first column is the cumulative count since system boot, while the value in the second column is the number of instructions emulated during that interval. Emulations on the order of many thousands per second can have an impact on performance.

The following is an example of output from issuing the **emstat 1** command:

```
# emstat 1

Emulation   Emulation
SinceBoot   Delta
      0         0
      0         0
      0         0
```

Once emulation has been detected, the next step is to determine which application is emulating instructions. This is much harder to determine. One way is to run only one application at a time and monitor it with the **emstat** program. Sometimes certain emulations cause a trace hook to be encountered. This can be viewed in the ASCII trace report file with the words PROGRAM CHECK. The process/thread associated with this trace event is emulating instructions either due to its own code emulating instructions, or it is executing library or code in other modules that are emulating instructions.

Detection of alignment exceptions with the alstat tool

AIX compilers perform natural alignment of data types. For example, data of type short, which is 2 bytes long, is padded automatically to 4 bytes by the compiler. Common programming practices such as typecasting and usage of alignment pragmas can cause application data to be aligned incorrectly. POWER-based optimization assumes correct alignment of data. Thus, fetching misaligned data may require multiple memory accesses where a single access should have sufficed. Misalignment of data can cause the hardware to generate an alignment exception, which would force the kernel to simulate the needed memory accesses. As with the case of instruction emulation, this can degrade application performance.

The **alstat** tool packaged with **bos.perf.tools** can be used to detect if alignment exceptions are occurring. To show alignment exceptions on a per-CPU basis, use the **-v** option.

Because **alstat** and **emstat** are the same binary, either of these tools can be used to show instruction emulation and alignment exceptions. To show instruction emulation, use the **-e** option on **alstat**. To show alignment exceptions, use the **-a** option on **emstat**.

The output for **alstat** looks similar to the following:

```
# alstat -e 1
Alignment  Alignment  Emulation  Emulation
SinceBoot  Delta      SinceBoot  Delta
          0          0          0          0
          0          0          0          0
          0          0          0          0
```

Restructure of executable programs with the fdpr program

The **fdpr** (feedback-directed program restructuring) program optimizes executable modules for faster execution and more efficient use of real memory. To determine whether the **fdpr** program is installed and available on your system, run the following command:

```
# ls1pp -lI perfagent.tools
```

The **fdpr** command is a performance-tuning utility that can improve both performance and real memory utilization of user-level application programs. The source code is not necessary as input to the **fdpr** program. However, stripped executable programs are not supported. If source code is available, programs built with the **-qfdpr** compiler flag contain information to assist the **fdpr** program in producing reordered programs with guaranteed functionality. If the **-qfdpr** flag is used, it should be used for all object modules in a program. Static linking will not enhance performance if the **-qfdpr** flag is used.

The **fdpr** tool reorders the instructions in an executable program to improve instruction cache, Translation Lookaside Buffer (TLB), and real memory utilization by doing the following:

- Packing together highly executed code sequences (as determined through profiling)
- Recoding conditional branches to improve hardware branch prediction
- Moving infrequently executed code out of line

For example, given an "if-then-else" statement, the **fdpr** program might conclude that the program uses the else branch more often than the if branch. It will then reverse the condition and the two branches as shown in the following figure.

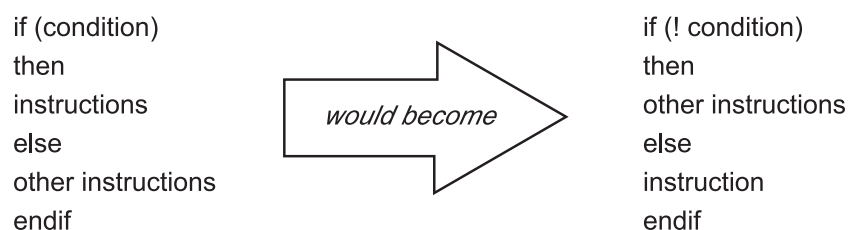

Figure 16. Example of Conditional Branch Recoding. The illustration shows how conditional branch recoding changes certain code. For example, the code `If (condition)` would become `If (! condition)`; the code `then` stays `then`; `instructions` becomes `other instructions`; `else` stays `else`; `other instructions` become `instruction`; and `endif` stays `endif`.

Large applications (larger than 5 MB) that are CPU-bound can improve execution time up to 23 percent, but typically the performance is improved between 5 and 20 percent. The reduction of real memory requirements for text pages for this type of program can reach 70 percent. The average is between 20 and 50 percent. The numbers depend on the application's behavior and the optimization options issued when using the **fdpr** program.

The **fdpr** processing takes place in three stages:

1. The executable module to be optimized is instrumented to allow detailed performance-data collection.
2. The instrumented executable module is run in a workload provided by the user, and performance data from that run is recorded.
3. The performance data is used to drive a performance-optimization process that results in a restructured executable module that should perform the workload that exercised the instrumented

executable program more efficiently. It is critically important that the workload used to drive the **fdpr** program closely match the actual use of the program. The performance of the restructured executable program with workloads that differ substantially from that used to drive the **fdpr** program is unpredictable, but can be worse than that of the original executable program.

As an example, the command

```
# fdpr -p ProgramName -R3 -x test.sh
```

would use the testcase **test.sh** to run an instrumented form of program **ProgramName**. The output of that run would be used to perform the most aggressive optimization (**-R3**) of the program to form a new module called, by default, **ProgramName.fdpr**. The degree to which the optimized executable program performed better in production than its unoptimized predecessor would depend largely on the degree to which the testcase **test.sh** successfully imitated the production workload.

Note: The **fdpr** program incorporates advanced optimization algorithms that sometimes result in optimized executable programs that do not function in the same way as the original executable module. It is *absolutely essential* that any optimized executable program be thoroughly tested before being used in any production situation; that is, before its output is trusted.

In summary, users of the **fdpr** program should adhere to the following:

- Take pains to use a workload to drive the **fdpr** program that is representative of the intended use.
- Thoroughly test the functioning of the resulting restructured executable program.
- Use the restructured executable program only on the workload for which it has been tuned.

Controlling contention for the CPU

Although the AIX kernel dispatches threads to the various processors, most of the system management tools refer to the process in which the thread is running rather than the thread itself.

Controlling the priority of user processes

User-process priorities can be manipulated using the **nice** or **renice** command or the **setpri()** subroutine, and displayed with the **ps** command. An overview of priority is provided in Process and Thread Priority.

Priority calculation is employed to accomplish the following:

- Share the CPU among threads
- Prevent starvation of any thread
- Penalize compute-bound threads
- Increase continuous discrimination between threads over time

Running a command with the nice command

Any user can run a command at a less-favorable-than-normal priority by using the **nice** command. Only the root user can use the **nice** command to run commands at a more-favorable-than-normal priority. In this case, the **nice** command values range between -20 and 19.

With the **nice** command, the user specifies a value to be added to or subtracted from the standard **nice** value. The modified **nice** value is used for the process that runs the specified command. The priority of the process is still non-fixed; that is, the priority value is still recalculated periodically based on the CPU usage, **nice** value, and minimum user-process-priority value.

The standard **nice** value of a foreground process is 20 (24 for a ksh background process). The following command would cause the **vmstat** command to be run in the foreground with a **nice** value of 25 (instead of the standard 20), resulting in a less favorable priority.

```
# nice -n 5 vmstat 10 3 > vmstat.out
```

If you use the root login, the **vmstat** command can be run at a more favorable priority with the following:

```
# nice -n -5 vmstat 10 3 > vmstat.out
```

If you were not using root login and issued the preceding example **nice** command, the **vmstat** command would still be run but at the standard **nice** value of 20, and the **nice** command would not issue any error message.

Setting a fixed priority with the **setpri** subroutine

An application that runs under the root user ID can use the **setpri()** subroutine to set its own priority or that of another process. For example:

```
retcode = setpri(0,59);
```

would give the current process a fixed priority of 59. If the **setpri()** subroutine fails, it returns -1.

The following program accepts a priority value and a list of process IDs and sets the priority of all of the processes to the specified value.

```
/*
  fixprocpri.c
  Usage: fixprocpri priority PID . . .
*/

#include <sys/sched.h>
#include <stdio.h>
#include <sys/errno.h>

main(int argc, char **argv)
{
  pid_t ProcessID;
  int Priority, ReturnP;

  if( argc < 3 ) {
    printf(" usage - setpri priority pid(s) \n");
    exit(1);
  }

  argv++;
  Priority=atoi(*argv++);
  if ( Priority < 50 ) {
    printf(" Priority must be >= 50 \n");
    exit(1);
  }

  while (*argv) {
    ProcessID=atoi(*argv++);
    ReturnP = setpri(ProcessID, Priority);
    if ( ReturnP > 0 )
      printf("pid=%d new pri=%d old pri=%d\n",
             (int)ProcessID, Priority, ReturnP);
    else {
      perror(" setpri failed ");
      exit(1);
    }
  }
}
```

Displaying process priority with the **ps** command

The **-l** (lowercase L) flag of the **ps** command displays the nice values and current priority values of the specified processes. For example, you can display the priorities of all of the processes owned by a given user with the following:

```
# ps -lu user1
  F S UID  PID PPID  C PRI NI ADDR  SZ  WCHAN  TTY  TIME CMD
241801 S 200 7032 7286  0  60 20 1b4c  108          pts/2  0:00 ksh
200801 S 200 7568 7032  0  70 25 2310  88  5910a58 pts/2  0:00 vmstat
241801 S 200 8544 6494  0  60 20 154b  108          pts/0  0:00 ksh
```

The output shows the result of the **nice -n 5** command described previously. Process 7568 has an inferior priority of 70. (The **ps** command was run by a separate session in superuser mode, hence the presence of two TTYs.)

If one of the processes had used the **setpri(10758, 59)** subroutine to give itself a fixed priority, a sample **ps -l** output would be as follows:

```
  F S UID  PID PPID  C PRI NI ADDR  SZ  WCHAN  TTY  TIME CMD
200903 S   0 10758 10500  0  59 -- 3438  40  4f91f98 pts/0  0:00 fixpri
```

Modifying the priority with the renice command

The **renice** command alters the **nice** value, and thus the priority, of one or more processes that are already running. The processes are identified either by process ID, process group ID, or the name of the user who owns the processes.

The **renice** command cannot be used on fixed-priority processes. A non-root user can specify a value to be added to, but not subtracted from the **nice** value of one or more running processes. The modification is done to the **nice** values of the processes. The priority of these processes is still non-fixed. Only the root user can use the **renice** command to alter the priority value within the range of -20 to 20, or subtract from the **nice** value of one or more running processes.

To continue the example, use the **renice** command to alter the **nice** value of the **vmstat** process that you started with **nice**.

```
# renice -n -5 7568
# ps -lu user1
  F S UID  PID PPID  C PRI NI ADDR  SZ  WCHAN  TTY  TIME CMD
241801 S 200 7032 7286  0  60 20 1b4c  108          pts/2  0:00 ksh
200801 S 200 7568 7032  0  60 20 2310  92  5910a58 pts/2  0:00 vmstat
241801 S 200 8544 6494  0  60 20 154b  108          pts/0  0:00 ksh
```

Now the process is running at a more favorable priority that is equal to the other foreground processes. To undo the effects of this, you could issue the following:

```
# renice -n 5 7569
# ps -lu user1
  F S UID  PID PPID  C PRI NI ADDR  SZ  WCHAN  TTY  TIME CMD
241801 S 200 7032 7286  0  60 20 1b4c  108          pts/2  0:00 ksh
200801 S 200 7568 7032  1  70 25 2310  92  5910a58 pts/2  0:00 vmstat
241801 S 200 8544 6494  0  60 20 154b  108          pts/0  0:00 ksh
```

In these examples, the **renice** command was run by the root user. When run by an ordinary user ID, there are two major limitations to the use of the **renice** command:

- Only processes owned by that user ID can be specified.
- The **nice** value of the process cannot be decreased, not even to return the process to the default priority after making its priority less favorable with the **renice** command.

Clarification of the nice and renice command syntax

The **nice** and **renice** commands have different ways of specifying the amount that is to be added to the standard **nice** value of 20.

| Command | Command | Resulting nice Value | Best Priority Value |
|------------------|--------------------|----------------------|---------------------|
| nice -n 5 | renice -n 5 | 25 | 70 |

| | | | |
|-------------------------|---------------------------|----|----|
| <code>nice -n +5</code> | <code>renice -n +5</code> | 25 | 70 |
| <code>nice -n -5</code> | <code>renice -n -5</code> | 15 | 55 |

Thread-Priority-Value calculation

This section discusses tuning using the following:

- Priority Calculation
- The **schedo** command

The **schedo** command allows you to change some of the CPU scheduler parameters used to calculate the priority value for each thread. See Process and Thread Priority for background information on priority.

To determine whether the **schedo** program is installed and available, run the following command:

```
# ls1pp -lI bos.perf.tune
```

Priority calculation

The formula for calculating the priority value is:

priority value = base priority + nice penalty + (CPU penalty based on recent CPU usage)

The recent CPU usage value of a given thread is incremented by 1 each time that thread is in control of the CPU when the timer interrupt occurs (every 10 milliseconds). The recent CPU usage value is displayed as the C column in the **ps** command output. The maximum value of recent CPU usage is 120.

The default algorithm calculates the CPU penalty by dividing recent CPU usage by 2. The CPU-penalty-to-recent-CPU-usage ratio is therefore 0.5. This ratio is controlled by a value called *R* (the default is 16). The formula is as follows:

$$\text{CPU_penalty} = C * R/32$$

Once a second, the default algorithm divides the recent CPU usage value of every thread by 2. The recent-CPU-usage-decay factor is therefore 0.5. This factor is controlled by a value called *D* (the default is 16). The formula is as follows:

$$C = C * D/32$$

The algorithm for calculating priority value uses the **nice** value of the process to determine the priority of the threads in the process. As the units of CPU time increase, the priority decreases with the nice effect. Using `schedo -r -d` can give additional control over the priority calculation by setting new values for *R* and *D*. See “The schedo command” for further information.

Begin with the following equation:

$$p_nice = \text{base priority} + \text{nice value}$$

Now use the following formula:

```
If p_nice > 60,
    then x_nice = (p_nice * 2) - 60,
    else x_nice = p_nice.
```

If the nice value is greater than 20, then it has double the impact on the priority value than if it was less than or equal to 20. The new priority calculation (ignoring integer truncation) is as follows:

$$\text{priority value} = x_nice + [(x_nice + 4)/64 * C*(R/32)]$$

The schedo command

Tuning is accomplished through two options of the **schedo** command: **sched_R** and **sched_D**. Each option specifies a parameter that is an integer from 0 through 32. The parameters are applied by

multiplying by the parameter's value and then dividing by 32. The default *R* and *D* values are 16, which yields the same behavior as the original algorithm $[(D=R=16)/32=0.5]$. The new range of values permits a far wider spectrum of behaviors. For example:

```
# schedo -o sched_R=0
```

$[(R=0)/32=0, (D=16)/32=0.5]$ would mean that the CPU penalty was always 0, making priority a function of the nice value only. No background process would get any CPU time unless there were no dispatchable foreground processes at all. The priority values of the threads would effectively be constant, although they would not technically be fixed-priority threads.

```
# schedo -o sched_R=5
```

$[(R=5)/32=0.15625, (D=16)/32=0.5]$ would mean that a foreground process would never have to compete with a background process started with the command **nice -n 10**. The limit of 120 CPU time slices accumulated would mean that the maximum CPU penalty for the foreground process would be 18.

```
# schedo -o sched_R=6 -o sched_D=16
```

$[(R=6)/32=0.1875, (D=16)/32=0.5]$ would mean that, if the background process were started with the command **nice -n 10**, it would be at least one second before the background process began to receive any CPU time. Foreground processes, however, would still be distinguishable on the basis of CPU usage. Long-running foreground processes that should probably be in the background would ultimately accumulate enough CPU usage to keep them from interfering with the true foreground.

```
# schedo -o sched_R=32 -o sched_D=32
```

$[(R=32)/32=1, (D=32)/32=1]$ would mean that long-running threads would reach a C value of 120 and remain there, contending on the basis of their nice values. New threads would have priority, regardless of their nice value, until they had accumulated enough time slices to bring them within the priority value range of the existing threads.

Here are some guidelines for *R* and *D*:

- Smaller values of *R* narrow the priority range and make the nice value have more of an impact on the priority.
- Larger values of *R* widen the priority range and make the nice value have less of an impact on the priority.
- Smaller values of *D* decay CPU usage at a faster rate and can cause CPU-intensive threads to be scheduled sooner.
- Larger values of *D* decay CPU usage at a slower rate and penalize CPU-intensive threads more (thus favoring interactive-type threads).

Example of a priority calculation

The example shows *R*=4 and *D*=31 and assumes no other runnable threads:

| time | current_effective_priority | base | process priority | nice value | count | (time slices consumed) |
|------------|----------------------------|------|------------------|------------|-------|------------------------|
| | | | | | | (schedo -o sched_R) |
| time 0 | p = 40 | + 20 | + (0 | * 4/32) | = 60 | |
| time 10 ms | p = 40 | + 20 | + (1 | * 4/32) | = 60 | |
| time 20 ms | p = 40 | + 20 | + (2 | * 4/32) | = 60 | |
| time 30 ms | p = 40 | + 20 | + (3 | * 4/32) | = 60 | |
| time 40 ms | p = 40 | + 20 | + (4 | * 4/32) | = 60 | |
| time 50 ms | p = 40 | + 20 | + (5 | * 4/32) | = 60 | |
| time 60 ms | p = 40 | + 20 | + (6 | * 4/32) | = 60 | |
| time 70 ms | p = 40 | + 20 | + (7 | * 4/32) | = 60 | |
| time 80 ms | p = 40 | + 20 | + (8 | * 4/32) | = 61 | |
| time 90 ms | p = 40 | + 20 | + (9 | * 4/32) | = 61 | |
| time 100ms | p = 40 | + 20 | + (10 | * 4/32) | = 61 | |

(skipping forward to 1000msec or 1 second)

```
time 1000ms    p = 40 + 20 + (100 * 4/32) = 72
time 1000ms    swapper recalculates the accumulated CPU usage counts of
                all processes. For the above process:
                new_CPU_usage = 100 * 31/32 = 96 (if d=31)
                after decaying by the swapper: p = 40 + 20 + ( 96 * 4/32) = 72
                (if d=16, then p = 40 + 20 + (100/2 * 4/32) = 66)
time 1010ms    p = 40 + 20 + ( 97 * 4/32) = 72
time 1020ms    p = 40 + 20 + ( 98 * 4/32) = 72
time 1030ms    p = 40 + 20 + ( 99 * 4/32) = 72
                ..
time 1230ms    p = 40 + 20 + (119 * 4/32) = 74
time 1240ms    p = 40 + 20 + (120 * 4/32) = 75    count <= 120
time 1250ms    p = 40 + 20 + (120 * 4/32) = 75
time 1260ms    p = 40 + 20 + (120 * 4/32) = 75
                ..
time 2000ms    p = 40 + 20 + (120 * 4/32) = 75
time 2000ms    swapper recalculates the counts of all processes.
                For above process 120 * 31/32 = 116
time 2010ms    p = 40 + 20 + (117 * 4/32) = 74
```

Modification of the scheduler time slice with the schedo command

The length of the scheduler time slice can be modified with the **schedo** command. To change the time slice, use the **schedo -o timeslice=value** option.

The value of **-t** is the number of ticks for the time slice and only SCHED_RR threads will use the nondefault time slice value (see Scheduling Policy for Threads for a description of fixed priority threads).

Changing the time slice takes effect instantly and does not require a reboot.

A thread running with SCHED_OTHER or SCHED_RR scheduling policy can use the CPU for up to a full time slice (the default time slice being 1 clock tick), a clock tick being 10 ms.

In some situations, too much context switching is occurring and the overhead of dispatching threads can be more costly than allowing these threads to run for a longer time slice. In these cases, increasing the time slice might have a positive impact on the performance of fixed-priority threads. Use the **vmstat** and **sar** commands for determining the number of context switches per second.

In an environment in which the length of the time slice has been increased, some applications might not need or should not have the full time slice. These applications can give up the processor explicitly with the **yield()** system call (as can programs in an unmodified environment). After a **yield()** call, the calling thread is moved to the end of the dispatch queue for its priority level.

CPU-efficient user id administration with the mkpasswd command

To improve login response time and conserve CPU time in systems with many users, the operating system can use an indexed version of the **/etc/passwd** file to look up user IDs. When this facility is used, the **/etc/passwd** file still exists, but is not used in normal processing. The indexed versions of the file are built by the **mkpasswd** command. If the indexed versions are not current, login processing reverts to a slow, CPU-intensive sequential search through **/etc/passwd**.

The command to create indexed password files is **mkpasswd -f**. This command creates indexed versions of **/etc/passwd**, **/etc/security/passwd**, and **/etc/security/lastlog**. The files created are **/etc/passwd.nm.idx**, **/etc/passwd.id.idx**, **/etc/security/passwd.idx**, and **/etc/security/lastlog.idx**. Note that this will greatly enhance performance of applications that also need the encrypted password (such as login and any other program that needs to do password authentication).

Applications can also be changed to use alternative routines such as `_getpwent()` instead of `getpwent()`, `_getpwnam_shadow(name,0)` instead of `getpwnam(name)`, or `_getpwuid_shadow(uid,0)` instead of `getpwuid(uid)` to do name/ID resolution in cases where the encrypted password is not needed. This prevents a lookup of `/etc/security/passwd`.

Do not edit the password files by hand because the time stamps of the database files (`.idx`) will not be in sync and the default lookup method (linear) will be used. If the `passwd`, `mkuser`, `chuser`, `rmuser` commands (or the SMIT command equivalents, with fast paths of the same name) are used to administer user IDs, the indexed files are kept up to date automatically. If the `/etc/passwd` file is changed with an editor or with the `pwdadm` command, the index files must be rebuilt.

Note: The `mkpasswd` command does not affect NIS, DCE, or LDAP user databases.

Chapter 11. Memory performance

The memory of a system is almost constantly filled to capacity. Even if currently running programs do not consume all available memory, the operating system retains in memory the text pages of programs that ran earlier and the files that they used. There is no cost associated with this retention, because the memory would have been unused anyway. In many cases, the programs or files will be used again, which reduces disk I/O.

This topic describes how memory use can be measured and modified. It contains the following major sections:

- Memory usage
- Memory-leaking programs
- Memory requirements assessment with the `rmss` command
- VMM memory load control tuning with the `schedo` command
- VMM page replacement tuning
- Page space allocation
- Paging-space threshold tuning
- Paging space garbage collection
- Shared memory
- AIX memory affinity support
- Large page feature on AIX

Readers who are not familiar with the operating system's virtual-memory management may want to look at Performance overview of the Virtual Memory Manager (VMM) before continuing.

Memory usage

Several performance tools provide memory usage reports. The reports of most interest are from the `vmstat`, `ps`, and `svmon` commands.

Memory usage determination with the `vmstat` command

The `vmstat` command summarizes the total *active* virtual memory used by all of the processes in the system, as well as the number of real-memory page frames on the free list. Active virtual memory is defined as the number of virtual-memory working segment pages that have actually been touched. For a more detailed definition, see Late page space allocation. This number can be larger than the number of real page frames in the machine, because some of the active virtual-memory pages may have been written out to paging space.

When determining if a system might be short on memory or if some memory tuning needs to be done, run the `vmstat` command over a set interval and examine the `pi` and `po` columns on the resulting report. These columns indicate the number of paging space page-ins per second and the number of paging space page-outs per second. If the values are constantly non-zero, there might be a memory bottleneck. Having occasional non-zero values is not be a concern because paging is the main principle of virtual memory.

```
# vmstat 2 10
kthr      memory          page          faults          cpu
-----
 r  b   avm   fre  re  pi  po  fr   sr  cy  in  sy  cs  us  sy  id  wa
1  3 113726   124   0  14   6  151  600   0  521 5533 816 23 13  7  57
0  3 113643   346   0   2  14  208  690   0  585 2201 866 16  9  2  73
0  3 113659   135   0   2   2  108  323   0  516 1563 797 25  7  2  66
0  2 113661   122   0   3   2  120  375   0  527 1622 871 13  7  2  79
0  3 113662   128   0  10   3  134  432   0  644 1434 948 22  7  4  67
1  5 113858   238   0  35   1  146  422   0  599 5103 903 40 16  0  44
```

```

0 3 113969 127 0 5 10 153 529 0 565 2006 823 19 8 3 70
0 3 113983 125 0 33 5 153 424 0 559 2165 921 25 8 4 63
0 3 113682 121 0 20 9 154 470 0 608 1569 1007 15 8 0 77
0 4 113701 124 0 3 29 228 635 0 674 1730 1086 18 9 0 73

```

In the example output above, notice the high I/O wait in the output and also the number of threads on the blocked queue. Other I/O activities might cause I/O wait, but in this particular case, the I/O wait is most likely due to the paging in and out from paging space.

To see if the system has performance problems with its VMM, examine the columns under memory and page:

- **memory**

Provides information about the real and virtual memory.

- **avm**

The Active Virtual Memory, **avm**, column represents the number of active virtual memory pages present at the time the **vmstat** sample was collected. The deferred page space policy is the default policy. Under this policy, the value for **avm** might be higher than the number of paging space pages used. The **avm** statistics do not include file pages.

- **fre**

The **fre** column shows the average number of free memory pages. A page is a 4 KB area of real memory. The system maintains a buffer of memory pages, called the free list, that will be readily accessible when the VMM needs space. The minimum number of pages that the VMM keeps on the free list is determined by the **minfree** parameter of the **vmo** command. For more details, see VMM page replacement tuning.

When an application terminates, all of its working pages are immediately returned to the free list. Its persistent pages, or files, however, remain in RAM and are not added back to the free list until they are stolen by the VMM for other programs. Persistent pages are also freed if the corresponding file is deleted.

For this reason, the **fre** value may not indicate all the real memory that can be readily available for use by processes. If a page frame is needed, then persistent pages related to terminated applications are among the first to be handed over to another program.

If the **fre** value is substantially above the **maxfree** value, it is unlikely that the system is *thrashing*. Thrashing means that the system is continuously paging in and out. However, if the system is experiencing thrashing, you can be assured that the **fre** value will be small.

- **page**

Information about page faults and paging activity. These are averaged over the interval and given in units per second.

- **re**

Note: This column is currently not supported.

- **pi**

The **pi** column details the number of pages paged in from paging space. Paging space is the part of virtual memory that resides on disk. It is used as an overflow when memory is over committed. Paging space consists of logical volumes dedicated to the storage of working set pages that have been stolen from real memory. When a stolen page is referenced by the process, a page fault occurs, and the page must be read into memory from paging space.

Due to the variety of configurations of hardware, software and applications, there is no absolute number to look out for. This field is important as a key indicator of paging-space activity. If a page-in occurs, there must have been a previous page-out for that page. It is also likely in a memory-constrained environment that each page-in will force a different page to be stolen and, therefore, paged out.

- **po**

The `po` column shows the number (rate) of pages paged out to paging space. Whenever a page of working storage is stolen, it is written to paging space, if it does not yet reside in paging space or if it was modified. If not referenced again, it will remain on the paging device until the process terminates or disclaims the space. Subsequent references to addresses contained within the faulted-out pages results in page faults, and the pages are paged in individually by the system. When a process terminates normally, any paging space allocated to that process is freed. If the system is reading in a significant number of persistent pages, you might see an increase in `po` without corresponding increases in `pi`. This does not necessarily indicate thrashing, but may warrant investigation into data-access patterns of the applications.

– **fr**

Number of pages that were freed per second by the page-replacement algorithm during the interval. As the VMM page-replacement routine scans the Page Frame Table, or PFT, it uses criteria to select which pages are to be stolen to replenish the free list of available memory frames. The criteria include both kinds of pages, working (computational) and file (persistent) pages. Just because a page has been freed, it does not mean that any I/O has taken place. For example, if a persistent storage (file) page has not been modified, it will not be written back to the disk. If I/O is not necessary, minimal system resources are required to free a page.

– **sr**

Number of pages that were examined per second by the page-replacement algorithm during the interval. The page-replacement algorithm might have to scan many page frames before it can steal enough to satisfy the page-replacement thresholds. The higher the **sr** value compared to the **fr** value, the harder it is for the page-replacement algorithm to find eligible pages to steal.

– **cy**

Number of cycles per second of the clock algorithm. The VMM uses a technique known as the clock algorithm to select pages to be replaced. This technique takes advantage of a referenced bit for each page as an indication of what pages have been recently used (referenced). When the page-stealer routine is called, it cycles through the PFT, examining each page's referenced bit.

The `cy` column shows how many times per second the page-replacement code has scanned the PFT. Because the free list can be replenished without a complete scan of the PFT and because all of the **vmstat** fields are reported as integers, this field is usually zero.

One way to determine the appropriate amount of RAM for a system is to look at the largest value for `avm` as reported by the **vmstat** command. Multiply that by 4 K to get the number of bytes and then compare that to the number of bytes of RAM on the system. Ideally, `avm` should be smaller than total RAM. If not, some amount of virtual memory paging will occur. How much paging occurs will depend on the difference between the two values. Remember, the idea of virtual memory is that it gives us the capability of addressing more memory than we have (some of the memory is in RAM and the rest is in paging space). But if there is far more virtual memory than real memory, this could cause excessive paging which then results in delays. If `avm` is lower than RAM, then paging-space paging could be caused by RAM being filled up with file pages. In that case, tuning the **minperm**, **maxperm**, and **maxclient** values could reduce the amount of paging-space paging. Refer to VMM page replacement tuning with the `vmo` command for more information.

The **vmstat -l** command

The **vmstat -l** command displays additional information, such as file pages in per-second, file pages out per-second which means any VMM page-ins and page-outs that are not paging space page-ins or paging space page-outs. The `re` and `cy` columns are not reported with this flag.

The **vmstat -s** command

The summary option, **-s**, sends a summary report to standard output starting from system initialization expressed in absolute counts rather than on an interval basis. The recommended way of using these statistics is to run this command before a workload, save the output, and then run it again after the

workload and save its output. The next step is to determine the difference between the two sets of output. An **awk** script called **vmstatit** that does this automatically is provided in Determining whether the problem is related to disk or memory.

```
# vmstat -s
3231543 total address trans. faults
 63623 page ins
383540 page outs
  149 paging space page ins
  832 paging space page outs
   0 total reclaims
807729 zero filled pages faults
 4450 executable filled pages faults
429258 pages examined by clock
   8 revolutions of the clock hand
175846 pages freed by the clock
18975 backtracks
   0 lock misses
  40 free frame waits
   0 extend XPT waits
16984 pending I/O waits
186443 start I/Os
186443 iodones
141695229 cpu context switches
317690215 device interrupts
   0 software interrupts
   0 traps
55102397 syscalls
```

The page-in and page-out numbers in the summary represent virtual memory activity to page in or out pages from page space and file space. The paging space ins and outs are representative of only page space.

Memory usage determination with the ps command

The **ps** command can also be used to monitor memory usage of individual processes. The **ps v PID** command provides the most comprehensive report on memory-related statistics for an individual process, such as:

- Page faults
- Size of working segment that has been touched
- Size of working segment and code segment in memory
- Size of text segment
- Size of resident set
- Percentage of real memory used by this process

The following is an example:

```
# ps v
  PID  TTY STAT  TIME PGIN  SIZE  RSS  LIM  TSIZ  TRS  %CPU  %MEM  COMMAND
36626 pts/3 A    0:00   0   316  408 32768  51   60  0.0  0.0 ps v
```

The most important columns on the resulting **ps** report are described as follows:

PGIN Number of page-ins caused by page faults. Since all I/O is classified as page faults, this is basically a measure of I/O volume.

SIZE Virtual size (in paging space) in kilobytes of the data section of the process (displayed as SZ by other flags). This number is equal to the number of working segment pages of the process that have been touched times 4. If some working segment pages are currently paged out, this number is larger than the amount of real memory being used. SIZE includes pages in the private segment and the shared-library data segment of the process.

- RSS** Real-memory (resident set) size in kilobytes of the process. This number is equal to the sum of the number of working segment and code segment pages in memory times 4. Remember that code segment pages are shared among all of the currently running instances of the program. If 26 **ksh** processes are running, only one copy of any given page of the **ksh** executable program would be in memory, but the **ps** command would report that code segment size as part of the RSS of each instance of the **ksh** program.
- TSIZ** Size of text (shared-program) image. This is the size of the text section of the executable file. Pages of the text section of the executable program are only brought into memory when they are touched, that is, branched to or loaded from. This number represents only an upper bound on the amount of text that could be loaded. The TSIZ value does not reflect actual memory usage. This TSIZ value can also be seen by executing the **dump -ov** command against an executable program (for example, **dump -ov /usr/bin/lis**).
- TRS** Size of the resident set (real memory) of text. This is the number of code segment pages times 4. This number exaggerates memory use for programs of which multiple instances are running. The TRS value can be higher than the TSIZ value because other pages may be included in the code segment such as the XCOFF header and the loader section.

%MEM

Calculated as the sum of the number of working segment and code segment pages in memory times 4 (that is, the RSS value), divided by the size of the real memory of the machine in KB, times 100, rounded to the nearest full percentage point. This value attempts to convey the percentage of real memory being used by the process. Unfortunately, like RSS, it tends to exaggerate the cost of a process that is sharing program text with other processes. Further, the rounding to the nearest percentage point causes all of the processes in the system that have RSS values under 0.005 times real memory size to have a %MEM of 0.0.

Note: The **ps** command does not indicate memory consumed by shared memory segments or memory-mapped segments. Because many applications use shared memory or memory-mapped segments, the **svmon** command is a better tool to view the memory usage of these segments.

The svmon command

The **svmon** command provides a more in-depth analysis of memory usage. It is more informative, but also more intrusive, than the **vmstat** and **ps** commands. The **svmon** command captures a snapshot of the current state of memory. However, it is not a true snapshot because it runs at the user level with interrupts enabled.

To determine whether **svmon** is installed and available, run the following command:

```
# ls1pp -lI bos.perf.tools
```

The **svmon** command can only be executed by the root user.

If an interval is used, which is the **-i** option, statistics will be displayed until the command is killed or until the number of intervals, which can be specified right after the interval, is reached.

You can use the following different reports to analyze the displayed information:

Global (-G)

Displays statistics describing the real memory and paging space in use for the whole system.

Process (-P)

Displays memory usage for the specified active processes. If no list of processes is supplied, the memory usage statistics display all active processes.

Segment (-S)

Displays memory usage for the specified segments. If no list of segments is supplied, memory usage statistics display all defined segments.

Detailed Segment (-D)

Displays detailed information on specified segments.

User (-U)

Displays memory usage statistics for the specified login names. If no list of login names is supplied, memory usage statistics display all defined login names.

Command (-C)

Displays memory usage statistics for the processes specified by command name.

Workload Management Class (-W)

Displays memory usage statistics for the specified workload management classes. If no classes are supplied, memory usage statistics display all defined classes.

Frame (-F)

Displays information about frames. When no frame number is specified, the percentage of used memory is reported. The only frames that are taken into account are the ones where the reference bit is set. During the processing period, all reference bits are reset. So, when the **-f** option is used a second time, the **svmon** command reports the percentage of real memory that has been accessed since the previous time the **-f** option was used. If a reserved pool is defined on the system, the percentage of memory used in each defined pool is reported.

Tier (-T)

Displays information about tiers, such as the tier number, the superclass name when the **-a** flag is used, and the total number of pages in real memory from segments belonging to the tier.

Amount of memory in use

To print out global statistics, use the **-G** flag. In the following example, it repeats two times at one-second intervals.

```
# svmon -G -i 1 2
```

| | size | inuse | free | pin | virtual |
|----------|----------|--------|--------|-------|---------|
| memory | 1048576 | 425275 | 623301 | 66521 | 159191 |
| pg space | 262144 | 31995 | | | |
| | work | pers | clnt | | |
| pin | 46041 | 0 | 0 | | |
| in use | 129600 | 275195 | 0 | | |
| PageSize | PoolSize | inuse | pgsp | pin | virtual |
| s 4 KB | - | 404795 | 31995 | 46041 | 159191 |
| L 16 MB | 5 | 0 | 0 | 5 | 0 |
| | size | inuse | free | pin | virtual |
| memory | 1048576 | 425279 | 623297 | 66521 | 159195 |
| pg space | 262144 | 31995 | | | |
| | work | pers | clnt | | |
| pin | 46041 | 0 | 0 | | |
| in use | 129604 | 275195 | 0 | | |
| PageSize | PoolSize | inuse | pgsp | pin | virtual |
| s 4 KB | - | 404799 | 31995 | 46041 | 159195 |
| L 16 MB | 5 | 0 | 0 | 5 | 0 |

Notice that if only 4 KB pages are available on the system, the section that breaks down the information per page size is not displayed.

The columns on the resulting **svmon** report are described as follows:

memory

Statistics describing the use of real memory, shown in 4 KB pages.

- size** Total size of memory in 4 KB pages.
- inuse** Number of pages in RAM that are in use by a process plus the number of persistent pages that belonged to a terminated process and are still resident in RAM. This value is the total size of memory minus the number of pages on the free list.
- free** Number of pages on the free list.
- pin** Number of pages pinned in RAM (a pinned page is a page that is always resident in RAM and cannot be paged out).
- virtual** Number of pages allocated in the process virtual space.

pg space

Statistics describing the use of paging space, shown in 4 KB pages. The value reported is the actual number of paging-space pages used, which indicates that these pages were paged out to the paging space. This differs from the **vmstat** command in that the **vmstat** command's **avm** column which shows the virtual memory accessed but not necessarily paged out.

size Total size of paging space in 4 KB pages.

inuse Total number of allocated pages.

pin Detailed statistics on the subset of real memory containing pinned pages, shown in 4 KB frames.

work Number of working pages pinned in RAM.

pers Number of persistent pages pinned in RAM.

clnt Number of client pages pinned in RAM.

in use Detailed statistics on the subset of real memory in use, shown in 4 KB frames.

work Number of working pages in RAM.

pers Number of persistent pages in RAM.

clnt Number of client pages in RAM (client page is a remote file page).

PageSize

Displayed only if page sizes other than 4 KB are available on the system. Specifies individual statistics per page size available on the system.

PageSize

Page size

PoolSize

Number of pages in the reserved memory pool.

inuse Number of pages used

pgsp Number of pages allocated in the paging space

pin Number of pinned pages

virtual Number of pages allocated in the system virtual space.

In the example, there are 1048576 pages of total size of memory. Multiply this number by 4096 to see the total real memory size in bytes (4 GB). While 425275 pages are in use, there are 623301 pages on the free list and 66521 pages are pinned in RAM. Of the total pages in use, there are 129600 working pages in RAM, 275195 persistent pages in RAM, and 0 client pages in RAM. The sum of these three parts, plus the memory reserved but not necessarily used by the reserved pools, is equal to the **inuse** column of the memory part. The **pin** part divides the pinned memory size into working, persistent, and client categories. The sum of them, plus the memory reserved by the reserved pools, which is always pinned, is equal to the **pin** column of the memory part. There are 262144 pages (1 GB) of total paging space, and 31995 pages are in use. The **inuse** column of memory is usually greater than the **inuse** column of pg space because memory for file pages is not freed when a program completes, while paging-space allocation is.

Memory usage by processes

The **svmon -P** command displays the memory usage statistics for all the processes currently running on a system. The following is an example of the **svmon -P** command:

```
# svmon -P
```

```
-----
```

| Pid | Command | Inuse | Pin | Pgsp | Virtual | 64-bit | Mthrd | 16MB |
|-------|---------------|-------|------|------|---------|--------|-------|------|
| 16264 | IBM.ServiceRM | 10075 | 3345 | 3064 | 13310 | N | Y | N |

| PageSize | Inuse | Pin | Pgsp | Virtual |
|----------|-------|------|------|---------|
| s 4 KB | 10075 | 3345 | 3064 | 13310 |
| L 16 MB | 0 | 0 | 0 | 0 |

| Vsid | Esid | Type | Description | PSize | Inuse | Pin | Pgsp | Virtual |
|-------|------|------|----------------------------|-------|-------|------|------|---------|
| f001e | d | work | shared library text | s | 4857 | 0 | 36 | 6823 |
| 0 | 0 | work | kernel seg | s | 4205 | 3335 | 2674 | 5197 |
| b83f7 | 2 | work | process private | s | 898 | 2 | 242 | 1098 |
| 503ea | f | work | shared library data | s | 63 | 0 | 97 | 165 |
| c8439 | 1 | pers | code,/dev/hd2:149841 | s | 28 | 0 | - | - |
| 883f1 | - | work | | s | 21 | 8 | 14 | 26 |
| e83dd | - | pers | /dev/hd2:71733 | s | 2 | 0 | - | - |
| f043e | 4 | work | shared memory segment | s | 1 | 0 | 1 | 1 |
| c0438 | - | pers | large file /dev/hd9var:243 | s | 0 | 0 | - | - |
| b8437 | 3 | mmap | mapped to sid a03f4 | s | 0 | 0 | - | - |
| 583eb | - | pers | large file /dev/hd9var:247 | s | 0 | 0 | - | - |

```
-----
```

| Pid | Command | Inuse | Pin | Pgsp | Virtual | 64-bit | Mthrd | 16MB |
|-------|---------------|-------|------|------|---------|--------|-------|------|
| 17032 | IBM.CSMAgentR | 9791 | 3347 | 3167 | 12944 | N | Y | N |

| PageSize | Inuse | Pin | Pgsp | Virtual |
|----------|-------|------|------|---------|
| s 4 KB | 9791 | 3347 | 3167 | 12944 |
| L 16 MB | 0 | 0 | 0 | 0 |

| Vsid | Esid | Type | Description | PSize | Inuse | Pin | Pgsp | Virtual |
|-------|------|------|----------------------------|-------|-------|------|------|---------|
| f001e | d | work | shared library text | s | 4857 | 0 | 36 | 6823 |
| 0 | 0 | work | kernel seg | s | 4205 | 3335 | 2674 | 5197 |
| 400 | 2 | work | process private | s | 479 | 2 | 303 | 674 |
| 38407 | f | work | shared library data | s | 120 | 0 | 127 | 211 |
| a83f5 | 1 | pers | code,/dev/hd2:149840 | s | 99 | 0 | - | - |
| 7840f | - | work | | s | 28 | 10 | 27 | 39 |
| e83dd | - | pers | /dev/hd2:71733 | s | 2 | 0 | - | - |
| babf7 | - | pers | /dev/hd2:284985 | s | 1 | 0 | - | - |
| 383e7 | - | pers | large file /dev/hd9var:186 | s | 0 | 0 | - | - |
| e03fc | - | pers | large file /dev/hd9var:204 | s | 0 | 0 | - | - |
| f839f | 3 | mmap | mapped to sid 5840b | s | 0 | 0 | - | - |

[...]

The command output details both the global memory use per process and also detailed memory use per segment used by each reported process. The default sorting rule is a decreasing sort based on the Inuse page count. You can change the sorting rule using the **svmon** command with either the **-u**, **-p**, **-g**, or **-v** flags.

For a summary of the top 15 processes using memory on the system, use the following command:

```
# svmon -Pt15 | perl -e 'while(<>){print if(.$==2||$&&!$s++);$.=0 if(/^-$/)}'
```

```
-----
```

| Pid | Command | Inuse | Pin | Pgsp | Virtual | 64-bit | Mthrd | 16MB |
|-------|---------------|-------|------|------|---------|--------|-------|------|
| 16264 | IBM.ServiceRM | 10075 | 3345 | 3064 | 13310 | N | Y | N |
| 17032 | IBM.CSMAgentR | 9791 | 3347 | 3167 | 12944 | N | Y | N |
| 21980 | zsh | 9457 | 3337 | 2710 | 12214 | N | N | N |
| 22522 | zsh | 9456 | 3337 | 2710 | 12213 | N | N | N |
| 13684 | getty | 9413 | 3337 | 2710 | 12150 | N | N | N |
| 26590 | perl5.8.0 | 9147 | 3337 | 2710 | 12090 | N | N | N |
| 7514 | sendmail | 9390 | 3337 | 2878 | 12258 | N | N | N |

| | | | | | | | | |
|-------|------------|------|------|------|-------|---|---|---|
| 14968 | rmcd | 9299 | 3340 | 3224 | 12596 | N | Y | N |
| 18940 | ksh | 9275 | 3337 | 2710 | 12172 | N | N | N |
| 14424 | ksh | 9270 | 3337 | 2710 | 12169 | N | N | N |
| 4164 | errdemon | 9248 | 3337 | 2916 | 12255 | N | N | N |
| 3744 | cron | 9217 | 3337 | 2770 | 12125 | N | N | N |
| 11424 | rpc.mountd | 9212 | 3339 | 2960 | 12290 | N | Y | N |
| 21564 | rlogind | 9211 | 3337 | 2710 | 12181 | N | N | N |
| 26704 | rlogind | 9211 | 3337 | 2710 | 12181 | N | N | N |

The Pid 16264 is the process ID that has the highest memory consumption. The Command indicates the command name, in this case IBM.ServiceRM. The Inuse column, which is the total number of pages in real memory from segments that are used by the process, shows 10075 pages. Each page is 4 KB. The Pin column, which is the total number of pages pinned from segments that are used by the process, shows 3345 pages. The Pgsp column, which is the total number of paging-space pages that are used by the process, shows 3064 pages. The Virtual column (total number of pages in the process virtual space) shows 13310.

The detailed section displays information about each segment for each process that is shown in the summary section. This includes the virtual, Vsid, and effective, Esid, segment identifiers. The Esid reflects the segment register that is used to access the corresponding pages. The type of the segment is also displayed along with its description that consists in a textual description of the segment, including the volume name and i-node of the file for persistent segments. The report also details the size of the pages the segment is backed by, where s denotes 4 KB pages and L denotes 16 MB pages, the number of pages in RAM, Inuse, number of pinned pages in RAM, Pin, number of pages in paging space, Pgsp, and number of virtual pages, Virtual.

You can use even more options to obtain more details. The **-j** option displays the path of the file for persistent segments. The **-l** option provides more detail for segments and the **-r** option displays the memory ranges used by each segment. The following is an example of the **svmon** command with the **-l**, **-r**, and **-j** options:

```
# svmon -S f001e 400 e83dd -l -r -j
```

| Vsid | Esid | Type | Description | PSize | Inuse | Pin | Pgsp | Virtual |
|-------|------|------|--|-------|-------|-----|------|---------|
| f001e | d | work | shared library text | s | 4857 | 0 | 36 | 6823 |
| | | | Addr Range: 0..60123 | | | | | |
| | | | Shared library text segment | | | | | |
| 400 | 2 | work | process private | s | 480 | 2 | 303 | 675 |
| | | | Addr Range: 0..969 : 65305..65535 | | | | | |
| | | | pid(s)=17032 | | | | | |
| e83dd | - | pers | /dev/hd2:71733 | s | 2 | 0 | - | - |
| | | | /usr/lib/nls/loc/uconvTable/IS08859-1 | | | | | |
| | | | Addr Range: 0..1 | | | | | |
| | | | pid(s)=17552, 17290, 17032, 16264, 14968, 9620 | | | | | |

The Address Range specifies one range for a persistent or client segment and two ranges for a working segment. The range for a persistent or a client segment takes the form '0..x,' where x is the maximum number of virtual pages that have been used. The range field for a working segment can be '0..x : y.65535', where 0..x contains global data and grows upward, and y.65535 contains stack area and grows downward. For the address range, in a working segment, space is allocated starting from both ends and working towards the middle. If the working segment is non-private (kernel or shared library), space is allocated differently.

In the above example, the segment ID 400 is a private working segment; its address range is 0..969 : 65305..65535. The segment ID f001e is a shared library text working segment; its address range is 0..60123.

A segment can be used by multiple processes. Each page in real memory from such a segment is accounted for in the Inuse field for each process using that segment. Thus, the total for Inuse may exceed

the total number of pages in real memory. The same is true for the Pgps and Pin fields. The values displayed in the summary section consist of the sum of Inuse, Pin, and Pgps, and Virtual counters of all segments used by the process.

In the above example, the e83dd segment is used by several processes whose PIDs are 17552, 17290, 17032, 16264, 14968 and 9620.

Detailed information on a specific segment id

The **-D** option displays detailed memory-usage statistics for segments.

The following is an example:

```
# svmon -D 38287 -b
Segid: 38287
Type: working
PSize: s (4 KB)
Address Range: 0..484
Size of page space allocation: 2 pages ( 0,0 MB)
Virtual: 18 frames ( 0,1 MB)
Inuse: 16 frames ( 0,1 MB)
```

| Page | Frame | Pin | Ref | Mod | ExtSegid | ExtPage |
|------|---------|-----|-----|-----|----------|---------|
| 341 | 527720 | N | N | N | - | - |
| 342 | 996079 | N | N | N | - | - |
| 343 | 524936 | N | N | N | - | - |
| 344 | 985024 | N | N | N | - | - |
| 347 | 658735 | N | N | N | - | - |
| 348 | 78158 | N | N | N | - | - |
| 349 | 174728 | N | N | N | - | - |
| 350 | 758694 | N | N | N | - | - |
| 404 | 516554 | N | N | N | - | - |
| 406 | 740622 | N | Y | N | - | - |
| 411 | 528313 | N | Y | Y | - | - |
| 412 | 1005599 | N | Y | N | - | - |
| 416 | 509936 | N | N | Y | - | - |
| 440 | 836295 | N | N | Y | - | - |
| 443 | 60204 | N | N | Y | - | - |
| 446 | 655288 | N | N | Y | - | - |

The explanation of the columns are as follows:

Page Specifies the index of the page within the segment.

Frame Specifies the index of the real memory frame that the page resides in.

Pin Specifies a flag indicating whether the page is pinned.

Ref Only specified with the **-b** flag. Specifies a flag indicating whether the page's reference bit is on.

Mod Only specified with the **-b** flag. Specifies a flag indicating whether the page is modified.

ExtSegid

In case the page belongs to an extended segment that is linked to the inspected segment, the virtual segment identifier of this segment is displayed.

ExtPage

In case the page belongs to an extended segment that is linked to the inspected segment, the index of the page within that extended segment is displayed.

When an extended segment is linked to the inspected segment, the report looks like the following example:

| Page | Frame | Pin | Ref | Mod | ExtSegid | ExtPage |
|-------|--------|-----|-----|-----|----------|---------|
| 65574 | 345324 | N | N | N | 288071 | 38 |
| 65575 | 707166 | N | N | N | 288071 | 39 |
| 65576 | 617193 | N | N | N | 288071 | 40 |

The **-b** flag shows the status of the reference and modified bits of all the displayed frames. After it is shown, the reference bit of the frame is reset. When used with the **-i** flag, it detects which frames are accessed between each interval.

Note: Due to the performance impacts, use the **-b** flag with caution.

List of top memory usage of segments

The **-S** option is used to sort segments by memory usage and to display the memory-usage statistics for the specified segments. If no list of segments is supplied, memory usage statistics display all defined segments. The following command sorts system and non-system segments by the number of pages in real memory. The **-t** option can be used to limit the number of segments displayed to the count specified. The **-u** flag sorts the output in descending order by the total number of pages in real memory.

The following is example output of the **svmon** command with the **-S**, **-t**, and **-u** options:

```
# svmon -Sut 10
```

| Vsid | Esid | Type | Description | PSize | Inuse | Pin | Pgsp | Virtual |
|-------|------|------|-------------------------|-------|-------|-------|-------|---------|
| 70c4e | - | pers | large file /dev/lv01:26 | s | 84625 | 0 | - | - |
| 22ec4 | - | work | | s | 29576 | 0 | 0 | 29586 |
| 8b091 | - | pers | /dev/hd3:123 | s | 24403 | 0 | - | - |
| 7800f | - | work | kernel heap | s | 22050 | 3199 | 19690 | 22903 |
| a2db4 | - | pers | /dev/hd3:105 | s | 15833 | 0 | - | - |
| 80010 | - | work | page frame table | s | 15120 | 15120 | 0 | 15120 |
| 7000e | - | work | misc kernel tables | s | 13991 | 0 | 2388 | 14104 |
| dc09b | - | pers | /dev/hd1:28703 | s | 9496 | 0 | - | - |
| 730ee | - | pers | /dev/hd3:111 | s | 8568 | 0 | - | - |
| f001e | - | work | | s | 4857 | 0 | 36 | 6823 |

Correlation between the svmon and vmstat command outputs

There is a correlation between the **svmon** and **vmstat** outputs.

The following is example output from the **svmon** command:

```
# svmon -G
```

| | size | inuse | free | pin | virtual |
|----------|----------|--------|--------|-------|---------|
| memory | 1048576 | 417374 | 631202 | 66533 | 151468 |
| pg space | 262144 | 31993 | | | |
| | work | pers | clnt | | |
| pin | 46053 | 0 | 0 | | |
| in use | 121948 | 274946 | 0 | | |
| PageSize | PoolSize | inuse | pgsp | pin | virtual |
| s 4 KB | - | 397194 | 262144 | 46053 | 151468 |
| L 16 MB | 5 | 0 | 0 | 5 | 0 |

The **vmstat** command was run in a separate window while the **svmon** command was running. The **vmstat** report follows:

```
# vmstat 3
```

| kthr | | memory | | | | page | | | | faults | | | | cpu | | | |
|------|---|--------|--------|----|----|------|----|----|----|--------|------|-----|----|-----|----|----|--|
| r | b | avm | fre | re | pi | po | fr | sr | cy | in | sy | cs | us | sy | id | wa | |
| 1 | 5 | 205031 | 749504 | 0 | 0 | 0 | 0 | 0 | 0 | 1240 | 248 | 318 | 0 | 0 | 99 | 0 | |
| 2 | 2 | 151360 | 631310 | 0 | 0 | 3 | 3 | 32 | 0 | 1187 | 1718 | 641 | 1 | 1 | 98 | 0 | |

```

1 0 151366 631304 0 0 0 0 0 0 1335 2240 535 0 1 99 0
1 0 151366 631304 0 0 0 0 0 0 1303 2434 528 1 4 95 0
1 0 151367 631303 0 0 0 0 0 0 1331 2202 528 0 0 99 0

```

The global **svmon** report shows related numbers. The `fre` column of the **vmstat** command relates to the memory free column of the **svmon** command. The Active Virtual Memory, `avm`, value of the **vmstat** command reports is similar to the virtual memory value that the **svmon** command reports.

Correlation between the svmon and ps command outputs

There are some relationships between the **svmon** and **ps** command outputs. The **svmon** command output is as follows:

```
# svmon -P 14706
```

```

-----
      Pid Command          Inuse      Pin      Pgps      Virtual 64-bit Mthrd 16MB
14706 itesmdem           9067      3337      2833      12198      N      N      N

      PageSize      Inuse      Pin      Pgps      Virtual
s      4 KB          9067      3337      2833      12198
L      16 MB          0          0          0          0

      Vsid      Esid Type Description      PSize Inuse Pin Pgps Virtual
f001e      d work shared library text      s      4857 0 36 6823
0          0 work kernel seg              s      4205 3335 2674 5197
f039e      2 work process private          s      5 2 27 29
b8397      3 work shared memory segment     s      0 0 1 1
d039a      6 work shared memory segment     s      0 0 1 1
c0398      4 work shared memory segment     s      0 0 1 1
d839b      7 work shared memory segment     s      0 0 1 1
e839d      f work shared library data        s      0 0 91 144
c8399      5 work shared memory segment     s      0 0 1 1
83a1      1 pers code,/dev/hd2:221359      s      0 0 - -

```

Compare the above example with the **ps** report which follows:

```
# ps v 14706
PID TTY STAT TIME PGIN SIZE RSS LIM TSIZ TRS %CPU %MEM COMMAND
14706 - A 0:00 16 692 20 32768 19 0 0,0 0,0 /usr/bin/
```

The `SIZE` value of 328 correlates to the `Virtual` value of the **svmon** command for process private value of 59 plus the shared library data value of 23, which is in 1 KB units. This number is equal to the number of working segment pages of the process that have been touched (that is, the number of virtual pages that have been allocated) times 4. It must be multiplied by 4 because pages are in 4 KB units and `SIZE` is in 1 KB units. If some working segment pages are currently paged out, this number is larger than the amount of real memory being used. The `SIZE` value (692) correlates with the `Virtual` number from the **svmon** command for process private (29) plus shared library data (144) in 1 KB units.

`RSS` refers to the real memory (resident set) size in KB of the process. This number is equal to the sum of the number of working segment and code segment pages in memory times 4. Remember that code segment pages are shared among all of the currently running instances of the program. If 26 **ksh** processes are running, only one copy of any given page of the **ksh** executable program would be in memory, but the **ps** command would report that code segment size as part of the `RSS` of each instance of the **ksh** program. The `RSS` value of 20 correlates with the `Inuse` numbers from the **svmon** command for the process private value of 5 working-storage segments, for code,/dev/hd2:221359 (0) segments, and for the shared library data value of 0 of the process in 1 KB units.

The `TRS` value refers to the size of the resident set (real memory) of text. This is the number of code segment pages times four. As was noted earlier, this number exaggerates memory use for programs of which multiple instances are running. This does not include the shared text of the process. The `TRS` value of 232 correlates with the number of the **svmon** pages in the code segment (58) of the `Inuse` column in 1

KB units. The TRS value can be higher than the TSIZ value because other pages, such as the XCOFF header and the loader section, may be included in the code segment.

You can use the following equations to calculate the SIZE, RSS, and TRS values:

```
SIZE = 4 * Virtual of (work lib data + work private)
RSS  = 4 * Inuse of (work lib data + work private + pers code)
TRS  = 4 * Inuse of (pers code)
```

The **svmon** command example from above shows only 4 KB pages. If other page sizes are used, you should take that into account when calculating the SIZE, RSS, and TRS values.

Minimum memory requirement calculation

The formula to calculate the minimum memory requirement of a program is the following:

$$\text{Total memory pages (4 KB units)} = T + (N * (PD + LD)) + F$$

where:

- T** = Number of pages for text (shared by all users)
- N** = Number of copies of this program running simultaneously
- PD** = Number of working segment pages in process private segment
- LD** = Number of shared library data pages used by the process
- F** = Number of file pages (shared by all users)

Multiply the result by 4 to obtain the number of kilobytes required. You may want to add in the kernel, kernel extension, and shared library text segment values to this as well even though they are shared by all processes on the system. For example, some applications like CATIA and databases use very large shared library modules. Note that because we have only used statistics from a single snapshot of the process, there is no guarantee that the value we get from the formula will be the correct value for the minimum working set size of a process. To get working set size, one would need to run a tool such as the **rmss** command or take many snapshots during the life of the process and determine the average values from these snapshots. See Memory requirements assessment with the **rmss** command for more information.

Memory-leaking programs

A *memory leak* is a program error that consists of repeatedly allocating memory, using it, and then neglecting to free it. A memory leak in a long-running program, such as an interactive application, is a serious problem, because it can result in memory fragmentation and the accumulation of large numbers of mostly garbage-filled pages in real memory and page space. Systems have been known to run out of page space because of a memory leak in a single program.

A memory leak can be detected with the **svmon** command, by looking for processes whose working segment continually grows. A leak in a kernel segment can be caused by an mbuf leak or by a device driver, kernel extension, or even the kernel. To determine if a segment is growing, use the **svmon** command with the **-i** option to look at a process or a group of processes and see if any segment continues to grow.

Identifying the offending subroutine or line of code is more difficult, especially in AIXwindows applications, which generate large numbers of **malloc()** and **free()** calls. C++ provides a HeapView Debugger for analyzing/tuning memory usage and leaks. Some third-party programs exist for analyzing memory leaks, but they require access to the program source code.

Some uses of the **realloc()** subroutine, while not actually programming errors, can have the same effect as a memory leak. If a program frequently uses the **realloc()** subroutine to increase the size of a data

area, the working segment of the process can become increasingly fragmented if the storage released by the **realloc()** subroutine cannot be reused for anything else.

Use the **disclaim()** system call and **free()** call to release memory that is no longer required. The **disclaim()** system call must be called before the **free()** call. It wastes CPU time to free memory after the last **malloc()** call, if the program will finish soon. When the program terminates, its working segment is destroyed and the real memory page frames that contained working segment data are added to the free list. The following example is a memory-leaking program where the Inuse, Pgspace, and Address Range values of the private working segment are continually growing:

```
# svmon -P 13548 -i 1 3
  Pid          Command      Inuse      Pin      Pgspace  Virtual  64-bit  Mthrd  LPage
13548          pacman      8535      2178      847      8533      N      N      N

Vsid   Esid Type  Description      LPage  Inuse   Pin  Pgspace  Virtual
  0     0  work  kernel seg      -    4375  2176  847     4375
48412  2  work  process private -    2357   2    0     2357
6c01b  d  work  shared library text - 1790   0    0     1790
4c413  f  work  shared library data -   11    0    0      11
3040c  1  pers  code,/dev/prodlv:4097 -    2    0    -      -
ginger :svmon -P 13548 -i 1 3

  Pid          Command      Inuse      Pin      Pgspace  Virtual  64-bit  Mthrd  LPage
13548          pacman      8589      2178      847      8587      N      N      N

Vsid   Esid Type  Description      LPage  Inuse   Pin  Pgspace  Virtual
  0     0  work  kernel seg      -    4375  2176  847     4375
48412  2  work  process private -    2411   2    0     2411
6c01b  d  work  shared library text - 1790   0    0     1790
4c413  f  work  shared library data -   11    0    0      11
3040c  1  pers  code,/dev/prodlv:4097 -    2    0    -      -

  Pid          Command      Inuse      Pin      Pgspace  Virtual  64-bit  Mthrd  LPage
13548          pacman      8599      2178      847      8597      N      N      N

Vsid   Esid Type  Description      LPage  Inuse   Pin  Pgspace  Virtual
  0     0  work  kernel seg      -    4375  2176  847     4375
48412  2  work  process private -    2421   2    0     2421
6c01b  d  work  shared library text - 1790   0    0     1790
4c413  f  work  shared library data -   11    0    0      11
3040c  1  pers  code,/dev/prodlv:4097 -    2    0    -      -
```

Memory requirements assessment with the **rmss** command

The **rmss** command, Reduced-Memory System Simulator, provides you with a means to simulate different sizes of real memories that are smaller than your actual machine, without having to extract and replace memory boards. Moreover, the **rmss** command provides a facility to run an application over a range of memory sizes, displaying, for each memory size, performance statistics such as the response time of the application and the amount of paging. The **rmss** command is designed to help you answer the question: “How many megabytes of real memory does a system need to run the operating system and a given application with an acceptable level of performance?”. In the multiuser context, it is designed to help you answer the question: “How many users can run this application simultaneously in a machine with *X* megabytes of real memory?”

The main use for the **rmss** command is as a capacity planning tool, to determine how much memory a workload needs. It can also be used as a problem determination tool, particularly for those cases where having more memory degrades performance.

To determine whether the **rmss** command is installed and available, run the following command:

```
# lsipp -lI bos.perf.tools
```

It is important to keep in mind that the memory size simulated by the **rmss** command is the total size of the machine's real memory, including the memory used by the operating system and any other programs that may be running. It is not the amount of memory used specifically by the application itself. Because of the performance degradation it can cause, the **rmss** command can be used only by a root user or a member of the system group.

Overview of the rmss command

You can use the **rmss** command in the following ways:

1. To change the memory size and exit.
2. As a driver program which executes a specified application multiple times over a range of memory sizes and displays important statistics that describe the application's performance at each memory size.

The first method is useful when you want to get the look and feel of how your application performs at a given system memory size, when your application is too complex to be expressed as a single command, or when you want to run multiple instances of the application. The second method is appropriate when you have an application that can be invoked as an executable program or shell script file.

Memory size change

To change the memory size and exit, use the **-c** flag of the **rmss** command. For example, to change the memory size to 128 MB, use the following:

```
# rmss -c 128
```

The memory size is an integer or decimal fraction number of megabytes (for example, 128.25). Additionally, the size must be between 8 MB and the amount of physical real memory in your machine. Depending on the hardware and software configuration, the **rmss** command may not be able to change the memory size to small sizes, because of the size of inherent system structures such as the kernel. When the **rmss** command is unable to change to a given memory size, it displays an error message.

The **rmss** command reduces the effective memory size of a system by stealing free page frames from the list of free frames that is maintained by the VMM. The stolen frames are kept in a pool of unusable frames and are returned to the free frame list when the effective memory size is to be increased. Also, the **rmss** command dynamically adjusts certain system variables and data structures that must be kept proportional to the effective size of memory.

It may take a short while (up to 15 to 20 seconds) to change the memory size. In general, the more you want to reduce the memory size, the longer the **rmss** command takes to complete. When successful, the **rmss** command responds with the following message:

```
Simulated memory size changed to 128.00 Mb.
```

To display the current memory size, use the **-p** flag, as follows:

```
# rmss -p
```

The **rmss** output is as follows:

```
Simulated memory size is 128.00 Mb.
```

Finally, if you want to reset the memory size to the actual memory size of the machine, use the **-r** flag, as follows:

```
# rmss -r
```

No matter what the current simulated memory size, using the **-r** flag sets the memory size to be the physical real memory size of the machine.

Because this example was run on a 256 MB machine, the **rmss** command responded as follows:

Simulated memory size changed to 256.00 Mb.

Note: The **rmss** command reports usable real memory. On machines that contain bad memory or memory that is in use, the **rmss** command reports the amount of real memory as the amount of physical real memory minus the memory that is bad or in use by the system. For example, the **rmss -r** command might report:

```
Simulated memory size changed to 79.9062 Mb.
```

This could be a result of some pages being marked bad or a result of a device that is reserving some pages for its own use and thus not available to the user.

The -c, -p, and -r flags of the rmss command: The advantage of using the **-c**, **-p** and **-r** flags of the **rmss** command is that they allow you to experiment with complex applications that cannot be expressed as a single executable program or shell script file. On the other hand, the disadvantage of using the **-c**, **-p**, and **-r** options is that they force you to do your own performance measurements. Fortunately, you can use the command **vmstat -s** to measure the paging-space activity that occurred while your application ran.

By running the command **vmstat -s**, running your application, then running the command **vmstat -s** again, and subtracting the number of paging-space page-ins before from the number of paging-space page-ins after, you can determine the number of paging-space page-ins that occurred while your program ran. Furthermore, by timing your program, and dividing the number of paging-space page-ins by the program's elapsed run time, you can obtain the average paging-space page-in rate.

It is also important to run the application multiple times at each memory size, for two reasons:

- When changing memory size, the **rmss** command often clears out a lot of memory. Thus, the first time you run your application after changing memory sizes it is possible that a substantial part of the run time may be due to your application reading files into real memory. But, since the files may remain in memory after your application terminates, subsequent executions of your application may result in substantially shorter elapsed times.
- To get a feel for the average performance of the application at that memory size. It is impossible to duplicate the system state each time your application runs. Because of this, the performance of your application can vary significantly from run to run.

To summarize, consider the following set of steps as a desirable way to invoke the **rmss** command:

```
while there are interesting memory sizes to investigate:
{
  change to an interesting memory size using rmss -c;
  run the application once as a warm-up;
  for a couple of iterations:
  {
    use vmstat -s to get the "before" value of paging-space page ins;
    run the application, while timing it;
    use vmstat -s to get the "after" value of paging-space page ins;
    subtract the "before" value from the "after" value to get the
      number of page ins that occurred while the application ran;
    divide the number of paging-space page ins by the response time
      to get the paging-space page-in rate;
  }
}
run rmss -r to restore the system to normal memory size (or reboot)
```

The calculation of the (after - before) paging I/O numbers can be automated by using the **vmstatit** script described in Disk or memory-related problem.

Execution of applications over a range of memory sizes with the **rmss** command

The **-s**, **-f**, **-d**, **-n**, and **-o** flags of the **rmss** command are used in combination to invoke the **rmss** command as a driver program. As a driver program, the **rmss** command executes a specified application

over a range of memory sizes and displays statistics describing the application's performance at each memory size. The syntax for this invocation style of the **rmss** command is as follows:

```
rmss [ -s smemsize ] [ -f fmemsize ] [ -d memdelta ]  
      [ -n numiterations ] [ -o outputfile ] command
```

Each of the following flags is discussed in detail below. The **-s**, **-f**, and **-d** flags are used to specify the range of memory sizes.

- n** This flag is used to specify the number of times to run and measure the command at each memory size.
- o** This flag is used to specify the file into which to write the **rmss** report, while **command** is the application that you wish to run and measure at each memory size.
- s** This flag specifies the starting size.
- f** This flag specifies the final size.
- d** This flag specifies the difference between sizes.

All values are in integer or decimal fractions of megabytes. For example, if you wanted to run and measure a command at sizes 256, 224, 192, 160 and 128 MB, you would use the following combination:

```
-s 256 -f 128 -d 32
```

Likewise, if you wanted to run and measure a command at 128, 160, 192, 224, and 256 MB, you would use the following combination:

```
-s 128 -f 256 -d 32
```

If the **-s** flag is omitted, the **rmss** command starts at the actual memory size of the machine. If the **-f** flag is omitted, the **rmss** command finishes at 8 MB. If the **-d** flag is omitted, there is a default of 8 MB between memory sizes.

What values should you choose for the **-s**, **-f**, and **-d** flags? A simple choice would be to cover the memory sizes of systems that are being considered to run the application you are measuring. However, increments of less than 8 MB can be useful, because you can get an estimate of how much space you will have when you settle on a given size. For instance, if a given application thrashes at 120 MB but runs without page-ins at 128 MB, it would be useful to know where within the 120 to 128 MB range the application starts thrashing. If it starts at 127 MB, you may want to consider configuring the system with more than 128 MB of memory, or you may want to try to modify the application so that there is more space. On the other hand, if the thrashing starts at 121 MB, you know that you have enough space with a 128 MB machine.

The **-n** flag is used to specify how many times to run and measure the command at each memory size. After running and measuring the command the specified number of times, the **rmss** command displays statistics describing the average performance of the application at that memory size. To run the command 3 times at each memory size, you would use the following:

```
-n 3
```

If the **-n** flag is omitted, the **rmss** command determines during initialization how many times your application must be run to accumulate a total run time of 10 seconds. The **rmss** command does this to ensure that the performance statistics for short-running programs will not be significantly skewed by outside influences, such as daemons.

Note: If you are measuring a very brief program, the number of iterations required to accumulate 10 seconds of CPU time can be very large. Because each execution of the program takes a minimum of about 2 elapsed seconds of **rmss** overhead, specify the **-n** parameter explicitly for short programs.

What are good values to use for the **-n** flag? If you know that your application takes much more than 10 seconds to run, you can specify **-n 1** so that the command is run twice, but measured only once at each memory size. The advantage of using the **-n** flag is that the **rmss** command will finish sooner because it will not have to spend time during initialization to determine how many times to run your program. This can be particularly valuable when the command being measured is long-running and interactive.

It is important to note that the **rmss** command always runs the command once at each memory size as a warm-up before running and measuring the command. The warm-up is needed to avoid the I/O that occurs when the application is not already in memory. Although such I/O does affect performance, it is not necessarily due to a lack of real memory. The warm-up run is not included in the number of iterations specified by the **-n** flag.

The **-o** flag is used to specify a file into which to write the **rmss** report. If the **-o** flag is omitted, the report is written into the file **rmss.out**.

Finally, **command** is used to specify the application to be measured. It can be an executable program or shell script, with or without command-line arguments. There are some limitations on the form of the command however. First, it cannot contain the redirection of input or output (for example, **foo > output** or **foo < input**). This is because the **rmss** command treats everything to the right of the command name as an argument to the command. To redirect, place the command in a shell script file.

Usually, if you want to store the **rmss** output in a specific file, use the **-o** option. If you want to redirect the standard output of the **rmss** command (for example, to concatenate it to the end of an existing file) then use the Korn shell to enclose the **rmss** invocation in parentheses, as follows:

```
# (rmss -s 24 -f 8 foo) >> output
```

Interpretation of results from the **rmss** command

The example in the Report generated for the **foo** program section was produced by running the **rmss** command on an actual application program, although the name of the program has been changed to **foo** for anonymity. The specific command to generate the report is as follows:

```
# rmss -s 16 -f 8 -d 1 -n 1 -o rmss.out foo
```

Report generated for the **foo** Program

```
Hostname: aixhost1.austin.ibm.com
Real memory size: 16.00 Mb
Time of day: Thu Mar 18 19:04:04 2004
Command: foo
```

Simulated memory size initialized to 16.00 Mb.

Number of iterations per memory size = 1 warm-up + 1 measured = 2.

| Memory size (megabytes) | Avg. Pageins | Avg. Response Time (sec.) | Avg. Pagein Rate (pageins / sec.) |
|----------------------------|--------------|------------------------------|--------------------------------------|
| 16.00 | 115.0 | 123.9 | 0.9 |
| 15.00 | 112.0 | 125.1 | 0.9 |
| 14.00 | 179.0 | 126.2 | 1.4 |
| 13.00 | 81.0 | 125.7 | 0.6 |
| 12.00 | 403.0 | 132.0 | 3.1 |
| 11.00 | 855.0 | 141.5 | 6.0 |
| 10.00 | 1161.0 | 146.8 | 7.9 |
| 9.00 | 1529.0 | 161.3 | 9.5 |
| 8.00 | 2931.0 | 202.5 | 14.5 |

The report consists of four columns. The leftmost column gives the memory size, while the Avg. Pageins column gives the average number of page-ins that occurred when the application was run at that memory size. It is important to note that the Avg. Pageins column refers to all page-in operations, including code,

data, and file reads, from all programs, that completed while the application ran. The Avg. Response Time column gives the average amount of time it took the application to complete, while the Avg. Pagein Rate column gives the average rate of page-ins.

Concentrate on the Avg. Pagein Rate column. From 16 MB to 13 MB, the page-in rate is relatively small (< 1.5 page-ins per second). However, from 13 MB to 8 MB, the page-in rate grows gradually at first, and then rapidly as 8 MB is reached. The Avg. Response Time column has a similar shape: relatively flat at first, then increasing gradually, and finally increasing rapidly as the memory size is decreased to 8 MB.

Here, the page-in rate actually decreases when the memory size changes from 14 MB (1.4 page-ins per second) to 13 MB (0.6 page-ins per second). This is not cause for alarm. In an actual system, it is impossible to expect the results to be perfectly smooth. The important point is that the page-in rate is relatively low at both 14 MB and 13 MB.

Finally, you can make a couple of deductions from the report. First, if the performance of the application is deemed unacceptable at 8 MB (as it probably would be), then adding memory would enhance performance significantly. Note that the response time rises from approximately 124 seconds at 16 MB to 202 seconds at 8 MB, an increase of 63 percent. On the other hand, if the performance is deemed unacceptable at 16 MB, adding memory will not enhance performance much, because page-ins do not slow the program appreciably at 16 MB.

Report for a 16 MB remote copy

The following example illustrates a report that was generated (on a client machine) by running the **rmss** command on a command that copied a 16 MB file from a remote (server) machine through NFS.

```
Hostname: aixhost2.austin.ibm.com
Real memory size: 48.00 Mb
Time of day: Mon Mar 22 18:16:42 2004
Command: cp /mnt/a16Mfile /dev/null
```

Simulated memory size initialized to 48.00 Mb.

Number of iterations per memory size = 1 warm-up + 4 measured = 5.

| Memory size (megabytes) | Avg. Pageins | Avg. Response Time (sec.) | Avg. Pagein Rate (pageins / sec.) |
|----------------------------|--------------|------------------------------|--------------------------------------|
| 48.00 | 0.0 | 2.7 | 0.0 |
| 40.00 | 0.0 | 2.7 | 0.0 |
| 32.00 | 0.0 | 2.7 | 0.0 |
| 24.00 | 1520.8 | 26.9 | 56.6 |
| 16.00 | 4104.2 | 67.5 | 60.8 |
| 8.00 | 4106.8 | 66.9 | 61.4 |

Note that the response time and page-in rate in this report start relatively low, rapidly increase at a memory size of 24 MB, and then reach a plateau at 16 and 8 MB. This report shows the importance of choosing a wide range of memory sizes when you use the **rmss** command. If this user had only looked at memory sizes from 24 MB to 8 MB, he or she might have missed an opportunity to configure the system with enough memory to accommodate the application without page-ins.

Hints for usage of the -s, -f, -d, -n, and -o flags

One helpful feature of the **rmss** command, when used in this way, is that it can be terminated (by the interrupt key, Ctrl-C by default) without destroying the report that has been written to the output file. In addition to writing the report to the output file, this causes the **rmss** command to reset the memory size to the physical memory size of the machine.

You can run the **rmss** command in the background, even after you have logged out, by using the **nohup** command. To do this, precede the **rmss** command by the **nohup** command, and follow the entire command with an & (ampersand), as follows:

```
# nohup rmss -s 48 -f 8 -o foo.out foo &
```

Guidelines to consider when using the **rmss** command

No matter which **rmss** invocation style you are using, it is important to re-create the end-user environment as closely as possible. For instance, are you using the same model CPU, the same model disks, the same network? Will the users have application files mounted from a remote node via NFS or some other distributed file system? This last point is particularly important, because pages from remote files are treated differently by the VMM than pages from local files.

Likewise, it is best to eliminate any system activity that is not related to the desired system configuration or the application you are measuring. For instance, you do not want to have people working on the same machine as the **rmss** command unless they are running part of the workload you are measuring.

Note: You cannot run multiple invocations of the **rmss** command simultaneously.

When you have completed all runs of the **rmss** command, it is best to shut down and reboot the system. This will remove all changes that the **rmss** command has made to the system and will restore the VMM memory load control parameters to their typical settings.

VMM memory load control tuning with the **schedo** command

The VMM memory load control facility, described in VMM memory load control facility, protects an overloaded system from thrashing.

For early versions of the operating system, if a large number of processes hit the system at the same time, memory became overcommitted and thrashing occurred, causing performance to degrade rapidly. A memory-load control mechanism was developed that could detect thrashing. Certain parameters affect the function of the load control mechanism.

With the **schedo** command, the root user can affect the criteria used to determine thrashing, the criteria used to determine which processes to suspend, the length of time to wait after thrashing ends before reactivating processes, the minimum number of processes exempt from suspension, or reset values to the defaults. To determine whether the **schedo** command is installed and available, run the following command:

```
# ls1pp -lI bos.perf.tune
```

Memory load control tuning

Memory load control is intended to smooth out infrequent peaks in load that might otherwise cause the system to thrash. It trades multiprogramming for throughput and is not intended to act continuously in a configuration that has too little RAM to handle its normal workload. The design was made for batch jobs and is not very discriminating. The AIX Workload Manager provides a better solution to protect critical tasks.

The correct solution to a fundamental, persistent RAM shortage is to add RAM, not to experiment with memory load control in an attempt to trade off response time for memory. The situations in which the memory-load-control facility may really need to be tuned are those in which there is more RAM, not less than the defaults were chosen for. An example would be configurations in which the defaults are too conservative.

You should not change the memory load control parameter settings unless your workload is consistent and you believe the default parameters are ill-suited to your workload.

The default parameter settings shipped with the system are always in force unless changed. The default values of these parameters have been chosen to "fail safe" across a wide range of workloads. Changed parameters last only until the next system boot. All memory load control tuning activities must be done by the root user. The system administrator can use the **schedo** command to change the parameters to tune the algorithm to a particular workload or to disable it entirely.

The following example displays the current parameter values with the **schedo** command:

```
# schedo -a
  v_repage_hi = 0
  v_repage_proc = 4
  v_sec_wait = 1
  v_min_process = 2
  v_exempt_secs = 2
  pacefork = 10
  sched_D = 16
  sched_R = 16
  timeslice = 1
  maxspin = 1
  %usDelta = 100
  affinity_lim = n/a
idle_migration_barrier = n/a
  fixed_pri_global = n/a
  big_tick_size = 1
  force_grq = n/a
```

The first five parameters specify the thresholds for the memory load control algorithm. These parameters set rates and thresholds for the algorithm. If the algorithm shows that RAM is overcommitted, the **v_repage_proc**, **v_min_process**, **v_sec_wait**, and **v_exempt_secs** values are used. Otherwise, these values are ignored. If memory load control is disabled, these latter values are not used.

After a tuning experiment, memory load control can be reset to its default characteristics by executing the command **schedo -D**.

The **v_repage_hi** parameter

The **v_repage_hi** parameter controls the threshold defining memory overcommitment. Memory load control attempts to suspend processes when this threshold is exceeded during any one-second period. The threshold is a relationship between two direct measures: the number of pages written to paging space in the last second (**po**) and the number of page steals occurring in the last second (**fr**). You can see both these values in the **vmstat** output. The number of page writes is usually much less than the number of page steals. Memory is overcommitted when the following is true:

```
po/fr > 1/v_repage_hi or po*v_repage_hi > fr
```

The **schedo -o v_repage_hi=0** command effectively disables memory load control. If a system has at least 128 MB of memory, the default value is 0, otherwise the default value is 6. With at least 128 MB of RAM, the normal VMM algorithms usually correct thrashing conditions on the average more efficiently than by using memory load control.

In some specialized situations, it might be appropriate to disable memory load control from the outset. For example, if you are using a terminal emulator with a time-out feature to simulate a multiuser workload, memory load control intervention may result in some responses being delayed long enough for the process to be killed by the time-out feature. Another example is, if you are using the **rmss** command to investigate the effects of reduced memory sizes, disable memory load control to avoid interference with your measurement.

If disabling memory load control results in more, rather than fewer, thrashing situations (with correspondingly poorer responsiveness), then memory load control is playing an active and supportive role in your system. Tuning the memory load control parameters then may result in improved performance or you may need to add RAM.

A lower value of **v_repage_hi** raises the thrashing detection threshold; that is, the system is allowed to come closer to thrashing before processes are suspended. Regardless of the system configuration, when the above **po/fr** fraction is low, thrashing is unlikely.

To alter the threshold to 4, enter the following:

```
# schedo -o v_repage_hi=4
```

In this way, you permit the system to come closer to thrashing before the algorithm starts suspending processes.

The **v_repage_proc** parameter

The **v_repage_proc** parameter determines whether a process is eligible for suspension and is used to set a threshold for the ratio of two measures that are maintained for every process: the number of repages (r) and the number of page faults that the process has accumulated in the last second (f). A high ratio of repages to page faults means the individual process is thrashing. A process is considered eligible for suspension (it is thrashing or contributing to overall thrashing) when the following is true:

$$r/f > 1/v_repage_proc \text{ or } r*v_repage_proc > f$$

The default value of **v_repage_proc** is 4, meaning that a process is considered to be thrashing (and a candidate for suspension) when the fraction of repages to page faults over the last second is greater than 25 percent. A low value of **v_repage_proc** results in a higher degree of individual process thrashing being allowed before a process is eligible for suspension.

To disable processes from being suspended by the memory load control, do the following:

```
# schedo -o v_repage_proc=0
```

Note that fixed-priority processes and kernel processes are exempt from being suspended.

The **v_min_process** parameter

The **v_min_process** parameter determines a lower limit for the degree of multiprogramming, which is defined as the number of active processes. Active processes are those that can be run and are waiting for page I/O. Processes that are waiting for events and processes suspended are not considered active nor is the wait process considered active.

Setting the minimum multiprogramming level, the **v_min_process** parameter effectively keeps **v_min_process** processes from being suspended. Suppose a system administrator knows that at least ten processes must always be resident and active in RAM for successful performance, and suspects that memory load control was too vigorously suspending processes. If the **schedo -o v_min_process=10** command was issued, the system would never suspend so many processes that fewer than ten were competing for memory. The **v_min_process** parameter does not count:

- The kernel processes
- Processes that have been pinned in RAM with the **plock()** system call
- Fixed-priority processes with priority values less than 60
- Processes awaiting events

The system default value of **v_min_process=2** ensures that the kernel, all pinned processes, and two user processes will always be in the set of processes competing for RAM.

While **v_min_process=2** is appropriate for a desktop, single-user configuration, it is frequently too small for larger, multiuser, or server configurations with large amounts of RAM.

If the system you are installing is larger than 32 MB, but less than 128 MB, and is expected to support more than five active users at one time, consider raising the minimum level of multiprogramming of the VMM memory-load-control mechanism.

As an example, if your conservative estimate is that four of your most memory-intensive applications should be able to run simultaneously, leaving at least 16 MB for the operating system and 25 percent of real memory for file pages, you could increase the minimum multiprogramming level from the default of 2 to 4 with the following command:

```
# schedo -o v_min_process=4
```

On these systems, setting the **v_min_process** parameter to 4 or 6 may result in the best performance. Lower values of **v_min_process**, while allowed, mean that at times as few as one user process may be active.

When the memory requirements of the thrashing application are known, the **v_min_process** value can be suitably chosen. Suppose thrashing is caused by numerous instances of one application of size M. Given the system memory size N, the **v_min_process** parameter should be set to a value close to N/M. Setting the **v_min_process** value too low would unnecessarily limit the number of processes that could be active at the same time.

The **v_sec_wait** parameter

The **v_sec_wait** parameter controls the number of one-second intervals during which the *po/fr* fraction (explained in the **v_repage_hi** parameter section) must remain below $1/v_repage_hi$ before suspended processes are reactivated. The default value of one second is close to the minimum value allowed, which is zero. A value of one second aggressively attempts to reactivate processes as soon as a one-second safe period has occurred. Large values of **v_sec_wait** run the risk of unnecessarily poor response times for suspended processes while the processor is idle for lack of active processes to run.

To alter the wait time to reactivate processes after two seconds, enter the following:

```
# schedo -o v_sec_wait=2
```

The **v_exempt_secs** parameter

Each time a suspended process is reactivated, it is exempt from suspension for a period of **v_exempt_secs** elapsed seconds. This ensures that the high cost in disk I/O of paging in the pages of a suspended process results in a reasonable opportunity for progress. The default value of **v_exempt_secs** is 2 seconds.

To alter this parameter, enter the following:

```
# schedo -o v_exempt_secs=1
```

Suppose thrashing is caused occasionally by an application that uses lots of memory but runs for about T seconds. The default system setting of 2 seconds for the **v_exempt_secs** parameter probably causes this application swapping in and out T/2 times on a busy system. In this case, resetting the **v_exempt_secs** parameter to a longer time helps this application progress. System performance improves when this offending application is pushed through quickly.

VMM page replacement tuning

The memory management algorithm, discussed in Real-memory management, tries to keep the size of the free list and the percentage of real memory occupied by persistent segment pages within specified bounds. These bounds can be altered with the **vmo** command, which can only be run by the root user. Changes made by this tool remain in effect until the next reboot of the system. To determine whether the **vmo** command is installed and available, run the following command:

```
# ls1pp -lI bos.perf.tune
```

Executing the **vmo** command with the **-a** option displays the current parameter settings. For example:

```
# vmo -a
  cpu_scale_memp = 8
data_stagger_interval = 161
  defps = 1
  force_realias_lite = 0
  framesets = 2
  htabscale = -1
  kernel_heap_psize = 4096
large_page_heap_size = 0
  lgpg_regions = 0
  lgpg_size = 0
```

```

low_ps_handling = 1
lru_file_repage = 1
lru_poll_interval = 0
  lrubucket = 131072
  maxclient% = 80
  maxfree = 1088
  maxperm = 3118677
  maxperm% = 80
  maxpin = 3355444
  maxpin% = 80
mbuf_heap_psize = 4096
memory_affinity = 1
  memory_frames = 4194304
  memplace_data = 2
  memplace_mapped_file = 2
  memplace_shm_anonymous = 2
  memplace_shm_named = 2
  memplace_stack = 2
  memplace_text = 2
  memplace_unmapped_file = 2
  mempools = 1
  minfree = 960
  minperm = 779669
  minperm% = 20
  nokilluid = 0
  npskill = 1536
  npsrpgmax = 12288
  npsrpgmin = 9216
  npsscrubmax = 12288
  npsscrubmin = 9216
  npswarn = 6144
num_spec_dataseg = 0
  numpsblks = 196608
page_steal_method = 1
  pagecoloring = n/a
  pinnable_frames = 3868256
pta_balance_threshold = n/a
relalias_percentage = 0
  rpgclean = 0
  rpgcontrol = 2
  scrub = 0
  scrubclean = 0
soft_min_lgpgs_vmpool = 0
  spec_dataseg_int = 512
  strict_maxclient = 1
  strict_maxperm = 0
  v_pinshm = 0
vm_modlist_threshold = -1
  vmm_fork_policy = 1

```

Values for minfree and maxfree parameters

The purpose of the free list is to keep track of real-memory page frames released by terminating processes and to supply page frames to requestors immediately, without forcing them to wait for page steals and the accompanying I/O to complete. The **minfree** limit specifies the free-list size below which page stealing to replenish the free list is to be started. The **maxfree** parameter is the size above which stealing ends. In the case of enabling strict file cache limits, like the **strict_maxperm** or **strict_maxclient** parameters, the **minfree** value is used to start page stealing. When the number of persistent pages is equal to or less than the difference between the values of the **maxperm** and **minfree** parameters, with the **strict_maxperm** parameter enabled, or when the number of client pages is equal to or less than the difference between the values of the **maxclient** and **minfree** parameters, with the **strict_maxclient** parameter enabled, page stealing starts.

The objectives in tuning these limits are to ensure the following:

- Any activity that has critical response-time objectives can always get the page frames it needs from the free list.
- The system does not experience unnecessarily high levels of I/O because of premature stealing of pages to expand the free list.

The default values of the **minfree** and **maxfree** parameters depend on the memory size of the machine. The difference between the **maxfree** and **minfree** parameters should always be equal to or greater than the value of the **maxpagehead** parameter, if you are using JFS. For Enhanced JFS, the difference between the **maxfree** and **minfree** parameters should always be equal to or greater than the value of the **j2_maxPageReadAhead** parameter. If you are using both JFS and Enhanced JFS, you should set the value of the **minfree** parameter to a number that is greater than or equal to the larger pagehead value of the two file systems.

The **minfree** and **maxfree** parameter values are different if there is more than one memory pool. Memory pools were introduced in AIX 4.3.3 for MP systems with large amounts of RAM. Each memory pool has its own **minfree** and **maxfree** values, but the **minfree** and **maxfree** values shown by the **vmo** command is the sum of the **minfree** and **maxfree** values for all memory pools.

A less precise but more comprehensive tool for investigating an appropriate size for **minfree** is the **vmstat** command. The following is a portion of **vmstat** command output on a system where the **minfree** value is being reached:

```
# vmstat 1
kthr      memory          page          faults          cpu
-----
 r  b   avm    fre  re  pi  po  fr  sr  cy  in  sy  cs  us  sy  id  wa
2  0 70668   414   0   0   0   0   0   0 178 7364 257 35 14  0 51
1  0 70669   755   0   0   0   0   0   0 196 19119 272 40 20  0 41
1  0 70704   707   0   0   0   0   0   0 190 8506 272 37  8  0 55
1  0 70670   725   0   0   0   0   0   0 205 8821 313 41 10  0 49
6  4 73362   123   0   5  36 313 1646   0 361 16256 863 47 53  0  0
5  3 73547   126   0   6  26 152  614   0 324 18243 1248 39 61  0  0
4  4 73591   124   0   3  11  90  372   0 307 19741 1287 39 61  0  0
6  4 73540   127   0   4  30 122  358   0 340 20097 970 44 56  0  0
8  3 73825   116   0  18  22 220  781   0 324 16012 934 51 49  0  0
8  4 74309    26   0  45  62 291 1079   0 352 14674 972 44 56  0  0
2  9 75322    0   0  41  87 283  943   0 403 16950 1071 44 56  0  0
5  7 75020    74   0  23 119 410 1611   0 353 15908 854 49 51  0  0
```

In the above example output, you can see that the **minfree** value of 120 is constantly being reached. Therefore, page replacement occurs and in this particular case, the free list even reaches 0 at one point. When that happens, threads needing free frames get blocked and cannot run until page replacement frees up some pages. To prevent this situation, you might consider increasing the **minfree** and **maxfree** values.

If you conclude that you should always have at least 1000 pages free, run the following command:

```
# vmo -o minfree=1000 -o maxfree=1008
```

To make this a permanent change, include the **-p** flag:

```
# vmo -o minfree=1000 -o maxfree=1008 -p
```

Starting with AIX 5.3, the default value of the **minfree** parameter is increased to 960 per memory pool and the default value of the **maxfree** parameter is increased to 1088 per memory pool.

Memory pools

The **vmo -o mempools=number_of_memory_pools** command allows you to change the number of memory pools that are configured at system boot time. The **mempools** option is therefore not a dynamic

change. It is recommended to not change this value without a good understanding of the behavior of the system and the VMM algorithms. You cannot change the **mempools** value on a UP kernel and on an MP kernel, the change is written to the kernel file.

List-based LRU

In AIX 5.3, the LRU algorithm can either use lists or the page frame table. Prior to AIX 5.3, the page frame table method was the only method available. The list-based algorithm provides a list of pages to scan for each type of segment. The following is a list of the types of segments:

- Working
- Persistent
- Client
- Compressed

If WLM is enabled, there are lists for classes as well.

You can disable the list-based LRU feature and enable the original physical-address-based scanning with the **page_steal_method** parameter of the **vmo** command. The default value for the **page_steal_method** parameter is 1, which means that the list-based LRU feature is enabled and lists are used to scan pages. If the **page_steal_method** parameter is set to 0, the physical-address-based scanning is used. The value for the **page_steal_method** parameter takes effect after a bosboot and reboot.

Note: With list-based scanning, buckets that are specified with the **lrubucket** parameter are still used, but buckets can overlap on multiple lists and include a count of the number of pages that were scanned.

Reduce memory scanning overhead with the lrubucket parameter

Tuning with the **lrubucket** parameter can reduce scanning overhead on large memory systems. The page-replacement algorithm scans memory frames looking for a free frame. During this scan, reference bits of pages are reset, and if a free frame has not been found, a second scan is done. In the second scan, if the reference bit is still off, the frame will be used for a new page (page replacement).

On large memory systems, there may be too many frames to scan, so now memory is divided up into buckets of frames. The page-replacement algorithm will scan the frames in the bucket and then start over on that bucket for the second scan before moving on to the next bucket. The default number of frames in this bucket is 131072 or 512 MB of RAM. The number of frames is tunable with the command **vmo -o lrubucket=new value**, and the value is in 4 KB frames.

Values for minperm and maxperm parameters

The operating system takes advantage of the varying requirements for real memory by leaving in memory pages of files that have been read or written. If the file pages are requested again before their page frames are reassigned, this technique saves an I/O operation. These file pages may be from local or remote (for example, NFS) file systems.

The ratio of page frames used for files versus those used for computational (working or program text) segments is loosely controlled by the **minperm** and **maxperm** values:

- If percentage of RAM occupied by file pages rises above **maxperm**, page-replacement steals only file pages.
- If percentage of RAM occupied by file pages falls below **minperm**, page-replacement steals both file and computational pages.
- If percentage of RAM occupied by file pages is between **minperm** and **maxperm**, page-replacement steals only file pages unless the number of file repages is higher than the number of computational repages.

In a particular workload, it might be worthwhile to emphasize the avoidance of file I/O. In another workload, keeping computational segment pages in memory might be more important. To understand what the ratio is in the untuned state, use the **vmstat** command with the **-v** option.

```
# vmstat -v
1048576 memory pages
1002054 lruable pages
478136 free pages
    1 memory pools
95342 pinned pages
 80.1 maxpin percentage
 20.0 minperm percentage
 80.0 maxperm percentage
 36.1 numperm percentage
362570 file pages
    0.0 compressed percentage
    0 compressed pages
 35.0 numclient percentage
 80.0 maxclient percentage
350782 client pages
    0 remote pageouts scheduled
 80 pending disk I/Os blocked with no pbuf
 0 paging space I/Os blocked with no psbuf
 3312 filesystem I/Os blocked with no fsbuf
    0 client filesystem I/Os blocked with no fsbuf
474178 external pager filesystem I/Os blocked with no fsbuf
```

The **numperm** value gives the number of file pages in memory, 362570. This is 36.1 percent of real memory.

If you notice that the system is paging out to paging space, it could be that the file repaging rate is higher than the computational repaging rate since the number of file pages in memory is below the **maxperm** value. So, in this case we can prevent computational pages from being paged out by lowering the **maxperm** value to something lower than the **numperm** value. Since the **numperm** value is approximately 36%, we could lower the **maxperm** value down to 30%. Therefore, the page replacement algorithm only steals file pages. If the **lru_file_repage** parameter is set to 0, only file pages are stolen if the number of file pages in memory is greater than the value of the **minperm** parameter.

Persistent file cache limit with the **strict_maxperm** option

The **strict_maxperm** option of the **vmo** command, when set to 1, places a hard limit on how much memory is used for a persistent file cache by making the **maxperm** value be the upper limit for this file cache. When the upper limit is reached, the least recently used (LRU) is performed on persistent pages.

Attention: The **strict_maxperm** option should only be enabled for those cases that require a hard limit on the persistent file cache. Improper use of the **strict_maxperm** option can cause unexpected system behavior because it changes the VMM method of page replacement.

Enhanced JFS file system cache limit with the **maxclient** parameter

The enhanced JFS file system uses client pages for its buffer cache. The limit on client pages in real memory is enforced using the **maxclient** parameter, which is tunable. The **maxclient** parameter represents the maximum number of client pages that can be used for buffer cache if the **strict_maxclient** parameter is set to 1, which is the default value. If the value of the **strict_maxclient** parameter is set to 0, the **maxclient** parameter acts as a soft limit. This means that the number of client pages can exceed the value of the **maxclient** parameter, and if that happens, only client file pages are stolen rather than computational pages when the client LRU daemon runs.

The LRU daemon begins to run when the number of client pages is within the number of **minfree** pages of the **maxclient** parameter's threshold. The LRU daemon attempts to steal client pages that have not been

referenced recently. If the number of client pages is lower than the value of the **maxclient** parameter but higher than the value of the **minperm** parameter, and the value of the **lru_file_repage** parameter is set to 1, the LRU daemon references the repage counters.

If the value of the file repage counter is higher than the value of the computational repage counter, computational pages, which are the working storage, are selected for replacement. If the value of the computational repage counter exceeds the value of the file repage counter, file pages are selected for replacement.

If the value of the **lru_file_repage** parameter is set to 0 and the number of file pages exceeds the value of the **minperm** parameter, file pages are selected for replacement. If the number of file pages is lower than the value of the **minperm** parameter, any page that has not been referenced can be selected for replacement.

If the number of client pages exceeds the value of the **maxclient** parameter, which is possible if the value of the **strict_maxclient** parameter equals 0, file pages are selected for replacement.

The **maxclient** parameter also affects NFS clients and compressed pages. Also note that the **maxclient** parameter should generally be set to a value that is less than or equal to the **maxperm** parameter, particularly in the case where the **strict_maxperm** parameter is enabled, or the value of the **strict_maxperm** is set to 1.

Page space allocation

The following page space allocation policies are available in AIX:

- Deferred Page Space Allocation (DPSA)
- Late Page Space Allocation (LPSA)
- Early Page Space Allocation (EPSA)

Deferred page space allocation

The deferred page space allocation policy is the default policy in AIX. With deferred page space allocation, the disk block allocation of paging space is delayed until it is necessary to page out the page, which results in no wasted paging space allocation. This does, however, result in additional overcommitment of paging space. On a system where enough virtual memory is accessed that paging is necessary, the amount of paging space required may be as much as was required on previously.

After a page has been paged out to paging space, the disk block is reserved for that page if that page is paged back into RAM. Therefore, the paging space percentage-used value may not necessarily reflect the number of pages only in paging space because some of it may be back in RAM as well. If the page that was paged back in is working storage of a thread, and if the thread releases the memory associated with that page or if the thread exits, then the disk block for that page is released. Starting with AIX 5.3, the disk blocks that are in paging space for pages that have been read back into main memory can be released using the paging space garbage collection feature. For detailed information, see “Paging space garbage collection” on page 150.

If paging space garbage collection is not enabled, it is very important to properly configure the amount of paging space. In addition, it is necessary to tune the system to prevent working storage pages from getting paged out due to file page activity if sufficient paging space is not configured. If the working storage requirements of the workload is less than the amount of real memory and if the system is tuned so that file page activity does not cause pageouts of working storage pages, the amount of paging space needed can be minimal. There should be some PTA segments which are not deferred allocation segments. A minimum value of 512 MB is recommended in this case, unless the system uses a large amount of PTA space, which you can determine with the **svmon -S** command.

If the working storage requirements are higher than the amount of real memory, you must have at least as much paging space configured as the size of the working storage virtual memory. Otherwise, the system might eventually run out of paging space.

Late page space allocation

The AIX operating system provides a way to enable the late page space allocation policy, which means that the disk block for a paging space page is only allocated when the corresponding in-memory page is touched. Being *touched* means the page was modified in some way. For example, with the **bzero()** subroutine or if page was requested by the **calloc()** subroutine or the page was initialized to some value.

With the late page space allocation policy, paging space slots are allocated if RAM pages are touched, but the pages are not assigned to a particular process until that process wants to page out. Therefore, there is no guarantee that a process will always have sufficient paging space available if it needed to page out because some other process can start later and consume all of the paging space.

Early page space allocation

If you want to ensure that a process will not be killed due to low paging conditions, this process can preallocate paging space by using the early page space allocation policy. This is done by setting an environment variable called **PSALLOC** to the value of **early**. This can be done from within the process or at the command line (**PSALLOC=early** command). When the process uses the **malloc()** subroutine to allocate memory, this memory will now have paging-space disk blocks reserved for this process, that is, they are reserved for this process so that there is a guarantee that if the process needed to page out, there will always be paging space slots available for it. If using early policy and if CPU savings is a concern, you may want to set another environment variable called **NODISCLAIM=true** so that each **free()** subroutine call does not also result in a **disclaim()** system call.

Choosing between LPSA and DPSA with the vmo command

Using the **vmo -o defps** command enables turning the deferred page space allocation, or DPSA, on or off in order to preserve the late page space allocation policy, or LPSA. A value of 1 indicates that DPSA should be on, and a value of 0 indicates that DPSA should be off.

Paging space and virtual memory

The **vmstat** command (avm column), **ps** command (SIZE, SZ), and other utilities report the amount of virtual memory actually accessed because with DPSA, the paging space might not get touched.

It is safer to use the **lsps -s** command rather than the **lsps -a** command to look at available paging space because the command **lsps -a** only shows paging space that is actually being used. But the **lsps -s** command includes paging space that is being used along with paging space that was reserved using the EPSA policy.

Paging-space thresholds tuning

If available paging space depletes to a low level, the operating system attempts to release resources by first warning processes to release paging space and finally by killing processes if there still is not enough paging space available for the current processes.

Values for the npswarn and npskill parameters

The **npswarn** and **npskill** thresholds are used by the VMM to determine when to first warn processes and eventually when to kill processes.

These two parameters can be set through the **vmo** command:

npswarn

Specifies the number of free paging-space pages at which the operating system begins sending

the SIGDANGER signal to processes. If the **npswarn** threshold is reached and a process is handling this signal, the process can choose to ignore it or do some other action such as exit or release memory using the **disclaim()** subroutine.

The value of **npswarn** must be greater than zero and less than the total number of paging-space pages on the system. It can be changed with the command **vmo -o npswarn=value**.

npskill

Specifies the number of free paging-space pages at which the operating system begins killing processes. If the **npskill** threshold is reached, a SIGKILL signal is sent to the youngest process. Processes that are handling SIGDANGER or processes that are using the early page-space allocation (paging space is allocated as soon as memory is requested) are exempt from being killed. The formula to determine the default value of **npskill** is as follows:

```
npskill = maximum (64, number_of_paging_space_pages/128)
```

The **npskill** value must be greater than zero and less than the total number of paging space pages on the system. It can be changed with the command **vmo -o npskill=value**.

nokillroot and nokilluid

By setting the **nokillroot** option to 1 with the command **vmo -o nokillroot=1**, processes owned by root will be exempt from being killed when the **npskill** threshold is reached.

By setting the **nokilluid** option to a nonzero value with the command **vmo -o nokilluid**, user IDs lower than this value will be exempt from being killed because of low page-space conditions.

The fork() retry interval parameter

If a process cannot be forked due to a lack of paging-space pages, the scheduler will retry the fork five times. In between each retry, the scheduler will delay for a default of 10 clock ticks.

The **pacefork** parameter of the **schedo** command specifies the number of clock ticks to wait before retrying a failed **fork()** call. For example, if a **fork()** subroutine call fails because there is not enough space available to create a new process, the system retries the call after waiting the specified number of clock ticks. The default value is 10, and because there is one clock tick every 10 ms, the system would retry the **fork()** call every 100 ms.

If the paging space is low only due to brief, sporadic workload peaks, increasing the retry interval might allow processes to delay long enough to be released like in the following example:

```
# schedo -o pacefork=15
```

In this way, when the system retries the **fork()** call, there is a higher chance of success because some processes might have finished their execution and, consequently, released pages from paging space.

Paging space garbage collection

Starting with AIX 5.3, you can use the paging space garbage collection feature to free up paging-space disk blocks under certain conditions so that you do not have to configure as much paging space as the amount of virtual memory used for a particular workload. The garbage collection feature is only available for the deferred page space allocation policy.

The following are implementations of the garbage collection mechanisms:

- Garbage collection on paging space blocks after a re-pagein
- Scrubbing of memory to release paging space disk blocks for pages that are already in memory

Garbage collection on paging space blocks after a re-pagein

The method of freeing a paging-space disk block after a page has been read back into memory from paging space is employed by default. The reason that this is not freed up for every re-pagein is because

leaving the blocks in paging space provides better performance in the case of unmodified working storage pages that are stolen by the LRU daemon. If pages are stolen, it is not necessary to perform the re-pageout function.

You can tune the following parameters with the **vmo** command:

npsrpgmin

Purpose: Specifies the number of free paging space blocks threshold when re-pagein garbage collection starts.

Values: Default: MAX (768, **npswarn**+ (**npswarn**/2))

Range: 0 to total number of paging space blocks in the system.

npsrpgax

Purpose: Specifies the number of free paging space blocks threshold when re-pagin garbage collection stops.

Values: Default: MAX (1024, **npswarn***2)

rpgclean

Purpose: Enables or disables the freeing of paging space blocks of pages from the deferred page space allocation policy on read accesses to them.

Values: Default: 0, which signifies free paging space disk blocks only on pagein of pages that are being modified.
A value of 1 signifies free paging space disk blocks on pagein of a page being modified or accessed, or read.

Range: 0 | 1

rpgcontrol

Purpose: Enables or disables the freeing of paging space blocks at pagein of pages from the deferred page space allocation policy.

Values: Default: 2, which signifies that it always enables freeing of paging space disk blocks on pagein, regardless of thresholds.

Note: Read accesses are only processed if the value of the **rpgcontrol** parameter is 1. By default, only write accesses are always processed. A value of 0 disables freeing of paging space disk blocks on pagein.

Range: 0 | 1 | 2

Garbage collection by scrubbing memory

Another method of paging space garbage collection is by scrubbing memory, which is implemented with the **psgc** kernel process. The **psgc** kernel process frees up paging space disk blocks for modified memory pages that have not yet been paged out again or for unmodified pages for which a paging space disk block exists.

The **psgc** kernel process uses the following tunable parameters that you can tune with the **vmo** command:

npsscrubmin

Purpose: Specifies the number of free paging space blocks at which scrubbing of memory pages starts to free disk blocks from pages from the deferred page space allocation policy.

Values: Default: MAX (768, the value of the **npsrpgmin** parameter)

Range: 0 to total number of paging space blocks in the system.

npsscrubmax

Purpose: Specifies the number of free paging space blocks at which scrubbing of memory pages stops to free disk blocks from pages from the deferred page space allocation policy.

Values: Default: MAX (1024, the value of the **npsrpgmax** parameter)

Range: 0 to total number of paging space blocks in the system.

scrub

Purpose: Enables or disables the freeing of paging space disk blocks from pages in memory from pages of the deferred page space allocation Policy.

Values: Default: 0, which completely disables memory scrubbing.
If the value is set to 1, scrubbing of memory of paging space disk blocks is enabled when the number of system free paging space blocks is below the value of the **npsscrubmin** parameter and above the value of the **npsscrubmax** parameter.

Range: 0 | 1

scrubclean

Purpose: Enables or disables the freeing of paging space disk blocks from pages in memory from pages of the deferred page space allocation policy that are not modified.

Values: Default: 0, which signifies free paging space disk blocks only for modified pages in memory
If the value is set to 1, frees paging space disk blocks for modified or unmodified pages.

Range: 0 | 1

Shared memory

By using the **shmat()** or **mmap()** subroutines, files can be explicitly mapped into memory. This avoids buffering and avoids system-call overhead. The memory areas are known as the shared memory segments or regions. Beginning with AIX 4.2.1 and only affecting 32-bit applications, segment 14 was released providing 11 shared memory segments (not including the shared library data or shared library text segments) for processes (segments 3-12 and 14). Each of these segments are 256 MB in size. Applications can read/write the file by reading/writing in the segment. Applications can avoid overhead of read/write system calls simply by manipulating pointers in these mapped segments.

Files or data can also be shared among multiple processes/threads. However, this requires synchronization between these processes/threads and its handling is up to the application. Typical use is by database applications for use as a large database buffer cache.

Paging space is allocated for shared memory regions just as it would for the process private segment (paging space is used as soon as the pages are touched if deferred page space allocation policy is off).

Extended Shared Memory (EXTSHM)

AIX provides a feature called Extended Shared Memory, which allows for more granular shared memory regions. However, the address space consumption will be rounded up to the next page (4096 byte) boundary. Extended Shared Memory essentially removes the limitation of only 11 shared memory regions, but note that when using EXTSHM, the **mmap** services are actually used and thus will have the same performance implications of **mmap**.

This feature is available to processes that have the variable EXTSHM set to ON (**EXTSHM=ON**) in their process environment. There is no limit on the number of shared memory regions that a process can

attach. File mapping is supported as before, but still consumes address space that is a multiple of 256 MB (segment size). Resizing a shared memory region is not supported in this mode. Kernel processes will still have the same behavior.

Extended Shared Memory has the following restrictions:

- I/O support is restricted in the same manner as for memory-mapped regions.
- Only **uphysio()** type of I/O is supported (no raw I/O).
- These shared memory regions cannot be used as I/O buffers where the unpinning of the buffer occurs in an interrupt handler. For example, these regions cannot be used for async I/O buffers.
- The segments cannot be pinned using the **plock()** subroutine because memory-mapped segments cannot be pinned with the **plock()** subroutine.

AIX memory affinity support

AIX memory affinity support introduction

IBM POWER-based SMP hardware systems contain modules that are capable of supporting single, dual, or multiple processor chips depending on the particular system. Each of these modules contain multiple processors and the system memory is attached to these modules. While any processor can access all of the memory in the system, a processor has faster access, and higher bandwidth when addressing memory that is attached to its own module rather than memory attached to the other modules in the system.

AIX provides the capability to allocate memory for a process from the module containing the processor that caused the page fault. You can use this capability if memory affinity support is enabled on your system and by setting the `MEMORY_AFFINITY` environment variable. Memory affinity is enabled by default in AIX 5.2, but you can disable it. Starting with AIX 5.3, you cannot disable memory affinity.

When memory affinity is enabled, each module has its own `vmPool`, which contains one or more memory pools. Each memory pool has its own page replacement daemon, **lrud**. The amount of memory in each pool is based on how much memory is available in the module or allocated to the VMM by the hypervisor layer.

If you are using AIX 5.2 and memory affinity is disabled, the number of memory pools is based on the amount of memory and the number of CPUs in the system.

To disable memory affinity support on AIX 5.2, you can use the following **vmo** command:

```
vmo -o memory_affinity=0
```

Note: A `bosboot` and a `reboot` are required in order for it to take effect. The default value is 1, which means that memory affinity support is enabled.

Enabling memory affinity support tells the operating system to organize its data structures along module boundaries. The default memory allocation policy rotates among the MCMs. In order to obtain preferential local MCM memory allocation, an application must export the `MEMORY_AFFINITY` environment variable as follows:

```
MEMORY_AFFINITY=MCM
```

This behavior is propagated across a fork. However, for this behavior to be retained across a call to the **exec** function, the variable must be contained in the environment string passed to the **exec** function call.

Performance impact of local MCM memory allocation

The effect that local MCM memory allocation has on a specific application is difficult to predict. Some applications are unaffected, some might improve, and others might degrade.

Most applications must be bound to processors to get a performance benefit from memory affinity. This is needed to prevent the AIX dispatcher from moving the application to processors in different MCMs while the application executes.

The most likely way to obtain a benefit from memory affinity is to limit the application to running only on the processors contained in a single MCM. This can be done with the **bindprocessor** command and the **bindprocessor()** function. It can also be done with the **resource set** affinity commands and services.

When the application requires more processors than contained in a single MCM, the performance benefit through memory affinity depends on the memory allocation and access patterns of the various threads in the application. Applications with threads that individually allocate and reference unique data areas may see improved performance. Applications that share memory among all the threads are more likely to get a degradation from memory affinity.

Memory placement with the vmo command

Starting with AIX 5.3, you can allocate user memory with parameters of the **vmo** command. You can also decide on whether you want to use the first-touch scheduling policy or the round-robin scheduling policy. With the first-touch scheduling policy, memory is allocated from the chip module that the thread was running on when it first touched that memory segment, which is the first page fault. With the round-robin scheduling policy, which is the default for all memory types, memory allocation is striped across each of the vmpools.

The following parameters of the **vmo** command control the placement of user memory and can either have a value of 1, signifying the first touch scheduling policy, or 2, signifying the round-robin scheduling policy:

memplace_data

This parameter specifies the memory placement for the following types of data:

- Data of the main executable that is either initialized or uninitialized
- Heap segment data
- Shared library data
- Data of object modules that are loaded at run-time

The default value for this parameter is 2.

memplace_mapped_file

This parameter specifies the memory placement for files that are mapped into the address space of a process, such as the **shmat()** function and the **mmap()** function. The default value for this parameter is 2.

memplace_shm_anonymous

This parameter specifies the memory placement for anonymous shared memory that acts as working storage memory that is created by a call to the **shmget()** function or the **mmap()** function. The memory can only be accessed by the creating process or its descendants and it is not associated with a name or a key. The default value for this parameter is 2.

memplace_shm_named

This parameter specifies the memory placement for named shared memory that acts as working storage memory that is created by a call to the **shmget()** function or the **shm_open()** function. It is associated with a name or a key that allows more than one process to access it simultaneously. The default value for this parameter is 2.

memplace_stack

This parameter specifies the memory placement for the program stack. The default value for this parameter is 2.

memplace_text

This parameter specifies the memory placement for the application text of the main executable, but not for its dependencies. The default value for this parameter is 2.

memplace_unmapped_file

This parameter specifies the memory placement for unmapped file access, such as with the **read()** or **write()** functions. The default value for this parameter is 2.

Memory placement with the MEMORY_AFFINITY environment variable

At the process level, you can configure the placement of user memory with the MEMORY_AFFINITY environment variable, which overrides memory placement with the parameters of the **vmo** command.

The following table lists the possible values for the MEMORY_AFFINITY environment variable:

Table 2.

| Value | Behavior |
|-----------|---|
| MCM | Private memory is local and shared memory is local. |
| SHM=RR | Both System V and Posix Real-Time shared memory are striped across the MCMs. Applies to 4 KB and large-page-backed shared memory objects. This value is only valid for the 64-bit kernel and if the MCM value is also defined. |
| LRU=EARLY | The LRU daemon starts on local memory as soon as low thresholds, such as the minfree parameter, are reached. It does not wait for all the system pools to reach the low thresholds. This value is only valid if the MCM value is also defined. |

You can set multiple values for the MEMORY_AFFINITY environment variable by separating each value with the at sign, (@).

Related information

The **vmo** command and VMM page replacement tuning with the **vmo** command.

The **bindprocessor** command or subroutine.

WLM Class Attributes and Resource Set Attributes.

Large page feature on AIX

This topic includes information on large page support in AIX and contains the following sections:

- “Large page overview”
- “Configuration of applications to use large pages” on page 156
- “System configuration for large pages” on page 157
- “Considerations for using large pages” on page 158

Large page overview

The main purpose for large page usage is to improve system performance for high performance computing (HPC) applications or any memory-access-intensive application that uses large amounts of virtual memory. The improvement in system performance stems from the reduction of translation lookaside buffer (TLB) misses due to the ability of the TLB to map to a larger virtual memory range. Large pages also improve memory prefetching by eliminating the need to restart prefetch operations on 4 KB boundaries.

AIX supports large page usage by both 32-bit and 64-bit applications. Also, the 32-bit and 64-bit versions of the AIX kernel support large pages.

The POWER4 large page architecture requires all the virtual pages in a 256 MB segment to be the same size. AIX supports this architecture by using a mixed mode process model such that some segments in a process are backed with 4 KB pages, while other segments are backed with 16 MB pages. Applications

can request that their heap segments or memory segments be backed with large pages. For detailed information, refer to “Configuration of applications to use large pages.”

AIX maintains separate 4 KB and 16 MB physical memory pools. You can specify the amount of physical memory in the 16 MB memory pool using the **vmo** command. Starting with AIX 5.3, the large page pool is dynamic, so the amount of physical memory that you specify takes effect immediately and does not require a system reboot. The remaining physical memory backs the 4 KB virtual pages.

AIX treats large pages as pinned memory. AIX does not provide paging support for large pages. The data of an application that is backed by large pages remains in physical memory until the application completes. A security access control mechanism prevents unauthorized applications from using large pages or large page physical memory. The security access control mechanism also prevents unauthorized users from using large pages for their applications. For non-root user ids, you must enable the **CAP_BYPASS_RAC_VMM** capability with the **chuser** command in order to use large pages. The following example demonstrates how to grant the **CAP_BYPASS_RAC_VMM** capability as the superuser:

```
# chuser capabilities=CAP_BYPASS_RAC_VMM,CAP_PROPAGATE <user id>
```

Configuration of applications to use large pages

You can configure applications to use large pages in the following ways:

- “Large page usage to back data and heap segments”
- “Large page usage to back shared memory segments” on page 157

Large page usage to back data and heap segments

You must determine an application’s large page data or heap usage when you execute the application because the application cannot switch modes after it starts executing. Large page usage is inherited by the children process of the **fork()** function.

You can configure an application to request large page backing of initialized program data, uninitialized program data (BSS), and heap segments with the following methods:

- “Marking the executable file to request large pages”
- “Setting an environment variable to request large pages”

Marking the executable file to request large pages: The XCOFF header in an executable file contains the **blpdata** flag to indicate that an application wants to use large pages to back the data and heap segments. To mark an executable file to request large pages, use the following command:

```
# ldedit -blpdata <filename>
```

If you decide to no longer use large pages to back the data and heap segments, use the following command to clear the large page flag:

```
# ldedit -bnolpdata <filename>
```

You can also set the **blpdata** option when linking and binding with the **cc** command.

Setting an environment variable to request large pages: You can use the **LDR_CNTRL** environment variable to configure an application to use large pages for the application’s data and heap segments. The environment variable takes precedence over the **blpdata** flag in the executable file.

The following options are available with the **LDR_CNTRL** environment variable:

- The **LDR_CNTRL=LARGE_PAGE_DATA=Y** option specifies that the application that is executed should use large pages for its data and heap segments, which is the same as marking the executable file to use large pages.
- The **LDR_CNTRL=LARGE_PAGE_DATA=N** option specifies that the application that is executed should not use large pages for its data and heap segments, which overrides the setting in an executable marked to use large pages.

- The **LDR_CNTRL=LARGE_PAGE_DATA=M** option specifies that the application that is executed should use large pages in mandatory mode for its data and heap segments.

Note: Set the large page environment variable only for specific applications that might benefit from large page usage. Otherwise, you might experience some performance degradation of your system.

You can specify if you want an application to use large pages for data or heap segments in either of the following modes:

- “Advisory mode”
- “Mandatory mode”

Advisory mode: In advisory mode, the application uses large pages if possible, depending on the following conditions:

- The userid is authorized to use large pages.
- The system hardware has the large page architectural feature.
- You defined a large page memory pool.
- There are enough pages in the large page memory pool to back the entire segment with large pages.

If any of the above conditions are not met, the application’s data and heap segments are backed with 4 KB pages.

In advisory mode it is possible for an application to have some of its heap segments backed by large pages and some of them backed by 4 KB pages. The 4 KB pages back the data or heap segments when there are not enough large pages available to back the segment. Executable files that are marked to use large pages run in advisory mode.

Mandatory mode: In mandatory mode, if an application requests a heap segment and there are not enough large pages to satisfy the request, the allocation request fails, which causes most applications to terminate with an error. If you use the mandatory mode, you must monitor the size of the large page pool and ensure that the pool does not run out of large pages. Otherwise, your mandatory mode large page applications fail.

32-bit applications that use large pages for their data and heap segments use the large page 32-bit process model because of the page protection granularity of large pages. Other process models use 4 KB pages with different protection attributes in the same segment, which does not work when the protection granularity is 16 MB.

Large page usage to back shared memory segments

To back shared memory segments of an application with large pages, you must specify the **SHM_LGPAGE** and **SHM_PIN** flags in the **shmget()** function. If large pages are unavailable, the 4 KB pages back the shared memory segment.

The physical memory that backs large page shared memory and large page data and heap segments comes from the large page physical memory pool. You must ensure that the large page physical memory pool contains enough large pages for both shared memory and data and heap large page usage.

System configuration for large pages

You must configure your system to use large pages and you must also specify the amount of physical memory that you want to allocate to back large pages. The system default is to not have any memory allocated to the large page physical memory pool. You can use the **vmo** command to configure the size of the large page physical memory pool. The following example allocates 4 GB to the large page physical memory pool:

```
# vmo -r -o lpgg_regions=64 -o lpgg_size=16777216
```

To use large pages for shared memory, you must enable the **SHM_PIN shmget()** system call with the following command, which persists across system reboots:

```
# vmo -p -o v_pinshm=1
```

To see how many large pages are in use on your system, use the **vmstat -l** command as in the following example:

```
# vmstat -l
```

```
kthr      memory          page          faults        cpu          large-page
-----
r  b  avm  fre  re  pi  po  fr  sr  cy  in  sy  cs  us  sy  id  wa  alp  flp
2  1 52238 124523  0  0  0  0  0  0 142  41 73  0  3 97  0   16   16
```

From the above example, you can see that there are 16 active large pages, alp, and 16 free large pages, flp.

Considerations for using large pages

Large page support is a special purpose performance improvement feature and is not recommended for general use. Note that not all applications benefit from using large pages. In fact, some applications, such as applications that perform a large number of **fork()** functions, are prone to performance degradation when using large pages.

Rather than using the **LDR_CNTRL** environment variable, consider marking specific executable files to use large pages, because it limits the large page usage to the specific application that benefits from large page usage.

If you are considering using large pages, think about the overall performance impact on your system. While some specific applications might benefit from large page usage, you might see a performance degradation in the overall system performance due to the reduction of 4 KB page storage available on the system. If your system has sufficient physical memory such that reducing the number of 4 KB pages does not significantly hinder the performance of the system, then you might consider using large pages.

Chapter 12. Logical volume and disk I/O performance

This topic focuses on the performance of logical volumes and locally attached disk drives. If you are not familiar with the operating system concepts of volume groups, logical and physical volumes, or logical and physical partitions, read Performance overview of fixed-disk storage management.

Deciding on the number and types of hard disks, and the sizes and placements of paging spaces and logical volumes on those hard disks is a critical pre-installation process because of the performance implications. For an extensive discussion of the considerations for pre-installation disk configuration planning, see Disk Pre-installation Guidelines.

The following sections are presented in this topic:

- Monitoring Disk I/O
- LVM performance monitoring with the `lvmstat` command
- Changing Logical Volume Attributes That Affect Performance
- LVM performance tuning with the `lvmo` command
- Physical Volume Considerations
- Volume Group Recommendations
- Reorganizing Logical Volumes
- Tuning Logical Volume Striping
- Using Raw Disk I/O
- Using `sync/fsync` Calls
- Setting SCSI-Adapter and Disk-Device Queue Limits
- Expanding the Configuration
- Using RAID
- Using SSA
- Using Fast Write Cache

Monitoring Disk I/O

When you are monitoring disk I/O, use the following to determine your course of action:

- Find the most active files, file systems, and logical volumes:
 - Can "hot" file systems be better located on the physical drive or be spread across multiple physical drives? (**lslv**, **iostat**, **filemon**)
 - Are "hot" files local or remote? (**filemon**)
 - Does paging space dominate disk utilization? (**vmstat**, **filemon**)
 - Is there enough memory to cache the file pages being used by running processes? (**vmstat**, **svmon**)
 - Does the application perform a lot of synchronous (non-cached) file I/O?
- Determine file fragmentation:
 - Are "hot" files heavily fragmented? (**fileplace**)
- Find the physical volume with the highest utilization:
 - Is the type of drive or I/O adapter causing a bottleneck? (**iostat**, **filemon**)

Building a Pre-Tuning Baseline

Before you make significant changes in your disk configuration or tuning parameters, it is a good idea to build a baseline of measurements that record the current configuration and performance.

Wait I/O Time Reporting

AIX 4.3.3 and later contain enhancements to the method used to compute the percentage of CPU time spent waiting on disk I/O (wio time). The method used in AIX 4.3.2 and earlier versions of the operating system can, under certain circumstances, give an inflated view of wio time on SMPs. The wio time is reported by the commands **sar** (%wio), **vmstat** (wa) and **iostat** (% iowait).

Another change is that the wa column details the percentage of time the CPU was *idle* with pending disk I/O to not only local, but also NFS-mounted disks.

Method Used in AIX 4.3.2 and Earlier

At each clock interrupt on each processor (100 times a second per processor), a determination is made as to which of the four categories (usr/sys/wio/idle) to place the last 10 ms of time. If the CPU was busy in usr mode at the time of the clock interrupt, then usr gets the clock tick added into its category. If the CPU was busy in kernel mode at the time of the clock interrupt, then the sys category gets the tick. If the CPU was not busy, a check is made to see if any I/O to disk is in progress. If any disk I/O is in progress, the wio category is incremented. If no disk I/O is in progress and the CPU is not busy, the idle category gets the tick.

The inflated view of wio time results from all idle CPUs being categorized as wio regardless of the number of threads waiting on I/O. For example, systems with just one thread doing I/O could report over 90 percent wio time regardless of the number of CPUs it has.

Method Used in AIX 4.3.3 and Later

The change in AIX 4.3.3 is to only mark an idle CPU as wio if an outstanding I/O was started on that CPU. This method can report much lower wio times when just a few threads are doing I/O and the system is otherwise idle. For example, a system with four CPUs and one thread doing I/O will report a maximum of 25 percent wio time. A system with 12 CPUs and one thread doing I/O will report a maximum of 8.3 percent wio time.

Also, starting with AIX 4.3.3, waiting on I/O to NFS mounted file systems is reported as wait I/O time.

Assessing Disk Performance with the iostat Command

Begin the assessment by running the **iostat** command with an interval parameter during your system's peak workload period or while running a critical application for which you need to minimize I/O delays. The following shell script runs the **iostat** command in the background while a copy of a large file runs in the foreground so that there is some I/O to measure:

```
# iostat 5 3 >io.out &
# cp big1 /dev/null
```

```
This example leaves the following three reports in the io.out file:
tty: tin tout avg-cpu: % user % sys % idle
% iowait 0.0 1.3 0.2 0.6 98.9 0.3 Disks: % tm_act Kbps tps Kb_read Kb_wrtn hdisk0 0.0 0.3 0.0 29753
48076 hdisk1 0.1 0.1 0.0 11971 26460 hdisk2 0.2 0.8 0.1 91200 108355 cd0 0.0 0.0 0.0 0 0
tty: tin tout
avg-cpu: % user % sys % idle % iowait 0.8 0.8 0.6 9.7 50.2 39.5 Disks: % tm_act Kbps tps Kb_read
Kb_wrtn hdisk0 47.0 674.6 21.8 3376 24 hdisk1 1.2 2.4 0.6 0 12 hdisk2 4.0 7.9 1.8 8 32 cd0 0.0 0.0 0.0 0
0
tty: tin tout avg-cpu: % user % sys % idle % iowait 2.0 2.0 0.2 1.8 93.4 4.6 Disks: % tm_act Kbps tps
Kb_read Kb_wrtn hdisk0 0.0 0.0 0.0 0 0 hdisk1 0.0 0.0 0.0 0 0 hdisk2 4.8 12.8 3.2 64 0 cd0 0.0 0.0 0.0 0
0
```

The first report is the summary since the last reboot and shows the overall balance (or, in this case, imbalance) in the I/O to each of the hard disks. hdisk1 was almost idle and hdisk2 received about 63 percent of the total I/O (from Kb_read and Kb_wrtn).

Note: The system maintains a history of disk activity. If the history is disabled (**smitty chgsys -> Continuously maintain DISK I/O history [false]**), the following message displays when you run the **iostat** command:

Disk history since boot not available.

The interval disk I/O statistics are unaffected by this.

The second report shows the 5-second interval during which **cp** ran. Examine this information carefully. The elapsed time for this **cp** was about 2.6 seconds. Thus, 2.5 seconds of high I/O dependency are being averaged with 2.5 seconds of idle time to yield the 39.5 percent `% iowait` reported. A shorter interval would have given a more detailed characterization of the command itself, but this example demonstrates what you must consider when you are looking at reports that show average activity across intervals.

TTY Report

The two columns of TTY information (`tin` and `tout`) in the **iostat** output show the number of characters read and written by all TTY devices. This includes both real and pseudo TTY devices. Real TTY devices are those connected to an asynchronous port. Some pseudo TTY devices are shells, **telnet** sessions, and **aixterm** windows.

Because the processing of input and output characters consumes CPU resources, look for a correlation between increased TTY activity and CPU utilization. If such a relationship exists, evaluate ways to improve the performance of the TTY subsystem. Steps that could be taken include changing the application program, modifying TTY port parameters during file transfer, or perhaps upgrading to a faster or more efficient asynchronous communications adapter.

CPU Report

The CPU statistics columns (`% user`, `% sys`, `% idle`, and `% iowait`) provide a breakdown of CPU usage. This information is also reported in the **vmstat** command output in the columns labeled `us`, `sy`, `id`, and `wa`. For a detailed explanation for the values, see The **vmstat** Command. Also note the change made to `% iowait` described in Wait I/O Time Reporting.

On systems running one application, high I/O wait percentage might be related to the workload. On systems with many processes, some will be running while others wait for I/O. In this case, the `% iowait` can be small or zero because running processes "hide" some wait time. Although `% iowait` is low, a bottleneck can still limit application performance.

If the **iostat** command indicates that a CPU-bound situation does not exist, and `% iowait` time is greater than 20 percent, you might have an I/O or disk-bound situation. This situation could be caused by excessive paging due to a lack of real memory. It could also be due to unbalanced disk load, fragmented data or usage patterns. For an unbalanced disk load, the same **iostat** report provides the necessary information. But for information about file systems or logical volumes, which are logical resources, you must use tools such as the **filemon** or **fileplace** commands.

Drive Report

When you suspect a disk I/O performance problem, use the **iostat** command. To avoid the information about the TTY and CPU statistics, use the **-d** option. In addition, the disk statistics can be limited to the important disks by specifying the disk names.

Remember that the first set of data represents all activity since system startup.

Disks: Shows the names of the physical volumes. They are either `hdisk` or `cd` followed by a number. If physical volume names are specified with the **iostat** command, only those names specified are displayed.

% tm_act

Indicates the percentage of time that the physical disk was active (bandwidth utilization for the drive) or, in other words, the total time disk requests are outstanding. A drive is active during data transfer and command processing, such as seeking to a new location. The "disk active time" percentage is directly proportional to resource contention and inversely proportional to performance. As disk use increases, performance decreases and response time increases. In

general, when the utilization exceeds 70 percent, processes are waiting longer than necessary for I/O to complete because most UNIX processes block (or sleep) while waiting for their I/O requests to complete. Look for busy versus idle drives. Moving data from busy to idle drives can help alleviate a disk bottleneck. Paging to and from disk will contribute to the I/O load.

Kbps Indicates the amount of data transferred (read or written) to the drive in KB per second. This is the sum of `Kb_read` plus `Kb_wrtn`, divided by the seconds in the reporting interval.

tps Indicates the number of transfers per second that were issued to the physical disk. A transfer is an I/O request through the device driver level to the physical disk. Multiple logical requests can be combined into a single I/O request to the disk. A transfer is of indeterminate size.

Kb_read

Reports the total data (in KB) read from the physical volume during the measured interval.

Kb_wrtn

Shows the amount of data (in KB) written to the physical volume during the measured interval.

Taken alone, there is no unacceptable value for any of the above fields because statistics are too closely related to application characteristics, system configuration, and type of physical disk drives and adapters. Therefore, when you are evaluating data, look for patterns and relationships. The most common relationship is between disk utilization (`%tm_act`) and data transfer rate (`tps`).

To draw any valid conclusions from this data, you have to understand the application's disk data access patterns such as sequential, random, or combination, as well as the type of physical disk drives and adapters on the system. For example, if an application reads/writes sequentially, you should expect a high disk transfer rate (Kbps) when you have a high disk busy rate (`%tm_act`). Columns `Kb_read` and `Kb_wrtn` can confirm an understanding of an application's read/write behavior. However, these columns provide no information on the data access patterns.

Generally you do not need to be concerned about a high disk busy rate (`%tm_act`) as long as the disk transfer rate (Kbps) is also high. However, if you get a high disk busy rate and a low disk transfer rate, you may have a fragmented logical volume, file system, or individual file.

Discussions of disk, logical volume and file system performance sometimes lead to the conclusion that the more drives you have on your system, the better the disk I/O performance. This is not always true because there is a limit to the amount of data that can be handled by a disk adapter. The disk adapter can also become a bottleneck. If all your disk drives are on one disk adapter, and your hot file systems are on separate physical volumes, you might benefit from using multiple disk adapters. Performance improvement will depend on the type of access.

To see if a particular adapter is saturated, use the **iostat** command and add up all the Kbps amounts for the disks attached to a particular disk adapter. For maximum aggregate performance, the total of the transfer rates (Kbps) must be below the disk adapter throughput rating. In most cases, use 70 percent of the throughput rate. In operating system versions later than 4.3.3 the **-a** or **-A** option will display this information.

Assessing Disk Performance with the vmstat Command

To prove that the system is I/O bound, it is better to use the **iostat** command. However, the **vmstat** command could point to that direction by looking at the `wa` column, as discussed in The **vmstat** Command. Other indicators for I/O bound are:

- The disk xfer part of the **vmstat** output

To display a statistic about the logical disks (a maximum of four disks is allowed), use the following command:

```
# vmstat hdisk0 hdisk1 1 8
kthr      memory          page          faults          cpu      disk xfer
-----
```

```

r  b  avm  fre  re  pi  po  fr  sr  cy  in  sy  cs  us  sy  id  wa  1  2  3  4
0  0  3456 27743  0  0  0  0  0  0  131 149 28  0  1 99  0  0  0
0  0  3456 27743  0  0  0  0  0  0  131  77 30  0  1 99  0  0  0
1  0  3498 27152  0  0  0  0  0  0  153 1088 35  1 10 87  2  0  11
0  1  3499 26543  0  0  0  0  0  0  199 1530 38  1 19  0 80  0  59
0  1  3499 25406  0  0  0  0  0  0  187 2472 38  2 26  0 72  0  53
0  0  3456 24329  0  0  0  0  0  0  178 1301 37  2 12 20 66  0  42
0  0  3456 24329  0  0  0  0  0  0  124  58 19  0  0 99  0  0  0
0  0  3456 24329  0  0  0  0  0  0  123  58 23  0  0 99  0  0  0

```

The disk xfer part provides the number of transfers per second to the specified physical volumes that occurred in the sample interval. One to four physical volume names can be specified. Transfer statistics are given for each specified drive in the order specified. This count represents requests to the physical device. It does not imply an amount of data that was read or written. Several logical requests can be combined into one physical request.

- The in column of the **vmstat** output

This column shows the number of hardware or device interrupts (per second) observed over the measurement interval. Examples of interrupts are disk request completions and the 10 millisecond clock interrupt. Since the latter occurs 100 times per second, the in field is always greater than 100. But the **vmstat** command also provides a more detailed output about the system interrupts.

- The **vmstat -i** output

The **-i** parameter displays the number of interrupts taken by each device since system startup. But, by adding the interval and, optionally, the count parameter, the statistic since startup is only displayed in the first stanza; every trailing stanza is a statistic about the scanned interval.

```

# vmstat -i 1 2
priority level  type  count module(handler)
  0          0  hardware  0 i_misc_pwr(a868c)
  0          1  hardware  0 i_scu(a8680)
  0          2  hardware  0 i_epow(954e0)
  0          2  hardware  0 /etc/drivers/ascsiddpin(189acd4)
  1          2  hardware 194 /etc/drivers/rsdd(1941354)
  3         10  hardware 10589024 /etc/drivers/mpsdd(1977a88)
  3         14  hardware 101947 /etc/drivers/ascsiddpin(189ab8c)
  5         62  hardware 61336129 clock(952c4)
 10         63  hardware 13769 i_softoff(9527c)
priority level  type  count module(handler)
  0          0  hardware  0 i_misc_pwr(a868c)
  0          1  hardware  0 i_scu(a8680)
  0          2  hardware  0 i_epow(954e0)
  0          2  hardware  0 /etc/drivers/ascsiddpin(189acd4)
  1          2  hardware  0 /etc/drivers/rsdd(1941354)
  3         10  hardware  25 /etc/drivers/mpsdd(1977a88)
  3         14  hardware  0 /etc/drivers/ascsiddpin(189ab8c)
  5         62  hardware 105 clock(952c4)
 10         63  hardware  0 i_softoff(9527c)

```

Note: The output will differ from system to system, depending on hardware and software configurations (for example, the clock interrupts may not be displayed in the **vmstat -i** output although they will be accounted for under the in column in the normal **vmstat** output). Check for high numbers in the count column and investigate why this module has to execute so many interrupts.

Assessing Disk Performance with the sar Command

The **sar** command is a standard UNIX command used to gather statistical data about the system. With its numerous options, the **sar** command provides queuing, paging, TTY, and many other statistics. With AIX 4.3.3, the **sar -d** option generates real-time disk I/O statistics.

```

# sar -d 3 3
AIX konark 3 4 0002506F4C00 08/26/99
12:09:50 device %busy avque r+w/s blks/s await avserv

```

| | | | | | | | |
|----------|--------|---|-----|---|---|-----|-----|
| 12:09:53 | hdisk0 | 1 | 0.0 | 0 | 5 | 0.0 | 0.0 |
| | hdisk1 | 0 | 0.0 | 0 | 1 | 0.0 | 0.0 |
| | cd0 | 0 | 0.0 | 0 | 0 | 0.0 | 0.0 |
| 12:09:56 | hdisk0 | 0 | 0.0 | 0 | 0 | 0.0 | 0.0 |
| | hdisk1 | 0 | 0.0 | 0 | 1 | 0.0 | 0.0 |
| | cd0 | 0 | 0.0 | 0 | 0 | 0.0 | 0.0 |
| 12:09:59 | hdisk0 | 1 | 0.0 | 1 | 4 | 0.0 | 0.0 |
| | hdisk1 | 0 | 0.0 | 0 | 1 | 0.0 | 0.0 |
| | cd0 | 0 | 0.0 | 0 | 0 | 0.0 | 0.0 |
| Average | hdisk0 | 0 | 0.0 | 0 | 3 | 0.0 | 0.0 |
| | hdisk1 | 0 | 0.0 | 0 | 1 | 0.0 | 0.0 |
| | cd0 | 0 | 0.0 | 0 | 0 | 0.0 | 0.0 |

The fields listed by the **sar -d** command are as follows:

%busy

Portion of time device was busy servicing a transfer request. This is the same as the `%tm_act` column in the **iostat** command report.

avque Average number of requests outstanding from the adapter to the device during that time. There may be additional I/O operations in the queue of the device driver. This number is a good indicator if an I/O bottleneck exists.

r+w/s Number of read/write transfers from or to device. This is the same as `tps` in the **iostat** command report.

blks/s Number of bytes transferred in 512-byte units

await

Average number of transactions waiting for service (queue length). Average time (in milliseconds) that transfer requests waited idly on queue for the device. This number is currently not reported and shows 0.0 by default.

avserv

Number of milliseconds per average seek. Average time (in milliseconds) to service each transfer request (includes seek, rotational latency, and data transfer times) for the device. This number is currently not reported and shows 0.0 by default.

Assessing Logical Volume Fragmentation with the **lslv** Command

The **lslv** command shows, among other information, the logical volume fragmentation. To check logical volume fragmentation, use the command **lslv -l lvname**, as follows:

```
# lslv -l hd2
hd2:/usr
PV          COPIES      IN BAND      DISTRIBUTION
hdisk0      114:000:000    22%          000:042:026:000:046
```

The output of `COPIES` shows the logical volume `hd2` has only one copy. The `IN BAND` shows how well the intrapolicy, an attribute of logical volumes, is followed. The higher the percentage, the better the allocation efficiency. Each logical volume has its own intrapolicy. If the operating system cannot meet this requirement, it chooses the best way to meet the requirements. In our example, there are a total of 114 logical partitions (LP); 42 LPs are located on middle, 26 LPs on center, and 46 LPs on inner-edge. Since the logical volume intrapolicy is center, the in-band is 22 percent (26 / (42+26+46)). The `DISTRIBUTION` shows how the physical partitions are placed in each part of the intrapolicy; that is:

```
edge : middle : center : inner-middle : inner-edge
```

See [Position on Physical Volume](#) for additional information about physical partitions placement.

Assessing Physical Placement of Data with the `lslv` Command

If the workload shows a significant degree of I/O dependency, you can investigate the physical placement of the files on the disk to determine if reorganization at some level would yield an improvement. To see the placement of the partitions of logical volume `hd11` within physical volume `hdisk0`, use the following:

```
# lslv -p hdisk0 hd11
hdisk0:hd11:/home/op
USED  USED  USED  USED  USED  USED  USED  USED  USED  USED  1-10
USED  USED  USED  USED  USED  USED  USED           11-17

USED  USED  USED  USED  USED  USED  USED  USED  USED  USED  18-27
USED  USED  USED  USED  USED  USED  USED           28-34

USED  USED  USED  USED  USED  USED  USED  USED  USED  USED  35-44
USED  USED  USED  USED  USED  USED           45-50

USED  USED  USED  USED  USED  USED  USED  USED  USED  USED  51-60
0052 0053 0054 0055 0056 0057 0058           61-67

0059 0060 0061 0062 0063 0064 0065 0066 0067 0068  68-77
0069 0070 0071 0072 0073 0074 0075           78-84
```

Look for the rest of `hd11` on `hdisk1` with the following:

```
# lslv -p hdisk1 hd11
hdisk1:hd11:/home/op
0035 0036 0037 0038 0039 0040 0041 0042 0043 0044  1-10
0045 0046 0047 0048 0049 0050 0051           11-17

USED  USED  USED  USED  USED  USED  USED  USED  USED  USED  18-27
USED  USED  USED  USED  USED  USED  USED           28-34

USED  USED  USED  USED  USED  USED  USED  USED  USED  USED  35-44
USED  USED  USED  USED  USED  USED           45-50

0001 0002 0003 0004 0005 0006 0007 0008 0009 0010  51-60
0011 0012 0013 0014 0015 0016 0017           61-67

0018 0019 0020 0021 0022 0023 0024 0025 0026 0027  68-77
0028 0029 0030 0031 0032 0033 0034           78-84
```

From top to bottom, five blocks represent edge, middle, center, inner-middle, and inner-edge, respectively.

- A `USED` indicates that the physical partition at this location is used by a logical volume other than the one specified. A number indicates the logical partition number of the logical volume specified with the `lslv -p` command.
- A `FREE` indicates that this physical partition is not used by any logical volume. Logical volume fragmentation occurs if logical partitions are not contiguous across the disk.
- A `STALE` physical partition is a physical partition that contains data you cannot use. You can also see the `STALE` physical partitions with the `lspv -m` command. Physical partitions marked as `STALE` must be updated to contain the same information as valid physical partitions. This process, called resynchronization with the `syncvg` command, can be done at vary-on time, or can be started anytime the system is running. Until the `STALE` partitions have been rewritten with valid data, they are not used to satisfy read requests, nor are they written to on write requests.

In the previous example, logical volume `hd11` is fragmented within physical volume `hdisk1`, with its first logical partitions in the inner-middle and inner regions of `hdisk1`, while logical partitions 35-51 are in the outer region. A workload that accessed `hd11` randomly would experience unnecessary I/O wait time as longer seeks might be needed on logical volume `hd11`. These reports also indicate that there are no free physical partitions in either `hdisk0` or `hdisk1`.

Assessing File Placement with the fileplace Command

To see how the file copied earlier, **big1**, is stored on the disk, we can use the **fileplace** command. The **fileplace** command displays the placement of a file's blocks within a logical volume or within one or more physical volumes.

To determine whether the **fileplace** command is installed and available, run the following command:

```
# ls1pp -lI perfagent.tools
```

Use the following command:

```
# fileplace -pv big1
```

```
File: big1 Size: 3554273 bytes Vol: /dev/hd10
Blk Size: 4096 Frag Size: 4096 Nfrags: 868 Compress: no
Inode: 19 Mode: -rwxr-xr-x Owner: hoetzel Group: system
```

| Physical Addresses (mirror copy 1) | Logical Fragment |
|---|------------------|
| 0001584-0001591 hdisk0 8 frags 32768 Bytes, 0.9% | 0001040-0001047 |
| 0001624-0001671 hdisk0 48 frags 196608 Bytes, 5.5% | 0001080-0001127 |
| 0001728-0002539 hdisk0 812 frags 3325952 Bytes, 93.5% | 0001184-0001995 |

```
868 frags over space of 956 frags: space efficiency = 90.8%
3 fragments out of 868 possible: sequentiality = 99.8%
```

This example shows that there is very little fragmentation within the file, and those are small gaps. We can therefore infer that the disk arrangement of **big1** is not significantly affecting its sequential read-time. Further, given that a (recently created) 3.5 MB file encounters this little fragmentation, it appears that the file system in general has not become particularly fragmented.

Occasionally, portions of a file may not be mapped to any blocks in the volume. These areas are implicitly filled with zeroes by the file system. These areas show as unallocated logical blocks. A file that has these holes will show the file size to be a larger number of bytes than it actually occupies (that is, the **ls -l** command will show a large size, whereas the **du** command will show a smaller size or the number of blocks the file really occupies on disk).

The **fileplace** command reads the file's list of blocks from the logical volume. If the file is new, the information may not be on disk yet. Use the **sync** command to flush the information. Also, the **fileplace** command will not display NFS remote files (unless the command runs on the server).

Note: If a file has been created by seeking to various locations and writing widely dispersed records, only the pages that contain records will take up space on disk and appear on a **fileplace** report. The file system does not fill in the intervening pages automatically when the file is created. However, if such a file is read sequentially (by the **cp** or **tar** commands, for example) the space between records is read as binary zeroes. Thus, the output of such a **cp** command can be much larger than the input file, although the data is the same.

Space Efficiency and Sequentiality

Higher space efficiency means files are less fragmented and probably provide better sequential file access. A higher sequentiality indicates that the files are more contiguously allocated, and this will probably be better for sequential file access.

Space efficiency =

Total number of fragments used for file storage /
(Largest fragment physical address -
Smallest fragment physical address + 1)

Sequentiality =

(Total number of fragments -
Number of grouped fragments + 1) /
Total number of fragments

If you find that your sequentiality or space efficiency values become low, you can use the **reorgvg** command to improve logical volume utilization and efficiency (see Reorganizing Logical Volumes). To improve file system utilization and efficiency, see Reorganizing File Systems.

In this example, the Largest fragment physical address - Smallest fragment physical address + 1 is: 0002539 - 0001584 + 1 = 956 fragments; total used fragments is: 8 + 48 + 812 = 868; the space efficiency is 868 / 956 (90.8 percent); the sequentiality is (868 - 3 + 1) / 868 = 99.8 percent.

Because the total number of fragments used for file storage does not include the indirect blocks location, but the physical address does, the space efficiency can never be 100 percent for files larger than 32 KB, even if the file is located on contiguous fragments.

Assessing Paging Space I/O with the vmstat Command

I/O to and from paging spaces is random, mostly one page at a time. The **vmstat** reports indicate the amount of paging-space I/O taking place. Both of the following examples show the paging activity that occurs during a C compilation in a machine that has been artificially shrunk using the **rmss** command. The **pi** and **po** (paging-space page-ins and paging-space page-outs) columns show the amount of paging-space I/O (in terms of 4096-byte pages) during each 5-second interval. The first report (summary since system reboot) has been removed. Notice that the paging activity occurs in bursts.

```
# vmstat 5 8
kthr      memory          page          faults          cpu
-----
 r  b   avm    fre re  pi  po  fr  sr  cy  in  sy  cs  us  sy  id  wa
0  1 72379  434 0   0   0  0   2  0 376 192 478  9  3 87  1
0  1 72379  391 0   8   0  0   0  0 631 2967 775 10  1 83  6
0  1 72379  391 0   0   0  0   0  0 625 2672 790  5  3 92  0
0  1 72379  175 0   7   0  0   0  0 721 3215 868  8  4 72 16
2  1 71384  877 0  12  13 44 150  0 662 3049 853  7 12 40 41
0  2 71929  127 0  35  30 182 666  0 709 2838 977 15 13  0 71
0  1 71938  122 0   0   8  32 122  0 608 3332 787 10  4 75 11
0  1 71938  122 0   0   0   3  12  0 611 2834 733  5  3 75 17
```

The following "before and after" **vmstat -s** reports show the accumulation of paging activity. Remember that it is the paging space page ins and paging space page outs that represent true paging-space I/O. The (unqualified) page ins and page outs report total I/O, that is both paging-space I/O and the ordinary file I/O, performed by the paging mechanism. The reports have been edited to remove lines that are irrelevant to this discussion.

| # vmstat -s # before | # vmstat -s # after |
|------------------------------------|------------------------------------|
| 6602 page ins | 7022 page ins |
| 3948 page outs | 4146 page outs |
| 544 paging space page ins | 689 paging space page ins |
| 1923 paging space page outs | 2032 paging space page outs |
| 0 total reclaims | 0 total reclaims |

The fact that more paging-space page-ins than page-outs occurred during the compilation suggests that we had shrunk the system to the point that thrashing begins. Some pages were being repaged because their frames were stolen before their use was complete.

Assessing Overall Disk I/O with the vmstat Command

The technique just discussed can also be used to assess the disk I/O load generated by a program. If the system is otherwise idle, the following sequence:

```
# vmstat -s >statout
# testpgm
# sync
# vmstat -s >> statout
# egrep "ins|outs" statout
```

yields a before and after picture of the cumulative disk activity counts, such as:

```
5698 page ins
5012 page outs
  0 paging space page ins
 32 paging space page outs
6671 page ins
5268 page outs
  8 paging space page ins
225 paging space page outs
```

During the period when this command (a large C compile) was running, the system read a total of 981 pages (8 from paging space) and wrote a total of 449 pages (193 to paging space).

Detailed I/O Analysis with the filemon Command

The **filemon** command uses the trace facility to obtain a detailed picture of I/O activity during a time interval on the various layers of file system utilization, including the logical file system, virtual memory segments, LVM, and physical disk layers. Data can be collected on all the layers, or layers can be specified with the **-O** layer option. The default is to collect data on the VM, LVM, and physical layers. Both summary and detailed reports are generated. Since it uses the trace facility, the **filemon** command can be run only by the root user or by a member of the system group.

To determine whether the **filemon** command is installed and available, run the following command:

```
# ls1pp -lI perfagent.tools
```

Tracing is started by the **filemon** command, optionally suspended with the **trcoff** subcommand and resumed with the **trcon** subcommand, and terminated with the **trcstop** subcommand (you may want to issue the command **nice -n -20 trcstop** to stop the **filemon** command since the **filemon** command is currently running at priority 40). As soon as tracing is terminated, the **filemon** command writes its report to stdout.

Note: Only data for those files opened after the **filemon** command was started will be collected, unless you specify the **-u** flag.

The **filemon** command can read the I/O trace data from a specified file, instead of from the real-time trace process. In this case, the **filemon** report summarizes the I/O activity for the system and period represented by the trace file. This offline processing method is useful when it is necessary to postprocess a trace file from a remote machine or perform the trace data collection at one time and postprocess it at another time.

The **trcrpt -r** command must be executed on the trace logfile and redirected to another file, as follows:

```
# gennames > gennames.out
# trcrpt -r trace.out > trace.rpt
```

At this point an adjusted trace logfile is fed into the **filemon** command to report on I/O activity captured by a previously recorded trace session as follows:

```
# filemon -i trace.rpt -n gennames.out | pg
```

In this example, the **filemon** command reads file system trace events from the input file **trace.rpt**. Because the trace data is already captured on a file, the **filemon** command does not put itself in the background to allow application programs to be run. After the entire file is read, an I/O activity report for the virtual memory, logical volume, and physical volume levels is displayed on standard output (which, in this example, is piped to the **pg** command).

If the **trace** command was run with the **-C all** flag, then run the **trcrpt** command also with the **-C all** flag (see Formatting a Report from trace -C Output).

The following sequence of commands gives an example of the **filemon** command usage:

```
# filemon -o fm.out -0 all; cp /smit.log /dev/null ; trcstop
```

The report produced by this sequence, in an otherwise-idle system, is as follows:

Thu Aug 19 11:30:49 1999

System: AIX texmex Node: 4 Machine: 000691854C00

0.369 secs in measured interval

Cpu utilization: 9.0%

Most Active Files

| #MBs | #opns | #rds | #wrs | file | volume:inode |
|------|-------|------|------|--------------|----------------|
| 0.1 | 1 | 14 | 0 | smit.log | /dev/hd4:858 |
| 0.0 | 1 | 0 | 13 | null | |
| 0.0 | 2 | 4 | 0 | ksh.cat | /dev/hd2:16872 |
| 0.0 | 1 | 2 | 0 | cmdtrace.cat | /dev/hd2:16739 |

Most Active Segments

| #MBs | #rpgs | #wpgs | segid | segtype | volume:inode |
|------|-------|-------|-------|------------|--------------|
| 0.1 | 13 | 0 | 5e93 | ??? | |
| 0.0 | 2 | 0 | 22ed | ??? | |
| 0.0 | 1 | 0 | 5c77 | persistent | |

Most Active Logical Volumes

| util | #rblk | #wblk | KB/s | volume | description |
|------|-------|-------|-------|----------|-------------|
| 0.06 | 112 | 0 | 151.9 | /dev/hd4 | / |
| 0.04 | 16 | 0 | 21.7 | /dev/hd2 | /usr |

Most Active Physical Volumes

| util | #rblk | #wblk | KB/s | volume | description |
|------|-------|-------|-------|-------------|-------------|
| 0.10 | 128 | 0 | 173.6 | /dev/hdisk0 | N/A |

Detailed File Stats

FILE: /smit.log volume: /dev/hd4 (/) inode: 858

opens: 1

total bytes xfrd: 57344

reads: 14 (0 errs)

read sizes (bytes): avg 4096.0 min 4096 max 4096 sdev 0.0

read times (msec): avg 1.709 min 0.002 max 19.996 sdev 5.092

FILE: /dev/null

```

opens: 1
total bytes xfrd: 50600
writes: 13 (0 errs)
  write sizes (bytes): avg 3892.3 min 1448 max 4096 sdev 705.6
  write times (msec): avg 0.007 min 0.003 max 0.022 sdev 0.006

```

FILE: /usr/lib/nls/msg/en_US/ksh.cat volume: /dev/hd2 (/usr) inode: 16872

```

opens: 2
total bytes xfrd: 16384
reads: 4 (0 errs)
  read sizes (bytes): avg 4096.0 min 4096 max 4096 sdev 0.0
  read times (msec): avg 0.042 min 0.015 max 0.070 sdev 0.025
lseeks: 10

```

FILE: /usr/lib/nls/msg/en_US/cmdtrace.cat volume: /dev/hd2 (/usr) inode: 16739

```

opens: 1
total bytes xfrd: 8192
reads: 2 (0 errs)
  read sizes (bytes): avg 4096.0 min 4096 max 4096 sdev 0.0
  read times (msec): avg 0.062 min 0.049 max 0.075 sdev 0.013
lseeks: 8

```

Detailed VM Segment Stats (4096 byte pages)

SEGMENT: 5e93 segtype: ???

```

segment flags:
reads: 13 (0 errs)
  read times (msec): avg 1.979 min 0.957 max 5.970 sdev 1.310
  read sequences: 1
  read seq. lengths: avg 13.0 min 13 max 13 sdev 0.0

```

SEGMENT: 22ed segtype: ???

```

segment flags: inode
reads: 2 (0 errs)
  read times (msec): avg 8.102 min 7.786 max 8.418 sdev 0.316
  read sequences: 2
  read seq. lengths: avg 1.0 min 1 max 1 sdev 0.0

```

SEGMENT: 5c77 segtype: persistent

```

segment flags: pers defer
reads: 1 (0 errs)
  read times (msec): avg 13.810 min 13.810 max 13.810 sdev 0.000
  read sequences: 1
  read seq. lengths: avg 1.0 min 1 max 1 sdev 0.0

```

Detailed Logical Volume Stats (512 byte blocks)

VOLUME: /dev/hd4 description: /

```

reads: 5 (0 errs)
  read sizes (blks): avg 22.4 min 8 max 40 sdev 12.8
  read times (msec): avg 4.847 min 0.938 max 13.792 sdev 4.819
  read sequences: 3
  read seq. lengths: avg 37.3 min 8 max 64 sdev 22.9
seeks: 3 (60.0%)
  seek dist (blks): init 6344,
  avg 40.0 min 8 max 72 sdev 32.0
time to next req(msec): avg 70.473 min 0.224 max 331.020 sdev 130.364
throughput: 151.9 KB/sec
utilization: 0.06

```

VOLUME: /dev/hd2 description: /usr

```

reads: 2 (0 errs)
  read sizes (blks): avg 8.0 min 8 max 8 sdev 0.0

```

```

read times (msec):  avg  8.078 min  7.769 max  8.387 sdev  0.309
read sequences:      2
read seq. lengths:  avg   8.0 min           8 max           8 sdev   0.0
seeks:               2 (100.0%)
seek dist (blks):   init 608672,
                   avg  16.0 min           16 max           16 sdev   0.0
time to next req(msec): avg 162.160 min  8.497 max 315.823 sdev 153.663
throughput:         21.7 KB/sec
utilization:        0.04

```

Detailed Physical Volume Stats (512 byte blocks)

```

VOLUME: /dev/hdisk0 description: N/A
reads:      7 (0 errs)
read sizes (blks):  avg  18.3 min           8 max           40 sdev  12.6
read times (msec):  avg  5.723 min  0.905 max  20.448 sdev  6.567
read sequences:      5
read seq. lengths:  avg  25.6 min           8 max           64 sdev  22.9
seeks:         5 (71.4%)
seek dist (blks):  init 4233888,
                   avg 171086.0 min           8 max  684248 sdev 296274.2
seek dist (%tot blks):init 48.03665,
                   avg 1.94110 min 0.00009 max 7.76331 sdev 3.36145
time to next req(msec): avg 50.340 min  0.226 max 315.865 sdev 108.483
throughput:      173.6 KB/sec
utilization:     0.10

```

Using the **filemon** command in systems with real workloads would result in much larger reports and might require more trace buffer space. Space and CPU time consumption for the **filemon** command can degrade system performance to some extent. Use a nonproduction system to experiment with the **filemon** command before starting it in a production environment. Also, use offline processing and on systems with many CPUs use the **-C all** flag with the **trace** command.

Note: Although the **filemon** command reports average, minimum, maximum, and standard deviation in its detailed-statistics sections, the results should not be used to develop confidence intervals or other formal statistical inferences. In general, the distribution of data points is neither random nor symmetrical.

Global Reports of the filemon Command

The global reports list the most active files, segments, logical volumes, and physical volumes during the measured interval. They are shown at the beginning of the **filemon** report. By default, the logical file and virtual memory reports are limited to the 20 most active files and segments, respectively, as measured by the total amount of data transferred. If the **-v** flag has been specified, activity for all files and segments is reported. All information in the reports is listed from top to bottom as most active to least active.

Most Active Files:

#MBs Total number of MBs transferred over measured interval for this file. The rows are sorted by this field in decreasing order.

#opns Number of opens for files during measurement period.

#rds Number of read calls to file.

#wrs Number of write calls to file.

file File name (full path name is in detailed report).

volume:inode

The logical volume that the file resides in and the i-node number of the file in the associated file

system. This field can be used to associate a file with its corresponding persistent segment shown in the detailed VM segment reports. This field may be blank for temporary files created and deleted during execution.

The most active files are **smit.log** on logical volume hd4 and file **null**. The application utilizes the terminfo database for screen management; so the **ksh.cat** and **cmdtrace.cat** are also busy. Anytime the shell needs to post a message to the screen, it uses the catalogs for the source of the data.

To identify unknown files, you can translate the logical volume name, **/dev/hd1**, to the mount point of the file system, **/home**, and use the **find** or the **ncheck** command:

```
# find / -inum 858 -print
/smit.log
```

or

```
# ncheck -i 858 /
/:
858    /smit.log
```

Most Active Segments:

#MBs Total number of MBs transferred over measured interval for this segment. The rows are sorted by this field in decreasing order.

#rpgs Number of 4-KB pages read into segment from disk.

#wpgs

Number of 4-KB pages written from segment to disk (page out).

#segid

VMM ID of memory segment.

segtype

Type of segment: working segment, persistent segment (local file), client segment (remote file), page table segment, system segment, or special persistent segments containing file system data (log, root directory, .inode, .inodemap, .inodex, .inodexmap, .indirect, .diskmap).

volume:inode

For persistent segments, name of logical volume that contains the associated file and the file's i-node number. This field can be used to associate a persistent segment with its corresponding file, shown in the Detailed File Stats reports. This field is blank for nonpersistent segments.

If the command is still active, the virtual memory analysis tool **svmon** can be used to display more information about a segment, given its segment ID (segid), as follows: **svmon -D segid**. See The svmon Command for a detailed discussion.

In our example, the segtype ??? means that the system cannot identify the segment type, and you must use the **svmon** command to get more information.

Most Active Logical Volumes:

util Utilization of logical volume.

#rblk Number of 512-byte blocks read from logical volume.

#wblk Number of 512-byte blocks written to logical volume.

KB/s Average transfer data rate in KB per second.

volume

Logical volume name.

description

Either the file system mount point or the logical volume type (paging, jfslog, boot, or sysdump). For example, the logical volume `/dev/hd2` is `/usr`; `/dev/hd6` is paging, and `/dev/hd8` is jfslog. There may also be the word *compressed*. This means all data is compressed automatically using Lempel-Zev (LZ) compression before being written to disk, and all data is uncompressed automatically when read from disk (see Compression for details).

The utilization is presented in percentage, 0.06 indicates 6 percent busy during measured interval.

Most Active Physical Volumes:

util Utilization of physical volume.

Note: Logical volume I/O requests start before and end after physical volume I/O requests. Total logical volume utilization will appear therefore to be higher than total physical volume utilization.

#rblk Number of 512-byte blocks read from physical volume.

#wblk Number of 512-byte blocks written to physical volume.

KB/s Average transfer data rate in KB per second.

volume

Physical volume name.

description

Simple description of the physical volume type, for example, SCSI Multimedia CD-ROM Drive or 16 Bit SCSI Disk Drive.

The utilization is presented in percentage, 0.10 indicates 10 percent busy during measured interval.

Detailed Reports of the filemon Command

The detailed reports give additional information for the global reports. There is one entry for each reported file, segment, or volume in the detailed reports. The fields in each entry are described below for the four detailed reports. Some of the fields report a single value; others report statistics that characterize a distribution of many values. For example, response-time statistics are kept for all read or write requests that were monitored. The average, minimum, and maximum response times are reported, as well as the standard deviation of the response times. The standard deviation is used to show how much the individual response times deviated from the average. Approximately two-thirds of the sampled response times are between average minus standard deviation ($avg - sdev$) and average plus standard deviation ($avg + sdev$). If the distribution of response times is scattered over a large range, the standard deviation will be large compared to the average response time.

Detailed File Stats: Detailed file statistics are provided for each file listed in the Most Active Files report. These stanzas can be used to determine what access has been made to the file. In addition to the number of total bytes transferred, opens, reads, writes, and lseeks, the user can also determine the read/write size and times.

FILE Name of the file. The full path name is given, if possible.

volume

Name of the logical volume/file system containing the file.

inode I-node number for the file within its file system.

opens Number of times the file was opened while monitored.

total bytes xfrd

Total number of bytes read/written from/to the file.

reads Number of read calls against the file.

read sizes (bytes)

Read transfer-size statistics (avg/min/max/sdev), in bytes.

read times (msec)

Read response-time statistics (avg/min/max/sdev), in milliseconds.

writes Number of write calls against the file.

write sizes (bytes)

Write transfer-size statistics.

write times (msec)

Write response-time statistics.

lseeks

Number of **lseek()** subroutine calls.

The read sizes and write sizes will give you an idea of how efficiently your application is reading and writing information. Use a multiple of 4 KB pages for best results.

Detailed VM Segment Stats: Each element listed in the Most Active Segments report has a corresponding stanza that shows detailed information about real I/O to and from memory.

SEGMENT

Internal operating system's segment ID.

segtype

Type of segment contents.

segment flags

Various segment attributes.

volume

For persistent segments, the name of the logical volume containing the corresponding file.

inode For persistent segments, the i-node number for the corresponding file.

reads Number of 4096-byte pages read into the segment (that is, paged in).

read times (msec)

Read response-time statistics (avg/min/max/sdev), in milliseconds.

read sequences

Number of read sequences. A sequence is a string of pages that are read (paged in) consecutively. The number of read sequences is an indicator of the amount of sequential access.

read seq. lengths

Statistics describing the lengths of the read sequences, in pages.

writes Number of pages written from the segment to disk (that is, paged out).

write times (msec)

Write response-time statistics.

write sequences

Number of write sequences. A sequence is a string of pages that are written (paged out) consecutively.

write seq. lengths

Statistics describing the lengths of the write sequences, in pages.

By examining the reads and read-sequence counts, you can determine if the access is sequential or random. For example, if the read-sequence count approaches the reads count, the file access is more

random. On the other hand, if the read-sequence count is significantly smaller than the read count and the read-sequence length is a high value, the file access is more sequential. The same logic applies for the writes and write sequence.

Detailed Logical/Physical Volume Stats: Each element listed in the Most Active Logical Volumes / Most Active Physical Volumes reports will have a corresponding stanza that shows detailed information about the logical/physical volume. In addition to the number of reads and writes, the user can also determine read and write times and sizes, as well as the initial and average seek distances for the logical / physical volume.

VOLUME

Name of the volume.

description

Description of the volume. (Describes contents, if dealing with a logical volume; describes type, if dealing with a physical volume.)

reads Number of read requests made against the volume.

read sizes (blks)

Read transfer-size statistics (avg/min/max/sdev), in units of 512-byte blocks.

read times (msec)

Read response-time statistics (avg/min/max/sdev), in milliseconds.

read sequences

Number of read sequences. A sequence is a string of 512-byte blocks that are read consecutively. It indicates the amount of sequential access.

read seq. lengths

Statistics describing the lengths of the read sequences, in blocks.

writes Number of write requests made against the volume.

write sizes (blks)

Write transfer-size statistics.

write times (msec)

Write-response time statistics.

write sequences

Number of write sequences. A sequence is a string of 512-byte blocks that are written consecutively.

write seq. lengths

Statistics describing the lengths of the write sequences, in blocks.

seeks Number of seeks that preceded a read or write request; also expressed as a percentage of the total reads and writes that required seeks.

seek dist (blks)

Seek-distance statistics in units of 512-byte blocks. In addition to the usual statistics (avg/min/max/sdev), the distance of the initial seek operation (assuming block 0 was the starting position) is reported separately. This seek distance is sometimes very large; it is reported separately to avoid skewing the other statistics.

seek dist (cyls)

(Physical volume only) Seek-distance statistics in units of disk cylinders.

time to next req

Statistics (avg/min/max/sdev) describing the length of time, in milliseconds, between consecutive read or write requests to the volume. This column indicates the rate at which the volume is being accessed.

throughput

Total volume throughput in KB per second.

utilization

Fraction of time the volume was busy. The entries in this report are sorted by this field in decreasing order.

A long seek time can increase I/O response time and result in decreased application performance. By examining the reads and read sequence counts, you can determine if the access is sequential or random. The same logic applies to the writes and write sequence.

Guidelines for Using the filemon Command

Following are some guidelines for using the **filemon** command:

- The **/etc/inittab** file is always very active. Daemons specified in **/etc/inittab** are checked regularly to determine whether they are required to be respawned.
- The **/etc/passwd** file is also always very active. Because files and directories access permissions are checked.
- A long seek time increases I/O response time and decreases performance.
- If the majority of the reads and writes require seeks, you might have fragmented files and overly active file systems on the same physical disk. However, for online transaction processing (OLTP) or database systems this behavior might be normal.
- If the number of reads and writes approaches the number of sequences, physical disk access is more random than sequential. Sequences are strings of pages that are read (paged in) or written (paged out) consecutively. The `seq. lengths` is the length, in pages, of the sequences. A random file access can also involve many seeks. In this case, you cannot distinguish from the **filemon** output if the file access is random or if the file is fragmented. Use the **fileplace** command to investigate further.
- Remote files are listed in the `volume:inode` column with the remote system name.

Because the **filemon** command can potentially consume some CPU power, use this tool with discretion, and analyze the system performance while taking into consideration the overhead involved in running the tool. Tests have shown that in a CPU-saturated environment:

- With little I/O, the **filemon** command slowed a large compile by about one percent.
- With a high disk-output rate, the **filemon** command slowed the writing program by about five percent.

Summary for Monitoring Disk I/O

In general, a high `% iowait` indicates that the system has an application problem, a memory shortage, or an inefficient I/O subsystem configuration. For example, the application problem might be due to requesting a lot of I/O, but not doing much with the data. Understanding the I/O bottleneck and improving the efficiency of the I/O subsystem is the key in solving this bottleneck. Disk sensitivity can come in a number of forms, with different resolutions. Some typical solutions might include:

- Limiting number of active logical volumes and file systems placed on a particular physical disk. The idea is to balance file I/O evenly across all physical disk drives.
- Spreading a logical volume across multiple physical disks. This is particularly useful when a number of different files are being accessed.
- Creating multiple Journaled File Systems (JFS) logs for a volume group and assigning them to specific file systems (preferably on fast write cache devices). This is beneficial for applications that create, delete, or modify a large number of files, particularly temporary files.
- If the **iostat** output indicates that your workload I/O activity is not evenly distributed among the system disk drives, and the utilization of one or more disk drives is often 70-80 percent or more, consider reorganizing file systems, such as backing up and restoring file systems to reduce fragmentation. Fragmentation causes the drive to seek excessively and can be a large portion of overall response time.
- If large, I/O-intensive background jobs are interfering with interactive response time, you may want to activate I/O pacing.

- If it appears that a small number of files are being read over and over again, consider whether additional real memory would allow those files to be buffered more effectively.
- If the workload's access pattern is predominantly random, you might consider adding disks and distributing the randomly accessed files across more drives.
- If the workload's access pattern is predominantly sequential and involves multiple disk drives, you might consider adding one or more disk adapters. It may also be appropriate to consider building a striped logical volume to accommodate large, performance-critical sequential files.
- Using fast write cache devices.
- Using asynchronous I/O.

Each technique is discussed later in this chapter.

LVM performance monitoring with the `lvmstat` command

You can use the `lvmstat` command to detect whether certain areas or partitions of a logical volume are accessed more frequently than others. In order to display the statistics of these frequently accessed areas with the `lvmstat` command, you must enable the statistics to run on a per logical volume or volume group basis.

To enable the statistics for the `lvmstat` command for a specific logical volume, use the following command:

```
# lvmstat -l lvname -e
```

To disable the statistics for the `lvmstat` command for a specific logical volume, use the following command:

```
# lvmstat -l lvname -d
```

To enable the statistics for the `lvmstat` command for all logical volumes in a volume group, use the following command:

```
# lvmstat -v vgname -e
```

To disable the statistics for the `lvmstat` command for all logical volumes in a volume group, use the following command:

```
# lvmstat -v vgname -d
```

When using the `lvmstat` command, if you do not specify an interval value, the output displays the statistics for every partition in the logical volume. When you specify an interval value, in seconds, the `lvmstat` command output only displays statistics for the particular partitions that have been accessed in the specified interval. The following is an example of the `lvmstat` command:

```
# lvmstat -l lv00 1
```

| Log_part | mirror# | iocnt | Kb_read | Kb_wrtn | Kbps |
|----------|---------|-------|---------|---------|----------|
| 1 | 1 | 65536 | 32768 | 0 | 0.02 |
| 2 | 1 | 53718 | 26859 | 0 | 0.01 |
| Log_part | mirror# | iocnt | Kb_read | Kb_wrtn | Kbps |
| 2 | 1 | 5420 | 2710 | 0 | 14263.16 |
| Log_part | mirror# | iocnt | Kb_read | Kb_wrtn | Kbps |
| 2 | 1 | 5419 | 2709 | 0 | 15052.78 |
| Log_part | mirror# | iocnt | Kb_read | Kb_wrtn | Kbps |
| 3 | 1 | 4449 | 2224 | 0 | 13903.12 |
| 2 | 1 | 979 | 489 | 0 | 3059.38 |
| Log_part | mirror# | iocnt | Kb_read | Kb_wrtn | Kbps |
| 3 | 1 | 5424 | 2712 | 0 | 12914 |

You can use the **-c** flag to limit the number of statistics the **lvmstat** command displays. The **-c** flag specifies the number of partitions with the most I/O activity that you want displayed. The following is an example of using the **lvmstat** command with the **-c** flag:

```
# lvmstat -l 1v00 -c 5
```

The above command displays the statistics for the 5 partitions with the most I/O activity.

If you do not specify the iterations parameter, the **lvmstat** command continues to produce output until you interrupt the command. Otherwise, the **lvmstat** command displays statistics for the number of iterations specified.

In using the **lvmstat** command, if you find that there are only a few partitions that are heavily used, you might want to separate these partitions over different hard disks using the **migratelp** command. The **migratelp** command allows you to migrate individual partitions from one hard disk to another. For details on using the **migratelp** command, see **migratelp Command** in *AIX 5L Version 5.3 Commands Reference, Volume 3*.

For more options and information about the **lvmstat** command, see **lvmstat Command** in *AIX 5L Version 5.3 Commands Reference, Volume 3*.

Changing Logical Volume Attributes That Affect Performance

Various factors have performance implications and can be controlled when creating a logical volume. These options appear as prompts for values on the **smitty mklv** screen.

Position on Physical Volume

The *Intra-Physical Volume Allocation Policy* specifies what strategy should be used for choosing physical partitions on a physical volume. The five general strategies are edge, inner-edge, middle, inner-middle, and center.

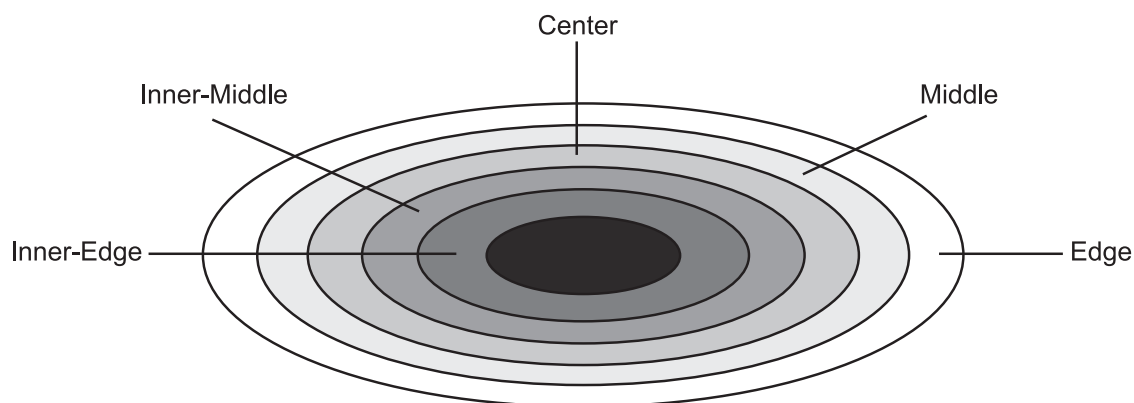

Figure 17. Intra-Physical Volume Allocation Policy. This figure illustrates storage position on a physical volume or disk. The disk is formatted into hundreds of tracks beginning at the outer edge of the disk and moving toward the center of the disk. Because of the way a disk is read (the tracks spinning under a movable read/write head), data that is written toward the center of the disk will have faster seek times than data that is written on the outer edge. In part, this is due to the mechanical action of the read/write head and the sectors of each track having to pass under the head. Data is more dense as it moves toward the center, resulting in less physical movement of the head. This results in faster overall throughput.

Physical partitions are numbered consecutively, starting with number one, from the outer-most edge to the inner-most edge.

The edge and inner-edge strategies specify allocation of partitions to the edges of the physical volume. These partitions have the slowest average seek times, which generally result in longer response times for any application that uses them. Edge on disks produced since the mid-1990s can hold more sectors per track so that the edge is faster for sequential I/O.

The middle and inner-middle strategies specify to avoid the edges of the physical volume and out of the center when allocating partitions. These strategies allocate reasonably good locations for partitions with reasonably good average seek times. Most of the partitions on a physical volume are available for allocation using this strategy.

The center strategy specifies allocation of partitions to the center section of each physical volume. These partitions have the fastest average seek times, which generally result in the best response time for any application that uses them. Fewer partitions on a physical volume satisfy the center strategy than any other general strategy.

The paging space logical volume is a good candidate for allocation at the center of a physical volume if there is lot of paging activity. At the other extreme, the dump and boot logical volumes are used infrequently and, therefore, should be allocated at the beginning or end of the physical volume.

The general rule, then, is that the more I/Os, either absolutely or in the course of running an important application, the closer to the center of the physical volumes the physical partitions of the logical volume should be allocated.

Range of Physical Volumes

The *Inter-Physical Volume Allocation Policy* specifies which strategy should be used for choosing physical devices to allocate the physical partitions of a logical volume. The choices are the minimum and maximum options.

Maximum Inter-Disk Policy (Range=maximum) with a Single Logical Volume Copy per Disk (Strict=y)

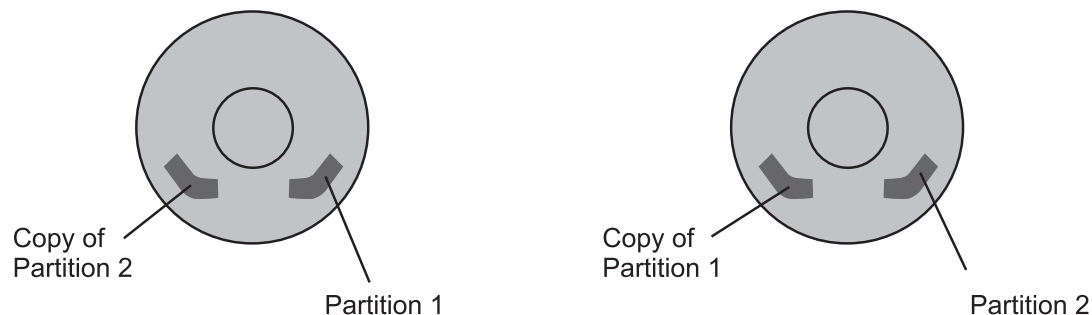

Figure 18. Inter-Physical Volume Allocation Policy. This illustration shows 2 physical volumes. One contains partition 1 and a copy of partition 2. The other contains partition 2 with a copy of partition 1. The formula for allocation is Maximum Inter-Disk Policy (Range=maximum) with a Single Logical Volume Copy per Disk (Strict=y).

The minimum option indicates the number of physical volumes used to allocate the required physical partitions. This is generally the policy to use to provide the greatest reliability and availability, without having copies, to a logical volume. Two choices are available when using the minimum option, with copies and without, as follows:

- Without Copies: The minimum option indicates one physical volume should contain all the physical partitions of this logical volume. If the allocation program must use two or more physical volumes, it uses the minimum number possible, remaining consistent with the other parameters.

- **With Copies:** The minimum option indicates that as many physical volumes as there are copies should be used. If the allocation program must use two or more physical volumes, the minimum number of physical volumes possible are used to hold all the physical partitions. At all times, the constraints imposed by other parameters such as the strict option are observed.

These definitions are applicable when extending or copying an existing logical volume. The existing allocation is counted to determine the number of physical volumes to use in the minimum with copies case, for example.

The maximum option indicates the number of physical volumes used to allocate the required physical partitions. The maximum option intends, considering other constraints, to spread the physical partitions of this logical volume over as many physical volumes as possible. This is a performance-oriented option and should be used with copies to improve availability. If an uncopied logical volume is spread across multiple physical volumes, the loss of any physical volume containing a physical partition from that logical volume is enough to cause the logical volume to be incomplete.

Maximum Number of Physical Volumes to Use for Allocation

Sets the maximum number of physical volumes for new allocation. The value should be between one and the total number of physical volumes in the volume group. This option relates to Range of Physical Volumes.

Mirror Write Consistency

The LVM always ensures data consistency among mirrored copies of a logical volume during normal I/O processing. For every write to a logical volume, the LVM generates a write request for every mirror copy. A problem arises if the system crashes in the middle of processing a mirrored write (before all copies are written). If mirror write consistency recovery is requested for a logical volume, the LVM keeps additional information to allow recovery of these inconsistent mirrors. Mirror write consistency recovery should be performed for most mirrored logical volumes. Logical volumes, such as the page space that do not use the existing data when the volume group is re-varied on, do not need this protection.

The Mirror Write Consistency (MWC) record consists of one sector. It identifies which logical partitions may be inconsistent if the system is not shut down correctly. When the volume group is varied back on-line, this information is used to make the logical partitions consistent again.

Note: With Mirror Write Consistency LVs, because the MWC control sector is on the edge of the disk, performance may be improved if the mirrored logical volume is also on the edge.

Beginning in AIX 5, a mirror write consistency option called Passive Mirror Write Consistency (MWC) is available. The default mechanism for ensuring mirror write consistency is Active MWC. Active MWC provides fast recovery at reboot time after a crash has occurred. However, this benefit comes at the expense of write performance degradation, particularly in the case of random writes. Disabling Active MWC eliminates this write-performance penalty, but upon reboot after a crash you must use the **syncvg -f** command to manually synchronize the entire volume group before users can access the volume group. To achieve this, automatic vary-on of volume groups must be disabled.

Enabling Passive MWC not only eliminates the write-performance penalty associated with Active MWC, but logical volumes will be automatically resynchronized as the partitions are being accessed. This means that the administrator does not have to synchronize logical volumes manually or disable automatic vary-on. The disadvantage of Passive MWC is that slower read operations may occur until all the partitions have been resynchronized.

You can select either mirror write consistency option within SMIT when creating or changing a logical volume. The selection option takes effect only when the logical volume is mirrored (copies > 1).

Allocate Each Logical Partition Copy on a Separate PV

Specifies whether to follow the strict allocation policy. Strict allocation policy allocates each copy of a logical partition on a separate physical volume. This option relates to Range of Physical Volumes.

Relocate the Logical Volume During Reorganization?

Specifies whether to allow the relocation of the logical volume during reorganization. For striped logical volumes, the relocate parameter must be set to no (the default for striped logical volumes). Depending on your installation you may want to relocate your logical volume.

Scheduling Policy for Reading/Writing Logical Partition Copies

Different scheduling policies can be set for the logical volume. Different types of scheduling policies are used for logical volumes with multiple copies, as follows:

- The *parallel* policy balances reads between the disks. On each read, the system checks whether the primary is busy. If it is not busy, the read is initiated on the primary. If the primary is busy, the system checks the secondary. If it is not busy, the read is initiated on the secondary. If the secondary is busy, the read is initiated on the copy with the least number of outstanding I/Os. Writes are initiated concurrently.
- The *parallel/sequential* policy always initiates reads on the primary copy. Writes are initiated concurrently.
- The *parallel/round robin* policy is similar to the parallel policy except that instead of always checking the primary copy first, it alternates between the copies. This results in equal utilization for reads even when there is never more than one I/O outstanding at a time. Writes are initiated concurrently.
- The *sequential* policy results in all reads being issued to the primary copy. Writes happen serially, first to the primary disk; only when that is completed is the second write initiated to the secondary disk.

For data that has only one physical copy, the logical volume device driver translates a logical read or write request address into a physical address and calls the appropriate physical device driver to service the request. This single-copy policy handles Bad Block Relocation for write requests and returns all read errors to the calling process.

Mirroring-scheduling policies, such as parallel and parallel/round-robin, can allow performance on read-intensive mirrored configurations to be equivalent to non-mirrored ones. Typically, performance on write-intensive mirrored configurations is less than non-mirrored, unless more disks are used.

Enable Write Verify

Specifies whether to verify all writes to the logical volume with a follow-up read. Setting this to *On* has an impact on performance.

Striping Size

When defining a striped logical volume, at least two physical drives are required. Stripe size can be any power of 2 from 4 KB to 128 KB. The size of the logical volume in partitions must be an integral multiple of the number of disk drives used. See Tuning Logical Volume Striping for a detailed discussion.

LVM performance tuning with the `lvmo` command

You can use the `lvmo` command to manage the number of LVM pbufs on a per volume group basis.

The tunable parameters for the `lvmo` command are the following:

`pv_pbuf_count`

The number of pbufs that will be added when a physical volume is added to the volume group.

max_vg_pbuf_count

The maximum number of pbufs that can be allocated for the volume group. For this value to take effect, the volume group must be varied off and varied on again.

global_pbuf_count

The minimum number of pbufs that will be added when a physical volume is added to any volume group. To change this value, use the **ioo** command.

The **lvmo -a** command displays the current values for the tunable parameters in the rootvg volume group. The following is an example:

```
# lvmo -a

vgname = rootvg
pv_pbuf_count = 256
total_vg_pbufs = 768
max_vg_pbuf_count = 8192
pervg_blocked_io_count = 0
global_pbuf_count = 256
global_blocked_io_count = 20
```

If you want to display the current values for another volume group, use the following command:

```
lvmo -v <vg_name> -a
```

To set the value for a tunable with the **lvmo** command, use the equal sign, as in the following example:

```
# lvmo -v redvg -o pv_pbuf_count=257

vgname = redvg
pv_pbuf_count = 257
total_vg_pbufs = 257
max_vg_pbuf_count = 263168
pervg_blocked_io_count = 0
global_pbuf_count = 256
global_blocked_io_count = 20
```

In the above example, the **pv_pbuf_count** tunable is set to 257 in the redvg volume group.

Note: If you increase the pbuf value too much, you might see a degradation in performance or unexpected system behavior.

For more options and information about the **lvmo** command, see *lvmo Command* in *AIX 5L Version 5.3 Commands Reference, Volume 3*.

Physical Volume Considerations

The major performance issue for disk drives is application-related; that is, whether large numbers of small accesses will be made (random), or smaller numbers of large accesses (sequential). For random access, performance will generally be better using larger numbers of smaller capacity drives. The opposite situation exists for sequential access (use faster drives or use striping with larger number of drives).

Volume Group Recommendations

If possible, for easier system management and better performance, the default volume group, rootvg, should consist of only the physical volume on which the operating system is initially installed. Maintaining only operating systems in the rootvg is a good decision because operating system updates, reinstallations, and crash recovery can be accomplished without endangering user data. Updates and reinstallations can be done more quickly because only the operating system is included in the changes.

One or more other volume groups should be defined for the other physical volumes that hold the user data. Having user data in alternate volume groups allows easier exporting of that data to other systems.

Place a highly active file system on one disk and the log for that file system on another if the activity would generate a lot of log transactions (see Reorganizing JFS Log and Log Logical Volumes). Cached devices (such as solid-state disks, SSA with Fast Write Cache, or disk arrays with write-cache) can provide for much better performance for log logical volumes (JFS log or database logs).

Performance Impacts of Mirroring rootvg

Although mirroring is common for customer data, particularly in database environments, it is used less frequently for system volumes.

In mirroring, when a write occurs, it must occur to all logical volume copies. Typically, this write will take longer than if the logical volume was not mirrored. Mirroring can also cause additional CPU overhead, because two disk I/Os take more instructions to complete than one. It is important to understand the layout of the rootvg logical volumes so one can guess where problems might exist when mirroring the rootvg logical volumes.

Looking at logical volumes typically found in rootvg, we expect most of the files in */*, including the heavily used **/usr/bin** where many executable programs reside, to be read-mostly data. The paging space should have writes only if the amount of physical memory in the system is insufficient to hold the current level of activity. It is common for systems to page from time to time, but sustained heavy paging usually leads to poor response time. The addition of physical memory generally resolves this issue.

The **/tmp** and **/var** file systems do see file-write activity for many types of applications. Applications, such as the compiler, often create and write temporary files in the **/tmp** directory. The **/var** directory receives files destined for mail and printer queues. The **jfslog** is essentially write-only during normal operation. Of the remaining file systems, perhaps only the **/home** directory is active during normal operation. Frequently, user home directories are placed in other file systems, which simplifies rootvg management.

The rootvg can be mirrored by mirroring each logical volume in rootvg with the **mklvcopy** command; or in AIX 4.2.1 and later, rootvg can be mirrored using the **mirrorvg** command.

By default, the **mirrorvg** command uses the parallel scheduling policy and leaves write-verify off for all logical volumes. It does not enable mirror-write consistency for page space. It does enable mirror-write consistency for all other logical volumes. Place logical volumes that are written to frequently close to the outer edge of the disk to minimize seek distance between the logical volume and the mirror-write consistency cache.

The caveat to mirroring rootvg not significantly affecting performance is that, if paging space is mirrored, the slowdown is directly related to paging rate. So systems that are configured to support very high paging rates, with paging spaces on rootvg, might not want to implement rootvg mirroring.

In summary, mirrored rootvg might be worth considering if your workload does not have high sustained paging rates.

Reorganizing Logical Volumes

If you find that a volume was sufficiently fragmented to require reorganization, you can use the **reorgvg** command (or **smitty reorgvg**) to reorganize a logical volume and make it adhere to the stated policies. This command will reorganize the placement of physical partitions within the volume group according to the logical volume characteristics. If logical volume names are specified with the command, highest priority is given to the first logical volume in the list. To use this command, the volume group must be varied on and have free partitions. The relocatable flag of each logical volume must be set to yes for the reorganization to take place, otherwise the logical volume is ignored.

By knowing the usage pattern of logical volumes, you can make better decisions governing the policies to set for each volume. Guidelines are:

- Allocate hot LVs to different PVs.
- Spread hot LV across multiple PVs.
- Place hottest LVs in center of PVs, except for LVs that have Mirror Write Consistency Check turned on.
- Place coldest LVs on Edges of PVs (except when accessed sequentially).
- Make LV contiguous.
- Define LV to maximum size that you will need.
- Place frequently used logical volumes close together.
- Place sequential files on the edge.

Recommendations for Best Performance

Whenever logical volumes are configured for better performance, the availability might be impacted. Decide whether performance or availability is more critical to your environment.

Use these guidelines when configuring for highest performance with the SMIT command:

- If the system does mostly reads, then mirroring with scheduling policy set to parallel can provide for better performance since the read I/Os will be directed to the copies that are least busy. If doing writes, then mirroring will cause a performance penalty because there will be multiple copies to write as well as the Mirror Write Consistency record to update. You may also want to set the allocation policy to Strict to have each copy on a separate physical volume.
- Set the write verify policy to No and, if the number of copies is greater than one, set the Mirror Write Consistency to Off.
- In general, the most frequently accessed logical volumes should be in the center in order to minimize seek distances; however, there are some exceptions:
 - Disks hold more data per track on the edges of the disk. Logical volumes being accessed in sequential manner could be placed on the edge for better performance.
 - Another exception is for logical volumes that have Mirror Write Consistency Check (MWCC) turned on. Because the MWCC sector is on the edge of the disk, performance may be improved if the mirrored logical volume is also on the edge.
- Logical volumes that will be accessed frequently or concurrently should be placed close together on the disk. Locality of reference is more important than placing them in the center.
- Put moderately used logical volumes in the middle, and put seldom-used logical volumes on the edge.
- By setting the Inter-Physical Volume Allocation Policy to maximum, you also ensure that the reads and writes are shared among PVs.

Recommendations for Highest Availability

To configure the system for highest availability (with the SMIT command), follow these guidelines:

- Use three LP copies (mirroring twice)
- Set write verify to Yes
- Set the inter policy to Minimum (mirroring copies = # of PVs)
- Set the scheduling policy to Sequential
- Set the allocation policy to Strict (no mirroring on the same PV)
- Include at least three physical volumes in a volume group
- Mirror the copies on physical volumes attached to separate buses, adapters, and power supplies

Having at least three physical volumes allows a quorum to be maintained in the event one physical volume becomes unavailable. Using separate busses, adapters, and power allows the use of copies not attached to the failing device.

Tuning Logical Volume Striping

Striping is a technique for spreading the data in a logical volume across several disk drives in such a way that the I/O capacity of the disk drives can be used in parallel to access data on the logical volume. The primary objective of striping is very high-performance reading and writing of large sequential files, but there are also benefits for random access. The following illustration gives a simple example.

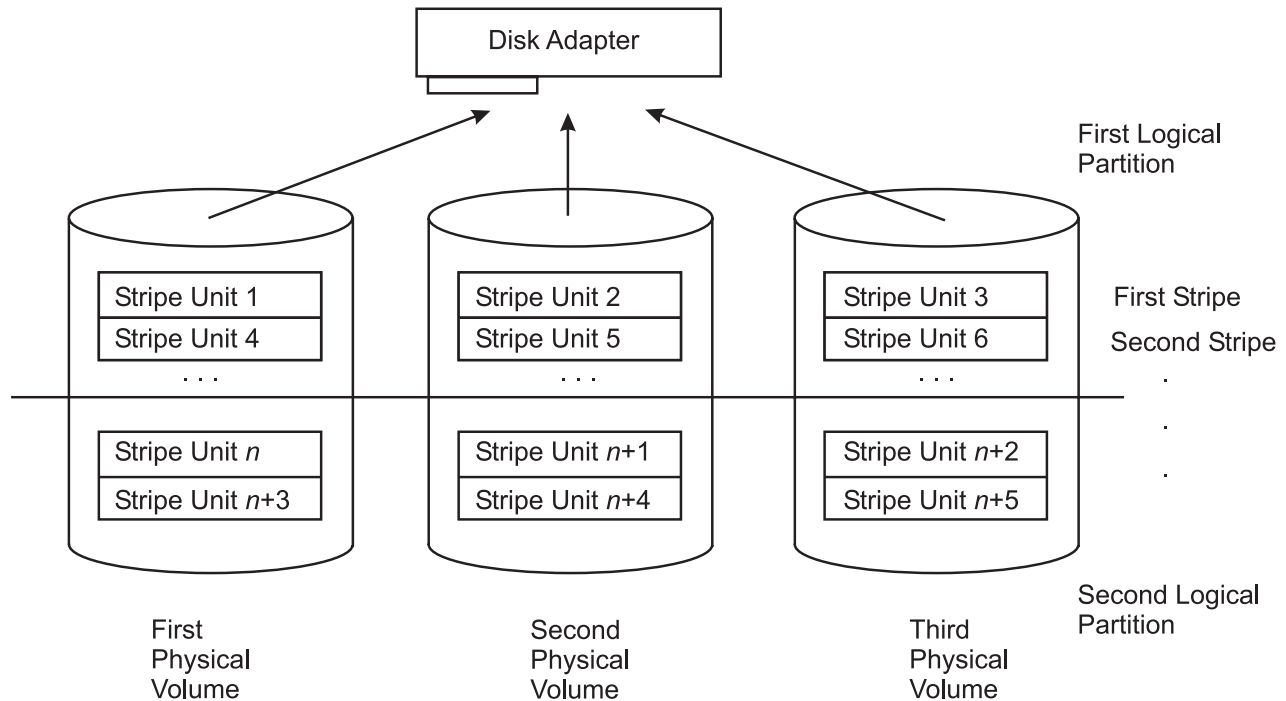

Figure 19. Striped Logical Volume /dev/lvs0. This illustration shows three physical volumes or drives. Each physical drive is partitioned into two logical volumes. The first partition, or logical volume, of drive 1 contains stripe unit 1 and 4. Partition 1 of drive 2 contains stripe unit 2 and 5 and partition 1 of drive 3 contains stripe unit 3 and 6. The second partition of drive one contains stripe unit n and n+3. The second partition of drive 2 contains stripe unit n+1 and n+4. Partition 2 of drive 3 contains stripe unit n+2 and n+5.

In an ordinary logical volume, the data addresses correspond to the sequence of blocks in the underlying physical partitions. In a striped logical volume, the data addresses follow the sequence of stripe units. A complete stripe consists of one stripe unit on each of the physical devices that contains part of the striped logical volume. The LVM determines which physical blocks on which physical drives correspond to a block being read or written. If more than one drive is involved, the necessary I/O operations are scheduled for all drives simultaneously.

As an example, a hypothetical lvs0 has a stripe-unit size of 64 KB, consists of six 2 MB partitions, and contains a journaled file system (JFS). If an application is reading a large sequential file and read-ahead has reached a steady state, each read will result in two or three I/Os being scheduled to each of the disk drives to read a total of eight pages (assuming that the file is on consecutive blocks in the logical volume). The read operations are performed in the order determined by the disk device driver. The requested data is assembled from the various pieces of input and returned to the application.

Although each disk device will have a different initial latency, depending on where its accessor was at the beginning of the operation, after the process reaches a steady state, all three disks should be reading at close to their maximum speed.

Designing a Striped Logical Volume

When a striped logical volume is defined, you specify:

drives At least two physical drives are required. The drives used should have little other activity when the performance-critical sequential I/O is taking place.

Some combinations of disk adapter and disk drive will require dividing the workload of a striped logical volume between two or more adapters.

stripe unit size

Although this can be any power of 2 from 4 KB through 128 KB, take sequential read-ahead into account, because that will be the mechanism that issues most of the reads. The objective is to have each read-ahead operation result in at least one I/O, ideally an equal number, to each disk drive (see previous figure).

size The number of physical partitions allocated to the logical volume must be an integral multiple of the number of disk drives used.

attributes

Beginning with AIX 4.3.3, striped logical volumes can be mirrored; that is, copies can now be set to more than 1.

Tuning for Striped Logical Volume I/O

Sequential and random disk I/Os benefit from disk striping. The following techniques have yielded the highest levels of sequential I/O throughput:

- Spread the logical volume across as many physical volumes as possible.
- Use as many adapters as possible for the physical volumes.
- Create a separate volume group for striped logical volumes.
- Set a stripe-unit size of 64 KB.
- Set **minpgahead** to 2, using the **ioo** command. See Sequential Read-Ahead.
- Set **maxpgahead** to 16 times the number of disk drives, using the **ioo** command. This causes page-ahead to be done in units of the stripe-unit size (64 KB) times the number of disk drives, resulting in the reading of one stripe unit from each disk drive for each read-ahead operation.
- Request I/Os for 64 KB times the number of disk drives. This is equal to the **maxpgahead** value.
- Modify **maxfree**, using the **ioo** command, to accommodate the change in **maxpgahead** (**maxfree = minfree + maxpgahead**). See Choosing minfree and maxfree Settings.
- Use 64-byte aligned I/O buffers. If the logical volume will occupy physical drives that are connected to two or more disk adapters, the I/O buffers used should be allocated on 64-byte boundaries. This avoids having the LVM serialize the I/Os to the different disks. The following code would yield a 64-byte-aligned buffer pointer:

```
char *buffer;
buffer = malloc(MAXBLKSIZE+64);
buffer = ((int)buffer + 64) & ~0x3f;
```

If the striped logical volumes are on raw logical volumes and writes larger than 1.125 MB are being done to these striped raw logical volumes, increasing the **lvm_bufcnt** parameter with the **ioo** command might increase throughput of the write activity. See Miscellaneous I/O Tuning Parameters.

The example above is for a JFS striped logical volume. The same techniques apply to enhanced JFS, except the **ioo** parameters used will be the enhanced JFS equivalents.

Also, it is not a good idea to mix striped and non-striped logical volumes in the same physical volume. All physical volumes should be the same size within a set of striped logical volumes.

Mirrored Striped Logical Volume Performance Implications

AIX 4.3.3 allows striping and mirroring together on the same logical volume. This feature provides a convenient mechanism for high-performance redundant storage. Measurements indicate that read and file system write performance of striping and mirroring is approximately equal to the unmirrored case, assuming you have twice as many disks.

File system writes benefit from caching in the file system, which allows considerable overlap of writes to disk with the program initiating the writes. The raw write performance suffers. Because it is synchronous, both writes must complete before control is returned to the initiating program. Performing larger writes increases raw write throughput. Also, Mirror Write Consistency (MWC) affects the performance of this case.

In summary, striping and mirroring allow redundant storage for very high-performance access.

Using Raw Disk I/O

Some applications, such as databases, do not require a file system because they perform functions such as logging, keeping track of data, and caching. Performance of these applications is usually better when using raw I/O rather than using file I/O because it avoids the additional work of memory copies, logging, and inode locks.

When using raw I/O, applications should use the `/dev/rlv*` character special files. The `/dev/lv*` block special files should not be used, as they break large I/Os into multiple 4K I/Os. The `/dev/rhdisk*` and `/dev/hdisk*` raw disk interfaces should not be used because they degrade performance and can also cause data consistency problems.

Using sync/fsync Calls

If a file is opened with `O_SYNC` or `O_DSYNC`, then each write will cause the data for that write to be flushed to disk before the write returns. If the write causes a new disk allocation (the file is being extended instead of overwriting an existing page), then that write will also cause a corresponding JFS log write.

Forced synchronization of the contents of real memory and disk takes place in several ways:

- An application program makes an **fsync()** call for a specified file. This causes all of the pages that contain modified data for that file to be written to disk. The writing is complete when the **fsync()** call returns to the program.
- An application program makes a **sync()** call. This causes all of the file pages in memory that contain modified data to be scheduled for writing to disk. The writing is not necessarily complete when the **sync()** call returns to the program.
- A user can enter the **sync** command, which in turn issues a **sync()** call. Again, some of the writes may not be complete when the user is prompted for input (or the next command in a shell script is processed).
- The `/usr/sbin/syncd` daemon issues a **sync()** call at regular intervals, usually every 60 seconds. This ensures that the system does not accumulate large amounts of data that exists only in volatile RAM.

A sync operation has several effects, aside from its small CPU consumption:

- It causes writes to be clumped, rather than spread out.
- It causes at least 28 KB of system data to be written, even if there has been no I/O activity since the previous **sync** operation.
- It accelerates the writing of data to disk, defeating the write-behind algorithm. This effect is significant mainly in programs that issue an **fsync()** call after every write.
- When **sync()** or **fsync()** calls occur, log records are written to the JFS log device to indicate that the modified data has been committed to disk.

Setting SCSI-Adapter and Disk-Device Queue Limits

The operating system has the ability to enforce limits on the number of I/O requests that can be outstanding from the SCSI adapter to a given SCSI bus or disk drive. These limits are intended to exploit the hardware's ability to handle multiple requests while ensuring that the seek-optimization algorithms in the device drivers are able to operate effectively.

For non-IBM devices, it is sometimes appropriate to modify the default queue-limit values that have been chosen to handle the worst possible case. The following sections describe situations in which the defaults should be changed and the recommended new values.

Non-IBM Disk Drive

For IBM disk drives, the default number of requests that can be outstanding at any given time is 3 (8 for SSA). This value is based on complex performance considerations, and no direct interface is provided for changing it. The default hardware queue depth for non-IBM disk drives is 1. If a specific non-IBM disk drive does have the ability to buffer multiple requests, the system's description of that device should be changed accordingly.

As an example, the default characteristics of a non-IBM disk drive are displayed with the **lsattr** command, as follows:

```
# lsattr -D -c disk -s scsi -t osdisk
pvid          none Physical volume identifier      False
clr_q         no   Device CLEARS its Queue on error
q_err        yes  Use QERR bit
q_type       none  Queuing TYPE
queue_depth   1   Queue DEPTH
reassign_to  120  REASSIGN time out value
rw_timeout    30  READ/WRITE time out value
start_timeout 60  START unit time out value
```

You can use SMIT (the fast path is **smitty chgdisk**) or the **chdev** command to change these parameters. For example, if your system contained a non-IBM SCSI disk drive `hdisk5`, the following command enables queuing for that device and sets its queue depth to 3:

```
# chdev -l hdisk5 -a q_type=simple -a queue_depth=3
```

Non-IBM Disk Array

A disk array appears to the operating system as a single, rather large, disk drive. A non-IBM disk array, like a non-IBM disk drive, is of class `disk`, subclass `SCSI`, type `osdisk` (which stands for "Other SCSI Disk Drive"). Because a disk array actually contains a number of physical disk drives, each of which can handle multiple requests, the queue depth for the disk array device has to be set to a value high enough to allow efficient use of all of the physical devices. For example, if `hdisk7` were an eight-disk non-IBM disk array, an appropriate change would be as follows:

```
# chdev -l hdisk7 -a q_type=simple -a queue_depth=24
```

If the disk array is attached through a SCSI-2 Fast/Wide SCSI adapter bus, it may also be necessary to change the outstanding-request limit for that bus.

Expanding the Configuration

Unfortunately, every performance-tuning effort ultimately does reach a point of diminishing returns. The question then becomes, "What hardware do I need, how much of it, and how do I make the best use of it?" That question is especially tricky with disk-limited workloads because of the large number of variables. Changes that might improve the performance of a disk-limited workload include:

- Adding disk drives and spreading the existing data across them. This divides the I/O load among more accessors.

- Acquiring faster disk drives to supplement or replace existing ones for high-usage data.
- Adding one or more disk adapters to attach the current and new disk drives.
- Adding RAM to the system and increasing the VMM's **minperm** and **maxperm** parameters to improve the in-memory caching of high-usage data.

For guidance more closely focused on your configuration and workload, you can use a measurement-driven simulator, such as BEST/1.

Using RAID

Redundant Array of Independent Disks (RAID) is a term used to describe the technique of improving data availability through the use of arrays of disks and various data-striping methodologies. Disk arrays are groups of disk drives that work together to achieve higher data-transfer and I/O rates than those provided by single large drives. An array is a set of multiple disk drives plus a specialized controller (an array controller) that keeps track of how data is distributed across the drives. Data for a particular file is written in segments to the different drives in the array rather than being written to a single drive.

Arrays can also provide data redundancy so that no data is lost if a single drive (physical disk) in the array should fail. Depending on the RAID level, data is either mirrored or striped.

Subarrays are contained within an array subsystem. Depending on how you configure it, an array subsystem can contain one or more sub-arrays, also referred to as Logical Units (LUN). Each LUN has its own characteristics (RAID level, logical block size and logical unit size, for example). From the operating system, each subarray is seen as a single hdisk with its own unique name.

RAID algorithms can be implemented as part of the operating system's file system software, or as part of a disk device driver (common for RAID 0 and RAID 1). These algorithms can be performed by a locally embedded processor on a hardware RAID adapter. Hardware RAID adapters generally provide better performance than software RAID because embedded processors offload the main system processor by performing the complex algorithms, sometimes employing specialized circuitry for data transfer and manipulation.

LVM

AIX LVM supports the following RAID options:

| | |
|----------------|------------------------|
| RAID 0 | Striping |
| RAID 1 | Mirroring |
| RAID 10 or 0+1 | Mirroring and striping |

RAID Levels and Their Performance Implications

Each of the RAID levels supported by disk arrays uses a different method of writing data and hence provides different benefits.

RAID 0 - For Performance

RAID 0 is also known as *data striping*. It is well-suited for program libraries requiring rapid loading of large tables, or more generally, applications requiring fast access to read-only data, or fast writing. RAID 0 is only designed to increase performance; there is no redundancy, so any disk failures require reloading from backups. Select RAID Level 0 for applications that would benefit from the increased performance capabilities of this RAID Level. Never use this level for critical applications that require high availability.

RAID 1 - For Availability/Good Read Response Time

RAID 1 is also known as *disk mirroring*. It is most suited to applications that require high data availability, good read response times, and where cost is a secondary issue. The response time for writes can be

somewhat slower than for a single disk, depending on the write policy; the writes can either be executed in parallel for speed or serially for safety. Select RAID Level 1 for applications with a high percentage of read operations and where the cost is not the major concern.

RAID 2 - Rarely Used

RAID 2 is rarely used. It implements the same process as RAID 3, but can utilize multiple disk drives for parity, while RAID 3 can use only one.

RAID 3 - For CAD/CAM, Sequential Access to Large Files

RAID 3 and RAID 2 are parallel process array mechanisms, where all drives in the array operate in unison. Similar to data striping, information to be written to disk is split into chunks (a fixed amount of data), and each chunk is written out to the same physical position on separate disks (in parallel). More advanced versions of RAID 2 and 3 synchronize the disk spindles so that the reads and writes can truly occur simultaneously (minimizing rotational latency buildups between disks). This architecture requires parity information to be written for each stripe of data; the difference between RAID 2 and RAID 3 is that RAID 2 can utilize multiple disk drives for parity, while RAID 3 can use only one. The LVM does not support RAID 3; therefore, a RAID 3 array must be used as a raw device from the host system.

Performance is very good for large amounts of data but poor for small requests because every drive is always involved, and there can be no overlapped or independent operation. It is well-suited for large data objects such as CAD/CAM or image files, or applications requiring sequential access to large data files. Select RAID 3 for applications that process large blocks of data. RAID 3 provides redundancy without the high overhead incurred by mirroring in RAID 1.

RAID 4 - Less Used (Parity Volume Bottleneck)

RAID 4 addresses some of the disadvantages of RAID 3 by using larger chunks of data and striping the data across all of the drives except the one reserved for parity. Write requests require a read/modify/update cycle that creates a bottleneck at the single parity drive. Therefore, RAID 4 is not used as often as RAID 5, which implements the same process, but without the parity volume bottleneck.

RAID 5 - High Availability and Fewer Writes Than Reads

RAID 5, as has been mentioned, is very similar to RAID 4. The difference is that the parity information is distributed across the same disks used for the data, thereby eliminating the bottleneck. Parity data is never stored on the same drive as the chunks that it protects. This means that concurrent read and write operations can now be performed, and there are performance increases due to the availability of an extra disk (the disk previously used for parity). There are other enhancements possible to further increase data transfer rates, such as caching simultaneous reads from the disks and transferring that information while reading the next blocks. This can generate data transfer rates at up to the adapter speed.

RAID 5 is best used in environments requiring high availability and fewer writes than reads. Select RAID level 5 for applications that manipulate small amounts of data, such as transaction processing applications.

RAID 6 - Seldom Used

RAID 6 is similar to RAID 5, but with additional parity information written that permits data recovery if two disk drives fail. Extra parity disk drives are required, and write performance is slower than a similar implementation of RAID 5.

RAID 7 - A Definition of 3rd Parties

The RAID 7 architecture gives data and parity the same privileges. The level 7 implementation allows each individual drive to access data as fast as possible. This is achieved by three features:

- Independent control and data paths for each I/O device/interface.
- Each device/interface is connected to a high-speed data bus that has a central cache capable of supporting multiple host I/O paths.

- A real time, process-oriented operating system is embedded into the disk drive array architecture. The embedded operating system "frees" the drives by allowing each drive head to move independently of the other disk drives. Also, the RAID 7 embedded operating system is enabled to handle a heterogeneous mix of disk drive types and sizes.

RAID 10 - RAID-0+1

RAID-0+1, also known in the industry as RAID 10, implements block interleave data striping and mirroring. RAID 10 is not formally recognized by the RAID Advisory Board (RAB), but, it is an industry standard term. In RAID 10, data is striped across multiple disk drives, and then those drives are mirrored to another set of drives.

The performance of RAID 10 is approximately the same as RAID 0 for sequential I/Os. RAID 10 provides an enhanced feature for disk mirroring that stripes data and copies the data across all the drives of the array. The first stripe is the data stripe; the second stripe is the mirror (copy) of the first data stripe, but it is shifted over one drive. Because the data is mirrored, the capacity of the logical drive is 50 percent of the physical capacity of the hard disk drives in the array.

Summary of RAID Levels

The advantages and disadvantages of the different RAID levels are summarized in the following table:

| RAID Level | Availability | Capacity | Performance | Cost |
|------------|--------------|--------------------------|-------------|--------|
| 0 | none | 100 percent | high | low |
| 1 | mirroring | 50 percent | medium/high | high |
| 2/3 | parity | varies between 50 - 100% | medium | medium |
| 4/5/6/7 | parity | varies between 50 - 100% | medium | medium |
| 10 | mirroring | 50 percent | high | high |

RAID Performance Summary

The most common RAID implementations are: 0, 1, 3 and 5. Levels 2, 4 and 6 have problems with performance and are functionally not better than the other ones. In most cases, RAID 5 is used instead of RAID 3 because of the bottleneck when using only one disk for parity.

RAID 0 and RAID 1 can be implemented with software support only. RAID 3, 5 and 7 require both hardware and software support (special RAID adapters or RAID array controllers).

For further information, see *Configuring and Implementing the IBM Fibre Channel RAID Storage Server*.

Using SSA

Serial Storage Architecture (SSA) is a high performance, serial interconnect technology used to connect disk devices and host adapters. SSA subsystems are built up of loops of adapters and disks. SSA is a serial link designed especially for low-cost, high-performance connection to disk drives. It is a two-signal connection (transmit and receive) providing full duplex communication. It uses a self-clocking code, which means that the data clock is recovered from the data signal itself rather than being transmitted as a separate signal.

Guidelines for Improving SSA Performance

Examine these guidelines in terms of your situation:

- Limit the number of disks per adapter so that the adapter is not flooded. With high throughputs using large block sizes, five to six disks can flood the adapter.

- Mirror across different adapters.
- The performance will be affected by the location of the logical volume on the disk. A contiguous, unfragmented partition in a logical volume will enhance performance.
- You can turn off mirror write consistency cache for logical volume mirroring, but doing so removes the guarantee of consistency of data in case of a crash. In this case, you would have to recopy all logical volumes to make sure they are consistent. However, the removal does provide a 20 percent plus enhancement in performance.
- For mirrored environments, make sure you are using the parallel scheduling policy.
- If any of the logical volume exists on more than one disk, stagger the partitions over the disks. This is automatically accomplished when the logical volume is created with the inter policy set to Maximum.
- Balance the I/Os across the loop; do not place all the workload on one half of the loop.
- In a multi-initiator environment, place the disks adjacent to the adapter that is using them.

For further information, see *Monitoring and Managing IBM SSA Disk Subsystems* and *A Practical Guide to Serial Storage Architecture for AIX*.

Additional information about IBM storage solutions can be found in *IBM Storage Solutions for e-business* and *Introduction to Storage Area Network*.

Using Fast Write Cache

Fast write cache (FWC) is an optional nonvolatile cache that provides redundancy with the standard adapter cache. The FWC tracks writes that have not been committed to disk.

FWC can significantly improve the response time for write operations. However, care must be taken not to flood the cache with write requests faster than the rate at which the cache can destage its data. It can also adversely affect the maximum I/O rate because additional processing is required in the adapter card to determine if the data that is being transferred is in the cache.

Fast write cache typically provides significant advantages in specialized workloads, for example, copying a database onto a new set of disks. If the fast write cache is spread over multiple adapters, this can multiply the benefit.

The FWC can also reduce JFS log bottlenecks because of three properties of the JFS log, as follows:

1. The JFS log is write-intensive. The FWC does not cache unmodified data.
2. The writes are small and frequent. Because the cache capacity is not enormous, it works best for high-rate small I/Os that are gathered together in the adapter into larger physical I/Os. Larger I/Os tend to have better performance because less disk rotations are normally needed to write the data.
3. Logs are not typically very large relative to the cache size, so the log does not tend to "wash" the cache frequently. Therefore, the log loses the benefit of rewriting over existing cached data. Although other array controllers with write caches have proven effective with logs, this article only discusses log performance with the FWC.

When single disk bandwidth becomes the limiting performance factor, one solution is to stripe several RAID 5 devices into a logical volume in conjunction with the FWC option of the SSA adapter. When the adapter is configured for RAID 5, writes equal to or larger than the stripe size bypass the cache. That is why 128 KB writes to a 2+p array with FWC are slower than 127 KB writes, and are equal to 128 KB writes to 2+p without the FWC. This is intended to keep bulk sequential I/O from "washing" the cache. The stripe size is 64 KB times the number of data disks in the RAID 5.

Chapter 13. File system performance

This topic focuses on file system tuning. File system configuration has a large effect on overall system performance and is time consuming to change after installation.

The file system performance topic focuses on the following sections :

- File system overview
- Potential performance inhibitors for JFS and enhanced JFS
- File system performance enhancements
- Disk I/O pacing
- File system attributes that affect performance
- Reorganization of file systems
- File system performance tuning
- Reorganizing JFS log and log logical volumes
- Summary of file system tunable parameters

File system overview

This section provides an overview of the supported file systems in AIX and contains the following information:

- File system types
- Main differences between JFS and Enhanced JFS
- Miscellaneous differences between JFS and Enhanced JFS
- Summary of differences between JFS and Enhanced JFS

To review basic information about file systems, see *AIX 5L Version 5.3 System Management Concepts: Operating System and Devices*.

File system types

This section discusses the various file systems supported in AIX. There are two different classifications of file systems:

- “Local file systems”
- “Remote file systems” on page 194

Local file systems

The following file systems are classified as local file systems:

- Journaled File System
- Enhanced Journaled File System
- CD ROM file system
- File system on RAM disk

Journaled File System: Journaled File System, or JFS, is the default file system for AIX when running on a 32-bit kernel. A journaling file system allows for quick file system recovery after a crash occurs by logging the metadata of files. By enabling file system logging, the system records every change in the metadata of the file into a reserved area of the file system. The actual write operations are performed after the logging of changes to the metadata has been completed.

Enhanced Journal File System: Enhanced JFS, or JFS2, is another native AIX journaling file system that was introduced in AIX 5.1. Enhanced JFS is the default file system for 64-bit kernel environments. Due to address space limitations of the 32-bit kernel, Enhanced JFS is not recommended for use in 32-bit kernel environments.

CD ROM file system: A CD ROM file system is a read-only file system that is stored on CD ROM media. AIX supports several types of CD-ROM file systems as described in the File System Types section in *AIX 5L Version 5.3 System Management Concepts: Operating System and Devices*.

RAM File System: A RAM disk is a simulated disk drive that resides in memory. RAM disks are designed to have significantly higher I/O performance than physical drives, and are typically used to overcome I/O bottlenecks with nonpersistent files. The maximum size of a RAM file system is limited by the amount of available system memory. You can create a file system on the RAM disk device to make it available for normal file system usage. Do not use RAM disks for persistent data, as all data is lost if the system crashes or reboots.

Remote file systems

The following file systems are classified as remote file systems:

- Network File System
- General Parallel File System

Network File System: The Network File System, or NFS, is a distributed file system that allows you to access files and directories located on remote computers and treat those files and directories as if they were local. For example, you can use operating system commands to create, remove, read, write, and set file attributes for remote files and directories.

Performance tuning and other issues regarding NFS are found in the NFS performance topic.

General Parallel File System (GPFS): The General Parallel File System, or GPFS, is a high-performance, shared-disk file system that can provide fast data access to all nodes in a server cluster. Parallel and serial applications access files using standard UNIX file system interfaces, such as those in AIX.

GPFS provides high performance by striping I/O across multiple disks, high availability through logging, replication, and both server and disk failover.

For more information, see the IBM Redbook entitled *GPFS on AIX Clusters: High Performance File System Administration Simplified*.

Main differences between JFS and Enhanced JFS

This section discusses the following differences between JFS and Enhanced JFS:

- “Kernel address space”
- “Journaling” on page 195
- “Directory organization” on page 195
- “Scaling” on page 195

Kernel address space

AIX offers two different types of kernels, a 32-bit kernel and a 64-bit kernel. The 32-bit and 64-bit kernels have common libraries, commands, utilities, and header files. However, the 64-bit kernel offers a degree of scaling for 64-bit hardware that the 32-bit kernel cannot.

JFS is optimized for the 32-bit kernel, and will run on 32-bit and 64-bit hardware. Enhanced JFS is optimized to run on the 64-bit kernel, allowing it to take advantage of 64-bit functionality.

For a description of kernel address space issues and differences, see POWER-based-Architecture-Unique Timer Access.

Journaling

Before writing actual data, a journaling file system logs the metadata, thus incurring an overhead penalty that slows write throughput. One way of improving performance under JFS is to disable metadata logging by using the **nointegrity** mount option. Note that the enhanced performance is achieved at the expense of metadata integrity. Therefore, use this option with extreme caution because a system crash can make a file system mounted with this option unrecoverable.

In contrast to JFS, Enhanced JFS does not allow you to disable metadata logging. However, the implementation of journaling on Enhanced JFS makes it more suitable to handle metadata-intensive applications. Thus, the performance penalty is not as high under Enhanced JFS as it is under JFS.

Directory organization

An index node, or i-node, is a data structure that stores all file and directory properties. When a program looks up a file, it searches for the appropriate i-node by looking up a file name in a directory. Because these operations are performed often, the mechanism used for searching is of particular importance.

JFS employs a linear organization for its directories, thus making searches linear as well. In contrast, Enhanced JFS employs a binary tree representation for directories, thus greatly accelerating access to files.

Scaling

The main advantage of using Enhanced JFS over JFS is scaling. Enhanced JFS provides the capability to store much larger files than the existing JFS. The maximum size of a file under JFS is 64 gigabytes. Under Enhanced JFS, AIX currently supports files up to 16 terabytes in size, although the file system architecture is set up to eventually handle file sizes of up to 4 petabytes.

Another scaling issue relates to accessing a large number of files. The following illustration demonstrates how Enhanced JFS can improve performance for this type of access.

Enhanced JFS Scaling

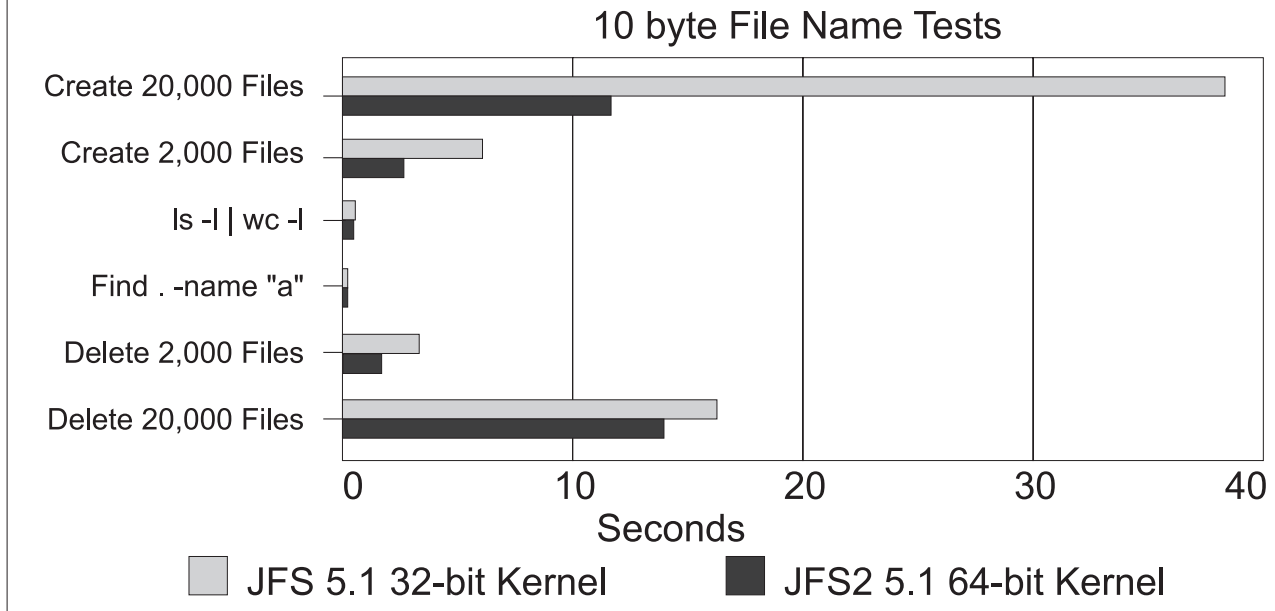

Figure 20.

The above example consists of creating, deleting, and searching directories with unique, 10-byte file names. The results show that creating and deleting files is much faster under Enhanced JFS than under JFS. Performance for searches was approximately the same for both file system types.

The example below shows how results for create, delete, and search operations are generally much faster on Enhanced JFS than on JFS when using non-unique file names. In this example, file names were chosen to have the same first 64-bytes appended by 10-byte unique names. The following illustration shows the results of this test:

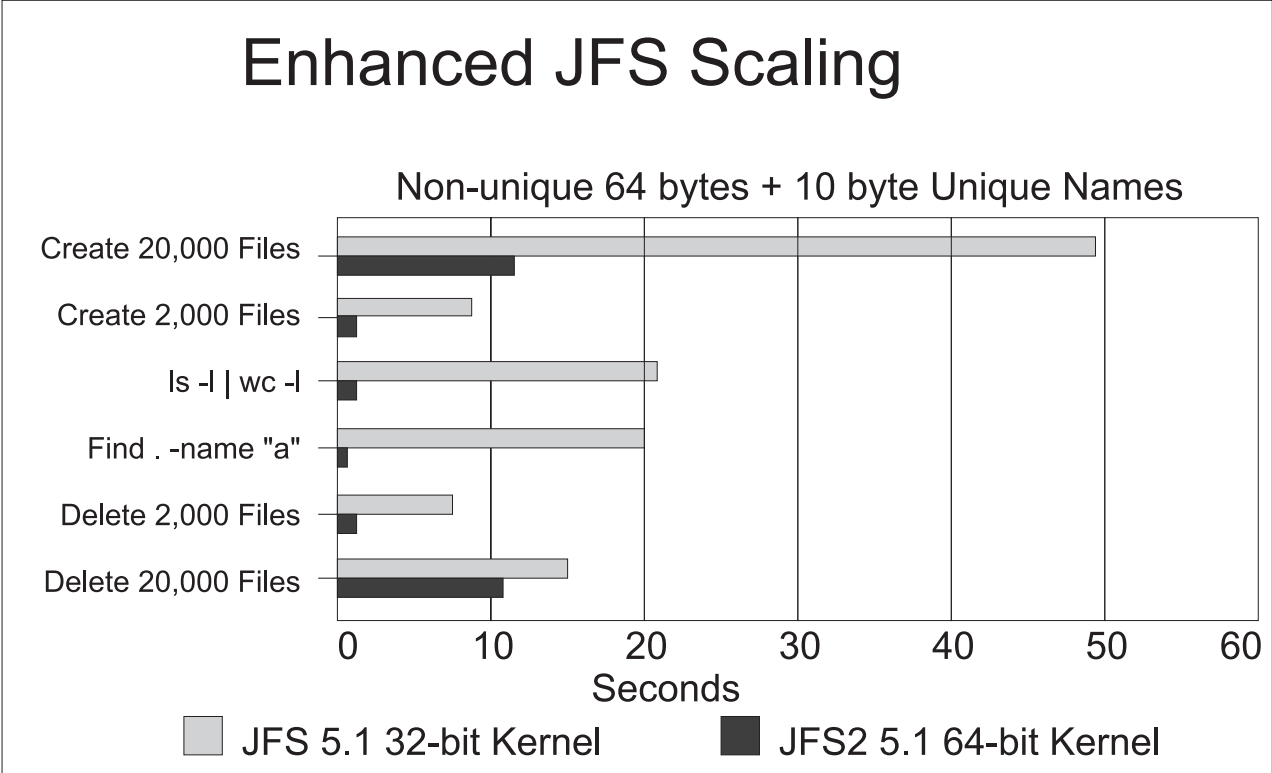

Figure 21.

On a related note, beginning with AIX 5.2, caching of long (greater than 32 characters) file names is supported in both the JFS and Enhanced JFS name caches. This improves the performance of directory operations, such as the **ls** and **find** commands, on directories with numerous long file name entries.

Miscellaneous differences between JFS and Enhanced JFS

Cloning with a system backup with **mksysb** from a 64-bit enabled JFS2 system to a 32-bit system will not be successful.

Unlike the JFS file system, the JFS2 file system will not allow the **link()** API to be used on its binary type directory. This limitation may cause some applications that operate correctly on a JFS file system to fail on a JFS2 file system.

Summary of differences between JFS and Enhanced JFS

The following table summarizes the differences between JFS and Enhanced JFS.

Table 3. Functional Differences between JFS and Enhanced JFS

| Function | JFS | Enhanced JFS |
|--------------------------|-------------------------------|--------------------------------|
| Optimization | 32-bit kernel | 64-bit kernel |
| Maximum file system size | 1 terabyte | 4 petabytes ¹ |
| Maximum file size | 64 gigabytes | 4 petabytes ¹ |
| Number of l-nodes | Fixed at file system creation | Dynamic, limited by disk space |
| Large file support | As mount option | Default |
| Online defragmentation | Yes | Yes |
| namefs | Yes | Yes |
| DMAPI | No | Yes |

Table 3. Functional Differences between JFS and Enhanced JFS (continued)

| Function | JFS | Enhanced JFS |
|--------------------|-----|--------------|
| Compression | Yes | No |
| Quotas | Yes | Yes |
| Deferred update | Yes | No |
| Direct I/O support | Yes | Yes |

Note: 1. This is an architectural limit. AIX currently only supports up to 16 terabytes.

Potential performance inhibitors for JFS and Enhanced JFS

This section discusses the following situations that can potentially inhibit JFS and Enhanced JFS performance:

- “Effects of file system logging on file system throughput”
- “Compression and fragmentation”

Effects of file system logging on file system throughput

Because write operations are performed after logging of metadata has been completed, write throughput can be affected. For a description of how to avoid performance penalties associated with logging, see Logical volume and Disk I/O performance.

Compression and fragmentation

The Journaled File System supports fragmented and compressed file systems as a means of saving disk space. On average, data compression saves disk space by about a factor of two. However, the fragmentation and compression might incur a performance loss associated with increased allocation activity. For a description of how compression and fragmentation might affect performance, see Logical volume and disk I/O performance.

To enhance performance, both JFS and Enhanced JFS allow for online defragmentation. The file system can be mounted and is accessible while the defragmentation process is underway.

File system performance enhancements

This section discusses the following policies and mechanisms that you can use to enhance file system performance under AIX:

- “Sequential page read ahead”
- “Sequential and random write behind” on page 199
- “Memory mapped files and write behind” on page 199
- “The release-behind mechanism” on page 200
- “Delayed write operations” on page 200
- “Direct I/O support” on page 200
- “Concurrent I/O support” on page 201

Sequential page read ahead

The VMM anticipates the future need for pages of a file by observing the pattern in which a program accesses the file. When the program accesses two successive pages of the file, the VMM assumes that the program will continue to access the file sequentially, and the VMM schedules additional sequential

reads of the file. These reads are overlapped with the program processing, and will make the data available to the program sooner than if the VMM had waited for the program to access the next page before initiating the I/O.

For JFS, the number of pages to be read ahead is determined by the following VMM thresholds:

minpgahead

Number of pages read ahead when the VMM first detects the sequential access pattern.

If the program continues to access the file sequentially, the next read ahead occurs after the program accesses 2 * **minpgahead** pages, the next after 4 * **minpgahead** pages, and so on until the number of pages reaches **maxpgahead**.

maxpgahead

Maximum number of pages the VMM will read ahead in a file.

For Enhanced JFS, the number of pages to be read ahead is determined by the following VMM thresholds:

j2_minPageReadAhead

Number of pages read ahead when the VMM first detects the sequential access pattern.

If the program continues to access the file sequentially, the next read ahead occurs after the program accesses 2 * **j2_minPageReadAhead** pages, the next after 4 * **j2_minPageReadAhead**, and so on until the number of pages reaches **j2_maxPageReadAhead**.

j2_maxPageReadAhead

Maximum number of pages the VMM will read ahead in a sequential file.

Sequential and random write behind

The AIX file system code logically divides each file into 16 KB clusters for JFS and 128 KB clusters for Enhanced JFS for the following reasons:

- Increase write performance
- Limit the number of dirty file pages in memory
- Reduce system overhead
- Minimize disk fragmentation

The pages of a given partition are not written to disk until the program writes the first byte of the next 16 KB partition. At that point, the file system code forces the four dirty pages of the first partition to be written to disk. The pages of data remain in memory until their frames are reused, at which point no additional I/O is required. If a program re-accesses any of the pages before their frames are reused, no I/O is required.

If a large number of dirty file pages remain in memory and do not get reused, the sync daemon writes them to disk, which might result in abnormal disk utilization. To distribute the I/O activity more evenly, you can turn on write behind to tell the system how many pages to keep in memory before writing them to disk. The write behind threshold is on a per-file basis, which causes pages to be written to disk before the sync daemon runs.

There are two types of write behind: sequential and random. The size of the write behind partitions and the write behind threshold can be changed with the **ioo** command. See Tuning Sequential and Random Write-Behind for more information.

Memory mapped files and write behind

Normal files are automatically mapped to segments to provide mapped files. This means that normal file access bypasses traditional kernel buffers and block-I/O routines, allowing files to use more memory when the extra memory is available. File caching is not limited to the declared kernel buffer area.

Files can be mapped explicitly with the **shmat()** or **mmap()** subroutines, but this provides no additional memory space for their caching. Applications that use the **shmat()** or **mmap()** subroutines to map a file explicitly and access it by address rather than by the **read()** and **write()** subroutines may avoid some path length of the system-call overhead, but they lose the benefit of the system read ahead and write behind feature.

When applications do not use the **write()** subroutine, modified pages tend to accumulate in memory and be written randomly when purged by the VMM page-replacement algorithm or the **sync** daemon. This results in many small writes to the disk that cause inefficiencies in CPU and disk utilization, as well as fragmentation that might slow future reads of the file.

The release-behind mechanism

Release-behind is a mechanism for JFS and Enhanced JFS under which pages are freed as soon as they are either committed to permanent storage by writes or delivered to an application by reads. This solution addresses a scaling problem when performing sequential I/O on very large files whose pages will not be re-accessed in the near future.

When writing a large file without using release-behind, writes will go very fast whenever there are available pages on the free list. When the number of pages drops to the value of the **minfree** parameter, VMM uses its Least Recently Used (LRU) algorithm to find candidate pages for eviction. As part of this process, VMM needs to acquire a lock that is also being used for writing. This lock contention might cause a sharp performance degradation.

You can enable release-behind by specifying either the release-behind sequential read (**rbr**) flag, the release-behind sequential write (**rbw**) flag, or the release-behind sequential read and write (**rbrw**) flag when issuing the **mount** command.

A side effect of using the release-behind mechanism is an increase in CPU utilization for the same read or write throughput rate compared to without using release-behind. This is due to the work of freeing pages, which would normally be handled at a later time by the LRU daemon. Also note that all file page accesses result in disk I/O since file data is not cached by VMM.

Starting with AIX 5.3 with 5300-03, you can use the **mount -o rbr** command to use release-behind for NFS.

Direct I/O support

Both JFS and Enhanced JFS offer support for direct I/O access to files. This access method bypasses the file cache and transfers data directly from disk into the user space buffer, as opposed to using the normal cache policy of placing pages in kernel memory. For a description on how to tune direct I/O, see Direct I/O tuning

Delayed write operations

JFS allows you to defer updates of data into permanent storage. Delayed write operations save extra disk operations for files that are often rewritten. You can enable this feature by opening the file with the deferred update flag, **O_DEFER**. This feature caches the data, allowing faster read and write operations from other processes.

When writing to files that have been opened with this flag, data is not committed to permanent storage until a process issues the **fsync** command, forcing all updated data to be committed to disk. Also, if a process issues a synchronous write operation on a file, that is, the process has opened the file with the **O_SYNC** flag, the operation is not deferred even if the file was created with the **O_DEFER** flag.

Note: This feature is not available for Enhanced JFS.

Concurrent I/O support

Enhanced JFS supports concurrent file access to files. Similar to direct I/O, this access method bypasses the file cache and transfers data directly from disk into the user space buffer. It also bypasses the inode lock which allows multiple threads to read and write to the same file concurrently.

Note: This feature is not available for JFS.

Summary of file system tunable parameters

The following table summarizes tunable parameters for JFS and Enhanced JFS file systems.

Table 4. JFS and Enhanced JFS Tunable Parameters

| Function | JFS Tuning Parameter | Enhanced JFS Tuning Parameter |
|---|---|---|
| Sets the maximum amount of memory for caching files | vmo -o maxperm=value | vmo -o maxclient=value (less than or equal to maxperm) |
| Sets the minimum amount of memory for caching files | vmo -o minperm=value | No equivalent |
| Sets a hard limit on memory for caching files | vmo -o strict_maxperm | vmo -o maxclient (always a hard limit) |
| Sets the maximum pages used for sequential read ahead | ioo -o maxpgahead=value | ioo -o j2_maxPageReadAhead=value |
| Sets the minimum pages used for sequential read ahead | ioo -o minpgahead=value | ioo -o j2_minPageReadAhead=value |
| Sets the maximum number of pending write I/Os to a file | chdev -l sys0 -a maxpout maxpout | chdev -l sys0 -a maxpout maxpout |
| Sets the minimum number of pending write I/Os to a file at which programs blocked by maxpout may proceed | chdev -l sys0 -a minpout minpout | chdev -l sys0 -a minpout minpout |
| Sets the amount of modified data cache for a file with random writes | ioo -o maxrandwrt=value | ioo -o j2_maxRandomWrite ioo -o j2_nRandomCluster |
| Controls the gathering of I/Os for sequential write behind | ioo -o numclust=value | ioo -o j2_nPagesPerWriteBehindCluster=value |
| Sets the number of file system bufstructs | ioo -o numfsbufs=value | ioo -o j2_nBufferPerPagerDevice=value |

Note: The amount of memory for caching files for Enhanced JFS, tuning parameter **maxclient**, is a subset of the amount of memory for file caching for JFS. The value of **maxclient** cannot exceed the value of **maxperm**.

File system attributes that affect performance

The longer a file system is used, the more fragmented it becomes. With the dynamic allocation of resources, file blocks become more and more scattered, logically contiguous files become fragmented, and logically contiguous logical volumes (LV) become fragmented.

The following list of things occur when files are accessed from a logical volume that is fragmented:

- Sequential access is no longer sequential
- Random access is slower
- Access time is dominated by longer seek time

However, once the file is in memory, these effects diminish. File system performance is also affected by physical considerations, such as:

- Types of disks and number of adapters
- Amount of memory for file buffering
- Amount of local versus remote file access
- Pattern and amount of file access by application

JFS allows you to change the file system fragment size for better space utilization by subdividing 4 KB blocks. The number of bytes per i-node, or NBPI, is used to control how many i-nodes are created for a file system. Compression can be used for file systems with a fragment size less than 4 KB. Fragment size and compression affect performance and are discussed in the following sections:

- “JFS file system fragment size”
- “JFS compression” on page 203

JFS file system fragment size

The fragments feature in JFS allows the space in a file system to be allocated in less than 4 KB chunks. When you create a file system, you can specify the size of the fragments in the file system. The allowable sizes are 512, 1024, 2048, and 4096 bytes. The default value is 4096 bytes. Files smaller than a fragment are stored together in each fragment, conserving as much disk space as possible, which is the primary objective.

Files smaller than 4096 bytes are stored in the minimum necessary number of contiguous fragments. Files whose size is between 4096 bytes and 32 KB (inclusive) are stored in one or more (4 KB) full blocks and in as many fragments as are required to hold the remainder. For example, a 5632-byte file would be allocated one 4 KB block, pointed to by the first pointer in the i-node. If the fragment size is 512, then eight fragments would be used for the first 4 KB block. The last 1.5 KB would use three fragments, pointed to by the second pointer in the i-node. For files greater than 32 KB, allocation is done in 4 KB blocks, and the i-node pointers point to these 4 KB blocks.

Whatever the fragment size, a full block is considered to be 4096 bytes. In a file system with a fragment size less than 4096 bytes, however, a need for a full block can be satisfied by any contiguous sequence of fragments totalling 4096 bytes. It need not begin on a multiple of a 4096-byte boundary.

The file system tries to allocate space for files in contiguous fragments by spreading the files themselves across the logical volume to minimize inter-file allocation interference and fragmentation.

The primary performance hazard for file systems with small fragment sizes is space fragmentation. The existence of small files scattered across the logical volume can make it impossible to allocate contiguous or closely spaced blocks for a large file. Performance can suffer when accessing large files. Carried to an extreme, space fragmentation can make it impossible to allocate space for a file, even though there are many individual free fragments.

Another adverse effect on disk I/O activity is the number of I/O operations. For a file with a size of 4 KB stored in a single fragment of 4 KB, only one disk I/O operation would be required to either read or write the file. If the choice of the fragment size was 512 bytes, eight fragments would be allocated to this file, and for a read or write to complete, several additional disk I/O operations (disk seeks, data transfers, and allocation activity) would be required. Therefore, for file systems which use a fragment size of 4 KB, the number of disk I/O operations might be far less than for file systems which employ a smaller fragment size.

Part of a decision to create a small-fragment file system should be a policy for defragmenting the space in that file system with the **defragfs** command. This policy must also take into account the performance cost of running the **defragfs** command. See Defragmenting a file system.

JFS compression

If a file system is compressed, all data is compressed automatically using Lempel-Zev (LZ) compression before being written to disk, and all data is uncompressed automatically when read from disk. The LZ algorithm replaces subsequent occurrences of a given string with a pointer to the first occurrence. On an average, a 50 percent savings in disk space is realized.

File system data is compressed at the level of an individual logical blocks. To compress data in large units (all the logical blocks of a file together, for example) would result in the loss of more available disk space. By individually compressing a file's logical blocks, random seeks and updates are carried out much more rapidly.

When a file is written into a file system for which compression is specified, the compression algorithm compresses the data 4096 bytes (a page) at a time, and the compressed data is then written in the minimum necessary number of contiguous fragments. Obviously, if the fragment size of the file system is 4 KB, there is no disk-space payback for the effort of compressing the data. Therefore, compression requires fragmentation to be used, with a fragment size smaller than 4096.

Although compression should result in conserving space overall, there are valid reasons for leaving some unused space in the file system:

- Because the degree to which each 4096-byte block of data will compress is not known in advance, the file system initially reserves a full block of space. The unneeded fragments are released after compression, but the conservative initial allocation policy may lead to premature "out of space" indications.
- Some free space is necessary to allow the **defragfs** command to operate.

In addition to increased disk I/O activity and free-space fragmentation problems, file systems using data compression have the following performance considerations:

- Degradation in file system usability arising as a direct result of the data compression/decompression activity. If the time to compress and decompress data is quite lengthy, it might not always be possible to use a compressed file system, particularly in a busy commercial environment where data needs to be available immediately.
- All logical blocks in a compressed file system, when modified for the first time, will be allocated 4096 bytes of disk space, and this space will subsequently be reallocated when the logical block is written to disk. Performance costs are associated with reallocation, which does not occur in noncompressed file systems.
- To perform data compression, approximately 50 CPU cycles per byte are required, and about 10 CPU cycles per byte for decompression. Data compression therefore places a load on the processor by increasing the number of processor cycles.
- The JFS compression kproc (**jfsc**) runs at a fixed priority of 30 so that while compression/decompression is occurring, the CPU that this kproc is running on may not be available to other processes unless they run at a better priority.

Reorganization of file systems

You can reduce file system fragmentation as follows:

- Copying the files to a backup media
- Recreating the file system using the **mkfs fsname** command or deleting the contents of the file system
- Reloading the files into the file system

This procedure loads the file sequentially and reduces fragmentation. The following sections provide more information:

- "Reorganizing a file system" on page 204
- "File system defragmentation" on page 205

Reorganizing a file system

For example, a system has a separate logical volume and file system *hd11* (mount point: **/home/op**). Because we decide that file system *hd11* needs to be reorganized, we perform the following steps:

1. Back up the file system by file name. If you back up the file system by i-node instead of by name, the **restore** command puts the files back in their original places, which would not solve the problem. Run the following commands:

```
# cd /home/op
# find . -print | backup -ivf/tmp/op.backup
```

This command creates a backup file (in a different file system), containing all of the files in the file system that is to be reorganized. If disk space on the system is limited, you can use tape to back up the file system.

2. Run the following commands:

```
# cd /
# umount /home/op
```

If any processes are using **/home/op** or any of its subdirectories, you must terminate those processes before the **umount** command can complete successfully.

3. Re-create the file system on the **/home/op** logical volume, as follows:

```
# mkfs /dev/hd11
```

You are prompted for confirmation before the old file system is destroyed. The name of the file system does not change.

4. To restore the original situation (except that **/home/op** is empty), run the following:

```
# mount /dev/hd11 /home/op
# cd /home/op
```

5. Restore the data, as follows:

```
# restore -xvf/tmp/op.backup >/dev/null
```

Standard output is redirected to **/dev/null** to avoid displaying the name of each of the files that were restored, which is time-consuming.

6. Review the large file inspected earlier (see File placement assessment with the `fileplace` command), as follows:

```
# fileplace -piv big1
```

We see that it is now (nearly) contiguous:

```
File: big1 Size: 3554273 bytes Vol: /dev/hd11
Blk Size: 4096 Frag Size: 4096 Nfrags: 868 Compress: no
Inode: 8290 Mode: -rwxr-xr-x Owner: hoetzel Group: system
```

```
INDIRECT BLOCK: 60307
```

| Physical Addresses (mirror copy 1) | Logical Fragment |
|---|------------------|
| ----- | ----- |
| 0060299-0060306 hdisk1 8 frags 32768 Bytes, 0.9% | 0008555-0008562 |
| 0060308-0061167 hdisk1 860 frags 3522560 Bytes, 99.1% | 0008564-0009423 |

```
868 frags over space of 869 frags: space efficiency = 99.9%
2 fragments out of 868 possible: sequentiality = 99.9%
```

The **-i** option that we added to the **fileplace** command indicates that the one-block gap between the first eight blocks of the file and the remainder contains the indirect block, which is required to supplement the i-node information when the length of the file exceeds eight blocks.

Some file systems or logical volumes should not be reorganized because the data is either transitory (for example, **/tmp**) or not in a file system format (log). The root file system is normally not very volatile and

seldom needs reorganizing. It can only be done in install/maintenance mode. The same is true for `/usr` because many of these files are required for normal system operation.

File system defragmentation

If a file system has been created with a fragment size smaller than 4 KB, it becomes necessary after a period of time to query the amount of scattered unusable fragments. If many small fragments are scattered, it is difficult to find available contiguous space.

To recover these small, scattered spaces, use either the `smitty dejfs` command or the `smitty dejfs2` command or the `defragfs` command. Some free space must be available for the defragmentation procedure to be used. The file system must be mounted for read-write.

File system performance tuning

This topic focuses on file system performance tuning and contains the following sections:

- Sequential read performance tuning
- Sequential and random write performance tuning
- Asynchronous I/O performance tuning
- File synchronization performance tuning
- File system buffer tuning
- Direct I/O tuning

Sequential read performance tuning

The VMM sequential read-ahead feature, described in Sequential-Access Read Ahead can enhance the performance of programs that access large files sequentially.

The following illustrates a typical read-ahead situation.

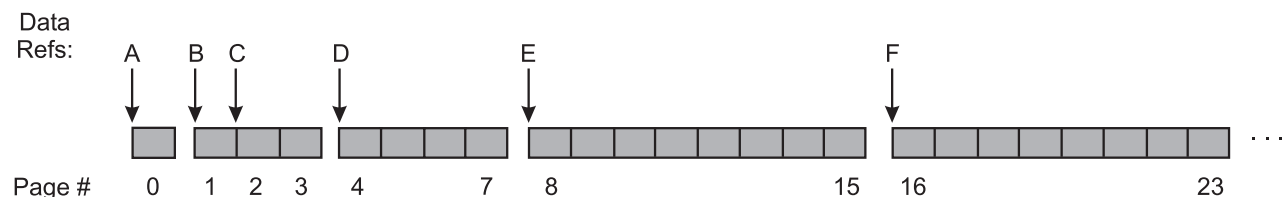

Figure 22. Sequential Read-Ahead Example. This illustration shows a row of blocks simulating a segmented track of file page numbers. These block segments are numbered 0, 1 through 3, 4 through 7, 8 through 15 and 16 through 23. The steps of a sequential read-ahead are found in the text immediately following the illustration.

In this example, `minpgahead` is 2 and `maxpgahead` is 8 (the defaults). The program is processing the file sequentially. Only the data references that have significance to the read-ahead mechanism are shown, designated by A through F. The sequence of steps is:

- The first access to the file causes the first page (page 0) of the file to be read. At this point, the VMM makes no assumptions about random or sequential access.
- When the program accesses the first byte of the next page (page 1), with no intervening accesses to other pages of the file, the VMM concludes that the program is accessing sequentially. It schedules `minpgahead` (2) additional pages (pages 2 and 3) to be read. Thus access B causes a total of 3 pages to be read.
- When the program accesses the first byte of the first page that has been read ahead (page 2), the VMM doubles the page-ahead value to 4 and schedules pages 4 through 7 to be read.

- D** When the program accesses the first byte of the first page that has been read ahead (page 4), the VMM doubles the page-ahead value to 8 and schedules pages 8 through 15 to be read.
- E** When the program accesses the first byte of the first page that has been read ahead (page 8), the VMM determines that the page-ahead value is equal to **maxpgahead** and schedules pages 16 through 23 to be read.
- F** The VMM continues reading **maxpgahead** pages when the program accesses the first byte of the previous group of read-ahead pages until the file ends.

If the program were to deviate from the sequential-access pattern and access a page of the file out of order, sequential read-ahead would be terminated. It would be resumed with **minpgahead** pages if the VMM detected that the program resumed sequential access.

The **minpgahead** and **maxpgahead** values can be changed by using options **-r** and **-R** in the **ioo** command. If you are contemplating changing these values, keep in mind:

- The values should be from the set: 0, 1, 2, 4, 8, 16, and so on. The use of other values may have adverse performance or functional effects.
 - Values should be powers of 2 because of the doubling algorithm of the VMM.
 - Values of **maxpgahead** greater than 16 (reads ahead of more than 64 KB) exceed the capabilities of some disk device drivers. In such a case, the read size stays at 64 KB.
 - Higher values of **maxpgahead** can be used in systems where the sequential performance of striped logical volumes is of paramount importance.
- A value of 0 for both **minpgahead** and **maxpgahead** effectively defeats the mechanism. This can adversely affect performance. However, it can be useful in some cases where I/O is random, but the size of the I/Os cause the VMM's read-ahead algorithm to take effect.
- The **maxpgahead** values of 8 or 16 yield the maximum possible sequential I/O performance for non-striped file systems.
- The buildup of the read-ahead value from **minpgahead** to **maxpgahead** is quick enough that for most file sizes there is no advantage to increasing **minpgahead**.
- Sequential Read-Ahead can be tuned separately for JFS and Enhanced JFS. JFS Page Read-Ahead can be tuned with **minpgahead** and **maxpgahead** whereas **j2_minPageReadAhead** and **j2_maxPageReadAhead** are used for Enhanced JFS.

Sequential and random write behind performance tuning

Write behind involves asynchronously writing modified pages in memory to disk after reaching a threshold rather than waiting for the **syncd** daemon to flush the pages to disk. This is done to limit the number of dirty pages in memory, reduce system overhead, and minimize disk fragmentation. There are two types of write-behind: sequential and random.

Sequential write behind

By default, a JFS file is partitioned into 16 KB partitions or 4 pages. Each of these partitions is called a *cluster*. If all 4 pages of this cluster are dirty, then as soon as a page in the next partition is modified, the 4 dirty pages of this cluster are scheduled to go to disk. Without this feature, pages would remain in memory until the **syncd** daemon runs, which could cause I/O bottlenecks and fragmentation of the file.

The number of clusters that the VMM uses as a threshold is tunable. The default is one cluster. You can delay write behind by increasing the **numclust** parameter using the **ioo -o numclust** command.

For Enhanced JFS, the **ioo -o j2_nPagesPerWriteBehindCluster** command is used to specify the number of pages to be scheduled at one time, rather than the number of clusters. The default number of pages for an Enhanced JFS cluster is 32, implying a default size of 128 KB for Enhanced JFS.

Random write behind

There may be applications that perform a lot of random I/O, that is, the I/O pattern does not meet the requirements of the write behind algorithm and thus all the pages stay resident in memory until the **syncd** daemon runs. If the application has modified many pages in memory, this could cause a very large number of pages to be written to disk when the **syncd** daemon issues a **sync()** call.

The write behind feature provides a mechanism such that when the number of dirty pages in memory for a given file exceeds a defined threshold, the subsequent pages written are then scheduled to be written to disk.

You can tune the threshold by using the **ioo** command with the JFS **maxrandwrt** parameter. The default value is 0, indicating that random write behind is disabled. Increasing this value to 128 indicates that once 128 memory-resident pages of a file are dirty, any subsequent dirty pages are scheduled to be written to the disk. The first set of pages will be flushed after a **sync()** call.

For Enhanced JFS, **ioo** command options **j2_nRandomCluster** (-z flag) and **j2_maxRandomWrite** (-J flag) are used to tune random write behind. Both options have a default of 0. The **j2_maxRandomWrite** option has the same function for enhanced JFS as **maxrandwrt** does for JFS. That is, it specifies a limit for the number of dirty pages per file that can remain in memory. The **j2_nRandomCluster** option specifies the number of clusters apart two consecutive writes must be in order to be considered random.

Asynchronous disk I/O performance tuning

If an application does a synchronous I/O operation, it must wait for the I/O to complete. In contrast, asynchronous I/O operations run in the background and do not block user applications. This improves performance, because I/O operations and applications processing can run simultaneously. Many applications, such as databases and file servers, take advantage of the ability to overlap processing and I/O.

Applications can use the **aio_read()**, **aio_write()**, or **lio_listio()** subroutines (or their 64-bit counterparts) to perform asynchronous disk I/O. Control returns to the application from the subroutine as soon as the request has been queued. The application can then continue processing while the disk operation is being performed.

To manage asynchronous I/O, each asynchronous I/O request has a corresponding control block in the application's address space. This control block contains the control and status information for the request. It can be used again when the I/O operation is completed.

After issuing an asynchronous I/O request, the user application can determine when and how the I/O operation is completed. This information is provided in any of three ways:

- The application can poll the status of the I/O operation.
- The system can asynchronously notify the application when the I/O operation is done.
- The application can block until the I/O operation is complete.

Each I/O is handled by a single kernel process, or kproc, and typically the kproc cannot process any more requests from the queue until that I/O has completed. The default minimum number of servers configured when async I/O is enabled is 1, which is the **minservers** attribute. There is also a maximum number of async I/O servers that get created, which is controlled by the **maxservers** attribute. The **maxservers** value is the number of async I/O kprocs per CPU and the default value is 10 per CPU. To obtain the maximum number of async I/O kprocs running on an AIX system, multiply the **maxservers** value with the number of currently running CPUs.

The number of servers limits the number of asynchronous disk I/O operations that can be in progress in the system simultaneously. You can set the number of servers with the SMIT command (**smitty**->Devices->Asynchronous I/O->Change/Show Characteristics of Asynchronous I/O->{*MINIMUM* | *MAXIMUM*} number of servers or **smitty aio**) or with the **chdev** command.

In systems that seldom run applications that use asynchronous I/O, the defaults are usually adequate.

If the number of async I/O requests is high, increase the **maxservers** value to approximately the number of simultaneous I/Os there might be. In most cases, it is better to leave the **minservers** parameter at the default value because the AIO kernel extension will generate additional servers if needed.

Note: AIO actions performed against a raw Logical Volume do not use kproc server processes. The setting of **maxservers** and **minservers** have no effect in this case.

By looking at the CPU utilization of the AIO servers, if the utilization is evenly divided among all of them, that means that they're all being used; you may want to try increasing them in this case. To see the AIO servers by name, run the **pstat -a** command. Run the **ps -k** command to see the AIO servers as the name kproc.

For environments in which the performance of asynchronous disk I/O is critical and the volume of requests is high, but you do not have an approximate number of simultaneous I/Os, it is recommended that **maxservers** be set to at least 10*(number of disks accessed asynchronously).

This could be achieved for a system with three asynchronously accessed disks as follows:

```
# chdev -l aio0 -a maxservers='30'
```

In addition, you can set the maximum number of asynchronous I/O REQUESTS outstanding, and the server PRIORITY. If you have a system with a high volume of asynchronous I/O applications, it might be appropriate to increase the REQUESTS number and lower the PRIORITY number.

File synchronization performance tuning

JFS file I/Os that are not sequential will accumulate in memory until certain conditions are met:

- The free list shrinks to **minfree**, and page replacement has to occur.
- The **syncd** daemon flushes pages at regularly scheduled intervals.
- The **sync** command is issued.
- Random-write behind flushes the dirty pages after random-write behind threshold is reached.

If too many pages accumulate before one of these conditions occur, then when pages do get flushed by the **syncd** daemon, the i-node lock is obtained and held until all dirty pages have been written to disk. During this time, threads trying to access that file will get blocked because the i-node lock is not available. Remember that the **syncd** daemon currently flushes all dirty pages of a file, but one file at a time. On systems with large amount of memory and large numbers of pages getting modified, high peaks of I/Os can occur when the **syncd** daemon flushes the pages.

AIX has a tunable option called **sync_release_ilock**. The **ioo** command with the **-o sync_release_ilock=1** option allows the i-node lock to be released while dirty pages of that file are being flushed. This can result in better response time when accessing this file during a **sync()** call.

This blocking effect can also be minimized by increasing the frequency of syncs in the **syncd** daemon. Change **/sbin/rc.boot** where it invokes the **syncd** daemon. Then reboot the system for it to take effect. For the current system, kill the **syncd** daemon and restart it with the new seconds value.

A third way to tune this behavior is by turning on random write behind using the **ioo** command (see VMM write behind).

File system buffer tuning

The following **ioo** and **vmstat -v** parameters can be useful in detecting I/O buffer bottlenecks and tuning disk I/O:

Counters of blocked I/Os due to a shortage of buffers

The **vmstat -v** command displays counters of blocked I/Os due to a shortage of buffers in various kernel components. Here is part of an example of the **vmstat -v** output:

```
...
    0 paging space I/Os blocked with no psbuf
    2740 filesystem I/Os blocked with no fsbuf
    0 external pager filesystem I/Os blocked with no fsbuf
...
```

The paging space I/Os blocked with no psbuf and the filesystem I/Os blocked with no fsbuf counters are incremented whenever a bufstruct is unavailable and the VMM puts a thread on the VMM wait list. The external pager filesystem I/Os blocked with no fsbuf counter is incremented whenever a bufstruct on an Enhanced JFS file system is unavailable

The numfsbufs parameter

If there are many simultaneous or large I/Os to a filesystem or if there are large sequential I/Os to a file system, it is possible that the I/Os might bottleneck at the file system level while waiting for bufstructs. You can increase the number of bufstructs per file system, known as **numfsbufs**, with the **ioo** command. The value takes effect only when a file system is mounted; so if you change the value, you must then unmount and mount the file system again. The default value for **numfsbufs** is currently 93 bufstructs per file system.

The j2_nBufferPerPagerDevice parameter

In Enhanced JFS, the number of bufstructs is specified with the **j2_nBufferPerPagerDevice** parameter. The default number of bufstructs for an Enhanced JFS filesystem is currently 512. The number of bufstructs per Enhanced JFS filesystem (**j2_nBufferPerPagerDevice**) can be increased using the **ioo** command. The value takes effect only when a file system is mounted.

The lvm_bufcnt parameter

If an application is issuing very large raw I/Os rather than writing through the file system, the same type of bottleneck as for file systems could occur at the LVM layer. Very large I/Os combined with very fast I/O devices would be required to cause the bottleneck to be at the LVM layer. But if it does happen, a parameter called **lvm_bufcnt** can be increased by the **ioo** command to provide for a larger number of "uphysio" buffers. The value takes effect immediately. The current default value is 9 "uphysio" buffers. Because the LVM currently splits I/Os into 128 K each, and because the default value of **lvm_bufcnt** is 9, the 9*128 K can be written at one time. If your I/Os are larger than 9*128 K, increasing **lvm_bufcnt** might be advantageous.

The pd_npages parameter

The **pd_npages** parameter specifies the number of pages that should be deleted in one chunk from RAM when a file is deleted. Changing this value may only be beneficial to real-time applications that delete files. By reducing the value of the **pd_npages** parameter, a real-time application can get better response time because few number of pages will be deleted before a process/thread is dispatched. The default value is the largest possible file size divided by the page size (currently 4096); if the largest possible file size is 2 GB, then the value of the **pd_npages** parameter is 524288 by default.

The v_pinshm parameter

When you set the **v_pinshm** parameter to 1, it causes pages in shared memory segments to be pinned by VMM, if the application, which does the **shmget()**, specifies SHM_PIN as part of the flags. The default value is 0.

Applications can choose to have a tunable which specifies whether the application should use the SHM_PIN flag (for example, the **lock_sga** parameter in Oracle 8.1.5 and later). Avoid pinning too much memory, because in that case no page replacement can occur. Pinning is useful because it saves overhead in async I/O from these shared memory segments (the async I/O kernel extension is not required to pin the buffers).

Direct I/O tuning

When you are processing normal I/O to files, the I/O goes from the application buffer to the VMM and from there back to the application buffer. The contents of the buffer are cached in RAM through the VMM's use of real memory as a file buffer cache. If the file cache hit rate is high, then this type of cached I/O is very effective in improving overall I/O performance. But applications that have poor cache hit rates or applications that do very large I/Os may not get much benefit from the use of normal cached I/O.

The main benefit of direct I/O is to reduce CPU utilization for file reads and writes by eliminating the copy from the VMM file cache to the user buffer. If the cache hit rate is low, then most read requests have to go to the disk. Writes are faster with normal cached I/O in most cases. But if a file is opened with `O_SYNC` or `O_DSYNC` (see Using sync/fsync calls), then the writes have to go to disk. In these cases, direct I/O can benefit applications because the data copy is eliminated.

Another benefit is that direct I/O allows applications to avoid diluting the effectiveness of caching of other files. When a file is read or written, that file competes for space in memory which could cause other file data to get pushed out of memory. If an application developer knows that certain files have poor cache-utilization characteristics, then only those files could be opened with `O_DIRECT`.

For direct I/O to work efficiently, the I/O request should be appropriate for the type of file system being used. The `finfo()` and `ffinfo()` subroutines can be used to query the offset, length, and address alignment requirements for fixed block size file systems, fragmented file systems, and bigfile file systems (direct I/O is not supported on compressed file systems). The information queried are contained in the structure `diocapbuf` as described in `/usr/include/sys/finfo.h`.

To avoid consistency issues, if there are multiple calls to open a file and one or more of the calls did not specify `O_DIRECT` and another open specified `O_DIRECT`, the file stays in the normal cached I/O mode. Similarly, if the file is mapped into memory through the `shmat()` or `mmap()` system calls, it stays in normal cached mode. If the last conflicting, non-direct access is eliminated, then the file system will move the file into direct I/O mode (either by using the `close()`, `munmap()`, or `shmdt()` subroutines). Changing from normal mode to direct I/O mode can be expensive because all modified pages in memory will have to be flushed to disk at that point.

Performance of direct I/O reads

Even though the use of direct I/O can reduce CPU usage, it typically results in longer elapsed times, especially for small I/O requests, because the requests would not be cached in memory.

Direct I/O reads cause synchronous reads from the disk, whereas with normal cached policy, the reads may be satisfied from the cache. This can result in poor performance if the data was likely to be in memory under the normal caching policy. Direct I/O also bypasses the VMM read-ahead algorithm because the I/Os do not go through the VMM. The read-ahead algorithm is very useful for sequential access to files because the VMM can initiate disk requests and have the pages already resident in memory before the application has requested the pages. Applications can compensate for the loss of this read-ahead by using one of the following methods:

- Issuing larger read requests (minimum of 128 K)
- Issuing asynchronous direct I/O read-ahead by the use of multiple threads
- Using the asynchronous I/O facilities such as `aio_read()` or `lio_listio()`

Performance of direct I/O writes

Direct I/O writes bypass the VMM and go directly to the disk, so that there can be a significant performance penalty; in normal cached I/O, the writes can go to memory and then be flushed to disk later by a `sync` or `write behind` operation. Because direct I/O writes do not get copied into memory, when a `sync` operation is performed, it will not have to flush these pages to disk, thus reducing the amount of work the `syncd` daemon has to perform.

Direct I/O tuning summary

Direct I/O requires substantially fewer CPU cycles than regular I/O. I/O-intensive applications that do not get much benefit from the caching provided by regular I/O can enhance performance by using direct I/O. The benefits of direct I/O will grow in the future as increases in CPU speeds continue to outpace increases in memory speeds.

Programs that are good candidates for direct I/O are typically CPU-limited and perform lots of disk I/O. Technical applications that have large sequential I/Os are good candidates. Applications that do numerous small I/Os will typically see less performance benefit, because direct I/O cannot do read ahead or write behind. Applications that have benefited from striping are also good candidates.

Reorganization of file system logs and log logical volumes

The Journaled File System (JFS) and the Enhanced Journaled File System (JFS2) use a database journaling technique to maintain a consistent file system structure. This involves duplicating transactions that are made to file system metadata to the circular file system log. File system metadata includes the superblock, i-nodes, indirect data pointers, and directories.

When pages in memory are actually written to disk by a **sync()** or **fsync()** call, commit records are written to the log to indicate that the data is now on disk. Log transactions occur in the following situations:

- When a file is created or deleted.
- When a **write()** call occurs for a file opened with `O_SYNC` and the write causes a new disk block allocation.
- When the **fsync()** or **sync()** subroutines are called.
- When a write causes an indirect or double-indirect block to be allocated.

File system logs enable rapid and clean recovery of file systems if a system goes down. If an application is doing synchronous I/O or is creating and removing many files in a short amount of time, there might be a lot of I/O going to the log logical volume. If both the log logical volume and the file system logical volume are on the same physical disk, this could cause an I/O bottleneck. The recommendation would be to migrate the log device to another physical disk (this is especially useful for NFS servers).

Fast-write cached devices can provide for much better performance for log logical volumes (file system log or database logs).

AIX 4.3.2 provides a **mount** option called **nointegrity** for JFS file systems which bypasses the use of a JFS log for the file system mounted with this option. This can provide better performance as long as the administrator knows that the **fsck** command might have to be run on the file system if the system goes down without a clean shutdown.

Use the **filemon** command to record information about I/Os to the file system log. If you notice that a file system and its log device are both heavily utilized, it might be better to put each one on a separate physical disk (assuming that there is more than one disk in that volume group).

You can have multiple log devices in a volume group. However, a log for a file system must be in the same volume group as that of the file system. A log logical volume or file system logical volume can be moved to another disk using the **migratepv** command, even while the system is running and in use.

Creating log logical volumes

Placing the log logical volume on a physical volume different from your most active file system logical volume will increase parallel resource usage. You can use a separate log for each file system.

When you create your logical volumes, the performance of drives differs. Try to create a logical volume for a hot file system on a fast drive (possibly one with fast write cache), as follows:

1. Create new file system log logical volume, as follows:

```
# mklv -t jfslog -y LVname VGname 1 PVname
```

 or

```
# mklv -t jfs2log -y LVname VGname 1 PVname
```

 or

```
# smitty mklv
```
2. Format the log as follows:

```
# /usr/sbin/logform -V vfstype /dev/LVname
```
3. Modify **/etc/filesystems** and the logical volume control block (LVCB) as follows:

```
# chfs -a log=/dev/LVname /filesystemname
```
4. Unmount and then mount file system.

Another way to create the log on a separate volume is to:

- Initially define the volume group with a single physical volume.
- Define a logical volume within the new volume group (this causes the allocation of the volume group JFS log to be on the first physical volume).
- Add the remaining physical volumes to the volume group.
- Define the high-utilization file systems (logical volumes) on the newly added physical volumes.

Disk I/O pacing

Disk-I/O pacing is intended to prevent programs that generate very large amounts of output from saturating the system's I/O facilities and causing the response times of less-demanding programs to deteriorate. Disk-I/O pacing enforces per-segment, or per-file, high and low-water marks on the sum of all pending I/Os. When a process tries to write to a file that already has *high-water mark* pending writes, the process is put to sleep until enough I/Os have completed to make the number of pending writes less than or equal to the *low-water mark*. The logic of I/O-request handling does not change. The output from high-volume processes is slowed down somewhat.

You can set the high and low-water marks system-wide with the SMIT tool by selecting **System Environments -> Change / Show Characteristics of Operating System(smitty chgsys)** and then entering the number of pages for the high and low-water marks or for individual file systems by using the **maxpout** and **minpout** mount options.

The **maxpout** parameter specifies the number of pages that can be scheduled in the I/O state to a file before the threads are suspended. The **minpout** parameter specifies the minimum number of scheduled pages at which the threads are woken up from the suspended state. The default value for both the **maxpout** and **minpout** parameters is 0, which means that the I/O pacing feature is disabled.

Changes to the system-wide values of the **maxpout** and **minpout** parameters take effect immediately without rebooting the system. Changing the values for the **maxpout** and **minpout** parameters overwrites the system-wide settings. You can exclude a file system from system-wide I/O pacing by mounting the file system and setting the values for the **maxpout** and **minpout** parameters explicitly to 0. The following command is an example:

```
mount -o minpout=0,maxpout=0 /<file system>
```

Tuning the **maxpout** and **minpout** parameters might prevent any thread that is doing sequential writes to a file from dominating system resources.

The following table demonstrates the response time of a session of the **vi** editor on a IBM eServer pSeries model 7039-651, configured as a 4-way system with a 1.7 GHz processor, with various values for the **maxpout** and the **minpout** parameters while writing to disk:

| Value for maxpout | Value for minpout | dd block size (10 GB) | write (sec) | Throughput (MB/sec) | vi comments |
|-------------------|-------------------|-----------------------|-------------|---------------------|--------------------------------|
| 0 | 0 | 10000 | 201 | 49.8 | after dd completed |
| 33 | 24 | 10000 | 420 | 23.8 | no delay |
| 65 | 32 | 10000 | 291 | 34.4 | no delay |
| 129 | 32 | 10000 | 312 | 32.1 | no delay |
| 129 | 64 | 10000 | 266 | 37.6 | no delay |
| 257 | 32 | 10000 | 316 | 31.6 | no delay |
| 257 | 64 | 10000 | 341 | 29.3 | no delay |
| 257 | 128 | 10000 | 223 | 44.8 | no delay |
| 513 | 32 | 10000 | 240 | 41.7 | no delay |
| 513 | 64 | 10000 | 237 | 42.2 | no delay |
| 513 | 128 | 10000 | 220 | 45.5 | no delay |
| 513 | 256 | 10000 | 206 | 48.5 | no delay |
| 513 | 384 | 10000 | 206 | 48.5 | 3 - 6 seconds |
| 769 | 512 | 10000 | 203 | 49.3 | 15-40 seconds, can be longer |
| 769 | 640 | 10000 | 207 | 48.3 | less than 3 seconds |
| 1025 | 32 | 10000 | 224 | 44.6 | no delay |
| 1025 | 64 | 10000 | 214 | 46.7 | no delay |
| 1025 | 128 | 10000 | 209 | 47.8 | less than 1 second |
| 1025 | 256 | 10000 | 204 | 49.0 | less than 1 second |
| 1025 | 384 | 10000 | 203 | 49.3 | 3 seconds |
| 1025 | 512 | 10000 | 203 | 49.3 | 25-40 seconds, can be longer |
| 1025 | 640 | 10000 | 202 | 49.5 | 7 - 20 seconds, can be longer |
| 1025 | 768 | 10000 | 202 | 49.5 | 15 - 95 seconds, can be longer |
| 1025 | 896 | 10000 | 209 | 47.8 | 3 - 10 seconds |

The best range for the **maxpout** and **minpout** parameters depends on the CPU speed and the I/O system. I/O pacing works well if the value of the **maxpout** parameter is equal to or greater than the value of the **j2_nPagesPerWriteBehindCluster** parameter. For example, if the value of the **maxpout** parameter is equal to 64 and the **minpout** parameter is equal to 32, there are at most 64 pages in I/O state and 2 I/Os before blocking on the next write.

The default tuning parameters are as follows:

| Parameter | Default Value |
|--------------------------------|---------------|
| j2_nPagesPerWriteBehindCluster | 32 |
| j2_nBufferPerPagerDevice | 512 |

For Enhanced JFS, you can use the **ioo -o j2_nPagesPerWriteBehindCluster** command to specify the number of pages to be scheduled at one time. The default number of pages for an Enhanced JFS cluster is 32, which implies a default size of 128 KB for Enhanced JFS. You can use the **ioo -o**

j2_nBufferPerPagerDevice command to specify the number of file system bufstructs. The default value is 512. For the value to take effect, the file system must be remounted.

Chapter 14. Network performance

This topic discusses several different communications protocols and ways to monitor and tune them. It contains the following major sections:

- TCP and UDP performance tuning
- Tuning mbuf pool performance
- Tuning ARP cache
- Name resolution tuning
- Network performance analysis
- SP™ network tuning

TCP and UDP performance tuning

The optimal settings of the tunable communications parameters vary with the type of LAN, as well as with the communications-I/O characteristics of the predominant system and application programs. This section describes the global principles of communications tuning for AIX.

Use the following outline for verifying and tuning a network installation and workload:

- Ensure adapters are placed in the proper slots.
- Ensure system firmware is at the proper release level
- Ensure adapter and network switches are in proper speed and duplex mode
- Ensure correct MTU size has been selected
- Adjust AIX tunables for network type, speed, and protocol
- Other considerations:
 - Adapter offload options
 - TCP checksum offload
 - TCP large send or re-segmentation
 - Interrupt coalescing
 - Input threads (Dog threads)

Adapter Placement

Network performance is dependent on the hardware you select, like the adapter type, and the adapter placement in the machine. To ensure best performance, you must place the network adapters in the I/O bus slots that are best suited for each adapter.

Consider the following items:

- PCI-X versus PCI adapters
- 64-bit versus 32-bit adapters
- supported bus-slot clock speed (33 MHz, 50/66 MHz, or 133 MHz)

The higher the bandwidth or data rate of the adapter, the more critical the slot placement. For example, PCI-X adapters perform best when used in PCI-X slots, as they typically run at 133 MHz clock speed on the bus. You can place PCI-X adapters in PCI slots, but they run slower on the bus, typically at 33 MHz or 66 MHz, and do not perform as well on some workloads.

Similarly, 64-bit adapters work best when installed in 64-bit slots. You can place 64-bit adapters in a 32-bit slot, but they do not perform at optimal rates. Large MTU adapters, like Gigabit Ethernet in jumbo frame mode, perform much better in 64-bit slots.

Other issues that potentially affect performance are the number of adapters per bus or per PCI host bridge (PHB). Depending on the system model and the adapter type, the number of high speed adapters may be limited per PHB. The placement guidelines ensure that the adapters are spread across the various PCI buses and might limit the number of adapters per PCI bus. Consult the PCI Adapter Placement Reference for more information by machine model and adapter type.

The following table lists the types of PCI and PCI-X slots available in IBM pSeries® eServers:

| Slot type | Code used in this topic |
|----------------------|-------------------------|
| PCI 32-bit 33 MHz | A |
| PCI 32-bit 50/66 MHz | B |
| PCI 64-bit 33 MHz | C |
| PCI 64-bit 50/66 MHz | D |
| PCI-X 32-bit 33 MHz | E |
| PCI-X 32-bit 66 MHz | F |
| PCI-X 64-bit 33 MHz | G |
| PCI-X 64-bit 66 MHz | H |
| PCI-X 64-bit 133 MHz | I |

The newer IBM pSeries servers only have PCI-X slots. The PCI-X slots are backwards-compatible with the PCI adapters.

The following table shows examples of common adapters and the suggested slot types:

| Adapter type | Preferred slot type (lowest to highest priority) |
|--|--|
| 10/100 Mbps Ethernet PCI Adapter II (10/100 Ethernet), FC 4962 | A-I |
| IBM PCI 155 Mbps ATM adapter, FC 4953 or 4957 | D, H, and I |
| IBM PCI 622 Mbs MMF ATM adapter, FC 2946 | D, G, H, and I |
| Gigabit Ethernet-SX PCI Adapter , FC 2969 | D, G, H, and I |
| IBM 10/100/1000 Base-T Ethernet PCI Adapter, FC 2975 | D, G, H, and I |
| Gigabit Ethernet-SX PCI-X Adapter (Gigabit Ethernet fiber), FC 5700 | G, H, and I |
| 10/100/1000 Base-TX PCI-X Adapter (Gigabit Ethernet), FC 5701 | G, H, and I |
| 2-Port Gigabit Ethernet-SX PCI-X Adapter (Gigabit Ethernet fiber), FC 5707 | G, H, and I |
| 2-Port 10/100/1000 Base-TX PCI-X Adapter (Gigabit Ethernet), FC 5706 | G, H, and I |

The **lsslot -c pci** command provides the following information:

- The PCI type of the slot
- The bus speed
- Shows which device is in what slot

The following is an example of the **lsslot -c pci** command on a 2-way p615 system with 6 internal slots:

```
# lsslot -c pci
# Slot      Description                               Device(s)
U0.1-P1-I1 PCI-X capable, 64 bit, 133 MHz slot fcs0
```

```

U0.1-P1-I2 PCI-X capable, 32 bit, 66 MHz slot Empty
U0.1-P1-I3 PCI-X capable, 32 bit, 66 MHz slot Empty
U0.1-P1-I4 PCI-X capable, 64 bit, 133 MHz slot fcs1
U0.1-P1-I5 PCI-X capable, 64 bit, 133 MHz slot ent0
U0.1-P1-I6 PCI-X capable, 64 bit, 133 MHz slot ent2

```

For a Gigabit Ethernet adapter, the adapter-specific statistics at the end of the **entstat -d en[interface-number]** command output or the **netstat -v** command output shows the PCI bus type and bus speed of the adapter. The following is an example output of the **netstat -v** command:

```

# netstat -v

10/100/1000 Base-TX PCI-X Adapter (14106902) Specific Statistics:
-----
Link Status: Up
Media Speed Selected: Auto negotiation
Media Speed Running: 1000 Mbps Full Duplex
PCI Mode: PCI-X (100-133)
PCI Bus Width: 64 bit

```

System Firmware

The system firmware is responsible for configuring several key parameters on each PCI adapter as well as configuring options in the I/O chips on the various I/O and PCI buses in the system. In some cases, the firmware sets parameters unique to specific adapters, for example the PCI Latency Timer and Cache Line Size, and for PCI-X adapters, the Maximum Memory Read Byte Count (MMRBC) values. These parameters are key to obtaining good performance from the adapters. If these parameters are not properly set because of down-level firmware, it will be impossible to achieve optimal performance by software tuning alone. Ensure that you update the firmware on older systems before adding new adapters to the system.

Firmware release level information and firmware updates can be downloaded from the following link: <https://techsupport.services.ibm.com/server/mdownload/download.html>

You can see both the platform and system firmware levels with the **lscfg -vplgrep -p "ROM"** command, as in the following example:

```

lscfg -vplgrep -p "ROM"

...lines omitted...

System Firmware:
  ROM Level (alterable).....M2P030828
  Version.....RS6K
  System Info Specific.(YL)...U0.1-P1/Y1
  Physical Location: U0.1-P1/Y1

SPCN firmware:
  ROM Level (alterable).....0000CMD02252
  Version.....RS6K
  System Info Specific.(YL)...U0.1-P1/Y3
  Physical Location: U0.1-P1/Y3

SPCN firmware:
  ROM Level (alterable).....0000CMD02252
  Version.....RS6K
  System Info Specific.(YL)...U0.2-P1/Y3
  Physical Location: U0.2-P1/Y3

Platform Firmware:
  ROM Level (alterable).....MM030829
  Version.....RS6K
  System Info Specific.(YL)...U0.1-P1/Y2
  Physical Location: U0.1-P1/Y2

```

Adapter performance guidelines

User payload data rates can be obtained by sockets-based programs for applications that are streaming data over a TCP connection. For example, one program doing `send()` calls and the receiver doing `recv()` calls. The rates are a function of the network bit rate, MTU size (frame size), physical level overhead, like Inter-Frame gap and preamble bits, data link headers, and TCP/IP headers and assume a Gigahertz speed CPU. These rates are best case numbers for a single LAN, and may be lower if going through routers or additional network hops or remote links.

Single direction (simplex) TCP Streaming rates are rates that can be seen by a workload like FTP sending data from machine A to machine B in a memory to memory test. See “The ftp command” on page 248 in “Network performance analysis” on page 247. Note that full duplex media performs slightly better than half duplex media because the TCP acks can flow back without contending for the same wire that the data packets are flowing on.

The following table lists maximum possible network payload speeds and the single direction (simplex) TCP streaming rates:

Note: In the following tables, the **Raw bit Rate** value is the physical media bit rate and does not reflect physical media overheads like Inter-Frame gaps, preamble bits, cell overhead (for ATM), data link headers and trailers. These all reduce the effective usable bit rate of the wire.

| Network type | Raw bit Rate (Mbits) | Payload Rate (Mbits) | Payload Rate (MB) |
|---|------------------------------|----------------------|-------------------|
| 10 Mbit Ethernet, Half Duplex | 10 | 6 | 0.7 |
| 10 Mbit Ethernet, Full Duplex | 10 (20 Mbit full duplex) | 9.48 | 1.13 |
| 100 Mbit Ethernet, Half Duplex | 100 | 62 | 7.3 |
| 100 Mbit Ethernet, Full Duplex | 100 (200 Mbit full duplex) | 94.8 | 11.3 |
| 1000 Mbit Ethernet, Full Duplex, MTU 1500 | 1000 (2000 Mbit full duplex) | 948 | 113.0 |
| 1000 Mbit Ethernet, Full Duplex, MTU 9000 | 1000 (2000 Mbit full duplex) | 989 | 117.9 |
| FDDI, MTU 4352 (default) | 100 | 92 | 11.0 |
| ATM 155, MTU 1500 | 155 | 125 | 14.9 |
| ATM 155, MTU 9180 (default) | 155 | 133 | 15.9 |
| ATM 622, MTU 1500 | 622 | 364 | 43.4 |
| ATM 622, MTU 9180 (default) | 622 | 534 | 63.6 |

Two direction (duplex) TCP streaming workloads have data streaming in both directions. For example, running the `ftp` command from machine A to machine B and another instance of the `ftp` command from machine B to A concurrently. These types of workloads take advantage of full duplex media that can send and receive data concurrently. Some media, like FDDI or Ethernet in Half Duplex mode, can not send and receive data concurrently and will not perform well when running duplex workloads. Duplex workloads do not scale to twice the rate of a simplex workload because the TCP ack packets coming back from the receiver now have to compete with data packets flowing in the same direction. The following table lists the two direction (duplex) TCP streaming rates:

| Network type | Raw bit Rate (Mbits) | Payload Rate (Mbits) | Payload Rate (MB) |
|--------------------------------|----------------------------|----------------------|-------------------|
| 10 Mbit Ethernet, Half Duplex | 10 | 5.8 | 0.7 |
| 10 Mbit Ethernet, Full Duplex | 10 (20 Mbit full duplex) | 18 | 2.2 |
| 100 Mbit Ethernet, Half Duplex | 100 | 58 | 7.0 |
| 100 Mbit Ethernet, Full Duplex | 100 (200 Mbit full duplex) | 177 | 21.1 |

| | | | |
|---|------------------------------|------------------|----------------|
| 1000 Mbit Ethernet, Full Duplex, MTU 1500 | 1000 (2000 Mbit full duplex) | 1470 (1660 peak) | 175 (198 peak) |
| 1000 Mbit Ethernet, Full Duplex, MTU 9000 | 1000 (2000 Mbit full duplex) | 1680 (1938 peak) | 200 (231 peak) |
| FDDI, MTU 4352 (default) | 100 | 97 | 11.6 |
| ATM 155, MTU 1500 | 155 (310 Mbit full duplex) | 180 | 21.5 |
| ATM 155, MTU 9180 (default) | 155 (310 Mbit full duplex) | 236 | 28.2 |
| ATM 622, MTU 1500 | 622 (1244 Mbit full duplex) | 476 | 56.7 |
| ATM 622, MTU 9180 (default) | 622 (1244 Mbit full duplex) | 884 | 105 |

Notes:

1. Peak numbers represent best case throughput with multiple TCP sessions running in each direction. Other rates are for single TCP sessions.
2. 1000 Mbit Ethernet (Gigabit Ethernet) duplex rates are for PCI-X adapters in PCI-X slots. Performance is slower on duplex workloads for PCI adapters or PCI-X adapters in PCI slots.
3. Data rates are for TCP/IP using IPV4. Adapters with a MTU size of 4096 and larger have the **RFC1323** option enabled.

Adapter and device settings

Several adapter or device options are important for both proper operation and best performance. AIX devices typically have default values that should work well for most installations. Therefore, these device values normally do not require changes. However, some companies have policies that require specific network settings or some network equipment might require some of these defaults to be changed.

Adapter speed and duplex mode settings

You can configure the Ethernet adapters for the following modes:

- 10_Half_Duplex
- 10_Full_Duplex
- 100_Half_Duplex
- 100_Full_Duplex
- Auto_Negotiation

It is important that you configure both the adapter and the other endpoint of the cable (normally an Ethernet switch or another adapter if running in a point-to-point configuration without an Ethernet switch) the same way. The default setting for AIX is Auto_Negotiation, which negotiates the speed and duplex settings for the highest possible data rates. For the Auto_Negotiation mode to function properly, you must also configure the other endpoint (switch) for Auto_Negotiation mode.

If one endpoint is manually set to a specific speed and duplex mode, the other endpoint should also be manually set to the same speed and duplex mode. Having one end manually set and the other in Auto_Negotiation mode normally results in problems that make the link perform slowly.

It is best to use Auto_Negotiation mode whenever possible, as it is the default setting for most Ethernet switches. However, some 10/100 Ethernet switches do not support Auto_Negotiation mode of the duplex mode. These types of switches require that you manually set both endpoints to the desired speed and duplex mode.

You must use the commands that are unique to each Ethernet switch to display the port settings and change the port speed and duplex mode settings within the Ethernet switch. Refer to your switch vendors' documentation for these commands.

For AIX, you can use the **smitty devices** command to change the adapter settings. You can use the **netstat -v** command or the **entstat -d enX** command, where X is the Ethernet interface number to display the settings and negotiated mode. The following is part of an example of the **entstat -d en3** command output:

```
10/100/1000 Base-TX PCI-X Adapter (14106902) Specific Statistics:
```

```
-----  
Link Status: Up  
Media Speed Selected: Auto negotiation  
Media Speed Running: 1000 Mbps Full Duplex
```

Adapter MTU setting

All devices on the same physical network, or logical network if using VLAN tagging, must have the same Media Transmission Unit (MTU) size. This is the maximum size of a frame (or packet) that can be sent on the wire.

The various network adapters support different MTU sizes, so make sure that you use the same MTU size for all the devices on the network. For example, you can not have a Gigabit Ethernet adapter using jumbo frame mode with a MTU size of 9000 bytes, while other adapters on the network use the default MTU size of 1500 bytes. 10/100 Ethernet adapters do not support jumbo frame mode, so they are not compatible with this Gigabit Ethernet option. You also have to configure Ethernet switches to use jumbo frames, if jumbo frames are supported on your Ethernet switch.

It is important to select the MTU size of the adapter early in the network setup so you can properly configure all the devices and switches. Also, many AIX tuning options are dependent upon the selected MTU size.

MTU size performance impacts

The MTU size of the network can have a large impact on performance. The use of large MTU sizes allows the operating system to send fewer packets of a larger size to reach the same network throughput. The larger packets greatly reduce the processing required in the operating system, assuming the workload allows large messages to be sent. If the workload is only sending small messages, then the larger MTU size will not help.

When possible, use the largest MTU size that the adapter and network support. For example, on ATM, the default MTU size of 9180 is much more efficient than using a MTU size of 1500 bytes (normally used by LAN Emulation). With Gigabit Ethernet, if all of the machines on the network have Gigabit Ethernet adapters and no 10/100 adapters on the network, then it would be best to use jumbo frame mode. For example, a server-to-server connection within the computer lab can typically be done using jumbo frames.

Selecting jumbo frame mode on Gigabit Ethernet

You must select the jumbo frame mode as a device option. Trying to change the MTU size with the **ifconfig** command does not work. Use SMIT to display the adapter settings with the following steps:

1. Select Devices
2. Select Communications
3. Select Adapter Type
4. Select Change/Show Characteristics of an Ethernet Adapter
5. Change the Transmit Jumbo Frames option from no to yes

The SMIT screen looks like the following:

```
Change/Show Characteristics of an Ethernet Adapter
```

```
Type or select values in entry fields.  
Press Enter AFTER making all desired changes.
```

```
Ethernet Adapter
```

```
[Entry Fields]  
ent0
```



```

Description          10/100/1000 Base-TX PCI-X Adapter (14106902)
Status               Available
Location             1H-08
Receive descriptor queue size [1024]             +#+
Transmit descriptor queue size [512]                +#+
Software transmit queue size [8192]                   +#+
Transmit jumbo frames      yes                    +
Enable hardware transmit TCP resegmentation  yes                    +
Enable hardware transmit and receive checksum yes                    +
Media Speed            Auto_Negotiation                +
Enable ALTERNATE ETHERNET address            no                     +
ALTERNATE ETHERNET address [0x000000000000]    +
Apply change to DATABASE only                no                     +

```

```

F1=Help           F2=Refresh           F3=Cancel           F4=List
Esc+5=Reset       Esc+6=Command        Esc+7=Edit          Esc+8=Image
Esc+9=Shell       Esc+0=Exit           Enter=Do

```

Network performance tuning with the no command

The network option or **no** command displays, changes, and manages the global network options. An alternate method for tuning some of these parameters is discussed in the “Interface-Specific Network Options (ISNO)” on page 222 section.

The following **no** command options are used to change the tuning parameters:

Option Definition

- a** Prints all tunables and their current values.
- d [tunable]**
Sets the specified tunable back to the default value.
- D** Sets all options back to their default values.
- o tunable=[New Value]**
Displays the value or sets the specified tunable to the specified new value
- h [tunable]**
Displays help about the specified tunable parameter, if one is specified. Otherwise, displays the **no** command usage statement.
- r** Used with the **-o** option to change a tunable that is of type Reboot to be permanent in the **nextboot** file.
- p** Used with the **-o** option to make a dynamic tunable permanent in the **nextboot** file.
- L [tunable]**
Used with the **-o** option to list the characteristics of one or all tunables, one per line.

The following is an example of the **no** command:

```

NAME                CUR   DEF   BOOT  MIN   MAX   UNIT           TYPE   DEPENDENCIES
-----
General Network Parameters
-----
sockthresh           85    85    85    0     100   %_of_thewall   D
-----
fasttimo             200   200   200   50    200   millisecond     D
-----
inet_stack_size      16    16    16    1     kbyte  R
-----
...lines omitted...

```

where:

CUR = current value

DEF = default value

BOOT = reboot value

MIN = minimal value

MAX = maximum value

UNIT = tunable unit of measure

TYPE = parameter type: D (for Dynamic), S (for Static), R for Reboot), B (for Bosboot), M (for Mount), I (for Incremental) and C (for Connect)

DEPENDENCIES = list of dependent tunable parameters, one per line

Some network attributes are run-time attributes that can be changed at any time. Others are load-time attributes that must be set before the **netinet** kernel extension is loaded.

Note: When you use the **no** command to change parameters, dynamic parameters are changed in memory and the change is in effect only until the next system boot. At that point, all parameters are set to their reboot settings. To make dynamic parameter changes permanent, use the **-ror -p** options of the **no** command to set the options in the **nextboot** file. Reboot parameter options require a system reboot to take affect.

For more information on the **no** command, see *The no Command in AIX 5L Version 5.3 Commands Reference, Volume 4*.

Interface-Specific Network Options (ISNO)

Interface-Specific Network Options (ISNO) allows IP network interfaces to be custom-tuned for the best performance. Values set for an individual interface take precedence over the systemwide values set with the **no** command. The feature is enabled (the default) or disabled for the whole system with the **no** command **use_isno** option. This single-point ISNO disable option is included as a diagnostic tool to eliminate potential tuning errors if the system administrator needs to isolate performance problems.

Programmers and performance analysts should note that the ISNO values will not show up in the socket (meaning they cannot be read by the **getsockopt()** system call) until after the TCP connection is made. The specific network interface that a socket actually uses is not known until the connection is complete, so the socket reflects the system defaults from the **no** command. After the TCP connection is accepted and the network interface is known, ISNO values are put into the socket.

The following parameters have been added for each supported network interface and are only effective for TCP (and not UDP) connections:

- **rfc1323**
- **tcp_nodelay**
- **tcp_sendspace**
- **tcp_recvspace**
- **tcp_mssdflt**

When set for a specific interface, these values override the corresponding **no** option values set for the system. These parameters are available for all of the mainstream TCP/IP interfaces (Token-Ring, FDDI, 10/100 Ethernet, and Gigabit Ethernet), except the **css#** IP interface on the SP switch. As a simple workaround, SP switch users can set the tuning options appropriate for the switch using the systemwide **no** command, then use the ISNOs to set the values needed for the other system interfaces.

These options are set for the TCP/IP interface (such as en0 or tr0), and not the network adapter (ent0 or tok0).

AIX sets default values for the Gigabit Ethernet interfaces, for both MTU 1500 and for jumbo frame mode (MTU 9000). As long as you configure the interface through the **SMIT tcpip** screens, the ISNO options should be set to the default values, which provides good performance.

For 10/100 Ethernet and token ring adapters, the ISNO defaults are not set by the system as they typically work fine with the system global **no** defaults. However, the ISNO attributes can be set if needed to override the global defaults.

The following example shows the default ISNO values for **tcp_sendspace** and **tcp_recvspace** for GigE in MTU 1500 mode :

```
# ifconfig en0
en0: flags=5e080863,c0<UP,BROADCAST,NOTRAILERS,RUNNING,SIMPLEX,MULTICAST,GROUPRT,64BIT,CHECKSUM_OFFLOAD,PSEG,CHAIN>
      inet 10.0.0.1 netmask 0xffffffff broadcast 192.0.0.255
      tcp_sendspace 131072 tcp_recvspace 65536
```

For jumbo frame mode, the default ISNO values for **tcp_sendspace**, **tcp_recvspace**, and **rfc1323** are set as follows:

```
# ifconfig en0
en0: flags=5e080863,c0<UP,BROADCAST,NOTRAILERS,RUNNING,SIMPLEX,MULTICAST,GROUPRT,64BIT,CHECKSUM_OFFLOAD,PSEG,CHAIN>
      inet 192.0.0.1 netmask 0xffffffff broadcast 192.0.0.255
      tcp_sendspace 262144 tcp_recvspace 131072 rfc1323 1
```

You can set ISNO options by the following methods:

- SMIT
- The **chdev** command
- The **ifconfig** command

Using SMIT or the **chdev** command changes the values in the ODM database on disk so they will be permanent. The **ifconfig** command only changes the values in memory, so they go back to the prior values stored in ODM on the next reboot.

Modifying the ISNO options with SMIT

You can change the ISNO options with SMIT as follows:

```
# smitty tcpip
```

1. Select the Futher Configuration option.
2. Select the Network Interfaces option.
3. Select the Network Interface Selection.
4. Select the Change/Show Characteristics of a Network Interface.
5. Select the interface with your cursor. For example, en0

Then, you will see the following screen:

```
Change / Show a Standard Ethernet Interface
```

```
Type or select values in entry fields.
Press Enter AFTER making all desired changes.
```

```
Network Interface Name          [Entry Fields]
INTERNET ADDRESS (dotted decimal)  en0
Network MASK (hexadecimal or dotted decimal) [192.0.0.1]
Current STATE                    [255.255.255.0]
Use Address Resolution Protocol (ARP)?  up
BROADCAST ADDRESS (dotted decimal)  yes
Interface Specific Network Options
('NULL' will unset the option)
rfc1323                            []
tcp_mssdf1t                         []
tcp_nodelay                          []
```

```
tcp_recvspace      []
tcp_sendspace     []
```

```
F1=Help           F2=Refresh       F3=Cancel        F4=List
Esc+5=Reset       Esc+6=Command    Esc+7=Edit       Esc+8=Image
Esc+9=Shell       Esc+0=Exit       Enter=Do
```

Notice that the ISNO system defaults do not display, even though they are set internally. For this example, override the default value for **tcp_sendspace** and lower it down to 65536.

Bring the interface back up with **smitty tcpip** and select Minimum Configuration and Startup. Then select en0, and take the default values that were set when the interface was first setup.

If you use the **ifconfig** command to show the ISNO options, you can see that the value of the **tcp_sendspace** attribute is now set to 65536. The following is an example:

```
# ifconfig en0
en0: flags=5e080863,c0<UP,BROADCAST,NOTRAILERS,RUNNING,SIMPLEX,MULTICAST,GROUPRT,64BIT,CHECKSUM_OFFLOAD,PSEQ,CHAIN>
    inet 192.0.0.1 netmask 0xfffff00 broadcast 192.0.0.255
    tcp_sendspace 65536 tcp_recvspace 65536
```

The **lsattr** command output also shows that the system default has been overridden for this attribute:

```
# lsattr -E -l en0
alias4                IPv4 Alias including Subnet Mask          True
alias6                IPv6 Alias including Prefix Length        True
arp                   on Address Resolution Protocol (ARP)       True
authority             Authorized Users                          True
broadcast             Broadcast Address                          True
mtu                   1500 Maximum IP Packet Size for This Device   True
netaddr               192.0.0.1 Internet Address                    True
netaddr6              IPv6 Internet Address                     True
netmask               255.255.255.0 Subnet Mask                 True
prefixlen             Prefix Length for IPv6 Internet Address   True
remmtu                576 Maximum IP Packet Size for REMOTE Networks True
rfc1323               Enable/Disable TCP RFC 1323 Window Scaling True
security              none Security Level                       True
state                 up Current Interface Status                True
tcp_mssdfmt          Set TCP Maximum Segment Size              True
tcp_nodelay           Enable/Disable TCP_NODELAY Option         True
tcp_recvspace         Set Socket Buffer Space for Receiving      True
tcp_sendspace 65536   Set Socket Buffer Space for Sending       True
```

Modifying the ISNO options with the **chdev** and **ifconfig** commands

You can use the following commands to first verify system and interface support and then to set and verify the new values.

- Make sure the **use_isno** option is enabled by using the following command:

```
# no -a | grep isno
use_isno = 1
```

- Make sure the interface supports the five new ISNOs by using the **lsattr -EI** command:

```
# lsattr -E -l en0 -H
attribute          value description          user_settable
:
rfc1323            Enable/Disable TCP RFC 1323 Window Scaling True
tcp_mssdfmt        Set TCP Maximum Segment Size          True
tcp_nodelay        Enable/Disable TCP_NODELAY Option      True
tcp_recvspace      Set Socket Buffer Space for Receiving   True
tcp_sendspace      Set Socket Buffer Space for Sending     True
```

- Set the interface-specific values, using either the **ifconfig** or **chdev** command. The **ifconfig** command sets values temporarily (best used for testing). The **chdev** command alters the ODM, so custom values return after system reboots.

For example, to set the **tcp_recvspace** and **tcp_sendspace** to 64 KB and enable **tcp_nodelay**, use one of the following methods:

```
# ifconfig en0 tcp_recvspace 65536 tcp_sendspace 65536 tcp_nodelay 1
```

or

```
# chdev -l en0 -a tcp_recvspace=65536 -a tcp_sendspace=65536 -a tcp_nodelay=1
```

- Verify the settings using the **ifconfig** or **lsattr** command:

```
# ifconfig en0
en0: flags=5e080863,c0<UP,BROADCAST,NOTRAILERS,RUNNING,SIMPLEX,MULTICAST,GROUPRT,64BIT,CHECKSUM_OFFLOAD,PSEG,CHAIN>
      inet 9.19.161.100 netmask 0xfffff00 broadcast 9.19.161.255
      tcp_sendspace 65536 tcp_recvspace 65536 tcp_nodelay 1
```

or

```
# lsattr -El en0
rfc1323          Enable/Disable TCP RFC 1323 Window Scaling True
tcp_mssdf1t     Set TCP Maximum Segment Size True
tcp_nodelay     1      Enable/Disable TCP_NODELAY Option True
tcp_recvspace   65536 Set Socket Buffer Space for Receiving True
tcp_sendspace   65536 Set Socket Buffer Space for Sending True
```

TCP workload tuning

There are several AIX tunable values that might impact TCP performance. Many applications use the reliable Transport Control Protocol (TCP), including the **ftp** and **rcp** commands.

Note: The **no -o** command warns you that when you change tuning options that affect TCP/IP connections, the changes are only effective for connections that are established after the changes are made. In addition, the **no -o** command restarts the **inetd** daemon process when options are changed that might affect processes for which the **inetd** daemon is listening for new connections.

TCP streaming workload tuning

Streaming workloads move large amounts of data from one endpoint to the other endpoint. Examples of streaming workloads are file transfer, backup or restore workloads, or bulk data transfer. The main metric of interest in these workloads is bandwidth, but you can also look at end-to-end latency.

The primary tunables that affect TCP performance for streaming applications are the following:

- **tcp_recvspace**
- **tcp_sendspace**
- **rfc1323**
- **MTU path discovery**
- **tcp_nodelayack**
- **sb_max**
- Adapter options, such as checksum offload and TCP Large Send

The following table shows suggested sizes for the tunable values to obtain optimal performance, based on the type of adapter and the MTU size:

| Device | Speed | MTU size | tcp_sendspace | tcp_recvspace | sb_max ¹ | rfc1323 |
|------------|--------------|----------|---------------|---------------------|---------------------|---------|
| Token Ring | 4 or 16 Mbit | 1492 | 16384 | 16384 | 32768 | 0 |
| Ethernet | 10 Mbit | 1500 | 16384 | 16384 | 32768 | 0 |
| Ethernet | 100 Mbit | 1500 | 16384 | 16384 | 65536 | 0 |
| Ethernet | Gigabit | 1500 | 131072 | 65536 | 131072 | 0 |
| Ethernet | Gigabit | 9000 | 131072 | 65535 | 262144 | 0 |
| Ethernet | Gigabit | 9000 | 262144 | 131072 ² | 524288 | 1 |
| ATM | 155 Mbit | 1500 | 16384 | 16384 | 131072 | 0 |
| ATM | 155 Mbit | 9180 | 65535 | 65535 ³ | 131072 | 0 |

| | | | | | | |
|---------------|-----------|-------|--------|---------------------|---------|---|
| ATM | 155 Mbit | 65527 | 655360 | 655360 ⁴ | 1310720 | 1 |
| FDDI | 100 Mbit | 4352 | 45056 | 45056 | 90012 | 0 |
| Fiber Channel | 2 Gigabit | 65280 | 655360 | 655360 | 1310720 | 1 |

Notes:

1. It is suggested to use the default value of 1048576 for the **sb_max** tunable. The values shown in the table are acceptable minimum values for the **sb_max** tunable.
2. Performance is slightly better when using these options, with **rfc1323** enabled, on jumbo frames on Gigabit Ethernet
3. Certain combinations of TCP send and receive space will result in very low throughput, (1 Mbit or less). To avoid this problem, set the **tcp_sendspace** tunable to a minimum of 3 times the MTU size or greater or equal to the receiver's **tcp_recvspace** value.
4. TCP has only a 16-bit value to use for its window size. This translates to a maximum window size of 65536 bytes. For adapters that have large MTU sizes (for example 32 KB or 64 KB), TCP streaming performance might be very poor. For example, on a device with a 64 KB MTU size, and with a **tcp_recvspace** set to 64 KB, TCP can only send one packet and then its window closes. It must wait for an ACK back from the receiver before it can send again. This problem can be solved in two ways:
 - One option is to enable **rfc1323**, which enhances TCP and allows it to overcome the 16-bit limit so that it can use a window size larger than 64 KB. You can then set the **tcp_recvspace** tunable to a large value, such as 10 times the MTU size, which allows TCP to stream data and thus provides good performance.
 - The second option is to reduce the MTU size of the adapter. For example, use the **ifconfig at0 mtu 16384** command to set the ATM MTU size to 16 KB. This causes TCP to compute a smaller MSS value. With a 16 KB MTU size, TCP can send 4 packets for a 64 KB window size.

The following are general guidelines for tuning TCP streaming workloads:

- Set the TCP send and receive space to at least 10 times the MTU size.
- You should enable **rfc1323** when MTU sizes are above 8 KB to allow larger TCP receive space values.
- For high speed adapters, larger TCP send and receive space values help performance.
- For high speed adapters, the **tcp_sendspace** tunable value should be 2 times the value of **tcp_recvspace**.

The **ftp** and **rnp** commands are examples of TCP applications that benefit from tuning the **tcp_sendspace** and **tcp_recvspace** tunables.

The tcp_recvspace tunable: The **tcp_recvspace** tunable specifies how many bytes of data the receiving system can buffer in the kernel on the receiving sockets queue. The **tcp_recvspace** tunable is also used by the TCP protocol to set the TCP window size, which TCP uses to limit how many bytes of data it will send to the receiver to ensure that the receiver has enough space to buffer the data. The **tcp_recvspace** tunable is a key parameter for TCP performance because TCP must be able to transmit multiple packets into the network to ensure the network pipeline is full. If TCP can not keep enough packets in the pipeline, then performance suffers.

You can set the **tcp_recvspace** tunable using the following methods:

- The **setsockopt()** system call from a program
- The **no -o tcp_recvspace=[value]** command
- The **tcp_recvspace** ISNO parameter

A common guideline for the **tcp_recvspace** tunable is to set it to a value that is at least 10 times less than the MTU size. You can determine the **tcp_recvspace** tunable value by dividing the **bandwidth-delay product** value by 8, which is computed with the following formula:

$$\text{bandwidth-delay product} = \text{capacity(bits)} = \text{bandwidth(bits/second)} \times \text{round-trip time (seconds)}$$

Dividing the capacity value by 8 provides a good estimate of the TCP window size needed to keep the network pipeline full. The longer the round-trip delay and the faster the network speed, the larger the **bandwidth-delay product** value, and thus the larger the TCP window. An example of this is a 100 Mbit network with a round trip time of 0.2 milliseconds. You can calculate the **bandwidth-delay product** value with the formula above:

```
bandwidth-delay product = 100000000 x 0.0002 = 20000  
20000/8 = 2500
```

Thus, in this example, the TCP window size needs to be at least 2500 bytes. On 100 Mbit and Gigabit Ethernet on a single LAN, you might want to set the **tcp_recvspace** and **tcp_sendspace** tunable values to at least 2 or 3 times the computed **bandwidth-delay product** value for best performance.

The tcp_sendspace tunable: The **tcp_sendspace** tunable specifies how much data the sending application can buffer in the kernel before the application is blocked on a send call. The TCP-socket send buffer is used to buffer the application data in the kernel using mbufs/clusters before it is sent to the receiver by the TCP protocol. The default size of the send buffer is specified by the **tcp_sendspace** tunable value or the program can use the **setsockopt()** subroutine to override it.

You should set the **tcp_sendspace** tunable value at least as large as the **tcp_recvspace** value, and for higher speed adapters, the **tcp_sendspace** value should be at least twice the size of the **tcp_recvspace** value.

If an application specifies O_NDELAY or O_NONBLOCK on the socket, which leads to nonblocking I/O, then if the send buffer fills up, the application will return with an EWOULDBLOCK/EAGAIN error rather than being put to sleep. Applications must be coded to handle this error (suggested solution is to sleep for a short while and try to send again).

The rfc1323 tunable: The **rfc1323** tunable enables the TCP window scaling option. The TCP window scaling option is a TCP negotiated option, so it must be enabled on both endpoints of the TCP connection to take effect. By default, the TCP window size is limited to 65536 bytes (64 K) but can be set higher if the **rfc1323** value is set to 1. If you are setting the **tcp_recvspace** value to greater than 65536, set the **rfc1323** value to 1 on each side of the connection. If you do not set the **rfc1323** value on both sides of the connection, the effective value for the **tcp_recvspace** tunable will be 65536. This option adds 12 more bytes to the TCP protocol header, which deducts from the user payload data, so on small MTU adapters this option might slightly hurt performance.

If you are sending data through adapters that have large MTU sizes (32 K or 64 K for example), TCP streaming performance might not be optimal unless this option is enabled because a single packet will consume the entire TCP window size. Therefore, TCP is unable to stream multiple packets as it will have to wait for a TCP acknowledgment and window update from the receiver for each packet. By enabling the **rfc1323** option using the command **no -o rfc1323=1**, TCP's window size can be set as high as 4 GB. After setting the **rfc1323** option to 1, you can increase the **tcp_recvspace** parameter to something much larger, such as 10 times the size of the MTU.

If the sending and receiving system do not support the **rfc1323** option, then reducing the MTU size is one way to enhance streaming performance for large MTU adapters. For example, instead of using a MTU size of 65536, which limits TCP to only one outstanding packet, selecting a smaller MTU size of 16384 allows TCP to have 4 packets outstanding with a **tcp_recvspace** value of 65536 bytes, which improves performance. However, all nodes on the network need to use the same MTU size.

TCP path MTU discovery: In AIX, the TCP path MTU discovery option is enabled by default. The **tcp_pmtu_discover** network tunable controls this option. The TCP path MTU discovery option allows TCP to determine the minimum MTU size on a network that is in the path between any two hosts for a TCP connection and relieves you from setting up MTU sizes for each route in a network.

The network MTU size affects network performance. If a network with a small MTU size is inserted between two networks with a larger MTU size, then TCP traffic goes across the network using the MTU size of the smallest network. For example, if two SP switch networks with MTU sizes of 64 KB are interconnected by an Ethernet with a MTU size of 1500 bytes, then TCP traffic between the two SP networks will be done with a maximum size packet of 1500 bytes.

If you disable the TCP path MTU discovery option, by setting the **tcp_pmtu_discover** tunable to 0, you must set the MTU size for each route for static routes or tune the **tcp_mssdflt** parameter in the global **no** command options or set the **tcp_mssdflt** parameter in the ISNO options for each adapter.

The *tcp_nodelayack* tunable: The **tcp_nodelayack** option prompts TCP to send an immediate acknowledgement, rather than the usual 200 ms delay. Sending an immediate acknowledgement might add a little more overhead, but in some cases, greatly improves performance.

Performance problems have been seen when TCP delays sending an acknowledgement for 200 ms, because the sender is waiting on an acknowledgment from the receiver and the receiver is waiting on more data from the sender. This might result in low streaming throughput. If you suspect this problem, you should enable the **tcp_nodelayack** option to see if it improves the streaming performance. If it does not, disable the **tcp_nodelayack** option.

The *sb_max* tunable: The **sb_max** tunable sets an upper limit on the number of socket buffers queued to an individual socket, which controls how much buffer space is consumed by buffers that are queued to a sender's socket or to a receiver's socket. The system accounts for socket buffers used based on the size of the buffer, not on the contents of the buffer.

If a device driver puts 100 bytes of data into a 2048-byte buffer, the system considers 2048 bytes of socket buffer space to be used. It is common for device drivers to receive buffers into a buffer that is large enough to receive the adapters maximum size packet. This often results in wasted buffer space but it would require more CPU cycles to copy the data to smaller buffers.

Note: In AIX, the default value for the **sb_max** tunable is 1048576, which is large. You should not change this value unless there is a need to conserve kernel mbuf memory, for example on a 32 bit kernel. See the table above for suggested **sb_max** values if you want to change this parameter.

TCP request/response workload tuning

TCP request/response workloads are workloads that involve a two-way exchange of information. Examples of request/response workloads are Remote Procedure Call (RPC) types of applications or client/server applications, like web browser requests to a web server, NFS file systems (that use TCP for the transport protocol), or a database's lock management protocol. Such request are often small messages and larger responses, but might also be large requests and a small response.

The primary metric of interest in these workloads is the round-trip latency of the network. Many of these requests or responses use small messages, so the network bandwidth is not a major consideration.

Hardware has a major impact on latency. For example, the type of network, the type and performance of any network switches or routers, the speed of the processors used in each node of the network, the adapter and bus latencies all impact the round-trip time.

Tuning options to provide minimum latency (best response) typically cause higher CPU overhead as the system sends more packets, gets more interrupts, etc. in order to minimize latency and response time. These are classic performance trade-offs.

Primary tunables for request/response applications are the following:

- **tcp_nodelay** or **tcp_nagle_limit**
- **tcp_nodelayack**

- Adapter interrupt coalescing settings

Note: Some request/response workloads involve large amounts of data in one direction. Such workloads might need to be tuned for a combination of streaming and latency, depending on the workload.

The `tcp_nodelay` or `tcp_nagle_limit` options

In AIX, the `TCP_NODELAY` socket option is disabled by default, which might cause large delays for request/response workloads, that might only send a few bytes and then wait for a response. TCP implements delayed acknowledgments, as it expects to piggy back a TCP acknowledgment on a response packet. The delay is normally 200 ms.

Most TCP implementations implement the nagle algorithm, where a TCP connection can only have one outstanding small segment that has not yet been acknowledged. This causes TCP to delay sending any more packets until it receives an acknowledgement or until it can bundle up more data and send a full size segment.

Applications that use request/response workloads should use the `setsockopt()` call to enable the `TCP_NODELAY` option. For example, the `telnet` and `rlogin` utilities, Network File System (NFS), and web servers, already use the `TCP_NODELAY` option to disable nagle. However, some applications do not do this, which might result in poor performance depending on the network MTU size and the size of the sends (writes) to the socket.

When dealing with applications that do not enable `TCP_NODELAY`, you can use the following tuning options to disable nagle:

- `tcp_nagle_limit`
- The `tcp_nodelay` ISNO option
- `tcp_nodelayack`
- `fasttimo`
- Interrupt coalescing on the adapter

The `tcp_nagle_limit` option: The `tcp_nagle_limit` network option is a global network option and is set to 65536 by default. TCP disables the nagle algorithm for segments equal or larger than this value so you can tune the threshold at which nagle is enabled. For example, to totally disable nagle, set the `tcp_nagle_limit` value to 1. To allow TCP to bundle up sends and send packets that are at least 256 bytes, set the `tcp_nagle_limit` value to 256.

The `tcp_nodelay ISNO` option: At the interface level, there is a `tcp_nodelay` ISNO option to enable `TCP_NODELAY`. Setting the `tcp_nodelay` value to 1 causes TCP to not delay, which disables nagle, and send each packet for each application send or write.

The `tcp_nodelayack` option: You can use the `tcp_nodelayack` network option to disable the delayed acknowledgement, typically the 200 ms timer. Not delaying the acknowledgement can reduce latency and allow the sender (which may have nagle enabled) to receive the acknowledgement and thus send the next partial segment sooner.

The `fasttimo` option: You can use the `fasttimo` network option to reduce the 200 ms timer, which is the default, down to 100 or 50 ms. Because TCP uses this timer for other functions that it does for all open TCP connections, reducing this timer adds more overhead to the system because all the TCP connections have to be scanned more often. The above options are the best choices and you should only use the `fasttimo` option as a last resort in tuning a system.

Interrupt coalescing: For low latency applications, you should disable interrupt coalescing on the adapter if it supports this feature. See “Interrupt avoidance” on page 232 and “Interrupt coalescing” on page 233 for more information.

UDP tuning

User Datagram Protocol (UDP) is a datagram protocol that is used by Network File System (NFS), name server (named), Trivial File Transfer Protocol (TFTP), and other special purpose protocols.

Since UDP is a datagram protocol, the entire message (datagram) must be copied into the kernel on a send operation as one atomic operation. The datagram is also received as one complete message on the **recv** or **recvfrom** system call. You must set the **udp_sendspace** and **udp_recvspace** parameters to handle the buffering requirements on a per-socket basis.

The largest UDP datagram that can be sent is 64 KB, minus the UDP header size (8 bytes) and the IP header size (20 bytes for IPv4 or 40 bytes for IPv6 headers).

The following tunables affect UDP performance:

- **udp_sendspace**
- **udp_recvspace**
- UDP packet chaining
- Adapter options, like interrupt coalescing

The **udp_sendspace** tunable

Set the **udp_sendspace** tunable value to a value that is equal to or greater than the largest UDP datagram that will be sent. For simplicity, set this parameter to 65536, which is large enough to handle the largest possible UDP packet. There is no advantage to setting this value larger.

The **udp_recvspace** tunable

The **udp_recvspace** tunable controls the amount of space for incoming data that is queued on each UDP socket. Once the **udp_recvspace** limit is reached for a socket, incoming packets are discarded. The statistics of the discarded packets are detailed in the **netstat -p udp** command output under the **socket buffer overflows** column. For more information, see *The netstat command in AIX 5L Version 5.3 Commands Reference, Volume 4*.

You should set the value for the **udp_recvspace** tunable high due to the fact that multiple UDP datagrams might arrive and wait on a socket for the application to read them. Also, many UDP applications use a particular socket to receive packets. This socket is used to receive packets from all clients talking to the server application. Therefore, the receive space needs to be large enough to handle a burst of datagrams that might arrive from multiple clients, and be queued on the socket, waiting to be read. If this value is too low, incoming packets are discarded and the sender has to retransmit the packet. This might cause poor performance.

Because the communication subsystem accounts for buffers used, and not the contents of the buffers, you must account for this when setting **udp_recvspace**. For example, an 8 KB datagram would be fragmented into 6 packets which would use 6 receive buffers. These will be 2048 byte buffers for Ethernet. So, the total amount of socket buffer consumed by this one 8 KB datagram is as follows:

$6 * 2048 = 12,288$ bytes

Thus, you can see that the **udp_recvspace** must be adjusted higher depending on how efficient the incoming buffering is. This will vary by datagram size and by device driver. Sending a 64 byte datagram would consume a 2 KB buffer for each 64 byte datagram.

Then, you must account for the number of datagrams that may be queued onto this one socket. For example, NFS server receives UDP packets at one well-known socket from all clients. If the queue depth of this socket could be 30 packets, then you would use $30 * 12,288 = 368,640$ for the **udp_recvspace** if NFS is using 8 KB datagrams. NFS Version 3 allows up to 32 KB datagrams.

A suggested starting value for **udp_recvspace** is 10 times the value of **udp_sendspace**, because UDP may not be able to pass a packet to the application before another one arrives. Also, several nodes can send to one node at the same time. To provide some staging space, this size is set to allow 10 packets to be staged before subsequent packets are discarded. For large parallel applications using UDP, the value may have to be increased.

Note: The value of **sb_max**, which specifies the maximum socket buffer size for any socket buffer, should be at least twice the size of the largest of the UDP and TCP send and receive buffers.

UDP packet chaining

When UDP Datagrams to be transmitted are larger than the adapters MTU size, the IP protocol layer will fragment the datagram into MTU size fragments. Ethernet interfaces include a UPD packet chaining feature. This feature is enabled by default in AIX

UDP packet chaining causes IP to build the entire chain of fragments and pass that chain down to the Ethernet device driver in one call. This improves performance by reducing the calls down through the ARP and interface layers and to the driver. This also reduces **lock** and **unlock** calls in SMP environment. It also helps the cache affinity of the code loops. These changes reduce the CPU utilization of the sender.

You can view the UDP packet chaining option with the **ifconfig** command. The following example shows the **ifconfig** command output for the en0 interface, where the CHAIN flag indicates that packet chaining is enabled:

```
# ifconfig en0
en0: flags=5e080863,80<UP,BROADCAST,NOTRAILERS,RUNNING,SIMPLEX,MULTICAST,GROUPRT,64BIT,CHECKSUM_OFFLOAD,PSEG,CHAIN>
    inet 192.1.6.1 netmask 0xffffffff broadcast 192.1.6.255
    tcp_sendspace 65536 tcp_recvspace 65536 tcp_nodelay 1
```

Packet chaining can be disabled by the following command:

```
# ifconfig en0 -pktchain

# ifconfig en0
en0: flags=5e080863,80<UP,BROADCAST,NOTRAILERS,RUNNING,SIMPLEX,MULTICAST,GROUPRT,64BIT,CHECKSUM_OFFLOAD,PSEG>
    inet 192.1.6.1 netmask 0xffffffff broadcast 192.1.6.255
    tcp_sendspace 65536 tcp_recvspace 65536 tcp_nodelay 1
```

Packet chaining can be re-enabled with the following command:

```
# ifconfig en0 pktchain

# ifconfig en0
en0: flags=5e080863,80<UP,BROADCAST,NOTRAILERS,RUNNING,SIMPLEX,MULTICAST,GROUPRT,64BIT,CHECKSUM_OFFLOAD,PSEG,CHAIN>
    inet 192.1.6.1 netmask 0xffffffff broadcast 192.1.6.255
    tcp_sendspace 65536 tcp_recvspace 65536 tcp_nodelay 1
```

Adapter offload options

Some adapters offer options that can be enabled or disabled that will offload work from the AIX system onto the adapter. The following table shows which adapters offer what options and the system default settings:

| Adapter Type | Feature Code | TCP Checksum Offload | Default Setting | TCP Large Send | Default Setting |
|---------------------------------|--------------|----------------------|-----------------|----------------|-----------------|
| GigE, PCI, SX & TX | 2969, 2975 | Yes | OFF | Yes | OFF |
| GigE, PCI-X, SX and TX | 5700, 5701 | Yes | ON | Yes | ON |
| GigE dual port PCI-X, TX and SX | 5706, 5707 | Yes | ON | Yes | ON |
| 10/100 Ethernet | 4962 | Yes | ON | Yes | OFF |
| ATM 155, UTP & MMF | 4953, 4957 | Yes (transmit only) | ON | No | N/A |
| ATM 622, MMF | 2946 | Yes | ON | No | N/A |

TCP checksum offload

The TCP checksum offload option enables the network adapter to compute the TCP checksum on transmit and receive, which saves the AIX host CPU from having to compute the checksum. The savings vary by packet size. Small packets have little or no savings with this option, while large packets have larger savings. On the PCI-X GigE adapters, the savings for MTU 1500 are typically about 5% reduction in CPU utilization, and for MTU 9000 (Jumbo Frames) the savings is approximately a 15% reduction in CPU utilization.

TCP streaming throughput with MTU 1500 is slower on machines that have processors faster than 400 MHz if the TCP checksum offload option is enabled because the host system can run the checksum faster than the Gigabit Ethernet PCI adapters, FC2969 and FC 2975. Therefore, by default, this option is off on these adapters. When these adapters use jumbo frames, it can run at wire speed even when it has to compute the checksum.

The PCI-X Gigabit Ethernet adapters can run at wire speeds with the TCP checksum offload option enabled and it reduces host CPU processing so it is enabled by default.

TCP large send offload

The TCP large send offload option allows the AIX TCP layer to build a TCP message up to 64 KB long and send it in one call down the stack through IP and the Ethernet device driver. The adapter then resegments the message into multiple TCP frames to transmit on the wire. The TCP packets sent on the wire are either 1500 byte frames for a MTU of 1500 or up to 9000 byte frames for a MTU of 9000 (jumbo frames).

With the TCP large send offload option, you can see that the adapter does a large amount of kernel processing. For example, to send 64 KB of data, it takes 44 calls down the stack, using 1500 byte packets. With the TCP large send option, you can do this with one call down the stack, which reduces host processing and results in lower CPU utilization on the host CPU. The savings varies depending on the average TCP large send size. For example, you can see a reduction of host CPU by 60 to 75% with the PCI-X GigE adapters with a MTU size of 1500. For jumbo frames, the savings are less because the system already sends larger frames. For example, you can see a reduction of host CPU by 40% with jumbo frames.

The first generation Gigabit Ethernet PCI adapters (FC2969 and FC 2975) support the TCP large send offload option. If your primary concern is lower host CPU utilization, use this option. However, for best raw throughput, you should not enable this option because the data rate on the wire is slower with this option enabled.

With the PCI-X GigE adapters, using the TCP large send offload option results in best raw throughput and in lowest host CPU utilization and is therefore enabled by default.

Interrupt avoidance

Interrupt handling is expensive in terms of host CPU cycles. To handle an interrupt, the system must save its prior machine state, determine where the interrupt is coming from, perform various housekeeping tasks, and call the proper device driver interrupt handler. The device driver typically performs high overhead operations like reading the interrupt status register on the adapter, which is slow compared to machine speed, take SMP locks, get and free buffers, etc.

Most AIX device drivers do not use transmit complete interrupts, which avoids interrupts for transmitting packets. Transmit complete processing is typically handled on the next transmit operation, thus avoiding a separate transmission complete interrupt. You can use the commands like the **netstat -v**, **entstat**, **atmstat**, or **fddistat** commands to view the status of the transmitted and received packet counts and the transmitted and received interrupt counts. From the statistics, you can clearly see that the transmit interrupts are avoided. Some third party adapters and drivers might not follow this convention.

Interrupt coalescing

For receive operations, interrupts typically inform the host CPU that packets have arrived on the device's input queue. Without some form of interrupt moderation logic on the adapter, this might lead to an interrupt for each incoming packet. However, as the incoming packet rate increases, the device driver finishes processing one packet and checks to see if any more packets are on the receive queue before exiting the driver and clearing the interrupt. The driver then finds that there are more packets to handle and ends up handling multiple packets per interrupt as the packet rate increases, which means that the system gets more efficient as the load increases.

However, some adapters provide additional features that can provide even more control on when receive interrupts are generated. This is often called interrupt coalescing or interrupt moderation logic, which allows several packets to be received and to generate one interrupt for several packets. A timer starts when the first packet arrives, and then the interrupt is delayed for n microseconds or until m packets arrive. The methods vary by adapter and by which of the features the device driver allows the user to control.

Under light loads, interrupt coalescing adds latency to the packet arrival time. The packet is in host memory, but the host is not aware of the packet until some time later. However, under higher packet loads, the system performs more efficiently by using fewer CPU cycles because fewer interrupts are generated and the host processes several packets per interrupt.

For AIX adapters that include the interrupt moderation feature, you should set the values to a moderate level to reduce the interrupt overhead without adding large amounts of latency. For applications that might need minimum latency, you should disable or change the options to allow more interrupts per second for lower latency.

The Gigabit Ethernet adapters offer the interrupt moderation features. The FC 2969 and FC 2975 GigE PCI adapters provide a delay value and a buffer count method. The adapter starts a timer when the first packet arrives and then an interrupt occurs either when the timer expires or when n buffers in the host have been used.

The FC 5700, FC 5701, FC 5706, and FC 5707 GigE PCI-X adapters use the interrupt throttle rate method. The interrupt throttle rate method generates interrupts at a specified frequency, which allows for the bunching of packets based on time. The default interrupt rate is 10000 interrupts per second. For lower interrupt overhead, you can set the interrupt rate to a minimum of 2000 interrupts per second. For workloads that call for lower latency and faster response time, you can set the interrupt rate to a maximum of 20000 interrupts. Setting the interrupt rate to 0 disables the interrupt throttle completely.

Enabling thread usage on LAN adapters (dog threads)

Drivers, by default, call IP directly, which calls up the protocol stack to the socket level while running on the interrupt level. This minimizes instruction path length, but increases the interrupt hold time. On an SMP system, a single CPU can become the bottleneck for receiving packets from a fast adapter. By enabling the *dog threads* feature, the driver queues the incoming packet to the thread and the thread handles calling IP, TCP, and the socket code. The thread can run on other CPUs which might be idle. Enabling the dog threads can increase capacity of the system in some cases, where the incoming packet rate is high, allowing incoming packets to be processed in parallel by multiple CPUs.

The down side of the dog threads feature is that it increases latency under light loads and also increases host CPU utilization because a packet has to be queued to a thread and the thread has to be dispatched.

Note: This feature is not supported on uniprocessors, because it would only add path length and slow down performance.

This is a feature for the input side (receive) of LAN adapters. It can be configured at the interface level with the **ifconfig** command (**ifconfig interface thread** or **ifconfig interface hostname up thread**).

To disable the feature, use the **ifconfig interface -thread** command, as in the following example:

```
# ifconfig en0 thread

# ifconfig en0
en0: flags=5e080863,e0<UP,BROADCAST,NOTRAILERS,RUNNING,SIMPLEX,MULTICAST,GROUPRT,64BIT,CHECKSUM_OFFLOAD,PSEG,THREAD,CHAIN>
    inet 192.1.0.1 netmask 0xfffff00 broadcast 192.1.0.255

# ifconfig en0 -thread

# ifconfig en0
en0: flags=5e080863,c0<UP,BROADCAST,NOTRAILERS,RUNNING,SIMPLEX,MULTICAST,GROUPRT,64BIT,CHECKSUM_OFFLOAD,PSEG,THREAD,CHAIN>
    inet 192.1.0.1 netmask 0xfffff00 broadcast 192.1.0.255
```

The **netstat -s** command also displays some counters to show the number of packets processed by threads and if the thread queues dropped any incoming packets. The following is an example of the **netstat -s** command:

```
# netstat -s | grep hread

    352 packets processed by threads
    0 packets dropped by threads
```

Guidelines when considering using dog threads are as follows:

- More CPUs than adapters need to be installed. Typically, at least two times more CPUs than adapters are recommended.
- Systems with faster CPUs benefit less. Machines with slower CPU speed may be helped the most.
- This feature is most likely to enhance performance when there is high input packet rate. It will enhance performance more on MTU 1500 compared to MTU 9000 (jumbo frames) on Gigabit as the packet rate will be higher on small MTU networks.

The dog threads run best when they find more work on their queue and do not have to go back to sleep (waiting for input). This saves the overhead of the driver waking up the thread and the system dispatching the thread.

- The dog threads can also reduce the amount of time a specific CPU spends with interrupts masked. This can release a CPU to resume typical user-level work sooner.
- The dog threads can also reduce performance by about 10 percent if the packet rate is not fast enough to allow the thread to keep running. The 10 percent is an average amount of increased CPU overhead needed to schedule and dispatch the threads.

Tuning adapter resources

Due to the wide range of adapters and drivers, it is difficult to discuss all types of adapter attributes. The following information focuses on the common attributes that most network adapters and drivers have that can affect system performance.

Most communication drivers provide a set of tunable parameters to control transmit and receive resources. These parameters typically control the transmit queue and receive queue limits, but may also control the number and size of buffers or other resources. These parameters limit the number of buffers or packets that may be queued for transmit or limit the number of receive buffers that are available for receiving packets. These parameters can be tuned to ensure enough queueing at the adapter level to handle the peak loads generated by the system or the network.

Following are some general guidelines:

- To display detailed information about the adapter resources and any errors that might occur, use the following commands, depending on which adapters you use:
 - **netstat -v**
 - **entstat**
 - **atmstat**
 - **fddistat**

- tokstat
- Monitor system error log reports using the **errpt** and **errpt -a** commands.
- Remember to only change parameters if any of the following conditions apply:
 - There is evidence indicating a resource shortage.
 - There are queue overruns.
 - Performance analysis indicates that some system tuning is required.

Transmit queues

For transmit, the device drivers may provide a *transmit queue* limit. There may be both hardware queue and software queue limits, depending on the driver and adapter. Some drivers have only a hardware queue; some have both hardware and software queues. Some drivers internally control the hardware queue and only allow the software queue limits to be modified. Generally, the device driver will queue a transmit packet directly to the adapter hardware queue. If the system CPU is fast relative to the speed of the network, or on an SMP system, the system may produce transmit packets faster than they can be transmitted on the network. This will cause the hardware queue to fill. After the hardware queue is full, some drivers provide a software queue and they will then queue to the software queue. If the software transmit queue limit is reached, then the transmit packets are discarded. This can affect performance because the upper-level protocols must then time out and retransmit the packet. At some point, however, the adapter has to discard packets as providing too much space can result in stale packets being sent, for example.

Following are examples of PCI adapter transmit queue sizes:

| Adapter Type | Feature Code | ODM attribute | Default value | Range |
|--------------------------------------|------------------------|---------------|---------------|-----------|
| IBM 10/100 Mbps Ethernet PCI Adapter | 2968 | tx_que_size | 8192 | 16-16384 |
| 10/100 Mbps Ethernet Adapter II | 4962 | tx_que_sz | 8192 | 512-16384 |
| Gigabit Ethernet PCI (SX or TX) | 2969, 2975 | tx_que_size | 8192 | 512-16384 |
| Gigabit Ethernet PCI (SX or TX) | 5700, 5701, 5706, 5707 | tx_que_sz | 8192 | 512-16384 |
| ATM 155 (MMF or UTP) | 4953, 4957 | sw_txq_size | 2048 | 50-16384 |
| ATM 622 (MMF) | 2946 | sw_txq_size | 2048 | 128-32768 |
| FDDI | 2741, 2742, 2743 | tx_queue_size | 256 | 3-2048 |

For adapters that provide hardware queue limits, changing these values will cause more real memory to be consumed on receives because of the associated control blocks and buffers associated with them. Therefore, raise these limits only if needed or for larger systems where the increase in memory use is negligible. For the software transmit queue limits, increasing these limits does not increase memory usage. It only allows packets to be queued that were already allocated by the higher layer protocols.

Transmit descriptors

Some drivers allow you to tune the size of the transmit ring or the number of transmit descriptors. The hardware transmit queue controls the maximum number of buffers that can be queued to the adapter for concurrent transmission. One descriptor typically only points to one buffer and a message might be sent in multiple buffers. Many drivers do not allow you to change the parameters.

| Adapter type | Feature code | ODM attribute | Default value | Range |
|----------------------------------|-----------------------|---------------|---------------|---------------------------|
| Gigabit Ethernet PCI-X, SX or TX | 5700, 5701, 5706, 507 | txdesc_que_sz | 512 | 128-1024, multiple of 128 |

Receive resources

Some adapters allow you to configure the number of resources used for receiving packets from the network. This might include the number of receive buffers (and even their size) or the number of DMA receive descriptors. Some drivers have multiple receive buffer pools with buffers of different sizes that might need to be tuned for different workloads. Some drivers manage these resources internal to the driver and do not allow you to change them.

The receive resources might need to be increased to handle peak bursts on the network. The network interface device driver places incoming packets on a receive queue. If the receive descriptor list or ring is full, or no buffers are available, packets are dropped, resulting in the sender needing to retransmit. The receive descriptor queue is tunable using the **SMIT** tool or **chdev** command (see How to change the parameters). The maximum queue size is specified to each type of communication adapter and can normally be seen using the **F4** or **List** key in the **SMIT** tool.

| Adapter Type | Feature Code | ODM attribute | Default value | Range |
|--------------------------------------|------------------------|------------------|------------------|---------------------|
| IBM 10/100 Mbps Ethernet PCI Adapter | 2968 | rx_que_size | 256 | 16, 32 ,64, 128, 26 |
| | | rx_buf_pool_size | 384 | 16-2048 |
| 10/100 Mbps Ethernet PCI Adapter II | 4962 | rx_desc_que_sz | 512 | 100-1024 |
| | | rxbuf_pool_sz | 1024 | 512-2048 |
| Gigabit Ethernet PCI (SX or TX) | 2969, 2975 | rx_queue_size | 512 | 512 (fixed) |
| Gigabit Ethernet PCI-X (SX or TX) | 5700, 5701, 5706, 5707 | rxdesc_que_sz | 1024 | 128-1024, by 128 |
| | | rxbuf_pool_sz | 2048 | 512-2048 |
| ATM 155 (MMF or UTP) | 4953, 4957 | rx_buf4k_min | x60 | x60-x200 (96-512) |
| ATM 622 (MMF) | 2946 | rx_buf4k_min | 256 ² | 0-4096 |
| | | rx_buf4k_max | 0 ¹ | 0-14000 |
| FDDI | 2741, 2742, 2743 | RX_buffer_cnt | 42 | 1-512 |

Notes:

1. The ATM adapter's **rx_buf4k_max** attribute is the maximum number of buffers in the receive buffer pool. When the value is set to 0, the driver assigns a number based on the amount of memory on the system. For example: (**rxbuf4k_max= thewall * 6 / 320**), but with upper limits of 9500 buffers for the ATM 155 adapter and 16360 buffers for the ATM 622 adapter. Buffers are released (down to **rx_buf4k_min**) when not needed.
2. The ATM adapter's **rx_buf4k_min** attribute is the minimum number of free buffers in the pool. The driver tries to keep only this amount of free buffers in the pool. The pool can expand up to the **rx_buf4k_max** value.

Commands to query and change the device attributes

Several status utilities can be used to show the transmit queue high-water limits and number of *no resource* or *no buffer* errors. You can use the **netstat -v** command, or go directly to the adapter statistics utilities (**entstat** for Ethernet, **tokstat** for Token-Ring, **fddistat** for FDDI, **atmstat** for ATM, and so on).

For an **entstat** example output, see The entstat command. Another method is to use the **netstat -i** utility. If it shows non-zero counts in the 0errs column for an interface, then this is typically the result of output queue overflows.

Viewing the network adapter settings

You can use the `lsattr -E -l adapter-name` command or you can use the SMIT command (`smitty commodev`) to show the adapter configuration.

Different adapters have different names for these variables. For example, they may be named `sw_txq_size`, `tx_que_size`, or `xmt_que_size` for the transmit queue parameter. The receive queue size and receive buffer pool parameters may be named `rec_que_size`, `rx_que_size`, or `rv_buf4k_min` for example.

The following is an example from the output of the `lsattr -E -l atm0` command on an IBM PCI 622 Mbps ATM adapter. The output shows the `sw_txq_size` is set to 2048 and the `rx_buf4k_min` receive buffers set to 256.

```
# lsattr -E -l atm0
adapter_clock 0          Provide SONET Clock                True
alt_addr      0x0          ALTERNATE ATM MAC address (12 hex digits) True
busintr       99          Bus Interrupt Level                 False
interface_type 0          Sonet or SDH interface             True
intr_priority 3          Interrupt Priority                  False
max_vc        1024         Maximum Number of VCs Needed       True
min_vc        64          Minimum Guaranteed VCs Supported   True
regmem        0xe0008000  Bus Memory address of Adapter Registers False
rx_buf4k_max  0          Maximum 4K-byte pre-mapped receive buffers True
rx_buf4k_min  256         Minimum 4K-byte pre-mapped receive buffers True
rx_checksum   yes         Enable Hardware Receive Checksum   True
rx_dma_mem    0x40000000  Receive bus memory address range   False
sw_txq_size   2048         Software Transmit Queue size       True
tx_dma_mem    0x20000000  Transmit bus memory address range   False
uni_vers      auto_detect  SVC UNI Version                    True
use_alt_addr  no          Enable ALTERNATE ATM MAC address   True
virtmem       0xe0000000  Bus Memory address of Adapter Virtual Memory False
```

Following is an example of the settings of a PCI-X Gigabit Ethernet adapter using the `lsattr -E -l ent0` command. This output shows the `tx_que_size` set to 8192, the `rxbuf_pool_sz` set to 2048, and the `rx_que_size` set to 1024.

```
# lsattr -E -l ent0

alt_addr      0x000000000000  Alternate ethernet address          True
busintr       163            Bus interrupt level                 False
busmem        0xc0080000     Bus memory address                  False
chksum_offload yes            Enable hardware transmit and receive checksum True
compat_mode   no             Gigabit Backward compatibility     True
copy_bytes    2048          Copy packet if this many or less bytes True
flow_ctrl     yes            Enable Transmit and Receive Flow Control True
intr_priority 3             Interrupt priority                   False
intr_rate     10000         Max rate of interrupts generated by adapter True
jumbo_frames  no            Transmit jumbo frames               True
large_send    yes            Enable hardware TX TCP resegmentation True
media_speed   Auto_Negotiation Media speed                          True
rom_mem       0xc0040000     ROM memory address                  False
rx_hog        1000          Max rcv buffers processed per rcv interrupt True
rxbuf_pool_sz 2048          Rcv buffer pool, make 2X rxdesc_que_sz True
rxdesc_que_sz 1024          Rcv descriptor queue size           True
slih_hog      10            Max Interrupt events processed per interrupt True
tx_que_sz     8192          Software transmit queue size        True
txdesc_que_sz 512           TX descriptor queue size            True
use_alt_addr  no            Enable alternate ethernet address   True
```

Changing network parameters

Whenever possible, use the **smitty** command to change network parameters. To select a particular device type, use the **smitty comdev** command. Then, select the adapter type from the list that comes up. The following is an example of the **smitty comdev** command to change the network parameters for an Ethernet adapter:

Change/Show Characteristics of an Ethernet Adapter

Type or select values in entry fields.
Press Enter AFTER making all desired changes.

```

                                     [Entry Fields]
Ethernet Adapter                    ent2
Description                        10/100/1000 Base-TX PCI-X Adapter (14106902)
Status                              Available
Location                            1V-08
Receive descriptor queue size       [1024]                                +#
Transmit descriptor queue size      [512]                                  +#
Software transmit queue size        [8192]                                 +#
Transmit jumbo frames               no                                       +
Enable hardware transmit TCP resegmentation  yes                                   +
Enable hardware transmit and receive checksum  yes                                   +
Media Speed                         Auto_Negotiation                       +
Enable ALTERNATE ETHERNET address    no                                       +
ALTERNATE ETHERNET address           [0x00000000000000]                       +
Apply change to DATABASE only        no                                       +

F1=Help          F2=Refresh          F3=Cancel          F4=List
Esc+5=Reset      Esc+6=Command      Esc+7=Edit         Esc+8=Image
Esc+9=Shell      Esc+0=Exit         Enter=Do
```

To change any of the parameter values, do the following:

1. Detach the interface by running the following command:

```
# ifconfig en0 detach
```

where *en0* represents the adapter name.
2. Use SMIT to display the adapter settings. Select **Devices -> Communications -> adapter type -> Change/Show...**
3. Move the cursor to the field you want to change, and press F4 to see the minimum and maximum ranges for the field (or the specific set of sizes that are supported).
4. Select the appropriate size, and press Enter to update the ODM database.
5. Reattach the adapter by running the following command:

```
# ifconfig en0 hostname up
```

An alternative method to change these parameter values is to run the following command:

```
# chdev -l [ifname] -a [attribute-name]=newvalue
```

For example, to change the above **tx_que_size** on *en0* to 128, use the following sequence of commands. Note that this driver only supports four different sizes, so it is better to use the SMIT command to see these values.

```
# ifconfig en0 detach
# chdev -l ent0 -a tx_que_size=128
# ifconfig en0 hostname up
```

TCP Maximum Segment Size tuning

The maximum size packets that TCP sends can have a major impact on bandwidth, because it is more efficient to send the largest possible packet size on the network. TCP controls this maximum size, known as Maximum Segment Size (MSS), for each TCP connection. For direct-attached networks, TCP computes the MSS by using the MTU size of the network interface and then subtracting the protocol headers to come up with the size of data in the TCP packet. For example, Ethernet with a MTU of 1500 would result in a MSS of 1460 after subtracting 20 bytes for IPv4 header and 20 bytes for TCP header.

The TCP protocol includes a mechanism for both ends of a connection to advertise the MSS to be used over the connection when the connection is created. Each end uses the OPTIONS field in the TCP header to advertise a proposed MSS. The MSS that is chosen is the smaller of the values provided by the two ends. If one endpoint does not provide its MSS, then 536 bytes is assumed, which is bad for performance.

The problem is that each TCP endpoint only knows the MTU of the network it is attached to. It does not know what the MTU size of other networks that might be between the two endpoints. So, TCP only knows the correct MSS if both endpoints are on the same network. Therefore, TCP handles the advertising of MSS differently depending on the network configuration, if it wants to avoid sending packets that might require IP fragmentation to go over smaller MTU networks.

The value of MSS advertised by the TCP software during connection setup depends on whether the other end is a local system on the same physical network (that is, the systems have the same network number) or whether it is on a different (remote) network.

Hosts on the same network

If the other end of the connection is on the same IP network, the MSS advertised by TCP is based on the MTU of the local network interface, as follows:

TCP MSS = MTU - TCP header size - IP header size

The TCP size is 20 bytes, the IPv4 header size is 20 bytes, and the IPv6 header size is 40 bytes.

Because this is the largest possible MSS that can be accommodated without IP fragmentation, this value is inherently optimal, so no MSS-tuning is required for local networks.

Hosts on different networks

When the other end of the connection is on a remote network, the operating system's TCP defaults to advertising an MSS that is determined with the method below. The method varies if TCP Path MTU discovery is enabled or not. If Path MTU discovery is not enabled, where **tcp_pmtu_discover=0**, TCP determines what MSS to use in the following order:

1. If the **route add** command specified a MTU size for this route, the MSS is computed from this MTU size.
2. If the **tcp_mssdfit** parameter for the ISNO is defined for the network interface being used, the **tcp_mssdfit** value is used for the MSS.
3. If neither of the above are defined, TCP uses the global **no tcp_mssdfit** tunable value. The default value for this option is 1460 bytes.

TCP path MTU discovery

The TCP path MTU discovery protocol option is enabled by default in AIX. This option is controlled by the **tcp_pmtu_discover=1** network option. This option allows the protocol stack to determine the minimum MTU size on any network that is currently in the path between two hosts.

Beginning with AIX 5.3, the implementation of TCP Path MTU discovery uses TCP packets of the connection itself rather than ICMP ECHO messages. The TCP/IP kernel extension maintains a table called the PMTU table to store related PMTU discovery information. Entries for each destination are created in the PMTU table when the TCP connections are established to that destination. The PMTU value is the outgoing interface MTU value.

TCP packets are sent with the Don't Fragment, or DF, bit set in the IP header. If a TCP packet reaches a network router that has a MTU value that is smaller than the size of the TCP packet, the router sends back an ICMP error message indicating that the message cannot be forwarded because it cannot be fragmented. If the router sending the error message complies with RFC 1191, the network's MTU value is contained in the ICMP error message. Otherwise, for the TCP packet to be retransmitted, a smaller value for the MTU size must be assigned from a table of well-known MTU values within the AIX TCP/IP kernel

extension. The PMTU value for the destination is then updated in the PMTU table with the new smaller MTU size and the TCP packet is retransmitted. Any subsequent TCP connections to that destination use the updated PMTU value.

You can use the **pmtu** command to view or delete PMTU entries. The following is an example of the **pmtu** command:

```
# pmtu display
```

| dst | gw | If | pmtu | refcnt | redisc_t | exp |
|-----------|------------|-----|------|--------|----------|-----|
| 10.10.1.3 | 10.10.1.5 | en1 | 1500 | 2 | 9 | 0 |
| 10.10.2.5 | 10.10.2.33 | en0 | 1500 | 1 | 0 | 0 |

Unused PMTU entries, which are refcnt entries with a value of 0, are deleted to prevent the PMTU table from getting too large. The unused entries are deleted **pmtu_expire** minutes after the refcnt value equals 0. The **pmtu_expire** network option has a default value of 10 minutes. To prevent PMTU entries from expiring, you can set the **pmtu_expire** value to 0.

Route cloning is unnecessary with this implementation of TCP path MTU discovery, which means the routing table is smaller and more manageable.

Static routes

You can override the default MSS value of 1460 bytes by specifying a static route to a specific remote network. Use the **-mtu** option of the **route** command to specify the MTU to that network. In this case, you would specify the actual minimum MTU of the route, rather than calculating an MSS value. For example, the following command sets the default MTU size to 1500 for a route to network 192.3.3 and the default host to get to that gateway is en0host2:

```
# route add -net 192.1.0 jack -mtu 1500
1500 net 192.3.3: gateway en0host2
```

The **netstat -r** command displays the route table and shows that the PMTU size is 1500 bytes. TCP computes the MSS from that MTU size. The following is an example of the **netstat -r** command:

```
# netstat -r
Routing tables
Destination      Gateway          Flags    Refs      Use  If    PMTU Exp Groups
-----
Route tree for Protocol Family 2 (Internet):
default          res101141       UGc      0          0  en4    -   -
ausdns01.srv.ibm res101141       UGHW     8          40  en4   1500 -
10.1.14.0        server1         UHSb     0          0  en4    -   - =>
10.1.14/24       server1         U        5         4043  en4    -   -
server1          loopback       UGHS     0          125  lo0    -   -
10.1.14.255     server1         UHSb     0          0  en4    -   -
127/8            loopback       U        2         1451769  lo0    -   -
192.1.0.0        en0host1       UHSb     0          0  en0    -   - =>
192.1.0/24       en0host1       U        4          13  en0    -   -
en0host1         loopback       UGHS     0          2  lo0    -   -
192.1.0.255     en0host1       UHSb     0          0  en0    -   -
192.1.1/24       en0host2       UGc      0          0  en0    -   -
en1host1         en0host2       UGHW     1         143474  en0   1500 -
192.3.3/24       en0host2       UGc      0          0  en0   1500 -
192.6.0/24       en0host2       UGc      0          0  en0    -   -

Route tree for Protocol Family 24 (Internet v6):
loopbackv6       loopbackv6     UH        0          0  lo0  16896 -
```

Note: The **netstat -r** command does not display the PMTU value. You can view the PMTU value with the **pmtu display** command. When you add a route for a destination with the **route add** command and you specify the MTU value, a PMTU entry is created in the PMTU table for that destination.

In a small, stable environment, this method allows precise control of MSS on a network-by-network basis. The disadvantages of this approach are as follows:

- It does not work with dynamic routing.
- It becomes impractical when the number of remote networks increases.
- Static routes must be set at both ends to ensure that both ends negotiate with a larger-than-default MSS.

Use of the **tcp_mssdfllt** option of the **no** command

The **tcp_mssdfllt** option is used to set the maximum packet size for communication with remote networks. The global **tcp_mssdfllt** option of the **no** command applies to all networks. However, for network interfaces that support the ISNO options, you can set the **tcp_mssdfllt** option on each of those interfaces. This value overrides the global **no** command value for routes using the network.

The **tcp_mssdfllt** option is the TCP MSS size, which represents the TCP data size. To compute this MSS size, take the desired network MTU size and subtract 40 bytes from it (20 for IP and 20 for TCP headers). There is no need to adjust for other protocol options as TCP handles this adjustment if other options, like the **rfc1323** option are used.

In an environment with a larger-than-default MTU, this method has the advantage in that the MSS does not need to be set on a per-network basis. The disadvantages are as follows:

- Increasing the default can lead to IP router fragmentation if the destination is on a network that is truly remote and the MTUs of the intervening networks are not known.
- The **tcp_mssdfllt** option must be set to the same value on the destination host.

Note: Beginning with AIX 5.3, you can only use the **tcp_mssdfllt** option if the **tcp_pmtu_discover** option is set to 0.

Subnetting and the **subnetsarelocal** option of the **no** command

You can use the **subnetsarelocal** option of the **no** command to control when TCP considers a remote endpoint to be local (on the same network) or remote. Several physical networks can be made to share the same network number by subnetting. The **subnetsarelocal** option specifies, on a system-wide basis, whether subnets are to be considered local or remote networks. With the **no -o subnetsarelocal=1** command, which is the default, Host A on subnet 1 considers Host B on subnet 2 to be on the same physical network.

The consequence is that when Host A and Host B establish a connection, they negotiate the MSS assuming they are on the same network. Each host advertises an MSS based on the MTU of its network interface, usually leading to an optimal MSS being chosen.

The advantages to this approach are as follows:

- It does not require any static bindings; MSS is automatically negotiated.
- It does not disable or override the TCP MSS negotiation, so that small differences in the MTU between adjacent subnets can be handled appropriately.

The disadvantages to this approach are as follows:

- Potential IP router fragmentation when two high-MTU networks are linked through a lower-MTU network. The following figure illustrates this problem.

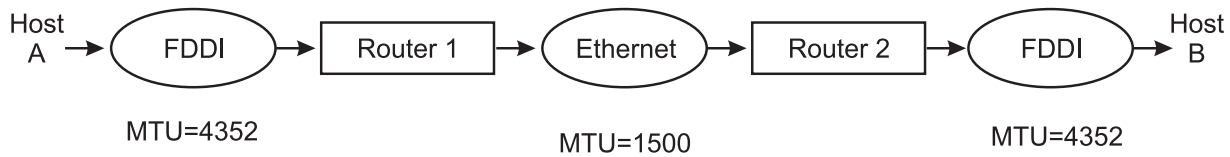

Figure 23. Inter-Subnet Fragmentation. This illustration shows a data path from Host A, through an FDDI with an MTU=4352, through Router 1, to the Ethernet with an MTU=1500. From there it goes to Router 2 and another FDDI with an MTU=4352 and out to Host B. An explanation of how fragmentation occurs in this example is described in the text immediately following the illustration.

- In this scenario, Hosts A and B would establish a connection based on a common MTU of 4352. A packet going from A to B would be fragmented by Router 1 and defragmented by Router 2. The reverse would occur going from B to A.
- Source and destination must both consider subnets to be local.

Note: Beginning with AIX 5.3, if the `tcp_pmtu_discover` value is 1, the MSS value is calculated based on the outgoing interface MTU. The `subnetsarelocal` value is only taken into consideration if the `tcp_pmtu_discover` network option value is 0.

IP protocol performance tuning recommendations

At the IP layer, the only tunable parameter is `ipqmaxlen`, which controls the length of the IP input queue. In general, interfaces do not do queuing. Packets can arrive very quickly and overrun the IP input queue. You can use the `netstat -s` or `netstat -p ip` command to view an overflow counter (`ipintrq overflows`).

If the number returned is greater than 0, overflows have occurred. Use the `no` command to set the maximum length of this queue. For example:

```
# no -o ipqmaxlen=100
```

This example allows 100 packets to be queued up. The exact value to use is determined by the maximum burst rate received. If this cannot be determined, using the number of overflows can help determine what the increase should be. No additional memory is used by increasing the queue length. However, an increase may result in more time spent in the off-level interrupt handler, because IP will have more packets to process on its input queue. This could adversely affect processes needing CPU time. The tradeoff is reduced packet-dropping versus CPU availability for other processing. It is best to increase `ipqmaxlen` by moderate increments if the tradeoff is a concern in your environment.

Tuning mbuf pool performance

The network subsystem uses a memory management facility that revolves around a data structure called an mbuf. Mbufs are mostly used to store data in the kernel for incoming and outbound network traffic. Having mbuf pools of the right size can have a positive effect on network performance. If the mbuf pools are configured incorrectly, both network and system performance can suffer. The upper limit of the mbuf pool size, which is the `thewall` tunable, is automatically determined by the operating system, based on the amount of memory in the system. As the system administrator, only you can tune the upper limit of the mbuf pool size.

The thewall tunable

The `thewall` network tunable option sets the upper limit for network kernel buffers. The system automatically sets the value of the `thewall` tunable to the maximum value and in general, you should not change the value. You could decrease it, which would reduce the amount of memory the system uses for network buffers, but it might affect network performance. Since the system only uses the necessary number of buffers at any given time, if the network subsystem is not being heavily used, the total number of buffers should be much lower than the `thewall` value.

The unit of **thewall** tunable is in 1 KB, so 1048576 bytes indicates 1024 MB or 1 GB of RAM.

32-bit versus 64-bit kernel

The AIX 32-bit kernel has up to 1 GB of mbuf buffer space, consisting of up to four memory segments of 256 MB each. This value might be lower, based on the total amount of memory in the system. The size of the **thewall** tunable is either 1 GB or half of the amount of system memory, whichever value is smaller.

The AIX 64-bit kernel has a much larger kernel buffer capacity. It has up to 65 GB of mbuf buffer space, consisting of 260 memory segments of 256 MB each. With the 64-bit kernel, the size of the **thewall** tunable is either 65 GB or half of the amount of system memory, whichever value is smaller.

Therefore, systems with large numbers of TCP connections, network adapters, or network I/O should consider using the 64-bit kernel if the mbuf pool is limiting capacity or performance.

The maxmbuf tunable

The value of the **maxmbuf** tunable limits how much real memory is used by the communications subsystem. You can also use the **maxmbuf** tunable to lower the **thewall** limit. You can view the **maxmbuf** tunable value by running the **lsattr -E -l sys0** command . If the **maxmbuf** value is greater than 0 , the **maxmbuf** value is used regardless of the value of **thewall** tunable.

The default value for the **maxmbuf** tunable is 0. A value of 0 for the **maxmbuf** tunable indicates that the **thewall** tunable is used. You can change the **maxmbuf** tunable value by using the **chdev** or **smitty** commands.

The sockthresh and strthresh threshold tunables

The **sockthresh** and **strthresh** tunables are the upper thresholds to limit the opening of new sockets or TCP connections, or the creation of new streams resources. This prevents buffer resources from not being available and ensures that existing sessions or connections have resources to continue operating.

The **sockthresh** tunable specifies the memory usage limit. No new socket connections are allowed to exceed the value of the **sockthresh** tunable. The default value for the **sockthresh** tunable is 85%, and once the total amount of allocated memory reaches 85% of the **thewall** or **maxmbuf** tunable value, you cannot have any new socket connections, which means the return value of the **socket()** and **socketpair()** system calls is *ENOBUFS*, until the buffer usage drops below 85%.

Similarly, the **strthresh** tunable limits the amount of mbuf memory used for streams resources and the default value for the **strthresh** tunable is 85%. The async and TTY subsystems run in the streams environment. The **strthresh** tunable specifies that once the total amount of allocated memory reaches 85% of the **thewall** tunable value, no more memory goes to streams resources, which means the return value of the streams call is *ENOSR*, to open streams, push modules or write to streams devices.

You can tune the **sockthresh** and **strthresh** thresholds with the **no** command.

Overview of the mbuf management facility

The mbuf management facility controls different buffer sizes that can range from 32 bytes up to 16384 bytes. The pools are created from system memory by making an allocation request to the Virtual Memory Manager (VMM). The pools consist of pinned pieces of kernel virtual memory in which they always reside in physical memory and are never paged out. The result is that the real memory available for paging in application programs and data has been decreased by the amount that the mbuf pools have been increased.

The network memory pool is split evenly among each processor. Each sub-pool is then split up into buckets, with each bucket holding buffers ranging in size from 32 to 16384 bytes. Each bucket can borrow memory from other buckets on the same processor but a processor cannot borrow memory from another

processor's network memory pool. When a network service needs to transport data, it can call a kernel service such as **m_get()** to obtain a memory buffer. If the buffer is already available and pinned, it can get it immediately. If the upper limit has not been reached and the buffer is not pinned, then a buffer is allocated and pinned. Once pinned, the memory stays pinned but can be freed back to the network pool. If the number of free buffers reaches a high-water mark, then a certain number is unpinned and given back to the system for general use. This unpinning is done by the **netm()** kernel process. The caller of the **m_get()** subroutine can specify whether to wait for a network memory buffer. If the **M_DONTWAIT** flag is specified and no pinned buffers are available at that time, a failed counter is incremented. If the **M_WAIT** flag is specified, the process is put to sleep until the buffer can be allocated and pinned.

The netstat -m command to monitor mbuf pools

Use the **netstat -m** command to detect shortages or failures of network memory (mbufs/clusters) requests. You can use the **netstat -Zm** command to clear (or zero) the mbuf statistics. This is helpful when running tests to start with a clean set of statistics. The following fields are provided with the **netstat -m** command:

Field name

Definition

By size

Shows the size of the buffer.

inuse Shows the number of buffers of that particular size in use.

calls Shows the number of calls, or allocation requests, for each sized buffer.

failed Shows how many allocation requests failed because no buffers were available.

delayed

Shows how many calls were delayed if that size of buffer was empty and the **M_WAIT** flag was set by the caller.

free Shows the number of each size buffer that is on the free list, ready to be allocated.

hiwat Shows the maximum number of buffers, determined by the system, that can remain on the free list. Any free buffers above this limit are slowly freed back to the system.

freed Shows the number of buffers that were freed back to the system when the free count when above the **hiwat** limit.

You should not see a large number of **failed** calls. There might be a few, which trigger the system to allocate more buffers as the buffer pool size increases. There is a predefined set of buffers of each size that the system starts with after each reboot, and the number of buffers increases as necessary.

The following is an example of the **netstat -m** command from a two-processor or CPU machine:

```
# netstat -m
```

```
Kernel malloc statistics:
```

```
***** CPU 0 *****
```

| By size | inuse | calls | failed | delayed | free | hiwat | freed |
|---------|-------|-------|--------|---------|------|-------|-------|
| 32 | 68 | 693 | 0 | 0 | 60 | 2320 | 0 |
| 64 | 55 | 115 | 0 | 0 | 9 | 1160 | 0 |
| 128 | 21 | 451 | 0 | 0 | 11 | 580 | 0 |
| 256 | 1064 | 5331 | 0 | 0 | 1384 | 1392 | 42 |
| 512 | 41 | 136 | 0 | 0 | 7 | 145 | 0 |
| 1024 | 10 | 231 | 0 | 0 | 6 | 362 | 0 |
| 2048 | 2049 | 4097 | 0 | 0 | 361 | 362 | 844 |
| 4096 | 2 | 8 | 0 | 0 | 435 | 435 | 453 |
| 8192 | 2 | 4 | 0 | 0 | 0 | 36 | 0 |
| 16384 | 0 | 513 | 0 | 0 | 86 | 87 | 470 |

```
***** CPU 1 *****
```

| By size | inuse | calls failed | delayed | free | hiwat | freed |
|---------|-------|--------------|---------|------|-------|-------|
| 32 | 139 | 710 | 0 | 117 | 2320 | 0 |
| 64 | 53 | 125 | 0 | 11 | 1160 | 0 |
| 128 | 41 | 946 | 0 | 23 | 580 | 0 |
| 256 | 62 | 7703 | 0 | 1378 | 1392 | 120 |
| 512 | 37 | 109 | 0 | 11 | 145 | 0 |
| 1024 | 21 | 217 | 0 | 3 | 362 | 0 |
| 2048 | 2 | 2052 | 0 | 362 | 362 | 843 |
| 4096 | 7 | 10 | 0 | 434 | 435 | 449 |
| 8192 | 0 | 4 | 0 | 1 | 36 | 0 |
| 16384 | 0 | 5023 | 0 | 87 | 87 | 2667 |

***** Allocations greater than 16384 Bytes *****

| By size | inuse | calls failed | delayed | free | hiwat | freed |
|---------|-------|--------------|---------|------|-------|-------|
| 65536 | 2 | 2 | 0 | 0 | 4096 | 0 |

Streams mblk statistic failures:
0 high priority mblk failures
0 medium priority mblk failures
0 low priority mblk failures

ARP cache tuning

The Address Resolution Protocol (ARP) is a protocol used to map 32-bit IPv4 addresses into a 48-bit host adapter address required by the data link protocol. ARP is handled transparently by the system. However, the system maintains an ARP cache, which is a table that holds the associated 32-bit IP addresses and its 48-bit host address. You might need to change the size of the ARP cache in environments where large numbers of machines (clients) are connected.

The **no** command tunable parameters are:

- **arpqsize = 12**
- **arpt_killc = 20**
- **arptab_bsiz = 7**
- **arptab_nb = 149**

The ARP table size is composed of a number of buckets, defined by the **arptab_nb** parameter. Each bucket holds **arptab_bsiz** entries. The defaults are 149 buckets with 7 entries each, so the table can hold 1043 (149 x 7) host addresses. If a server connects to 1000 client machines concurrently, the default ARP table is too small, which causes AIX to thrash the ARP cache. The operating system then has to purge an entry in the cache and replace it with a new address. This requires the TCP or UDP packets to wait (be queued) while the ARP protocol exchanges this information. The **arpqsize** parameter determines how many of these waiting packets can be queued by the ARP layer until an ARP response is received back from an ARP request. If the ARP queue is overrun, outgoing TCP or UDP packets are dropped.

ARP cache thrashing might have a negative impact on performance for the following reasons:

1. The current outgoing packet has to wait for the ARP protocol lookup over the network.
2. Another ARP entry must be removed from the ARP cache. If all the addresses are needed, another address is required when the host address that is deleted has packets sent to it.
3. The ARP output queue might be overrun, which could cause dropped packets.

The **arpqsize**, **arptab_bsiz**, and **arptab_nb** parameters are all reboot parameters in that the system must be rebooted if their values change because they alter tables that are built at boot time or TCP/IP load time.

The **arpt_killc** parameter is the time, in minutes, before an ARP entry is deleted. The default value of the **arpt_killc** parameter is 20 minutes. ARP entries are deleted from the table every **arpt_killc** minutes to

cover the case where a host system might change its 48-bit address, which can occur when its network adapter is replaced for example. This ensures that any stale entries in the cache are deleted, as these would prevent communication with such a host until its old address is removed. Increasing this time would reduce ARP lookups by the system, but can result in holding stale host addresses longer. The **arpt_killc** parameter is a dynamic parameter, so it can be changed on the fly without rebooting the system.

The **netstat -p arp** command displays the ARP statistics. These statistics show how many total ARP request have been sent and how many packets have been purged from the table when an entry is deleted to make room for a new entry. If this purged count is high, then your ARP table size should be increased. The following is an example of the **netstat -p arp** command.

```
# netstat -p arp
arp:
    6 packets sent
    0 packets purged
```

You can display the ARP table with the **arp -a** command. The command output shows which addresses are in the ARP table and how those addresses are hashed and to what buckets.

```
? (10.3.6.1) at 0:6:29:dc:28:71 [ethernet] stored
bucket:  0    contains:  0 entries
bucket:  1    contains:  0 entries
bucket:  2    contains:  0 entries
bucket:  3    contains:  0 entries
bucket:  4    contains:  0 entries
bucket:  5    contains:  0 entries
bucket:  6    contains:  0 entries
bucket:  7    contains:  0 entries
bucket:  8    contains:  0 entries
bucket:  9    contains:  0 entries
bucket: 10    contains:  0 entries
bucket: 11    contains:  0 entries
bucket: 12    contains:  0 entries
bucket: 13    contains:  0 entries
bucket: 14    contains:  1 entries
bucket: 15    contains:  0 entries
```

...lines omitted...

There are 1 entries in the arp table.

Name resolution tuning

TCP/IP attempts to obtain an Internet Protocol (IP) address from a host name in a process known as *name resolution*. The process of translating an Internet Protocol address into a host name is known as *reverse name resolution*. A *resolver routine* is used to resolve names. It queries DNS, NIS and finally the local **/etc/hosts** file to find the required information.

You can accelerate the process of name resolution by overwriting the default search order, if you know how you want names to be resolved. This is done through the use of the **/etc/netsvc.conf** file or the **NSORDER** environment variable.

- If both the **/etc/netsvc.conf** file and the **NSORDER** are used, **NSORDER** overrides the **/etc/netsvc.conf** file. To specify host ordering with **/etc/netsvc.conf**, create the file and include the following line:

```
hosts=value,value,value
```

where *value* may be (lowercase only) `bind`, `local`, `nis`, `bind4`, `bind6`, `local4`, `local6`, `nis4`, or `nis6` (for **/etc/hosts**). The order is specified on one line with values separated by commas. White spaces are permitted between the commas and the equal sign.

The values specified and their ordering is dependent on the network configuration. For example, if the local network is organized as a flat network, then only the `/etc/hosts` file is needed. The `/etc/netsvc.conf` file would contain the following line:

```
hosts=local
```

The **NSORDER** environment variable would be set as:

```
NSORDER=local
```

- If the local network is a domain network using a name server for name resolution and an `/etc/hosts` file for backup, specify both services. The `/etc/netsvc.conf` file would contain the following line:

```
hosts=bind,local
```

The **NSORDER** environment variable would be set as:

```
NSORDER=bind,local
```

The algorithm attempts the first source in the list. The algorithm will then determine to try another specified service based on:

- Current service is not running; therefore, it is unavailable.
- Current service could not find the name and is not authoritative.

Network performance analysis

When performance problems arise, your system might be totally innocent, while the real culprit is buildings away. An easy way to tell if the network is affecting overall performance is to compare those operations that involve the network with those that do not. If you are running a program that does a considerable amount of remote reads and writes and it is running slowly, but everything else seems to be running as usual, then it is probably a network problem. Some of the potential network bottlenecks might be caused by the following:

- Client-network interface
- Network bandwidth
- Network topology
- Server network interface
- Server CPU load
- Server memory usage
- Server bandwidth
- Inefficient configuration

Several tools measure network statistics and give a variety of information, but only part of this information is related to performance tuning.

To enhance performance, you can use the **no** (network options) command and the **nfso** command for tuning NFS options. You can also use the **chdev** and **ifconfig** commands to change system and network parameters.

The ping command

The **ping** command is useful for the following:

- Determining the status of the network and various foreign hosts.
- Tracking and isolating hardware and software problems.
- Testing, measuring, and managing networks.

Some **ping** command options relevant to performance tuning are as follows:

- c** Specifies the number of packets. This option is useful when you get an IP trace log. You can capture a minimum of **ping** packets.

- s** Specifies the length of packets. You can use this option to check fragmentation and reassembly.
- f** Sends the packets at 10 ms intervals or immediately after each response. Only the root user can use this option.

If you need to load your network or systems, the **-f** option is convenient. For example, if you suspect that your problem is caused by a heavy load, load your environment intentionally to confirm your suspicion. Open several **aixterm** windows and run the **ping -f** command in each window. Your Ethernet utilization quickly gets to around 100 percent. The following is an example:

```
# date; ping -c 1000 -f 192.1.6.1 ; date
Thu Feb 12 10:51:00 CST 2004
PING 192.1.6.1 (192.1.6.1): 56 data bytes
.
--- 192.1.6.1 ping statistics ---
1000 packets transmitted, 1000 packets received, 0% packet loss
round-trip min/avg/max = 1/1/23 ms
Thu Feb 12 10:51:00 CST 2004
```

Note: The **ping** command can be very hard on a network and should be used with caution. Flood-pinging can only be performed by the root user.

In this example, 1000 packets were sent within 1 second. Be aware that this command uses IP and Internet Control Message Protocol (ICMP) protocol and therefore, no transport protocol (UDP/TCP) and application activities are involved. The measured data, such as round-trip time, does not reflect the total performance characteristics.

When you try to send a flood of packets to your destination, consider several points:

- Sending packets puts a load on your system.
- Use the **netstat -i** command to monitor the status of your network interface during the experiment. You may find that the system is dropping packets during a send by looking at the **0errs** output.
- You should also monitor other resources, such as **mbufs** and **send/receive queue**. It can be difficult to place a heavy load onto the destination system. Your system might be overloaded before the other system is.
- Consider the relativity of the results. If you want to monitor or test just one destination system, do the same experiment on some other systems for comparison, because your network or router might have a problem.

The ftp command

You can use the **ftp** command to send a very large file by using **/dev/zero** as input and **/dev/null** as output. This allows you to transfer a large file without involving disks (which might be a bottleneck) and without having to cache the entire file in memory.

Use the following **ftp** subcommands (change count to increase **ftp** or decrease the number of blocks read by the **dd** command):

```
> bin
> put "|dd if=/dev/zero bs=32k count=10000" /dev/null
```

The above command transfers 10000 blocks of data and each block is 32 KB in size. To increase or decrease the size of the file transferred, change the count of blocks read by the **dd** command, which is the count parameter, or by changing the block size, which is the **bs** parameter. Note that the default file type for the **ftp** command is ASCII, which is slower since all bytes have to be scanned. The binary mode, or **bin** should be used for transfers whenever possible.

Make sure that **tcp_senspace** and **tcp_recvspace** are at least 65535 for the Gigabit Ethernet "jumbo frames" and for the ATM with MTU 9180 or larger to get good performance due to larger MTU size. A size of 131072 bytes (128 KB) is recommended for optimal performance. If you configure your Gigabit Ethernet

adapters with the **SMIT** tool, the ISNO system default values should be properly set. The ISNO options do not get properly set if you use the **ifconfig** command to bring up the network interfaces.

An example to set the parameters is as follows:

```
# no -o tcp_sendspace=65535
# no -o tcp_recvspace=65535
```

The **ftp** subcommands are as follows:

```
ftp> bin
200 Type set to I.
ftp> put "|dd if=/dev/zero bs=32k count=10000" /dev/null
200 PORT command successful.
150 Opening data connection for /dev/null.
10000+0 records in
10000+0 records out
226 Transfer complete.
327680000 bytes sent in 2.789 seconds (1.147e+05 Kbytes/s)
local: |dd if=/dev/zero bs=32k count=10000 remote: /dev/null
ftp> quit
221 Goodbye.
```

The above data transfer was executed between two Gigabit Ethernet adapters using 1500 bytes MTU and the throughput was reported to be : 114700 KB/sec which is the equivalent of 112 MB/sec or 940 Mbps.

When the sender and receiver used Jumbo Frames, with a MTU size of 9000, the throughput reported was 120700 KB/sec or 117.87 MB/sec or 989 Mbps, as you can see in the following example:

```
ftp> bin
200 Type set to I.
ftp> put "|dd if=/dev/zero bs=32k count=10000" /dev/null
200 PORT command successful.
150 Opening data connection for /dev/null.
10000+0 records in
10000+0 records out
226 Transfer complete.
327680000 bytes sent in 2.652 seconds (1.207e+05 Kbytes/s)
local: |dd if=/dev/zero bs=32k count=10000 remote: /dev/null
```

The following is an example of an **ftp** data transfer between two 10/100 Mbps Ethernet interfaces:

```
ftp> bin
200 Type set to I.
ftp> put "|dd if=/dev/zero bs=32k count=10000" /dev/null
200 PORT command successful.
150 Opening data connection for /dev/null.
10000+0 records in
10000+0 records out
226 Transfer complete.
327680000 bytes sent in 27.65 seconds (1.157e+04 Kbytes/s)
local: |dd if=/dev/zero bs=32k count=10000 remote: /dev/null
```

The throughput of the above data transfer is 11570 KB/sec which is the equivalent of 11.3 MB/sec or 94.7 Mbps.

The netstat command

The **netstat** command is used to show network status. Traditionally, it is used more for problem determination than for performance measurement. However, the **netstat** command can be used to determine the amount of traffic on the network to ascertain whether performance problems are due to network congestion.

The **netstat** command displays information regarding traffic on the configured network interfaces, such as the following:

- The address of any protocol control blocks associated with the sockets and the state of all sockets
- The number of packets received, transmitted, and dropped in the communications subsystem
- Cumulative statistics per interface
- Routes and their status

Using the netstat command

The **netstat** command displays the contents of various network-related data structures for active connections. In this chapter, only the options and output fields that are relevant for network performance determinations are discussed. For all other options and columns, see the *AIX 5L Version 5.3 Commands Reference*.

The netstat -in command: Shows the state of all configured interfaces.

The following example shows the statistics for a workstation with an integrated Ethernet (en1), a PCI-X Gigabit Ethernet (en0) and Fiber Channel Adapter configured for TCP/IP (fc0):

```
# netstat -in
Name Mtu Network Address Ipkts Ierrs Opkts Oerrs Coll
en1 1500 link#2 0.9.6b.3e.0.55 28800 0 506 0 0
en1 1500 10.3.104 10.3.104.116 28800 0 506 0 0
fc0 65280 link#3 0.0.c9.33.17.46 12 0 11 0 0
fc0 65280 192.6.0 192.6.0.1 12 0 11 0 0
en0 1500 link#4 0.2.55.6a.a5.dc 14 0 20 5 0
en0 1500 192.1.6 192.1.6.1 14 0 20 5 0
lo0 16896 link#1 33339 0 33343 0 0
lo0 16896 127 127.0.0.1 33339 0 33343 0 0
```

The count values are summarized since system startup.

Name Interface name.

Mtu Maximum transmission unit. The maximum size of packets in bytes that are transmitted using the interface.

Ipkts Total number of packets received.

Ierrs Total number of input errors. For example, malformed packets, checksum errors, or insufficient buffer space in the device driver.

Opkts Total number of packets transmitted.

Oerrs Total number of output errors. For example, a fault in the local host connection or adapter output queue overrun.

Coll Number of packet collisions detected.

Note: The **netstat -i** command does not support the collision count for Ethernet interfaces (see The **entstat** command for Ethernet statistics).

Following are some tuning guidelines:

- If the number of errors during input packets is greater than 1 percent of the total number of input packets (from the command **netstat -i**); that is,

$$Ierrs > 0.01 \times Ipkts$$

Then run the **netstat -m** command to check for a lack of memory.

- If the number of errors during output packets is greater than 1 percent of the total number of output packets (from the command **netstat -i**); that is,

$$Oerrs > 0.01 \times Opkts$$

Then increase the send queue size (**xmt_que_size**) for that interface. The size of the **xmt_que_size** could be checked with the following command:

```
# lsattr -El adapter
```

- If the collision rate is greater than 10 percent, that is,

$Coll / Opkts > 0.1$

Then there is a high network utilization, and a reorganization or partitioning may be necessary. Use the **netstat -v** or **entstat** command to determine the collision rate.

The netstat -i -Z command: This function of the **netstat** command clears all the statistic counters for the **netstat -i** command to zero.

The netstat -I interface interval: Displays the statistics for the specified interface. It offers information similar to the **netstat -i** command for the specified interface and reports it for a given time interval. For example:

```
# netstat -I en0 1
  input      (en0)      output      input      (Total)      output
  packets  errs  packets  errs  colls  packets  errs  packets  errs  colls
    0        0      27       0     0     799655   0   390669   0     0
    0        0       0       0     0         2     0         0     0     0
    0        0       0       0     0         1     0         0     0     0
    0        0       0       0     0        78     0        254   0     0
    0        0       0       0     0       200     0         62     0     0
    0        0       1       0     0         0     0          2     0     0
```

The previous example shows the **netstat -I** command output for the **en0** interface. Two reports are generated side by side, one for the specified interface and one for all available interfaces (Total). The fields are similar to the ones in the **netstat -i** example, input packets = **Ipkts**, input errs = **Ierrs** and so on.

The netstat -a command: The **netstat -a** command shows the state of all sockets. Without the **-a** flag, sockets used by server processes are not shown. For example:

```
# netstat -a
Active Internet connections (including servers)
Proto Recv-Q Send-Q Local Address           Foreign Address         (state)
tcp4   0      0 *.daytime               *.*                     LISTEN
tcp    0      0 *.ftp                   *.*                     LISTEN
tcp    0      0 *.telnet                *.*                     LISTEN
tcp4   0      0 *.time                  *.*                     LISTEN
tcp4   0      0 *.sunrpc                 *.*                     LISTEN
tcp    0      0 *.exec                  *.*                     LISTEN
tcp    0      0 *.login                 *.*                     LISTEN
tcp    0      0 *.shell                 *.*                     LISTEN
tcp4   0      0 *.klogin                *.*                     LISTEN
tcp4   0      0 *.kshell                *.*                     LISTEN
tcp    0      0 *.netop                 *.*                     LISTEN
tcp    0      0 *.netop64               *.*                     LISTEN
tcp4   0      1028 brown10.telnet          remote_client.mt.1254  ESTABLISHED
tcp4   0      0 *.wsmserve              *.*                     LISTEN
udp4   0      0 *.daytime               *.*                     LISTEN
udp4   0      0 *.time                  *.*                     LISTEN
udp4   0      0 *.sunrpc                 *.*                     LISTEN
udp4   0      0 *.ntalk                 *.*                     LISTEN
udp4   0      0 *.32780                 *.*                     LISTEN
Active UNIX domain sockets
SADR/PCB Type Recv-Q Send-Q Inode Conn Refs Nextref Addr
71759200 dgram 0 0 13434d00 0 0 0 /dev/SRC
7051d580
71518a00 dgram 0 0 183c3b80 0 0 0 /dev/.SRC-unix/SRCCwfCEb
```

You can view detailed information for each socket with the **netstat -ao** command. In the following example, the **ftp** socket runs over a Gigabit Ethernet adapter configured for jumbo frames:

```
# netstat -ao
Active Internet connections (including servers)
Proto Recv-Q Send-Q Local Address           Foreign Address         (state)
```

[...]

```
tcp4      0      0  server1.ftp          client1.33122        ESTABLISHED

so_options: (REUSEADDR|OOBINLINE)
so_state: (ISCONNECTED|PRIV)
timeo:0 uid:0
so_special: (LOCKBALE|MEMCOMPRESS|DISABLE)
so_special2: (PROC)
sndbuf:
  hiwat:134220 lowat:33555 mbcnt:0 mbmax:536880
rcvbuf:
  hiwat:134220 lowat:1 mbcnt:0 mbmax:536880
  sb_flags: (WAIT)
TCP:
mss:8948 flags: (NODELAY|RFC1323|SENT_WS|RCVD_WS|SENT_TS|RCVD_TS)

tcp4      0      0  server1.telnet      sig-9-49-151-26..2387 ESTABLISHED

so_options: (REUSEADDR|KEEPALIVE|OOBINLINE)
so_state: (ISCONNECTED|NBIO)
timeo:0 uid:0
so_special: (NOUAREA|LOCKBALE|EXTPRIV|MEMCOMPRESS|DISABLE)
so_special2: (PROC)
sndbuf:
  hiwat:16384 lowat:4125 mbcnt:0 mbmax:65536
  sb_flags: (SEL|NOINTR)
rcvbuf:
  hiwat:66000 lowat:1 mbcnt:0 mbmax:264000
  sb_flags: (SEL|NOINTR)
TCP:
mss:1375

tcp4      0      925  en6host1.login      en6host2.1023      ESTABLISHED

so_options: (REUSEADDR|KEEPALIVE|OOBINLINE)
so_state: (ISCONNECTED|NBIO)
timeo:0 uid:0
so_special: (NOUAREA|LOCKBALE|EXTPRIV|MEMCOMPRESS|DISABLE)
so_special2: (PROC)
sndbuf:
  hiwat:16384 lowat:16384 mbcnt:3216 mbmax:65536
  sb_flags: (SEL|NOINTR)
rcvbuf:
  hiwat:130320 lowat:1 mbcnt:0 mbmax:521280
  sb_flags: (SEL|NOINTR)
TCP:
mss:1448 flags: (RFC1323|SENT_WS|RCVD_WS|SENT_TS|RCVD_TS)

tcp       0      0  *.login             *.*                 LISTEN

so_options: (ACCEPTCONN|REUSEADDR)
q0len:0 qlen:0 qlimit:1000 so_state: (PRIV)
timeo:0 uid:0
so_special: (LOCKBALE|MEMCOMPRESS|DISABLE)
so_special2: (PROC)
sndbuf:
  hiwat:16384 lowat:4096 mbcnt:0 mbmax:65536
rcvbuf:
  hiwat:16384 lowat:1 mbcnt:0 mbmax:65536
  sb_flags: (SEL)
TCP:
mss:512
```

```

tcp      0      0 *.shell          *.*              LISTEN

so_options: (ACCEPTCONN|REUSEADDR)
q0len:0 qlen:0 qlimit:1000      so_state: (PRIV)
timeo:0 uid:0
so_special: (LOCKBALE|MEMCOMPRESS|DISABLE)
so_special2: (PROC)
sndbuf:
    hiwat:16384 lowat:4096 mbcnt:0 mbmax:65536
rcvbuf:
    hiwat:16384 lowat:1 mbcnt:0 mbmax:65536
    sb_flags: (SEL)
TCP:
mss:512

```

```

tcp4    0    6394 brown10.telnet    remote_client.mt.1254  ESTABLISHED

so_options: (REUSEADDR|KEEPALIVE|OOBINLINE)
so_state: (ISCONNECTED|NBIO)
timeo:0 uid:0
so_special: (NOUAREA|LOCKBALE|EXTPRIV|MEMCOMPRESS|DISABLE)
so_special2: (PROC)
sndbuf:
    hiwat:16384 lowat:4125 mbcnt:65700 mbmax:65536
    sb_flags: (SEL|NOINTR)
rcvbuf:
    hiwat:16500 lowat:1 mbcnt:0 mbmax:66000
    sb_flags: (SEL|NOINTR)
TCP:
mss:1375

```

```

udp4    0      0 *.time          *.*

so_options: (REUSEADDR)
so_state: (PRIV)
timeo:0 uid:0
so_special: (LOCKBALE|DISABLE)
so_special2: (PROC)
sndbuf:
    hiwat:9216 lowat:4096 mbcnt:0 mbmax:36864
rcvbuf:
    hiwat:42080 lowat:1 mbcnt:0 mbmax:168320
    sb_flags: (SEL)

```

[...]

Active UNIX domain sockets

| SADR/PCB | Type | Recv-Q | Send-Q | Inode | Conn | Refs | Nextref | Addr |
|----------|-------|--------|--------|----------|------|------|---------|----------|
| 71759200 | dgram | 0 | 0 | 13434d00 | 0 | 0 | 0 | /dev/SRC |
| 7051d580 | | | | | | | | |

```

so_state: (PRIV)
timeo:0 uid:0
so_special: (LOCKBALE)
so_special2: (PROC)
sndbuf:
    hiwat:8192 lowat:4096 mbcnt:0 mbmax:32768
rcvbuf:
    hiwat:45000 lowat:1 mbcnt:0 mbmax:180000
    sb_flags: (SEL)

```

| | | | | | | | | |
|----------|-------|---|---|----------|---|---|---|----------------------------------|
| 71518a00 | dgram | 0 | 0 | 183c3b80 | 0 | 0 | 0 | /dev/.SRC-unix/SRCCwfCEb7051d400 |
|----------|-------|---|---|----------|---|---|---|----------------------------------|

```

so_state: (PRIV)
timeo:0 uid:0
so_special: (LOCKBALE)
so_special2: (PROC)

```

```

sndbuf:
    hiwat:16384 lowat:4096 mbcnt:0 mbmax:65536
rcvbuf:
    hiwat:8192 lowat:1 mbcnt:0 mbmax:32768
    sb_flags: (SEL)

```

[...]

In the above example, the adapter is configured for jumbo frames which is the reason for the large MSS value and the reason that **rfc1323** is set.

netstat -m: Displays the statistics recorded by the mbuf memory-management routines. The most useful statistics in the output of the **netstat -m** command are the counters that show the requests for mbufs denied and non-zero values in the failed column. If the requests for mbufs denied is not displayed, then this must be an SMP system running operating system version 4.3.2 or later; for performance reasons, global statistics are turned off by default. To enable the global statistics, set the **no** parameter **extended_netstats** to 1. This can be done by changing the **/etc/rc.net** file and rebooting the system. However, enabling **extended_netstats** significantly degrades the performance of SMP systems. It is highly recommended to set the **extended_netstats** value to 0.

The following example shows the first part of the **netstat -m** output with **extended_netstats** set to 0:

```
# netstat -m
```

Kernel malloc statistics:

```
***** CPU 0 *****
```

| By size | inuse | calls | failed | delayed | free | hiwat | freed |
|---------|-------|----------|--------|---------|------|-------|-------|
| 32 | 132 | 1384 | 0 | 0 | 124 | 2320 | 0 |
| 64 | 53 | 1778 | 0 | 0 | 11 | 1160 | 0 |
| 128 | 27 | 4552 | 0 | 0 | 485 | 580 | 0 |
| 256 | 3153 | 27577974 | 0 | 0 | 1375 | 1392 | 43 |
| 512 | 31 | 787811 | 0 | 0 | 137 | 145 | 1325 |
| 1024 | 14 | 933442 | 0 | 0 | 354 | 362 | 2 |
| 2048 | 3739 | 4710181 | 0 | 0 | 361 | 362 | 844 |
| 4096 | 8 | 381861 | 0 | 0 | 435 | 435 | 508 |
| 8192 | 2 | 215908 | 0 | 0 | 10 | 36 | 0 |
| 16384 | 512 | 201880 | 0 | 0 | 77 | 87 | 750 |

```
***** CPU 1 *****
```

| By size | inuse | calls | failed | delayed | free | hiwat | freed |
|---------|-------|----------|--------|---------|------|-------|-------|
| 32 | 156 | 1378 | 0 | 0 | 228 | 2320 | 0 |
| 64 | 65 | 1784 | 0 | 0 | 63 | 1160 | 0 |
| 128 | 42 | 3991 | 0 | 0 | 470 | 580 | 0 |
| 256 | 34 | 25022240 | 0 | 0 | 1374 | 1392 | 44 |
| 512 | 53 | 594457 | 0 | 0 | 139 | 145 | 1048 |
| 1024 | 19 | 890741 | 0 | 0 | 357 | 362 | 0 |
| 2048 | 361 | 4703223 | 0 | 0 | 361 | 362 | 844 |
| 4096 | 2 | 377020 | 0 | 0 | 435 | 435 | 648 |
| 8192 | 0 | 213864 | 0 | 0 | 12 | 36 | 0 |
| 16384 | 0 | 199239 | 0 | 0 | 75 | 87 | 963 |

```
***** Allocations greater than 16384 Bytes *****
```

| By size | inuse | calls | failed | delayed | free | hiwat | freed |
|---------|-------|-------|--------|---------|------|-------|-------|
| 65536 | 2 | 0 | 0 | 0 | 0 | 4096 | 0 |

Streams mblk statistic failures:

```

0 high priority mblk failures
0 medium priority mblk failures
0 low priority mblk failures

```

If global statistics are not on and you want to determine the total number of requests for mbufs denied, add up the values under the `failed` columns for each CPU. If the `netstat -m` command indicates that requests for mbufs or clusters have failed or been denied, then you may want to increase the value of `thewall` by using the `no -o thewall=NewValue` command. See Overview of the mbuf Management Facility for additional details about the use of `thewall` and `maxmbuf`.

Beginning with AIX 4.3.3, a `delayed` column was added. If the requester of an mbuf specified the `M_WAIT` flag, then if an mbuf was not available, the thread is put to sleep until an mbuf is freed and can be used by this thread. The failed counter is not incremented in this case; instead, the `delayed` column will be incremented. Prior to AIX 4.3.3, the failed counter was also not incremented, but there was no `delayed` column.

Also, if the currently allocated amount of network memory is within 85 percent of `thewall`, you may want to increase `thewall`. If the value of `thewall` is increased, use the `vmstat` command to monitor total memory use to determine if the increase has had a negative impact on overall memory performance.

If buffers are not available when a request is received, the request is most likely lost (to see if the adapter actually dropped a package, see Adapter Statistics). Keep in mind that if the requester of the mbuf specified that it could wait for the mbuf if not available immediately, this puts the requestor to sleep but does not count as a request being denied.

If the number of failed requests continues to increase, the system might have an mbuf leak. To help track down the problem, the `no` command parameter `net_malloc_police` can be set to 1, and the trace hook with ID 254 can be used with the `trace` command.

After an mbuf/cluster is allocated and pinned, it can be freed by the application. Instead of unpinning this buffer and giving it back to the system, it is left on a free-list based on the size of this buffer. The next time that a buffer is requested, it can be taken off this free-list to avoid the overhead of pinning. After the number of buffers on the free list reaches the highwater mark, buffers smaller than 4096 will be coalesced together into page-sized units so that they can be unpinned and given back to the system. When the buffers are given back to the system, the `freed` column is incremented. If the `freed` value consistently increases, the highwater mark is too low. The highwater mark is scaled according to the amount of RAM on the system.

The `netstat -M` command: The `netstat -M` command displays the network memory's cluster pool statistics. The following example shows the output of the `netstat -M` command:

```
# netstat -M
Cluster pool Statistics:
```

| Cluster Size | Pool Size | Calls | Failed | Inuse | Max | Outcount |
|--------------|-----------|--------|--------|-------|-----|----------|
| 131072 | 0 | 0 | 0 | 0 | | 0 |
| 65536 | 0 | 0 | 0 | 0 | | 0 |
| 32768 | 0 | 0 | 0 | 0 | | 0 |
| 16384 | 0 | 0 | 0 | 0 | | 0 |
| 8192 | 0 | 191292 | 3 | 0 | | 3 |
| 4096 | 0 | 196021 | 3 | 0 | | 3 |
| 2048 | 0 | 140660 | 4 | 0 | | 2 |
| 1024 | 0 | 2 | 1 | 0 | | 1 |
| 512 | 0 | 2 | 1 | 0 | | 1 |
| 131072 | 0 | 0 | 0 | 0 | | 0 |
| 65536 | 0 | 0 | 0 | 0 | | 0 |
| 32768 | 0 | 0 | 0 | 0 | | 0 |
| 16384 | 0 | 0 | 0 | 0 | | 0 |
| 8192 | 0 | 193948 | 2 | 0 | | 2 |
| 4096 | 0 | 191122 | 3 | 0 | | 3 |
| 2048 | 0 | 145477 | 4 | 0 | | 2 |
| 1024 | 0 | 0 | 0 | 0 | | 0 |
| 512 | 0 | 2 | 1 | 0 | | 1 |

The netstat -v command: The **netstat -v** command displays the statistics for each Common Data Link Interface (CDLI)-based device driver that is in operation. Interface-specific reports can be requested using the **tokstat**, **entstat**, **fdlistat**, or **atmstat** commands.

Every interface has its own specific information and some general information. The following example shows the Token-Ring and Ethernet part of the **netstat -v** command; other interface parts are similar. With a different adapter, the statistics will differ somewhat. The most important output fields are highlighted.

```
# netstat -v
-----
ETHERNET STATISTICS (ent1) :
Device Type: 10/100 Mbps Ethernet PCI Adapter II (1410ff01)
Hardware Address: 00:09:6b:3e:00:55
Elapsed Time: 0 days 17 hours 38 minutes 35 seconds

Transmit Statistics:                Receive Statistics:
-----
Packets: 519                        Packets: 30161
Bytes: 81415                         Bytes: 7947141
Interrupts: 2                       Interrupts: 29873
Transmit Errors: 0                   Receive Errors: 0
Packets Dropped: 0                  Packets Dropped: 0
Bad Packets: 0

Max Packets on S/W Transmit Queue: 3
S/W Transmit Queue Overflow: 0
Current S/W+H/W Transmit Queue Length: 1

Broadcast Packets: 3                 Broadcast Packets: 29544
Multicast Packets: 2                 Multicast Packets: 42
No Carrier Sense: 0                  CRC Errors: 0
DMA Underrun: 0                      DMA Overrun: 0
Lost CTS Errors: 0                   Alignment Errors: 0
Max Collision Errors: 0               No Resource Errors: 0
Late Collision Errors: 0              Receive Collision Errors: 0
Deferred: 0                           Packet Too Short Errors: 0
SQE Test: 0                           Packet Too Long Errors: 0
Timeout Errors: 0                     Packets Discarded by Adapter: 0
Single Collision Count: 0              Receiver Start Count: 0
Multiple Collision Count: 0

Current HW Transmit Queue Length: 1

General Statistics:
-----
No mbuf Errors: 0
Adapter Reset Count: 0
Adapter Data Rate: 200
Driver Flags: Up Broadcast Running
                Simplex AlternateAddress 64BitSupport
                ChecksumOffload PrivateSegment DataRateSet

10/100 Mbps Ethernet PCI Adapter II (1410ff01) Specific Statistics:
-----
Link Status: Up
Media Speed Selected: Auto negotiation
Media Speed Running: 100 Mbps Full Duplex
Receive Pool Buffer Size: 1024
Free Receive Pool Buffers: 1024
No Receive Pool Buffer Errors: 0
Receive Buffer Too Small Errors: 0
Entries to transmit timeout routine: 0
Transmit IPsec packets: 0
Transmit IPsec packets dropped: 0
Receive IPsec packets: 0
Receive IPsec packets dropped: 0
Inbound IPsec SA offload count: 0
Transmit Large Send packets: 0
```

```

Transmit Large Send packets dropped: 0
Packets with Transmit collisions:
 1 collisions: 0          6 collisions: 0          11 collisions: 0
 2 collisions: 0          7 collisions: 0          12 collisions: 0
 3 collisions: 0          8 collisions: 0          13 collisions: 0
 4 collisions: 0          9 collisions: 0          14 collisions: 0
 5 collisions: 0         10 collisions: 0         15 collisions: 0

```

```

-----
ETHERNET STATISTICS (ent0) :
Device Type: 10/100/1000 Base-TX PCI-X Adapter (14106902)
Hardware Address: 00:02:55:6a:a5:dc
Elapsed Time: 0 days 17 hours 0 minutes 26 seconds

```

```

Transmit Statistics:                Receive Statistics:
-----
Packets: 15                         Packets: 14
Bytes: 1037                          Bytes: 958
Interrupts: 0                        Interrupts: 13
Transmit Errors: 0                    Receive Errors: 0
Packets Dropped: 0                    Packets Dropped: 0
Bad Packets: 0

```

```

Max Packets on S/W Transmit Queue: 4
S/W Transmit Queue Overflow: 0
Current S/W+H/W Transmit Queue Length: 0

```

```

Broadcast Packets: 1                 Broadcast Packets: 0
Multicast Packets: 1                 Multicast Packets: 0
No Carrier Sense: 0                  CRC Errors: 0
DMA Underrun: 0                       DMA Overrun: 0
Lost CTS Errors: 0                    Alignment Errors: 0
Max Collision Errors: 0                No Resource Errors: 0
Late Collision Errors: 0                Receive Collision Errors: 0
Deferred: 0                             Packet Too Short Errors: 0
SQE Test: 0                             Packet Too Long Errors: 0
Timeout Errors: 0                       Packets Discarded by Adapter: 0
Single Collision Count: 0                Receiver Start Count: 0
Multiple Collision Count: 0
Current HW Transmit Queue Length: 0

```

General Statistics:

```

-----
No mbuf Errors: 0
Adapter Reset Count: 0
Adapter Data Rate: 2000
Driver Flags: Up Broadcast Running
                Simplex 64BitSupport ChecksumOffload
                PrivateSegment LargeSend DataRateSet

```

10/100/1000 Base-TX PCI-X Adapter (14106902) Specific Statistics:

```

-----
Link Status: Up
Media Speed Selected: Auto negotiation
Media Speed Running: 1000 Mbps Full Duplex
PCI Mode: PCI-X (100-133)
PCI Bus Width: 64-bit
Jumbo Frames: Disabled
TCP Segmentation Offload: Enabled
    TCP Segmentation Offload Packets Transmitted: 0
    TCP Segmentation Offload Packet Errors: 0
Transmit and Receive Flow Control Status: Enabled
    XON Flow Control Packets Transmitted: 0
    XON Flow Control Packets Received: 0
    XOFF Flow Control Packets Transmitted: 0
    XOFF Flow Control Packets Received: 0
Transmit and Receive Flow Control Threshold (High): 32768
Transmit and Receive Flow Control Threshold (Low): 24576
Transmit and Receive Storage Allocation (TX/RX): 16/48

```

The highlighted fields are described as follows:

- **Transmit and Receive Errors**

Number of output/input errors encountered on this device. This field counts unsuccessful transmissions due to hardware/network errors.

These unsuccessful transmissions could also slow down the performance of the system.

- **Max Packets on S/W Transmit Queue**

Maximum number of outgoing packets ever queued to the software transmit queue.

An indication of an inadequate queue size is if the maximal transmits queued equals the current queue size (`xmt_que_size`). This indicates that the queue was full at some point.

To check the current size of the queue, use the `lsattr -El adapter` command (where `adapter` is, for example, `tok0` or `ent0`). Because the queue is associated with the device driver and adapter for the interface, use the adapter name, not the interface name. Use the SMIT or the `chdev` command to change the queue size.

- **S/W Transmit Queue Overflow**

Number of outgoing packets that have overflowed the software transmit queue. A value other than zero requires the same actions as would be needed if the Max Packets on S/W Transmit Queue reaches the `xmt_que_size`. The transmit queue size must be increased.

- **Broadcast Packets**

Number of broadcast packets received without any error.

If the value for broadcast packets is high, compare it with the total received packets. The received broadcast packets should be less than 20 percent of the total received packets. If it is high, this could be an indication of a high network load; use multicasting. The use of IP multicasting enables a message to be transmitted to a group of hosts, instead of having to address and send the message to each group member individually.

- **DMA Overrun**

The DMA Overrun statistic is incremented when the adapter is using DMA to put a packet into system memory and the transfer is not completed. There are system buffers available for the packet to be placed into, but the DMA operation failed to complete. This occurs when the MCA bus is too busy for the adapter to be able to use DMA for the packets. The location of the adapter on the bus is crucial in a heavily loaded system. Typically an adapter in a lower slot number on the bus, by having the higher bus priority, is using so much of the bus that adapters in higher slot numbers are not being served. This is particularly true if the adapters in a lower slot number are ATM or SSA adapters.

- **Max Collision Errors**

Number of unsuccessful transmissions due to too many collisions. The number of collisions encountered exceeded the number of retries on the adapter.

- **Late Collision Errors**

Number of unsuccessful transmissions due to the late collision error.

- **Timeout Errors**

Number of unsuccessful transmissions due to adapter reported timeout errors.

- **Single Collision Count**

Number of outgoing packets with single (only one) collision encountered during transmission.

- **Multiple Collision Count**

Number of outgoing packets with multiple (2 - 15) collisions encountered during transmission.

- **Receive Collision Errors**

Number of incoming packets with collision errors during reception.

- **No mbuf Errors**

Number of times that mbufs were not available to the device driver. This usually occurs during receive operations when the driver must obtain memory buffers to process inbound packets. If the mbuf pool for the requested size is empty, the packet will be discarded. Use the **netstat -m** command to confirm this, and increase the parameter **thewall**.

The No mbuf Errors value is interface-specific and not identical to the requests for mbufs denied from the **netstat -m** output. Compare the values of the example for the commands **netstat -m** and **netstat -v** (Ethernet and Token-Ring part).

To determine network performance problems, check for any Error counts in the **netstat -v** output.

Additional guidelines:

- To check for an overloaded Ethernet network, calculate (from the **netstat -v** command):
(Max Collision Errors + Timeouts Errors) / Transmit Packets
If the result is greater than 5 percent, reorganize the network to balance the load.
- Another indication for a high network load is (from the command **netstat -v**):
If the total number of collisions from the **netstat -v** output (for Ethernet) is greater than 10 percent of the total transmitted packets, as follows:
Number of collisions / Number of Transmit Packets > 0.1

netstat -p protocol: Shows statistics about the value specified for the protocol variable (udp, tcp, ip, icmp), which is either a well-known name for a protocol or an alias for it. Some protocol names and aliases are listed in the **/etc/protocols** file. A null response indicates that there are no numbers to report. If there is no statistics routine for it, the program report of the value specified for the protocol variable is unknown.

The following example shows the output for the ip protocol:

```
# netstat -p ip
ip:
  45775 total packets received
  0 bad header checksums
  0 with size smaller than minimum
  0 with data size < data length
  0 with header length < data size
  0 with data length < header length
  0 with bad options
  0 with incorrect version number
  0 fragments received
  0 fragments dropped (dup or out of space)
  0 fragments dropped after timeout
  0 packets reassembled ok
  45721 packets for this host
  51 packets for unknown/unsupported protocol
  0 packets forwarded
  4 packets not forwardable
  0 redirects sent
  33877 packets sent from this host
  0 packets sent with fabricated ip header
  0 output packets dropped due to no bufs, etc.
  0 output packets discarded due to no route
  0 output datagrams fragmented
  0 fragments created
  0 datagrams that can't be fragmented
  0 IP Multicast packets dropped due to no receiver
  0 successful path MTU discovery cycles
  1 path MTU rediscovery cycle attempted
  3 path MTU discovery no-response estimates
  3 path MTU discovery response timeouts
  1 path MTU discovery decrease detected
  8 path MTU discovery packets sent
  0 path MTU discovery memory allocation failures
  0 ipintrq overflows
```

```
0 with illegal source
0 packets processed by threads
0 packets dropped by threads
0 packets dropped due to the full socket receive buffer
0 dead gateway detection packets sent
0 dead gateway detection packet allocation failures
0 dead gateway detection gateway allocation failures
```

The highlighted fields are described as follows:

- **Total Packets Received**

Number of total IP datagrams received.

- **Bad Header Checksum or Fragments Dropped**

If the output shows bad header checksum or fragments dropped due to dup or out of space, this indicates either a network that is corrupting packets or device driver receive queues that are not large enough.

- **Fragments Received**

Number of total fragments received.

- **Dropped after Timeout**

If the fragments dropped after timeout is other than zero, then the time to life counter of the ip fragments expired due to a busy network before all fragments of the datagram arrived. To avoid this, use the **no** command to increase the value of the **ipfragttl** network parameter. Another reason could be a lack of mbufs; increase **thewall**.

- **Packets Sent from this Host**

Number of IP datagrams that were created and sent out from this system. This counter does not include the forwarded datagrams (passthrough traffic).

- **Fragments Created**

Number of fragments created in this system when IP datagrams were sent out.

When viewing IP statistics, look at the ratio of packets received to fragments received. As a guideline for small MTU networks, if 10 percent or more of the packets are getting fragmented, you should investigate further to determine the cause. A large number of fragments indicates that protocols above the IP layer on remote hosts are passing data to IP with data sizes larger than the MTU for the interface. Gateways/routers in the network path might also have a much smaller MTU size than the other nodes in the network. The same logic can be applied to packets sent and fragments created.

Fragmentation results in additional CPU overhead so it is important to determine its cause. Be aware that some applications, by their very nature, can cause fragmentation to occur. For example, an application that sends small amounts of data can cause fragments to occur. However, if you know the application is sending large amounts of data and fragmentation is still occurring, determine the cause. It is likely that the MTU size used is not the MTU size configured on the systems.

The following example shows the output for the udp protocol:

```
# netstat -p udp
udp:
  11623 datagrams received
  0 incomplete headers
  0 bad data length fields
  0 bad checksums
  620 dropped due to no socket
  10989 broadcast/multicast datagrams dropped due to no socket
  0 socket buffer overflows
  14 delivered
  12 datagrams output
```

Statistics of interest are:

- **Bad Checksums**

Bad checksums could happen due to hardware card or cable failure.

- **Dropped Due to No Socket**

Number of received UDP datagrams of that destination socket ports were not opened. As a result, the ICMP Destination Unreachable - Port Unreachable message must have been sent out. But if the received UDP datagrams were broadcast datagrams, ICMP errors are not generated. If this value is high, investigate how the application is handling sockets.

- **Socket Buffer Overflows**

Socket buffer overflows could be due to insufficient transmit and receive UDP sockets, too few **nfsd** daemons, or too small **nfs_socketsize**, **udp_recvspace** and **sb_max** values.

If the **netstat -p udp** command indicates socket overflows, then you might need to increase the number of the **nfsd** daemons on the server. First, check the affected system for CPU or I/O saturation, and verify the recommended setting for the other communication layers by using the **no -a** command. If the system is saturated, you must either to reduce its load or increase its resources.

The following example shows the output for the tcp protocol:

```
# netstat -p tcp
tcp:
    576 packets sent
        512 data packets (62323 bytes)
        0 data packets (0 bytes) retransmitted
        55 ack-only packets (28 delayed)
        0 URG only packets
        0 window probe packets
        0 window update packets
        9 control packets
        0 large sends
        0 bytes sent using largesend
        0 bytes is the biggest largesend
    719 packets received
        504 acks (for 62334 bytes)
        19 duplicate acks
        0 acks for unsent data
        449 packets (4291 bytes) received in-sequence
        8 completely duplicate packets (8 bytes)
        0 old duplicate packets
        0 packets with some dup. data (0 bytes duped)
        5 out-of-order packets (0 bytes)
        0 packets (0 bytes) of data after window
        0 window probes
        2 window update packets
        0 packets received after close
        0 packets with bad hardware assisted checksum
        0 discarded for bad checksums
        0 discarded for bad header offset fields
        0 discarded because packet too short
        0 discarded by listeners
        0 discarded due to listener's queue full
        71 ack packet headers correctly predicted
        172 data packet headers correctly predicted
    6 connection requests
    8 connection accepts
    14 connections established (including accepts)
    6 connections closed (including 0 drops)
    0 connections with ECN capability
    0 times responded to ECN
    0 embryonic connections dropped
    504 segments updated rtt (of 505 attempts)
    0 segments with congestion window reduced bit set
    0 segments with congestion experienced bit set
    0 resends due to path MTU discovery
```

```

0 path MTU discovery terminations due to retransmits
0 retransmit timeouts
    0 connections dropped by rexmit timeout
0 fast retransmits
    0 when congestion window less than 4 segments
0 newreno retransmits
0 times avoided false fast retransmits
0 persist timeouts
    0 connections dropped due to persist timeout
16 keepalive timeouts
    16 keepalive probes sent
    0 connections dropped by keepalive
0 times SACK blocks array is extended
0 times SACK holes array is extended
0 packets dropped due to memory allocation failure
0 connections in timewait reused
0 delayed ACKs for SYN
0 delayed ACKs for FIN
0 send_and_disconnects
0 spliced connections
0 spliced connections closed
0 spliced connections reset
0 spliced connections timeout
0 spliced connections persist timeout
0 spliced connections keepalive timeout

```

Statistics of interest are:

- Packets Sent
- Data Packets
- Data Packets Retransmitted
- Packets Received
- Completely Duplicate Packets
- Retransmit Timeouts

For the TCP statistics, compare the number of packets sent to the number of data packets retransmitted. If the number of packets retransmitted is over 10-15 percent of the total packets sent, TCP is experiencing timeouts indicating that network traffic may be too high for acknowledgments (ACKs) to return before a timeout. A bottleneck on the receiving node or general network problems can also cause TCP retransmissions, which will increase network traffic, further adding to any network performance problems.

Also, compare the number of packets received with the number of completely duplicate packets. If TCP on a sending node times out before an ACK is received from the receiving node, it will retransmit the packet. Duplicate packets occur when the receiving node eventually receives all the retransmitted packets. If the number of duplicate packets exceeds 10-15 percent, the problem may again be too much network traffic or a bottleneck at the receiving node. Duplicate packets increase network traffic.

The value for retransmit timeouts occurs when TCP sends a packet but does not receive an ACK in time. It then resends the packet. This value is incremented for any subsequent retransmittals. These continuous retransmittals drive CPU utilization higher, and if the receiving node does not receive the packet, it eventually will be dropped.

netstat -s: The **netstat -s** command shows statistics for each protocol (while the **netstat -p** command shows the statistics for the specified protocol).

netstat -s -s: The undocumented **-s -s** option shows only those lines of the **netstat -s** output that are not zero, making it easier to look for error counts.

netstat -s -Z: This is an undocumented function of the **netstat** command. It clears all the statistic counters for the **netstat -s** command to zero.

netstat -r: Another option relevant to performance is the display of the discovered Path Maximum Transmission Unit (PMTU).

For two hosts communicating across a path of multiple networks, a transmitted packet will become fragmented if its size is greater than the smallest MTU of any network in the path. Because packet fragmentation can result in reduced network performance, it is desirable to avoid fragmentation by transmitting packets with a size no larger than the smallest MTU in the network path. This size is called the *path MTU*.

Use the **netstat -r** command to display this value. In the following is example the **netstat -r -f inet** command is used to display only the routing tables:

```
# netstat -r -f inet
Routing tables
Destination      Gateway          Flags  Refs    Use  If  PMTU Exp Groups

Route tree for Protocol Family 2 (Internet):
default          res101141       UGc    0        0  en1  -   -
ausdns01.srv.ibm res101141       UGHW   1        4  en1  1500 -
10.1.14.0        server1         UHSb   0        0  en1  -   - =>
10.1.14/24       server1         U      3       112  en1  -   -
brown17          loopback       UGHS   6       110  lo0  -   -
10.1.14.255     server1         UHSb   0        0  en1  -   -
magenta          res1031041     UGHW   1        42  en1  -   -
127/8            loopback       U      6     16633  lo0  -   -
192.1.6.0        en6host1       UHSb   0        0  en0  -   - =>
192.1.6/24       en6host1       U      0        17  en0  -   -
en6host1         loopback       UGHS   0     16600  lo0  -   -
192.1.6.255     en6host1       UHSb   0        0  en0  -   -
192.6.0.0        fc0host1       UHSb   0        0  fc0  -   - =>
192.6.0/24       fc0host1       U      0        20  fc0  -   -
fc0host1         loopback       UGHS   0        0  lo0  -   -
192.6.0.255     fc0host1       UHSb   0        0  fc0  -   -
```

netstat -D: The **-D** option allows you to see packets coming into and going out of each layer in the communications subsystem along, with packets dropped at each layer.

```
# netstat -D

Source
-----
ent_dev1          32556          727           0           0
ent_dev2           0              1            0           0
ent_dev3           0              1            0           0
fcnet_dev0        24             22           0           0
fcnet_dev1         0              0            0           0
ent_dev0          14             15           0           0
-----
Devices Total      32594          766           0           0
-----
ent_dd1          32556          727           0           0
ent_dd2           0              2            0           1
ent_dd3           0              2            0           1
fcnet_dd0        24             22           0           0
fcnet_dd1         0              0            0           0
ent_dd0          14             15           0           0
-----
Drivers Total      32594          768           0           2
-----
fcs_dmx0          0              N/A           0           N/A
fcs_dmx1           0              N/A           0           N/A
ent_dmx1         31421          N/A          1149         N/A
ent_dmx2           0              N/A           0           N/A
ent_dmx3           0              N/A           0           N/A
fcnet_dmx0        0              N/A           0           N/A
fcnet_dmx1        0              N/A           0           N/A
```

| | | | | |
|-----------------|-------|-------|-------|-----|
| ent_dmx0 | 14 | N/A | 0 | N/A |
| Demuxer Total | 31435 | N/A | 1149 | N/A |
| IP | 46815 | 34058 | 64 | 8 |
| IPv6 | 0 | 0 | 0 | 0 |
| TCP | 862 | 710 | 9 | 0 |
| UDP | 12412 | 13 | 12396 | 0 |
| Protocols Total | 60089 | 34781 | 12469 | 8 |
| en_if1 | 31421 | 732 | 0 | 0 |
| fc_if0 | 24 | 22 | 0 | 0 |
| en_if0 | 14 | 20 | 0 | 6 |
| lo_if0 | 33341 | 33345 | 4 | 0 |
| Net IF Total | 64800 | 34119 | 4 | 6 |

(Note: N/A -> Not Applicable)

The Devices layer shows number of packets coming into the adapter, going out of the adapter, and number of packets dropped on input and output. There are various causes of adapter errors, and the **netstat -v** command can be examined for more details.

The Drivers layer shows packet counts handled by the device driver for each adapter. Output of the **netstat -v** command is useful here to determine which errors are counted.

The Demuxer values show packet counts at the demux layer, and Idrops here usually indicate that filtering has caused packets to be rejected (for example, Netware or DecNet packets being rejected because these are not handled by the system under examination).

Details for the Protocols layer can be seen in the output of the **netstat -s** command.

Note: In the statistics output, a N/A displayed in a field value indicates the count is not applicable. For the NFS/RPC statistics, the number of incoming packets that pass through RPC are the same packets which pass through NFS, so these numbers are not summed in the NFS/RPC Total field, hence the N/A. NFS has no outgoing packet or outgoing packet drop counters specific to NFS and RPC. Therefore, individual counts have a field value of N/A, and the cumulative count is stored in the NFS/RPC Total field.

The netpmon command

The **netpmon** command uses the trace facility to obtain a detailed picture of network activity during a time interval. Because it uses the trace facility, the **netpmon** command can be run only by a root user or by a member of the system group.

Also, the **netpmon** command cannot run together with any of the other trace-based performance commands such as **tprof** and **filemon**. In its usual mode, the **netpmon** command runs in the background while one or more application programs or system commands are being executed and monitored.

The **netpmon** command focuses on the following system activities:

- CPU usage
 - By processes and interrupt handlers
 - How much is network-related
 - What causes idle time
- Network device driver I/O
 - Monitors I/O operations through all Ethernet, Token-Ring, and Fiber-Distributed Data Interface (FDDI) network device drivers.

- In the case of transmission I/O, the command monitors utilizations, queue lengths, and destination hosts. For receive ID, the command also monitors time in the demux layer.
- Internet socket calls
 - Monitors **send()**, **recv()**, **sendto()**, **recvfrom()**, **sendmsg()**, **read()**, and **write()** subroutines on Internet sockets.
 - Reports statistics on a per-process basis for the Internet Control Message Protocol (ICMP), Transmission Control Protocol (TCP), and the User Datagram Protocol (UDP).
- NFS I/O
 - On client: RPC requests, NFS read/write requests.
 - On server: Per-client, per-file, read/write requests.

The following will be computed:

- Response times and sizes associated with transmit and receive operations at the device driver level.
- Response times and sizes associated with all types of Internet socket read and write system calls.
- Response times and sizes associated with NFS read and write system calls.
- Response times associated with NFS remote procedure call requests.

To determine whether the **netpmon** command is installed and available, run the following command:

```
# ls1pp -lI perfagent.tools
```

Tracing is started by the **netpmon** command, optionally suspended with the **trcoff** subcommand and resumed with the **trcon** subcommand, and terminated with the **trcstop** subcommand. As soon as tracing is terminated, the **netpmon** command writes its report to standard output.

Using netpmon

The **netpmon** command will start tracing immediately unless the **-d** option is used. Use the **trcstop** command to stop tracing. At that time, all the specified reports are generated, and the **netpmon** command exits. In the client-server environment, use the **netpmon** command to view how networking affects the overall performance. It can be run on both client and server.

The **netpmon** command can read the I/O trace data from a specified file, instead of from the real-time trace process. In this case, the **netpmon** report summarizes the network activity for the system and period represented by the trace file. This offline processing method is useful when it is necessary to postprocess a trace file from a remote machine or perform the trace data collection at one time and postprocess it at another time.

The **trcrpt -r** command must be executed on the trace logfile and redirected to another file, as follows:

```
# gennames > gennames.out
# trcrpt -r trace.out > trace.rpt
```

At this point, an adjusted trace logfile is fed into the **netpmon** command to report on I/O activity captured by a previously recorded trace session as follows:

```
# netpmon -i trace.rpt -n gennames.out | pg
```

In this example, the **netpmon** command reads file system trace events from the **trace.rpt** input file. Because the trace data is already captured on a file, the **netpmon** command does not put itself in the background to allow application programs to be run. After the entire file is read, a network activity report will be displayed on standard output (which, in this example, is piped to the **pg** command).

If the **trace** command was run with the **-C all** flag, then run the **trcrpt** command also with the **-C all** flag (see Formatting a Report from trace -C Output).

The following **netpmon** command running on an NFS server executes the **sleep** command and creates a report after 400 seconds. During the measured interval, a copy to an NFS-mounted file system **/nfs_mnt** is taking place.

```
# netpmon -o netpmon.out -0 all; sleep 400; trcstop
```

With the **-O** option, you can specify the report type to be generated. Valid report type values are:

- cpu** CPU usage
- dd** Network device-driver I/O
- so** Internet socket call I/O
- nfs** NFS I/O
- a11** All reports are produced. The following is the default value.

```
# cat netpmon.out
```

```
Fri Mar 5 15:41:52 2004
System: AIX crusade Node: 5 Machine: 000353534C00
```

```
=====
```

Process CPU Usage Statistics:

```
-----
```

| Process (top 20) | PID | CPU Time | CPU % | Network CPU % |
|-----------------------|-------|----------|--------|------------------|
| netpmon | 45600 | 0.6995 | 1.023 | 0.000 |
| nfsd | 50090 | 0.5743 | 0.840 | 0.840 |
| UNKNOWN | 56912 | 0.1274 | 0.186 | 0.000 |
| trcstop | 28716 | 0.0048 | 0.007 | 0.000 |
| gil | 3870 | 0.0027 | 0.004 | 0.004 |
| ksh | 42186 | 0.0024 | 0.003 | 0.000 |
| IBM.ServiceRMd | 14966 | 0.0021 | 0.003 | 0.000 |
| IBM.ERrmd | 6610 | 0.0020 | 0.003 | 0.000 |
| IBM.CSMAgentRMd | 15222 | 0.0020 | 0.003 | 0.000 |
| IBM.AuditRMd | 12276 | 0.0020 | 0.003 | 0.000 |
| syncd | 4766 | 0.0020 | 0.003 | 0.000 |
| sleep | 28714 | 0.0017 | 0.002 | 0.000 |
| swapper | 0 | 0.0012 | 0.002 | 0.000 |
| rpc.lockd | 34942 | 0.0007 | 0.001 | 0.000 |
| netpmon | 28712 | 0.0006 | 0.001 | 0.000 |
| trace | 54622 | 0.0005 | 0.001 | 0.000 |
| reaper | 2580 | 0.0003 | 0.000 | 0.000 |
| netm | 3612 | 0.0002 | 0.000 | 0.000 |
| aixmibd | 4868 | 0.0001 | 0.000 | 0.000 |
| xmgc | 3354 | 0.0001 | 0.000 | 0.000 |
| Total (all processes) | | 1.4267 | 2.087 | 0.844 |
| Idle time | | 55.4400 | 81.108 | |

```
-----
```

```
=====
```

First Level Interrupt Handler CPU Usage Statistics:

```
-----
```

| FLIH | CPU Time | CPU % | Network CPU % |
|-------------------|----------|--------|------------------|
| external device | 0.3821 | 0.559 | 0.559 |
| PPC decremter | 0.0482 | 0.070 | 0.000 |
| data page fault | 0.0137 | 0.020 | 0.000 |
| queued interrupt | 0.0002 | 0.000 | 0.000 |
| Total (all FLIHs) | | 0.4441 | 0.650 |

```
-----
```

=====
 Second Level Interrupt Handler CPU Usage Statistics:

| SLIH | CPU Time | CPU % | Network CPU % |
|-------------------|----------|-------|---------------|
| phxentdd32 | 2.4740 | 3.619 | 3.619 |
| Total (all SLIHs) | 2.4740 | 3.619 | 3.619 |

=====

Network Device-Driver Statistics (by Device):

| Device | Xmit | | | | Recv | | |
|------------|---------|----------|------|--------|---------|---------|--------|
| | Pkts/s | Bytes/s | Util | QLen | Pkts/s | Bytes/s | Demux |
| ethernet 4 | 7237.33 | 10957295 | 0.0% | 27.303 | 3862.63 | 282624 | 0.2324 |

=====

Network Device-Driver Transmit Statistics (by Destination Host):

| Host | Pkts/s | Bytes/s |
|----------------|---------|----------|
| client_machine | 7237.33 | 10957295 |

=====

NFS Server Statistics (by Client):

| Client | Read | | Write | | Other |
|---------------------|---------|---------|---------|---------|---------|
| | Calls/s | Bytes/s | Calls/s | Bytes/s | Calls/s |
| client_machine | 0.00 | 0 | 0.00 | 0 | 321.15 |
| Total (all clients) | 0.00 | 0 | 0.00 | 0 | 321.15 |

=====

Detailed Second Level Interrupt Handler CPU Usage Statistics:

SLIH: phxentdd32
 count: 33256
 cpu time (msec): avg 0.074 min 0.018 max 288.374 sdev 1.581

COMBINED (All SLIHs)
 count: 33256
 cpu time (msec): avg 0.074 min 0.018 max 288.374 sdev 1.581

=====

Detailed Network Device-Driver Statistics:

DEVICE: ethernet 4
 recv packets: 33003
 recv sizes (bytes): avg 73.2 min 60 max 618 sdev 43.8
 recv times (msec): avg 0.000 min 0.000 max 0.005 sdev 0.000
 demux times (msec): avg 0.060 min 0.004 max 288.360 sdev 1.587
 xmit packets: 61837
 xmit sizes (bytes): avg 1514.0 min 1349 max 1514 sdev 0.7
 xmit times (msec): avg 3.773 min 2.026 max 293.112 sdev 8.947

```

=====
Detailed Network Device-Driver Transmit Statistics (by Host):
-----

HOST: client_machine (10.4.104.159)
xmit packets:      61837
  xmit sizes (bytes):  avg 1514.0  min 1349   max 1514   sdev 0.7
  xmit times (msec):  avg 3.773   min 2.026  max 293.112 sdev 8.947
=====

Detailed NFS Server Statistics (by Client):
-----

CLIENT: client_machine
other calls:      2744
  other times (msec):  avg 0.192   min 0.075  max 0.311   sdev 0.025

COMBINED (All Clients)
other calls:      2744
  other times (msec):  avg 0.192   min 0.075  max 0.311   sdev 0.025

```

The output of the **netpmon** command is composed of two different types of reports: *global* and *detailed*. The global reports list statistics as follows:

- Most active processes
- First-level interrupt handlers
- Second-level interrupt handlers
- Network device drivers
- Network device-driver transmits
- TCP socket calls
- NFS server or client statistics

The global reports are shown at the beginning of the **netpmon** output and are the occurrences during the measured interval. The detailed reports provide additional information for the global reports. By default, the reports are limited to the 20 most active statistics measured. All information in the reports is listed from top to bottom as most active to least active.

Global reports of the netpmon command

The reports generated by the **netpmon** command begin with a header, which identifies the date, the machine ID, and the length of the monitoring period in seconds. The header is followed by a set of global and detailed reports for all specified report types.

Process CPU usage statistics: Each row describes the CPU usage associated with a process. Unless the verbose (**-v**) option is specified, only the 20 most active processes are included in the list. At the bottom of the report, CPU usage for all processes is totaled, and CPU idle time is reported. The idle time percentage number is calculated from the idle time divided by the measured interval. The difference between the CPU time totals and measured interval is due to Interrupt handlers.

The Network CPU % is the percentage of total time that this process spent executing network-related code.

If the **-t** flag is used, a thread CPU usage statistic is also present. Each process row described above is immediately followed by rows describing the CPU usage of each thread owned by that process. The fields in these rows are identical to those for the process, except for the name field. Threads are not named.

In the example report, the Idle time percentage number (81.104 percent) shown in the global CPU usage report is calculated from the Idle time (55.4400) divided by the measured interval times 8 (8.54 secs times 8), because there are eight CPUs in this server. If you want to look at each CPU's activity, you can use **sar**, **ps**, or any other SMP-specific command. Similar calculation applies to the total CPU % that is occupied by all processes. The Idle time is due to network I/O. The difference between the CPU Time totals (55.4400 + 1.4267) and the measured interval is due to interrupt handlers and the multiple CPUs. It appears that in the example report, the majority of the CPU usage was network-related: (0.844 / 2.087) = 40.44 percent.

Note: If the result of total network CPU % divided by total CPU % is greater than 0.5 from Process CPU Usage Statistics for NFS server, then the majority of CPU usage is network-related.

This method is also a good way to view CPU usage by process without tying the output to a specific program.

First Level Interrupt Handler CPU Usage Statistics: Each row describes the CPU usage associated with a first-level interrupt handler (FLIH). At the bottom of the report, CPU usage for all FLIHs is totaled.

CPU Time

Total amount of CPU time used by this FLIH

CPU %

CPU usage for this interrupt handler as a percentage of total time

Network CPU %

Percentage of total time that this interrupt handler executed on behalf of network-related events

Second Level Interrupt Handler CPU Usage Statistics: Each row describes the CPU usage associated with a second-level interrupt handler (SLIH). At the bottom of the report, CPU usage for all SLIHs is totaled.

Network Device-Driver Statistics (by Device): Each row describes the statistics associated with a network device.

Device

Name of special file associated with device

Xmit Pkts/s

Packets per second transmitted through this device

Xmit Bytes/s

Bytes per second transmitted through this device

Xmit Util

Busy time for this device, as a percent of total time

Xmit QLen

Number of requests waiting to be transmitted through this device, averaged over time, including any transaction currently being transmitted

Recv Pkts/s

Packets per second received through this device

Recv Bytes/s

Bytes per second received through this device

Recv Demux

Time spent in demux layer as a fraction of total time

In this example, the Xmit QLen is 27.303. Its Recv Bytes/s is 10957295 (10.5 MB/sec), which is close to the wire limit for a 100 Mbps Ethernet. Therefore, in this case, the network is almost saturated.

Network Device-Driver Transmit Statistics (by Destination Host): Each row describes the amount of transmit traffic associated with a particular destination host, at the device-driver level.

Host Destination host name. An asterisk (*) is used for transmissions for which no host name can be determined.

Pkts/s Packets per second transmitted to this host.

Bytes/s

Bytes per second transmitted to this host.

TCP Socket Call Statistics for Each Internet Protocol (by Process): These statistics are shown for each used Internet protocol. Each row describes the amount of **read()** and **write()** subroutine activity on sockets of this protocol type associated with a particular process. At the bottom of the report, all socket calls for this protocol are totaled.

NFS Server Statistics (by Client): Each row describes the amount of NFS activity handled by this server on behalf of a particular client. At the bottom of the report, calls for all clients are totaled.

On a client machine, the NFS server statistics are replaced by the NFS client statistics (NFS Client Statistics for each Server (by File), NFS Client RPC Statistics (by Server), NFS Client Statistics (by Process)).

Detailed Reports of netpmon

Detailed reports are generated for all requested (-O) report types. For these report types, a detailed report is produced in addition to the global reports. The detailed reports contain an entry for each entry in the global reports with statistics for each type of transaction associated with the entry.

Transaction statistics consist of a count of the number of transactions for that type, followed by response time and size distribution data (where applicable). The distribution data consists of average, minimum, and maximum values, as well as standard deviations. Roughly two-thirds of the values are between average minus standard deviation and average plus standard deviation. Sizes are reported in bytes. Response times are reported in milliseconds.

Detailed Second-Level Interrupt Handler CPU-Usage Statistics: The output fields are described as follows:

SLIH Name of second-level interrupt handler

count Number of interrupts of this type

cpu time (msec)

CPU usage statistics for handling interrupts of this type

Detailed Network Device-Driver Statistics (by Device): The output fields are described as follows:

DEVICE

Path name of special file associated with device

recv packets

Number of packets received through this device

recv sizes (bytes)

Size statistics for received packets

recv times (msec)

Response time statistics for processing received packets

demux times (msec)

Time statistics for processing received packets in the demux layer

xmit packets

Number of packets transmitted through this device

xmit sizes (bytes)

Size statistics for transmitted packets

xmit times (msec)

Response time statistics for processing transmitted packets

There are other detailed reports, such as Detailed Network Device-Driver Transmit Statistics (by Host) and Detailed TCP Socket Call Statistics for Each Internet Protocol (by Process). For an NFS client, there are the Detailed NFS Client Statistics for Each Server (by File), Detailed NFS Client RPC Statistics (by Server), and Detailed NFS Client Statistics (by Process) reports. For an NFS server, there is the Detailed NFS Server Statistics (by Client) report. They have similar output fields as explained above.

In the example, the results from the Detailed Network Device-Driver Statistics lead to the following:

- $\text{recv bytes} = 33003 \text{ packets} * 73.2 \text{ bytes/packet} = 2,415,819.6 \text{ bytes}$
- $\text{xmit bytes} = 61837 \text{ packets} * 1514 \text{ bytes/packet} = 93,621,218 \text{ bytes}$
- $\text{total bytes exchanged} = 2,415,819.6 + 93,621,218 = 96,037,037.6 \text{ bytes}$
- $\text{total bits exchanged} = 96,037,037.6 * 8 \text{ bits/byte} = 768,296,300.8 \text{ bits}$
- $\text{network speed} = 768,296,300.8 / 8.54 = 89,964,438 \text{ bits/sec}$ (approximately 90 Mbps) - assuming the NFS copy took the whole amount of tracing

As in the global device driver report, you can conclude that this case is almost network-saturated. The average receive size is 73.2 bytes, and reflects the fact that the NFS server which was traced, received acknowledgements for the data it sent. The average send size is 1514 bytes, which is the default MTU (maximum transmission unit) for Ethernet devices. *interface*, replacing *interface* with the interface name, such as `en0` or `tr0`, you could change the MTU or adapter transmit-queue length value to get better performance with the following command:

```
# ifconfig tr0 mtu 8500
```

or

```
# chdev -l 'tok0' -a xmt_que_size='150'
```

If the network is congested already, changing the MTU or queue value will not help.

Notes:

1. If transmit and receive packet sizes are small on the device driver statistics report, then increasing the current MTU size will probably result in better network performance.
2. If system wait time due to network calls is high from the network wait time statistics for the NFS client report, the poor performance is due to the network.

Limitations of the netpmon command

The **netpmon** command uses the trace facility to collect the statistics. Therefore, it has an impact on the system workload, as follows.

- In a moderate, network-oriented workload, the **netpmon** command increases overall CPU utilization by 3-5 percent.
- In a CPU-saturated environment with little I/O of any kind, the **netpmon** command slowed a large compile by about 3.5 percent.

To alleviate these situations, use offline processing and on systems with many CPUs use the **-C all** flag with the **trace** command.

The traceroute command

While the **ping** command confirms IP network reachability, you cannot pinpoint and improve some isolated problems. Consider the following situation:

- When there are many hops (for example, gateways or routes) between your system and the destination, and there seems to be a problem somewhere along the path. The destination system may have a problem, but you need to know where a packet is actually lost.
- The **ping** command hangs up and does not tell you the reasons for a lost packet.

The **traceroute** command can inform you where the packet is located and why the route is lost. If your packets must pass through routers and links, which belong to and are managed by other organizations or companies, it is difficult to check the related routers through the **telnet** command. The **traceroute** command provides a supplemental role to the **ping** command.

Note: The **traceroute** command is intended for use in network testing, measurement, and management. It should be used primarily for manual fault isolation. Because of the load it imposes on the network, do not use the **traceroute** command during typical operations or from automated scripts.

Successful traceroute examples

The **traceroute** command uses UDP packets and uses the ICMP error-reporting function. It sends a UDP packet three times to each gateway or router on the way. It starts with the nearest gateway and expands the search by one hop. Finally, the search gets to the destination system. In the output, you see the gateway name, the gateway's IP address, and three round-trip times for the gateway. See the following example:

```
# traceroute aix1
trying to get source for aix1
source should be 10.53.155.187
traceroute to aix1.austin.ibm.com (10.53.153.120) from 10.53.155.187 (10.53.155.187), 30 hops max
outgoing MTU = 1500
 1 10.111.154.1 (10.111.154.1) 5 ms 3 ms 2 ms
 2 aix1 (10.53.153.120) 5 ms 5 ms 5 ms
```

Following is another example:

```
# traceroute aix1
trying to get source for aix1
source should be 10.53.155.187
traceroute to aix1.austin.ibm.com (10.53.153.120) from 10.53.155.187 (10.53.155.187), 30 hops max
outgoing MTU = 1500
 1 10.111.154.1 (10.111.154.1) 10 ms 2 ms 3 ms
 2 aix1 (10.53.153.120) 8 ms 7 ms 5 ms
```

After the address resolution protocol (ARP) entry expired, the same command was repeated. Note that the first packet to each gateway or destination took a longer round-trip time. This is due to the overhead caused by the ARP. If a public-switched network (WAN) is involved in the route, the first packet consumes a lot of memory due to a connection establishment and may cause a timeout. The default timeout for each packet is 3 seconds. You can change it with the **-w** option.

The first 10 ms is due to the ARP between the source system (9.53.155.187) and the gateway 9.111.154.1. The second 8 ms is due to the ARP between the gateway and the final destination (wave). In this case, you are using DNS, and every time before the **traceroute** command sends a packet, the DNS server is searched.

Failed traceroute examples

For a long path to your destination or complex network routes, you may see a lot of problems with the **traceroute** command. Because many things are implementation-dependent, searching for the problem may only waste your time. If all routers or systems involved are under your control, you may be able to investigate the problem completely.

Gateway (Router) problem: In the following example, packets were sent from the system 9.53.155.187. There are two router systems on the way to the bridge. The routing capability was intentionally removed from the second router system by setting the option **ipforwarding** of the **no** command to 0. See the following example:

```
# traceroute lamar
trying to get source for lamar
source should be 9.53.155.187
traceroute to lamar.austin.ibm.com (9.3.200.141) from 9.53.155.187 (9.53.155.187), 30 hops max
outgoing MTU = 1500
 1 9.111.154.1 (9.111.154.1) 12 ms 3 ms 2 ms
 2 9.111.154.1 (9.111.154.1) 3 ms !H * 6 ms !H
```

If an ICMP error message, excluding Time Exceeded and Port Unreachable, is received, it is displayed as follows:

```
!H    Host Unreachable
!N    Network Unreachable
!P    Protocol Unreachable
!S    Source route failed
!F    Fragmentation needed
```

Destination system problem: When the destination system does not respond within a 3-second time-out interval, all queries are timed out, and the results are displayed with an asterisk (*).

```
# traceroute chuys
trying to get source for chuys
source should be 9.53.155.187
traceroute to chuys.austin.ibm.com (9.53.155.188) from 9.53.155.187 (9.53.155.187), 30 hops max
outgoing MTU = 1500
 1 * * *
 2 * * *
 3 * * *
^C#
```

If you think that the problem is due to a communication link, use a longer timeout period with the **-w** flag. Although rare, all the ports queried might have been used. You can change the ports and try again.

Number of "hops" to destination: Another output example might be as follows:

```
# traceroute mysystem.university.edu (129.2.130.22)
traceroute to mysystem.university.edu (129.2.130.22), 30 hops max
 1 helios.ee.lbl.gov (129.3.112.1) 0 ms 0 ms 0 ms
 2 lilac-dmc.university.edu (129.2.216.1) 39 ms 19 ms 39 ms
 3 lilac-dmc.university.edu (129.2.215.1) 19 ms 39 ms 19 ms
 4 ccngw-ner-cc.university.edu (129.2.135.23) 39 ms 40 ms 19 ms
 5 ccn-nerif35.university.edu (129.2.167.35) 39 ms 39 ms 39 ms
 6 csgw/university.edu (129.2.132.254) 39 ms 59 ms 39 ms
 7 * * *
 8 * * *
 9 * * *
10 * * *
11 * * *
12 * * *
13 rip.university.EDU (129.2.130.22) 59 ms! 39 ms! 39 ms!
```

In this example, exactly half of the 12 gateway hops (13 is the final destination) are "missing." However, these hops were actually not gateways. The destination host used the time to live (ttl) from the arriving datagram as the ttl in its ICMP reply; thus, the reply timed out on the return path. Because ICMPs are not sent for ICMPs, no notice was received. The ! (exclamation mark) after each round-trip time indicates some type of software incompatibility problem. (The cause was diagnosed after the **traceroute** command issued a probe of twice the path length. The destination host was really only seven hops away.)

The iptrace daemon, and the ipreport and ipfilter commands

You can use many tools for observing network activity. Some run under the operating system, others run on dedicated hardware. One tool that can be used to obtain a detailed, packet-by-packet description of the LAN activity generated by a workload is the combination of the **iptrace** daemon and the **ipreport** command. To use the **iptrace** daemon with operating system version 4, you need the **bos.net.tcp.server** fileset. The **iptrace** daemon is included in this fileset, as well as some other useful commands such as the **trpt** and **tcdump** commands. The **iptrace** daemon can only be started by a root user.

By default, the **iptrace** daemon traces all packets. The option **-a** allows exclusion of address resolution protocol (ARP) packets. Other options can narrow the scope of tracing to a particular source host (**-s**), destination host (**-d**), or protocol (**-p**). Because the **iptrace** daemon can consume significant amounts of processor time, be as specific as possible when you describe the packets you want traced.

Because **iptrace** is a daemon, start the **iptrace** daemon with the **startsrc** command rather than directly from the command line. This method makes it easier to control and shut down cleanly. A typical example would be as follows:

```
# startsrc -s iptrace -a "-i en0 /home/user/iptrace/log1"
```

This command starts the **iptrace** daemon with instructions to trace all activity on the Gigabit Ethernet interface, en0, and place the trace data in **/home/user/iptrace/log1**. To stop the daemon, use the following:

```
# stopsrc -s iptrace
```

If you did not start the **iptrace** daemon with the **startsrc** command, you must use the **ps** command to find its process ID with and terminate it with the **kill** command.

The **ipreport** command is a formatter for the log file. Its output is written to standard output. Options allow recognition and formatting of RPC packets (**-r**), identifying each packet with a number (**-n**), and prefixing each line with a 3-character string that identifies the protocol (**-s**). A typical **ipreport** command to format the **log1** file just created (which is owned by the root user) would be as follows:

```
# ipreport -ns log1 >log1_formatted
```

This would result in a sequence of packet reports similar to the following examples. The first packet is the first half of a **ping** packet. The fields of most interest are as follows:

- The source (SRC) and destination (DST) host address, both in dotted decimal and in ASCII
- The IP packet length (ip_len)
- The indication of the higher-level protocol in use (ip_p)

```
Packet Number 7
ETH: ====( 98 bytes transmitted on interface en0 )==== 10:28:16.516070112
ETH: [ 00:02:55:6a:a5:dc -> 00:02:55:af:20:2b ] type 800 (IP)
IP: < SRC = 192.1.6.1 > (en6host1)
IP: < DST = 192.1.6.2 > (en6host2)
IP: ip_v=4, ip_hl=20, ip_tos=0, ip_len=84, ip_id=1789, ip_off=0
IP: ip_ttl=255, ip_sum=28a6, ip_p = 1 (ICMP)
ICMP: icmp_type=8 (ECHO_REQUEST) icmp_id=18058 icmp_seq=3
```

```
Packet Number 8
ETH: ====( 98 bytes received on interface en0 )==== 10:28:16.516251667
ETH: [ 00:02:55:af:20:2b -> 00:02:55:6a:a5:dc ] type 800 (IP)
IP: < SRC = 192.1.6.2 > (en6host2)
IP: < DST = 192.1.6.1 > (en6host1)
IP: ip_v=4, ip_hl=20, ip_tos=0, ip_len=84, ip_id=11325, ip_off=0
IP: ip_ttl=255, ip_sum=366, ip_p = 1 (ICMP)
ICMP: icmp_type=0 (ECHO_REPLY) icmp_id=18058 icmp_seq=3
```

The next example is a frame from an **ftp** operation. Note that the IP packet is the size of the MTU for this LAN (1492 bytes).

```

Packet Number 20
ETH: ==== ( 1177 bytes transmitted on interface en0 )==== 10:35:45.432353167
ETH: [ 00:02:55:6a:a5:dc -> 00:02:55:af:20:2b ] type 800 (IP)
IP: < SRC = 192.1.6.1 > (en6host1)
IP: < DST = 192.1.6.2 > (en6host2)
IP: ip_v=4, ip_hl=20, ip_tos=8, ip_len=1163, ip_id=1983, ip_off=0
IP: ip_ttl=60, ip_sum=e6a0, ip_p = 6 (TCP)
TCP: <source port=32873, destination port=20(ftp-data) >
TCP: th_seq=623eabdc, th_ack=973dcd95
TCP: th_off=5, flags<PUSH | ACK>
TCP: th_win=17520, th_sum=0, th_urp=0
TCP: 00000000 69707472 61636520 322e3000 00008240 | iptrace 2.0...@
TCP: 00000010 2e4c9d00 00000065 6e000065 74000053 | .L....en..et..S
TCP: 00000020 59535841 49584906 01000040 2e4c9d1e | YSXAIXI...@.L..
TCP: 00000030 c0523400 0255af20 2b000255 6aa5dc08 | .R4..U. +..Uj...
TCP: 00000040 00450000 5406f700 00ff0128 acc00106 | .E..T.....(....
TCP: 00000050 01c00106 0208005a 78468a00 00402e4c | .....ZxF...@.L
TCP: 00000060 9d0007df 2708090d 0a0b0c0d 0e0f1011 | .....!.....
TCP: 00000070 12131415 16171819 1a1b1c1d 1e1f2021 | .....!
TCP: 00000080 22232425 26272829 2a2b2c2d 2e2f3031 | "#$%&'()*+,-./01
TCP: 00000090 32333435 36370000 0082402e 4c9d0000 | 234567....@.L...
----- Lots of uninteresting data omitted -----
TCP: 00000440 15161718 191a1b1c 1d1e1f20 21222324 | .....! "#$
TCP: 00000450 25262728 292a2b2c 2d2e2f30 31323334 | %&'()*+,-./01234
TCP: 00000460 353637 | 567

```

The **ipfilter** command extracts different operation headers from an **ipreport** output file and displays them in a table. Some customized NFS information regarding requests and replies is also provided.

To determine whether the **ipfilter** command is installed and available, run the following command:

```
# ls1pp -lI perfagent.tools
```

An example command is as follows:

```
# ipfilter log1_formatted
```

The operation headers currently recognized are: udp, nfs, tcp, ipx, icmp. The **ipfilter** command has three different types of reports, as follows:

- A single file (**ipfilter.all**) that displays a list of all the selected operations. The table displays packet number, Time, Source & Destination, Length, Sequence #, Ack #, Source Port, Destination Port, Network Interface, and Operation Type.
- Individual files for each selected header (**ipfilter.udp**, **ipfilter.nfs**, **ipfilter.tcp**, **ipfilter.ipx**, **ipfilter.icmp**). The information contained is the same as **ipfilter.all**.
- A file **nfs.rpt** that reports on NFS requests and replies. The table contains: Transaction ID #, Type of Request, Status of Request, Call Packet Number, Time of Call, Size of Call, Reply Packet Number, Time of Reply, Size of Reply, and Elapsed millisecond between call and reply.

Adapter statistics

The commands in this section provide output comparable to the **netstat -v** command. They allow you to reset adapter statistics (**-r**) and to get more detailed output (**-d**) than the **netstat -v** command output provides.

The entstat command

The **entstat** command displays the statistics gathered by the specified Ethernet device driver. The user can optionally specify that the device-specific statistics be displayed in addition to the device-generic statistics. Using the **-d** option will list any extended statistics for this adapter and should be used to ensure all statistics are displayed. If no flags are specified, only the device-generic statistics are displayed.

The **entstat** command is also invoked when the **netstat** command is run with the **-v** flag. The **netstat** command does not issue any **entstat** command flags.

```
# entstat ent0
```

```
-----  
ETHERNET STATISTICS (ent0) :  
Device Type: 10/100/1000 Base-TX PCI-X Adapter (14106902)  
Hardware Address: 00:02:55:6a:a5:dc  
Elapsed Time: 1 days 18 hours 47 minutes 34 seconds
```

```
Transmit Statistics:                Receive Statistics:  
-----  
Packets: 1108055                    Packets: 750811  
Bytes: 4909388501                  Bytes: 57705832  
Interrupts: 0                       Interrupts: 681137  
Transmit Errors: 0                  Receive Errors: 0  
Packets Dropped: 0                 Packets Dropped: 0  
Bad Packets: 0
```

```
Max Packets on S/W Transmit Queue: 101  
S/W Transmit Queue Overflow: 0  
Current S/W+H/W Transmit Queue Length: 0
```

```
Broadcast Packets: 3                Broadcast Packets: 3  
Multicast Packets: 3                Multicast Packets: 5  
No Carrier Sense: 0                 CRC Errors: 0  
DMA Underrun: 0                     DMA Overrun: 0  
Lost CTS Errors: 0                  Alignment Errors: 0  
Max Collision Errors: 0              No Resource Errors: 0  
Late Collision Errors: 0             Receive Collision Errors: 0  
Deferred: 0                          Packet Too Short Errors: 0  
SQE Test: 0                          Packet Too Long Errors: 0  
Timeout Errors: 0                   Packets Discarded by Adapter: 0  
Single Collision Count: 0            Receiver Start Count: 0  
Multiple Collision Count: 0  
Current HW Transmit Queue Length: 0
```

```
General Statistics:  
-----
```

```
No mbuf Errors: 0  
Adapter Reset Count: 0  
Adapter Data Rate: 2000  
Driver Flags: Up Broadcast Running  
Simplex 64BitSupport ChecksumOffload  
PrivateSegment LargeSend DataRateSet
```

In the above report, you may want to concentrate on:

Transmit Errors

Number of output errors encountered on this device. This is a counter for unsuccessful transmissions due to hardware/network errors.

Receive Errors

Number of input errors encountered on this device. This is a counter for unsuccessful reception due to hardware/network errors.

Packets Dropped

Number of packets accepted by the device driver for transmission which were not (for any reason) given to the device.

Max Packets on S/W Transmit Queue

Maximum number of outgoing packets ever queued to the software transmit queue.

S/W Transmit Queue Overflow

Number of outgoing packets that have overflowed the transmit queue.

No Resource Errors

Number of incoming packets dropped by the hardware due to lack of resources. This error usually

occurs because the receive buffers on the adapter were exhausted. Some adapters may have the size of the receive buffers as a configurable parameter. Check the device configuration attributes (or SMIT helps) for possible tuning information.

Single Collision Count/Multiple Collision Count

Number of collisions on an Ethernet network. These collisions are accounted for here rather than in the collision column of the output of the **netstat -i** command.

Notice in this example, the Ethernet adapter is behaving well because there are no Receive Errors. These errors are sometimes caused when a saturated network only transmits partial packets. The partial packets are eventually retransmitted successfully but are recorded as receive errors.

If you receive S/W Transmit Queue Overflow errors, the value of Max Packets on S/W Transmit Queue will correspond to the transmit queue limit for this adapter (**xmt_que_size**).

Note: These values can represent the *hardware queue* if the adapter does not support a software transmit queue. If there are transmit-queue overflows, then increased the hardware or software queue limits for the driver.

If there are not enough receive resources, this would be indicated by Packets Dropped: and depending on the adapter type, would be indicated by Out of Rcv Buffers or No Resource Errors: or some similar counter.

The elapsed time displays the real-time period that has elapsed since the last time the statistics were reset. To reset the statistics, use the **entstat -r adapter_name** command.

Similar output can be displayed for Token-Ring, FDDI, and ATM interfaces using the **tokstat**, **fddistat**, and **atmstat** commands.

The tokstat command

The **tokstat** command displays the statistics gathered by the specified Token-Ring device driver. The user can optionally specify that the device-specific statistics be displayed in addition to the device driver statistics. If no flags are specified, only the device driver statistics are displayed.

This command is also invoked when the **netstat** command is run with the **-v** flag. The **netstat** command does not issue any **tokstat** command flags.

The output produced by the **tokstat tok0** command and the problem determination are similar to that described in The entstat command.

The fddistat command

The **fddistat** command displays the statistics gathered by the specified FDDI device driver. The user can optionally specify that the device-specific statistics be displayed in addition to the device driver statistics. If no flags are specified, only the device driver statistics are displayed.

This command is also invoked when the **netstat** command is run with the **-v** flag. The **netstat** command does not issue any **fddistat** command flags.

The output produced by the **fddistat fddi0** command and the problem determination are similar to that described in The entstat command.

The atmstat command

The **atmstat** command displays the statistics gathered by the specified ATM device driver. The user can optionally specify that the device-specific statistics be displayed in addition to the device driver statistics. If no flags are specified, only the device driver statistics are displayed.

The output produced by the **atmstat atm0** command and the problem determination are similar to that described in The **entstat** command.

The **no** command

Use the **no** command to display current network values and to change options.

- a** Prints all options and current values (example: **no -a**)
- d** Sets options back to default (example: **no -d thewall**)
- o** *option=NewValue* (example: **no -o thewall=16384**)

For a listing of all attributes for the **no** command, see Network Option Tunable Parameters.

Some network attributes are run-time attributes that can be changed at any time. Others are load-time attributes that must be set before the **netinet** kernel extension is loaded.

Note: When the **no** command is used to change parameters, the change is in effect only until the next system boot. At that point, all parameters are initially reset to their defaults. To make the change permanent, put the appropriate **no** command in the **/etc/rc.net** file.

If your system uses Berkeley-style network configuration, set the attributes near the top of the **/etc/rc.bsdnet** file. If you use an SP system, edit the **tuning.cust** file as documented in the *RS/6000 SP: Installation and Relocation* manual.

Note: The **no** command performs no-range checking. If it is used incorrectly, the **no** command can cause your system to become inoperable.

The following tuning sections discuss some of the **no** command attributes and how to adjust them.

Tuning the SP Network

This section provides information about network tunable parameters that need special attention in an SP environment. For a more detailed discussion on SP tuning, see *RS/6000 SP System Performance Tuning*.

SP Switch Statistics

Note: The commands in this section are SP-specific.

The **estat** Command

The unsupported and undocumented **estat** command can be helpful in determining SP Switch problems. The **entstat** command is located in the **/usr/lpp/ssp/css** directory and produces output similar to the **entstat** command. The output contains sections for transmit, receive, and general statistics.

The output that is helpful in determining SP Switch problems is Transmit Errors, Receive Errors, Packets Dropped, and No mbuf Errors. The second line in the output indicates how long the adapter has been online.

The **vidlxxxx** Commands

These unsupported and undocumented commands display the SP Switch pool usage since the SP Switch was last started. There are several commands called **vidlxxxx** (where **vidl3** is for an MCA-based node, **vidl3mx** for a 332 MHz node, and **vidl3pci** for the S70 and S7A). These commands are found in the **/usr/lpp/ssp/css** directory on each node. For the SP Switch, only the send pool is used because microcode in the adapter manages the receive pool.

Following is an example for the **vidl3** command:

```

# /usr/lpp/ssp/css/vdid13 -i
send pool: size=524288 anchor=0x50002c00 start=0x50dc0000 tags=0x50001d00
bkt  allocd      free  success      fail  split      comb      freed
 12      0         0         0           0     1         0         0
 13      0         0         0           0     0         0         0
 14      0         0         0           0     0         0         0
 15      0         0         0           0     0         0         0
 16      0         8         0           0     0         0         0
rsvd pool: size=262144 anchor=0x50002000 start=0x50e40000 tags=0x50b84680
bkt  allocd      free  success      fail  split      comb      freed
 12      0         0         0           0     0         0         0
 13      0         0         0           0     0         0         0
 14      0         0         0           0     0         0         0
 15      0         0         0           0     0         0         0
 16      0         4         0           0     0         0         0
rcv pool: size=524288 anchor=0x50002e00 start=0x50e80000 tags=0x50001e00
bkt  allocd      free  success      fail  split      comb      freed
 12      0         0         0           0     0         0         0
 13      0         0         0           0     0         0         0
 14      0         0         0           0     0         0         0
 15      0         0         0           0     0         0         0
 16      0         0         0           0     0         0         0

```

Interpret the output carefully because some of the statistics have several meanings. For the SP Switch, only the send pool is used because the receive pool is managed by microcode in the adapter. Each column is described as follows:

bkt Lists the pool allocation in powers of 2 for the line it is on. The line starting with 12 means 2 to the 12th or 4 KB allocations, and the line starting with 16 means 2 to the 16th or 64 KB allocations.

allocd Lists the current allocations at the time the command was run, for each of the size allocations in the first column. This "snapshot" value fluctuates between successive executions of the command.

free Lists the number of buffers of each allocation that are allocated and unused at the time the command was run. In the above example, eight 64 K allocations are free for use. This instantaneous value can fluctuate between successive executions of the command.

success

This counter increments every time an allocation of the given size succeeded. This counter is cumulative, so it shows the number of successes since the adapter was last initialized.

fail

This counter is incremented every time an allocation is not available for the size requested. However, it is possible that the allocation is made by splitting up a larger allocation, or combining smaller ones into the size needed. A fail does *not* necessarily mean a packet was dropped. It is also possible that an allocation was split from a larger allocation without incurring a failed count. This counter is cumulative, so it shows the number of fails since the adapter was last initialized.

split

This counter indicates how many times the allocation size was extracted from the pool by carving the size needed from a larger allocation in the pool. This counter is cumulative, so it shows the number of splits since the adapter was last initialized.

comb This field is currently not used.

freed This field is currently not used.

SP System-Specific Tuning Recommendations

The following are specific details for setting the network tunables for the SP system.

arptab_bsiz

Number of ARP cache entries in each bucket (default = 7). See the following table for recommendations.

arptab_nb

Number of ARP cache buckets (default = 25). See the following table for recommendations.

CSS MTU size

The recommended MTU of a switch is 65520. However, under some circumstances (for example, when you want to avoid the Nagle algorithm causing very slow traffic), it may be necessary to reduce this value. You can reduce the MTU of a switch to 32678 with only a 2 to 10 percent loss in throughput. However, CPU utilization will be slightly higher due to the per-packet overhead. To reduce the MTU of the switch, run the following:

```
ifconfig css0 mtu new_size
```

This command takes effect immediately and must be run as root user. Always use the same MTU across all nodes in an SP.

rfc1323

See rfc1323.

sb_max

See TCP Socket Buffer Tuning.

tcp_mssdflt

See When to Use the tcp_mssdflt Option of the no Command.

tcp_sendspace and tcp_recvspace

See TCP Socket Buffer Tuning. These parameters should never be higher than the major network adapter transmit queue limit. To calculate this limit, use:
*(major adapter queue size) * (major network adapter MTU)*

thewall

See Tuning Network Memory.

udp_sendspace and udp_recvspace

See UDP Socket Buffer Tuning.

By default, the maximum number of ARP entries allowed is 175 (25 * 7). This default value of 175 might not be large enough in SP environments with many nodes. An inadequate number of slots in the ARP cache will slow the performance of nodes in the system. Use the following table to estimate optimal values for the **arptab_nb** and **arptab_bsiz** variables.

| Number of Nodes | arptab_nb | Number of Interfaces | arptab_bsiz |
|-----------------|-----------|----------------------|------------------------------|
| 1 - 64 | 25 | 1 - 3 | 7 |
| 65 - 128 | 64 | 4 | 8 |
| 129 - 256 | 128 | 5 | 10 |
| 257 - 512 | 256 | more... | 2 times number of interfaces |

In general, **arptab_nb** increases monotonically with the number of nodes and **arptab_bsiz** with the number of IP interfaces in an SP system.

These parameters must be placed in the first section of the **/etc/rc.net** file in front of the configuration methods.

Managing Tunable SP Parameters

The SP usually requires that tunable settings be changed from the default values in order to achieve optimal performance of the entire system. Placement of these tunable values is crucial. If they are not set in the correct places, subsequent rebooting of the nodes or other changes can cause them to change or be lost.

For all dynamically tunable values (those that take effect immediately), the setting for each node should be set in the **tuning.cust** file. This file is found in the **/ftfboot** directory on each node. There is also a copy

of the file in this same directory on the Control Work Station (CWS). Tunable parameters changed using the **no**, **nfso** or **vmtune** command can be included in this file. Even though the sample files do not include **nfso** and **vmtune** commands, the commands can be added.

A small number of tuning recommendations that are not dynamically tunable values need to be changed in the **rc.net** file. These tunable parameters are for ARP cache-tuning and setting the number of adapter types per interface. The following are the only tunable parameters that should be added to **rc.net**:

- **arptab_nb**
- **arptab_bsize**
- **arpqsize**
- **ifsize**

Using the sample **tuning.cust** settings selected as part of the installation is a sufficient starting point for the SP nodes in the environment type selected.

If the system has nodes that require different tuning settings, it is recommended that a copy of each setting be saved on the CWS. When nodes with specific tuning settings are installed, that version of **tuning.cust** must be moved into **/tftpboot** on the CWS.

Another option is to create one **tuning.cust** file that determines the node number, and based on that node number, sets the appropriate tuning values.

Initial Settings of SP Tunable Parameters

When a node is installed, migrated or customized, and that node's boot/install server does not have a **/tftpboot/tuning.cust** file, a default file with performance tuning variable settings in **/usr/lpp/ssp/install/tuning.default** is copied to **/tftpboot/tuning.cust** on that node. You can choose from one of the four sample tuning files, or you can create and customize your own. The existing files are located in the **/usr/lpp/ssp/install/config** directory and are as follows:

tuning.commercial

Contains initial performance tuning parameters for a typical commercial environment.

tuning.development

Contains initial performance tuning parameters for a typical interactive or development environment. These are the default tuning parameters.

tuning.scientific

Contains initial performance tuning parameters for a typical engineering/scientific environment.

tuning.server

Contains initial performance tuning parameters for a typical server environment.

The other option is to create and select your own alternate tuning file. While this may not be the initial choice, it certainly must be the choice at some point in time. On the CWS, create a **tuning.cust** file, or you can begin with one of the sample files. Edit the **tuning.cust** file and proceed to the installation of nodes. This **tuning.cust** file is then propagated to each node's **/tftpboot/tuning.cust** file from the boot/install server when the node is installed, migrated, or customized. The tuning file is maintained across reboots.

Tuning the SP Network for Specific Workloads

The following table provides a combined overview of tunable parameters for different environments. The settings given are only initial settings and are not guaranteed to be optimized for your environment. Examine your specific implementation and adjust your tuning settings accordingly.

| Parameter | Commercial Environment | Server Environment | Scientific Environment | Development Environment |
|--|-------------------------------|---------------------------|---|--------------------------------|
| thewall | 16384 | 65536 | 16384 | 16384 |
| sb_max | 1310720 | 1310720 | 1310720 | 1310720 |
| subnetsarelocal | 1 | 1 | 1 | 1 |
| ipforwarding | 1 | 1 | 1 | 1 |
| tcp_sendspace | 262144 | 65536 | 655360 | 65536 |
| tcp_recvspace | 262144 | 65536 | 655360 | 65536 |
| udp_sendspace | 65536 | 65536 | 65536 | 32768 |
| udp_recvspace | 655360 | 655360 | 655360 | 65536 |
| rfc1323 | 1 | 1 | 1 | 1 |
| tcp_mssdflt | 1448 | 1448 | Varies depending on other network types | 1448 |
| tcp_mtu_discover (AIX 4.2.1 and later) | 1 | 1 | 1 | 1 |
| udp_mtu_discover (AIX 4.2.1 and later) | 1 | 1 | 1 | 1 |

Chapter 15. NFS performance

This topic discusses Network File System (NFS) monitoring and tuning on both the server and the client. It contains the following sections:

- NFS overview
- NFS performance monitoring and tuning
- NFS performance monitoring on the server
- NFS performance tuning on the server
- NFS performance monitoring on the client
- NFS tuning on the client
- Cache file system
- NFS references

NFS overview

NFS allows programs on one system to access files on another system transparently by mounting the remote directory. Usually, when the server is booted, directories are made available by the **exports** command, and the daemons to handle remote access (**nfsd** daemons) are started. Similarly, the mounts of the remote directories and the initiation of the appropriate numbers of NFS block I/O daemons (**biod** daemon) to handle remote access are performed during client system boot.

The **nfsd** and **biod** daemons are both multithreaded, which means there are multiple kernel threads within a process. Also, the daemons are self-tuning in that they create or delete threads as needed, based on the amount of NFS activity.

The following figure illustrates the structure of the dialog between NFS clients and a server. When a thread in a client system attempts to read or write a file in an NFS-mounted directory, the request is redirected from the usual I/O mechanism to one of the client's **biod** threads. The **biod** thread sends the request to the appropriate server, where it is assigned to one of the server's NFS threads (**nfsd** thread). While that request is being processed, neither the **biod** nor the **nfsd** thread involved do any other work.

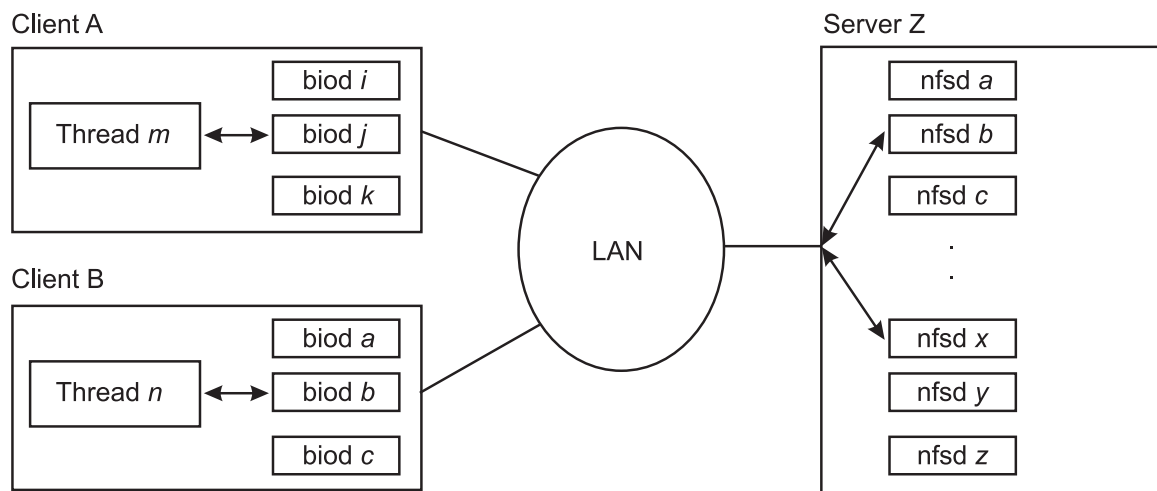

Figure 24. NFS Client-Server Interaction. This illustration shows two clients and one server on a network that is laid out in a typical star topology. Client A is running application thread *m* in which data is directed to one of its **biod** threads. Similarly, client B is running application thread *n* and directing data to one of its **biod** threads. The respective threads send the data across the network to server Z where it is assigned to one of the server's NFS (**nfsd**) threads.

NFS uses Remote Procedure Calls (RPC) to communicate. RPCs are built on top of the External Data Representation (XDR) protocol which transforms data to a generic format before transmitting and allowing machines with different architectures to exchange information. The RPC library is a library of procedures that allows a local (client) process to direct a remote (server) process to execute a procedure call as if the local (client) process had executed the procedure call in its own address space. Because the client and server are two separate processes, they no longer have to exist on the same physical system.

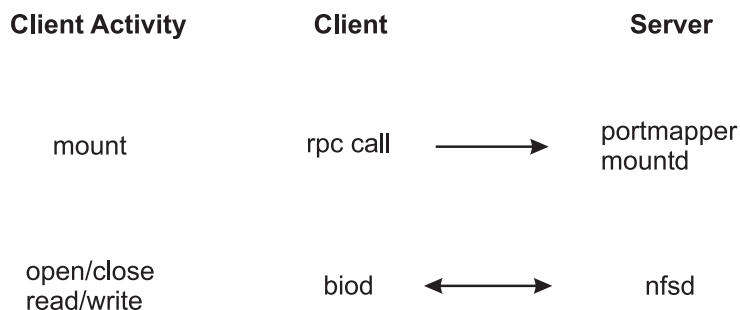

Figure 25. The Mount and NFS Process. This illustration is a three column table with Client Activity, Client, and Server as the three column headings. The first client activity is mount. An rpc call goes from the client to the server's portmapper mountd. The second client activity is open/close read/write. There is two-way interaction between the client's biod thread and the server's nfsd thread.

The **portmap** daemon, **portmapper**, is a network service daemon that provides clients with a standard way of looking up a port number associated with a specific program. When services on a server are requested, they register with **portmap** daemon as an available server. The **portmap** daemon then maintains a table of program-to-port pairs.

When the client initiates a request to the server, it first contacts the **portmap** daemon to see where the service resides. The **portmap** daemon listens on a well-known port so the client does not have to look for it. The **portmap** daemon responds to the client with the port of the service that the client is requesting. The client, upon receipt of the port number, is able to make all of its future requests directly to the application.

The **mountd** daemon is a server daemon that answers a client request to mount a server's exported file system or directory. The **mountd** daemon determines which file system is available by reading the **/etc/xtab** file. The mount process takes place as follows:

1. Client mount makes call to server's **portmap** daemon to find the port number assigned to the **mountd** daemon.
2. The **portmap** daemon passes the port number to the client.
3. The client **mount** command then contacts the server **mountd** daemon directly and passes the name of the desired directory.
4. The server **mountd** daemon checks **/etc/xtab** (built by the **exportfs -a** command, which reads **/etc/exports**) to verify availability and permissions on the requested directory.
5. If all is verified, the server **mountd** daemon gets a file handle (pointer to file system directory) for the exported directory and passes it back to the client's kernel.

The client only contacts the **portmap** daemon on its very first mount request after a system restart. Once the client knows the port number of the **mountd** daemon, the client goes directly to that port number for any subsequent mount request.

The **biod** daemon is the block input/output daemon and is required in order to perform read-ahead and write-behind requests, as well as directory reads. The **biod** daemon threads improve NFS performance by filling or emptying the buffer cache on behalf of the NFS client applications. When a user on a client system wants to read from or write to a file on a server, the **biod** threads send the requests to the server.

The following NFS operations are sent directly to the server from the operating system's NFS client kernel extension and do not require the use of the **biод** daemon:

- **getattr()**
- **setattr()**
- **lookup()**
- **readlink()**
- **create()**
- **remove()**
- **rename()**
- **link()**
- **symlink()**
- **mkdir()**
- **rmdir()**
- **readdir()**
- **readdirplus()**
- **fsstat()**

The **nfсd** daemon is the active agent providing NFS services from the NFS server. The receipt of any one NFS protocol request from a client requires the dedicated attention of an **nfсd** daemon thread until that request is satisfied and the results of the request processing are sent back to the client.

NFS network transport

TCP is the default transport protocol for NFS, but you can use UDP as well. You can choose the transport protocol on a per-mount basis. UDP works efficiently over clean or efficient networks and responsive servers. For wide area networks or for busy networks or for networks with slower servers, TCP might provide better performance because its inherent flow control can minimize retransmit latency on the network.

The various versions of NFS

AIX supports both NFS Version 2 and Version 3 on the same machine, and beginning with AIX 5.3, the operating system also supports NFS version 4. NFS Version 3 continues to be the default, if the version is not specified as a mount option on an AIX client. As with the network transport, you can choose the NFS protocol version on a per-mount basis.

NFS Version 4

NFS Version 4 is the latest protocol specification for NFS and is defined in RFC 3530. While it is similar to prior versions of NFS, primarily Version 3, the new protocol provides many new functional enhancements in areas such as security, scalability, and back-end data management. These characteristics make NFS Version 4 a better choice for large-scale distributed file sharing environments.

Some of the NFS Version 4 protocol features include the following:

- “Implementation change of NFS operations” on page 286
- “TCP requirement” on page 286
- “Integrated locking protocol” on page 286
- “Integrated mount support” on page 286
- “Improved security mechanisms” on page 286
- “Internationalization support” on page 286
- “Extensible attribute model” on page 286
- “Access Control List (ACL) support” on page 286

Implementation change of NFS operations: Unlike NFS versions 2 and 3, version 4 consists of only two RPC procedures: NULL and COMPOUND. The COMPOUND procedure consists of one or more NFS operations that were typically defined as separate RPC procedures in the previous NFS versions. This change might result in requiring fewer RPCs to perform logical file system operations over the network.

TCP requirement: The NFS version 4 protocol mandates the use of a transport protocol that includes congestion control for better performance in WAN environments. AIX does not support the use of UDP with NFS version 4.

Integrated locking protocol: NFS version 4 includes support for advisory byte range file locking. The Network Lock Manager (NLM) protocol and the associated **rpc.lockd** and **rpc.statd** daemons are not used. For better interoperability with non-UNIX operating systems, NFS version 4 also supports open share reservations and includes features to accommodate server platforms with mandatory locking.

Integrated mount support: NFS version 4 supports file system mounting via protocol operations. Clients do not use the separate mount protocol or communicate with the **rpc.mountd** daemon.

Improved security mechanisms: NFS version 4 includes support for the RPCSEC-GSS security protocol. The RPCSEC-GSS security protocol allows the implementation of multiple security mechanisms without requiring the addition of new RPC authentication definitions for each. NFS on AIX only supports the Kerberos 5 security mechanism.

Internationalization support: In NFS version 4, string-based data is encoded in UTF-8 rather than being transmitted as raw bytes.

Extensible attribute model: The attribute model in NFS version 4 allows for better interoperability with non-UNIX implementations, and makes it easier for users to add attribute definitions.

Access Control List (ACL) support: NFS version 4 includes a definition for an ACL attribute. The ACL model is similar to the Windows NT[®] model in that it offers a set of permissions and entry types to grant or deny access on a user or group basis.

Note that the additional functionality and complexity of the new protocol result in more processing overhead. Therefore, NFS version 4 performance might be slower than with NFS version 3 for many applications. The performance impact varies significantly depending on which new functions you use. For example, if you use the same security mechanisms on NFS version 4 and version 3, your system might perform slightly slower with NFS version 4. However, you might notice a significant degradation in performance when comparing the performance of version 3 using traditional UNIX authentication (AUTH_SYS) to that of version 4 using Kerberos 5 with privacy, which means full user data encryption.

Also note that any tuning recommendations made for NFS Version 3 typically apply to NFS version 4 as well.

NFS Version 3

NFS Version 3 is highly recommended over NFS Version 2 due to inherent protocol features that can enhance performance in the following ways:

- “Write throughput”
- “Reduced requests for file attributes” on page 287
- “Efficient use of high bandwidth network technology” on page 287
- “Reduced directory lookup requests” on page 287

Write throughput: Applications running on client systems may periodically write data to a file, changing the file’s contents. The amount of data an application can write to stable storage on the server over a period of time is a measurement of the *write throughput* of a distributed file system. Write throughput is

therefore an important aspect of performance. All distributed file systems, including NFS, must ensure that data is safely written to the destination file while at the same time minimizing the impact of server latency on write throughput.

The NFS Version 3 protocol offers a better alternative to increasing write throughput by eliminating the synchronous write requirement of NFS Version 2 while retaining the benefits of close-to-open semantics. The NFS Version 3 client significantly reduces the latency of write operations to the server by writing the data to the server's cache file data (main memory), but not necessarily to disk. Subsequently, the NFS client issues a commit operation request to the server that ensures that the server has written all the data to stable storage. This feature, referred to as *safe asynchronous writes*, can vastly reduce the number of disk I/O requests on the server, thus significantly improving write throughput.

The writes are considered "safe" because status information on the data is maintained, indicating whether it has been stored successfully. Therefore, if the server crashes before a commit operation, the client will know by looking at the status indication whether to resubmit a write request when the server comes back up.

Reduced requests for file attributes: Because read data can sometimes reside in the cache for extended periods of time in anticipation of demand, clients must check to ensure their cached data remains valid if a change is made to the file by another application. Therefore, the NFS client periodically acquires the file's attributes, which includes the time the file was last modified. Using the modification time, a client can determine whether its cached data is still valid.

Keeping attribute requests to a minimum makes the client more efficient and minimizes server load, thus increasing scalability and performance. Therefore, NFS Version 3 was designed to return attributes for all operations. This increases the likelihood that the attributes in the cache are up to date and thus reduces the number of separate attribute requests.

Efficient use of high bandwidth network technology: NFS Version 2 has an 8 KB maximum RPC size limitation, which restricts the amount of NFS data that can be transferred over the network at one time. In NFS Version 3, this limitation has been relaxed. The default read/write size is 32KB for NFS on AIX and the maximum is 64KB, enabling NFS to construct and transfer larger chunks of data in one RPC packet. This feature allows NFS to more efficiently use high bandwidth network technologies such as FDDI, 100baseT (100 Mbps) and 1000baseT (Gigabit) Ethernet, and the SP Switch, and contributes substantially to NFS performance gains in sequential read and write performance.

Reduced directory lookup requests: A full directory listing, with the **ls -l** command for example, requires that name and attribute information be acquired from the server for all entries in the directory listing. NFS Version 2 clients query the server separately for the list of file and directory names and attribute information for all directory entries through lookup requests. With NFS Version 3, the names list and attribute information are returned at one time via the **READDIRPLUS** operation, relieving both client and server from performing multiple tasks.

In AIX 5.2, support was added for caching of longer filenames (greater than 31 characters) in the NFS client directory name lookup cache, or **dnlc**. Implementation of this feature is a benefit for NFS client work loads using very long filenames, which previously caused excessive **LOOKUP** operations to the server due to **dnlc** misses. An example of this type of work load is the **ls -l** command that was previously mentioned.

NFS performance monitoring and tuning

This section contains information on commands you can use to monitor NFS statistics and tune NFS attributes. In addition, there are some general tips for tuning the TCP/IP and disk subsystems.

Achieving good NFS performance requires tuning and removal of bottlenecks not only within NFS itself, but also within the operating system and the underlying hardware. Workloads characterized by heavy

read/write activity are particularly sensitive to and require tuning and configuration of the entire system. This section also contains information about workloads that might not be well-suited for NFS use.

As a general rule, before you start adjusting the values of any tuning variables, make certain that you understand what you are trying to achieve by modifying these values and what the potential, negative side effects of these changes might be.

NFS statistics and tuning parameters

NFS gathers statistics on types of NFS operations performed, along with error information and performance indicators. You can use the following commands to identify potential bottlenecks, observe the type of NFS operations taking place on your system, and tun NFS-specific parameters.

The `nfsstat` command

The `nfsstat` command displays statistical information about the NFS and the RPC interface to the kernel for clients and servers. This command could also be used to re-initialize the counters for these statistics (`nfsstat -z`). For performance issues, the RPC statistics (`-r` option) are the first place to look. The NFS statistics show you how the applications use NFS.

RPC statistics: The `nfsstat` command displays statistical information about RPC calls, such as:

- Total number of RPC calls received or rejected
- Total number of RPC calls sent or rejected by a server
- Number of times no RPC packet was available when trying to receive
- Number of packets that were too short or had malformed headers
- Number of times a call had to be transmitted again
- Number of times a reply did not match the call
- Number of times a call timed out
- Number of times a call had to wait on a busy client handle
- Number of times authentication information had to be refreshed

The NFS part of the `nfsstat` command output is divided into Version 2 and Version 3 statistics of NFS. The RPC part is divided into Connection oriented (TCP) and Connectionless (UDP) statistics.

Refer to “NFS performance tuning on the server” on page 295 and “NFS tuning on the client” on page 299 for output specific to the respective topics.

The `nfs` command

You can use the `nfs` command to configure NFS attributes. It sets or displays NFS-related options associated with the currently running kernel and NFS kernel extension. See *The nfs Command in AIX 5L Version 5.3 Commands Reference, Volume 4* for a detailed description of the command and its output.

Note: The `nfs` command performs no range-checking. If it is used incorrectly, the `nfs` command can make your system inoperable.

The `nfs` parameters and their values can be displayed by using the `nfs -a` command, as follows:

```
# nfs -a
      portcheck = 0
      udpchecksum = 1
      nfs_socketsize = 60000
      nfs_tcp_socketsize = 60000
      nfs_setattr_error = 0
      nfs_gather_threshold = 4096
      nfs_repeat_messages = 0
nfs_udp_duplicate_cache_size = 5000
nfs_tcp_duplicate_cache_size = 5000
      nfs_server_base_priority = 0
```

```

nfs_dynamic_retrans = 1
nfs_iopace_pages = 0
nfs_max_connections = 0
nfs_max_threads = 3891
nfs_use_reserved_ports = 0
nfs_device_specific_bufs = 1
nfs_server_clread = 1
nfs_rfc1323 = 1
nfs_max_write_size = 65536
nfs_max_read_size = 65536
nfs_allow_all_signals = 0
nfs_v2_pdts = 1
nfs_v3_pdts = 1
nfs_v2_vm_bufs = 1000
nfs_v3_vm_bufs = 1000
nfs_securenfs_authtimeout = 0
nfs_v3_server_readdirplus = 1
lockd_debug_level = 0
statd_debug_level = 0
statd_max_threads = 50
utf8_validation = 1
nfs_v4_pdts = 1
nfs_v4_vm_bufs = 1000

```

Most NFS attributes are run-time attributes that can be changed at any time. Load time attributes, such as **nfs_socketsize**, need NFS to be stopped first and restarted afterwards. The **nfsso -L** command provides more detailed information about each of these attributes, including the current value, default value, and the restrictions regarding when the value changes actually take effect:

```
# nfsso -L
```

| NAME | CUR | DEF | BOOT | MIN | MAX | UNIT | TYPE | DEPENDENCIES |
|------------------------------|--------|--------|--------|-------|--------|---------|------|--------------|
| portcheck | 0 | 0 | 0 | 0 | 1 | On/Off | D | |
| udpchecksum | 1 | 1 | 1 | 0 | 1 | On/Off | D | |
| nfs_socketsize | 600000 | 600000 | 600000 | 40000 | 1M | Bytes | D | |
| nfs_tcp_socketsize | 600000 | 600000 | 600000 | 40000 | 1M | Bytes | D | |
| nfs_setattr_error | 0 | 0 | 0 | 0 | 1 | On/Off | D | |
| nfs_gather_threshold | 4K | 4K | 4K | 512 | 8193 | Bytes | D | |
| nfs_repeat_messages | 0 | 0 | 0 | 0 | 1 | On/Off | D | |
| nfs_udp_duplicate_cache_size | 5000 | 5000 | 5000 | 5000 | 100000 | Req | I | |
| nfs_tcp_duplicate_cache_size | 5000 | 5000 | 5000 | 5000 | 100000 | Req | I | |
| nfs_server_base_priority | 0 | 0 | 0 | 31 | 125 | Pri | D | |
| nfs_dynamic_retrans | 1 | 1 | 1 | 0 | 1 | On/Off | D | |
| nfs_iopace_pages | 0 | 0 | 0 | 0 | 65535 | Pages | D | |
| nfs_max_connections | 0 | 0 | 0 | 0 | 10000 | Number | D | |
| nfs_max_threads | 3891 | 3891 | 3891 | 5 | 3891 | Threads | D | |
| nfs_use_reserved_ports | 0 | 0 | 0 | 0 | 1 | On/Off | D | |
| nfs_device_specific_bufs | 1 | 1 | 1 | 0 | 1 | On/Off | D | |

| | | | | | | | |
|---------------------------|------|------|------|-----|------|---------|---|
| nfs_server_clread | 1 | 1 | 1 | 0 | 1 | On/Off | D |
| nfs_rfc1323 | 1 | 0 | 0 | 0 | 1 | On/Off | D |
| nfs_max_write_size | 64K | 32K | 32K | 512 | 64K | Bytes | D |
| nfs_max_read_size | 64K | 32K | 32K | 512 | 64K | Bytes | D |
| nfs_allow_all_signals | 0 | 0 | 0 | 0 | 1 | On/Off | D |
| nfs_v2_pdts | 1 | 1 | 1 | 1 | 8 | PDTs | M |
| nfs_v3_pdts | 1 | 1 | 1 | 1 | 8 | PDTs | M |
| nfs_v2_vm_bufs | 1000 | 1000 | 1000 | 512 | 5000 | Bufs | I |
| nfs_v3_vm_bufs | 1000 | 1000 | 1000 | 512 | 5000 | Bufs | I |
| nfs_securenfs_authtimeout | 0 | 0 | 0 | 0 | 60 | Seconds | D |
| nfs_v3_server_readdirplus | 1 | 1 | 1 | 0 | 1 | On/Off | D |
| lockd_debug_level | 0 | 0 | 0 | 0 | 10 | Level | D |
| statd_debug_level | 0 | 0 | 0 | 0 | 10 | Level | D |
| statd_max_threads | 50 | 50 | 50 | 1 | 1000 | Threads | D |
| utf8_validation | 1 | 1 | 1 | 0 | 1 | On/Off | D |
| nfs_v4_pdts | 1 | 1 | 1 | 1 | 8 | PDTs | M |
| nfs_v4_vm_bufs | 1000 | 1000 | 1000 | 512 | 5000 | Bufs | I |

n/a means parameter not supported by the current platform or kernel

Parameter types:

- S = Static: cannot be changed
- D = Dynamic: can be freely changed
- B = Bosboot: can only be changed using bosboot and reboot
- R = Reboot: can only be changed during reboot
- C = Connect: changes are only effective for future socket connections
- M = Mount: changes are only effective for future mountings
- I = Incremental: can only be incremented

Value conventions:

- K = Kilo: 2¹⁰
- M = Mega: 2²⁰
- G = Giga: 2³⁰
- T = Tera: 2⁴⁰
- P = Peta: 2⁵⁰
- E = Exa: 2⁶⁰

To display or change a specific parameter, use the **nfso -o** command. For example:

```
# nfso -o portcheck
portcheck= 0
# nfso -o portcheck=1
```

The parameters can be reset to their default value by using the **-d** option. For example:

```
# nfso -d portcheck
# nfso -o portcheck
portcheck= 0
```

TCP/IP tuning guidelines for NFS performance

NFS uses UDP or TCP to perform its network I/O. Ensure that you have applied the tuning techniques described in TCP and UDP performance tuning and Mbuf pool performance tuning. In particular, you should do the following:

- Check for system error log entries by running the **errpt** command and looking for reports of network device or network media problems.
- Ensure that the LAN adapter transmit and receive queues are set to the maximum values. See Adapter transmit and receive queue tuning for more information.
- Check for 0errs with the **netstat -i** command. A significant number of these errors might indicate that the transmit queue size for the related network device is not large enough.
- Ensure that TCP and UDP socket buffer sizes are configured appropriately. The **nfs_tcp_socketsize** tunable of the **nfso** command controls the TCP socket buffer sizes, **tcp_sendspace** and **tcp_recvspace**, used by NFS. Similarly, the **nfs_udp_socketsize** tunable controls the UDP socket buffer sizes, **udp_sendspace** and **udp_recvspace**, used by NFS. Follow the guidelines described in TCP and UDP performance tuning for setting socket buffer size tunables. As with ordinary TCP and UDP tuning, the value of the **sb_max** tunable of the **no** command must be larger than the **nfs_tcp_socketsize** and **nfs_udp_socketsize** values. In general, you should find that the default values used in AIX should be adequate, but it does not hurt to check this. To check for UDP socket buffer overruns, run the **netstat -s -p udp** command and look for a large number of dropped packets being reported in the socket buffer overflows field.
- Ensure that enough network memory is configured in the system. Run the **netstat -m** command and see if there are any requests for denied or delayed mbufs. If so, increase the number of mbufs available to the network. For more information on tuning a system to eliminate mbuf problems, see Mbuf pool performance tuning.
- Check for general routing problems. Use the **traceroute** command to look for unexpected routing hops or delays.
- If possible, increase the MTU size on the LAN. On a 16 Mb Gigabit Ethernet network for example, an increase in MTU size from the default 1500 bytes to 9000 bytes (jumbo frames) allows a complete 8 KB NFS read or write request to be transmitted without fragmentation. It also makes much more efficient use of mbuf space, reducing the probability of overruns.
- Check for MTU size mismatches. Run the **netstat -i** command and check the MTU on the client and server. If they are different, try making them the same and see if the problem is eliminated. Also be aware that slow or wide area network equipment, like routers or bridges, between the machines might further fragment the packets to traverse the network segments. One possible solution is to try to determine the smallest MTU between source and destination, and change the **rsize** and **wsize** settings on the NFS mount to some number lower than the lowest-common-denominator MTU.
- When running NFS Version 3 with TCP, and using the default of 32 KB or larger RPC sizes, you should set the **nfs_rfc1323** option of the **nfso** command. This allows for TCP window sizes greater than 64 KB, and thus helps minimize waiting for TCP acknowledgments. The option must be set on each side of the TCP connection, for example on both the NFS server and client.
- Check for very small inter-packet delays. There have been rare cases where this has caused problems. If there is a router or other hardware between the server and client, you can check the hardware documentation to see if the inter-packet delays can be configured. If so, try increasing the delay.
- Check for large media speed mismatches. When packets are traversing two media with widely different speeds, the router might drop packets when taking them off the high speed network and trying to get them out on the slower network. This may occur, for instance, when a router is trying to take packets from a server on Gigabit Ethernet and send them to a client on 100 Mbps Ethernet. It may not be able to send out the packets fast enough on 100 Mbps Ethernet to keep up with the Gigabit Ethernet. Aside from replacing the router, one other possible solution is to try to slow down the rate of client requests and/or use smaller read/write sizes.
- The maximum number of TCP connections allowed into the server can be controlled by the new **nfs_max_connections** option. The default of 0 indicates that there is no limit. The client will close TCP

connections that have been idle for approximately 5 minutes, and the connection is reestablished when use warrants it. The server will close connections that have been idle for approximately 6 minutes.

- The operating system provides an option to turn off the UDP checksum for NFS only. You can use the **nfs** command option, called **udpchecksum**. The default is 1, which means the checksum is enabled. You can achieve slight performance gains by turning it off, at the expense of increased chance of data corruption.

Dropped packets

While using the above guidelines might help minimize the chance of dropped packets, this section provides more details on detecting and addressing dropped packets. Although dropped packets are typically first detected on an NFS client, the real challenge is to find out where they are being lost. Packets can be dropped at the client, the server, or anywhere on the network.

Packets dropped by the client

Packets are rarely dropped by a client. Since each **biod** thread can only work on a single NFS operation at a time, it must wait for the RPC call reply from that operation before issuing another RPC call. This self-pacing mechanism means that there is little opportunity for overrunning system resources. The most stressful operation is probably reading, where there is potential for a large rate of data flowing into the machine. While the data volume can be high, the actual number of simultaneous RPC calls is fairly small and each **biod** thread has its own space allocated for the reply. Thus, it is very unusual for a client to drop packets.

Packets are more commonly dropped either by the network or by the server.

Packets dropped by the server

The following situations exist where servers drop packets under heavy loads:

1. Network adapter driver

When an NFS server responds to a very large number of requests, the server sometimes overruns the interface driver output queue. You can observe this by looking at the statistics that are reported by the **netstat -i** command. Examine the columns marked **0errs** and look for any counts. Each **0errs** value is a dropped packet. This is easily tuned by increasing the problem device driver's transmit queue size. The idea behind configurable queues is that you do not want to make the transmit queue too long, because of latencies incurred in processing the queue. But because NFS maintains the same port and **XID** for the call, a second call can be satisfied by the response to the first call's reply. Additionally, queue-handling latencies are far less than UDP retransmit latencies incurred by NFS if the packet is dropped.

2. Socket buffers

The UDP socket buffer is another place where a server drops packets. These dropped packets are counted by the UDP layer and you can see the statistics by using the **netstat -p udp** command. Examine the socket buffer overflows statistic.

NFS packets are usually dropped at the socket buffer only when a server has a lot of NFS write traffic. The NFS server uses a UDP socket attached to NFS port 2049 and all incoming data is buffered on that UDP port. The default size of this buffer is 60,000 bytes. You can divide that number by the size of the default NFS Version 3 write packet (32786) to find that it will take 19 simultaneous write packets to overflow that buffer.

You might see cases where the server has been tuned and no dropped packets are arriving for either the socket buffer or the **0errs** driver, but clients are still experiencing timeouts and retransmits. Again, this is a two-case scenario. If the server is heavily loaded, it may be that the server is just overloaded and the backlog of work for **nfsd** daemons on the server is resulting in response times beyond the default timeout that is set on the client. The other possibility, and the most likely problem if the server is known to be otherwise idle, is that packets are being dropped on the network.

Packets dropped on the network

If there are no socket buffer overflows or `0errs` on the server, the client is getting lots of timeouts and retransmits and the server is known to be idle, then packets are most likely being dropped on the network. In this case, *network* refers to a large variety of things including media and network devices such as routers, bridges, concentrators, and the whole range of things that can implement a transport for packets between the client and server.

Anytime a server is not overloaded and is not dropping packets, but NFS performance is bad, assume that packets are being dropped on the network. Much effort can be expended proving this and finding exactly how the network is dropping the packets. The easiest way of determining the problem depends mostly on the physical proximity involved and resources available.

Sometimes the server and client are in close enough proximity to be direct-connected, bypassing the larger network segments that may be causing problems. Obviously, if this is done and the problem is resolved, then the machines themselves can be eliminated as the problem. More often, however, it is not possible to wire up a direct connection, and the problem must be tracked down in place. You can use network sniffers and other tools to debug such problems.

Configuration of the disk subsystem for NFS performance

One of the most common sources of bottlenecks in read/write-intensive workloads is poorly configured disk subsystems. While you might consider tuning only the disk subsystem on the NFS server, note that a poorly configured disk setup on the NFS client might be the actual problem in certain scenarios. An example of this is a workload in which a file is copied by an application on the NFS client from an NFS-mounted filesystem to a local filesystem on the client. In this case, it is important that the disk subsystem on the client is properly tuned such that write performance to the local filesystem does not become the bottleneck. See the tuning techniques described in Chapter 12, “Logical volume and disk I/O performance,” on page 159. In particular, consider the following:

- For a simple read or write workload over NFS, evaluate the performance capabilities of the disks which contain the file systems being used. You can do this by writing to or reading from a file locally on the file system. You should use the **`iostat`** command to measure the throughput capability of the disks since many test applications might complete without actually writing all the data to disk. For example, some data might still be in memory. You can then typically consider this throughput measured on local reads/writes as the upper bound on the performance you will be able to achieve over NFS, since you are not incurring the additional processing and latency overhead associated with NFS.
- It is often necessary to achieve high parallelism on data access. Concurrent access to a single file system on a server by multiple clients or multiple client processes can result in throughput bottlenecks on the disk I/O for a specific device. You can use the **`iostat`** command to evaluate disk loading. In particular, the **`%tm_act`** parameter indicates the percentage of time that a particular disk was active, but a high value can also indicate that the associated disk adapter is overloaded.
- While not directly relevant to tuning of the disk subsystem, it is worth mentioning that concurrent writes to a single file can result in contention on the inode lock of the file. Most file systems use an inode lock to serialize access to the file and thus ensure the consistency of the data being written to it. Unfortunately, this can severely hamper write performance in the case where multiple threads are attempting to write to the same file concurrently since only the thread holding the inode lock is allowed to write to the file at any single point in time.
- For large NFS servers, the general strategy should be to evenly divide the disk I/O demand across as many disk and disk adapter devices as possible. On a system where disk I/O has been well-distributed, it is possible to reach a point where CPU load on the server becomes the limiting factor on the workload performance

Misuses of NFS that affect performance

Many of the misuses of NFS occur because people do not realize that the files that they are accessing are at the other end of an expensive communication path. A few examples of this are as follows:

- An application running on one system doing random updates of an NFS-mounted inventory file, supporting a real-time retail cash register application.
- A development environment in which a source code directory on each system was NFS-mounted on all of the other systems in the environment, with developers logging onto arbitrary systems to do editing and compiles. This practically guaranteed that all of the compiles would be obtaining their source code from, and writing their output to, remote systems.
- Running the **ld** command on one system to transform **.o** files in an NFS-mounted directory into an **a.out** file in the same directory.
- Applications that issue writes that are not page-aligned, for example 10 KB. Writes that are less than 4 KB in size always result in a *pagein* and in the case of NFS, the *pagein* goes over the network.

It can be argued that these are valid uses of the transparency provided by NFS. Perhaps this is so, but these uses do cost processor time and LAN bandwidth and degrade response time. When a system configuration involves NFS access as part of the standard pattern of operation, the configuration designers should be prepared to defend the consequent costs with offsetting technical or business advantages, such as:

- Placing all of the data or source code on a server, rather than on individual workstations, improves source-code control and simplifies centralized backups.
- A number of different systems access the same data, making a dedicated server more efficient than one or more systems combining client and server roles.

Another type of application that should not be run across NFS file systems is an application that does hundreds of **lockf()** or **flock()** calls per second. On an NFS file system, all the **lockf()** or **flock()** calls (and other file locking calls) must go through the **rpc.lockd** daemon. This can severely degrade system performance because the lock daemon may not be able to handle thousands of lock requests per second.

Regardless of the client and server performance capacity, all operations involving NFS file locking will probably seem unreasonably slow. There are several technical reasons for this, but they are all driven by the fact that if a file is being locked, special considerations must be taken to ensure that the file is synchronously handled on both the read and write sides. This means there can be no caching of any file data at the client, including file attributes. All file operations go to a fully synchronous mode with no caching. Suspect that an application is doing network file locking if it is operating over NFS and shows unusually poor performance compared to other applications on the same client/server pair.

NFS performance monitoring on the server

You should check CPU utilization, I/O activity, and memory usage with the **vmstat** and **iostat** commands on the NFS server during workload activity to see if the server's processor, memory, and I/O configuration is adequate. You can use the **nfsstat** command to monitor NFS operation activity on the server.

The **nfsstat -s** command

The NFS server displays the number of NFS calls received, **calls**, and rejected, **badcalls**, due to authentication as well as the counts and percentages for the various kinds of calls made.

The following example shows the server part of the **nfsstat** command output specified by the **-s** option:

```
# nfsstat -s

Server rpc:
Connection oriented:
calls    badcalls  nullrecv  badlen    xdrcall  dupchecks  dupreqs
15835    0          0          0          0          772         0
Connectionless:
calls    badcalls  nullrecv  badlen    xdrcall  dupchecks  dupreqs
0        0          0          0          0          0          0

Server nfs:
```

```

calls      badcalls  public_v2  public_v3
15835      0          0          0
Version 2: (0 calls)
null      getattr   setattr    root       lookup     readlink   read
0 0%      0 0%      0 0%       0 0%       0 0%       0 0%       0 0%
wrcache   write     create     remove     rename     link       symlink
0 0%      0 0%      0 0%       0 0%       0 0%       0 0%       0 0%
mkdir     rmdir    readdir    statfs
0 0%      0 0%      0 0%       0 0%
Version 3: (15835 calls)
null      getattr   setattr    lookup     access     readlink   read
7 0%      3033 19%   55 0%     1008 6%   1542 9%   20 0%   9000 56%
write     create    mkdir      symlink    mknod     remove     rmdir
175 1%    185 1%   0 0%      0 0%      0 0%     120 0%    0 0%
rename    link      readdir    readdir+   fsstat    fsinfo     pathconf
87 0%     0 0%     1 0%      150 0%    348 2%   7 0%     0 0%
commit
97 0%

```

RPC output for the server, **-s**, is as follows:

calls Total number of RPC calls received from clients

badcalls

Total number of calls rejected by the RPC layer

nullrecv

Number of times an RPC call was not available when it was thought to be received

badlen

Packets truncated or damaged (number of RPC calls with a length shorter than a minimum-sized RPC call)

xdrcall

Number of RPC calls whose header could not be External Data Representation (XDR) decoded

dupchecks

Number of RPC calls looked up in the duplicate request cache

dupreqs

Number of duplicate RPC calls found

The output also displays a count of the various kinds of calls and their respective percentages.

Duplicate checks are performed for operations that cannot be performed twice with the same result. The classic example is the **rm** command. The first **rm** command will succeed, but if the reply is lost, the client will retransmit it. We want duplicate requests like these to succeed, so the duplicate cache is consulted, and if it is a duplicate request, the same (successful) result is returned on the duplicate request as was generated on the initial request.

By looking at the percentage of calls for different types of operations, such as **getattr()**, **read()**, **write()**, or **readdir()**, you can decide what type of tuning to use. For example, if the percentage of **getattr()** calls is very high, then tuning attribute caches may be advantageous. If the percentage of **write()** calls is very high, then disk and LVM tuning is important. If the percentage of **read()** calls is very high, then using more RAM for caching files could improve performance.

NFS performance tuning on the server

NFS-specific tuning variables on the server are accessible primarily through the **nfso** command.

In general, when implemented appropriately, tuning NFS-specific options can help with issues like the following:

- Decrease the load on the network and on the NFS server
- Work around network problems and client memory usage

Number of necessary nfsd threads

There is a single **nfsd** daemon on the NFS server which is multithreaded. This means that there are multiple kernel threads within the **nfsd** process. The number of threads is self-tuning in that the daemon creates and destroys threads as needed, based on NFS load. Due to this self-tuning capability, and since the default number (3891) of maximum **nfsd** threads is the maximum allowed anyway, it is rarely necessary to change this value. Nevertheless, you can adjust the maximum number of **nfsd** threads in the system by using the **nfs_max_threads** parameter of the **nfsd** command.

Read and write size limits on the server

You can use the **nfs_max_read_size** and **nfs_max_write_size** options of the **nfsd** command to control the maximum size of RPCs used for NFS read replies and NFS write requests, respectively. The “NFS tuning on the client” on page 299 section contains information on the situations in which it may be appropriate to tune read and write RPC sizes. Typically, it is on the client where the tuning is performed. However, in environments where modifying these values on the clients may be difficult to manage, these server **nfsd** options prove to be useful.

Maximum caching of file data tuning

NFS does not have its own dedicated buffers for caching data from files in NFS-exported file systems. Instead, the Virtual Memory Manager (VMM) controls the caching of these file pages. If a system acts as a dedicated NFS server, it might be appropriate to permit the VMM to use as much memory as necessary for data caching. For a server exporting JFS file systems, this is accomplished by setting the **maxperm** parameter, which controls the maximum percentage of memory occupied by JFS file pages to 100 percent. This parameter is set using the **vmo** command. For example:

```
# vmo -o maxperm%=100
```

On a server exporting Enhanced JFS file systems, both the **maxclient** and **maxperm** parameters must be set. The **maxclient** parameter controls the maximum percentage of memory occupied by client-segment pages which is where Enhanced JFS file data is cached. Note that the **maxclient** value cannot exceed the **maxperm** value. For example:

```
# vmo -o maxclient%=100
```

Under certain conditions, too much file data cached in memory might actually be undesirable. See Chapter 13, “File system performance,” on page 193 for an explanation of how you can use a mechanism called *release-behind* to flush file data that is not likely to be reused by applications.

RPC mount daemon tuning

The **rpc.mountd** daemon is multithreaded and by default, can create up to 16 threads. In environments that make heavy use of the **automount** daemon, and where frequent **automount** daemon timeouts are seen, it might make sense to increase the maximum number of **rpc.mountd** threads as follows:

```
# chsys -s rpc.mountd -a -h <number of threads>
# stopsrc -s rpc.mountd
# startsrc -s rpc.mountd
```

RPC lock daemon tuning

The **rpc.lockd** daemon is multithreaded and by default, can create up to 33 threads. In situations where there is heavy RPC file locking activity, the **rpc.lockd** daemon might become a bottleneck once it reaches

the maximum number of threads. When that maximum value is reached, any subsequent requests have to wait, which might result in other timeouts. You can adjust the number of **rpc.lockd** threads up to a maximum of 511. The following is an example:

```
# chsys -s rpc.lockd -a <number of threads>
# stopsrc -s rpc.lockd
# startsrc -s rpc.lockd
```

NFS performance monitoring on the client

You should check CPU utilization and memory usage with the **vmstat** command on the NFS client during workload activity to see if the client's processor and memory configuration is adequate. You can use the **nfsstat** command to monitor NFS operation activity by the client.

The **nfsstat -c** command

The NFS client displays the number of NFS calls sent and rejected, as well as the number of times a client handle was received, **clgets**, and a count of the various kinds of calls and their respective percentages.

The following example shows the **nfsstat** command output specified for clients using the **-c** option:

```
# nfsstat -c

Client rpc:
Connection oriented
calls      badcalls  badxids  timeouts  newcreds  badverfs  timers
0          0         0        0         0         0         0
nomem     cantconn  interrupts
0          0         0
Connectionless
calls      badcalls  retrans  badxids  timeouts  newcreds  badverfs
6553      0         0        0         0         0         0
timers    nomem     cantsend
0          0         0

Client nfs:
calls      badcalls  clgets   cltoomany
6541      0         0        0
Version 2: (6541 calls)
null      getattr   setattr  root      lookup    readlink  read
0 0%     590 9%   414 6%   0 0%     2308 35% 0 0%   0 0%
wrcache   write     create   remove   rename    link      symlink
0 0%     2482 37%  276 4%   277 4%   147 2%   0 0%   0 0%
mkdir     rmdir    readdir  statfs
6 0%     6 0%    30 0%    5 0%
Version 3: (0 calls)
null      getattr   setattr  lookup    access    readlink  read
0 0%     0 0%    0 0%    0 0%     0 0%     0 0%   0 0%
write     create    mkdir    symlink   mknod     remove    rmdir
0 0%     0 0%    0 0%    0 0%     0 0%     0 0%   0 0%
rename    link      readdir  readdir+  fsstat    fsinfo    pathconf
0 0%     0 0%    0 0%    0 0%     0 0%     0 0%   0 0%
commit
0 0%
```

RPC output for the client, **-c**, is as follows:

calls Total number of RPC calls made to NFS

badcalls

Total number of calls rejected by the RPC layer

retrans

Number of times a call had to be retransmitted due to a timeout while waiting for a reply from the server. This is applicable only to RPC over connectionless transports

badxid

Number of times a reply from a server was received that did not correspond to any outstanding call. This means the server is taking too long to reply

timeouts

Number of times a call timed-out while waiting for a reply from the server

newcreds

Number of times authentication information had to be refreshed.

badverfs

Number of times a call failed due to a bad verifier in the response.

timers Number of times the calculated timeout value was greater than or equal to the minimum specified timeout value for a call.

nomem

Number of times a call failed due to a failure to allocate memory.

cantconn

Number of times a call failed due to a failure to make a connection to the server.

interrupts

Number of times a call was interrupted by a signal before completing.

cantsend

Number of times a send failed due to a failure to make a connection to the client.

The output also displays a count of the various kinds of calls and their respective percentages.

For performance monitoring, the **nfsstat -c** command provides information on whether the network is dropping UDP packets. A network may drop a packet if it cannot handle it. Dropped packets can be the result of the response time of the network hardware or software or an overloaded CPU on the server. Dropped packets are not actually lost, because a replacement request is issued for them.

The **retrans** column in the RPC section displays the number of times requests were retransmitted due to a timeout in waiting for a response. This situation is related to dropped UDP packets. If the **retrans** value consistently exceeds five percent of the total calls in column one, it indicates a problem with the server keeping up with demand. Use the **vmstat** and **iostat** commands on the server machine to check the load.

A high **badxid** count implies that requests are reaching the various NFS servers, but the servers are too loaded to send replies before the client's RPC calls time out and are retransmitted. The **badxid** value is incremented each time a duplicate reply is received for a transmitted request. An RPC request retains its **XID** value through all transmission cycles. Excessive retransmissions place an additional strain on the server, further degrading response time. If the **badxid** value and the number of timeouts are greater than five percent of the total calls, increase the **timeo** parameter of the NFS-mount options by using the **smitty chnfsmnt** command. If the **badxid** value is 0, but the **retrans** value and number of timeouts are sizable, attempt to decrease the NFS buffer size using the **rsize** and **wsize** options of the **mount** command.

If the number of retransmits and timeouts are close to the same value, it is certain that packets are being dropped. See "Dropped packets" on page 292 for further discussion.

In some instances, an application or user experiences poor performance, yet examination of the **nfsstat -c** command output indicates no or very few timeouts and retransmits. This means that the client is receiving responses from the server as fast as it is asking for them. The first thing to check is that there is an appropriate number of **biod** daemons running on the client machine. This can also be observed when an

application is doing remote file locking. When remote file locks are set on a file served over NFS, the client goes into a fully synchronous mode of operation that will turn off all data and attribute caching for the file. The result is very slow performance and is, unfortunately, normal. You can identify locking packets in **ipreport** output by looking for NLM requests.

The **nfsstat -m** command

The **nfsstat -m** command displays the server name and address, mount flags, current read and write sizes, retransmission count, and the timers used for dynamic retransmission for each NFS mount on the client. The following is an example:

```
# nfsstat -m
/SAVE from /SAVE:aixhost.ibm.com
Flags: vers=2,proto=udp,auth=unix,soft,intr,dynamic,rsize=8192,wsize=8192,retrans=5
Lookups: srttp=27 (67ms), dev=17 (85ms), cur=11 (220ms)
Reads: srttp=16 (40ms), dev=7 (35ms), cur=5 (100ms)
Writes: srttp=42 (105ms), dev=14 (70ms), cur=12 (240ms)
All: srttp=27 (67ms), dev=17 (85ms), cur=11 (220ms)
```

The numbers in parentheses in the example output are the actual times in milliseconds. The other values are unscaled values kept by the operating system kernel. You can ignore the unscaled values. Response times are shown for lookups, reads, writes, and a combination of all of these operations, All. Other definitions used in this output are as follows:

srtp Smoothed round-trip time
dev Estimated deviation
cur Current backed-off timeout value

NFS tuning on the client

NFS-specific tuning variables are accessible primarily through the **nfso** and **mount** commands. Before you start adjusting the values of tuning variables, make certain that you understand what you are trying to achieve by modifying these values and what the potential negative side effects of these changes might be.

You can also set the **mount** options by modifying the **/etc/filesystems** stanza for the particular file system so the values take effect when the file system is mounted at boot time.

In general, when implemented appropriately, tuning NFS-specific options can help with issues like the following:

- Decrease the load on the network and on the NFS server
- Work around network problems and client memory usage

Number of necessary **biod** threads

There is a single **biod** daemon on the NFS client which is multithreaded. This means that there are multiple kernel threads within the **biod** process. The number of threads is self-tuning in that the daemon creates and destroys threads as needed, based on NFS load. You can tune the maximum number of **biod** threads per mount with the **biod** mount option. The default number of **biod** threads is 4 for NFS Version 3 and NFS Version 4 mounts and 7 for NFS Version 2 mounts.

Because **biod** threads handle one read or write request at a time and because NFS response time is often the largest component of overall response time, it is undesirable to block applications for lack of a **biod** thread.

Determining the best number of the **nfsd** and **biod** daemons is an iterative process. The guidelines listed below are solely a reasonable starting point. The general considerations for configuring **biod** threads are as follows:

- Increasing the number of threads cannot compensate for inadequate client or server processor power or memory, or inadequate server disk bandwidth. Before changing the number of threads, you should check server and client resource-utilization levels with the **iostat** and **vmstat** commands
- If the CPU or disk subsystem is already at near-saturation level, an increase in the number of threads will not yield better performance
- Only reads and writes go through a **biod** thread
- The defaults are generally a good starting point, but increasing the number of **biod** threads for a mount point might be desirable if multiple application threads are accessing files on that mount point simultaneously. For example, you might want to estimate the number of files that will be written simultaneously. Ensure that you have at least two **biod** threads per file to support read ahead or write behind activity.
- If you have fast client workstations connected to a slower server, you might have to constrain the rate at which the clients generate NFS requests. A potential solution is to reduce the number of **biod** threads on the clients, paying attention to the relative importance of each client's workload and response time requirements. Increasing the number of **biod** threads on the client negatively impacts server performance because it allows the client to send more requests at once, further loading the network and the server. In cases where a client overruns the server, it might be necessary to reduce the number of **biod** threads to one. For example:

```
# stopsrc -s biod
```

The above example leaves the client with just the **biod** kernel process still running.

Read and write size adjustments

Some of the most useful NFS tuning options are the **rsize** and **wsiz**e options, which define the maximum sizes of each RPC packet for read and write, respectively. The following reasons outline why you might want to change the read and write size values:

- The server might not be capable of handling the data volume and speeds inherent in transferring the read/write packets, which are 8 KB for NFS Version 2 and 32 KB for NFS Version 3 and NFS Version 4. This might be the case if a NFS client is using a PC as an NFS server. The PC may have limited memory available for buffering large packets.
- If a read/write size value is decreased, there may be a subsequent reduction in the number of IP fragments generated by the call. If you are dealing with a faulty network, the chances of a call and reply pair completing with a two-packet exchange are greater than if there must be seven packets successfully exchanged. Likewise, if you are sending NFS packets across multiple networks with different performance characteristics, the packet fragments may not all arrive before the timeout value for IP fragments.

Reducing the **rsize** and **wsiz**e values might improve the NFS performance in a congested network by sending shorter packets for each NFS-read reply and write request. But, a side effect of this is that more packets are needed to send data across the network, increasing total network traffic, as well as CPU utilization on both the server and client.

If your NFS file system is mounted across a high-speed network, such as Gigabit Ethernet, larger read and write packet sizes might enhance NFS file system performance. With NFS Version 3 and NFS Version 4, you can set the **rsize** and **wsiz**e values as high as 65536 when the network transport is TCP. The default value is 32768. With NFS Version 2, the maximum values for the **rsize** and **wsiz**e options is 8192, which is also the default.

Tuning the caching of NFS file data

The VMM controls the caching of NFS file data on the NFS client in client-segment pages. If an NFS client is running workloads that have little need for working-segment pages, it might be appropriate to allow VMM to use as much system memory as available for NFS file data caching. You can accomplish this by

setting both the **maxperm** and **maxclient** parameters. The value of **maxclient** must be less than or equal to that of the **maxperm** value. The following example sets the amount of memory available for file caching to 100%:

```
# vmo -o maxperm%=100
# vmo -o maxclient%=100
```

Effects of NFS data caching on read throughput

NFS sequential read throughput, as measured at the client, is enhanced via the VMM read ahead and caching mechanisms. Read ahead allows file data to be transferred to the client from the NFS server in anticipation of that data being requested by an NFS client application. By the time the request for data is issued by the application, it is possible that the data resides already in the client's memory, and thus the request can be satisfied immediately. VMM caching allows rereads of file data to occur instantaneously, assuming that the data was not paged out of client memory which would necessitate retrieving the data again from the NFS server.

While many applications might benefit from VMM caching of NFS data on the client, there are some applications, like databases, that might perform their own file data cache management. Applications that perform their own file data cache management might benefit from using direct I/O, or DIO, over NFS. You can enable DIO over NFS with the **dio** option of the **mount** command or by specifying the **O_DIRECT** flag with the **open()** system call.

The following list details the benefits of DIO:

- You avoid double-caching of file data by the VMM and the application.
- You can gain CPU efficiency on file reads and writes since the DIO function bypasses the VMM code.

Applications that perform their own file data cache management and file access serialization, like databases, might benefit from using concurrent I/O, or CIO. In addition to the benefits of DIO, CIO does not serialize read and write file accesses, which allows multiple threads to read or write to the same file concurrently.

Note: Using CIO or DIO might degrade performance for applications that rely heavily on VMM file caching and the read-ahead and write-behind VMM optimizations for increased system performance.

You can use CacheFS to further enhance read throughput in environments with memory-limited clients, very large files, and/or slow network segments by adding the potential to satisfy read requests from file data residing in a local disk cache on the client. See “Cache file system” on page 304 for more information.

Data caching for sequential reads of large files might result in heavy page replacement activity as memory is filled with the NFS data cache. Starting with AIX 5.3 with 5300-03, you can improve performance by avoiding the page replacement activity by using the release-behind on read, **rbr**, **mount** option or the **nfs4cl setfsoptions** argument for NFS version 4. For sequential reads of large files, the real memory for the previous reads is then freed as the sequential reads continue.

If the **rbr mount** option starts to release memory that you are going to need again soon, you can use the **nfs_auto_rbr_trigger** tunable of the **nfs** command instead. The **nfs_auto_rbr_trigger** tunable, which is measured in megabytes, serves as a read-offset threshold for when the release-behind on read option takes effect. For example, if the **nfs_auto_rbr_trigger** tunable is set to 100 MB, the first 100 MB of a sequentially-read file is cached and the rest of the file is released from memory.

Effects of NFS data caching on write throughput

If you are trying to perform sequential write operations on files using NFS Version 3 or NFS Version 4 that are larger than client memory, you can improve performance by using commit-behind. Writing entire files that are larger than the amount of memory in the client causes heavy page replacement activity on the client. This might result in a commit operation being performed over-the-wire for every page of data

written. Commit-behind enables a more aggressive logic for committing client pages to stable storage on the server and, more importantly, returning those pages to the free list.

You can enable commit-behind when mounting the file system by specifying the **combehind** option with the **mount** command. You also need to set an appropriate value for the **numclust** variable, with the **mount** command. This variable specifies the number of 16 KB clusters processed by the sequential write-behind algorithm of the Virtual Memory Manager (VMM). When the I/O pattern is sequential, use a large value for the **numclust** option in order to keep more pages in RAM before scheduling them for I/O. Increase the value for the **numclust** option if striped logical volumes or disk arrays are being used.

NFS file-attribute cache tuning

NFS maintains a cache on each client system of the attributes of recently accessed directories and files. You can set several parameters with the **mount** command to control how long a given entry is kept in the cache. They are as follows:

actimeo

Absolute time for which file and directory entries are kept in the file-attribute cache after an update. If specified, this value overrides the following ***min** and ***max** values, effectively setting them all to the **actimeo** value.

acregmin

Minimum time after an update that file entries will be retained. The default is 3 seconds.

acregmax

Maximum time after an update that file entries will be retained. The default is 60 seconds.

acdirmin

Minimum time after an update that directory entries will be retained. The default is 30 seconds.

acdirmax

Maximum time after an update that directory entries will be retained. The default is 60 seconds.

Each time the file or directory is updated, its removal is postponed for at least **acregmin** or **acdirmin** seconds. If this is the second or subsequent update, the entry is kept at least as long as the interval between the last two updates, but not more than **acregmax** or **acdirmax** seconds.

Performance implications of hard or soft NFS mounts

One of the choices you have when configuring NFS-mounted directories is whether you want hard (**-o hard**) or soft (**-o soft**) mounts. When, after a successful mount, an access to a soft-mounted directory encounters an error (typically, a timeout), the error is immediately reported to the program that requested the remote access. When an access to a hard-mounted directory encounters an error, NFS retries the operation.

A persistent error accessing a hard-mounted directory can escalate into a perceived performance problem because the default number of retries, which is 1000, and the default timeout value of 0.7 seconds, combined with an algorithm that increases the timeout value for successive retries, means that NFS continues to try to complete the operation.

It is technically possible to reduce the number of retries, or increase the timeout value, or both, using options of the **mount** command. Unfortunately, changing these values sufficiently to remove the perceived performance problem might lead to unnecessary reported hard errors. Instead, use the **intr** option to mount the hard-mounted directories, which allows the user to interrupt from the keyboard a process that is in a retry loop.

Although soft-mounting the directories causes the error to be detected sooner, it runs a serious risk of data corruption. In general, read/write directories should be hard-mounted.

Unnecessary retransmits

Related to the hard-versus-soft mount question is the question of the appropriate timeout duration for a given network configuration. If the server is heavily loaded, is separated from the client by one or more bridges or gateways, or is connected to the client by a WAN, the default timeout criterion may be unrealistic. If so, both server and client are burdened with unnecessary retransmits. For example, if the following command:

```
# nfsstat -c
```

reports a significant number, like greater than five percent of the total, of both timeouts and badxids, you could increase the **timeo** parameter with the **mount** command.

Identify the directory you want to change, and enter a new value, in tenths of a second, on the **NFS TIMEOUT** line.

The default time is 0.7 second, **timeo=7**, but this value is manipulated in the NFS kernel extension depending on the type of call. For read calls, for instance, the value is doubled to 1.4 seconds.

To achieve control over the **timeo** value for operating system version 4 clients, you must set the **nfs_dynamic_retrans** option of the **nfsd** command to 0. There are two directions in which you can change the **timeo** value, and in any given case, there is only one right way to change it. The correct way, making the timeouts longer or shorter, depends on why the packets are not arriving in the allotted time.

If the packet is only late and does finally arrive, then you may want to make the **timeo** variable longer to give the reply a chance to return before the request is retransmitted.

However, if the packet has been dropped and will never arrive at the client, then any time spent waiting for the reply is wasted time, and you want to make the **timeo** shorter.

One way to estimate which option to take is to look at a client's **nfsstat -cr** output and see if the client is reporting lots of badxid counts. A badxid value means that an RPC client received an RPC call reply that was for a different call than the one it was expecting. Generally, this means that the client received a duplicate reply for a previously retransmitted call. Packets are thus arriving late and the **timeo** should be lengthened.

Also, if you have a network analyzer available, you can apply it to determine which of the two situations is occurring. Lacking that, you can try setting the **timeo** option higher and lower and see what gives better overall performance. In some cases, there is no consistent behavior. Your best option then is to track down the actual cause of the packet delays/drops and fix the real problem; that is, server or network/network device.

For LAN-to-LAN traffic through a bridge, try a value of 50, which is in tenths of seconds. For WAN connections, try a value of 200. Check the NFS statistics again after waiting at least one day. If the statistics still indicate excessive retransmits, increase the **timeo** value by 50 percent and try again. You also want to examine the server workload and the loads on the intervening bridges and gateways to see if any element is being saturated by other traffic.

Unused NFS ACL support

If your workload does not use the NFS access control list, or ACL, support on a mounted file system, you can reduce the workload on both client and server to some extent by specifying the **noacl** option. This can be done as follows:

```
options=noacl
```

Set this option as part of the client's **/etc/filesystems** stanza for that file system.

Use of REaddirPLUS operations

In NFS Version 3, file handle and attribute information is returned along with directory entries via the REaddirPLUS operation. This relieves the client from having to query the server for that information separately for each entry, as is done with NFS Version 2, and is thus much more efficient.

However, in some environments with large directories where only the information of a small subset of directory entries is used by the client, the NFS Version 3 REaddirPLUS operation might cause slower performance. In such cases, the `nfs_v3_server_readdirplus` option of the `nsfo` command can be used to disable the use of REaddirPLUS. But, this is not generally recommended because it does not comply with the NFS Version 3 standard.

Cache file system

You can use the Cache file system, or CacheFS, to enhance performance of remote file systems, like NFS, or slow devices such as CD-ROM. When a remote file system is cached, the data read from the remote file system or CD-ROM is stored in a cache on the local system, thereby avoiding the use of the network and NFS server when the same data is accessed for the second time. CacheFS is designed as a layered file system which means that it provides the ability to cache one file system (the NFS file system, also called the back file system) on another (your local file system, also called the front file system), as shown in the following figure:

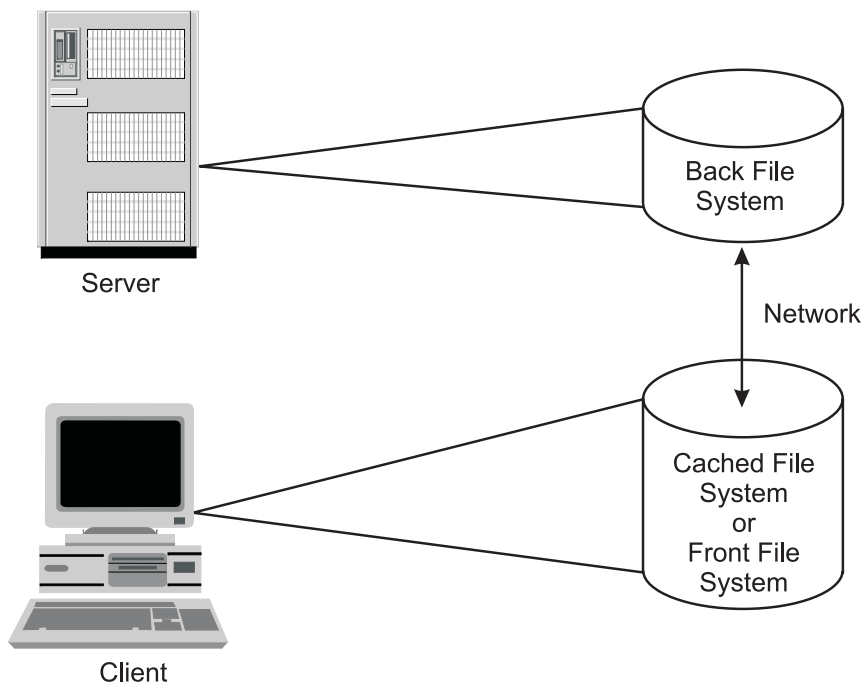

Figure 26. Cache File System (CacheFS). This illustration shows a client machine and a server that are connected by a network. The storage media on the server contains the back file system. The storage media on the client contains the cached file system or the front file system.

CacheFS functions as follows:

1. After creating a CacheFS file system on a client system, you can specify which file systems are to be mounted in the cache.
2. When a user on the client attempts to access files that are part of the back file system, those files are placed in the cache. The cache does not get filled until a user requests access to a file or files. Therefore, the initial request to access a file will be at typical NFS speeds, but subsequent accesses to the same file will be at local JFS speeds.

3. To ensure that the cached directories and files are kept up to date, CacheFS periodically checks the consistency of files stored in the cache. It does this by comparing the current modification time to the previous modification time.
4. If the modification times are different, all data and attributes for the directory or file are purged from the cache, and new data and attributes are retrieved from the back file system.

An example of where CacheFS is suitable is in a CAD environment where master copies of drawing components can be held on the server and cached copies on the client workstation when in use.

CacheFS does not allow reads and writes on files that are 2 GB or larger in size.

CacheFS performance benefits

Because NFS data is cached on the local disk once it is read from the server, read requests to the NFS file system can be satisfied much faster than if the data had to be retrieved over the net again. Depending on the memory size and usage of the client, a small amount of data might be held and retrieved from memory, so that the benefits of cached data on the disk applies to a large amount of data that cannot be kept in memory. An additional benefit is that data on the disk cache will be held at system shutdown, whereas data cached in memory will have to be retrieved from the server again after the reboot.

Other potential NFS bottlenecks are a slow or busy network and a weak performing server with too many NFS clients to serve. Therefore, access from the client system to the server is likely to be slow. CacheFS will not prevent you from having to do the first read over the network and to access the server, but you can avoid reads over the network for further requests for the same data.

If more read requests can be satisfied from the client's local disk, the amount of NFS accesses to the server will decrease. This means that more clients can be served by the server; thus, the client per server ratio will increase.

Fewer read requests over the network will decrease your network load and, therefore, allow you to get some relief on very busy networks or space for other data transfers.

Not every application benefits from CacheFS. Because CacheFS only speeds up read performance, applications that mainly have huge read requests for the same data over and over again benefit from CacheFS. Large CAD applications certainly benefit from CacheFS, because of the often very large models that they have to load for their calculations.

Performance tests showed that sequential reads from the CacheFS file system are 2.4 to 3.4 times faster than reads from the NFS server's memory or disk.

CacheFS performance impacts

CacheFS will not increase the write performance to NFS file systems. However, you have some write options to choose as parameters to the **-o** option of the **mount** command, when mounting a CacheFS. They will influence the subsequent read performance to the data. The write options are as follows:

write around

The write around mode is the default mode and it handles writes the same way that NFS does. The writes are made to the back file system, and the affected file is purged from the cache. This means that write around voids the cache and new data must be obtained back from the server after the write.

non-shared

You can use the non-shared mode when you are certain that no one else will be writing to the cached file system. In this mode, all writes are made to both the front and the back file system, and the file remains in the cache. This means that future read accesses can be done to the cache, rather than going to the server.

Small reads might be kept in memory anyway (depending on your memory usage) so there is no benefit in also caching the data on the disk. Caching of random reads to different data blocks does not help, unless you will access the same data over and over again.

The initial read request still has to go to the server because only by the time a user attempts to access files that are part of the back file system will those files be placed in the cache. For the initial read request, you will see typical NFS speed. Only for subsequent accesses to the same data, you will see local JFS access performance.

The consistency of the cached data is only checked at intervals. Therefore, it is dangerous to cache data that is frequently changed. CacheFS should only be used for read-only or read-mostly data.

Write performance over a cached NFS file system differs from NFS Version 2 to NFS Version 3. Performance tests have shown the following:

- Sequential writes to a new file over NFS Version 2 to a CacheFS mount point can be 25 percent slower than writes directly to the NFS Version 2 mount point.
- Sequential writes to a new file over NFS Version 3 to a CacheFS mount point can be 6 times slower than writes directly to the NFS Version 3 mount point.

Configuring CacheFS

CacheFS is not implemented by default or prompted at the time of the creation of an NFS file system.

You must specify explicitly which file systems are to be mounted in the cache as follows:

1. Create the local cache file system by using the **cfsadmin** command:

```
# cfsadmin -c -o parameters cache-directory
```

where *parameters* specify the resource parameters and *cache-directory* is the name of the directory where the cache should be created.

2. Mount the back file system onto the cache:

```
# mount -V cachefs -o backfstype=nfs,cachedir=/cache-directory remhost:/rem-directory local-mount-point
```

where *rem-directory* is the name of the remote host and file system where the data resides, and *local-mount-point* is the mount point on the client where the remote file system should be mounted.

3. Alternately, you could administer CacheFS using the SMIT command (use the **smitty cachefs** fast path).

Several parameters can be set at creation time, as follows:

maxblocks

Sets the maximum number of blocks that CacheFS is allowed to claim within the front file system. Default = 90 percent.

minblocks

Sets the minimum number of blocks that CacheFS is allowed to claim within the front file system. Default = 0 percent.

threshblocks

Sets the number of blocks that must be available in the JFS file system on the client side before CacheFS can claim more than the blocks specified by **minblocks**. Default = 85 percent.

maxfiles

Maximum number of files that CacheFS can use, expressed as a percentage of the total number of i-nodes in the front file system. Default = 90 percent.

minfiles

Minimum number of files that CacheFS is always allowed to use, expressed as a percentage of the total number of i-nodes in the front file system. Default = 0 percent.

maxfilesize

Largest file size, expressed in megabytes, that CacheFS is allowed to cache. Default = 3.

NFS references

The following is a summary of NFS-related files, commands, daemons, and subroutines. See the *AIX 5L Version 5.3 System Management Guide: Communications and Networks* and the *AIX 5L Version 5.3 Commands Reference* for details.

List of NFS files

Following is a list of NFS files containing configuration information:

bootparams

Lists clients that diskless clients can use for booting

exports

Lists the directories that can be exported to NFS clients

networks

Contains information about networks on the Internet network

pcnfsd.conf

Provides configuration options for the **rpc.pcnfsd** daemon

rpc Contains database information for Remote Procedure Call (RPC) programs

xtab Lists directories that are currently exported

/etc/filesystems

Lists all the file systems that are attempted to be mounted at system restart

List of NFS commands

Following is a list of NFS commands:

chnfs Starts a specified number of **biod** and **nfsd** daemons

mknfs Configures the system to run NFS and starts NFS daemons

nfso Configures NFS network options

automount

Mounts an NFS file system automatically

chnfsexp

Changes the attributes of an NFS-exported directory

chnfsmnt

Changes the attributes of an NFS-mounted directory

exportfs

Exports and unexports directories to NFS clients

lsnfsexp

Displays the characteristics of directories that are exported with NFS

lsnfsmnt

Displays the characteristics of mounted NFS systems

mknfsexp

Exports a directory using NFS

mknfsmnt

Mounts a directory using NFS

rmnfs Stops the NFS daemons

rmnfsexp

Removes NFS-exported directories from a server's list of exports

rmnfsmnt

Removes NFS-mounted file systems from a client's list of mounts

List of NFS daemons

Following is a list of NFS locking daemons:

lockd Processes lock requests through the RPC package

statd Provides crash-and-recovery functions for the locking services on NFS

Following is a list of network service daemons and utilities:

biod Sends the client's read and write requests to the server

mountd

Answers requests from clients for file system mounts

nfsd Starts the daemons that handle a client's request for file system operations

pcnfsd

Handles service requests from PC-NFS clients

nfsstat

Displays information about a machine's ability to receive calls

on Executes commands on remote machines

portmap

Maps RPC program numbers to Internet port numbers

rex Accepts request to run programs from remote machines

rpcgen

Generates C code to implement an RPC protocol

rpcinfo

Reports the status of RPC servers

rstatd Returns performance statistics obtained from the kernel

rup Shows the status of a remote host on the local network

rusers

Reports a list of users logged on to the remote machines

rusersd

Responds to queries from the **rusers** command

rwall Sends messages to all users on the network

rwalld Handles requests from the **rwall** command

showmount

Displays a list of all clients that have mounted remote file systems

spray Sends a specified number of packets to a host

sprayd

Receives packets sent by the **spray** command

Following is a list of secure networking daemons and utilities:

chkey Changes the user's encryption key

keyenvoy

Provides an intermediary between user processes and the key server

keylogin

Decrypts and stores the user's secret key

keyserv

Stores public and private keys

mkkeyserv

Starts the **keyserv** daemon and uncomments the appropriate entries in the **/etc/rc.nfs** file

newkey

Creates a new key in the public key file

rmkeyserv

Stops the **keyserv** daemon and comments the entry for the **keyserv** daemon in the **/etc/rc.nfs** file

ypupdated

Updates information in Network Information Service (NIS) maps

Following is a diskless client support configuration file:

bootparamd

Provides information necessary for booting to diskless clients

Following is a list of NFS subroutines:

cbc_crypt(), des_setparity(), or ecb_crypt()

Implements Data Encryption Standard (DES) routines.

Chapter 16. LPAR performance

This topic provides insights and guidelines for considering, monitoring, and tuning AIX performance in partitions running on POWER4-based systems. For more information about partitions and their implementation, see *AIX 5L Version 5.3 AIX Installation in a Partitioned Environment* or *Hardware Management Console Installation and Operations Guide*.

This topic contains the following sections:

- “Performance considerations with logical partitioning”
- “Workload management in a partition” on page 312
- “LPAR performance impacts” on page 313
- “CPUs in a partition” on page 313
- “Virtual processor management within a partition” on page 314
- “Application considerations” on page 315

Performance considerations with logical partitioning

You can configure POWER4-based systems in a variety of ways, including the following:

- Larger systems with POWER4 CPUs packaged as Multi Chip Modules (MCM)
- Smaller systems with POWER4 CPUs packaged as Single Chip Modules (SCM)

Application workloads might vary in their performance characteristics on these systems.

LPAR offers flexible hardware use when the application software does not scale well across large numbers of processors, or when flexibility of the partitions is needed. In these cases, running multiple instances of an application on separate smaller partitions can provide better throughput than running a single large instance of the application. For example, if an application is designed as a single process with little to no threading, it will run fine on a 2-way or 4-way system, but might run into limitations running on larger SMP systems. Rather than redesigning the application to take advantage of the larger number of CPUs, the application can run in a parallel set of smaller CPU partitions.

The performance implications of logical partitioning should be considered when doing detailed, small variation analysis. The hypervisor and firmware handle the mapping of memory, CPUs and adapters for the partition. Applications are generally unaware of where the partition’s memory is located, which CPUs have been assigned, or which adapters are in use. There are a number of performance monitoring and tuning considerations for applications with respect to the location of memory to CPUs, sharing L2 and L3 caches, and the overhead of the hypervisor managing the partitioned environment on the system.

LPAR operating system considerations

Partitions on POWER4-based systems can run on the following operating systems:

- AIX 5L™ with a 32-bit kernel.
- AIX 5L with a 64-bit kernel. The AIX 5L 64-bit kernel is optimized for running 64-bit applications and improves scalability by allowing applications to use larger sizes of physical memory assigned to that partition.
- Linux® with a 64-bit kernel.

Each of the partitions on a system can run a different level of an operating system. Partitions are designed to isolate software running in one partition from software running in the other partitions. This includes protection against natural software breaks and deliberate software attempts to break the LPAR barrier. Data access between partitions is prevented, other than normal network connectivity access. A software partition crash in one partition will not cause a disruption to other partitions, including failures for both application software and operating system software. Partitions cannot make extensive use of an underlying

hardware shared resource to the point where other partitions using that resource become starved, for example partitions sharing the same PCI bridge chips are not able to lock the bus indefinitely.

System components

Several system components must work together to implement and support the LPAR environment. The relationship between processors, firmware, and operating system requires that specific functions need to be supported by each of these components. Therefore, an LPAR implementation is not based solely on software, hardware, or firmware, but on the relationship between the three components. The POWER4 microprocessor supports an enhanced form of system call, known as Hypervisor™ mode, that allows a privileged program access to certain hardware facilities. The support also includes protection for those facilities in the processor. This mode allows the processor to access information about systems located outside the boundaries of the partition where the processor is located. The hypervisor does use a small percentage of the system CPU and memory resources, so comparing a workload running with the hypervisor to one running without the hypervisor will typically show some minor impacts.

A POWER4-based system can be booted in a variety of partition configurations, including the following:

- Dedicated hardware system with no LPAR support running so the hypervisor is not running. This is called a Full System Partition.
- Partitions running on the system with the hypervisor running.

Affinity logical partitioning

Some POWER4-based systems have the ability to create affinity logical partitions. This feature automatically determines which system CPU and memory resources are to be used for each partition, based on their relative physical location to each other. The hardware management console, HMC, divides the system into symmetrical LPARs with 4-processor or 8-processor partitions, depending on the selection of the administrator in the setup process. The processors and memory are aligned on MCM boundaries. This is designed to allow the system to be used as a set of identical cluster nodes and provides performance optimization for scientific and technical workloads. If the system is booted in this mode, the ability to tune resources by adding and deleting CPUs and memory is not available. There is a performance gain in workloads running in an affinity logical partition over a normal logical partition.

Note: AIX memory affinity is not available in LPAR mode.

Workload management in a partition

The same workload management facilities in AIX exist within each AIX partition. There are no differences seen by the AIX Workload Manager, or WLM, running inside a partition. The WLM does not manage workloads across partitions. Application owners may be experienced with specifying CPUs or memory to a workload and want to extend this concept to partitions. However, in partitioning, CPUs are assigned to each partition outside the scope of the workload manager, so the ability to specify a set of CPUs from a specific MCM to a particular workload is not available. The workload manager and the **bindprocessor** command can still bind the previously-assigned CPUs to particular workloads.

Choice between partitioning and workload management

When making the choice between using partitions or using workload management for a particular set of workloads, applications, or solutions, there are several situations to consider. Generally, partitioning is considered the more appropriate mode of management when the following are present:

- Application dependencies that require different versions or fix levels of the operating system.
- Security requirements that require different owners/administrators, strong separation of sensitive data, or distributed applications with network firewalls between them.
- Different recovery procedures, for example **HA** clustering and application failover or differing disaster recovery procedures.

- Strong isolation of failures is required so that application or operating system failures do not affect each other.
- Separation of performance is needed so that the performance characteristics of the work loads must not interfere with shared resources.

Separation of performance is important when you are monitoring or tuning application workloads on a system that supports partitioning. It can be challenging to establish effective AIX workload management controls when you are working in conjunction with other critical workloads at the same time. Monitoring and tuning multiple applications is more practical in separate partitions where granular resources can be assigned to the partition.

LPAR performance impacts

The hypervisor functions running on a system in LPAR mode typically adds less than 5% overhead to normal memory and I/O operations. The impact of running in an LPAR is not significantly different from running on a similar processor in SMP mode. Running multiple partitions simultaneously generally has little performance impact on the other partitions, but there are circumstances that can affect performance. There is some extra overhead associated with the hypervisor for the virtual memory management. This should be minor for most workloads, but the impact increases with extensive amounts of page-mapping activity. Partitioning may actually help performance in some cases for applications that do not scale well on large SMP systems by enforcing strong separation between workloads running in the separate partitions.

Simulation of smaller systems

When used on POWER4-based MCM systems, the **rmss** command allocates memory from the system without respect to the location of that memory to the MCM. Detailed specific performance characteristics may change depending on what memory is available and what memory is assigned to a partition. For example, if you were to use the **rmss** command to simulate an 8-way partition using local memory, the actual assigned memory is not likely to be the physical memory closest to the MCM. In fact, the 8 processors are not likely to be the 8 processors on an MCM, but will instead be assigned from the available list.

A better way to simulate less amount of memory is to reduce the amount of memory available to the partition.

When deconfiguring CPUs on an MCM-based system, there are subtleties involved when the hypervisor implicitly using pathways between MCMs and memory. While the performance impacts are small, there can be some slight differences that may affect detailed performance analysis.

CPUs in a partition

This section discusses the following topics:

- “Assigned CPUs”
- “Impact of disabling CPUs” on page 314

Assigned CPUs

To view a list of CPUs that are assigned to an LPAR, select the Managed System (CEC) object on the HMC and view its properties. There is a tab that displays the current allocation state of all processors that are assigned to running partitions. AIX uses the firmware-provided numbers, which allows you to see from within a partition the processors that are used by looking at the CPU numbers and AIX location codes.

Verifying the status of the CPUs assigned to a two-processor partition looks similar to the following:

```
> lsdev -C | grep proc
proc17  Available 00-17  Processor
proc23  Available 00-23  Processor
```

Impact of disabling CPUs

When disabling CPUs on a POWER4-based system with an MCM, there is still routing of control flow and memory accessibility through the existing CPUs on the overall system. This might impact overall workload performance.

Virtual processor management within a partition

Starting with AIX 5.3, the kernel scheduler has been enhanced to dynamically increase and decrease the use of virtual processors in conjunction with the instantaneous load of the partition, as measured by the physical utilization of the partition. Every second, the kernel scheduler evaluates the number of virtual processors that should be activated to accommodate the physical utilization of the partition. If the number yields a high virtual processor utilization, the base number of virtual processors required is incremented to enable the workload to expand. You can request additional virtual processors with the **schedo** command. The value is then used to determine whether a virtual processor needs to be enabled or disabled, as the scheduler only adjusts the number of virtual processors in use each second by one. So, if the calculated number is greater than the number of virtual processors that are currently activated, a virtual processor is activated. If the number is less than the number of virtual processors that are currently activated, a virtual processor is deactivated.

When virtual processors are deactivated, they are not dynamically removed from the partition as with DLPAR. The virtual processor is no longer a candidate to run on or receive unbound work, however it can still run bound jobs. The number of online logical processors and online virtual processors that are visible to the user or applications does not change. There are no impacts to the middleware or the applications running on the system because the active and inactive virtual processors are internal to the system.

You can use the **vpm_xvcpus** tunable to enable and disable the virtual processor management feature of folding virtual processors. The default value of the **vpm_xvcpus** tunable is 0, which signifies that folding is enabled. This means that the virtual processors are being managed. You can use the **schedo** command to modify the **vpm_xvcpus** tunable. For more information, refer to *schedo Command in AIX 5L Version 5.3 Commands Reference, Volume 5*.

The following example disables the virtual processor management feature:

```
# schedo -o vpm_xvcpus=-1
```

To determine whether or not the virtual processor management feature is enabled, you can use the following command:

```
# schedo -a vpm_xvcpus
```

To increase the number of virtual processors in use by 1, you can use the following command:

```
# schedo -o vpm_xvcpus=1
```

Each virtual processor can consume a maximum of one physical processor. The number of virtual processors needed is determined by calculating the sum of the physical CPU utilization and the value of the **vpm_xvcpus** tunable, as shown in the following equation:

```
Number of virtual processors needed =  
Physical CPU utilization + Number of additional virtual processors to enable
```

If the number of virtual processors needed is less than the current number of enabled virtual processors, a virtual processor is disabled. If the number of virtual processors needed is greater than the current number of enabled virtual processors, a disabled virtual processor is enabled. Threads that are attached to a disabled virtual processor are still allowed to run on it.

Note: You should always round up the value that is calculated from the above equation to the next integer.

The following example describes how to calculate the number of virtual processors to use:

Over the last interval, partition A is utilizing two and a half processors. The `vpm_xvcpus` tunable is set to 1. Using the above equation,

Physical CPU utilization = 2.5

Number of additional virtual processors to enable (`vpm_xvcpus`) = 1

Number of virtual processors needed = 2.5 + 1 = 3.5

Rounding up the value that was calculated to the next integer equals 4. Therefore, the number of virtual processors needed on the system is 4. So, if partition A was running with 8 virtual processors, 4 virtual processors are disabled and 4 virtual processors remain enabled. If SMT is enabled, each virtual processor yields 2 logical processors. So, 8 logical processors are disabled and 8 logical processors are enabled.

In the following example, a modest workload that is running without the folding feature enabled consumes a minimal amount of each virtual processor that is allocated to the partition. The following output from the `mpstat -s` tool on a system with 4 virtual CPUs, indicates the utilization for the virtual processor and the two logical processors that are associated with it:

| | | | | | | | |
|--------|-------|--------|-------|--------|-------|--------|-------|
| Proc0 | | Proc2 | | Proc4 | | Proc6 | |
| 19.15% | | 18.94% | | 18.87% | | 19.09% | |
| cpu0 | cpu1 | cpu2 | cpu3 | cpu4 | cpu5 | cpu6 | cpu7 |
| 11.09% | 8.07% | 10.97% | 7.98% | 10.93% | 7.93% | 11.08% | 8.00% |

When the folding feature is enabled, the system calculates the number of virtual processors needed with the equation above. The calculated value is then used to decrease the number of virtual processors to what is needed to run the modest workload without degrading performance. The following output from the `mpstat -s` tool on a system with 4 virtual CPUs, indicates the utilization for the virtual processor and the two logical processors that are associated with it:

| | | | | | | | |
|--------|--------|-------|-------|-------|-------|-------|-------|
| Proc0 | | Proc2 | | Proc4 | | Proc6 | |
| 54.63% | | 0.01% | | 0.00% | | 0.08% | |
| cpu0 | cpu1 | cpu2 | cpu3 | cpu4 | cpu5 | cpu6 | cpu7 |
| 38.89% | 15.75% | 0.00% | 0.00% | 0.00% | 0.00% | 0.03% | 0.05% |

As you can see from the data above, the workload benefits from a decrease in utilization and maintenance of ancillary processors, and increased affinity when the work is concentrated on one virtual processor. When the workload is heavy however, the folding feature does not interfere with the ability to use all the virtual CPUs, if needed.

Application considerations

Generally, an application is not aware that it is running in a LPAR. There are some slight differences that you are aware of, but these are masked from the application. Apart from these considerations, AIX runs inside a partition the same way it runs on a standalone server. No differences are observed either from the application or your point of view. LPAR is transparent to AIX applications and most AIX performance tools. Third party applications only need to be certified for a level of AIX.

The `uname` command run in LPAR

The following is an example of the `uname` command and the string that is returned:

```
> uname -L
-1 NULL
```

The "-1" indicates that the system is not running with any logical partitions, but is running in full system partition mode.

The following example demonstrates how the **uname** command provides the partition number and the partition name as managed by the HMC:

```
> uname -L  
3 Web Server
```

Knowing that the application is running in an LPAR can be helpful when you are assessing slight performance differences.

Virtual console

There is no physical console on each partition. While the physical serial ports can be assigned to the partitions, they can only be in one partition at a time. For diagnostic purposes, and to provide an output for console messages, the firmware implements a virtual tty that is seen by AIX as a standard tty device. The virtual tty output is streamed to the HMC. The AIX diagnostics subsystem uses the virtual tty as the system console. From a performance perspective, if a lot of data is being written to the system console, which is being monitored on the HMC's console, the connection to the HMC is limited by the serial cable connection.

Time-of-Day clock

Each partition has its own Time-of-Day clock values so that partitions can work with different time zones. The only way partitions can communicate with each other is through standard network connectivity. When looking at traces or time-stamped information from each of the partitions on a system, each time stamp will be different according to how the partition was configured.

System serial number

The **uname -m** command provides a variety of system information as the partition is defined. The serial number is the system serial number, which is the same across the partitions. The same system serial number will be seen in each of the partitions.

Memory considerations

Partitions are defined with a "must have", a "desired", and a "minimum" amount of memory. When you are assessing changing performance conditions across system reboots, it is important to know that memory and CPU allocations might change based on the availability of the underlying resources. Also, remember that the amount of memory allocated to the partition from the HMC is the total amount allocated. Within the partition itself, some of that physical memory is used for hypervisor-page-table-translation support.

Memory is allocated by the system across the system. Applications in partitions cannot determine where memory has been physically allocated.

PTX considerations

Because each LPAR can logically be viewed as a separate machine with a distinct IP address, PTX monitors will treat each LPAR as a distinct machine. Each LPAR must have the PTX Agent, **xmservd**, installed to provide LPAR statistics. The PTX Manager, **xmperf**, can view the LPAR as a whole or provide more granular views of individual processors within the LPAR. The **xmperf** skeleton consoles are set up to provide these views, but the LPAR naming process might need to be explained so that the user can select the proper LPAR and processors within the LPAR.

The PTX **3dmon** component is updated to show a summary of partitions recognized as running on a single system. Like the **xmperf** operations, the **3dmon** component views each LPAR as it would an individual SMP machine. Select LPARs by their assigned host names.

Chapter 17. Dynamic logical partitioning

This topic provides an overview of dynamic logical partitioning, DLPAR. DLPAR is available on POWER4–based pSeries systems with microcode updates dated October 2002 or later. It is possible to run a variety of partitions with varying levels of operating systems, but you can only use DLPAR on partitions running AIX 5.2 or later.

This topic contains the following sections:

- DLPAR overview
- DLPAR performance implications
- DLPAR tuning tools
- DLPAR guidelines for adding CPUs or memory

DLPAR overview

Prior to the enablement of DLPAR, you rebooted a partition to add additional resources to a system. DLPAR increases the flexibility of logically partitioned systems by allowing you to dynamically add and remove processors, memory, I/O slots, and I/O drawers from active logical partitions. You can reassign hardware resources and adjust to changing system capacity demands without impacting the availability of the partition.

You can perform the following basic operations with DLPAR:

- Move a resource from one partition to another
- Remove a resource from a partition
- Add a resource to a partition

Processors, memory, and I/O slots that are not currently assigned to a partition exist in a “free pool.” Existing partitions on the system have no visibility to the other partitions on the system or the free pool. With DLPAR, when you remove a processor from an active partition, the system releases it to the pool, and that processor can then be added to an active partition. When a processor is added to an active partition, it has full access to all of the partition’s memory, I/O address space, and I/O interrupts. The processor can participate completely in that partition’s workload.

You can add or remove memory in 256 MB memory regions, or chunks. The effects of memory removal on an application running in an AIX partition are minimized by the fact that the AIX kernel runs almost entirely in virtual mode. The applications, kernel extensions and most of the kernel use only virtual memory. When memory is removed, the partition might start paging. Because parts of the AIX kernel are pageable, this could degrade performance. When you remove memory, you must monitor the paging statistics to ensure that paging is not induced.

It is possible to add or remove I/O slots, such as network adapters, CD ROM devices, or tape drives from active partitions. This avoids the problem of having to purchase and install duplicate physical devices to accommodate multiple partitions when the device itself might not be used often. Unlike adding or removing processors or memory, the reconfiguration of I/O slots requires certain PCI hot-plug procedures prior to adding or removing a device in an active partition. Hot-plug procedures are available through SMIT.

The Hardware Management Console, or HMC, is attached to the system and allows you to perform dynamic reconfiguration (DR) operations. The HMC must be running R3V1.0 or later to support DLPAR. For a list of HMC operations relating to DLPAR, refer to The Complete Partitioning Guide for IBM eServer pSeries Servers.

The hypervisor is a thin layer of software which provides hardware management capabilities and isolation to the virtual machines (the partitions) running on a single physical system. Commands to control the

movement of resources between partitions can be passed to the LPAR hypervisor via the HMC graphical user interface or through the HMC command line. You can only have one instance of the hypervisor running, and only the hypervisor has the ability to see and assign system resources. DLPAR does not compromise the security of a partition. Resources moved between partitions are re-initialized so that no residual data is left behind.

DLPAR performance implications

You can add or remove memory in multiple logical memory blocks. When removing memory from a partition, the time it takes to complete a DLPAR operation is relative to the number of memory chunks being removed. For example, a DR operation removing 4 GB of memory from an idle partition takes 1 to 2 minutes. However, dynamically partitioning large memory pages is not supported. A memory region that contains a large page cannot be removed.

The affinity logical partitioning configuration allocates CPU and memory resources in fixed patterns based on multi-chip module, MCM, boundaries. The HMC does not provide DR processor or memory support on affinity partitions. Only the I/O adapter resources can be dynamically reconfigured when you are running affinity logical partitioning.

You can also take advantage of dynamic resource allocation and deallocation by enabling applications and middleware to be DLPAR-aware. This means the application can resize itself to accommodate new hardware resources. AIX 5.2 provides DLPAR scripts and APIs to dynamically resize vendor applications. You can find instructions for using these scripts or API's in the DLPAR section of *AIX 5L Version 5.3 General Programming Concepts*.

DLPAR tuning tools

With DLPAR, the number of online processors can change dynamically. In order to track the difference between the number of online processors and the maximum number of processors possible in the system, you can use the following parameters:

_system_configuration.ncpus

Queries the number of online processors

_system_configuration.max_ncpus

Provides the maximum number of processors possible in the system

AIX supports trace hook **38F** to enable the trace facility to capture the addition and removal of processors and memory.

Performance monitoring tools such as **curt**, **splat**, **filemon**, **netpmon**, **tprof**, and **pprof** are not designed to handle DR activity. They rely on static processor or memory quantities. In some cases, a DR operation performed while the tool is running might not have any side effect, for example with the **tprof** and **pprof** tools. However, the DR operation could result in undefined behavior or misleading results with other tools like the **curt** tool, for example.

There are tools that support DR operations. These tools are designed to recognize configuration changes and adjust their reporting accordingly. Tools that provide DLPAR support are the following:

topas There are no changes to the interface, nor to the interpretation of the output. When you perform a DR operation, the **topas** tool will recognize the addition or removal of the resource and will report the appropriate statistics based on the new set of the resources.

sar, vmstat, and iostat

There are no changes to the interfaces, nor to the interpretation of the output of these commands. When you perform a DR operation, a message is sent to you, informing you of a configuration change. The tools then begin reporting the appropriate statistics based on the new set of resources.

rmss There is no change to the invocation of this command and it continues to work as expected if a DR operation occurs while the **rmss** tool is running.

DLPAR guidelines for adding CPUs or memory

When you remove memory from a partition, the DR operation succeeds even if there is not enough free physical memory available to absorb outgoing memory, provided there is enough paging space available instead of physical memory. Therefore it is important to monitor the paging statistics of the partition before and after a DR memory removal. The virtual memory manager is equipped to handle paging, however, excessive paging can lead to performance degradations.

You can use the guidelines available in Memory performance and CPU performance to determine when a memory or processor shortage is occurring. You can use the guidelines available in Network Performance to determine when I/O slots must be added. These guidelines can also be used to estimate the impact of reducing one of these resources.

Chapter 18. Micro-Partitioning

Logical partitions allow you to run multiple operating systems on the same system without interference. Prior to AIX 5.3, you were not able to share processors among the different partitions. Starting with AIX 5.3, you can use shared processor partitions, or SPLPAR, also known as Micro-Partitioning.

This topic contains the following sections:

- “Micro-Partitioning overview”
- “Implementation of Micro-Partitioning” on page 322
- “Micro-Partitioning performance implications” on page 322

Micro-Partitioning overview

Micro-Partitioning maps virtual processors to physical processors and the virtual processors are assigned to the partitions instead of the physical processors. You can use the Hypervisor to specify what percentage of processor usage to grant to the shared partitions, which is defined as an entitlement. The minimum processor entitlement is 10%.

You can realize the following advantages with micro partitioning:

- Optimal resource utilization
- Rapid deployment of new servers
- Application isolation

Micro-Partitioning is available on POWER5-based pSeries systems. It is possible to run a variety of partitions with varying levels of operating systems, but you can only use Micro-Partitioning on partitions running AIX 5.3 or later.

With IBM eServer p5 servers, you can choose the following types of partitions from the Hardware Management Console, or HMC:

- “Dedicated processor partition”
- “Shared processor partition”

Dedicated processor partition

If you use a dedicated processor partition, the entire processor is assigned to a particular logical partition. Also, the amount of processing capacity on the partition is limited by the total processing capacity of the processors configured in that partition, and it cannot go over this capacity, unless you add more processors inside the partition using a DLPAR operation.

Shared processor partition

If you use a shared processor partition, the physical processors are virtualized and then assigned to partitions. The virtual processors have capacities ranging from 10 percent of a physical processor, up to the entire processor. A system can therefore have multiple partitions sharing the same processors and dividing the processing capacity among themselves. The maximum number of virtual processors per partition is 64. For more information, see “Virtual processor management within a partition” on page 314.

Implementation of Micro-Partitioning

The following table lists the different types of processors you can use with Micro-Partitioning:

Table 5.

| Type of processor | Description |
|--------------------|--|
| Physical processor | A physical processor is the actual hardware resource, which represents the number of unique processor cores, not the number of processor chips. Each chip contains two processor cores. The maximum number of physical processors is 64 on POWER5-based systems. |
| Logical processor | A logical processor is the operating system's view of a managed processor unit. The maximum number of logical processors is 128. |
| Virtual processor | A virtual processor is the unit that represents the percentage of the logical processor that is shared by the different partitions. The maximum number of virtual processors is 64. |

As with LPAR, you can define the partitions in Micro-Partitioning with the HMC. When you create a partition, you must choose whether you want to create a shared processor partition or a dedicated processor partition. It is not possible to have both shared and dedicated processors in one partition. To enable the sharing of processors, you must configure the following options:

- The processor sharing mode: Capped or Uncapped¹
- The processing capacity: Weight²
- The number of virtual processors: Desired, Minimum, and Maximum

Notes:

1. Capped mode means that the processing capacity never exceeds the assigned capacity and uncapped mode means that the processing capacity can be exceeded when the shared processing pool has available resources.
2. The processing capacity is specified in terms of processing units that are measured in fractions of 0.01 of a processor. So for example, to assign a processing capacity for a half of a processor, you must specify 0.50 processing units on the HMC.

Micro-Partitioning performance implications

You might experience a positive or a negative impact on performance with Micro-Partitioning. The benefit of Micro-Partitioning is that it allows for increased overall utilization of system resources by applying only the required amount of processor resource needed by each partition. But due to the overhead associated with maintaining online virtual processors, consider the capacity requirements when choosing values for the attributes.

For optimal performance, ensure that you create the minimal amount of partitions, which decreases the overhead of scheduling virtual processors.

CPU-intensive applications, like high performance computing applications, might not be suitable for a Micro-Partitioning environment. If an application use most of its entitled processing capacity during execution, you should use a dedicated processor partition to handle the demands of the application.

Chapter 19. Application Tuning

Before spending a lot of effort to improve the performance of a program, use the techniques in this chapter to help determine how much its performance can be improved and to find the areas of the program where optimization and tuning will have the most benefit. For an extensive discussion of these techniques, see *Optimization and Tuning Guide for XL Fortran, XL C and XL C++*. Also see *Designing and Implementing Efficient Programs* for additional hints and tips.

In general, the optimization process involves several steps:

- Some tuning involves changing the source code, for example, by reordering statements and expressions. This technique is known as *hand tuning*.
- For FORTRAN and C programs, optimizing preprocessors are available to tune and otherwise transform source code before it is compiled. The output of these preprocessors is FORTRAN or C source code that has been optimized.
- The FORTRAN or C++ compiler translates the source code into an intermediate language.
- A code generator translates the intermediate code into machine language. The code generator can optimize the final executable code to speed it up, depending on the selected compiler options. You can increase the amount of optimization performed in this step by hand-tuning or preprocessing first.

The speed increase is affected by two factors:

- The amount of optimization applied to individual parts of the program
- The frequency of use for those parts of the program at run time

Speeding up a single routine might speed up the program significantly if that routine performs the majority of the work, on the other hand, it might not improve overall performance much if the routine is rarely called and does not take long anyway. Keep this point in mind when evaluating the performance techniques and data, so that you focus on the techniques that are most valuable in your work.

This chapter contains the following major sections:

- Compiler Optimization Techniques
- Optimizing Preprocessors for FORTRAN and C
- Code-Optimization Techniques

Compiler Optimization Techniques

The three main areas of source-code tuning are as follows:

- Programming techniques that take advantage of the optimizing compilers and the system architecture.
- BLAS, a library of Basic Linear Algebra Subroutines. If you have a numerically intensive program, these subroutines can provide considerable performance enhancement. An extension of BLAS is ESSL, the Engineering Scientific Subroutine Library. In addition to a subset of the BLAS library, ESSL includes other high-performance mathematical routines for chemistry, engineering, and physics. A Parallel ESSL (PESSL) exists for SMP machines.
- Compiler options and the use of preprocessors like KAP and VAST, available from third-party vendors.

In addition to these source-code tuning techniques, the **fdpr** program restructures object code. The **fdpr** program is described in *Restructuring Executable Programs with the fdpr Program*.

Compiling with Optimization (-O, -O2, -O3, -O4, -O5, qstrict, -qhot, -qipa)

To produce a program that achieves good performance, the first step is to take advantage of the basic optimization features built into the compiler. Doing so can increase the speedup that comes from tuning your program and can remove the need to perform some kinds of tuning.

Recommendations

Follow these guidelines for optimization:

- Use **-O2** or **-O3 -qstrict** for any production-level FORTRAN, C, or C++ program you compile. For High Performance FORTRAN (HPF) programs, do not use the **-qstrict** option.
- Use the **-qhot** option for programs where the hotspots are loops or array language. Always use the **-qhot** option for HPF programs.
- Use the **-qipa** option near the end of the development cycle if compilation time is not a major consideration.

The **-qipa** option activates or customizes a class of optimizations known as *interprocedural analysis*. The **-qipa** option has several suboptions that are detailed in the compiler manual. It can be used in two ways:

- The first method is to compile with the **-qipa** option during both the compile and link steps. During compilation, the compiler stores interprocedural analysis information in the **.o** file. During linking, the **-qipa** option causes a complete recompilation of the entire application.
- The second method is to compile the program for profiling with the **-p/-pg** option (with or without **-qipa**), and run it on a typical set of data. The resulting data can then be fed into subsequent compilations with **-qipa** so that the compiler concentrates optimization in the seconds of the program that are most frequently used.

Using **-O4** is equivalent to using **-O3 -qipa** with automatic generation of architecture and tuning option ideal for that platform. Using the **-O5** flag is similar to **-O4** except that **-qipa= level = 2**.

You gain the following benefits when you use compiler optimization:

Branch optimization

Rearranges the program code to minimize branching logic and to combine physically separate blocks of code.

Code motion

If variables used in a computation within a loop are not altered within the loop, the calculation can be performed outside of the loop and the results used within the loop.

Common subexpression elimination

In common expressions, the same value is recalculated in a subsequent expression. The duplicate expression can be eliminated by using the previous value.

Constant propagation

Constants used in an expression are combined, and new ones are generated. Some implicit conversions between integers and floating-point types are done.

Dead code elimination

Eliminates code that cannot be reached or where the results are not subsequently used.

Dead store elimination

Eliminates stores when the value stored is never referenced again. For example, if two stores to the same location have no intervening load, the first store is unnecessary and is removed.

Global register allocation

Allocates variables and expressions to available hardware registers using a "graph coloring" algorithm.

Inlining

Replaces function calls with actual program code

Instruction scheduling

Reorders instructions to minimize execution time

Interprocedural analysis

Uncovers relationships across function calls, and eliminates loads, stores, and computations that cannot be eliminated with more straightforward optimizations.

Invariant IF code floating (Unswitching)

Removes invariant branching code from loops to make more opportunity for other optimizations.

Profile driven feedback

Results from sample program execution are used to improve optimization near conditional branches and in frequently executed code sections.

Reassociation

Rearranges the sequence of calculations in an array subscript expression, producing more candidates for common expression elimination.

Store motion

Moves store instructions out of loops.

Strength Reduction

Replaces less efficient instructions with more efficient ones. For example, in array subscripting, an add instruction replaces a multiply instruction.

Value numbering

Involves constant propagation, expression elimination, and folding of several instructions into a single instruction.

When to Compile without Optimization

Do not use the **-O** option for programs that you intend to debug with a symbolic debugger, regardless of whether you use the **-g** option. However, because optimization is so important to HPF programs, use **-O3 -qhot** for them even during debugging.

The optimizer rearranges assembler-language instructions, making it difficult to map individual instructions to a line of source code. If you compile with the **-g** option, this rearrangement may give the appearance that the source-level statements are executed in the wrong order when you use a symbolic debugger.

If your program produces incorrect results when it is compiled with any of the **-O** options, check your program for unintentionally aliased variables in procedure references.

Compiling for Specific Hardware Platforms (-qarch, -qtune)

Systems can use several type of processors. By using the **-qarch** and **-qtune** options, you can optimize programs for the special instructions and particular strengths of these processors.

Recommendations

Follow these guidelines for compiling for specific hardware platforms:

- If your program will be run only on a single system, or on a group of systems with the same processor type, use the **-qarch** option to specify the processor type.
- If your program will be run on systems with different processor types, and you can identify one processor type as the most important, use the appropriate **-qarch** and **-qtune** settings. XL FORTRAN and XL HPF users can use the **xxlf** and **xxlhp** commands to select these settings interactively.
- If your program is intended to run on the full range of processor implementations, and is not intended primarily for one processor type, do not use either **-qarch** or **-qtune**.

Compiling for Floating-Point Performance (-qfloat)

You can change some default floating-point options to enhance performance of floating-point intensive programs. Some of these options can affect conformance to floating-point standards. Using these options can change the results of computations, but in many cases the result is an increase in accuracy.

Recommendations

Follow these guidelines:

- For single-precision programs on POWER family and POWER2 platforms, you can enhance performance while preserving accuracy by using these floating-point options:

```
-qfloat=fltint:rsqrt:hssngl
```

If your single-precision program is not memory-intensive (for example, if it does not access more data than the available cache space), you can obtain equal or better performance, and greater precision, by using:

```
-qfloat=fltint:rsqrt -qautodbl=dblpad4
```

For programs that do not contain single-precision variables, use **-qfloat=rsqrt:fltint** only. Note that **-O3** without **-qstrict** automatically sets **-qfloat=rsqrt:fltint**.

- Single-precision programs are generally more efficient than double-precision programs, so promoting default REAL values to REAL(8) can reduce performance. Use the following **-qfloat** suboptions:

Specifying Cache Sizes (-qcache)

If your program is intended to run exclusively on a single machine or configuration, you can help the compiler tune your program to the memory layout of that machine by using the FORTRAN **-qcache** option. You must also specify the **-qhot** option for **-qcache** to have any effect. The **-qhot** option uses the **-qcache** information to determine appropriate memory-management optimizations.

There are three types of cache: data, instruction, and combined. Models generally fall into two categories: those with both data and instruction caches, and those with a single, combined data/instruction cache. The TYPE suboption lets you identify which type of cache the **-qcache** option refers to.

The **-qcache** option can also be used to identify the size and set associativity of a model's level-2 cache and the Translation Lookaside Buffer (TLB), which is a table used to locate recently referenced pages of memory. In most cases, you do not need to specify the **-qcache** entry for a TLB unless your program uses more than 512 KB of data space.

There may be cases where a lower setting for the SIZE attribute gives enhanced performance, depending on the system load at the time of a run.

Expanding Procedure Calls Inline (-Q)

Inlining involves copying referenced procedures into the code from which they are referenced. This eliminates the calling overhead for inlined routines and enables the optimizer to perform other optimizations in the inlined routines.

For FORTRAN and C programs, you can specify the **-Q** option (along with **-O2** or **-O3**) to have procedures inlined into their reference points.

Inlining enhances performance in some programs, while it degrades performance in others. A program with inlining might slow down because of larger code size, resulting in more cache misses and page faults, or because there are not enough registers to hold all the local variables in some combined routines.

If you use the **-Q** option, always check the performance of the version of your program compiled with **-O3** and **-Q** to that compiled only with **-O3**. Performance of programs compiled with **-Q** might improve dramatically, deteriorate dramatically, or change little or not at all.

The compiler decides whether to inline procedures based on their size. You might be able to enhance your application's performance by using other criteria for inlining. For procedures that are unlikely to be referenced in a typical execution (for example, error-handling and debugging procedures), disable inlining selectively by using the **-Q-names** option. For procedures that are referenced within hot spots, specify the **-Q+names** option to ensure that those procedures are always inlined.

When to Use Dynamic Linking and Static Linking

The operating system provides facilities for creating and using dynamically linked shared libraries. With dynamic linking, external symbols referenced in user code and defined in a shared library are resolved by the loader at load time. When you compile a program that uses shared libraries, they are dynamically linked to your program by default.

The idea behind shared libraries is to have only one copy of commonly used routines and to maintain this common copy in a unique shared-library segment. These common routines can significantly reduce the size of executable programs, thereby saving disk space.

You can reduce the size of your programs by using dynamic linking, but there is usually a tradeoff in performance. The shared library code is not present in the executable image on disk, but is kept in a separate library file. Shared code is loaded into memory once in the shared library segment and shared by all processes that reference it. Dynamically linked libraries therefore reduce the amount of virtual storage used by your program, provided that several concurrently running applications (or copies of the same application) use the procedures provided in the shared library. They also reduce the amount of disk space required for your program provided that several different applications stored on a given system share a library. Other advantages of shared libraries are as follows:

- Load time might be reduced because the shared library code might already be in memory.
- Run-time performance can be enhanced because the operating system is less likely to page out shared library code that is being used by several applications, or copies of an application, rather than code that is only being used by a single application. As a result, fewer page faults occur.
- The routines are not statically bound to the application but are dynamically bound when the application is loaded. This permits applications to automatically inherit changes to the shared libraries, without recompiling or rebinding.

Disadvantages of dynamic linking include the following:

- From a performance viewpoint, there is "glue code" that is required in the executable program to access the shared segment. There is a performance cost in references to shared library routines of about eight machine cycles per reference. Programs that use shared libraries are usually slower than those that use statically-linked libraries.
- A more subtle effect is a reduction in "locality of reference." You may be interested in only a few of the routines in a library, and these routines may be scattered widely in the virtual address space of the library. Thus, the total number of pages you need to touch to access all of your routines is significantly higher than if these routines were all bound directly into your executable program. One impact of this situation is that, if you are the only user of these routines, you experience more page faults to get them all into real memory. In addition, because more pages are touched, there is a greater likelihood of causing an instruction translation lookaside buffer (TLB) miss.
- When a program references a limited number of procedures in a library, each page of the library that contains a referenced procedure must be individually paged into real memory. If the procedures are small enough that using static linking might have linked several procedures that are in different library pages into a single page, then dynamic linking may increase paging thus decreasing performance.
- Dynamically linked programs are dependent on having a compatible library. If a library is changed (for example, a new compiler release may change a library), applications might have to be reworked to be made compatible with the new version of the library. If a library is removed from the system, programs using that library will no longer work.

In statically-linked programs, all code is contained in a single executable module. Library references are more efficient because the library procedures are statically linked into the program. Static linking increases the file size of your program, and it may increase the code size in memory if other applications, or other copies of your application, are running on the system.

The **cc** command defaults to the shared-library option. To override the default, when you compile your programs to create statically-linked object files, use the **-bnso** option as follows:

```
cc xxx.c -o xxx.nosh -0 -bnso -bI:/lib/syscalls.exp
```

This option forces the linker to place the library procedures your program references into the program's object file. The **/lib/syscalls.exp** file contains the names of system routines that must be imported to your program from the system. This file must be specified for static linking. The routines that it names are imported automatically by **libc.a** for dynamic linking, so you do not need to specify this file during dynamic linking. For further details on these options, see Appendix B. Efficient Use of the **ld** Command and the **ld** command.

Determining If Nonshared Libraries Help Performance

One method of determining whether your application is sensitive to the shared-library approach is to recompile your executable program using the **nonshare** option. If the performance is significantly better, you may want to consider trading off the other advantages of shared libraries for the performance gain. Be sure to measure performance in an authentic environment, however. A program that had been bound nonshared might run faster as a single instance in a lightly loaded machine. That same program, when used by a number of users simultaneously, might increase real memory usage enough to slow down the whole workload.

Specifying the Link Order to Reduce Paging for Large Programs

During the linkage phase of program compilation, the linker relocates program units in an attempt to improve locality of reference. For example, if a procedure references another procedure, the linker may make the procedures adjacent in the load module, so that both procedures fit into the same page of virtual memory. This can reduce paging overhead. When the first procedure is referenced for the first time and the page containing it is brought into real memory, the second procedure is ready for use without additional paging overhead.

In very large programs where paging occurs excessively for pages of your program's code, you may decide to impose a particular link order on the linker. You can do this by arranging control sections in the order you want them linked, and by using the **-bnoobjreorder** option to prevent the linker from reordering. A control section or CSECT is the smallest replaceable unit of code or data in an XCOFF object module. For further details, see the *AIX 5L Version 5.3 Files Reference*.

However, there are a number of risks involved in specifying a link order. Any link reordering should always be followed by thorough performance testing to demonstrate that your link order gives superior results for your program over the link order that the linker chooses. Take the following points into account before you decide to establish your own link order:

- You must determine the link order for all CSECTs in your program. The CSECTs must be presented to the linker in the order in which you want to link them. In a large program, such an ordering effort is considerable and prone to errors.
- A performance benefit observed during development of a program can become a performance loss later on, because the changing code size can cause CSECTs that were previously located together in a page to be split into separate pages.
- Reordering can change the frequency of instruction cache-line collisions. On implementations with an instruction cache or combined data and instruction cache that is two-way set-associative, any line of program code can only be stored in one of two lines of the cache. If three or more short, interdependent procedures have the same cache-congruence class, instruction-cache thrashing can reduce performance. Reordering can cause cache-line collisions where none occurred before. It can also eliminate cache-line collisions that occur when **-bnoobjreorder** is not specified.

If you attempt to tune the link order of your programs, always test performance on a system where total real storage and memory utilization by other programs are similar to the anticipated working environment. A link order that works on a quiet system with few tasks running can cause page thrashing on a busier system.

Calling the BLAS and ESSL Libraries

The Basic Linear Algebra Subroutines (BLAS) provide a high level of performance for linear algebraic equations in matrix-matrix, matrix-vector, and vector-vector operations. The Engineering and Scientific Subroutine Library (ESSL), contains a more comprehensive set of subroutines, all of which are tuned for the POWER family, POWER2, and PowerPC architecture. The BLAS and ESSL subroutines can save you considerable effort in tuning many arithmetic operations, and still provide performance that is often better than that obtained by hand-tuning or by automatic optimization of hand-coded arithmetic operations. You can call functions from both libraries from FORTRAN, C, and C++ programs.

The BLAS library is a collection of Basic Linear Algebra Subroutines that have been highly tuned for the underlying architecture. The BLAS subset is provided with the operating system (*/lib/libblas.a*).

Users should use this library for their matrix and vector operations, because they are tuned to a degree that users are unlikely to achieve on their own.

The BLAS routines are designed to be called from FORTRAN programs, but can be used with C programs. Care must be taken due to the language difference when referencing matrixes. For example, FORTRAN stores arrays in column major order, while C uses row major order.

To include the BLAS library, which exists in */lib/libblas.a*, use the **-lblas** option on the compiler statement (**xl f -O prog.f -lblas**). If calling BLAS from a C program, also include the **-lxlf** option for the FORTRAN library (**cc -O prog.c -lblas -lxlf**).

ESSL is a more advanced library that includes a variety of mathematical functions used in the areas of engineering, chemistry and physics.

Advantages to using the BLAS or ESSL subroutines are as follows:

- BLAS and ESSL subroutine calls are easier to code than the operations they replace.
- BLAS and ESSL subroutines are portable across different platforms. The subroutine names and calling sequences are standardized.
- BLAS code is likely to perform well on all platforms. The internal coding of the routines is usually platform-specific so that the code is closely tied to the architecture's performance characteristics.

In an example program, the following nine lines of FORTRAN code:

```
do l=1,control
do j=1,control
    xmult=0.d0
    do k=1,control
        xmult=xmult+a(i,k)*a(k,j)
    end do
    b(i,j)=xmult
end do
end do
```

were replaced by the following line of FORTRAN that calls a BLAS routine:

```
call dgemm ('n','n',control,control,control,1,d0,a, control,a,1control,1,d0,b,control)
```

The following performance enhancement was observed:

| Array Dimension | MULT Elapsed | BLAS Elapsed | Ratio |
|-----------------|--------------|--------------|-------|
| 101 x 101 | .1200 | .0500 | 2.40 |
| 201 x 201 | .8900 | .3700 | 2.41 |
| 301 x 301 | 16.4400 | 1.2300 | 13.37 |
| 401 x 401 | 65.3500 | 2.8700 | 22.77 |
| 501 x 501 | 170.4700 | 5.4100 | 31.51 |

This example demonstrates how a program using matrix multiplication operations could better use a level 3 BLAS routine for enhanced performance. Note that the improvement increases as the array size increases.

Profile Directed Feedback (PDF)

PDF is a compiler option to do further procedural level optimization such as directing register allocations, instruction scheduling, and basic block rearrangement. To use PDF, do the following:

1. Compile the source files in a program with **-qpdf1** (the function **main()** must be compiled also). The **-lpdf** option is required during the link step. All the other compilation options used must also be used during step 3.
2. Run the program all the way through a typical data set. The program records profiling information when it exits into a file called **._BLOCKS** in the directory specified by the **PDFDIR** environment variable or in the current working directory if that variable is not set. You can run the program multiple times with different data sets, and the profiling information is accumulated to provide an accurate count of how often branches are taken and blocks of code are executed. It is important to use data that is representative of the data used during a typical run of your finished program.
3. Recompile the program using the same compiler options as in step 1, but change **-qpdf1** to **-qpdf2**. Remember that **-L** and **-I** are linker options, and you can change them at this point; in particular, omit the **-lpdf** option. In this second compilation, the accumulated profiling information is used to fine-tune the optimizations. The resulting program contains no profiling overhead and runs at full speed.

Two commands are available for managing the **PDFDIR** directory:

resetpdf *pathname*

Clears all profiling information (but does not remove the data files) from the *pathname* directory. If *pathname* is not specified, from the **PDFDIR** directory; or if **PDFDIR** is not set, from the current directory. When you make changes to the application and recompile some files, the profiling information for these files is automatically reset. Run the **resetpdf** command to reset the profiling information for the entire application, after making significant changes that may affect execution counts for parts of the program that were not recompiled.

cleanpdf *pathname*

Removes all profiling information from the *pathname* or **PDFDIR** or current directory. Removing the profile information reduces the run-time overhead if you change the program and then go through the PDF process again. Run this program after compiling with **-qpdf2**.

The fdpr Command

The **fdpr** command can rearrange the code within a compiled executable program to improve branching performance, move rarely used code away from program hot spots, and do other global optimizations. It works best for large programs with many conditional tests, or highly structured programs with multiple, sparsely placed procedures. The **fdpr** command is described in Restructuring Executable Programs with the **fdpr** Program.

Optimizing Preprocessors for FORTRAN and C

The KAP and VAST preprocessors for the FORTRAN compiler can restructure FORTRAN source code to better use the POWER family, POWER2, and PowerPC® processing unit resources and memory hierarchy. A version of the KAP preprocessor is also available for restructuring the code of C programs. The preprocessors perform memory management optimizations, algebraic transformations, inlining, interprocedural analysis, and other optimizations that improve the performance of FORTRAN or C applications.

Performance tests indicate improvements in the range of 8 to 18 percent, on average, when a suite of programs is compiled with the preprocessors, compared to compiling with the same optimization options for the unprocessed version.

The KAP and VAST preprocessors attempt to transform source-level algorithms into algorithms that can take full advantage of the optimizing capabilities of the compiler. The preprocessors also generate listings that identify the transformations performed and areas of your code that prevent transformations from being carried out. The preprocessors analyze source code, and perform transformations that can improve a program's performance.

Any transformation done by the preprocessors can also be accomplished through hand-tuning. The advantages of using a preprocessor rather than hand-tuning are as follows:

- In many cases, the preprocessors yield programs that perform as efficiently as, or more efficiently than, their hand-tuned equivalents, without a significant investment of programmer time. If you use the preprocessors, you may not require as thorough an understanding of the architecture or of tuning techniques discussed elsewhere in this book.
- For certain programs, you can get code that is highly optimized, simply by selecting appropriate command-line preprocessor options and by adding a small number of directives to the source code of your program. In cases where the preprocessors do not yield a noticeable improvement, work with the preprocessor listings to see what areas of the source code prevent optimization.
- Some of the transformations done by the preprocessors involve considerable expansion of source code. While these expansions can improve your program's efficiency, implementing them through hand-tuning would increase the likelihood of algorithmic and typographical errors, reduce the readability of the source code, and make program maintenance more difficult.
- The preprocessors can generate code that is tuned for a particular architectural configuration, even one that is not available on POWER family, POWER2, and PowerPC systems. You can maintain a single version of source code, and produce transformed versions that are tuned for different POWER™, POWER2™, and PowerPC models or for machines with other cache and processor characteristics.
- The preprocessors can often improve on hand-tuned code. Although it is possible to tune your programs by hand to as great a level of efficiency as the preprocessors do, some of the more complicated transformations can lead to coding errors when attempted by hand.

Code-Optimization Techniques

The degradation from inefficient use of memory is much greater than that from inefficient use of the caches, because the difference in speed between memory and disk is much higher than between cache and memory. Code-optimization techniques include the following:

- To minimize the code working set of a program, pack frequently executed code together, while separating infrequently used code. In other words, do not put long blocks of error handling code in line and load frequently called modules next to their callers.
- To minimize the data working set, concentrate frequently used data together and avoid unnecessary references to pages. This can be accomplished by using the **malloc()** subroutine instead of the **calloc()** subroutine, initializing data structures immediately before they are used and being sure to free and disclaim allocated space when no longer needed.

- To minimize pinned storage, package pinned code in separate load modules. Make sure it is necessary to use pinned code. Certain system structures (such as mbuf pools) are pinned in memory; do not arbitrarily increase them.
- Real-time techniques can be used, such as the **pllock()** subroutine to pin code in memory, and priorities pinned with the **setpri()** subroutine.

Mapped Files

The use of mapped files is another code-optimization technique. Applications can use the **shmat()** or **mmap()** system calls to access files by address, instead of using multiple read and write system calls. Because there is always overhead associated with system calls, the fewer calls used, the better. The **shmat()** or **mmap()** calls can enhance performance up to 50 times compared with traditional **read()** or **write()** system calls. To use the **shmat()** subroutine, a file is opened and a file descriptor (*fd*) returned, just as if read or write system calls are being used. A **shmat()** call then returns the address of the mapped file. Setting elements equal to subsequent addresses in a file, instead of using multiple read system calls, does read from a file to a matrix.

The **mmap()** call allows mapping of memory to cross segment boundaries. A user can have more than 10 areas mapped into memory. The **mmap()** functions provide page-level protection for areas of memory. Individual pages can have their own read or write, or they can have no-access permissions set. The **mmap()** call allows the mapping of only one page of a file.

The **shmat()** call also allows mapping of more than one segment, when a file being mapped is greater than a segment.

The following example program reads from a file using read statements:

```
fd = open("myfile", O_RDONLY);
for (i=0; i<cols; i++) {
    for (j=0; j<rows; j++) {
        read(fd, &n, sizeof(char));
        *p++ = n;
    }
}
```

Using the **shmat()** subroutine, the same result is accomplished without read statements:

```
fd = open("myfile", O_RDONLY);
nptr = (signed char *) shmat(fd, 0, SHM_MAP | SHM_RDONLY);
for (i=0; i<cols; i++) {
    for (j=0; j<rows; j++) {
        *p++ = *nptr++;
    }
}
```

The only drawback to using explicitly mapped files is on the writes. The system write-behind feature, that periodically writes modified pages to a file in an orderly fashion using sequential blocks, does not apply when an application uses the **shmat()** or **mmap()** subroutine. Modified pages can collect in memory and will only be written randomly when the Virtual Memory Manager (VMM) needs the space. This situation often results in many small writes to the disk, causing inefficiencies in CPU and disk usage.

Chapter 20. Java performance monitoring

Java is an object-oriented programming language developed by Sun Microsystems, Inc. It is modeled after C++, and was designed to be small, simple, and portable across platforms and operating systems at the source level and at the binary level. Java programs, which include applets and applications, can therefore run on any machine that has the Java Virtual Machine, JVM, installed.

This topic provides insights and general guidelines for isolating bottlenecks and tuning performance in Java applications in the following sections:

- Advantages of Java
- Java performance guidelines
- Java monitoring tools
- Java tuning for AIX
- Garbage collection impacts to Java performance

Advantages of Java

Java has significant advantages over other languages and environments that make it suitable for just about any programming task.

The advantages of Java are as follows:

- Java is easy to learn.
Java was designed to be easy to use and is therefore easy to write, compile, debug, and learn than other programming languages.
- Java is object-oriented.
This allows you to create modular programs and reusable code.
- Java is platform-independent.
One of the most significant advantages of Java is its ability to move easily from one computer system to another. The ability to run the same program on many different systems is crucial to World Wide Web software, and Java succeeds at this by being platform-independent at both the source and binary levels.

Because of Java's robustness, ease of use, cross-platform capabilities and security features, it has become a language of choice for providing worldwide Internet solutions.

Java performance guidelines

The following are basic guidelines to improving Java performance on AIX:

- Use the **StringBuffer** function instead of string concatenations when doing excessive string manipulations to avoid unnecessarily creating objects that eventually must undergo garbage collection.
- Avoid excessive writing to the Java console to reduce the cost of string manipulations, text formatting, and output.
- Avoid the costs of object creation and manipulation by using primitive types for variables when necessary.
- Cache frequently-used objects to reduce the amount of garbage collection needed, and avoid the need to re-create the objects.
- Group native operations to reduce the number of Java Native Interface (JNI) calls when possible.
- Use synchronized methods only when necessary to limit the multitasking in the JVM and operating system.
- Avoid invoking the garbage collector unless necessary. If you must invoke it, do so only during idle time or some noncritical phase.

- Use the **int** type instead of the **long** type whenever possible, because 32-bit operations are executed faster than 64-bit operations.
- Declare methods as **final** whenever possible. Final methods are handled better by the JVM.
- Use the **static final** key word when creating constants in order to reduce the number of times the variables need to be initialized.
- Avoid unnecessary "casts" and "instanceof" references, because casting in Java is done at run time.
- Avoid the use of vectors whenever possible when an array will suffice.
- Add and delete items from the end of the vector.
- Compile Java files with the **-O** option.
- Avoid allocating objects within loops.
- Use buffer I/O and tune the buffer size.
- Use connection pools and cached-prepared statements for database access.
- Use connection pools to the database and reuse connections rather than repeatedly opening and closing connections.
- Maximize and minimize thread creation and destruction cycles.
- Minimize the contention for shared resources.
- Minimize the creation of short-lived objects.
- Avoid remote method calls.
- Use callbacks to avoid blocking remote method calls.
- Avoid creating an object only used for accessing a method.
- Keep synchronized methods out of loops.
- Store string and char data as Unicode in the database.
- Reorder CLASSPATH so that the most frequently used libraries occur first.

Java monitoring tools

You can use the following tools to monitor and identify performance inhibitors in your Java applications:

vmstat

Provides information about various system resources. It reports statistics on kernel threads in the run queue as well as in the wait queue, memory usage, paging space, disk I/O, interrupts, system calls, context switches, and CPU activity.

iostat Reports detailed disk I/O information.

topas Reports CPU, network, disk I/O, Workload Manager and process activity.

tprof Profiles the application to pinpoint any hot routines or methods, which can be considered performance problems.

ps -mo THREAD

Shows to which CPU a process or thread is bound.

Java profilers [-Xrunhprof, Xrunjpa64 (64-bit kernel), -Xrunjpa 32-bit kernel]

Determines which routines or methods are the most heavily used.

java -verbose:gc

Checks the impact of garbage collection on your application. It reports total time spent doing garbage collection, average time per garbage collection, average memory collected per garbage collection, and average objects collected per garbage collection.

Java tuning for AIX

The following parameters are recommended AIX settings for your JAVA environment:

AIXTHREAD_SCOPE=S

The default value for this variable is **P**, which signifies process-wide contention scope (M:N). For Java applications, you should set this value to **S**, which signifies system-wide contention scope (1:1).

AIXTHREAD_MUTEX_DEBUG=OFF

Maintains a list of active mutexes for use by the debugger.

AIXTHREAD_COND_DEBUG=OFF

Maintains a list of condition variables for use by the debugger.

AIXTHREAD_RWLOCK_DEBUG=OFF

Maintains a list of active mutual exclusion locks, condition variables, and read-write locks for use by the debugger. When a lock is initialized, it is added to the list if it is not there already. This list is implemented as a linked list, so searching it to determine if a lock is present or not has a performance implication when the list gets large. The problem is compounded by the fact that the list is protected by a lock, which is held for the duration of the search operation. Other calls to the **pthread_mutex_init()** subroutine must wait while the search is completed. For optimal performance, you should set the value of this thread-debug option to **OFF**. Their default is **ON**.

SPINLOOPTIME=500

Number of times that a process can spin on a busy lock before blocking. This value is set to 40 by default. If the **tprof** command output indicates high CPU usage for the **check_lock** routine, and if locks are usually available within a short amount of time, you should increase the spin time by setting the value to 500 or higher.

Also, the following settings are recommended for your Java environment:

ulimit -d unlimited

ulimit -m unlimited

ulimit -n unlimited

ulimit -s unlimited

Certain environment parameters and settings can be used to tune Java performance within the operating system. In addition, many of the techniques for tuning system components, such as CPU, memory, network, I/O, and so on, can increase Java performance. To determine which environment parameters may be beneficial to your situation, refer to the specific topics for more information.

To obtain the best possible Java performance and scalability, use the latest available versions of the operating system and Java, as well as for your Just-In-Time (JIT) compiler.

Garbage collection impacts to Java performance

The most common performance problem associated with Java relates to the garbage collection mechanism. If the size of the Java heap is too large, the heap must reside outside main memory. This causes increased paging activity, which affects Java performance.

Also, a large heap can take several seconds to fill up. This means that even if garbage collection occurs less frequently, pause times associated with garbage collection increase.

To tune the Java Virtual Machine (JVM) heap, use the **java** command with the **-ms** or **-mx** option. Use the garbage collection statistics to help determine optimal settings.

Chapter 21. Analyzing Performance with the Trace Facility

The operating system's trace facility is a powerful system-observation tool. The trace facility captures a sequential flow of time-stamped system events, providing a fine level of detail on system activity. Events are shown in time sequence and in the context of other events. Trace is a valuable tool for observing system and application execution. Unlike other tools that only provide CPU utilization or I/O wait time, trace expands that information to aid in understanding what events are happening, who is responsible, when the events are taking place, how they are affecting the system and why.

The operating system is instrumented to provide general visibility to system execution. Users can extend visibility into their applications by inserting additional events and providing formatting rules.

Care was taken in the design and implementation of this facility to make the collection of trace data efficient, so that system performance and flow would be minimally altered by activating trace. Because of this, the trace facility is extremely useful as a performance-analysis tool and as a problem-determination tool.

The following sections provide more information on the trace facility:

- Understanding the Trace Facility
- Example of Trace Facility Use
- Starting and Controlling Trace from the Command Line
- Starting and Controlling Trace from a Program
- Using the `trcrpt` Command to Format a Report
- Adding New Trace Events

Understanding the Trace Facility

The trace facility is more flexible than traditional system-monitor services that access and present statistics maintained by the system. It does not presuppose what statistics will be needed, instead, trace supplies a stream of events and allows the user to decide what information to extract. With traditional monitor services, data reduction (conversion of system events to statistics) is largely coupled to the system instrumentation. For example, many systems maintain the minimum, maximum, and average elapsed time observed for executions of task A and permit this information to be extracted.

The trace facility does not strongly couple data reduction to instrumentation, but provides a stream of trace event records (usually abbreviated to *events*). It is not necessary to decide in advance what statistics will be needed; data reduction is to a large degree separated from the instrumentation. The user may choose to determine the minimum, maximum, and average time for task A from the flow of events. But it is also possible to:

- Extract the average time for task A when called by process B
- Extract the average time for task A when conditions XYZ are met
- Calculate the standard deviation of run time for task A
- Decide that some other task, recognized by a stream of events, is more meaningful to summarize.

This flexibility is invaluable for diagnosing performance or functional problems.

In addition to providing detailed information about system activity, the trace facility allows application programs to be instrumented and their trace events collected in addition to system events. The trace file then contains a complete record of the application and system activity, in the correct sequence and with precise time stamps.

Implementation

A *trace hook* is a specific event that is to be monitored. A unique number is assigned to that event called a *hook ID*. The **trace** command monitors these hooks.

The **trace** command generates statistics on user processes and kernel subsystems. The binary information is written to two alternate buffers in memory. The **trace** process then transfers the information to the trace log file on disk. This file grows very rapidly. The **trace** program runs as a process which may be monitored by the **ps** command. The **trace** command acts as a daemon, similar to accounting.

The following figure illustrates the implementation of the trace facility.

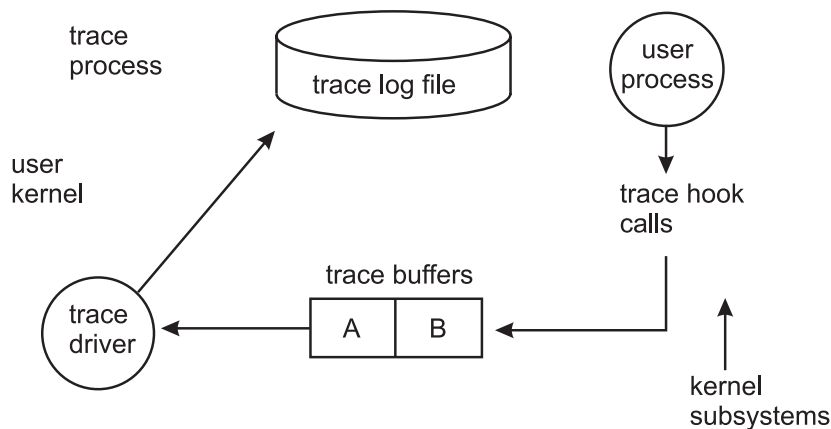

Figure 27. Implementation of the Trace Facility. This illustration shows the trace process. In this process, the user process (kernel subsystems) sends trace hook calls to trace buffers labeled A and B. From the buffers, they pass through the trace driver and on to the trace log file of the user kernel.

Monitoring facilities use system resources. Ideally, the overhead should be low enough as to not significantly affect system execution. When the **trace** program is active, the CPU overhead is less than 2 percent. When the trace data fills the buffers and must be written to the log, additional CPU is required for file I/O. Usually this is less than 5 percent. Because the **trace** program claims and pins buffer space, if the environment is memory-constrained, this might be significant. Be aware that the trace log and report files can become very large.

Limiting the Amount of Trace Data Collected

The trace facility generates large volumes of data. This data cannot be captured for extended periods of time without overflowing the storage device. There are two ways to use the trace facility efficiently:

- The trace facility can be turned on and off in multiple ways to capture system activity. It is practical to capture in this way seconds to minutes of system activity for post processing. This is enough time to characterize major application transactions or interesting sections of a long task.
- The trace facility can be configured to direct the event stream to standard output. This allows a real-time process to connect to the event stream and provide data reduction as the events are recorded, thereby creating long-term monitoring capability. A logical extension for specialized instrumentation is to direct the data stream to an auxiliary device that can either store massive amounts of data or provide dynamic data reduction. This technique is used by the performance tools **tprof**, **pprof**, **netpmn**, and **filemon**.

Starting and Controlling Trace

The trace facility provides three distinct modes of use:

Subcommand Mode

Trace is started with a shell command (**trace**) and carries on a dialog with the user through subcommands. The workload being traced must be provided by other processes, because the original shell process is in use.

Command Mode

Trace is started with a shell command (**trace -a**) that includes a flag which specifies that the trace facility is to run asynchronously. The original shell process is free to run ordinary commands, interspersed with trace-control commands.

Application-Controlled Mode

Trace is started with the **trcstart()** subroutine and controlled by subroutine calls such as **trcon()** and **trcoff()** from an application program.

Formatting Trace Data

A general-purpose trace-report facility is provided by the **trcrpt** command. The report facility provides little data reduction, but converts the raw binary event stream to a readable ASCII listing. Data can be visually extracted by a reader, or tools can be developed to further reduce the data.

The report facility displays text and data for each event according to rules provided in the trace format file. The default trace format file is **/etc/trcfmt**, which contains a stanza for each event ID. The stanza for the event provides the report facility with formatting rules for that event. This technique allows users to add their own events to programs and insert corresponding event stanzas in the format file to specify how the new events should be formatted.

Viewing Trace Data

When trace data is formatted, all data for a given event is usually placed on a single line. Additional lines may contain explanatory information. Depending on the fields included, the formatted lines can easily exceed 80 characters. It is best to view the reports on an output device that supports 132 columns.

Example of Trace Facility Use

The following takes you through an example of a typical trace.

Note: This example is more meaningful if the input file is not already cached in system memory. Choose as the source file any file that is about 50 KB in size and has not been used recently.

Obtaining a Sample Trace File

Trace data accumulates rapidly. Bracket the data collection as closely around the area of interest as possible. One technique for doing this is to issue several commands on the same command line. For example:

```
# trace -a -k "20e,20f" -o trc_raw ; cp ../bin/track /tmp/junk ; trcstop
```

captures the execution of the **cp** command. We have used two features of the **trace** command. The **-k "20e,20f"** option suppresses the collection of events from the **lockl()** and **unlockl()** functions. These calls are numerous on uniprocessor systems, but not on SMP systems, and add volume to the report without giving us additional information. The **-o trc_raw** option causes the raw trace output file to be written in our local directory.

Formatting the Sample Trace

We use the following form of the **trcrpt** command for our report:

```
# trcrpt -0 "exec=on,pid=on" trc_raw > cp.rpt
```

This reports both the fully qualified name of the file that is run and the process ID that is assigned to it.

The report file shows us that there are numerous VMM page assign and delete events in the trace, like the following sequence:

```
1B1 ksh          8526          0.003109888      0.162816
      VMM page delete:      V.S=0000.150E ppage=1F7F
      working_storage delete_in_progress process_private computational

1B0 ksh          8526          0.003141376      0.031488
      VMM page assign:      V.S=0000.2F33 ppage=1F7F
      working_storage delete_in_progress process_private computational
```

We are not interested in this level of VMM activity detail at the moment, so we reformat the trace as follows:

```
# trcrpt -k "1b0,1b1" -o "exec=on,pid=on" trc_raw > cp.rpt2
```

The **-k "1b0,1b1"** option suppresses the unwanted VMM events in the formatted output. It saves us from having to retrace the workload to suppress unwanted events. We could have used the **-k** function of the **trcrpt** command instead of that of the **trace** command to suppress the **lockl()** and **unlockl()** events, if we had believed that we might need to look at the lock activity at some point. If we had been interested in only a small set of events, we could have specified **-d "hookid1,hookid2"** to produce a report with only those events. Because the hook ID is the leftmost column of the report, you can quickly compile a list of hooks to include or exclude. A comprehensive list of trace hook IDs is defined in the **/usr/include/sys/trchkid.h** file.

Reading a Trace Report

The header of the trace report tells you when and where the trace was taken, as well as the command that was used to produce it:

```
Thu Oct 28 13:34:05 1999
System: AIX texmex Node: 4
Machine: 000691854C00
Internet Protocol Address: 09359BBB 9.53.155.187
Buffering: Kernel Heap
```

```
trace -a -k 20e,20f -o trc_raw
```

The body of the report, if displayed in a small enough font, looks similar to the following:

| ID | PROCESS NAME | PID | ELAPSED_SEC | DELTA_MSEC | APPL | SYSCALL | KERNEL | INTERRUPT |
|-----|--------------|------|-------------|------------|------|---------|--|-----------|
| 101 | ksh | 8526 | 0.005833472 | 0.107008 | | kfork | LR = D0040AF8 | |
| 101 | ksh | 7214 | 0.012820224 | 0.031744 | | execve | LR = 10015390 | |
| 134 | cp | 7214 | 0.014451456 | 0.030464 | | exec: | cmd=cp ../bin/track /tmp/junk pid=7214 tid=24713 | |

In **cp.rpt2** you can see the following information:

- The **fork()**, **exec()**, and page fault activities of the **cp** process.
- The opening of the input file for reading and the creation of the **/tmp/junk** file
- The successive **read()/write()** system calls to accomplish the copy.
- The process **cp** becoming blocked while waiting for I/O completion, and the **wait** process being dispatched.
- How logical-volume requests are translated to physical-volume requests.
- The files are mapped rather than buffered in traditional kernel buffers, and the read accesses cause page faults that must be resolved by the Virtual Memory Manager.
- The Virtual Memory Manager senses sequential access and begins to prefetch the file pages.
- The size of the prefetch becomes larger as sequential access continues.
- When possible, the disk device driver coalesces multiple file requests into one I/O request to the drive.

The trace output looks a little overwhelming at first. This is a good example to use as a learning aid. If you can discern the activities described, you are well on your way to being able to use the trace facility to diagnose system-performance problems.

Filtering of the Trace Report

The full detail of the trace data may not be required. You can choose specific events of interest to be shown. For example, it is sometimes useful to find the number of times a certain event occurred. To answer the question "How many opens occurred in the copy example?" first find the event ID for the **open()** system call. This can be done as follows:

```
# trcrpt -j | grep -i open
```

You should be able to see that event ID 15b is the OPEN SYSTEM CALL event. Now, process the data from the copy example as follows:

```
# trcrpt -d 15b -0 "exec=on" trc_raw
```

The report is written to standard output, and you can determine the number of **open()** subroutines that occurred. If you want to see only the **open()** subroutines that were performed by the **cp** process, run the report command again using the following:

```
# trcrpt -d 15b -p cp -0 "exec=on" trc_raw
```

Starting and Controlling Trace from the Command Line

The trace facility is configured and data collection optionally started by the **trace** command, the detailed syntax of which is described in the *AIX 5L Version 5.3 Commands Reference*.

After trace is configured by the **trace** command, there are controls to turn data collection on and off and to stop the trace facility (the **trcstop** subcommand deconfigures **trace** and unpins buffers). You can invoke the controls through: subcommands, commands, and subroutines. The subroutine interfaces are described in Starting and Controlling Trace from a Program.

Controlling Trace in Subcommand Mode

If the **trace** routine is configured without the **-a** option, it runs in subcommand mode. Instead of the normal shell prompt, a prompt of **"->"** displays. In this mode, the following subcommands are recognized:

trcon Starts or resumes collection of event data

trcoff Suspends collection of event data

q or quit

Stops collection of event data and terminates the **trace** routine

!command

Runs the specified shell command

?

Displays the available commands

For example:

```
# trace -f -m "Trace of events during mycmd"
-> !mycmd
-> q
#
```

Controlling Trace by Commands

If the **trace** routine is configured to run asynchronously (**trace -a**), trace can be controlled by the following commands:

trcon Starts or resumes collection of event data

trcoff Suspends collection of event data

trcstop

Stops collection of event data and terminates the **trace** routine

For example:

```
# trace -a -n -L 2000000 -T 1000000 -d -o trace.out
# trcon
# cp /a20kfile /b
# trcstop
```

By specifying the **-d** (defer tracing until the **trcon** subcommand is entered) option, you can limit how much tracing is done on the **trace** command itself. If the **-d** option is not specified, then tracing begins immediately and can log events for the **trace** command initializing its own memory buffers. Typically, we want to trace everything but the **trace** command itself.

By default, the kernel buffer size (**-T** option) can be at most one half of the log buffer size (**-L** option). If you use the **-f** flag, the buffer sizes can be the same.

The **-n** option is useful if there are kernel extension system calls that need to be traced.

Starting and Controlling Trace from a Program

The trace facility can be started from a program, through a subroutine call. The subroutine is **trcstart()** and is in the **librts.a** library. The syntax of the **trcstart()** subroutine is as follows:

```
int trcstart(char *args)
```

where *args* is the options list that you would have entered for the **trace** command. By default, the system trace (channel 0) is started. If you want to start a generic trace, include a **-g** option in the *args* string. On successful completion, the **trcstart()** subroutine returns the channel ID. For generic tracing, this channel ID can be used to record to the private generic channel.

When compiling a program using this subroutine, the link to the **librts.a** library must be specifically requested (use **-l rts** as a compile option).

Controlling Trace with Trace Subroutine Calls

The controls for the **trace** routine are available as subroutines from the **librts.a** library. The subroutines return zero on successful completion. The subroutines are:

int trcon()

Begins or resumes collection of trace data.

int trcoff()

Suspends collection of trace data.

int trcstop()

Stops collection of trace data and terminates the **trace** routine.

Using the **trcrpt** Command to Format a Report

The trace report facility reads the trace log file, formats the trace entries, and writes a report. The **trcrpt** command displays text and data for each event according to rules provided in the trace format file (**/etc/trcfmt**). Stanzas in the format file provide formatting rules for events or hooks. Users adding hooks to programs can insert corresponding event stanzas in the format file to print their trace data (see Adding New Trace Events).

The **trcrpt** facility does not produce any summary reports, but you can use the **awk** command to create simple summaries through further processing of the **trcrpt** output.

The detailed syntax of the **trcrpt** command is described in the *AIX 5L Version 5.3 Commands Reference*.

Formatting a Report on the Same System

The **trcrpt** command formats reports of trace event data contained in the trace log file. You can specify the events to be included (or omitted) in the report, as well as determine the presentation of the output with this command.

You can use the System Management Interface Tool (SMIT) to run the **trcrpt** command by typing the SMIT fast path:

```
# smitty trcrpt
```

To create a trace report to the newfile file, type:

```
# trcrpt -o newfile
```

Formatting a Report on a Different System

It is often desirable to run the **trcrpt** command on another system than the system where the trace is collected. There may be various reasons for this, such as:

- The system being traced might not be available for you to run the **trcrpt** command, and the trace might be collected by the system administrator or someone at the remote site.
- The system being traced is too busy for you to run the **trcrpt** command.
- The system being traced does not have enough file system space left to accommodate a very large **trcrpt** file.

You can run the **trace** command on a system and run the **trcrpt** command on that trace file on a different system. In order for this to work correctly, the output of the **trcnm** command is needed from the system where the trace was run. Run the **trcnm** command and redirect the output into a file, as follows:

```
# trcnm > trace.nm
```

If you want to use the trace file for other performance tools such as **tprof**, **pprof**, **netpmn**, and **filemon**, run the **gennames** *Gennames_File* command.

That file is then used with the **-n** flag of the **trcrpt** command, as follows:

```
# trcrpt -n trace.nm -o newfile
```

If **-n** is not specified, then the **trcrpt** command generates a symbol table from the system on which the **trcrpt** command is run.

Additionally, a copy of the **/etc/trcfmt** file from the system being traced might be beneficial because that system may have different or more trace format stanzas than the system where the **trcrpt** command is being run. The **trcrpt** command can use the **-t** flag to specify the trace format file (by default it uses the **/etc/trcfmt** file from the system where the **trcrpt** command is being run). For example:

```
# trcrpt -n trace.nm -t trcfmt_file -o newfile
```

Formatting a Report from trace -C Output

If trace was run with the **-C** flag, one or more trace output files are generated. For example, if the trace file name was specified as **trace.out** and **-C all** was specified on a 4-way SMP, then a **trace.out**, **trace.out-1**, **trace.out-2**, **trace.out-3**, and **trace.out-4** file was generated. When you run the **trcrpt** command, specify **trcrpt -C all** and **trace.out** as the file name, and all the files will be read, as follows:

```
# trcrpt -C all -r trace.out > trace.tr
```

This **trace.tr** file can then be used as input for other commands (it will include the trace data from each CPU). The reason for the **-C** flag on trace is so that the trace can keep up with each CPU's activities on those systems which have many CPUs (more than 12, for example). Another reason is that the buffer size for the trace buffers is per CPU when you use the **-C all** flag.

Adding New Trace Events

The operating system is shipped instrumented with key events. The user need only activate trace to capture the flow of events from the operating system. Application developers may want to instrument their application code during development for tuning purposes. This provides them with insight into how their applications are interacting with the system.

To add a trace event, you must design the trace records generated by your program in accordance with trace interface conventions. You then add trace-hook macros to the program at the appropriate locations. Traces can then be taken through any of the standard ways of invoking and controlling trace (commands, subcommands, or subroutine calls). To use the **trcrpt** program to format your traces, add stanzas describing each new trace record and its formatting requirements to the trace format file.

Possible Forms of a Trace Event Record

A trace event can take several forms. An event consists of a hook word, optional data words, and an optional time stamp, as shown in the following figure. A four-bit type is defined for each form that the event record can take. The type field is imposed by the recording routine so that the report facility can always skip from event to event when processing the data, even if the formatting rules in the trace format file are incorrect or missing for that event.

| 12-bit Hook ID | 4-bit Type | 16-bit Data Field | Hook Word (required) |
|----------------|------------|-------------------|----------------------|
| | | Data Word 1 | D1 (optional) |
| | | Data Word 2 | D2 (optional) |
| | | Data Word 3 | D3 (optional) |
| | | Data Word 4 | D4 (optional) |
| | | Data Word 5 | D5 (optional) |
| | | 32-bit Time Stamp | T (optional) |

Figure 28. Format of a Trace Event Record. This illustration is a table containing 7 rows. Cells in the first row are labeled 12-bit hook ID, 4-bit Type and 16-bit Data Field. The next 6 rows are simply labeled Data Word 1 through Data Word 5, and the last row is labeled 32-bit Time Stamp. A row heading for row 1 is Hook Word (required). The next 5 rows are labeled D1 (optional), D2 (optional), D3 (optional), D4 (optional), and (optional). The last row is labeled T (optional).

An event record should be as short as possible. Many system events use only the hook word and time stamp. The data words should seldom be used because using them is less efficient and is intrusive. A long format allows the user to record a variable length of data. In this long form, the 16-bit data field of the hook word is converted to a length field that describes the length of the event record.

Trace Channels

The trace facility can accommodate up to eight simultaneous channels of trace-hook activity, which are numbered 0-7. Channel 0 is always used for system events, but application events can also use it. The other seven channels, called generic channels, can be used for tracing application-program activity.

When trace is started, channel 0 is used by default. A **trace -n channel_number** command starts trace to a generic channel. Use of the generic channels has some limitations:

- The interface to the generic channels costs more CPU time than the interface to channel 0 because of the need to distinguish between channels and because generic channels record variable-length records.
- Events recorded on channel 0 and on the generic channels can be correlated only by time stamp, not by sequence, so there may be situations in which it is not possible to determine which event occurred first.

Macros for Recording Trace Events

Macros to record each possible type of event record are defined in the `/usr/include/sys/trcmacros.h` file. The event IDs are defined in the `/usr/include/sys/trchkid.h` file. Include these two files in any program that is recording trace events.

The macros to record events on channel 0 with a time stamp are as follows:

```
TRCHKL0T(hw)
TRCHKL1T(hw,D1)
TRCHKL2T(hw,D1,D2)
TRCHKL3T(hw,D1,D2,D3)
TRCHKL4T(hw,D1,D2,D3,D4)
TRCHKL5T(hw,D1,D2,D3,D4,D5)
```

Similarly, to record events on channel 0 without a time stamp, use:

```
TRCHKL0(hw)
TRCHKL1(hw,D1)
TRCHKL2(hw,D1,D2)
TRCHKL3(hw,D1,D2,D3)
TRCHKL4(hw,D1,D2,D3,D4)
TRCHKL5(hw,D1,D2,D3,D4,D5)
```

The type field of the trace event record is set to the value that corresponds to the macro used, regardless of the value of those 4 bits in the `hw` parameter.

Only two macros record events to one of the generic channels (1-7). These are as follows:

```
TRCGEN(ch,hw,D1,len,buf)
TRCGENT(ch,hw,D1,len,buf)
```

These macros record in the event stream specified by the channel parameter (`ch`) a hook word (`hw`), a data word (`D1`) and `len` bytes from the user's data segment beginning at the location specified by `buf`.

Use of Event IDs

The event ID in a trace record identifies that record as belonging to a particular class of records. The event ID is the basis on which the trace mechanism records or ignores trace hooks, as well as the basis on which the `trcrpt` command includes or excludes trace records in the formatted report.

Event IDs are 12 bits (three hexadecimal digits) for a possible 4096 IDs. Event IDs that are reserved and shipped with code are permanently assigned to avoid duplication. To allow users to define events in their environments or during development, the range of event IDs from hex 010 through hex 0FF has been reserved for temporary use. Users can freely use IDs in this range in their own environment (that is, any set of systems within which the users are prepared to ensure that the same event ID is not used ambiguously).

Note: It is important that users who make use of this event range do not let the code leave their environment. If you ship code instrumented with temporary hook IDs to an environment in which you do not control the use of IDs, you risk collision with other programs that already use the same IDs in that environment.

Event IDs should be conserved because there are so few of them, but they can be extended by using the 16-bit Data Field. This yields a possible 65536 distinguishable events for every formal hook ID. The only reason to have a unique ID is that an ID is the level at which collection and report filtering are available in the trace facility.

A user-added event can be formatted by the **trcrpt** command if there is a stanza for the event in the specified trace format file. The trace format file is an editable ASCII file (see Syntax for Stanzas in the Trace Format File).

Examples of Coding and Formatting Events

The following example shows the use of trace events to time the execution of a program loop:

```
#include <sys/trcctl.h>
#include <sys/trcmacros.h>
#include <sys/trchkid.h>
char *ctl_file = "/dev/systrctl";
int ctldfd;
int i;
main()
{
    printf("configuring trace collection \n");
    if (trcstart("-ad")){
        perror("trcstart");
        exit(1);
    }

    printf("opening the trace device \n");
    if((ctldfd = open(ctl_file,0))<0){
        perror(ctl_file);
        exit(1);
    }

    printf("turning trace on \n");
    if(ioctl(ctldfd,TRCON,0)){
        perror("TRCON");
        exit(1);
    }

    for(i=1;i<11;i++){
        TRCHKLIT(HKWD_USER1,i);

        /* The code being measured goes here. The interval */
        /* between occurrences of HKWD_USER1 in the trace */
        /* file is the total time for one iteration.      */
    }

    printf("turning trace off\n");
    if(ioctl(ctldfd,TRCSTOP,0)){
        perror("TRCOFF");
        exit(1);
    }

    printf("stopping the trace daemon \n");
    if (trcstop(0)){
        perror("trcstop");
        exit(1);
    }

    exit(0);
}
```

When you compile the sample program, you must link to the **librts.a** library as follows:

```
# xlc -O3 sample.c -o sample -l rts
```

HKWD_USER1 is event ID 010 hexadecimal (you can verify this by examining the `/usr/include/sys/trchkid.h` file). The report facility does not format the HKWD_USER1 event, unless rules are provided in the trace format file. The following example of a stanza for HKWD_USER1 could be used:

```
# User event HKWD_USER1 Formatting Rules Stanza
# An example that will format the event usage of the sample program
010 1.0 L=APPL "USER EVENT - HKWD_USER1" 02.0      \n \
              "The # of loop iterations =" U4      \n \
              "The elapsed time of the last loop = " \
              endtimer(0x010,0x010) starttimer(0x010,0x010)
```

When you enter the example stanza, do not modify the master format file `/etc/trcfmt`, but instead make a copy and keep it in your own directory (assume you name it `mytrcfmt`). When you run the sample program, the raw event data is captured in the default log file because no other log file was specified to the `trcstart()` subroutine. You can filter the output report to get only your events. To do this, run the `trcrpt` command as follows:

```
# trcrpt -d 010 -t mytrcfmt -O "exec=on" > sample.rpt
```

You can browse the `sample.rpt` file to see the result.

Syntax for Stanzas in the Trace Format File

The trace format file provides rules for presentation and display of the expected data for each event ID. This allows new events to be formatted without changing the report facility. Rules for new events are simply added to the format file. The syntax of the rules provides flexibility in the presentation of the data.

A trace format stanza can be as long as required to describe the rules for any particular event. The stanza can be continued to the next line by terminating the present line with a `\` character. The fields are described in the *AIX 5L Version 5.3 Files Reference*.

Comments in the `/etc/trcfmt` file describe other format and macro possibilities and describe how a user can define additional macros.

Chapter 22. Reporting Performance Problems

If you believe that you have found a possible performance problem in the operating system, you can use tools and procedures for reporting the problem and supplying problem-analysis data. These tools are intended to ensure that you get a prompt and accurate response, with a minimum of effort and time on your part.

The main sections in this topic are:

- Measuring the Baseline
- What is a Performance Problem
- Performance Problem Description
- Reporting a Performance Problem

Measuring the Baseline

Performance problems are often reported immediately following some change to system hardware or software. Unless there is a pre-change baseline measurement with which to compare post-change performance, quantification of the problem is impossible.

Changes to any of the following can affect performance:

- Hardware configuration - Adding, removing, or changing configurations such as how the disks are connected
- Operating system - Installing or updating a fileset, installing PTFs, and changing parameters
- Applications - Installing new versions and fixes
- Applications - Configuring or changing data placement
- Application tuning
- Tuning options in the operating system, RDBMS or an application
- Any changes

The best option is to measure the environment before and after each change. The alternative is running the measurements at regular intervals (for example, once a month) and save the output. When a problem is found, the previous capture can be used for comparison. It is worth collecting a series of outputs in order to support the diagnosis of a possible performance problem.

To maximize performance diagnosis, collect data for various periods of the working day, week, or month when performance is likely to be an issue. For example, you might have workload peaks as follows:

- In the middle of the mornings for online users
- During a late-night batch run
- During the end-of-month processing
- During major data loads

Use measurements to collect data for each of these peaks in workload, because a performance problem might only cause problems during one of these periods and not during other times.

Note: Any measurement has an impact on the performance of the system being measured.

The AIX Performance PMR (perfpmr) data collection tools are the preferred method for gathering baseline data. Access these tools via the web at <ftp://ftp.software.ibm.com/aix/tools/perftools/perfpmr>. Follow the instructions in the README file in the directory that matches the AIX version you will be measuring to obtain, install, and collect data on your system.

What is a Performance Problem

Support personnel need to determine when a reported problem is a functional problem or a performance problem. When an application, a hardware system, or a network is not behaving correctly, this is referred to as a *functional problem*. For example, an application or a system with a memory leak has a functional problem.

Sometimes functional problems lead to performance problems; for example, when the functions are being achieved, but the speed of the functions are slow. In these cases, rather than tune the system, it is more important to determine the root cause of the problem and fix it. Another example would be when communication is slowed because of networks or name servers that are down.

Performance Problem Description

Support personnel often receive problem reports stating that someone has a performance problem on the system and providing some data analysis. This information is insufficient to accurately determine the nature of a performance problem. The data might indicate 100 percent CPU utilization and a high run queue, but that may have nothing to do with the cause of the performance problem.

For example, a system might have users logged in from remote terminals over a network that goes over several routers. The users report that the system is slow. Data might indicate that the CPU is very heavily utilized. But the real problem could be that the characters get displayed after long delays on their terminals due to packets getting lost on the network (which could be caused by failing routers or overloaded networks). This situation might have nothing to do with the CPU utilization on the machine. If on the other hand, the complaint was that a batch job on the system was taking a long time to run, then CPU utilization or I/O bandwidth might be related.

Always obtain as much detail as possible before you attempt to collect or analyze data, by asking the following questions regarding the performance problem:

- Can the problem be demonstrated by running a specific command or reconstructing a sequence of events? (for example: **ls /slow/fs** or **ping xxxxx**). If not, describe the least complex example of the problem.
- Is the slow performance intermittent? Does it get slow, but then disappear for a while? Does it occur at certain times of the day or in relation to some specific activity?
- Is everything slow or only some things?
- What aspect is slow? For example, time to echo a character, or elapsed time to complete a transaction, or time to paint the screen?
- When did the problem start occurring? Was the situation the same ever since the system was first installed or went into production? Did anything change on the system before the problem occurred (such as adding more users or migrating additional data to the system)?
- If client/server, can the problem be demonstrated when run just locally on the server (network versus server issue)?
- If network related, how are the network segments configured (including bandwidth such as 10 Mb/sec or 9600 baud)? Are there any routers between the client and server?
- What vendor applications are running on the system, and are those applications involved in the performance issue?
- What is the impact of the performance problem on the users?

Reporting a Performance Problem

You should report operating system performance problems to IBM support. Use your normal software problem-reporting channel. If you are not familiar with the correct problem-reporting channel for your organization, check with your IBM representative.

The AIX Performance PMR (perfpmr) data collection tools are the best way to collect performance data when an AIX performance problem is suspected. Access these tools via the web at <ftp://ftp.software.ibm.com/aix/tools/perftools/perfpmr> Follow the instructions in the README file in the directory that matches the AIX version you will be measuring to obtain, install, and collect data on your system. Instructions are also provided on how to send the data to IBM support for analysis once a PMR has been opened.

When someone reports a performance problem, it is not enough just to gather data and then analyze it. Without knowing the nature of the performance problem, you might waste a lot of time analyzing data which may have nothing to do with the problem being reported.

Before you involve support personnel to report a problem, prepare in advance the information that you will be asked to supply to facilitate the problem to be investigated. Your local support personnel will attempt to quickly solve your performance problem directly with you.

Three further ways you can help to get the problem resolved faster are:

1. Provide a clear written statement of a simple specific instance of problem, but be sure to separate the symptoms and facts from the theories, ideas and your own conclusions. PMRs that report "the system is slow" require extensive investigation to determine what you mean by slow, how it is measured, and what is acceptable performance.
2. Provide information about everything that has changed on the system in the weeks before the problem. Missing something that changed can block a possible investigation path and will only delay finding a resolution. If all the facts are available, the performance team can quickly eliminate the unrelated ones.
3. Use the correct machine to supply information. In very large sites it is easy to accidentally collect the data on the wrong machine. This makes it very hard to investigate the problem.

When you report the problem, supply the following basic information:

- A problem description that can be used to search the problem-history database to see if a similar problem has already been reported.
- What aspect of your analysis led you to conclude that the problem is due to a defect in the operating system?
- What is the hardware and software configuration in which the problem is occurring?
 - Is the problem confined to a single system, or does it affect multiple systems?
 - What are the models, memory sizes, as well as number and size of disks on the affected systems?
 - What kinds of LAN and other communications media are connected to the systems?
 - Does the overall configuration include those for other operating systems?
- What are the characteristics of the program or workload that is experiencing the problem?
 - Does an analysis with the **time**, **iostat**, and **vmstat** commands indicate that it is CPU-limited or I/O-limited?
 - Are the workloads being run on the affected systems: workstation, server, multiuser, or a combination?
- What are the performance objectives that are not being met?
 - Is the primary objective in terms of console or terminal response time, throughput, or real-time responsiveness?
 - Were the objectives derived from measurements on another system? If so, what was its configuration?

If this is the first report of the problem, you will receive a PMR number for use in identifying any additional data you supply and for future reference.

Include all of the following items when the supporting information and the **perfpmr** data for the PMR is first gathered:

- A means of reproducing the problem
 - If possible, a program or shell script that demonstrates the problem should be included.
 - At a minimum, a detailed description of the conditions under which the problem occurs is needed.
- The application experiencing the problem:
 - If the application is, or depends on, any software product, the exact version and release of that product should be identified.
 - If the source code of a user-written application cannot be released, the exact set of compiler parameters used to create the executable program should be documented.

Appendix A. Monitoring and Tuning Commands and Subroutines

Performance tools for the system environment fall into two general categories: those that tell you what is occurring and those that let you do something about it. A few tools do both. This appendix lists these performance-related commands and subroutines. For details of the syntax and functions of the commands, see the *AIX 5L Version 5.3 Commands Reference*.

The performance-related commands are packaged as part of the **perfagent.tools**, **bos.acct**, **bos.sysmgmt.trace**, **bos.adt.samples**, **bos.perf.tools**, and **bos.perf.tune** filesets that are shipped with the Base Operating System.

You can determine whether all the performance tools have been installed by running one of the following commands:

For AIX 5.2:

```
# ls1pp -lI perfagent.tools bos.sysmgmt.trace bos.acct bos.perf.tools bos.perf.tune
```

For AIX 5.1:

```
# ls1pp -lI perfagent.tools bos.sysmgmt.trace bos.acct bos.perf.tools bos.adt.samples
```

For AIX 4.3 and earlier:

```
# ls1pp -lI perfagent.tools bos.sysmgmt.trace bos.acct bos.adt.samples
```

This appendix contains the following major sections:

- Performance Reporting and Analysis Commands
- Performance Tuning Commands
- Performance-Related Subroutines

Performance Reporting and Analysis Commands

Performance reporting and analysis commands give you information on the performance of one or more aspects of the system, or on one or more of the parameters that affect performance. The commands are as follows:

Command

Function

alstat Reports alignment exceptions counts

atmstat

Shows Asynchronous Transfer Mode (ATM) adapter statistics

curt Reports CPU utilization for each kernel thread (beginning with AIX 5.2)

emstat

Reports emulation instruction counts

entstat

Shows ethernet device driver and device statistics

fddistat

Shows FDDI device driver and device statistics

filemon

Uses the trace facility to report on the I/O activity of physical volumes, logical volumes, individual files, and the Virtual Memory Manager

fileplace

Displays the physical or logical placement of the blocks that constitute a file within the physical or logical volume on which they reside

gprof Reports the flow of control among the subroutines of a program and the amount of CPU time consumed by each subroutine

ifconfig

Configures or displays network interface parameters for a network using TCP/IP

ioo Sets I/O related tuning parameters (along with **vmo**, replaces **vmtune** beginning with AIX 5.2)

iostat Displays utilization data for:

- Terminals
- CPU
- Disks
- Adapters (beginning with AIX 5.1)

ipfilter

Extracts different operation headers from an **ipreport** output file and displays them in a table

ipreport

Generates a packet trace report from the specified packet trace file

iptrace

Provides interface-level packet tracing for Internet protocols

locktrace

Turns on lock tracing (beginning with AIX 5.1)

lsattr Displays attributes of the system that affect performance, such as:

- Processor speed (beginning with AIX 5.1)
- Size of the caches
- Size of real memory
- Maximum number of pages in the block I/O buffer cache
- Maximum number of kilobytes of memory allowed for mbufs
- High- and low-water marks for disk-I/O pacing

lsdev Displays devices in the system and their characteristics

lslv Displays information about a logical volume

lspas Displays the characteristics of paging spaces

lspv Displays information about a physical volume within a volume group

lsvg Displays information about volume groups

mtrace

Prints a multicast path from a source to a receiver

netpmon

Uses the trace facility to report on network activity, including:

- CPU consumption
- Data rates
- Response time

netstat

Displays a wide variety of configuration information and statistics on communications activity, such as:

- Current status of the mbuf pool

- Routing tables
- Cumulative statistics on network activity

nfs Displays (or changes) the values of NFS options

nfsstat

Displays statistics on Network File System (NFS) and Remote Procedure Call (RPC) server and client activity

no Displays (or changes) the values of network options, such as:

- Default send and receive socket buffer sizes
- Maximum total amount of memory used in mbuf and cluster pools

pdt_config

Starts, stops, or changes the parameters of the Performance Diagnostic Tool

pdt_report

Generates a PDT report based on the current historical data

pprof Reports CPU usage of all kernel threads over a period of time

prof Displays object file profile data

ps Displays statistics and status information about the processes in the system, such as:

- Process ID
- I/O activity
- CPU utilization

sar Displays statistics on operating-system activity, such as:

- Directory accesses
- Read and write system calls
- Forks and execs
- Paging activity

schedo

Sets tuning parameters for CPU scheduler (replaces **schedtune** starting with AIX 5.2)

smitty Displays (or changes) system-management parameters

splat Lock contention analysis tool (beginning with AIX 5.2)

svmon

Reports on the status of memory at system, process, and segment levels

tcpdump

Prints out packet headers

time, timex

Prints the elapsed and CPU time used by the execution of a command

topas Reports selected local system statistics

tokstat

Shows Token-Ring device driver and device statistics

tprof Uses the trace facility to report the CPU consumption of kernel services, library subroutines, application-program modules, and individual lines of source code in the application program

trace, trcrpt

Writes a file that records the exact sequence of activities within the system

traceroute

Prints the route that IP packets take to a network host

vmo Sets VMM related tuning parameters (along with **ioo**, replaces **vmtune** beginning with AIX 5.2)

vmstat

Displays VMM data, such as:

- Number of processes that are dispatchable or waiting
- Page-frame free-list size
- Page-fault activity
- CPU utilization

Performance Tuning Commands

The following tools allow you to change one or more performance-related aspects of the system.

Command

Function

bindprocessor

Binds or unbinds the kernel threads of a process to a processor

chdev Changes the characteristics of a device

chlv Changes only the characteristics of a logical volume

chps Changes attributes of a paging space

fdpr A performance tuning utility for improving execution time and real memory utilization of user-level application programs

ifconfig

Configures or displays network interface parameters for a network using TCP/IP

ioo Sets I/O related tuning parameters (along with **vmo**, replaces **vmtune** starting with AIX 5.2)

migratepv

Moves allocated physical partitions from one physical volume to one or more other physical volumes

mkps Adds an additional paging space to the system

nfso Configures Network File System (NFS) network variables

nice Runs a command at a lower or higher priority

no Configures network attributes

renice Alters the nice value of running processes

reorgvg

Reorganizes the physical partition allocation for a volume group

rmss Simulates a system with various sizes of memory for performance testing of applications

schedo

Sets tuning parameters for CPU scheduler (replaces **schedtune** starting with AIX 5.2)

smitty Changes (or displays) system-management parameters

tuncheck

Validates a stanza file with tuning parameter values (beginning with AIX 5.2)

tundefault

Resets all tuning parameters to their default values (beginning with AIX 5.2)

tunrestore

Restores all tuning parameter values from a stanza file (beginning with AIX 5.2)

tunsave

Saves all tuning parameter values in a stanza file (beginning with AIX 5.2)

vmo

Sets VMM related tuning parameters (along with **ioo**, replaces **vmtune** starting with AIX 5.2)

Performance-Related Subroutines

The following subroutines can be used in monitoring and tuning performance:

bindprocessor()

Binds kernel threads to a processor

getpri()

Determines the scheduling priority of a running process

getpriority()

Determines the nice value of a running process

getrusage()

Retrieves information about the use of system resources

nice() Increments the nice value of the current process

psdanger()

Retrieves information about paging space use

setpri()

Changes the priority of a running process to a fixed priority

setpriority()

Sets the nice value of a running process

Appendix B. Efficient Use of the `ld` Command

The binder (invoked as the final stage of a compile or directly by the `ld` command) has functions that are not found in the typical UNIX linker. This situation can result in longer linking times if the additional power of the operating system binder is not exploited. This appendix describes some techniques for more efficient use of the binder.

Rebindable Executable Programs

The formal documentation of the binder refers to the ability of the binder to take an executable program (a load module) as input. Exploitation of this function can significantly improve the overall performance of the system with software-development workloads, as well as the response time of individual `ld` commands.

In most typical UNIX systems, the `ld` command always takes as input a set of files containing object code, either from individual `.o` files or from archived libraries of `.o` files. The `ld` command then resolves the external references among these files and writes an executable program with the default name of `a.out`. The `a.out` file can only be executed. If a bug is found in one of the modules that was included in the `a.out` file, the defective source code is changed and recompiled, and then the entire `ld` process must be repeated, starting from the full set of `.o` files.

In this operating system, however, the binder can accept both `.o` and `a.out` files as input, because the binder includes resolved External Symbol Dictionary (ESD) and Relocation Dictionary (RLD) information in the executable file. This means that the user has the ability to rebind an existing executable program to replace a single modified `.o` file, rather than build a new executable program from the beginning. Because the binding process consumes storage and processor cycles partly in proportion to the number of different files being accessed and the number of different references to symbols that have to be resolved, rebinding an executable program with a new version of one module is much quicker than binding it from scratch.

Prebound Subroutine Libraries

Equally important in some environments is the ability to bind an entire subroutine library in advance of its use. The system subroutine libraries such as `libc.a` are, in effect, shipped in binder-output format, rather than as an archive file of `.o` files. This saves the user considerable processing time when binding an application with the required system libraries, because only the references from the application to the library subroutines have to be resolved. References among the system library routines themselves have already been resolved during the system-build process.

Many third-party subroutine libraries, however, are routinely shipped in archive form as raw `.o` files. When users bind applications with such libraries, the binder must resolve symbols for the entire library each time the application is bound. This results in long bind times in environments where applications are being bound with large libraries on small machines.

The performance difference between bound and unbound libraries can be significant, especially in minimum configurations.

Examples

Following is an example that illustrates efficient use of the `ld` command:

1. To prebind a library, use the following command on the archive file:

```
# ld -r libfoo.a -o libfoo.o
```

2. The compile and bind of the FORTRAN program `something.f` is as follows:

```
# xlf something.f libfoo.o
```

Notice that the prebound library is treated as another ordinary input file, not with the usual library identification syntax (**-lfoo**).

3. To recompile the module and rebind the executable program after fixing a bug, use the following:

```
# xlf something.f a.out
```

4. However, if the bug fix had resulted in a call to a different subroutine in the library, the bind would fail. The following Korn shell script tests for a failure return code and recovers:

```
# !/usr/bin/ksh
# Shell script for source file replacement bind
#
xlf something.f a.out
rc=$?
if [ "$rc" != 0 ]
then
echo "New function added ... using libfooa.o"
xlf something.o libfooa.o
fi
```

Appendix C. Accessing the Processor Timer

Attempts to measure very small time intervals are often frustrated by the intermittent background activity that is part of the operating system and by the processing time consumed by the system time routines. One approach to solving this problem is to access the processor timer directly to determine the beginning and ending times of measurement intervals, run the measurements repeatedly, and then filter the results to remove periods when an interrupt intervened.

The POWER and POWER2 architectures, which are supported through AIX 5.1 only, implement the processor timer as a pair of special-purpose registers. The POWER-based architecture defines a 64-bit register called the *TimeBase*. Only assembler-language programs can access these registers.

Note: The time measured by the processor timer is the absolute wall-clock time. If an interrupt occurs between accesses to the timer, the calculated duration will include the processing of the interrupt and possibly other processes being dispatched before control is returned to the code being timed. The time from the processor timer is the raw time and should never be used in situations in which it will not be subjected to a reasonableness test.

A pair of library subroutines make access to the TimeBase registers architecture-independent. The subroutines are as follows:

read_real_time()

This subroutine obtains the current time from the appropriate source and stores it as two 32-bit values.

time_base_to_time()

This subroutine ensures that the time values are in seconds and nanoseconds, performing any necessary conversion from the TimeBase format.

The time-acquisition and time-conversion functions are separated in order to minimize the overhead of time acquisition.

The following example shows how these subroutines could be used to measure the elapsed time for a specific piece of code:

```
#include <stdio.h>
#include <sys/time.h>

int main(void) {
    timebasestruct_t start, finish;
    int val = 3;
    int w1, w2;
    double time;

    /* get the time before the operation begins */
    read_real_time(&start, TIMEBASE_SZ);

    /* begin code to be timed */
    printf("This is a sample line %d \n", val);
    /* end code to be timed */

    /* get the time after the operation is complete */
    read_real_time(&finish, TIMEBASE_SZ);

    /* call the conversion routines unconditionally, to ensure
     * that both values are in seconds and nanoseconds regardless
     * of the hardware platform. */
    time_base_to_time(&start, TIMEBASE_SZ);
    time_base_to_time(&finish, TIMEBASE_SZ);

    /* subtract the starting time from the ending time */
```

```

w1 = finish.tb_high - start.tb_high; /* probably zero */
w2 = finish.tb_low - start.tb_low;

/* if there was a carry from low-order to high-order during */
/* the measurement, we may have to undo it. */
if (w2 < 0) {
    w1--;
    w2 += 1000000000;
}

/* convert the net elapsed time to floating point microseconds */
time = ((double) w2)/1000.0;
if (w1 > 0)
    time += ((double) w1)*1000000.0;

printf("Time was %9.3f microseconds \n", time);
exit(0);
}

```

To minimize the overhead of calling and returning from the timer routines, the analyst can experiment with binding the benchmark nonshared (see *When to Use Dynamic Linking and Static Linking*).

If this were a real performance benchmark, we would perform the code to be measured repeatedly. If we timed a number of consecutive repetitions collectively, we could calculate an average time for the operation, but it might include interrupt handling or other extraneous activity. If we timed a number of repetitions individually, we could inspect the individual times for reasonableness, but the overhead of the timing routines would be included in each measurement. It may be desirable to use both techniques and compare the results. In any case, the analyst will want to consider the purpose of the measurements in choosing the method.

POWER-based-Architecture-Unique Timer Access

Note: The following discussion applies only to the POWER and POWER2 architectures (and the 601 processor chip). The code examples will function correctly in a POWER-based system, but some of the instructions will be simulated. Because the purpose of accessing the processor timer is to obtain high-precision times with low overhead, simulation makes the results much less useful.

The POWER and POWER2 processor architectures include two special-purpose registers (an upper register and a lower register) that contain a high-resolution timer. The upper register contains time in seconds, and the lower register contains a count of fractional seconds in nanoseconds. The actual precision of the time in the lower register depends on its update frequency, which is model-specific.

Assembler Routines to Access the POWER Timer Registers

The following assembler-language module (**timer.s**) provides routines (`rtc_upper` and `rtc_lower`) to access the upper and lower registers of the timer:

```

        .globl  .rtc_upper
.rtc_upper: mfspr    3,4          # copy RTCU to return register
            br

        .globl  .rtc_lower
.rtc_lower: mfspr    3,5          # copy RTCL to return register
            br

```

C Subroutine to Supply the Time in Seconds

The following module (**second.c**) contains a C routine that calls the **timer.s** routines to access the upper and lower register contents. It returns a double-precision real value of time in seconds.

```

double second()
{
    int ts, t1, tu;

    ts = rtc_upper();    /* seconds          */
    t1 = rtc_lower();    /* nanoseconds     */
    tu = rtc_upper();    /* Check for a carry from */
    if (ts != tu)        /* the lower reg to the upper. */
        t1 = rtc_lower(); /* Recover from the race condition. */
    return ( tu + (double)t1/1000000000 );
}

```

The subroutine **second()** can be called from either a C routine or a FORTRAN routine.

Note: Depending on the length of time since the last system reset, the **second.c** module might yield a varying amount of precision. The longer the time since reset, the larger the number of bits of precision consumed by the whole-seconds part of the number. The technique shown in the first part of this appendix avoids this problem by performing the subtraction required to obtain an elapsed time before converting to floating point.

Accessing Timer Registers in PowerPC Systems

The PowerPC architecture includes a 64-bit TimeBase register, which is logically divided into 32-bit upper and lower fields (TBU and TBL). The TimeBase register is incremented at a frequency that is hardware- and software-implementation dependent and may vary from time to time. Transforming the values from TimeBase into seconds is a more complex task than in the POWER architecture. To obtain time values in PowerPC systems, use the **read_real_time()** and **time_base_to_time()** interfaces.

Example of the second Subroutine

An example (**main.c**) of a C program using the **second()** subroutine is as follows:

```

#include <stdio.h>
double second();
main()
{
    double t1,t2;

    t1 = second();
    my_favorite_function();
    t2 = second();

    printf("my_favorite_function time: %7.9f\n",t2 - t1);
    exit();
}

```

An example (**main.f**) of a FORTRAN program using the **second()** subroutine is as follows:

```

double precision t1
double precision t2

t1 = second()
my_favorite_subroutine()
t2 = second()
write(6,11) (t2 - t1)
11 format(f20.12)
end

```

To compile and use either **main.c** or **main.f**, use the following:

```

xlc -O3 -c second.c timer.s
xlf -O3 -o mainF main.f second.o timer.o
xlc -O3 -o mainC main.c second.o timer.o

```

Appendix D. Determining CPU Speed

When using AIX 5.1 and subsequent releases, the following code returns the processor speed in hertz (Hz):

```
lsattr -E -l proc0 | grep "Processor Speed"
```

When using earlier releases than AIX 5.1, use the **uname** command. Running the **uname -m** command produces output of the following form:

```
xyyyyyymmss
```

where:

xx 00

yyyyyy
Unique CPU ID

mm Model ID (the numbers to use to determine CPU speed)

ss 00 (Submodel)

By cross-referencing the mm values from the **uname -m** output with the table below, you can determine the processor speed.

| Model ID | Machine Type | Processor Speed | Architecture |
|----------|--------------------|-----------------|--------------|
| 02 | 7015-930 | 25 | Power |
| 10 | 7013-530 | 25 | Power |
| 10 | 7016-730 | 25 | Power |
| 11 | 7013-540 | 30 | Power |
| 14 | 7013-540 | 30 | Power |
| 18 | 7013-53H | 33 | Power |
| 1C | 7013-550 | 41.6 | Power |
| 20 | 7015-930 | 25 | Power |
| 2E | 7015-950 | 41 | Power |
| 30 | 7013-520 | 20 | Power |
| 31 | 7012-320 | 20 | Power |
| 34 | 7013-52H | 25 | Power |
| 35 | 7012-32H | 25 | Power |
| 37 | 7012-340 | 33 | Power |
| 38 | 7012-350 | 41 | Power |
| 41 | 7011-220 | 33 | RSC |
| 43 | 7008-M20 | 33 | Power |
| 43 | 7008-M2A | 33 | Power |
| 46 | 7011-250 | 66 | PowerPC |
| 47 | 7011-230 | 45 | RSC |
| 48 | 7009-C10 | 80 | PowerPC |
| 4C | | See Note 1. | |
| 57 | 7012-390 | 67 | Power2 |
| 57 | 7030-3BT | 67 | Power2 |
| 57 | 9076-SP2 Thin | 67 | Power2 |
| 58 | 7012-380 | 59 | Power2 |
| 58 | 7030-3AT | 59 | Power2 |
| 59 | 7012-39H | 67 | Power2 |
| 59 | 9076-SP2 Thin w/L2 | 67 | Power2 |
| 5C | 7013-560 | 50 | Power |
| 63 | 7015-970 | 50 | Power |
| 63 | 7015-97B | 50 | Power |
| 64 | 7015-980 | 62.5 | Power |
| 64 | 7015-98B | 62.5 | Power |
| 66 | 7013-580 | 62.5 | Power |
| 67 | 7013-570 | 50 | Power |
| 67 | 7015-R10 | 50 | Power |
| 70 | 7013-590 | 66 | Power2 |
| 70 | 9076-SP2 Wide | 66 | Power2 |

| | | | |
|----|---------------|-------------|----------|
| 71 | 7013-58H | 55 | Power2 |
| 72 | 7013-59H | 66 | Power2 |
| 72 | 7015-R20 | 66 | Power2 |
| 72 | 9076-SP2 Wide | 66 | Power2 |
| 75 | 7012-370 | 62 | Power |
| 75 | 7012-375 | 62 | Power |
| 75 | 9076-SP1 Thin | 62 | Power |
| 76 | 7012-360 | 50 | Power |
| 76 | 7012-365 | 50 | Power |
| 77 | 7012-350 | 41 | Power |
| 77 | 7012-355 | 41 | Power |
| 77 | 7013-55L | 41.6 | Power |
| 79 | 7013-591 | 77 | Power2 |
| 79 | 9076-SP2 Wide | 77 | Power2 |
| 80 | 7015-990 | 71.5 | Power2 |
| 81 | 7015-R24 | 71.5 | Power2 |
| 89 | 7013-595 | 135 | P2SC |
| 89 | 9076-SP2 Wide | 135 | P2SC |
| 94 | 7012-397 | 160 | P2SC |
| 94 | 9076-SP2 Thin | 160 | P2SC |
| A0 | 7013-J30 | 75 | PowerPC |
| A1 | 7013-J40 | 112 | PowerPC |
| A3 | 7015-R30 | See Note 2. | PowerPC |
| A4 | 7015-R40 | See Note 2. | PowerPC |
| A4 | 7015-R50 | See Note 2. | PowerPC |
| A4 | 9076-SP2 High | See Note 2. | PowerPC |
| A6 | 7012-G30 | See Note 2. | PowerPC |
| A7 | 7012-G40 | See Note 2. | PowerPC |
| C0 | 7024-E20 | See Note 3. | PowerPC |
| C0 | 7024-E30 | See Note 3. | PowerPC |
| C4 | 7025-F30 | See Note 3. | PowerPC |
| F0 | 7007-N40 | 50 | ThinkPad |

Notes:

1. For systems where the **uname -m** command outputs a model ID of 4C; in general, the only way to determine the processor speed of a machine with a model ID of 4C is to reboot into System Management Services and choose the system configuration options. However, in some cases, the information gained from the **uname -M** command can be helpful, as shown in the following table.

| uname -M | Machine Type | Processor Speed | Processor Architecture |
|--------------------|---------------------|------------------------|-------------------------------|
| IBM,7017-S70 | 7017-S70 | 125 | RS64 |
| IBM,7017-S7A | 7017-S7A | 262 | RD64-II |
| IBM,7017-S80 | 7017-S80 | 450 | RS-III |
| IBM,7025-F40 | 7025-F40 | 166/233 | PowerPC |
| IBM,7025-F50 | 7025-F50 | See Note 4. | PowerPC |
| IBM,7026-H10 | 7026-H10 | 166/233 | PowerPC |
| IBM,7026-H50 | 7026-H50 | See Note 4. | PowerPC |
| IBM,7026-H70 | 7026-H70 | 340 | RS64-II |
| IBM,7042/7043 (ED) | 7043-140 | 166/200/233/332 | PowerPC |
| IBM,7042/7043 (ED) | 7043-150 | 375 | PowerPC |
| IBM,7042/7043 (ED) | 7043-240 | 166/233 | PowerPC |
| IBM,7043-260 | 7043-260 | 200 | Power3 |
| IBM,7248 | 7248-100 | 100 | PowerPersonal |
| IBM,7248 | 7248-120 | 120 | PowerPersonal |
| IBM,7248 | 7248-132 | 132 | PowerPersonal |
| IBM,9076-270 | 9076-SP Silver Node | See Note 4. | PowerPC |

2. For J-Series, R-Series, and G-Series systems, you can determine the processor speed in an MCA SMP system from the FRU number of the CPU card by using the following command:

```
# lscfg -v1 cpucard0 | grep FRU
FRU Number    Processor Type    Processor Speed
E1D           PowerPC 601      75
C1D           PowerPC 601      75
C4D           PowerPC 604      112
E4D           PowerPC 604      112
X4D           PowerPC 604e     200
```

3. For the E-series and F-30 systems use the following command to determine CPU speed:

```
# lscfg -vp | pg
```

Look for the following stanza:

```
procF0                                CPU Card

Part Number.....093H5280
EC Level.....00E76527
Serial Number.....17700008
FRU Number.....093H2431
Displayable Message.....CPU Card
Device Specific.(PL).....
Device Specific.(ZA).....PS=166,PB=066,PCI=033,NP=001,CL=02,PBH
                                Z=64467000,PM=2.5,L2=1024
Device Specific.(RM).....10031997 140951 VIC97276
ROS Level and ID.....03071997 135048
```

In the section Device Specific.(ZA), the section PS= is the processor speed expressed in MHz.

4. For F-50 and H-50 systems and SP Silver Node, the following commands can be used to determine the processor speed of an F-50 system:

```
# lscfg -vp | more
```

Look for the following stanza:

```
Orca M5 CPU:
Part Number.....08L1010
EC Level.....E78405
Serial Number.....L209034579
FRU Number.....93H8945
Manufacture ID.....IBM980
Version.....RS6K
Displayable Message.....OrcaM5 CPU DD1.3
Product Specific.(ZC).....PS=0013c9eb00,PB=0009e4f580,SB=0004f27
                                ac0,NP=02,PF=461,PV=05,KV=01,CL=1
```

In the line containing Product Specific.(ZC), the entry PS= is the processor speed in hexadecimal notation. To convert this to an actual speed, use the following conversions:

```
0009E4F580 = 166 MHz
0013C9EB00 = 332 MHz
```

The value PF= indicates the processor configuration.

```
251 = 1 way 166 MHz
261 = 2 way 166 MHz
451 = 1 way 332 MHz
461 = 2 way 332 MHz
```

Appendix E. National Language Support: Locale versus Speed

National Language Support (NLS) facilitates the use of the operating system in various language environments. Because informed use of NLS is increasingly important in obtaining optimum performance from the system, this appendix contains a brief review of NLS.

NLS allows the operating system to be tailored to the individual user's language and cultural expectations. A *locale* is a specific combination of language and geographic or cultural requirements that is identified by a compound name, such as `en_US` (English as used in the United States). For each supported locale, there is a set of message catalogs, collation value tables, and other information that defines the requirements of that locale. When the operating system is installed, the system administrator can choose what locale information should be installed. Thereafter, the individual users can control the locale of each shell by changing the **LANG** and **LC_ALL** variables.

The one locale that does not conform to the structure just described is the C (or POSIX) locale. The C locale is the system default locale unless the user explicitly chooses another. It is also the locale in which each newly forked process starts. Running in the C locale is the nearest equivalent in the operating system to running in the original, unilingual form of UNIX. There are no C message catalogs. Instead, programs that attempt to get a message from the catalog are given back the default message that is compiled into the program. Some commands, such as the **sort** command, revert to their original, character-set-specific algorithms.

The performance of NLS generally falls into three bands. The C locale is generally the fastest for the execution of commands, followed by the single-byte (Latin alphabet) locales such as `en_US`, with the multibyte locales resulting in the slowest command execution.

Programming Considerations

Historically, the C language has displayed a certain amount of provinciality in its interchangeable use of the words `byte` and `character`. Thus, an array declared `char foo[10]` is an array of 10 bytes. But not all of the languages in the world are written with characters that can be expressed in a single byte. Japanese and Chinese, for example, require two or more bytes to identify a particular graphic to be displayed. Therefore, we distinguish between a `byte`, which is 8 bits of data, and a `character`, which is the amount of information needed to represent a single graphic.

Two characteristics of each locale are the maximum number of bytes required to express a character in that locale and the maximum number of output display positions a single character can occupy. These values can be obtained with the **MB_CUR_MAX** and **MAX_DISP_WIDTH** macros. If both values are 1, the locale is one in which the equivalence of byte and character still holds. If either value is greater than 1, programs that do character-by-character processing, or that keep track of the number of display positions used, must use internationalization functions to do so.

Because the multibyte encodings consist of variable numbers of bytes per character, they cannot be processed as arrays of characters. To allow efficient coding in situations where each character has to receive extensive processing, a fixed-byte-width data type, **wchar_t**, has been defined. A **wchar_t** is wide enough to contain a translated form of any supported character encoding. Programmers can therefore declare arrays of **wchar_t** and process them with (roughly) the same logic they would have used on an array of **char**, using the wide-character analogs of the traditional **libc.a** functions.

Unfortunately, the translation from the multibyte form in which text is entered, stored on disk, or written to the display, to the **wchar_t** form, is computationally quite expensive. It should only be performed in situations in which the processing efficiency of the **wchar_t** form will more than compensate for the cost of translation to and from the **wchar_t** form.

Some Simplifying Rules

It is possible to write a slow, multilingual application program if the programmer is unaware of some constraints on the design of multibyte character sets that allow many programs to run efficiently in a multibyte locale with little use of internationalization functions. For example:

- In all code sets supported by IBM, the character codes 0x00 through 0x3F are unique and encode the ASCII standard characters. Being unique means that these bit combinations never appear as one of the bytes of a multibyte character. Because the null character is part of this set, the **strlen()**, **strcpy()**, and **strcat()** functions work on multibyte as well as single-byte strings. The programmer must remember that the value returned by **strlen()** is the number of bytes in the string, not the number of characters.
- Similarly, the standard string function **strchr(foostr, '/')** works correctly in all locales, because the / (slash) is part of the unique code-point range. In fact, most of the standard delimiters are in the 0x00 to 0x3F range, so most parsing can be accomplished without recourse to internationalization functions or translation to **wchar_t** form.
- Comparisons between strings fall into two classes: equal and unequal. Use the standard **strcmp()** function to perform comparisons. When you write

```
if (strcmp(foostr,"a rose") == 0)
```

you are not looking for "a rose" by any other name; you are looking for that set of bits only. If `foostr` contains "a rosE" no match is found.
- Unequal comparisons occur when you are attempting to arrange strings in the locale-defined collation sequence. In that case, you would use

```
if (strcoll(foostr,barstr) > 0)
```

and pay the performance cost of obtaining the collation information about each character.
- When a program is executed, it always starts in the C locale. If it will use one or more internationalization functions, including accessing message catalogs, it must execute:

```
setlocale(LC_ALL, "");
```

to switch to the locale of its parent process before calling any internationalization function.

Setting the Locale

The following command sequence:

```
LANG=C
export LANG
```

sets the default locale to C (that is, C is used unless a given variable, such as **LC_COLLATE**, is explicitly set to something else).

The following sequence:

```
LC_ALL=C
export LC_ALL
```

forcibly sets all the locale variables to C, regardless of previous settings.

For a report on the current settings of the locale variables, type **locale**.

Appendix F. Summary of Tunable Parameters

Each of the following sections describes one of the operating system's parameters that can affect performance. This appendix contains the following major sections:

- Environment Variables
- Kernel Tunable Parameters
- Network Tunable Parameters

The parameters are described in alphabetical order within each section.

Environment Variables

This section discusses the following topics:

- Thread Support Tunable Parameters
- Miscellaneous Tunable Parameters

Thread Support Tunable Parameters

Following is a list of *thread support parameters* that can be tuned:

1. ACT_TIMEOUT

Purpose: Tunes the seconds for activation timeouts.

Values: Default: DEF_ACTOUT
Range: A positive integer

Display: **echo \$ACT_TIMEOUT**
(This is turned on internally, so the initial default value will not be seen with the **echo** command)

Change: **ACT_TIMEOUT=export ACT_TIMEOUT**
export SPINLOOPTIME
Change takes effect immediately in this shell.
Change is effective until logging out of this shell.
Permanent change is made by adding **ACT_TIMEOUT=*n*** command to the **/etc/environment** file.

Diagnosis: N/A

Tuning: N/A

Refer to: Thread Environment Variables

2. AIXTHREAD_COND_DEBUG (AIX 4.3.3 and subsequent versions)

Purpose: Maintains a list of condition variables for use by the debugger.

Values: Default: ON
Range: ON, OFF

Display: **echo \$AIXTHREAD_COND_DEBUG**
(This is turned on internally, so the initial default value will not be seen with the **echo** command)

Change: **AIXTHREAD_COND_DEBUG={ON|OFF}**
export AIXTHREAD_COND_DEBUG
Change takes effect immediately in this shell.
Change is effective until logging out of this shell. Permanent change is made by adding **AIXTHREAD_COND_DEBUG={ON|OFF}** command to the **/etc/environment** file.

Diagnosis: Leaving it on makes debugging threaded applications easier, but may impose some overhead.

Tuning: If the program contains a large number of active condition variables and frequently creates and destroys condition variables, this may create higher overhead for maintaining the list of condition variables. Setting the variable to **OFF** will disable the list.

Refer to “Thread Debug Options” on page 71.

3. AIXTHREAD_ENRUSG

- Purpose:** Enable or disable pthread resource collection.
- Values:** Default: OFF
Range: ON, OFF
- Display:** **echo \$AIXTHREAD_ENRUSG**
(This is turned on internally, so the initial default value will not be seen with the **echo** command)
- Change:** **AIXTHREAD_ENRUSG={ON|OFF}**
export AIXTHREAD_ENRUSG
Change takes effect immediately in this shell. Change is effective until logging out of this shell. Permanent change is made by adding **AIXTHREAD_ENRUSG={ON/OFF}** command to the **/etc/environment** file.
- Diagnosis:** Turning it on allows for resource collection of all pthreads in a process, but will impose some overhead.

Tuning:

Refer to “Thread Environment Variables” on page 67.

4. AIXTHREAD_GUARDPAGES (AIX 4.3 and later)

- Purpose:** Controls the number of guard pages to add to the end of the pthread stack.
- Values:** Default: 0
Range: A positive integer
- Display:** **echo \$AIXTHREAD_GUARDPAGES**
(This is turned on internally, so the initial default value will not be seen with the **echo** command)
- Change:** **AIXTHREAD_GUARDPAGES=*n***
export AIXTHREAD_GUARDPAGES
Change takes effect immediately in this shell.
Change is effective until logging out of this shell.
Permanent change is made by adding **AIXTHREAD_GUARDPAGES=*n*** command to the **/etc/environment** file.
- Diagnosis:** N/A
- Tuning:** N/A

Refer to “Thread Environment Variables” on page 67.

5. AIXTHREAD_MINKTHREADS (AIX 4.3 and later)

- Purpose:** Controls the the minimum number of kernel threads that should be used.
- Values:** Default: 8
Range: A positive integer value
- Display:** **echo \$AIXTHREAD_MINKTHREADS**
(This is turned on internally, so the initial default value will not be seen with the **echo** command)
- Change:** **AIXTHREAD_MINKTHREADS=*n***
export AIXTHREAD_MINKTHREADS
Change takes effect immediately in this shell. Change is effective until logging out of this shell. Permanent change is made by adding **AIXTHREAD_MINKTHREADS =*n*** command to the **/etc/environment** file.
- Diagnosis:** N/A
- Tuning:** The library scheduler will not reclaim kernel threads below this figure. A kernel thread may be reclaimed at virtually any point. Generally, a kernel thread is targeted as a result of a pthread terminating.

Refer to: Variables for Process-Wide Contention Scope

6. AIXTHREAD_MNRATIO (AIX 4.3 and later)

- Purpose:** Controls the scaling factor of the library. This ratio is used when creating and terminating pthreads.
- Values:** Default: 8:1
Range: Two positive values ($p:k$), where k is the number of kernel threads that should be employed to handle p runnable pthreads
- Display:** **echo \$AIXTHREAD_MNRATIO**
(This is turned on internally, so the initial default value will not be seen with the **echo** command)
- Change:** **AIXTHREAD_MNRATIO= $p:k$**
export AIXTHREAD_MNRATIO
Change takes effect immediately in this shell.
Change is effective until logging out of this shell.
Permanent change is made by adding **AIXTHREAD_MNRATIO= $p:k$** command to the **/etc/environment** file.
- Diagnosis:** N/A
- Tuning:** May be useful for applications with a very large number of threads. However, always test a ratio of 1:1 because it may provide for better performance.

Refer to: Variables for Process-Wide Contention Scope

7. AIXTHREAD_MUTEX_DEBUG (AIX 4.3.3 and later)

- Purpose:** Maintains a list of active mutexes for use by the debugger.
- Values:** Default: OFF
Range: ON, OFF
- Display:** **echo \$AIXTHREAD_MUTEX_DEBUG**
(This is turned on internally, so the initial default value will not be seen with the **echo** command)
- Change:** **AIXTHREAD_MUTEX_DEBUG={ON/OFF}**
export AIXTHREAD_MUTEX_DEBUG
Change takes effect immediately in this shell.
Change is effective until logging out of this shell.
Permanent change is made by adding **AIXTHREAD_MUTEX_DEBUG={ON/OFF}** command to the **/etc/environment** file.
- Diagnosis:** Setting the variable to ON makes debugging threaded applications easier, but may impose some overhead.
- Tuning:** If the program contains a large number of active mutexes and frequently creates and destroys mutexes, this may create higher overhead for maintaining the list of mutexes. Leaving the variable off disables the list.

Refer to: Thread Debug Options

8. AIXTHREAD_READ_GUARDPAGES (AIX 5.3 with 5300-03 and later)

- Purpose:** Controls the read access to guard pages that are added to the end of the pthread stack.
- Values:** Default: OFF
Range: ON, OFF
- Display:** **echo \$AIXTHREAD_READ_GUARDPAGES**
(This is turned on internally, so the initial default value will not be seen with the **echo** command)

Change: AIXTHREAD_READ_GUARDPAGES={ON|OFF}
export AIXTHREAD_GUARDPAGES
Change takes effect immediately in this shell.
Change is effective until logging out of this shell.
Permanent change is made by adding the **AIXTHREAD_READ_GUARDPAGES={ON|OFF}**
command to the **/etc/environment** file.

Diagnosis: N/A

Tuning: N/A

Refer to “Thread Environment Variables” on page 67.

9. AIXTHREAD_RWLOCK_DEBUG (AIX 4.3.3 and later)

Purpose: Maintains a list of read-write locks for use by the debugger.

Values: Default: ON
Range: ON, OFF

Display: **echo \$AIXTHREAD_RWLOCK_DEBUG**
(This is turned on internally, so the initial default value will not be seen with the **echo** command)

Change: **AIXTHREAD_RWLOCK_DEBUG={ON|OFF}**
export AIXTHREAD_RWLOCK_DEBUG
Change takes effect immediately in this shell.
Change is effective until logging out of this shell.
Permanent change is made by adding **AIXTHREAD_RWLOCK_DEBUG={ON|OFF}** command to the **/etc/environment** file.

Diagnosis: Leaving it on makes debugging threaded applications easier, but may impose some overhead.

Tuning: If the program contains a large number of active read-write locks and frequently creates and destroys read-write locks, this may create higher overhead for maintaining the list of read-write locks. Setting the variable to OFF will disable the list.

Refer to: Thread Debug Options

10. AIXTHREAD_SCOPE (AIX 4.3.1 and later)

Purpose: Controls contention scope. P signifies process-based contention scope (M:N). S signifies system-based contention scope (1:1).

Values: Default: P
Possible Values: P or S

Display: **echo \$AIXTHREAD_SCOPE**
(This is turned on internally, so the initial default value will not be seen with the **echo** command)

Change: **AIXTHREAD_SCOPE={P|S}**
export AIXTHREAD_SCOPE
Change takes effect immediately in this shell.
Change is effective until logging out of this shell.
Permanent change is made by adding **AIXTHREAD_SCOPE={P|S}** command to the **/etc/environment** file.

Diagnosis: If fewer threads are being dispatched than expected, then system scope should be tried.

Tuning: Tests on AIX 4.3.2 have shown that certain applications can perform much better with system based contention scope (S). The use of this environment variable impacts only those threads created with the default attribute. The default attribute is employed when the *attr* parameter to **pthread_create** is NULL.

Refer to: Thread Environment Variables

11. AIXTHREAD_SLPRATIO (AIX 4.3 and later)

Purpose: Controls the number of kernel threads that should be held in reserve for sleeping threads.

Values: Default: 1:12
Range: Two positive values (*k:p*), where *k* is the number of kernel threads that should be held in reserve for *p* sleeping pthreads

Display: **echo \$AIXTHREAD_SLPRATIO**
(This is turned on internally, so the initial default value will not be seen with the **echo** command)

Change: **AIXTHREAD_SLPRATIO=*k:p***
export AIXTHREAD_SLPRATIO
Change takes effect immediately in this shell.
Change is effective until logging out of this shell.
Permanent change is made by adding the **AIXTHREAD_SLPRATIO=*k:p*** command to the **/etc/environment** file.

Diagnosis: N/A

Tuning: In general, fewer kernel threads are required to support sleeping pthreads, because they are generally woken one at a time. This conserves kernel resources.

Refer to: Variables for Process-Wide Contention Scope

12. AIXTHREAD_STK=*n* (AIX 4.3.3 ML 09 and later)

Purpose: The decimal number of bytes that should be allocated for each pthread. This value may be overridden by **pthread_attr_setstacksize**.

Values: Default: 98,304 bytes for 32bit applications, 196,608 bytes for 64bit applications.
Range: Decimal integer values from 0 to 268,435,455 which will be rounded up to the nearest page (currently 4,096).

Display: **echo \$AIXTHREAD_STK**
(This is turned on internally, so the initial default value will not be seen with the **echo** command)

Change: **AIXTHREAD_STK=*size***
export AIXTHREAD_STK
Change takes effect immediately in this shell.
Change is effective until logging out of this shell.
Permanent change is made by adding the **AIXTHREAD_STK=*size*** command to the **/etc/environment** file.

Diagnosis: If analysis of a failing program indicates stack overflow, the default stack size can be increased.

Tuning: If trying to reach the 32,000 thread limit on a 32 bit application, it may be necessary to decrease the default stack size.

13. MALLOCBUCKETS (Version 4.3.3.25 and later)

Purpose: Enables buckets-based extension in the default memory allocator which may enhance performance of applications that issue large numbers of small allocation requests.

Values: **MALLOCTYPE=buckets**

MALLOCBUCKETS=[[**number_of_buckets**:*n* | **bucket_sizing_factor**:*n* | **blocks_per_bucket**:*n* | **bucket_statistics**:*[stdout|stderr|pathname]*],...]

The following table displays default values of MALLOCBUCKETS.

MALLOCBUCKETS Default Values

| MALLOCBUCKETS Options | Default Value |
|---|-------------------|
| number_of_buckets ¹ | 16 |
| bucket_sizing_factor (32-bit) ² | 32 |
| bucket_sizing_factor (64-bit) ³ | 64 |
| blocks_per_bucket | 1024 ⁴ |

Notes:

1. The minimum value allowed is 1. The maximum value allowed is 128.
2. For 32-bit implementations, the value specified for `bucket_sizing_factor` must be a multiple of 8.
3. For 64-bit implementations, the value specified for `bucket_sizing_factor` must be a multiple of 16.
4. The `bucket_statistics` option is disabled by default.

Display: `echo $MALLOCBUCKETS; echo $MALLOCTYPE`

Change: Use the shell specific method of exporting the environment variables.

Diagnosis: If malloc performance is slow and many small malloc requests are issued, this feature may enhance performance.

Tuning: To enable malloc buckets, the `MALLOCTYPE` environment variable has to be set to the value "buckets".

The `MALLOCBUCKETS` environment variable may be used to change the default configuration of the malloc buckets, although the default values should be sufficient for most applications.

The `number_of_buckets:n` option can be used to specify the number of buckets available per heap, where *n* is the number of buckets. The value specified for *n* will apply to all available heaps.

The `bucket_sizing_factor:n` option can be used to specify the bucket sizing factor, where *n* is the bucket sizing factor in bytes.

The `blocks_per_bucket:n` option can be used to specify the number of blocks initially contained in each bucket, where *n* is the number of blocks. This value is applied to all of the buckets. The value of *n* is also used to determine how many blocks to add when a bucket is automatically enlarged because all of its blocks have been allocated.

The `bucket_statistics` option will cause the malloc subsystem to output a statistical summary for malloc buckets upon typical termination of each process that calls the malloc subsystem while malloc buckets is enabled. This summary will show buckets configuration information and the number of allocation requests processed for each bucket. If multiple heaps have been enabled by way of malloc multiheap, the number of allocation requests shown for each bucket will be the sum of all allocation requests processed for that bucket for all heaps.

The buckets statistical summary will be written to one of the following output destinations, as specified with the `bucket_statistics` option.

| | |
|-----------------|---------------------------|
| stdout | Standard output |
| stderr | Standard error |
| pathname | A user-specified pathname |

If a user-specified pathname is provided, statistical output will be appended to the existing contents of the file (if any). Avoid using standard output as the output destination for a process whose output is piped as input into another process.

Refer to: Malloc Buckets

14. MALLOCMULTIHEAP (AIX 4.3.1 and later)

Purpose: Controls the number of heaps within the process private segment.

Values: Default: 16 for 4.3.1 and 4.3.2, 32 for 4.3.3 and later
Range: A positive number between 1 and 32)

Display: **echo \$MALLOCMULTIHEAP** (this is turned on internally, so the initial default value will not be seen with the **echo** command)

Change: **MALLOCMULTIHEAP=[[heaps:n | considersize],...]**
export MALLOCMULTIHEAP
Change takes effect immediately in this shell. Change is effective until logging out of this shell. Permanent change is made by adding **MALLOCMULTIHEAP=[[heaps:n | considersize],...]** command to the **/etc/environment** file.

Diagnosis: Look for lock contention on the malloc lock (located in segment F) or fewer than expected runnable threads.

Tuning: Smaller number of heaps can help reduce size of the process. Certain multithreaded user processes which use the malloc subsystem heavily may obtain better performance by exporting the environment variable **MALLOCMULTIHEAP=1** before starting the application.

The potential performance enhancement is particularly likely for multithreaded C++ programs, because these may make use of the malloc subsystem whenever a constructor or destructor is called.

Any available performance enhancement will be most evident when the multithreaded user process is running on an SMP system, and particularly when system scope threads are used (M:N ratio of 1:1). However, in some cases, enhancement may also be evident under other conditions, and on uniprocessors.

If the **considersize** option is specified, an alternate heap selection algorithm is used that tries to select an available heap that has enough free space to handle the request. This may minimize the working set size of the process by reducing the number of **sbrk()** calls. However, there is a bit more processing time required for this algorithm.

Refer to: Thread Environment Variables

15. NUM_RUNQ

Purpose: Changes the number of the default number of run queues.

Values: Default: Number of active processors found at run time
Range: A positive integer

Display: **echo \$NUM_RUNQ** (this is turned on internally, so the initial default value will not be seen with the **echo** command)

Change: **NUM_RUNQ=export NUM_RUNQ**
Change takes effect immediately in this shell. Change is effective until logging out of this shell. Permanent change is made by adding **NUM_RUNQ=n** command to the **/etc/environment** file.

Diagnosis: N/A

Tuning: N/A

Refer to: Thread Environment Variables

16.

NUM_SPAREVP

Purpose: Sets the number of vp structures that will be malloced during **pth_init** time.

Values: Default: **NUM_SPARE_VP**
Range: A positive integer

Display: `echo $NUM_SPAREVP` (this is turned on internally, so the initial default value will not be seen with the `echo` command)

Change: `NUM_SPAREVP=export NUM_SPAREVP`
Change takes effect immediately in this shell. Change is effective until logging out of this shell. Permanent change is made by adding `NUM_SPAREVP=n` command to the `/etc/environment` file.

Diagnosis: N/A

Tuning: N/A

Refer to: Thread Environment Variables

17. SPINLOOPTIME

Purpose: Controls the number of times to retry a busy lock before yielding to another processor (only for libpthreads).

Values: Default: 1 on uniprocessors, 40 on multiprocessors
Range: A positive integer

Display: `echo $SPINLOOPTIME` (this is turned on internally, so the initial default value will not be seen with the `echo` command)

Change: `SPINLOOPTIME=n`
`export SPINLOOPTIME`
Change takes effect immediately in this shell. Change is effective until logging out of this shell. Permanent change is made by adding `SPINLOOPTIME=n` command to the `/etc/environment` file.

Diagnosis: If threads are going to sleep often (lot of idle time), then the `SPINLOOPTIME` may not be high enough.

Tuning: Increasing the value from default of 40 on multiprocessor systems might be of benefit if there is pthread mutex contention.

Refer to: Thread Environment Variables

18. STEP_TIME

Purpose: Tunes the number of times it takes to create a vp during activation timeouts.

Values: Default: `DEF_STEPTIME`
Range: A positive integer

Display: `echo $STEP_TIME` (this is turned on internally, so the initial default value will not be seen with the `echo` command)

Change: `STEP_TIME=export STEP_TIME`
Change takes effect immediately in this shell. Change is effective until logging out of this shell. Permanent change is made by adding `STEP_TIME=n` command to the `/etc/environment` file.

Diagnosis: N/A

Tuning: N/A

Refer to: Thread Environment Variables

19. VP_STEALMAX

Purpose: Tunes the number of vps that can be stolen or turns vp stealing off..

Values: Default: None
Range: A positive integer

Display: `echo $VP_STEALMAX` (this is turned on internally, so the initial default value will not be seen with the `echo` command)

Change: `VP_STEALMAX=export VP_STEALMAX`
Change takes effect immediately in this shell. Change is effective until logging out of this shell. Permanent change is made by adding `VP_STEALMAX=n` command to the `/etc/environment` file.

Diagnosis: N/A

Tuning: N/A

Refer to: Thread Environment Variables

20. YIELDLOOPTIME

Purpose: Controls the number of times to yield the processor before blocking on a busy lock (only for libpthreads). The processor is yielded to another kernel thread, assuming there is another runnable kernel thread with sufficient priority.

Values: Default: 0
Range: A positive value

Display: **echo \$YIELDLOOPTIME** (this is turned on internally, so the initial default value will not be seen with the **echo** command)

Change: **YIELDLOOPTIME=*n***
export YIELDLOOPTIME
Change takes effect immediately in this shell. Change is effective until logging out of this shell. Permanent change is made by adding **YIELDLOOPTIME=*n*** command to the **/etc/environment** file.

Diagnosis: If threads are going to sleep often (lot of idle time), then the **YIELDLOOPTIME** may not be high enough.

Tuning: Increasing the value from default value of 0 may benefit if you do not want the threads to go to sleep when waiting for locks.

Refer to: Thread Environment Variables

Miscellaneous Tunable Parameters

Following is a list of *miscellaneous parameters* that can be tuned:

1. EXTSHM (AIX 4.2.1 and later)

Purpose: Turns on the extended shared memory facility.

Values: Default: Not set
Possible Value: ON

Display: **echo \$EXTSHM**

Change: **EXTSHM=ON**
export EXTSHM
Change takes effect immediately in this shell. Change is effective until logging out of this shell. Permanent change is made by adding **EXTSHM=ON** command to the **/etc/environment** file.

Diagnosis: N/A

Tuning: Setting value to ON will allow a process to allocate shared memory segments as small as 1 byte (though this will be rounded up to the nearest page); this effectively removes the limitation of 11 user shared memory segments. Maximum size of all segments together can still only be 2.75 GB worth of memory for 32-bit processes. 64-bit processes do not need to set this variable since a very large number of segments is available. Some restrictions apply for processes that set this variable, and these restrictions are the same as with processes that use mmap buffers.

Refer to: Extended Shared Memory (EXTSHM)

2. LDR_CNTRL

Purpose: Allows tuning of the kernel loader.

Values: Default: Not set
Possible Values: PREREAD_SHLIB, LOADPUBLIC, IGNOREUNLOAD, USERREGS, MAXDATA, DSA, PRIVSEG_LOADS, DATA_START_STAGGER, LARGE_PAGE_TEXT, LARGE_PAGE_DATA, NAMEDSHLIB

Display: `echo $LDR_CNTRL`

Change: `LDR_CNTRL={PREREAD_SHLIB | LOADPUBLICI ...}`
`export LDR_CNTRL`

Change takes effect immediately in this shell. Change is effective until logging out of this shell.

Permanent change is made by adding the following line to the **/etc/environment** file:

`LDR_CNTRL={PREREAD_SHLIB | LOADPUBLICI ...}`

Diagnosis: N/A

Tuning:

The **LDR_CNTRL** environment variable can be used to control one or more aspects of the system loader behavior. You can specify multiple options with the **LDR_CNTRL** variable. When doing this, separate the options using the at sign, @. For example:**LDR_CNTRL=PREREAD_SHLIB@LOADPUBLIC).**

Specifying the **PREREAD_SHLIB** option will cause entire libraries to be read as soon as they are accessed. With VMM readahead tuned, a library can be read in from disk and be cached in memory by the time the program starts to access its pages. While this method can use more memory, it can enhance performance of programs that use many shared library pages providing the access pattern is non-sequential. (for example, Catia).

Specifying the **LOADPUBLIC** option directs the system loader to load all modules requested by an application into the global shared library segment. If a module cannot be loaded publicly into the global shared library segment then it is loaded privately for the application.

Specifying the **IGNOREUNLOAD** option prevents the application from unloading libraries. This might prevent memory fragmentation and eliminate the overhead incurred when libraries are repeatedly loaded and unloaded. If you do not specify the **IGNOREUNLOAD** option, you might end up with two data instances of a module if the module was loaded at application load time and the module was then requested to be dynamically loaded and unloaded multiple times.

Specifying the **USERREGS** option will tell the system to save all general-purpose user registers across system calls made by an application. This can be helpful in applications doing garbage collection.

Specifying the **MAXDATA** option sets the maximum heap size for a process, including overriding any **MAXDATA** value specified in an executable. If you want to use Large Program Support with a data heap size of 0x30000000, then specify **LDR_CNTRL=MAXDATA=0x30000000**. To turn off Large Program Support, specify **LDR_CNTRL=MAXDATA=0**.

Specifying the **DSA** (Dynamic Segment Allocation) option tells the system loader to run applications using Very Large Program Support. The **DSA** option is only valid for 32-bit applications.

Specifying the **PRIVSEG_LOADS** option directs the system loader to put dynamically loaded private modules into the process private segment. This might improve the availability of memory in large memory model applications that perform private dynamic loads and tend to run out of memory in the process heap. If the process private segment lacks sufficient space, the **PRIVSEG_LOADS** option has no effect. The **PRIVSEG_LOADS** option is only valid for 32-bit applications with a non-zero **MAXDATA** value.

Specifying the **DATA_START_STAGGER=Y** option starts the data section of the process at a per-MCM offset that is controlled by the **data_stagger_interval** option of the **vmo** command. The nth large-page data process executed on a given MCM has its data section start at offset (n * **data_stagger_interval** * **PAGESIZE**) % 16MB. The **DATA_START_STAGGER=Y** option is only valid for 64-bit processes on a 64-bit kernel.

Specifying the **LARGE_PAGE_TEXT=Y** option indicates that the loader should attempt to use large pages for the text segment of the process. The **LARGE_PAGE_TEXT=Y** option is only valid for 64-bit processes on a 64-bit kernel.

Specifying the **LARGE_PAGE_DATA=M** option allocates only enough large pages for the data segment up to the **brk** value, rather than the entire segment, which is the behavior when you do not specify the **LARGE_PAGE_DATA=M** option. Changes to the **brk** value might fail if there are not enough large pages to support the change to the **brk** value.

Specifying the **RESOLVEALL** option forces the loader to resolve all undefined symbols that are imported from “.” at program load time or when the program loads the dynamic modules. Symbol resolution is performed in the standard AIX depth-first order. If you specify **LDR_CNTRL=RESOLVEALL** and the symbols imported from “.” cannot be resolved, the program or the dynamic modules fail to load.

Specifying the **NAMEDSHLIB=name,[attr1],[attr2]...[attrN]** option enables a process to access or create a shared library area that is identified by the name that is specified.

You can create a named shared library area in the following methods:

- With no attributes
- With the **doubletex32** attribute, which creates the named shared library area with two segments dedicated to shared library text.

If a process requests the use of a named shared library area which does not exist, the shared library area is automatically created with the name that is specified. If an invalid name is specified, the **NAMEDSHLIB=name,[attr1],[attr2]...[attrN]** option is ignored. Valid names are of positive length and contain only alphanumeric, underscore, and period characters.

3. NODISCLAIM

Purpose: Controls how calls to **free()** are being handled. When **PSALLOC** is set to *early*, all **free()** calls result in a **disclaim()** system call. When **NODISCLAIM** is set to True, this does not occur.

Values: Default: Not set
Possible Value: True

Display: **echo \$NODISCLAIM**

Change: **NODISCLAIM=true**
export NODISCLAIM
Change takes effect immediately in this shell. Change is effective until logging out of this shell. Permanent change is made by adding **NODISCLAIM=true** command to the **/etc/environment** file.

Diagnosis: If number of **disclaim()** system calls is very high, you may want to set this variable.

Tuning: Setting this variable will eliminate calls to **disclaim()** from **free()** if **PSALLOC** is set to early.

Refer to: Early Page Space Allocation

4. NSORDER

Purpose: Overwrites the set name resolution search order.

Values: Default: bind, nis, local
Possible Values: bind, local, nis, bind4, bind6, local4, local6, nis4, or nis6

Display: **echo \$NSORDER** (this is turned on internally, so the initial default value will not be seen with the **echo** command)

Change: **NSORDER=value, value, ...**
export NSORDER
Change takes effect immediately in this shell. Change is effective until logging out of this shell. Permanent change is made by adding **NSORDER=value** command to the **/etc/environment** file.

Diagnosis: N/A

Tuning: **NSORDER** overrides the **/etc/netsvc.conf** file.

Refer to: Tuning Name Resolution

5. PSALLOC

Purpose: Sets the **PSALLOC** environment variable to determine the paging-space allocation policy.

Values: Default: Not set
Possible Value: early

Display: **echo \$PSALLOC**

Change: **PSALLOC=early**
export PSALLOC
Change takes effect immediately in this shell. Change is effective until logging out of this shell.

Diagnosis: N/A

Tuning: To ensure that a process is not killed due to low paging conditions, this process can preallocate paging space by using the Early Page Space Allocation policy. However, this may result in wasted paging space. You may also want to set the **NODISCLAIM** environment variable.

Refer to: Allocation and Reclamation of Paging Space Slots and Early Page Space Allocation

6. RT_GRQ (AIX 4.3.3.1 and later)

Purpose: Causes thread to be put on a global run queue rather than on a per-CPU run queue.

Values: Default: Not set; Range: ON, OFF

Display: **echo \$RT_GRQ**

Change: `RT_GRQ={OFF/ON}`
export RT_GRQ
 Change takes effect immediately. Change is effective until next boot. Permanent change is made by adding `RT_GRQ={ON/OFF}` command to the `/etc/environment` file.

Diagnosis: N/A

Tuning: May be tuned on multiprocessor systems. Set to ON, will cause the thread to be put on a global run queue. In that case, the global run queue is searched to see which thread has the best priority. This might allow to get the thread dispatched sooner and can improve performance for threads that are running SCHED_OTHER, and are interrupt driven.

Refer to: Scheduler Run Queue

7. RT_MPC (AIX 4.3.3 and later)

Purpose: When running the kernel in real-time mode (see `bosdebug` command), an MPC can be sent to a different CPU to interrupt it if a better priority thread is runnable so that this thread can be dispatched immediately.

Values: Default: Not set; Range: ON

Display: `echo $RT_MPC`

Change: `RT_MPC=ON`
export RT_MPC
 Change takes effect immediately. Change is effective until next boot. Permanent change is made by adding `RT_MPC=ON` command to the `/etc/environment` file.

Diagnosis: N/A

Kernel Tunable Parameters

Following are kernel parameters, grouped into the following sections:

- Scheduler and Memory Load Control Tunable Parameters
- Virtual Memory Manager Tunable Parameters
- Synchronous I/O Tunable Parameters
- Asynchronous I/O Tunable Parameters
- Disk and Disk Adapter Tunable Parameters
- Interprocess Communication Tunable Parameters

Scheduler and Memory Load Control Tunable Parameters

Most of the scheduler and memory load control tunable parameters are fully described in the `schedo` man page. The following are a few other related parameters:

1. maxuproc

Purpose: Specifies the maximum number of processes per user ID.

Values: Default: 40; Range: 1 to 131072

Display: `lsattr -E -l sys0 -a maxuproc`

Change: `chdev -l sys0 -a maxuproc=NewValue`
 Change takes effect immediately and is preserved over boot. If value is reduced, then it goes into effect only after a system boot.

Diagnosis: Users cannot fork any additional processes.

Tuning: This is a safeguard to prevent users from creating too many processes.

2. ncargs

- Purpose:** Specifies the maximum allowable size of the ARG/ENV list (in 4KB blocks) when running **exec()** subroutines.
- Values:** Default: 6; Range: 6 to 1024
- Display:** **lsattr -E -l sys0 -a ncargs**
- Change:** **chdev -l sys0 -a ncargs=NewValue**
Change takes effect immediately and is preserved over boot.
- Diagnosis:** Users cannot execute any additional processes because the argument list passed to the **exec()** system call is too long. A low default value might cause some programs to fail with the `arg list too long` error message, in which case you might try increasing the **ncargs** value with the **chdev** command above and then rerunning the program.
- Tuning:** This is a mechanism to prevent the **exec()** subroutines from failing if the argument list is too long. Please note that tuning to a higher **ncargs** value puts additional constraints on system memory resources.

Virtual Memory Manager Tunable Parameters

The complete listing of the virtual memory manager tunable parameters is located in the **vmo** man page.

Synchronous I/O Tunable Parameters

Most of the synchronous I/O tunable parameters are fully described in the **ioo** man page. The following are a few other related parameters:

1. maxbuf

- Purpose:** Number of (4 KB) pages in the block-I/O buffer cache.
- Values:** Default: 20; Range: 20 to 1000
- Display:** **lsattr -E -l sys0 -a maxbuf**
- Change:** **chdev -l sys0 -a maxbuf=NewValue**
Change is effective immediately and is permanent. If the **-T** flag is used, the change is immediate and lasts until the next boot. If the **-P** flag is used, the change is deferred until the next boot and is permanent.
- Diagnosis:** If the **sar -b** command shows `breads` or `bwrites` with `%rcache` and `%wcache` being low, you might want to tune this parameter.
- Tuning:** This parameter normally has little performance effect on systems, where ordinary I/O does not use the block-I/O buffer cache.

Refer to: Tuning Asynchronous Disk I/O

2. maxpout

- Purpose:** Specifies the maximum number of pending I/Os to a file.
- Values:** Default: 0 (no checking); Range: 0 to n (n should be a multiple of 4, plus 1)
- Display:** **lsattr -E -l sys0 -a maxpout**
- Change:** **chdev -l sys0 -a maxpout=NewValue**
Change is effective immediately and is permanent. If the **-T** flag is used, the change is immediate and lasts until the next boot. If the **-P** flag is used, the change is deferred until the next boot and is permanent.
- Diagnosis:** If the foreground response time sometimes deteriorates when programs with large amounts of sequential disk output are running, sequential output may need to be paced.

Tuning: Set **maxpout** to 33 and **minpout** to 16. If sequential performance deteriorates unacceptably, increase one or both. If foreground performance is still unacceptable, decrease both.

3. minpout

Purpose: Specifies the point at which programs that have reached **maxpout** can resume writing to the file.

Values: Default: 0 (no checking); Range: 0 to n (n should be a multiple of 4 and should be at least 4 less than **maxpout**)

Display: **lsattr -E -l sys0 -a minpout**

Change: **chdev -l sys0 -a minpout=NewValue**

Change is effective immediately and is permanent. If the **-T** flag is used, the change is immediate and lasts until the next boot. If the **-P** flag is used, the change is deferred until the next boot and is permanent.

Diagnosis: If the foreground response time sometimes deteriorates when programs with large amounts of sequential disk output are running, sequential output may need to be paced.

Tuning: Set **maxpout** to 33 and **minpout** to 16. If sequential performance deteriorates unacceptably, increase one or both. If foreground performance is still unacceptable, decrease both.

4. mount -o nointegrity

Purpose: A new mount option (nointegrity) may enhance local file system performance for certain write-intensive applications. This optimization basically eliminates writes to the JFS log. Note that the enhanced performance is achieved at the expense of metadata integrity. Therefore, use this option with extreme caution because a system crash can make a file system mounted with this option unrecoverable. Nevertheless, certain classes of applications do not require file data to remain consistent after a system crash, and these may benefit from using the nointegrity option. Two examples in which a nointegrity file system may be beneficial is for compiler temporary files, and for doing a nonmigration or mkysb installation.

5. Paging Space Size

Purpose: The amount of disk space required to hold pages of working storage.

Values: Default: configuration-dependent; Range: 32 MB to n MB for hd6, 16 MB to n MB for non-hd6

Display: **lsps -a**
mkps or **chps** or **smitty pgsp**

Change: Change is effective immediately and is permanent. Paging space is not necessarily put into use immediately, however.

Diagnosis: Run: **lsps -a**. If processes have been killed for lack of paging space, monitor the situation with the **psdanger()** subroutine.

Tuning: If it appears that there is not enough paging space to handle the normal workload, add a new paging space on another physical volume or make the existing paging spaces larger.

6. syncd Interval

Purpose: The time between **sync()** calls by **syncd**.

Values: Default: 60; Range: 1 to any positive integer

Display: **grep syncd /sbin/rc.boot**
vi /sbin/rc.boot or

Change: Change is effective at next boot and is permanent. An alternate method is to use the **kill** command to terminate the **syncd** daemon and restart it from the command line with the command **/usr/sbin/syncd interval**.

Diagnosis: I/O to a file is blocked when **syncd** is running.

Tuning: At its default level, this parameter has little performance cost. No change is recommended. Significant reductions in the **syncd interval** in the interests of data integrity (as for HACMP™) could have adverse performance consequences.

Asynchronous I/O Tunable Parameters

1. maxreqs

Purpose: Specifies the maximum number of asynchronous I/O requests that can be outstanding at any one time.

Values: Default: 4096; Range: 1 to AIO_MAX (*/usr/include/sys/limits.h*)

Display: **lsattr -E -l aio0 -a maxreqs**

Change: **chdev -l aio0 -a maxreqs=NewValue**
Change is effective after reboot and is permanent.

Diagnosis: N/A

Tuning: This includes requests that are in progress, as well as those that are waiting to be started. The maximum number of asynchronous I/O requests cannot be less than the value of AIO_MAX, as defined in the */usr/include/sys/limits.h* file, but can be greater. It would be appropriate for a system with a high volume of asynchronous I/O to have a maximum number of asynchronous I/O requests larger than AIO_MAX.

Refer to: Tuning Asynchronous Disk I/O

2. maxservers

Purpose: Specifies the maximum number of AIO **kprocs** per processor.

Values: Default: 10 per processor

Display: **lsattr -E -l aio0 -a maxservers**

Change: **chdev -l aio0 -a maxservers=NewValue**
Change is effective after reboot and is permanent.

Diagnosis: N/A

Tuning: This value limits the number of concurrent asynchronous I/O requests. The value should be about the same as the expected number of concurrent AIO requests. This tunable parameter only affects AIO on JFS file systems (or Virtual Shared Disks (VSD) before AIX 4.3.2).

Refer to: Tuning Asynchronous Disk I/O

3. minservers

Purpose: Specifies the number of AIO **kprocs** that will be created when the AIO kernel extension is loaded.

Values: Default: 1

Display: **lsattr -E -l aio0 -a minservers**

Change: **chdev -l aio0 -a minservers=NewValue**
Change is effective after reboot and is permanent.

Diagnosis: N/A

Tuning: Making this a large number is not recommended, because each process takes up some memory. Leaving this number small is acceptable in most cases because AIO will create additional **kprocs** up to **maxservers** as needed. This tunable is only effective for AIO on JFS file systems (or VSDs before AIX 4.3.2).

Refer to: Tuning Asynchronous Disk I/O

Disk and Disk Adapter Tunable Parameters

1. Disk Adapter Outstanding-Requests Limit

| | |
|-------------------|--|
| Purpose: | Maximum number of requests that can be outstanding on a SCSI bus. (Applies only to the SCSI-2 Fast/Wide Adapter.) |
| Values: | Default: 40; Range: 40 to 128 |
| Display: | lsattr -E -l scsin -a num_cmd_elems |
| Change: | chdev -l scsin -a num_cmd_elems=NewValue Change is effective immediately and is permanent. If the -T flag is used, the change is immediate and lasts until the next boot. If the -P flag is used, the change is deferred until the next boot and is permanent. |
| Diagnosis: | Applications performing large writes to striped raw logical volumes are not obtaining the desired throughput rate. |
| Tuning: | Value should equal the number of physical drives (including those in disk arrays) on the SCSI bus, times the queue depth of the individual drives. |

2. Disk Drive Queue Depth

| | |
|-------------------|--|
| Purpose: | Maximum number of requests the disk device can hold in its queue. |
| Values: | Default: IBM disks=3; Non-IBM disks=0; Range: specified by manufacturer |
| Display: | lsattr -E -l hdiskn |
| Change: | chdev -l hdiskn -a q_type=simple -a queue_depth=NewValue Change is effective immediately and is permanent. If the -T flag is used, the change is immediate and lasts until the next boot. If the -P flag is used, the change is deferred until the next boot and is permanent. |
| Diagnosis: | N/A |
| Tuning: | If the non-IBM disk drive is capable of request-queuing, make this change to ensure that the operating system takes advantage of the capability. |

Refer to: Setting SCSI-Adapter and Disk-Device Queue Limits

Interprocess Communication Tunable Parameters

1. msgmax

| | |
|-------------------|---|
| Purpose: | Specifies maximum message size. |
| Values: | Dynamic with maximum value of 4 MB |
| Display: | N/A |
| Change: | N/A |
| Diagnosis: | N/A |
| Tuning: | Does not require tuning because it is dynamically adjusted as needed by the kernel. |

2. msgmnb

| | |
|-------------------|---|
| Purpose: | Specifies maximum number of bytes on queue. |
| Values: | Dynamic with maximum value of 4 MB |
| Display: | N/A |
| Change: | N/A |
| Diagnosis: | N/A |
| Tuning: | Does not require tuning because it is dynamically adjusted as needed by the kernel. |

3. msgmni

Purpose: Specifies maximum number of message queue IDs.
Values: Dynamic with maximum value of 131072
Display: N/A
Change: N/A
Diagnosis: N/A
Tuning: Does not require tuning because it is dynamically adjusted as needed by the kernel.

4. msgmnm

Purpose: Specifies maximum number of messages per queue.
Values: Dynamic with maximum value of 524288
Display: N/A
Change: N/A
Diagnosis: N/A
Tuning: Does not require tuning because it is dynamically adjusted as needed by the kernel.

5. semaem

Purpose: Specifies maximum value for adjustment on exit.
Values: Dynamic with maximum value of 16384
Display: N/A
Change: N/A
Diagnosis: N/A
Tuning: Does not require tuning because it is dynamically adjusted as needed by the kernel.

6. semmni

Purpose: Specifies maximum number of semaphore IDs.
Values: Dynamic with maximum value of 131072
Display: N/A
Change: N/A
Diagnosis: N/A
Tuning: Does not require tuning because it is dynamically adjusted as needed by the kernel.

7. semmsl

Purpose: Specifies maximum number of semaphores per ID.
Values: Dynamic with maximum value of 65535
Display: N/A
Change: N/A
Diagnosis: N/A
Tuning: Does not require tuning because it is dynamically adjusted as needed by the kernel.

8. semopm

Purpose: Specifies maximum number of operations per **semop()** call.

Values: Dynamic with maximum value of 1024
Display: N/A
Change: N/A
Diagnosis: N/A
Tuning: Does not require tuning because it is dynamically adjusted as needed by the kernel.

9. **semume**

Purpose: Specifies maximum number of undo entries per process.
Values: Dynamic with maximum value of 1024
Display: N/A
Change: N/A
Diagnosis: N/A
Tuning: Does not require tuning because it is dynamically adjusted as needed by the kernel.

10. **semvmx**

Purpose: Specifies maximum value of a semaphore.
Values: Dynamic with maximum value of 32767
Display: N/A
Change: N/A
Diagnosis: N/A
Tuning: Does not require tuning because it is dynamically adjusted as needed by the kernel.

11. **shmmax**

Purpose: Specifies maximum shared memory segment size.
Values: Dynamic with maximum value of 256 MB for 32-bit processes and 0x80000000u for 64-bit
Display: N/A
Change: N/A
Diagnosis: N/A
Tuning: Does not require tuning because it is dynamically adjusted as needed by the kernel.

12. **shmmin**

Purpose: Specifies minimum shared-memory-segment size.
Values: Dynamic with minimum value of 1
Display: N/A
Change: N/A
Diagnosis: N/A
Tuning: Does not require tuning because it is dynamically adjusted as needed by the kernel.

13. **shmmni**

Purpose: Specifies maximum number of shared memory IDs.
Values: Dynamic with maximum value of 131072
Display: N/A

| | |
|-------------------|---|
| Change: | N/A |
| Diagnosis: | N/A |
| Tuning: | Does not require tuning because it is dynamically adjusted as needed by the kernel. |

Network Tunable Parameters

Following are network parameters, grouped into the following sections:

- Network Option Tunable Parameters
- NFS Option Tunable Parameters
- Streams Tunable Attributes

Network Option Tunable Parameters

Most of the network option tunable parameters are fully described in the **no** man page. The following are a few other related parameters:

1. **maxmbuf**

| | |
|-------------------|---|
| Purpose: | Maximum Kbytes of real memory allowed for Mbufs. |
| Values: | Default: 0, Range: x to y |
| Display: | lsattr -E -l sys0 -a maxmbuf |
| Change: | chdev -l sys0 -a maxmbuf=NewValue Change is effective immediately and is permanent. If the -T flag is used, the change is immediate and lasts until the next boot. If the -P flag is used, the change is deferred until the next boot and is permanent. |
| Diagnosis: | N/A |
| Tuning: | If maxmbuf is greater than 0, the maxmbuf value is used regardless of the value of thewall . The upper limit on mbufs is the higher value of maxmbuf or thewall . |
| Refer to: | Tuning Network Memory |

2. **MTU**

| | |
|-------------------|---|
| Purpose: | Limits the size of packets that are transmitted on the network. |
| Values: | Default: configuration-dependent |
| Display: | lsattr -E -l interface_name |
| Change: | chdev -l interface_name -a mtu=NewValue With the chdev command, the interface cannot be changed while it is in use. Change is effective across reboots. An alternate method is as follows: ifconfig interface_name mtu NewValue This changes the MTU size on a running system, but will not preserve the value across a system reboot. |
| Diagnosis: | Packet fragmentation statistics. |
| Tuning: | Increase MTU size for the network interfaces. For the Gigabit Ethernet adapter use the device attribute jumbo_frames=yes to enable jumbo frames (just setting MTU to 9000 on the interface is not enough). |
| Refer to: | Tuning TCP and UDP Performance |

3. rfc1323

| | |
|-------------------|--|
| Purpose: | Enables TCP enhancements as specified by RFC 1323 (TCP Extensions for High Performance). Value of 1 indicates that tcp_sendspace and tcp_recvspace can exceed 64 KB. |
| Values: | Default: 0; Range 0 to 1 |
| Display: | Isattr -EI interface or ifconfig interface |
| Change: | ifconfig interface rfc1323 NewValue OR chdev -l interface -a rfc1323=NewValue The ifconfig command sets values temporarily, making it useful for testing. The chdev command alters the ODM, so custom values return after system reboots. |
| Diagnosis: | N/A |
| Tuning: | The default value of 0 disables the RFC enhancements on a systemwide scale. A value of 1 specifies that all TCP connections will attempt to negotiate the RFC enhancements. The SOCKETS application can override the default behavior on individual TCP connections, using the setsockopt() subroutine. This is a run-time attribute. Make changes before attempting to set tcp_sendspace and tcp_recvspace to more than 64 KB. |
| Refer to: | TCP Socket Buffer Tuning |

4. tcp_mssdflt

| | |
|-------------------|--|
| Purpose: | Default maximum segment size used in communicating with remote networks. |
| Values: | Default: 512 bytes |
| Display: | Isattr -EI interface or ifconfig interface |
| Change: | ifconfig interface tcp_mssdflt NewValue OR chdev -l interface -a tcp_mssdflt=NewValue The ifconfig command sets values temporarily, making it useful for testing. The chdev command alters the ODM, so custom values return after system reboots. |
| Diagnosis: | N/A |
| Tuning: | For AIX 4.2.1 or later, tcp_mssdflt is only used if path MTU discovery is not enabled or path MTU discovery fails to discover a path MTU. Limiting data to (MTU - 52) bytes ensures that, where possible, only full packets will be sent. This is a run-time attribute. |
| Refer to: | Tuning TCP Maximum Segment Size |

5. tcp_nodelay

| | |
|-------------------|--|
| Purpose: | Specifies that sockets using TCP over this interface follow the Nagle algorithm when sending data. By default, TCP follows the Nagle algorithm. |
| Values: | Default: 0; Range: 0 or 1 |
| Display: | Isattr -EI interface or ifconfig interface |
| Change: | ifconfig interface tcp_nodelay NewValue OR chdev -l interface -a tcp_nodelay=NewValue The ifconfig command sets values temporarily, making it useful for testing. The chdev command alters the ODM, so custom values return after system reboots. |
| Diagnosis: | N/A |
| Tuning: | This is an Interface-Specific Network Option (ISNO) option. |
| Refer to: | Interface-Specific Network Options (ISNO) |

6. tcp_recvspace

- Purpose:** Specifies the system default socket buffer size for receiving data. This affects the window size used by TCP.
- Values:** Default: 16384 bytes
- Display:** **lsattr -El interface** or **ifconfig interface**
- Change:** **ifconfig interface tcp_recvspace NewValue**
OR
chdev -l interface -a tcp_recvspace=NewValue
The **ifconfig** command sets values temporarily, making it useful for testing. The **chdev** command alters the ODM, so custom values return after system reboots.
- Diagnosis:** N/A
- Tuning:** Setting the socket buffer size to 16 KB (16,384) improves performance over standard Ethernet and Token-Ring networks. The default is a value of 16384. Lower bandwidth networks, such as Serial Line Internet Protocol (SLIP), or higher bandwidth networks, such as Serial Optical Link, should have different optimum buffer sizes. The optimum buffer size is the product of the media bandwidth and the average round-trip time of a packet.
- The **tcp_recvspace** attribute must specify a socket buffer size less than or equal to the setting of the **sb_max** attribute. This is a dynamic attribute, but for daemons started by the **inetd** daemon, run the following commands: **stopsrc -s inetd ; startsrc -s inetd**
- Refer to:** TCP Socket Buffer Tuning

7. tcp_sendspace

- Purpose:** Specifies the system default socket buffer size for sending data.
- Values:** Default: 16384 bytes
- Display:** **lsattr -El interface** or **ifconfig interface**
- Change:** **ifconfig interface tcp_sendspace NewValue**
OR
chdev -l interface -a tcp_sendspace=NewValue
The **ifconfig** command sets values temporarily, making it useful for testing. The **chdev** command alters the ODM, so custom values return after system reboots.
- Diagnosis:** N/A
- Tuning:** This affects the window size used by TCP. Setting the socket buffer size to 16 KB (16,384) improves performance over standard Ethernet and Token-Ring networks. The default is a value of 16,384. Lower bandwidth networks, such as Serial Line Internet Protocol (SLIP), or higher bandwidth networks, such as Serial Optical Link, should have different optimum buffer sizes. The optimum buffer size is the product of the media bandwidth and the average round-trip time of a packet:
$$\text{optimum_window} = \text{bandwidth} * \text{average_round_trip_time}$$

The **tcp_sendspace** attribute must specify a socket buffer size less than or equal to the setting of the **sb_max** attribute. The **tcp_sendspace** parameter is a dynamic attribute, but for daemons started by the **inetd** daemon, run the following commands: **stopsrc -s inetd ; startsrc -s inetd**
- Refer to:** TCP Socket Buffer Tuning

8. use_sndbufpool

- Purpose:** Specifies whether send buffer pools should be used for sockets.
- Values:** Default: 1

Display: `netstat -m`
Change: This option can be enabled by setting the value to 1 or disabled by setting the value to 0.
Diagnosis: N/A
Tuning: It is a load time, boolean option.

9. xmt_que_size

Purpose: Specifies the maximum number of send buffers that can be queued up for the interface.
Values: Default: configuration-dependent
Display: `lsattr -E -l interface_name`
Change: `ifconfig interface_name detach`
`chdev -l interface_name -aque_size_name=NewValue`
`ifconfig interface_name hostname up`
 Cannot be changed while the interface is in use. Change is effective across reboots.
Diagnosis: `netstat -i (0err > 0)`
Tuning: Increase size.
Refer to: The netstat Command

NFS Option Tunable Parameters

Most of the NFS option tunable parameters are fully described in the **nfs** man page. The following are a few other related parameters:

1. biod Count

Purpose: Number of biod processes available to handle NFS requests on a client.
Values: Default: 6; Range: 1 to any positive integer
Display: `ps -efa | grep biod`
Change: `chnfs -b NewValue`
 Change normally takes effect immediately and is permanent. The **-N** flag causes an immediate, temporary change. The **-I** flag causes a change that takes effect at the next boot.
Diagnosis: `netstat -s` to look for UDP socket buffer overflows.
Tuning: Increase number until socket buffer overflows cease.
Refer to: How Many biod and nfsd Daemons Are Needed?

2. combehind

Purpose: Enables commit-behind behavior on the NFS client when writing very large files over NFS Version 3 mounts.
Values: Default: 0; Range: 0 to 1
Display: `nfsstat -m`
Change: `mount -o combehind`
Diagnosis: Poor throughput when writing very large files (primarily files larger than the amount of system memory in the NFS client) over NFS Version 3 mounts.
Tuning: Use this mount option on the NFS client if the primary use of NFS is to write very large files to the NFS server. Note that an undesirable feature of this option is that VMM caching of NFS file data is effectively disabled on the client. Therefore, use of this option is discouraged in environments where good NFS read performance is necessary.

3. nfsd Count

| | |
|-------------------|---|
| Purpose: | Specifies the maximum number of NFS server threads that are created to service incoming NFS requests. |
| Values: | Default: 3891; Range: 1 to 3891 |
| Display: | ps -efa grep nfsd |
| Change: | chnfs -n <i>NewValue</i> Change takes effect immediately and is permanent. The -N flag causes an immediate, temporary change. The -I flag causes a change that takes effect at the next boot. |
| Diagnosis: | See nfs_max_threads |
| Tuning: | See nfs_max_threads |
| Refer to: | How Many biod and nfsd Daemons Are Needed? |

4. numclust

| | |
|-------------------|---|
| Purpose: | Used in conjunction with the combehind option to improve write throughput performance when writing large files over NFS Version 3 mounts. |
| Values: | Default: 128; Range: 8 to 1024 |
| Display: | ps -efa grep nfsd |
| Change: | chnfs -n <i>NewValue</i> Change takes effect immediately and is permanent. The -N flag causes an immediate, temporary change. The -I flag causes a change that takes effect at the next boot. |
| Diagnosis: | Poor throughput when writing very large files (primarily files larger than the amount of system memory in the NFS client) over NFS Version 3 mounts. |
| Tuning: | Use this mount option on the NFS client if the primary use of NFS is to write very large files to the NFS server. The value basically represents the minimum number of pages for which VMM will attempt to generate a commit operation from the NFS client. Too low a value can result in poor throughput due to an excessive number of commits (each of which results in synchronous writes on the server). Too high a value can also result in poor throughput due to the NFS client memory filling up with modified pages which can cause the LRU daemon to be invoked to start reclaiming pages. When the lrud runs, V3 writes essentially become synchronous because each write ends up being accompanied by a commit. This situation can be avoided by using the numclust and combehind options. |

Streams Tunable Attributes

The complete listing of the streams tunable attributes is located in the **no** man page.

Appendix G. Test Case Scenarios

Performance tuning is highly system- and application-dependent, however, there are some general tuning methods that will work on almost any AIX system.

This appendix contains actual test cases from AIX users. If you have a similar scenario in your own environment, use the information in these test cases to help you. Each case describes the type of system and the problem that was encountered. It goes on to explain how to test for the particular performance problem and how to resolve the problem if it is detected.

This appendix contains the following test cases:

- Improving NFS Client Large File Writing Performance
- Improving Tivoli® Storage Manager (TSM) Backup Performance
- Streamlining Security Subroutines with Password Indexing

Improving NFS Client Large File Writing Performance

Things to Consider

The information in this how-to was tested using AIX 5.2. If you are using a different version or level of AIX, the results you obtain might vary significantly.

Writing large, sequential files over an NFS-mounted file system can cause a severe decrease in the file transfer rate to the NFS server. In this scenario, you identify whether this situation exists and use the steps to remedy the problem.

Assume the system is running an application that sequentially writes very large files (larger than the amount of physical memory on the machine) to an NFS-mounted file system. The file system is mounted using NFS V3. The NFS server and client communicate over a 100 MB per second Ethernet network. When sequentially writing a small file, the throughput averages around 10 MB per second. However, when writing a very large file, the throughput average drops to well under 1 MB per second.

The application's large file write is filling all of the client's memory, causing the rate of transfer to the NFS server to decrease. This happens because the client AIX system must invoke the LRUD **kproc** to release some pages in memory to accommodate the next set of pages being written by the application.

Use either of the following methods to detect if you are experiencing this problem:

- While a file is being written to the NFS server, run the **nfsstat** command periodically (every 10 seconds) by typing the following:

```
nfsstat
```

Check the **nfsstat** command output. If the number of V3 commit calls is increasing nearly linearly with the number of V3 write calls, it is likely that this is the problem.

- Use the **topas** command (located in the **bos.perf.tools** fileset) to monitor the amount of data per second that is being sent to the NFS server by typing the following:

```
topas -i 1
```

If either of the methods listed indicate that the problem exists, the solution is to use the new **mount** command option called **combehind** when mounting the NFS server file system on the client system. Do the following:

1. When the file system is not active, unmount it by typing the following:

```
umount /mnt
```

(assumes /mnt is local mount point)

2. Remount the remote file system by using the **mount** command option called **comebehind**, as follows:

```
mount -o comebehind server_hostname:/remote_mount_point /mnt
```

Improve Tivoli Storage Manager (TSM) Backup Performance

Things to Consider

The information in this how-to was tested using AIX 5.2. If you are using a different version or level of AIX, the results you obtain might vary significantly.

In this scenario, you will identify and correct a system performance problem that could be increasing your backup time when using Tivoli Storage Manager (TSM).

The scenario environment consists of two systems: one TSM client machine used as a database server, and a TSM backup server. The client machine is connected to the TSM backup server with point-to-point Ethernet running at 1 GB per second. The **backint** application, which is a multi-threaded TSM backup program for SAP database environments, runs on the client using the TSM backup APIs.

After upgrading both the TSM server and client machines from AIX 4.3.3, Maintenance Level 04 to Maintenance Level 09, and upgrading from TSM Version 3 to TSM Version 4, the time to backup the database on the client using the **backint** application increased from 7 hours to 15 hours.

To determine the cause of the performance degradation and improve TSM backup performance, do the following:

1. Test the network throughput performance by using the **ftp** and **dd** commands from the TSM client machine. Perform a memory-to-memory transfer to eliminate disk operations in either the client or server by running the following:

```
# ftp <hostname_of_TSM_server>
ftp> bin
ftp> put "| dd if=/dev/zero bs=32k count=10000" /dev/null
```

In this scenario, the **ftp** and **dd** command output revealed a network throughput of about 81 MB per second, which indicates that the network itself is not an issue. (If the network had been at fault, the **netstat** tool would have been the next logical step.)

2. Test the client backup program capabilities by using the **backint** application as follows:
 - a. Examine any parameters used by the application to understand how it works and interacts with AIX. In this scenario, the **backint** application was seen to be using sequential **read()** calls of 128k each to get the data from disk on the client machine.
 - b. While the **backint** application is running, use the **ps -eflm** command to determine if the application is single or multi-threaded. The **ps** command output gives one line of output per thread in a process. The **backint** application was seen to be multi-threaded and the number of threads was tunable. Each thread reads from a different file being backed up, and all the data is sent to the TSM server to be written to tape.
3. Tune AIX to match what the application is doing as follows:
 - a. Use the **ioo** command to change the amount of data actually read from disk by AIX in a single I/O when the calling application is doing sequential **read()** calls.

In this scenario, the **ioo** parameter is **maxpgahead** because the files were stored in a journaled file system (JFS) and not an enhanced journaled file system (JFS2). The default for this parameter is 8, which means read, at most, eight 4 KB blocks (32 KB total) of data into memory with a single I/O operation. Because the **backint** application asks to get 128 KB on each **read()** call, use the following command to tell AIX to read as much as 128 KB in a single I/O when sequential **read()** operations are being done:

```
ioo -o maxpgahead=32
```

- b. Use the **iostat 1** and **vmstat 1** commands to monitor the client machine. While a backup is in progress, enter the following:

```
iostat 1  
vmstat 1
```

In this example, the list of available pages in AIX (the freelist = fre column in the **vmstat** command output) was approaching zero at times. AIX will not function smoothly if the freelist gets too small.

- c. Use the **vmo -o minfree -o maxfree** command to increase the minimum and maximum size of the freelist that AIX will try to maintain. The formulas to determine the **minfree** and **maxfree** values are:

minfree = 120 multiplied by the number of processors (12 in our case) or $[120*12]$

and

maxfree = 120 + **maxpgahead** (32) multiplied by the number of processors or $[(120 + 32)*12]$.

Tune AIX by running the following command:

```
vmo -o minfree=1440 -o maxfree=1824
```

- d. Use the **iostat 1** and **vmstat 1** commands again to monitor another backup session. In this scenario, the freelist was okay at all times and throughput improved dramatically so that backup now takes just 8 hours.
4. Perform additional application tuning (if possible) by using the **iostat 1** and **vmstat 1** commands to monitor another backup session.

Note: In step 3d, above, the **iostat** data showed that additional processor cycles and disk bandwidth were still available, so the **backint** application parameters were modified to add an additional concurrent thread during backup.

Overall backup time has now decreased to under 7 hours.

For More Information

The **iostat**, **netstat**, **ps**, **vmstat**, **ioo** and **vmo** commands.

Streamline Security Subroutines with Password Indexing

Things to Consider

The information in this how-to was tested using AIX 5.2. If you are using a different version or level of AIX, the results you obtain might vary significantly.

In this scenario, you will verify that you have a high number of security subroutine processes and then reduce the amount of processor time used for security subroutines by indexing the password file.

The scenario environment consists of one 2-way system used as a mail server. Mail is received remotely through POP3 (Post Office Protocol Version 3) and by local mail client with direct login on the server. Mail is sent by using the **sendmail** daemon. Because of the nature of a mail server, a high number of security subroutines are called for user authentication. After moving from a uniprocessor machine to the 2-way system, the **uptime** command returned 200 processes, compared to less than 1 on the uniprocessor machine.

To determine the cause of the performance degradation and reduce the amount of processor time used for security subroutines, do the following:

1. Determine which processes consume a high percentage of processor time and whether the majority of processor time is spent in kernel or user mode by running the following command (located in the **bos.perf.tools** fileset):

```
topas -i 1
```

The **topas** command output in our scenario indicated that the majority of processor time, about 90%, was spent in user mode and the processes consuming the most processor time were **sendmail** and **pop3d**. (Had the majority of processor usage been kernel time, a kernel trace would be the appropriate tool to continue.)

2. Determine whether the user-mode processor time is spent in application code (user) or in shared libraries (shared) by running the following command to gather data for 60 seconds:

```
tprof -ske -x "sleep 60"
```

The **tprof** command lists the names of the subroutines called out of shared libraries and is sorted by the number of processor ticks spent for each subroutine. The **tprof** data, in this case, showed most of the processor time in user mode was spent in the **libc.a** system library for the security subroutines (and those subroutines called by them). (Had the **tprof** command shown that user-mode processor time was spent mostly in application code (user), then application debugging and profiling would have been necessary.)

3. To avoid having the **/etc/passwd** file scanned with each security subroutine, create an index for it by running the following command:

```
mkpasswd -f
```

By using an indexed password file, the load average for this scenario was reduced from a value of 200 to 0.6.

For More Information

- The **topas**, **tprof**, and **uptime** commands.
- The **pop3d** and **sendmail** daemons.

Index

A

- about this book vii
- accessing POWER timer registers 362
- accessing POWER-based timer registers 363
- accessing the processor timer 361
- ACT_TIMEOUT 371
- adapter statistics 275
- adapter transmit and receive queue tuning 234
- administration
 - CPU-efficient
 - user ID 119
- affinity
 - processor 61
- AIXTHREAD_COND_DEBUG 371
- AIXTHREAD_ENRUSG 372
- AIXTHREAD_GUARDPAGES 372
- AIXTHREAD_MINKTHREADS 372
- AIXTHREAD_MNRATIO 373
- AIXTHREAD_MUTEX_DEBUG 373
- AIXTHREAD_READ_GUARDPAGES 373
- AIXTHREAD_RWLOCK_DEBUG 374
- AIXTHREAD_SCOPE 374
- AIXTHREAD_SLPRATIO 374
- AIXTHREAD_STK=n 375
- allocation and reclamation of paging space slots 49
- alstat tool 112
- Amdahl's law 64
- analyzing performance with the trace facility 337
- application
 - parallelizing 56
- application tuning 323
- assessing memory requirements 134
- asynchronous I/O tunable parameters 386
- attributes
 - file 201
 - logical volume
 - changing 178
 - tunable
 - streams 394

B

- benchmarking
 - performance 11
- binding
 - processor 61
- biod Count 393
- biod daemon 9

C

- C and C++ coding style 87
- cache
 - effective use 83
 - fast write 192
 - limiting enhanced JFS 147
 - limiting persistent file 147

- cache and TLBs 85
- cache coherency 60
- CacheFS 301
- caches 4
- calls
 - sync/fsync 187
- CD ROM file system 194
- code-optimization techniques 331
- coherency
 - cache 60
- combehind 393
- commands
 - bindprocessor 72
 - considerations 73
- cautions
 - time and timex 107
- CPU
 - acctcom 109
 - iostat 101
 - ps 107
 - sar 102
 - time 106
 - vmstat 99
- disk
 - filemon 168
 - filespace 166
 - lslv 164, 165
 - sar 163
 - vmstat 162, 167, 168
- disk I/O
 - iostat 160
- examples 359
- fdpr 330
- filemon
 - global reports 171
- ftp 248
- id 359
- ipfilter 274
- ipreport 274
- memory
 - interpreting rmss results 138
 - ps 124
 - rmss 134
 - rmss guidelines 140
 - schedo 140
 - svmon 125
 - vmo 143
 - vmstat 121
- mkpasswd 119
- monitoring and tuning 353
- netpmon 264
- netstat 249
- nfsstat 288
- no 278
- performance analysis 353
- performance reporting 353
- performance tuning 356
- ping 247

- commands *(continued)*
 - pprof 109
 - schedo 150
 - schedtune -s 73
 - traceroute 272
 - vmtune 149
- compiler execution time 88
- compiler optimization techniques 323
- compiling for floating-point performance (-qfloat) 326
- compiling for specific hardware platforms 87, 325
- compiling with optimization 324
- components
 - workload
 - identifying 75
- compression 198
- concurrent I/O 301
- configuration
 - expanding 188
- considerations
 - programming 369
- contention
 - memory and bus 61
- CPU
 - determining speed 365
 - monitoring 99
 - performance 99
- CPU options 103
- CPU time ratio 108
- CPU-intensive programs
 - identifying 107
- CPU-limited programs 82
- critical resources
 - identifying 9
 - minimizing requirements 10
- cross invalidate 60
- currently dispatched threads 5

D

- daemons
 - cron 103
- data serialization 57
- deferred allocation algorithm 50
- designing and implementing efficient programs 82
- determining CPU speed 365
- DIO 301
- direct I/O 301
 - performance
 - reads 210
 - writes 210
 - tuning 210
- directory organization 195
- disk adapter outstanding-requests limit 387
- disk and disk adapter tunable parameters 387
- disk drive queue depth 387
- disk I/O
 - assessing disk performance 160
 - assessing overall 168
 - asynchronous
 - tuning 207
 - detailed analysis 168

- disk I/O *(continued)*
 - monitoring 159
 - monitoring and tuning 159
 - pre-tuning baseline 159
 - raw 187
 - summary 176
 - wait time reporting 160
- disk I/O pacing 212
- disk mirroring 93
 - striped 93
- disk striping
 - designing 186
 - tuning logical volume 185
- dispatchable threads 5

E

- early allocation algorithm 50
- efficient use of the id command 359
- environment variables 371
- estat 278
- examples
 - second subroutine 363
- executable programs 5
- execution model
 - program 2
- execution time
 - compiler 88
- expanding procedure calls inline (-Q) 326
- EXTSHM 379

F

- facility
 - trace 339
- file data 296
- file syncs
 - tuning 208
- file system
 - buffers 208
 - cache 304
 - monitoring and tuning 193
 - performance tuning 205
 - reorganization 203
- file systems
 - monitoring and tuning 193
 - types 193
- filemon reports 171
- files
 - attributes
 - changing for performance 201
 - compression 203
 - fragment size 202
 - mapped 332
- finding memory-leaking programs 133
- fixed disks 3
- fixed-disk storage management
 - performance overview 51
- fork () retry interval parameter
 - tuning 150
- fragmentation 198

- fragmentation (*continued*)
 - disk
 - assessing 164
- free list 44
- ftp 248

G

- garbage collection
 - java 335
- GPFS 194
- granularity
 - lock 58
- guidelines
 - performance
 - communications preinstallation 93
 - CPU preinstallation 90
 - disk preinstallation 90
 - installation 90
 - memory preinstallation 90
 - operating system preinstallation 90

H

- hand tuning 323
- hardware hierarchy 3
- hierarchy
 - hardware 3
 - caches 4
 - fixed disks 3
 - pipeline and registers 4
 - real memory 4
 - translation lookaside buffer 4
 - software 4
 - current instructions 6
 - currently dispatched threads 5
 - dispatchable threads 5
 - executable programs 5
 - interrupt handlers 5
 - waiting threads 5
- How-to
 - improve TSM backup performance 396

I

- I/O
 - communications
 - monitoring and tuning 215
- identifying critical resources 9
 - CPU 9
 - disk space 9
 - memory 9
 - network access 9
- identifying workload components 75
- identifying workloads 8
- initial settings of SP tunable parameters 281
- instruction emulation
 - detecting 111, 112
- interface-specific network options 222
- interprocess communication tunable parameters 387
- interrupt handlers 5

- introducing the performance-tuning process 7
- introduction to multiprocessing 55
- IP performance tuning 242
- iso 9000 vii

J

- java
 - advantages 333
 - guidelines 333
 - monitoring 333
- Java 334
- java monitoring tools 334
- java performance guidelines 333
- JFS 193
- JFS and Enhanced JFS
 - differences 194
- JFS and enhanced JFS tunable parameters 201
- JFS2 194
- journaled file system
 - reorganizing 211
- journaling 195

K

- kernel
 - tunable parameters 383
- kernel threads
 - CPU usage
 - measuring 109
- kernel tunable parameters 383

L

- late allocation algorithm 50
- LDR_CNTRL 379
- levels of optimization 86
- libraries
 - BLAS 329
 - ESSL 329
 - prebound subroutine 359
- link order
 - specifying 328
- linking
 - dynamic 327
 - static 327
- locale
 - national language support 369
 - setting 370
- locks
 - complex 58
 - granularity 58
 - overhead 59
 - simple 58
 - types of 57
 - waiting for 60
- log logical volume
 - creating 211
 - reorganizing 211
- logical volume
 - allocation 181

- logical volume (*continued*)
 - attributes
 - changing for performance 178
 - designing 186
 - mirror write consistency 180
 - mirrored 187
 - relocation 181
 - reorganizing 183
 - scheduling policy 181
 - striping size 181
 - tuning 185
 - I/O 186
 - write verify 181
- lvmo 181
- lvostat 177

M

- MALLOCBUCKETS 375
- MALLOCMULTIHEAP 376
- management
 - real-memory 43
- managing tunable SP parameters 280
- mapped files 332
- maxbuf 384
- maxclient 147
- maximum caching
 - file data 296
 - NFS file data 300
- maxmbuf 390
- maxperm 147
- maxreqs 386
- maxservers 386
- maxuproc 383
- measuring CPU usage of kernel threads 109
- measuring CPU use 106
- memory
 - AIX Memory Affinity Support 153
 - assessing requirements 134
 - computational versus file 45
 - determining use 121
 - extended shared 152
 - monitoring and tuning 121
 - placement 154, 155
 - requirements
 - calculating minimum 133
 - using shared 152
 - who is using 128
- memory and bus contention 61
- memory load control algorithm 48
- memory load control facility
 - VMM 48
- memory load control tuning 140
 - the h parameter 141
 - the m parameter 142
 - the p parameter 142
 - the v_exempt_secs parameter 143
 - the w parameter 143
- memory mapped files 199
- memory placement 154, 155
- memory use determination 121

- memory-limited programs 88
- methods
 - choosing page space allocation 148
- minfree and maxfree settings 144
- minimizing critical-resource requirements 10
- minperm 147
- minperm and maxperm settings 146
- minservers 386
- mirroring
 - disk 93
 - striped 93
- mode switching 42
- model
 - program execution 2
- monitoring and tuning commands and subroutines 353
- monitoring and tuning communications I/O use 215
- monitoring and tuning disk I/O use 159
- monitoring and tuning file systems 193
- monitoring and tuning memory use 121
- monitoring and tuning NFS 283
- monitoring disk I/O 159
- monitoring java 333
- mountd 283
- msgmax 387
- msgmnb 387
- msgmni 388
- msgmnm 388
- MTU 390
- multiprocessing
 - introduction to 55
 - types of 55
 - shared disks 56
 - shared memory 56
 - shared memory cluster 56
 - shared nothing (pure cluster) 55

N

- name resolution tuning 246
- national language support (NLS)
 - locale versus speed 369
- ncargs 384
- netstat 249
- network
 - tunable parameters 390
- network file system (NFS)
 - analyzing performance 287
 - monitoring and tuning 283
 - overview 283
 - references 307
 - version 3 285
- network performance analysis 247
- network tunable parameters 390
 - maxmbuf 390
 - MTU 390
 - option 390
 - rfc1323 391
- NFS 194
 - see network file system (NFS) 283, 287
 - tuning 295
 - client 299

- NFS (*continued*)
 - tuning (*continued*)
 - server 295
- NFS client
 - tuning 299
- NFS data caching
 - read throughput 301
 - write throughput 301
- NFS data caching effects 301
- NFS file data 300
- NFS option tunable parameters 393
- nfsd 283
- nfsd Count 394
- nfsd threads 296, 299
 - number 296, 299
- nice 66, 114
- NLS
 - see national language support (NLS) 369
- NODISCLAIM 382
- non-shared 305
- npswarn and npskill settings 149
- NSORDER 382
- NUM_RUNQ 377
- NUM_SPAREVP 377
- numclust 394

O

- objectives
 - performance 2
 - setting 8
- optimizing processors for FORTRAN and C 331
- options
 - thread 108
 - useful CPU 103
- outputs
 - correlating svmon and ps 132
 - correlating svmon and vmstat 131
- overhead
 - locking 59
 - reducing memory scanning 146

P

- pacing
 - disk I/O 212
- page replacement 45
- page space allocation
 - deferred 148
 - early 149
 - late 149
- page space allocation methods 148
- paging space and virtual memory 149
- paging space slots
 - allocation and reclamation 49
- paging spaces
 - placement and sizes 92
- paging-space
 - assessing I/O 167
 - tuning 149

- parameter
 - j2_nBufferPerPagerDevice 209
 - lvm_bufcnt 209
 - numfsbufs 209
 - pd_npages 209
 - v_pinshm 209
- parameters
 - tunable 384
 - asynchronous I/O 386
 - disk and disk adapter 387
 - interprocess communication 387
 - kernel 383
 - miscellaneous 379
 - network 390
 - scheduler 383
 - summary 371
 - synchronous I/O 384
 - thread support 371
 - virtual memory manager 384
- PDT
 - see performance diagnostic tool (PDT) 349
- performance
 - disk
 - assessing 162, 163
 - CPU report 161
 - drive report 161
 - tty report 161
 - disk mirroring 93
 - disk or memory determination 32
 - implementing 75
 - installation guidelines 90
 - issues
 - SMP 61
 - network
 - analysis 247
 - objectives 2
 - planning for 75
 - problem diagnosis 27
 - slowdown
 - specific program 27
 - subroutines 357
 - tuning
 - TCP and UDP 215
- performance analysis commands 353
- performance benchmarking 11
- performance concepts 7, 95
- performance diagnostic tool (PDT)
 - measuring the baseline 349
- performance enhancements
 - JFS and enhanced JFS 198
- performance inhibitors 198
- performance monitoring
 - LVM 177, 181
- performance overview 1
- performance problem
 - description 350
 - reporting 350
- performance problems
 - reporting 349
- performance reporting commands 353

- performance requirements
 - documenting 76
- performance tuning commands 356
- performance-related installation guidelines 90
- performance-related subroutines 357
- performance-tuning
 - introducing 7
- physical volume
 - considerations 182
 - maximum number 180
 - position 178
 - range 179
- ping 247
- pinned storage
 - misuse of 90
- pipeline and registers 4
- placement
 - assessing file 166
 - assessing physical data 165
- planning and implementing for performance 75
- platforms
 - compiling for specific 87
- portmap 283
- POWER-based-architecture-unique timer access 362
- prebound subroutine libraries 359
- preprocessors and compilers
 - effective use of 86
- previously captured data
 - display 102
- priority
 - process and thread 38
- problems
 - performance
 - reporting 349
- process 65
 - priority 38
- processes and threads 37
- processor affinity and binding 61
- processor scheduler
 - performance overview 37
- processor time slice
 - scheduler 42
- processor timer
 - accessing 361
- profile directed feedback (PDF) 330
- program execution model 2
- programming considerations 369
- programs
 - CPU-intensive
 - identifying 107
 - efficient
 - cache 83
 - cache and TLBs 85
 - CPU-limited 82
 - designing and implementing 82
 - levels of optimization 86
 - preprocessors and compilers 86
 - registers and pipeline 84
 - executable
 - restructuring 113
 - fdpr 113

- programs (*continued*)
 - finding memory-leaking 133
 - memory-limited 88
 - rebindable executable 359
 - xmpert 106
- ps command 124
- PSALLOC 382

Q

- queue limits
 - disk device 188
 - scsi adapter 188

R

- RAID
 - see redundant array of independent disks (RAID) 189
- RAM 4
- RAM disk
 - file system 194
- random write behind 207
- real memory 4
- real-memory management 43
- rebindable executable programs 359
- redundant array of independent disks (RAID) 189
 - levels 189
 - summary 191
- registers and pipeline 4, 84
- related publications vii
- release-behind 301
- renice 66
- repaging 46
- reporting performance problems 349
- reports
 - filemon 171
- requirements
 - performance
 - documenting 76
 - workload
 - resource 76
- resource allocation
 - reflecting priorities 10
- resource management overview 37
- resources
 - applying additional 11
 - critical
 - identifying 9
- response time 2
 - SMP 62, 64
- restructuring executable programs 113
- rfc1323 391
- RPC lock daemon 296
 - tuning 296
- RPC mount daemon 296
 - tuning 296
- RT_GRQ 382
- RT_MPC 383
- rules
 - simplifying 370

- run queue
 - scheduler 41

S

- scalability
 - multiprocessor throughput 63
- scaling 195
- scenarios 395
- scheduler
 - processor 37
 - processor time slice 42
 - run queue 41
- scheduler tunable parameters 383
- scheduling
 - SMP thread 65
 - algorithm variables 66
 - default 66
 - thread 40
- second subroutine example 363
- segments
 - persistent versus working 44
- semaem 388
- semgni 388
- semmsl 388
- semopm 388
- semume 389
- semvmx 389
- sequential read performance 205
- sequential write behind 206
- serial storage architecture (SSA) 191
- serialization
 - data 57
- setpri() 66
- setpriority() 66
- setting objectives 8
- setting the locale 370
- shmmax 389
- shmmni 389
- shmmni 389
- simplifying rules 370
- size
 - read
 - client 300
 - write
 - client 300
- size limits
 - read
 - server 296
 - write
 - server 296
- slow program 27
- SMP
 - see symmetrical multiprocessor (SMP) 55
- SMP performance issues 61
 - response time 62
 - throughput 62
 - workload concurrency 61
- SMP thread scheduling 65
- SMP tools 72
 - the bindprocessor command 72

- SMP workloads 62
 - multiprocessability 62
 - response time 64
 - throughput scalability 63
- snooping 60
- software hierarchy 4
- SP Network tuning 278
- SP network tuning for specific workloads 281
- SP switch statistics 278
- SP system—specific tuning recommendations 279
- space efficiency and sequentiality 166
- specifying cache sizes (-qcache) 326
- speed
 - national language support 369
- SSA
 - see serial storage architecture (SSA) 191
- STEP_TIME 378
- streams tunable attributes 394
- strict_maxperm 147
- structuring
 - pageable code 89
 - pageable data 89
- subroutine
 - libraries
 - prebound 359
- subroutines
 - monitoring and tuning 353
 - performance 357
 - string.h 87
- svmon command 125
- symmetrical multiprocessor (SMP)
 - concepts and architecture 55
- sync/fsync calls 187
- synchronous I/O tunable parameters 384
- system activity accounting 103
- system performance monitoring 21

T

- tcp_mssdflt 391
- tcp_nodelay 391
- tcp_recvspace 392
- tcp_sendspace 227, 392
- test case scenarios 395
- test cases 395
- text highlighting vii
- thread 37, 65
 - priority 38
 - scheduling policy 40
 - support 37
- thread option 108
- thread support tunable parameters 371
- thread tuning 67
- threads
 - environment variables 67
 - debug options 71
 - process-wide contention scope 70
 - tuning summary 71
- kernel
 - measuring CPU usage 109

- threads (*continued*)
 - SMP
 - scheduling 65
 - tuning 67
- threads and processes 37
- thresholds
 - VMM 47
- throughput 2
 - SMP 62
- throughput scalability
 - SMP 63
- time ratio 108
- timer
 - C subroutine 362
 - processor
 - accessing 361
- timer access
 - POWER-based-architecture-unique 362
- timer registers
 - POWER
 - assembler routines 362
 - POWER-based
 - accessing 363
- TLB see translation lookaside buffer 4
- tools
 - alstat 112
 - emstat 111
 - SMP 72
- trace channels 344
- trace data
 - formatting 339
 - limiting 338
 - viewing 339
- trace events
 - adding new 344
- trace facility
 - analyzing performance with 337
 - controlling 338
 - event IDs 345
 - example 339
 - implementing 338
 - report formatting 342
 - starting 338
 - starting and controlling 341, 342
 - understanding 337
- trace file
 - example 339
 - sample
 - formatting 339
 - obtaining 339
- trace report
 - filtering 341
 - reading 340
- translation lookaside buffer 4
- trcrpt 342
- tunable attributes
 - streams 394
- tunable parameters
 - asynchronous I/O 386
 - disk and disk adapter 387
 - interprocess communication 387

- tunable parameters (*continued*)
 - kernel 383
 - miscellaneous 379
 - network 390
 - tcp_mssdfit 391
 - tcp_nodelay 391
 - tcp_recvspace 392
 - tcp_sendspace 392
 - use_sndbufpool 392
 - xmt_que_size 393
 - nfs option 393
 - biod Count 393
 - combehind 393
 - nfsd Count 394
 - numclust 394
 - scheduler 383
 - summary 371
 - synchronous I/O 384
 - thread support 371
 - virtual memory manager 384
- tuning 334
 - adapter queue 234
 - application 323
 - hand 323
 - IP 242
 - mbuf pool 242
 - name resolution 246
 - network memory 244
 - SP network 278
 - system 6
 - TCP and UDP 215
 - TCP maximum segment size 238
 - thread 67
- tuning file systems 205
- tuning logical volume striping 185
- tuning mbuf pool performance 242
- tuning memory pools 145
- tuning paging-space thresholds 149
- tuning TCP and UDP performance 215
- tuning TCP maximum segment size 238
- tuning VMM memory load control 140
- tuning VMM page replacement 143

U

- understanding the trace facility 337
- use_sndbufpool 392
- user ID
 - administration for CPU efficiency 119

V

- variables
 - environment 371
- virtual memory manager
 - tunable parameters 384
- virtual memory and paging space 149
- virtual memory manager (VMM)
 - memory load control facility 48
 - performance overview 43
 - thresholds 47

- virtual memory manager tunable parameters 384
- VMM
 - see virtual memory manager (VMM) 43
- vmstat command 121
- volume group
 - considerations 182
 - mirroring 183
- VP_STEALMAX 378

W

- waiting threads 5
- workload
 - system 1
- workload concurrency
 - SMP 61
- workload multiprocessability
 - SMP 62
- workload resource requirements
 - estimating 76
 - measuring 78
 - new program 80
 - transforming from program level 81
- workloads
 - identifying 8
 - SMP 62
- write behind
 - memory mapped files 199
 - sequential
 - random 206
- write-around 305

X

- xmperf 106
- xmt_que_size 393

Y

- YIELDLOOPTIME 379

Vos remarques sur ce document / Technical publication remark form

Titre / Title : Bull AIX 5L Performance Management Guide

N° Référence / Reference N° : 86 A2 54EM 02

Daté / Dated : October 2005

ERREURS DETECTEES / ERRORS IN PUBLICATION

AMELIORATIONS SUGGEREES / SUGGESTIONS FOR IMPROVEMENT TO PUBLICATION

Vos remarques et suggestions seront examinées attentivement.

Si vous désirez une réponse écrite, veuillez indiquer ci-après votre adresse postale complète.

Your comments will be promptly investigated by qualified technical personnel and action will be taken as required.

If you require a written reply, please furnish your complete mailing address below.

NOM / NAME : _____ Date : _____

SOCIETE / COMPANY : _____

ADRESSE / ADDRESS : _____

Remettez cet imprimé à un responsable BULL ou envoyez-le directement à :

Please give this technical publication remark form to your BULL representative or mail to:

**BULL CEDOC
357 AVENUE PATTON
B.P.20845
49008 ANGERS CEDEX 01
FRANCE**

Technical Publications Ordering Form

Bon de Commande de Documents Techniques

To order additional publications, please fill up a copy of this form and send it via mail to:

Pour commander des documents techniques, remplissez une copie de ce formulaire et envoyez-la à :

BULL CEDOC
ATTN / Mr. L. CHERUBIN
357 AVENUE PATTON
B.P.20845
49008 ANGERS CEDEX 01
FRANCE

Phone / Téléphone : +33 (0) 2 41 73 63 96
FAX / Télécopie : +33 (0) 2 41 73 60 19
E-Mail / Courrier Electronique : srv.Cedoc@franp.bull.fr

Or visit our web sites at: / Ou visitez nos sites web à:

<http://www.logistics.bull.net/cedoc>

<http://www-frec.bull.com> <http://www.bull.com>

| CEDOC Reference # N° Référence CEDOC | Qty Qté | CEDOC Reference # N° Référence CEDOC | Qty Qté | CEDOC Reference # N° Référence CEDOC | Qty Qté |
|--|------------|---|------------|---|------------|
| ____ _ [__] | | ____ _ [__] | | ____ _ [__] | |
| ____ _ [__] | | ____ _ [__] | | ____ _ [__] | |
| ____ _ [__] | | ____ _ [__] | | ____ _ [__] | |
| ____ _ [__] | | ____ _ [__] | | ____ _ [__] | |
| ____ _ [__] | | ____ _ [__] | | ____ _ [__] | |
| ____ _ [__] | | ____ _ [__] | | ____ _ [__] | |
| ____ _ [__] | | ____ _ [__] | | ____ _ [__] | |
| [__] : no revision number means latest revision / pas de numéro de révision signifie révision la plus récente | | | | | |

NOM / NAME : _____ Date : _____

SOCIETE / COMPANY : _____

ADRESSE / ADDRESS : _____

PHONE / TELEPHONE : _____ FAX : _____

E-MAIL : _____

For Bull Subsidiaries / Pour les Filiales Bull :

Identification: _____

For Bull Affiliated Customers / Pour les Clients Affiliés Bull :

Customer Code / Code Client : _____

For Bull Internal Customers / Pour les Clients Internes Bull :

Budgetary Section / Section Budgétaire : _____

For Others / Pour les Autres :

Please ask your Bull representative. / Merci de demander à votre contact Bull.

BULL CEDOC
357 AVENUE PATTON
B.P.20845
49008 ANGERS CEDEX 01
FRANCE

ORDER REFERENCE
86 A2 54EM 02