

M6-700 or M7-700 Managing devices

ESCALA Power7



REFERENCE  
86 A1 76FG 02



# ESCALA Power7

## M6-700 or M7-700 Managing devices

The ESCALA Power7 publications concern the following models:

- Bull Escala E5-700 (Power 750 / 8233-E8B)
- Bull Escala M6-700 (Power 770 / 9117-MMB)
- Bull Escala M6-705 (Power 770 / 9117-MMC)
- Bull Escala M7-700 (Power 780 / 9179-MHB)
- Bull Escala M7-705 (Power 780 / 9179-MHC)
- Bull Escala E1-700 (Power 710 / 8231-E2B)
- Bull Escala E1-705 (Power 710 / 8231-E1C)
- Bull Escala E2-700 / E2-700T (Power 720 / 8202-E4B)
- Bull Escala E2-705 / E2-705T (Power 720 / 8202-E4C)
- Bull Escala E3-700 (Power 730 / 8231-E2B)
- Bull Escala E3-705 (Power 730 / 8231-E2C)
- Bull Escala E4-700 / E4-700T (Power 740 / 8205-E6B)
- Bull Escala E4-705 (Power 740 / 8205-E6C)

References to Power 755 / 8236-E8C models are irrelevant.

## Hardware

May 2012

BULL CEDOC  
357 AVENUE PATTON  
B.P.20845  
49008 ANGERS CEDEX 01  
FRANCE

REFERENCE  
86 A1 76FG 02

The following copyright notice protects this book under Copyright laws which prohibit such actions as, but not limited to, copying, distributing, modifying, and making derivative works.

Copyright © Bull SAS 2012

Printed in France

Suggestions and criticisms concerning the form, content, and presentation of this book are invited. A form is provided at the end of this book for this purpose.

To order additional copies of this book or other Bull Technical Publications, you are invited to use the Ordering Form also provided at the end of this book.

### **Trademarks and Acknowledgements**

We acknowledge the right of proprietors of trademarks mentioned in this book.

*The information in this document is subject to change without notice. Bull will not be liable for errors contained herein, or for incidental or consequential damages in connection with the use of this material.*

---

# Contents

<b>Safety notices</b> . . . . .	<b>v</b>
<b>What's new in Managing devices</b> . . . . .	<b>1</b>
<b>Managing tape drives for the 9117-MMB or 9179-MHB</b> . . . . .	<b>3</b>
Tape drives . . . . .	3
Tape drive media . . . . .	5
Preparing the tape drive for installation . . . . .	9
800/1600 GB Ultrium 4 SAS tape drive (FC 5746) . . . . .	10
Eject button functions on the tape drive (FC 5746) . . . . .	11
Status lights (FC 5746) . . . . .	12
Tape cartridges (FC 5746) . . . . .	14
Setting the write-protect switch (FC 5746) . . . . .	15
Cleaning the tape drive (FC 5746) . . . . .	15
Maintenance mode (FC 5746) . . . . .	16
Resetting the tape drive . . . . .	18
Performing the internal self-test (FC 5746) . . . . .	19
200/400 GB Half High Ultrium 2 tape drive (FC 5755) . . . . .	20
Cleaning the tape drive (FC 5755) . . . . .	21
Setting the write-protect switch (FC 5755) . . . . .	22
Status lights (FC 5755) . . . . .	22
Tape cartridges (FC 5755) . . . . .	25
Resetting the tape drive (FC 5755) . . . . .	26
Performing the internal self-test (FC 5755) . . . . .	26
160/320 GB internal tape drive VXA-320 (FC 6279) . . . . .	28
Cleaning the tape drive (FC 6120 and 6279) . . . . .	29
Loading and unloading cartridges . . . . .	30
Loading a cartridge . . . . .	30
Unloading a cartridge . . . . .	30
Setting the write-protect switch (FC 6279) . . . . .	31
Status lights (FC 6279) . . . . .	31
Performing the internal self-test (FC 6120 or 6279) . . . . .	33
Tape cartridges (FC 6279) . . . . .	34
Resetting the tape drive . . . . .	35
80/160 GB internal tape drive VXA-2 (FC 6120) . . . . .	36
Cleaning the tape drive (FC 6120 and 6279) . . . . .	36
Loading and unloading cartridges . . . . .	37
Loading a cartridge . . . . .	38
Unloading a cartridge . . . . .	38
Setting the write-protect switch (FC 6120) . . . . .	38
Status lights (FC 6120) . . . . .	39
Performing the internal self-test (FC 6120 or 6279) . . . . .	41
Tape cartridges (FC 6120) . . . . .	42
Resetting the tape drive . . . . .	43
60/150 GB 16-bit 8-mm internal tape drive (FC 6134) . . . . .	44
Cleaning the tape drive (FC 6134) . . . . .	44
Loading and unloading cartridges . . . . .	46
Loading a cartridge . . . . .	46
Unloading a cartridge . . . . .	46
Setting the write-protect switch (FC 6134) . . . . .	46
Status lights (FC 6134) . . . . .	47
Tape cartridges (FC 6134) . . . . .	48
Resetting the tape drive . . . . .	49
36/72 GB Data72 4 mm internal tape drive (FC 6258 or 5907) . . . . .	50
Cleaning the tape drive (FC 6258 or 5907) . . . . .	51

Loading and unloading cartridges . . . . .	52
Loading a cartridge . . . . .	52
Unloading a cartridge . . . . .	52
Setting the write-protect switch (FC 6258 or 5907) . . . . .	53
Status lights (FC 6258 or 5907) . . . . .	53
Tape cartridges (FC 6258 or 5907) . . . . .	55
Resetting the tape drive . . . . .	56
80/160 GB DAT160 SAS Tape Drive (FC 5619). . . . .	57
Cleaning the tape drive (FC 5619) . . . . .	58
Loading and unloading cartridges . . . . .	59
Loading a cartridge . . . . .	59
Unloading a cartridge . . . . .	59
Setting the write-protect switch (FC 5619) . . . . .	60
Status lights (FC 5619). . . . .	60
Tape cartridges (FC 5619). . . . .	62
Resetting the tape drive . . . . .	63
160/320 GB DAT320 SAS tape drive (FC 5661). . . . .	64
Cleaning the tape drive (FC 5661) . . . . .	65
Loading and unloading cartridges . . . . .	66
Loading a cartridge . . . . .	66
Unloading a cartridge . . . . .	66
Setting the write-protect switch (FC 5661) . . . . .	67
Status lights (FC 5661). . . . .	67
Tape cartridges (FC 5661). . . . .	70
Resetting the tape drive . . . . .	70
<b>Managing DVD drives for the 9117-MMB or 9179-MHB . . . . .</b>	<b>73</b>
SATA Slimline DVD-RAM Drive (FC 5762) . . . . .	73
Handling and storing the DVD media . . . . .	73
Opening a DVD tray manually . . . . .	74
DVD-RAM type II disc . . . . .	74
<b>Managing diskette drives . . . . .</b>	<b>77</b>
External USB 1.44 MB diskette drive (FC 2591) . . . . .	77
<b>Managing removable disk drives . . . . .</b>	<b>79</b>
USB Removable Disk Drive (FC 1104, 1106, 1107, 1123, EU01, and EU08) . . . . .	79
<b>Notices . . . . .</b>	<b>85</b>
Trademarks . . . . .	86
Electronic emission notices . . . . .	86
Class A Notices . . . . .	86
Terms and conditions . . . . .	90

---

## Safety notices

Safety notices may be printed throughout this guide.

- **DANGER** notices call attention to a situation that is potentially lethal or extremely hazardous to people.
- **CAUTION** notices call attention to a situation that is potentially hazardous to people because of some existing condition.
- **Attention** notices call attention to the possibility of damage to a program, device, system, or data.

### World Trade safety information

Several countries require the safety information contained in product publications to be presented in their national languages. If this requirement applies to your country, a safety information booklet is included in the publications package shipped with the product. The booklet contains the safety information in your national language with references to the U.S. English source. Before using a U.S. English publication to install, operate, or service this product, you must first become familiar with the related safety information in the booklet. You should also refer to the booklet any time you do not clearly understand any safety information in the U.S. English publications.

### Laser safety information

The servers can use I/O cards or features that are fiber-optic based and that utilize lasers or LEDs.

#### Laser compliance

The servers may be installed inside or outside of an IT equipment rack.

## DANGER

When working on or around the system, observe the following precautions:

Electrical voltage and current from power, telephone, and communication cables are hazardous. To avoid a shock hazard:

- Connect power to this unit only with the provided power cord. Do not use the provided power cord for any other product.
- Do not open or service any power supply assembly.
- Do not connect or disconnect any cables or perform installation, maintenance, or reconfiguration of this product during an electrical storm.
- The product might be equipped with multiple power cords. To remove all hazardous voltages, disconnect all power cords.
- Connect all power cords to a properly wired and grounded electrical outlet. Ensure that the outlet supplies proper voltage and phase rotation according to the system rating plate.
- Connect any equipment that will be attached to this product to properly wired outlets.
- When possible, use one hand only to connect or disconnect signal cables.
- Never turn on any equipment when there is evidence of fire, water, or structural damage.
- Disconnect the attached power cords, telecommunications systems, networks, and modems before you open the device covers, unless instructed otherwise in the installation and configuration procedures.
- Connect and disconnect cables as described in the following procedures when installing, moving, or opening covers on this product or attached devices.

To Disconnect:

1. Turn off everything (unless instructed otherwise).
2. Remove the power cords from the outlets.
3. Remove the signal cables from the connectors.
4. Remove all cables from the devices

To Connect:

1. Turn off everything (unless instructed otherwise).
2. Attach all cables to the devices.
3. Attach the signal cables to the connectors.
4. Attach the power cords to the outlets.
5. Turn on the devices.

(D005a)

## DANGER



Observe the following precautions when working on or around your IT rack system:

- Heavy equipment—personal injury or equipment damage might result if mishandled.
- Always lower the leveling pads on the rack cabinet.
- Always install stabilizer brackets on the rack cabinet.
- To avoid hazardous conditions due to uneven mechanical loading, always install the heaviest devices in the bottom of the rack cabinet. Always install servers and optional devices starting from the bottom of the rack cabinet.
- Rack-mounted devices are not to be used as shelves or work spaces. Do not place objects on top of rack-mounted devices.



- Each rack cabinet might have more than one power cord. Be sure to disconnect all power cords in the rack cabinet when directed to disconnect power during servicing.
- Connect all devices installed in a rack cabinet to power devices installed in the same rack cabinet. Do not plug a power cord from a device installed in one rack cabinet into a power device installed in a different rack cabinet.
- An electrical outlet that is not correctly wired could place hazardous voltage on the metal parts of the system or the devices that attach to the system. It is the responsibility of the customer to ensure that the outlet is correctly wired and grounded to prevent an electrical shock.

#### CAUTION

- Do not install a unit in a rack where the internal rack ambient temperatures will exceed the manufacturer's recommended ambient temperature for all your rack-mounted devices.
- Do not install a unit in a rack where the air flow is compromised. Ensure that air flow is not blocked or reduced on any side, front, or back of a unit used for air flow through the unit.
- Consideration should be given to the connection of the equipment to the supply circuit so that overloading of the circuits does not compromise the supply wiring or overcurrent protection. To provide the correct power connection to a rack, refer to the rating labels located on the equipment in the rack to determine the total power requirement of the supply circuit.
- *(For sliding drawers.)* Do not pull out or install any drawer or feature if the rack stabilizer brackets are not attached to the rack. Do not pull out more than one drawer at a time. The rack might become unstable if you pull out more than one drawer at a time.
- *(For fixed drawers.)* This drawer is a fixed drawer and must not be moved for servicing unless specified by the manufacturer. Attempting to move the drawer partially or completely out of the rack might cause the rack to become unstable or cause the drawer to fall out of the rack.

(R001)

**CAUTION:**

Removing components from the upper positions in the rack cabinet improves rack stability during relocation. Follow these general guidelines whenever you relocate a populated rack cabinet within a room or building:

- Reduce the weight of the rack cabinet by removing equipment starting at the top of the rack cabinet. When possible, restore the rack cabinet to the configuration of the rack cabinet as you received it. If this configuration is not known, you must observe the following precautions:
  - Remove all devices in the 32U position and above.
  - Ensure that the heaviest devices are installed in the bottom of the rack cabinet.
  - Ensure that there are no empty U-levels between devices installed in the rack cabinet below the 32U level.
- If the rack cabinet you are relocating is part of a suite of rack cabinets, detach the rack cabinet from the suite.
- Inspect the route that you plan to take to eliminate potential hazards.
- Verify that the route that you choose can support the weight of the loaded rack cabinet. Refer to the documentation that comes with your rack cabinet for the weight of a loaded rack cabinet.
- Verify that all door openings are at least 760 x 230 mm (30 x 80 in.).
- Ensure that all devices, shelves, drawers, doors, and cables are secure.
- Ensure that the four leveling pads are raised to their highest position.
- Ensure that there is no stabilizer bracket installed on the rack cabinet during movement.
- Do not use a ramp inclined at more than 10 degrees.
- When the rack cabinet is in the new location, complete the following steps:
  - Lower the four leveling pads.
  - Install stabilizer brackets on the rack cabinet.
  - If you removed any devices from the rack cabinet, repopulate the rack cabinet from the lowest position to the highest position.
- If a long-distance relocation is required, restore the rack cabinet to the configuration of the rack cabinet as you received it. Pack the rack cabinet in the original packaging material, or equivalent. Also lower the leveling pads to raise the casters off of the pallet and bolt the rack cabinet to the pallet.

(R002)

(L001)



(L002)



(L003)



or



All lasers are certified in the U.S. to conform to the requirements of DHHS 21 CFR Subchapter J for class 1 laser products. Outside the U.S., they are certified to be in compliance with IEC 60825 as a class 1 laser product. Consult the label on each part for laser certification numbers and approval information.

**CAUTION:**

This product might contain one or more of the following devices: CD-ROM drive, DVD-ROM drive, DVD-RAM drive, or laser module, which are Class 1 laser products. Note the following information:

- Do not remove the covers. Removing the covers of the laser product could result in exposure to hazardous laser radiation. There are no serviceable parts inside the device.
- Use of the controls or adjustments or performance of procedures other than those specified herein might result in hazardous radiation exposure.

(C026)

**CAUTION:**

Data processing environments can contain equipment transmitting on system links with laser modules that operate at greater than Class 1 power levels. For this reason, never look into the end of an optical fiber cable or open receptacle. (C027)

**CAUTION:**

This product contains a Class 1M laser. Do not view directly with optical instruments. (C028)

**CAUTION:**

Some laser products contain an embedded Class 3A or Class 3B laser diode. Note the following information: laser radiation when open. Do not stare into the beam, do not view directly with optical instruments, and avoid direct exposure to the beam. (C030)

**CAUTION:**

The battery contains lithium. To avoid possible explosion, do not burn or charge the battery.

*Do Not:*

- \_\_\_ Throw or immerse into water
- \_\_\_ Heat to more than 100°C (212°F)
- \_\_\_ Repair or disassemble

Exchange only with the approved part. Recycle or discard the battery as instructed by local regulations. (C003a)

## **Power and cabling information for NEBS (Network Equipment-Building System) GR-1089-CORE**

The following comments apply to the servers that have been designated as conforming to NEBS (Network Equipment-Building System) GR-1089-CORE:

The equipment is suitable for installation in the following:

- Network telecommunications facilities
- Locations where the NEC (National Electrical Code) applies

The intrabuilding ports of this equipment are suitable for connection to intrabuilding or unexposed wiring or cabling only. The intrabuilding ports of this equipment *must not* be metallically connected to the interfaces that connect to the OSP (outside plant) or its wiring. These interfaces are designed for use as intrabuilding interfaces only (Type 2 or Type 4 ports as described in GR-1089-CORE) and require isolation from the exposed OSP cabling. The addition of primary protectors is not sufficient protection to connect these interfaces metallically to OSP wiring.

**Note:** All Ethernet cables must be shielded and grounded at both ends.

The ac-powered system does not require the use of an external surge protection device (SPD).

The dc-powered system employs an isolated DC return (DC-I) design. The DC battery return terminal *shall not* be connected to the chassis or frame ground.

---

## What's new in Managing devices

See what is new and what has changed in Managing devices since the last edition of this topic.

### March 2010

- Added information on Handling and storing the DVD media.

### February 2010

- Added information for systems servers that contain the POWER7<sup>®</sup> processor.



---

## Managing tape drives for the 9117-MMB or 9179-MHB

Learn about using and managing removable media devices. Find specifications and installation notes for specific drives.

---

### Tape drives

Learn general information about tape drives.

Select the appropriate information from this list:

- Tape drive overview
- Tape drive environment and use
- Tape handling and storage
- Environmental issues
- Tape drive cleaning
- SCSI hardware issues
- Microcode updates

#### Tape drive overview

Your tape drive must be installed in the cleanest possible environment. Additionally, tape drives require high quality, data grade tapes and cleaning on a regular basis. Media must also be stored and handled properly. Improper use, storage or handling of tape drives or media may void your warranty or service agreement. If a tape drive stops functioning due to a component failure during the tape drive warranty or maintenance time, the tape drive supplier will replace the tape drive unit. The tape drive supplier will replace any defective tape drive under the terms and conditions of the warranty or service agreement.

The tape drive is a streaming device used primarily for:

- Saving and restoring system data files
- Archiving important records
- Distributing operating system software upgrades

**Note:** The following information describes hardware features and functions. While the hardware supports them, the availability of these features and functions depends upon support from the operating system. For information about support for features and functions, see the documentation for your operating system.

#### Tape drive environment and use

Tape drives require specific maintenance and environmental conditions to operate well over time. Using high-quality, data-grade media, handling and storing this media correctly, operating the tape drive in a clean environment, and keeping the tape drive correctly cleaned can help you to avoid problems with your tape drive.

If a tape drive stops functioning due to a component failure during the tape drive warranty or maintenance time, the service provider will replace the tape drive unit. The service provider will replace any defective tape drive under the terms and conditions of its warranty or service agreement. It is the service provider's objective to work with you to identify the cause of any tape-drive problem and provide a solution.

## Tape handling and storage

Most tape is supplied in a sealed cartridge so that the tape will remain clean. Opening the cartridge allows dirt and airborne particles to enter and then become a source of contamination. The cartridge should only be opened by the tape drive and not an operator. The tape also is held under proper tension inside the cartridge. If the cartridge is dropped, this tension will be relaxed.

**Attention:** Inserting a dropped cartridge into a tape drive can cause incorrect loading and result in a jam. This action will ruin the tape and can cause physical damage if the cartridge is not removed correctly.

When the tapes are stored, they must be replaced in their protective containers and stored on their end. The storage area must be clean, dry, at normal room temperature, and away from any magnetic fields. Improper use, storage, or handling of tape drives or media might void your warranty or service agreement.

## Environmental issues

Tape drives are designed to operate in a clean environment. Problems can be caused by dirt, dust, fibers, and airborne particles. Airborne particles are the most difficult to address. When a tape is installed into the tape drive, the clearance between the heads and the tape is measured in microns. Particles can damage the tape or the head if they come in contact with either. Customers are responsible to provide a clean operating environment for the tape drive and system.

## Tape drive cleaning

No matter how clean the environment, debris can build up on the heads of any tape drive. Every time tape motion occurs, some of the media surface comes off on the heads. Over time, this surface builds up and causes errors in reading and writing. Customers are responsible to clean the tape drive in accordance with the cleaning information that was provided with the tape drive.

Cleaning cartridges can be used a limited number of times. After a cleaning cartridge has been used to its maximum number of times, the cartridge is considered expired. When cartridges expire, they must be replaced. Never reuse an expired cleaning cartridge. Doing so allows previously removed dirt to be reintroduced to the tape drive. Place a mark on the cleaning cartridge after each use, to best determine when your cleaning cartridge has expired.

## SCSI hardware issues

**Note:** If you are installing the auto-docking version of this device on your system, this section does not apply to your system. For information about the auto-docking feature, see your system documentation.

SCSI bus cables and terminators can affect tape drive performance. Use cables and terminators that are designed specifically to keep the SCSI bus as free of noise as possible. Generic cables or terminators can adversely affect the SCSI bus performance. If your service provider's analysis indicates a problem with inferior cables, it might be necessary for the customer to replace them.

## Microcode updates

To make certain that the tape drives work their best, your system supplier might release changed microcode for the tape drives. When a microcode change is developed, your system supplier makes the change available to you through its service organization or by electronic delivery. You might be responsible for installing new microcode as it becomes available. However, microcode can be installed by your service provider or your system administrator. For more information, contact your authorized service provider.



---

## Tape drive media

Learn about using the different types of tape drive media.

**Attention:** Your system supplier might support only the media that it sells. If the supplier's analysis indicates that the problem is caused by using inferior media, it is the customer's responsibility to replace the inferior media.

Select the appropriate information from this list:

- Types of cartridges
- Recommendations for data cartridge usage
- Prolonging head life
- Storage and shipping environments
- Tape cartridge storage
- Operating in harsh environments
- Ordering tape and data cartridges

### Types of cartridges

Tape devices use the following media cartridges.

#### Data cartridge

Use the data cartridge to save or restore programs or data.

#### Test cartridge

Use the specially labeled test cartridge to run the AIX<sup>®</sup> system diagnostics (for information about running diagnostics, refer to your AIX documentation). Do not use the test cartridge to save or restore customer programs or data.

#### Cleaning cartridge

Use the specially labeled cleaning cartridge to clean the device.

**Attention:** Use of other than the specified cleaning cartridge can damage your device and might void your warranty.

To order additional cartridges, refer to Ordering tape cartridges.

### Recommendations for data cartridge usage

The following list describes recommended guidelines that will help to protect your data and prolong the life of your tape cartridges and the device:

- Use only the tape cartridge specified for your type of tape device.
- Remove the tape cartridge from the drive when the drive is not in use.
- Back up and then discard any tape cartridge that repeatedly produces error messages (the error information is in the System Error Log).
- On the data cartridge, do not open the door that covers the tape. The door protects the tape from dirt, dust, and damage.
- Do not touch the tape. Any substance transferred to the tape by touching could cause loss of data.
- To avoid problems with loading and unloading, use only one label on a cartridge. Multiple or poorly placed labels can clog the drive load mechanism.
- Do not use poor-quality tape cartridges. They can cause excessive read or write errors, and they might damage the tape drive.
- Discard any tape cartridges that are dropped, because the impact might damage the tape's internal mechanism.

- Make sure the environment is kept clean and constant. Do not operate in a dusty environment and always maintain a constant environment. A consistent storage and operating environment reduces media exposure to climatic stress.
- Use only the recommended cleaning cartridge to clean the tape drive. Use of other than recommended cleaning cartridges can damage your drive and might void the warranty.
- Printers and copiers can produce paper dust and toner dust. Locate the tape unit away from these items. High traffic areas near hallways and doors can also produce excess dust and dirt.
- Record all important information on the tape label. Information, such as the model and number of the system or tape drive, the date, the density, any error statistics, and include a log number. Also note the operating environment and compression mode.

## Prolonging head life

New technology found in the tape device is read and write compatible with newer tape cartridges. Due to media characteristics, extended use of older tape cartridges might increase head wear on the drive. An indication of this head wear is an increase in soft (recoverable) errors. Using newer tape cartridges may have enhanced characteristics that can reduce drive head wear and maximize the overall advantages of the tape device.

## Storage and shipping environments

Before using a tape cartridge, let it acclimatize to the operating environment by placing the cartridge in the operating environment for as long as it has been away from the environment or for 24 hours, whichever is less. Acclimatization is necessary for any data cartridge exposed to an environmental change in humidity or to temperature changes of 11°C (20°F) or more. To determine the appropriate operating environment, see Tape drive environment and use.

Retrieval of archived data can be performed on a tape unit that is clean and fully operational. Try to make the recovery environment the same as the operating environment. Allow tapes at least 24 hours to acclimatize to the environment of the tape unit.

The recommended environment for storage and shipment of cartridges is shown in Table 1.

*Table 1. Recommended environment for data cartridges*

Environmental Factor	Storage	Shipping
Temperature	5°C - 32°C (41°F - 90°F)	-40 - 52°C (-40 - 125°F)
Relative Humidity (noncondensing)	20% - 60%	5% - 80%
Maximum Wet Bulb	26°C (79°F)	26°C (79°F)

## Tape cartridge storage

Tape drives record data using densities similar to hard disk drives. Because most computer systems are not located in a dust-free, climate-controlled environment, you must exercise special care when dealing with tape cartridges and tape drives. They must be treated as a valuable asset used to protect your business data.

Use the following guidelines for storing your tape cartridges:

- Keep temperature and humidity constant at the levels listed in Table 1.
- Always store tape cartridges in their protective cases. The storage case helps prevent damage from dust and physical misuse. When the tape cartridges are not in use or being stored, keep them in their

storage cases and stand on edge in a designated storage location. Do not stack cartridges on the flat side or stack other items on top of the tape cartridges. Handle your tape cartridges with care to reduce archival problems.

- Keep protective cases for tape cartridges closed except when inserting or removing a cartridge. Contamination can build up and be transferred to the tape cartridge if the protective case is left open.
- Exercise stored tapes at least once every 12 months. Run the tape from Beginning of Data (BOD) to End of Data (EOD) and back to BOD at normal operating speeds. Exercise tapes stored in a warmer environment more frequently.
- Sunlight can damage the tape and the cartridge shell. Store tape cartridges out of the direct sunlight.

**Attention:** Operation outside of the recommended environment can result in possible loss of data or failure of the drive.

## Operating in harsh environments

The device is suited to streaming operations, as opposed to multiple stop-and-start, random-search tape operations. When the tape is used for frequent stop-and-start operations, it is beneficial to still have as much streaming movement as possible. This can be accomplished by ensuring that any save or restore operation is the only active operation being performed.

Do not use any tape for archival purposes if it has been used outside of the ranges specified in Table 1 on page 6 for an extended period of time. The magnetic and physical strength of the tape will have deteriorated as a result of its exposure to the environment. Do not store important data on such a tape; transfer the data to a newer tape for reliable archiving.

## Ordering tape and data cartridges

All tape cartridges are not alike. The tape composition and length, and the construction of the cartridge itself can all affect the quality and capacity of the recording and the performance of your tape drive. A poor quality tape cartridge might appear to work adequately in your system, yet it can leave contamination in the tape path or impede the speed of the recording.

The length and composition of the tape, and the size, shape, and construction of the cartridge shell must all be considered when selecting the tape cartridge to be used with your system. Your service provider might support using only data and cleaning cartridges supplied by it. Use only data-grade tape media for backup and data processing.

To order cartridges, contact your authorized service provider.

*Table 2. Recommended test, cleaning, and 4mm data cartridges for the specific type of tape drive*

Tape drive	Part number	Type of cartridge	Capacity
DDS3	59H3466	Test Cartridge	11.5m
	21F8763	Cleaning Cartridge	50 cleanings
	59H3465	Data Cartridge	12 GB
DDS4	59H4457	Test Cartridge	11.5m
	21F8763	Cleaning Cartridge	50 cleanings
	59H4458	Data Cartridge	20 GB
DAT72	59H4457	Test Cartridge	11.5m
	21F8763	Cleaning Cartridge	50 cleanings
	18P7912	Data Cartridge	36 GB

Table 2. Recommended test, cleaning, and 4mm data cartridges for the specific type of tape drive (continued)

Tape drive	Part number	Type of cartridge	Capacity
DAT160	23R5636	Test Cartridge	155m
	23R5638	Cleaning Cartridge	25 cleanings (minimum)
	23R5635	Data Cartridge	80 GB
DAT320	46C1938	Test Cartridge	153m
	46C1937	Cleaning Cartridge	27 cleanings (minimum)
			50 cleanings (average)
46C1936	Data Cartridge	160 GB	

Table 3. Recommended 8-mm data cartridges

Part number	Type of cartridge	Length
35L1044	20 GB AME with SmartClean Data Cartridge	75 m (246 ft)
09L5323	40 GB AME with SmartClean Data Cartridge	150 m (492 ft)
18P6484	60 GB AME with SmartClean Data Cartridge	225 m (738 ft)
35L1409	Cleaning Cartridge	

Table 4. Recommended VXA X-type data cartridges

Part number	Type of cartridge	Length
24R2137	80/160 GB X23 VXA Data Cartridge	230 m (754 ft)
24R2136	40/80 GB X10* VXA Data Cartridge	124 m (406 ft)
24R2134	20/40 GB X6* VXA Data Cartridge	62 m (203 ft)
24R2135	VXA X6* Test Cartridge	62 m (203 ft)
24R2138	VXA 20 X Cleaning Cartridge	

Note: \*X type media requires a minimum microcode level of 2105.

Table 5. Recommended VXA V Type data cartridges

Part number	Type of cartridge	Length
19P4876	80/160 GB V23 VXA Data Cartridge	230 m (754 ft)
24R2136	40/80 GB V10 VXA Data Cartridge	124 m (406 ft)
19P4878	20/40 GB V6 VXA Data Cartridge	62 m (203 ft)
19P4879	VXA V6 Test Cartridge	62 m (203 ft)
19P4880	VXA 20 V Cleaning Cartridge	

Note: V cartridges are the original VXA cartridge.

Table 6. LTO Ultrium data cartridges

Part number	Type of cartridge	Length
08L9120	100/200GB LTO Ultrium 1 Data Cartridge	610 m (2000 ft )
08L9870	200/400GB LTO Ultrium 2 Data Cartridge	610 m (2000 ft )

Table 6. LTO Ultrium data cartridges (continued)

Part number	Type of cartridge	Length
24R1922	LTO-3 Data Cartridge (400GB/800GB)	
96P1203	LTO-3 Worm Data Cartridge	
95P4436	LTO-4 Data Cartridge (800GB/1.6TB)	
95P4450	LTO-4 Worm Data Cartridge	
45E1129	LTO-4 Test Cartridge	
24R0395	LTO Gen-2 Test Cartridge	610 m (2000 ft )
35L2086	Universal Cleaning Cartridge	
46X1290	LTO-5 Data Cartridge( 1.5 TB / 3.0 TB) Write/Read	
46C2009	LTO-5 Test Cartridge( 1.5 TB / 3.0 TB) Write/Read	
46X1292	LTO-5 Worm Data Cartridge Write 1x/Read many	
35L2086	Universal Cleaning Cartridge	

Table 7. RDX data cartridges

Feature code	IBM part number	Type of cartridge
1106	46C5375	160 GB RDX Data Cartridges
EU08	46C5377	320 GB RDX Data Cartridges
1107	46C5379	500 GB RDX Data Cartridges
EU01	46C2335	1 TB Removable Disk Drive

## Preparing the tape drive for installation

Find what you need to know before you install a SCSI tape drive.

### Handling recommendations

**Attention:** Be sure to read these instructions before you remove the device from its anti-static bag or any time you handle it.

For optimum performance, always follow these recommendations:

- Handle the drive carefully and by its external metal chassis. Keep your hands away from the printed circuit boards, components, and printed circuit (flex) cables.
- If possible, work on a cushioned surface, and do not drop the device onto the work surface.
- If you move the device to an environment that is colder or warmer than its previous environment, keep the drive in its package and allow the package to reach the current room temperature. This action prevents potential data loss or damage to the device. Allow one hour of acclimatization for each 10 degrees C (18 degrees F) difference between the ship or storage temperature and the room temperature.

**Note:** If you are installing the auto-docking version of this device on your system, the remainder of this information does not apply to your system. For information about the auto-docking feature, see your system documentation.

## Planning your serial-attached SCSI (SAS) device layout

SAS devices do not require you to set a SCSI address before connecting to a SAS bus.

## Configuring the tape drive

To configure the drive after installation, boot your system unit. Device drivers are provided in the operating systems that support the drive. Your operating system recognizes the drive and automatically updates your system unit configuration.

## Updating microcode levels

Media devices contain microcode that you can update. For instructions about how to obtain and install the latest microcode levels for your device, see Fix Central.

---

## 800/1600 GB Ultrium 4 SAS tape drive (FC 5746)

Learn about the features of this media device.

Description	<p>The Ultrium 4 serial attached SCSI (SAS) tape drive is a half-high tape drive designed for Open Systems backup and restore applications. The tape drive is an LTO Ultrium 4 standard interchange device. The drive will read tapes written by other Ultrium 4 drives, and will write to tapes readable by other Ultrium 4 drives. For an illustration of the drive, see Figure 1 on page 12.</p> <p>Characteristics:</p> <ul style="list-style-type: none"><li>• FRU part number is 45E1127. For media part numbers, see “Tape cartridges (FC 5746)” on page 14.</li><li>• Custom card identification number (CCIN) number is 63A0</li><li>• Data transfer rate: 120 MB per second native mode, 240 MB per second at 2:1 compression</li><li>• Bootable device, depending on the host system configuration</li><li>• Operation: Streaming</li><li>• Form Factor: 5.25-inch half high</li><li>• Attributes required: One 1.6-inch (41 mm) half-high media bay and one integrated, internal SAS controller</li></ul>
Tools	<p>The following tools and documentation are needed to complete the installation:</p> <ul style="list-style-type: none"><li>• A flat-blade screwdriver (if this device is not an auto-docking feature on your system)</li><li>• Your system unit documentation, including any service documentation</li><li>• Your operating system documentation</li></ul> <p>Contact the place of purchase if an item is missing or damaged.</p> <p><b>Note:</b> If you are installing the auto-docking version of this device on your system, see your system documentation for information about the auto-docking feature.</p>
Media	<p>The drive will read and write on Ultrium 4 and Ultrium 3 cartridges, and read Ultrium 2 cartridges. The drive will not write on Ultrium 2 cartridges, and the drive will not read or write on Ultrium 1 cartridges.</p> <p>Each Ultrium 4 tape cartridge can store up to 800 GB of uncompressed data, or up to 1600 GB of compressed data.</p> <p><b>Note:</b> The actual capacity varies depending on the application, the type of data, and the tape cartridge. When data compression is activated, 800 GB is typical and 1600 GB is possible. The default setting of data compression is controlled by the host system. The user and the application software can control the activation or deactivation of the data compression setting. The drive can optimally achieve a 2:1 compression ratio.</p>

Related information	<p>Your package contains the following items:</p> <ul style="list-style-type: none"> <li>• The tape drive</li> <li>• Media kit containing: <ul style="list-style-type: none"> <li>– One cleaning cartridge</li> <li>– One test tape</li> </ul> </li> <li>• Specific hardware for attaching the drive to your specific system, as detailed on the parts listing provided with your drive.</li> </ul>
---------------------	---

## Eject button functions on the tape drive (FC 5746)

You might need to eject a tape, reset the drive, or place the drive in maintenance mode. Use the information in this topic to perform these tasks.

### About this task

The drive has an eject button that enables you to perform the functions shown in the following table. The eject button is illustrated in Figure 1 on page 12.

*Table 8. Eject button functions on the tape drive*

Function	How to start the function
Reset the drive	Press and hold the eject button on the drive for 20 seconds. The drive saves a dump of the current drive state, and then reboots to allow communication. Do not cycle power because this will erase the contents of the dump.
Rewind the tape into the cartridge and eject the cartridge from the tape drive	Press the eject button once. The status light flashes green while the tape drive is rewinding and unloading.
Place the tape drive in maintenance mode	Ensure that the tape drive is unloaded. Then, press the eject button three times within one second. You are in maintenance mode when the light becomes solid amber and 0 appears in the single-character display.
Scroll through the maintenance functions	While in maintenance mode, push the eject button once per second to increment the display characters by one. When you reach the character of the diagnostic or maintenance function that you want, press and hold the eject button for 3 seconds. For a list of Maintenance functions, see Table 11 on page 17.
Exit maintenance mode	Press the eject button once per second until 0 displays. Then press and hold the eject button for 3 seconds. Maintenance mode is exited when the status light becomes solid green and the single-character display becomes blank.

Table 8. Eject button functions on the tape drive (continued)

Function	How to start the function
Force a drive dump (part of the maintenance mode)	<p><b>Attention:</b> If the tape drive detects a permanent error and displays an error code, it automatically forces a drive dump. If you force a drive dump, the existing dump will be overwritten and data will be lost. After you force a drive dump, do not turn off the power to the tape drive or you might lose the dump data.</p> <p>If the tape drive is in maintenance mode (status light is solid amber), select function code 4. For a list of Maintenance functions, see Table 11 on page 17.</p> <p>If the tape drive is in operating mode (status light is solid or flashing green), press and hold the eject button for 10 seconds. If captured dump data exists, the tape drive places the data into a dump area</p>

## Status lights (FC 5746)

You might need to read the status lights on your tape drive to determine the operating status of the drive. Use the information in this topic to perform this task.

The following illustration shows a front view of the tape drive:

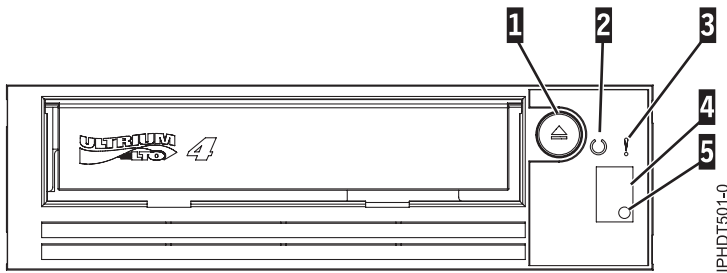

Figure 1. Front view of tape drive

- |          |                                |
|----------|--------------------------------|
| <b>1</b> | Eject button                   |
| <b>2</b> | Ready LED                      |
| <b>3</b> | Fault LED                      |
| <b>4</b> | Single-character display (SCD) |
| <b>5</b> | SCD light                      |

The combinations of the lights and their definitions are shown in the following table.

Table 9. Definition of Status Light Combinations



Operation	Ready 	Fault 	Single character display 	Response
Power-On Self-Test in progress	Off	Off or on	Segments flashing <sup>1</sup>	Wait 30 to 60 seconds.
After Power-On Self-Test and drive reset <sup>2</sup>	3.0 seconds on <sup>2</sup>	3.0 seconds on <sup>2</sup>	3.0 seconds on <sup>2</sup>	Wait 30 to 60 seconds.



Table 9. Definition of Status Light Combinations (continued)







Operation	Ready 	Fault 	Single character display 	Response
No cartridge is loaded	Off	Off or on <sup>3</sup>	Off or C <sup>3</sup>	Wait 30 to 60 seconds.
Cartridge is loading or unloading	Flashing <sup>1</sup>	Off or on <sup>3</sup>	Off or C <sup>3</sup>	Wait 30 to 60 seconds.
Cartridge loaded, no activity	On	Off or on <sup>3</sup>	Off or C <sup>3</sup>	Wait 30 to 60 seconds.
Data cartridge loaded, activity	Flashing <sup>1</sup>	Off or on <sup>3</sup>	Off or C <sup>3</sup>	Wait 30 to 60 seconds.
Cleaning is required (clean bit is set)	On or off	On <sup>3</sup>	C <sup>3</sup>	Clean drive as soon as possible.
Cleaning in progress	Flashing	Off	C <sup>3</sup>	Wait for cleaning to complete.
Cleaning cartridge loaded, clean failed	Off	On	6 or 7 <sup>4</sup>	Replace cleaning cartridge, which may be expired.
Maximum operating temperature exceeded <sup>5</sup>	Off	On	1	Reduce drive temperature.
Input voltage failure	Off	On	2	Check input power connections.
Drive firmware failure <sup>6</sup>	Off	Flashing <sup>1</sup>	3	Update to latest level firmware.
Drive firmware or hardware failure <sup>6</sup>	Off	Flashing <sup>1</sup>	4	Clean drive, replace cartridge, or both, if needed. Retry operation.
Unrecoverable drive failure	Off	Flashing <sup>1</sup>	5	
Drive or media failure <sup>7</sup>	Off	On	6	
Media error	Off	On	7 <sup>4</sup>	Replace cartridge. Possible expired cleaning cartridge.
SAS interface failure	Off	Flashing <sup>1</sup>	8	Check SAS cable and connector.
Recoverable drive error <sup>8</sup>	Off	On	A	Clean drive and retry operation.
Incorrect media	Off	On	J	Insert correct media type.
Firmware update is in progress	Both LEDs flashing together	Both LEDs flashing together	Off	Wait for update to complete.
Incorrect firmware update tape used	Off	On	F <sup>4</sup>	Replace firmware update tape.
Firmware update failed <sup>9</sup>	Off	Flashing <sup>1</sup>	H	Retry firmware update operation.

Table 9. Definition of Status Light Combinations (continued)

Operation	Ready 	Fault 	Single character display 	Response
Write operation was attempted and media is write-protected	Off	On	P <sup>4</sup>	Use media that is not write protected.
Drive is in service mode	Flashing rapidly <sup>1</sup>	On	On <sup>10</sup>	
Self-test is in progress	Flashing <sup>1</sup>	On	The number 1 is flashing	Wait for test to complete

<sup>1</sup> When used in this table, *flashing* refers to a 1 Hz flash rate (1 flash per second), and *flashing rapidly* refers to a 4 Hz flash rate (4 flashes per second).

<sup>2</sup> Immediately following a power-on self-test sequence or drive reset, both LEDs, all segments of the single-character display, and the SCD dot will be on solid for approximately 3 seconds.

<sup>3</sup> When a drive needs cleaning, the Fault LED will be on solid and a C will show on the single character display. In most cases the drive will continue to function, but it should be cleaned as soon as possible. Do not ignore the indicator by cycling the power to turn the LED off.

<sup>4</sup> Error code on single-character display is cleared when cartridge is removed from drive.

<sup>5</sup> The Fault LED will be on solid to indicate an over-temperature condition. If a tape is present it will be ejected. This LED will remain on until the drive temperature drops below a lower secondary-temperature limit and one of the following two conditions is also met:

- A data or cleaning cartridge is inserted.
- The drive is powered off and on.

<sup>6</sup> A drive dump will be stored before the drive is powered off. The SCD light serves as a dump indicator. When this light is lit, a dump file is stored in the drive and can be retrieved.

<sup>7</sup> Failure cannot be isolated to either a faulty drive or faulty media.

<sup>8</sup> Error condition will be cleared when the drive is powered off. The drive is not disabled.

<sup>9</sup> The firmware update failed and the drive is not functional. The drive boot code is in control and you should retry the firmware download.

<sup>10</sup> When the drive is in maintenance mode, the Fault LED will be on solid and the single character display will indicate the current maintenance mode state.

## Tape cartridges (FC 5746)

Learn about the types of tape cartridges that are available for this drive.

### Available tape cartridges

Table 10. LTO Ultrium data cartridges

Part number	Type of cartridge
24R1922	LTO-3 Data Cartridge (400GB/800GB)
96P1203	LTO-3 Worm Data Cartridge
35L2086	LTO-4 Cleaning Cartridge
45E1129	LTO-4 Test Cartridge
95P4436	LTO-4 Data Cartridge (800 GB / 1.6 TB)

Table 10. LTO Ultrium data cartridges (continued)

Part number	Type of cartridge
95P4450	LTO-4 Worm Data Cartridge

**Attention:** Do not attempt to bulk erase an LTO data cartridge for reuse. Bulk eraser devices cannot properly erase an LTO data cartridge and cause permanent damage to the cartridge.

## Setting the write-protect switch (FC 5746)

You might need to set the write-protect switch on the media. Use the information in this topic to perform this task.

**Attention:** Do not attempt to change the write-protect settings after the tape cartridge is loaded in the drive because this might cause unpredictable results and might damage the tape or the drive.

The position of the write-protect switch on the tape cartridge determines when you can write to the tape. Before loading cartridges into magazines, set the write-protect switch of each cartridge to enable or disable data recording. When the switch is set to the left, data can be written to the tape. When the switch is set to the right, data cannot be written to the tape.

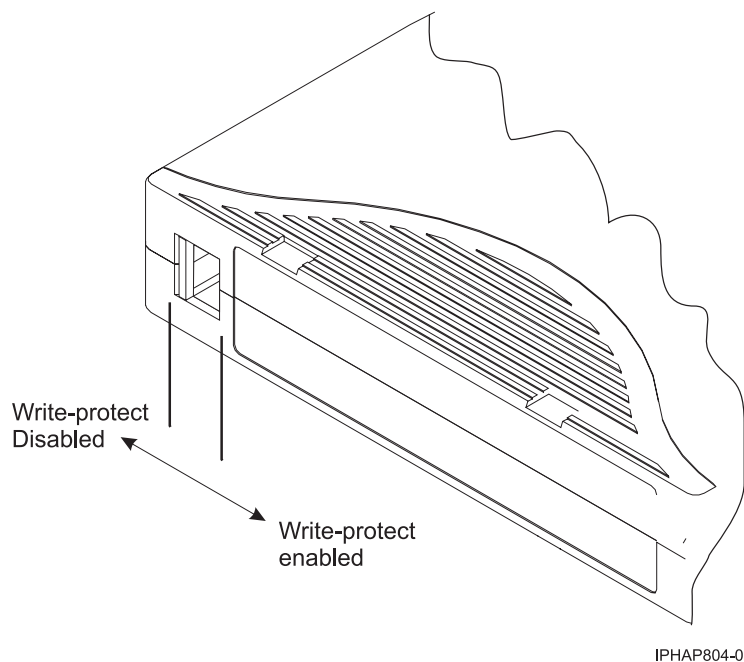

## Cleaning the tape drive (FC 5746)

You will need to clean your tape drive. Use the procedure in this topic to perform this task.

### About this task

Clean the device whenever the Fault status light comes on and a C is displayed in the single-character display (SCD), or when a system I/O error occurs that is related to the device.

**Attention:** Use only the recommended cleaning cartridge to clean the tape drive. Use of other than recommended cleaning cartridges can damage your drive and might void the warranty.

The tape drive will set the cleaning indicator when one of the following conditions occurs:

- The tape drive exceeds internal preset error thresholds in the drive.
- The tape drive exceeds the maximum recommended time between cleaning.

This is an internal drive calculation where the drive maintains information on the amount of data written and read and when this value reaches a total of approximately 20 full tape writes or reads the drive will request cleaning. The cleaning indicator will be turned on when the tape is ejected.

- There is a write or read failure of the tape drive to the data cartridge.

**Note:** When a cleaning cartridge that has been used the maximum number of times is inserted in the drive, the drive will turn on the fault indicator. The SCD displays 6 or 7 to indicate that the cleaning process is not done and the cleaning cartridge is no longer usable. If the fault indicator was on and a C was in the SCD prior to the cleaning process, the indicators will stay on after the depleted cleaning cartridge is removed. If these indicators were off prior to inserting the depleted cleaning cartridge, they will turn off once the depleted cleaning cartridge is removed from the drive.

To clean the tape drive, complete the following steps:

## Procedure

1. Make sure that the power is on for the tape drive.
2. If a tape cartridge is in the tape drive, eject and remove the cartridge.
3. Grasp the cleaning cartridge by the outer edges, with the insertion arrow on top and the write-protect switch facing you.
4. Slide the cartridge into the opening on the front of the drive until the loading mechanism pulls the cartridge into the drive.

## Results

After the cleaning cartridge has been inserted, the remainder of the cleaning process is automatic. The tape drive does the following actions:

- Loads the cleaning cartridge into the tape drive.
- Cleans the drive by moving the cleaning tape forward for approximately 30 seconds.
- Unloads the cleaning cartridge when the cleaning operation is complete.
- Indicates a successful cleaning operation by turning off the C in the SCD, if the C in the SCD was on prior to the cleaning process.

**Note:** If the cleaning operation is completed but the C in the SCD remains on, the cleaning cartridge might not be usable. Repeat the cleaning procedure with a new cleaning cartridge. If the C in the SCD still remains on, contact your authorized service provider.

To determine how many times a cleaning cartridge can be used, check the information printed on the cartridge. If you attempt to use a depleted cleaning cartridge the fault indicator will be turned on and the SCD displays 6 or 7 to indicate that the cleaning process was not done and the cleaning cartridge is no longer usable. If the fault indicator was on and a C was in the SCD prior to the cleaning process, the indicators will stay on after the depleted cleaning cartridge is removed. If these indicators were off prior to inserting the depleted cleaning cartridge, they will turn off once the depleted cleaning cartridge is removed from the drive.

If a system error occurs, clean the drive and retry the operation. If the operation fails, replace the data cartridge, clean the drive again, and then retry the operation.

## Maintenance mode (FC 5746)

Learn about using maintenance mode functions on the 5746 tape drive.

## Performing operations using the front panel

Perform maintenance operations by pushing the eject button while observing the status LED and the single-character display.

### Entering maintenance mode

To enter maintenance mode (if the drive is not already in maintenance mode and no cartridge is loaded), press and hold the eject button for 6 seconds. While the drive is in maintenance mode, the status LED is shows solid amber and the operator can perform maintenance or diagnostic functions. In maintenance mode, the tape drive is offline to SCSI commands.

**Note:** If a tape is loaded, the eject button is interpreted as an eject request. The drive cannot be put into maintenance mode while a tape is loaded.

### Scrolling through maintenance options

With the drive in maintenance mode, press the eject push button at a rate of once per second. The single-character display code increments by one each time you press the eject push button.

**Note:** Do not press the eject push button more frequently than once per second or the selected maintenance function will occur instead of the desired scrolling operation.

After the last maintenance function is reached, the display code wraps to 0. Unassigned digits (B, D, and G) are not displayed when the options are incremented.

The following table lists the maintenance functions.

*Table 11. Maintenance functions*

Maintenance functions	Display code
Normal mode	None
Exit maintenance mode	0
Drive diagnostics	1
Update drive microcode from the firmware microcode release (FMR) tape	2
Create FMR tape	3
Force a drive dump (same as pressing the eject button for 10 or more seconds, except it does not cause a reset operation)	4
Copy drive dump to tape at the beginning of tape	5
Copy drive dump to tape	5-1
Copy drive dump to flash memory	5-2
Clear flash dump	5-3
SCSI wrap test	6
SAS wrap test for port 1	6-1
SAS wrap test for port 2	6-2
SAS wrap test for both ports	6-3
RS-422 wrap test	7
Unmake FMR tape	8
Display error code log	9

Table 11. Maintenance functions (continued)

Maintenance functions	Display code
Clear error code log	A
Insert cartridge into tape drive	C
Test cartridge and media	E
Write performance test	F
Test head	H
Fast write test	J
Load/unload test	L
Enable post-error reporting	P
Disable post-error reporting	U

## Running a maintenance function

To run the maintenance function indicated by the character on the single-character display, press and hold the eject button for 2 seconds. The single digit flashes the selected maintenance function code during the running of the operation. If the drive runs the function successfully, the single-character display indicates 0. If the function fails, the status LED indicates continuous yellow and the single-character display indicates the reason for the error by displaying an error code. For a list of error codes, see Table 9 on page 12.

## Exiting maintenance mode

To exit maintenance mode, press the eject button twice within one second:

- While the single-character display indicates 0.
- When the selected maintenance function is completed either successfully or unsuccessfully.
- When the eject button is pressed during any currently running maintenance function.

## Running a dump operation when not in maintenance mode

To perform a drive dump operation, press and hold the eject button for 10 or more seconds. The microcode goes to its initialized state after a dump operation.

**Note:** Data from a dump operation is for use by trained personnel for problem determination.

## Resetting the tape drive

You might need to reset your tape drive. Use the procedure in this topic to perform this task.

### About this task

Use this information to reset your tape drive, without affecting server operation. Allow up to 2 minutes for the entire tape drive process to complete.

**Attention:** Resetting a tape drive before the current backup operation has completed can cause loss of customer data.

To reset the tape drive, follow these steps:

## Procedure

1. Press and hold the eject button for 20 seconds, and then release the button. The LEDs on the drive will be flashing while the reset function is in process.
2. When the LEDs stop flashing, wait approximately one minute for the drive to complete the reset operation. The drive will then be ready to use.

## Performing the internal self-test (FC 5746)

Use the information in this section to perform an internal self-test on your tape drive.

This procedure is designed to allow you to quickly perform a complete set of diagnostic tests on your LTO-4 tape drive, without impacting server operation. This 4-minute test can also be used to verify good performance of individual LTO tape cartridges. For an illustration of the tape drive and the LED status lights that are referred to in this procedure, see Figure 1 on page 12

## Prerequisites

In order to perform the test you need a blank LTO-4 (Ultrium 4) data cartridge. If an Ultrium-4 data cartridge is not available, an Ultrium-3 cartridge can be substituted.

## Performing the test

Follow these steps to perform the test:

**Attention:** Use a blank data cartridge to perform the test. During the test, the tape will be overwritten with a test pattern and all data on the tape will be destroyed.

1. Enter diagnostic mode by doing the following steps:
  - a. Verify that a tape cartridge is not loaded in the drive. To unload a cartridge, press the eject button on the front of the drive.
  - b. Press and hold the eject button for 7 seconds, until all LEDs become active, and then release the button.  
The Ready LED will continue flashing, the Fault LED will remain on, and a 1 is displayed in the Single-character display (SCD). This combination indicates that the drive is waiting for a cartridge to be inserted.
2. Start the self-test by inserting a blank, Ultrium 4 data cartridge into the drive.

If an Ultrium-4 data cartridge is not available, an Ultrium-3 cartridge can be substituted.

### Notes:

- A cartridge must be loaded within 15 seconds or the drive will automatically revert back to normal operation. If necessary, return to step 1 to reenter diagnostic mode.
- The test takes about 4 minutes.
- Use a cartridge that is not write-protected. If a write-protected cartridge is inserted while the drive is in diagnostic mode, the cartridge will be ejected. See Table 12 on page 20.
- Self-testing can only be performed using a write-compatible (either Ultrium-4 or Ultrium-3) cartridge type, and with a cartridge that is not damaged. See Table 12 on page 20.
- If a cleaning cartridge is inserted while the drive is in diagnostic mode, it will be ejected.

While self-testing is in progress, the LEDs will remain active and the following test steps are performed:

- The hardware test runs for about one minute. During that time, a static test is performed on the electrical components of the drive, and proper operation of the cartridge load/unload mechanism is verified.
- The write/read test runs for about three minutes.

## Interpreting the results

Table 12. Interpreting the results of the self-test

Result	Description
Test passed	<p>When self-testing has completed successfully and no problems were detected, the cartridge is unloaded from the drive and all LEDs are off. Proper function of both the drive and tape cartridge have been verified. The drive is no longer in diagnostic mode, and has been returned to normal operation.</p> <p>If the yellow Fault LED remains on and a C is displayed in the SCD, this combination indicates that self-testing has completed successfully but that cleaning is required. Clean the drive by inserting a cleaning cartridge.</p>
Drive failure	<p>When a drive problem is detected, the cartridge remains loaded inside the drive, the yellow Fault LED flashes, and a 5 is displayed in the SCD. Replace the tape drive.</p>
Media failure	<p>When a media problem is detected, the cartridge remains loaded inside the drive, the yellow Fault LED remains on, and a 7 is displayed in the SCD. Repeat the self-test using another blank tape cartridge and discard the defective media.</p>
Incorrect cartridge	<p>When an incorrect tape cartridge is used for the test, the cartridge is unloaded, the yellow Fault LED remains on, and a P, 7, or J is displayed in the SCD. This can happen if the cartridge is:</p> <ul style="list-style-type: none"><li>• Write-protected (P is displayed in the SCD.)</li><li>• Damaged (7 is displayed in the SCD.)</li><li>• Not write-compatible with the drive (J is displayed in the SCD.)</li></ul> <p>Press the eject button to end the self-test and return the drive to normal operating mode. Then return to step 1 and run the self-test again using a suitable cartridge.</p>

## Returning to normal operation

When self-testing has completed successfully, the tape cartridge is unloaded. The drive is no longer in diagnostic mode and returns to normal operation.

When self-testing fails, the tape cartridge remains loaded inside the drive, and the drive remains in diagnostic mode. Press the eject button to unload tape cartridge and return drive to normal operation.

---

## 200/400 GB Half High Ultrium 2 tape drive (FC 5755)

Learn about the features of this media device.

The LTO half-high tape drive is a SCSI device that can be used for backing up, restoring and archiving data. These files can include multimedia, imaging, transaction processing, large databases, and other storage-intensive applications. Each tape cartridge can store up to 200 GB of data (uncompressed), or up to 400 GB of data (compressed), assuming a 2 to 1 compression ratio.

**Note:** The actual capacity varies depending on the application, the type of data, and the tape cartridge. 200 GB is typical and 400 GB is possible when the Data Compression setting is activated. The default setting of Data Compression is controlled by the host system. The user and the application software can control the activation or deactivation of the data compression setting. The drive can optimally achieve a 2:1 compression ratio.

The LTO half-high tape drive FRU part number is 23R3248

The custom card identification number (CCIN): 63A0

The LTO half-high tape drive features:



- A sustained native data transfer rate of up to 24 MB per second, 48 MB per second at 2:1 compression
- Downward read and write compatibility with earlier LTO-type data cartridges.
- Uses the self-configuring SCSI device driver native to the host operating system.
- Can be used as an bootable device, depending on the host system configuration.
- 5.25-inch half-high form factor
- Streaming operation

Attributes required: One 1.6-inch (41 mm) half-high media bay and one SCSI-2 internal 16-bit address

## Cleaning the tape drive (FC 5755)

You will need to clean your tape drive. Use the procedure in this topic to perform this task.

### About this task

Clean the device whenever the Fault status light comes on or a system I/O error related to the device occurs.

**Attention:** Use only the recommended cleaning cartridge to clean the tape drive. Use of other than recommended cleaning cartridges can damage your drive and might void the warranty.

The tape drive will turn on the cleaning indication for several reasons:

- - The tape drive exceeds internal preset error thresholds in the drive.
- - A cleaning cartridge that has been used the maximum number of times is inserted in the drive. The cleaning indicator is turned on to indicate that the cleaning process was not done and the cleaning cartridge is no longer usable.
- The tape drive exceeds the maximum recommended time between cleaning.

The maximum recommended time between preventive-maintenance cleaning is 100 tape motion hours. Tape motion hours are defined as the time that the tape drive is moving tape. If the tape drive reaches 100 tape motion hours since the tape drive was last cleaned, the drive will turn on the cleaning required LED to indicate the drive needs cleaning. The tape drive will continue to operate but it is recommended the tape drive be cleaned at the next opportunity to insert a cleaning cartridge.

To clean the tape drive, complete the following steps:

### Procedure

1. Make sure that the power is on for the tape drive.
2. If a tape cartridge is in the tape drive, eject and remove the cartridge.
3. Grasp the cleaning cartridge by the outer edges, with the window-side up and the write-protect switch facing you.
4. Slide the cartridge into the opening on the front of the drive until the loading mechanism pulls the cartridge into the drive.

### Results

After the cleaning cartridge has been inserted, the remainder of the cleaning process is automatic. The tape drive does the following actions:

- Loads the cleaning cartridge into the tape drive.
- Cleans the drive by moving the cleaning tape forward for approximately 30 seconds.
- Unloads the cleaning cartridge when the cleaning operation is complete.

- Indicates a successful cleaning operation by turning off the Cleaning status light (if the Cleaning light was on prior to the cleaning process. Otherwise, the Cleaning light remains solid to indicate that the cleaning cartridge is no longer usable. Obtain a new cleaning cartridge and repeat the process.)

**Note:** If the cleaning operation completes but the Cleaning light remains on, repeat the cleaning procedure with a new cleaning cartridge. If the light still remain on, contact your authorized service representative.

To determine how many times a cleaning cartridge may be used, check the information printed on the cartridge. If you attempt to use a depleted cleaning cartridge, the drive automatically detects the error and ejects the cartridge. If the Cleaning status light was on prior to the cleaning process, it stays on; if the Cleaning light was off, the depleted cartridge causes the light to come on.

If a system error occurs, clean the drive and retry the operation. If the operation fails, replace the data cartridge, clean the drive again, then retry the operation.

## Setting the write-protect switch (FC 5755)

You might need to set the write-protect switch on the media. Use the information in this topic to perform this task.

**Attention:** Do not attempt to change the write-protect settings after the tape cartridge is loaded in the drive because this might cause unpredictable results and might damage the tape or the drive.

The position of the write-protect switch on the tape cartridge determines when you can write to the tape. Before loading cartridges into magazines, set the write-protect switch of each cartridge to enable or disable data recording. When the switch is set to the left, data can be written to the tape. When the switch is set to the right, data cannot be written to the tape.

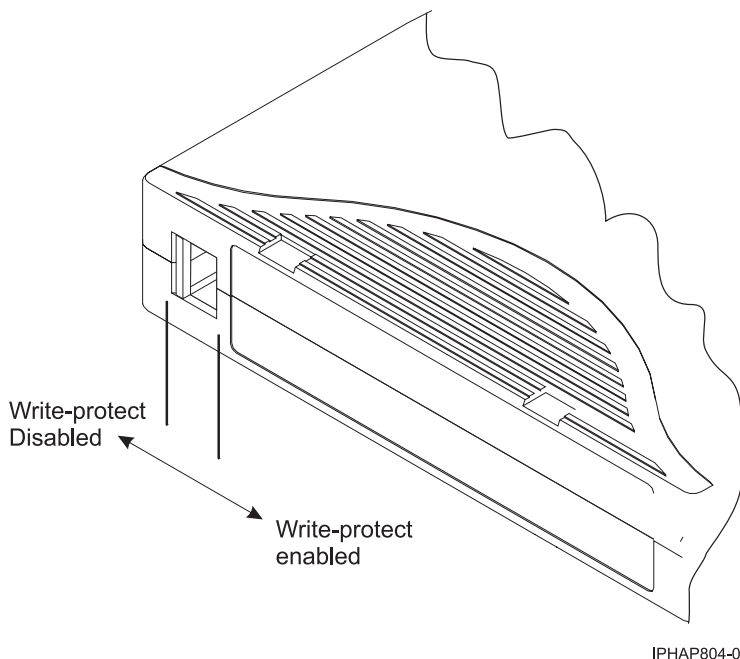

## Status lights (FC 5755)

You might need to read the status lights on your tape drive to determine the operating status of the drive. Use the information in this topic to perform this task.

The following illustration shows a front view of the tape drive:

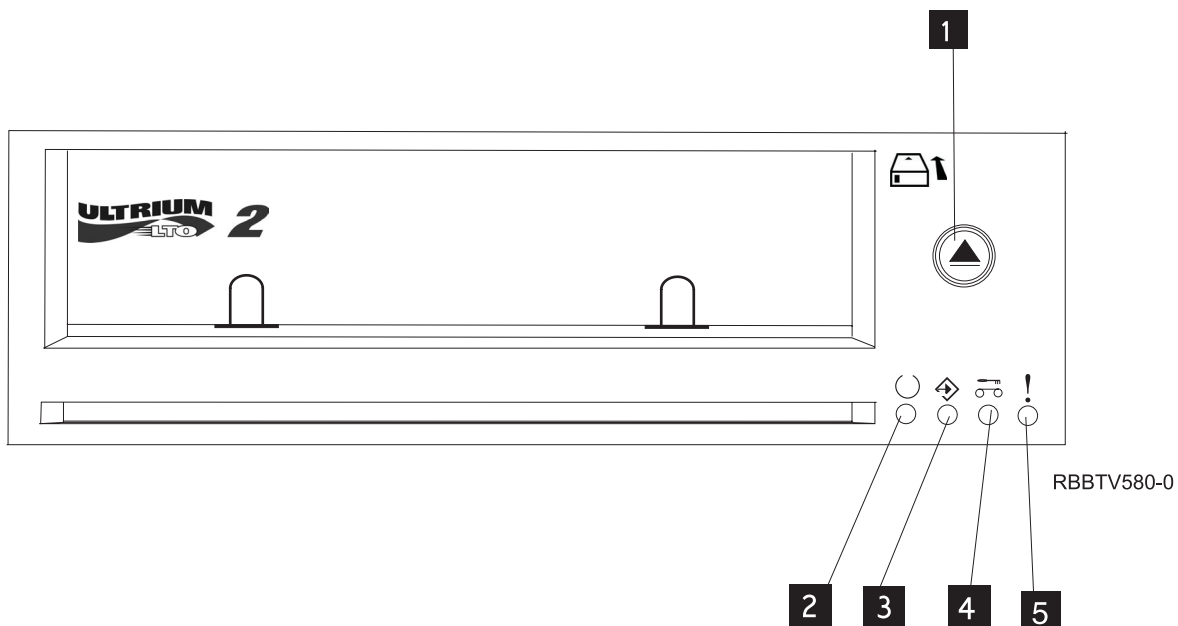

Figure 2. Front view of tape drive

- 1 Eject button
- 2 Ready (green)
- 3 Active (green)
- 4 Cleaning (amber)
- 5 Fault (amber)

The status lights and their ISO symbols are on the device as follows:

Ready  (green)

Activity  (green)

Cleaning  (amber)

Fault  (amber)

The combinations of the lights and their definitions are shown in the following table.

Table 13. Definition of Status Light Combinations





Operation	Ready 	Activity 	Cleaning 	Fault 
Power-On LED Test <sup>1</sup>	On for 2.0 seconds	On for 2.0 seconds	On for 2.0 seconds	On for 2.0 seconds
Power-On Self-Test (POST) is in progress <sup>2</sup>	Flashing	Off	Off	Off

Table 13. Definition of Status Light Combinations (continued)









Operation	Ready 	Activity 	Cleaning 	Fault 
A cartridge is not loaded	Off	Off	On <sup>3</sup> /Off	Off
Cartridge loaded, no activity	On	Off	On <sup>3</sup> /Off	Off
Data cartridge loaded, activity	On	Flashing	On <sup>3</sup> /Off	Off
Cleaning cartridge loaded, activity	On	Flashing	On	Off
Cleaning cartridge loaded, cleaning failed	Off	Off	On <sup>3 4</sup>	Off
Cartridge is loading or unloading	Off	Flashing	On <sup>3</sup> /Off	Off
Unrecoverable drive failure	On/Off	Off	On <sup>3</sup> /Off	Flashing <sup>5</sup>
Firmware download is in progress	Flashing	Off	On <sup>3</sup> /Off	Off
Firmware update is in progress	Flashing	Flashing	On <sup>3</sup> /Off	Off
Firmware download failure <sup>6</sup>	Off	Off	On <sup>3</sup> /Off	Flashing <sup>5</sup>
Maximum operating temperature exceeded <sup>7</sup>	Off	Off	On <sup>3</sup> /Off	On
Diagnostics test is in-progress	Flashing	Off or Flashing	On <sup>3</sup> / Off	Off
Media failure <sup>8</sup>	Off	Off	Flashing	Off
Incorrect media inserted in drive <sup>8</sup>	Off	Both LEDs Flashing Together		Off

Table 13. Definition of Status Light Combinations (continued)

Operation	Ready 	Activity 	Cleaning 	Fault 
<p><sup>1</sup> All 4 LEDs will be on solid for 2 seconds.</p> <p><sup>2</sup> If the drive completes Power-On Self-Test (POST) within 2 seconds, no POST in progress indication is required.</p> <p><sup>3</sup> A solid amber Clean LED indicates that the drive needs cleaning. In most cases the drive will continue to function, but it should be cleaned as soon as possible.</p> <p><sup>4</sup> If the cleaning function completes and the solid amber Clean LED remains lit, the cleaning function was not successful. The cleaning cartridge may be depleted. Obtain a new LTO cleaning cartridge and use it to perform the cleaning function again.</p> <p><sup>5</sup> The Fault LED will flash to indicate an unrecoverable error. An unrecoverable error is an error condition that results in the drive not being able to function unless initiator, operator, or service intervention is applied. An unrecoverable drive failure is usually the result of a hardware error condition. One of the following actions will be needed to clear the flashing Fault LED:</p> <ul style="list-style-type: none"> <li>• Hard SCSI reset</li> <li>• Cartridge eject</li> <li>• Power cycle</li> <li>• Retry microcode download</li> </ul> <p>An unrecoverable cartridge (media) failure is usually the result of a defective cartridge, media, or cartridge state and will require the drive to eject the cartridge (if possible) to clear the flashing LED.</p> <p><sup>6</sup> The firmware download failed and the drive is not functional. The drive boot code is in control and the firmware download must be retried.</p> <p><sup>7</sup> When the Fault LED is solid, it indicates an over temperature condition. The drive has exceeded its preset temperature limit, and if a tape is present in the drive it will be ejected. The Fault LED will remain solid until the drive temperature drops below a secondary temperature limit, and a data or cleaning cartridge is inserted.</p> <p><sup>8</sup> While running drive diagnostics (using either SEND DIAG or the Self-Test Procedure), a media-related problem (hard media error or excessive soft error rate) will be reported as a media failure (with flashing Clean LED), and a write-protected, damaged, or incompatible cartridge will be reported as incorrect media (with Activity and Clean LEDs flashing simultaneously).</p>				

## Tape cartridges (FC 5755)

Learn about the types of tape cartridges that are available for this drive.

### Available tape cartridges

Table 14. LTO Ultrium data cartridges

Part Number	Type of Cartridge	Length
08L9120	100/200GB LTO Ultrium 1 Data Cartridges	610 m (2000 ft )
08L9870	200/400GB LTO Ultrium 2 Data Cartridges	610 m (2000 ft )
24R0395	LTO Gen-2 Test Tape	610 m (2000 ft )
35L2086	Universal Cleaning Tape	--

**Attention:** Do not attempt to bulk erase an LTO data cartridge for reuse. Bulk eraser devices cannot properly erase an LTO data cartridge and will permanently damage the cartridge.

## Resetting the tape drive (FC 5755)

You might need to reset your tape drive. Use the procedure in this topic to perform this task.

### About this task

Use this information to reset your half-high LTO-2 tape drive, without impacting server operation. Please allow up to 2 minutes for the entire tape drive process to complete.

**Attention:** Resetting a tape drive before the current backup operation has completed may cause loss of customer data.

To reset the tape drive, follow these steps:

### Procedure

1. Press and hold the eject button for 7 seconds, until the green Ready LED starts flashing rapidly, then release the button. The Ready LED will continue flashing, indicating that the drive is waiting for a cartridge to be inserted.
2. Press and release the eject button. The green Activity LED will begin flashing rapidly.
3. Double-click the eject button. The Activity LED will continue flashing slowly while the reset function is in progress. When the reset function is complete, the tape cartridge will remain in the drive and the Ready LED will be lit. Allow up to 2 minutes for the reset function to complete.

**Note:** A solid amber Cleaning LED light indicates that the reset is complete, but the tape unit requires cleaning. Clean the tape unit by inserting a Universal LTO Cleaning Cartridge (part number 35L2086).

### Results

After the reset function completes, the tape unit is restored to normal operating mode. To remove the cartridge, press the eject button.

## Performing the internal self-test (FC 5755)

Use the information in this section to perform an internal self-test on your tape drive.

Use the following procedure to quickly perform a complete set of diagnostic tests on your LTO-2 tape drive, without affecting server operation. This 5-1/2 minute test can also be used to verify good performance of individual LTO tape cartridges. For an illustration of the tape drive and the LED status lights that are referred to in this procedure, see Figure 2 on page 23.

### Prerequisites

In order to perform the test you need the following items:

- Half High LTO-2 Tape Drive: Firmware code v0330 or higher
- One LTO cleaning cartridge
- One test tape (P/N 24R0395) or one blank LTO-2 (Ultrium 2) data cartridge

## Performing the test

Follow these steps to perform the test:

**Attention:** Use a test tape or blank (scratch) tape to perform the test. During the test, the tape will be overwritten with a test pattern and all data on the tape will be destroyed.

1. Enter diagnostic mode by doing the following steps:
  - a. Verify that a tape cartridge is not loaded in the drive. To unload a cartridge, press the eject button on the front of the drive.
  - b. Press and hold the eject button for 7 seconds, until the green Ready LED starts flashing rapidly, and then release the button. The Ready LED will continue flashing, indicating that the drive is waiting for a cartridge to be inserted.
2. Start the self-test by inserting a test tape into the drive. If a test tape is not available, you can substitute any blank LTO Ultrium-2 cartridge.

A cartridge must be loaded within 15 seconds or the drive will automatically revert back to normal operation. If necessary, return to step 1 to reenter diagnostic mode.

### Notes:

- The test takes about 5-1/2 minutes.
- At any time, self-testing can be stopped by pressing the eject button. After a current test operation is completed, the cartridge will be ejected and drive will return to normal operation.
- Use a cartridge that is not write-protected. If a write-protected cartridge is inserted while the drive is in diagnostic mode, the cartridge will be ejected.
- Self-testing can only be performed using an undamaged, write-compatible, Ultrium-2 cartridge. If a write-protected or damaged cartridge is used, refer to Incorrect cartridge in Table 15.
- If a cleaning cartridge is inserted while the drive is in diagnostic mode, cleaning will occur and the drive will then return to normal operating mode. To reenter diagnostic mode, return to step 1.
- While self-testing is in progress, the Ready LED continues to flash. The following three test steps are performed:
  - The initialization sequence has an approximate duration of 20 seconds. The Activity LED indicates tape movement.
  - The hardware test has an approximate duration of 2 minutes. During that time, a static test is performed on the electrical components of the drive, and proper operation of the cartridge load/unload mechanism is verified.
  - The write/read test has an approximate duration of three minutes. The Activity LED indicates tape movement.

## Interpreting the results

Table 15. Interpreting the results of the self-test

Result	Description
Test passed	<p>When self-testing has completed successfully and no problems were detected, the cartridge is unloaded from the drive and all LEDs are off. Proper function of both the drive and tape cartridge have been verified. The drive is no longer in diagnostic mode, and has been returned to normal operation.</p> <p>If the yellow Clean LED remains on, it indicates that self-testing has completed successfully but that cleaning is required. Clean the drive by inserting a cleaning cartridge.</p>
Drive failure	<p>When a drive problem is detected, the cartridge will remain loaded inside the drive and the yellow Fault LED will flash. Contact your service provider for assistance.</p>
Media failure	<p>When a media problem is detected, the cartridge will remain loaded inside the drive, and the yellow Clean LED will flash. Repeat self-test using another blank tape cartridge.</p>

Table 15. Interpreting the results of the self-test (continued)

Result	Description
Incorrect cartridge	<p>When an incorrect tape cartridge is used for the test, the cartridge is unloaded and both the Activity and Clean LEDs will flash. This can happen if the cartridge is:</p> <ul style="list-style-type: none"> <li>• Write-protected</li> <li>• Damaged</li> <li>• Not write-compatible with the drive</li> </ul> <p>Press the eject button to end the self-test and return the drive to normal operating mode. Then return to step 1 and run the self-test again using a suitable cartridge.</p>

## Returning to normal operation

When self-testing has completed successfully, the tape cartridge is unloaded. The drive is no longer in diagnostic mode and returns to normal operation.

When self-testing fails, the tape cartridge remains loaded inside the drive, and the drive remains in diagnostic mode. Press the eject button to unload tape cartridge and return drive to normal operation.

---

## 160/320 GB internal tape drive VXA-320 (FC 6279)

Learn about the features of this media device.

<b>Description</b>	<p>The 160/320 GB Internal Tape Drive with VXA Technology is a 5.25-inch, half-high, Ultra2 LVD 16-bit tape drive, which provides a high capacity for save/restore and achieve functions. This tape drive uses VXA tape data cartridges and is capable of compression, providing a capacity of up to 320 GB.</p> <p>Characteristics:</p> <ul style="list-style-type: none"> <li>• FRU part number: 95P1976</li> <li>• Custom card identification number (CCIN): 63A0</li> <li>• Capacity: 160 GB native mode, 320 GB (typical) compression mode</li> <li>• Form Factor: 5.25-inch half high</li> <li>• Media: uses VXA tape data cartridges</li> <li>• Technology: Helical scan, rotating head</li> <li>• Operation: Streaming</li> <li>• Data Transfer Rate: 12 MBps native mode, 24 MBps (typical) compression</li> <li>• Interface: SCSI-2 (LVD/SE) asynchronous/synchronous</li> <li>• Compatibility: 160 GB mode (Read/Write), 320 GB compression (Read/Write)</li> <li>• Attributes provided: One 160/320 GB internal tape drive</li> <li>• Attributes required: One 1.6-inch (41 mm) half-high media bay and one SCSI-2 internal 16-bit address</li> </ul>
<b>Tools</b>	<p>The following tools and documentation are needed to complete the installation:</p> <ul style="list-style-type: none"> <li>• A flat-blade screwdriver (if this device is not an auto-docking feature on your system)</li> <li>• Your system unit documentation, including any service documentation</li> <li>• Your operating system documentation</li> </ul> <p>If an item is missing or damaged, contact the place of purchase.</p>



<b>Related information</b>	<p>Check that your package contains the following items:</p> <ul style="list-style-type: none"> <li>• The device</li> <li>• Media kit containing: <ul style="list-style-type: none"> <li>– 1 cleaning cartridge</li> <li>– 1 test tape</li> <li>– Jumpers (located in a plastic bag)</li> </ul> </li> <li>• Specific hardware for attaching the device to your specific system, as detailed on the parts listing provided with your device</li> </ul>
----------------------------	---

## Cleaning the tape drive (FC 6120 and 6279)

You will need to clean your tape drive. Use the procedure in this topic to perform this task.

### About this task

Clean the device whenever the Fault status light comes on or a system I/O error related to the device occurs.

**Attention:** Use only the recommended cleaning cartridge to clean the tape drive. Use of other than recommended cleaning cartridges can damage your drive and might void the warranty.

The tape drive will turn on the cleaning indication for several reasons:

- The tape drive exceeds internal preset error thresholds in the drive.
- A cleaning cartridge that has been used the maximum number of times is inserted in the drive. The cleaning indicator is turned on to indicate that the cleaning process was not done and the cleaning cartridge is no longer usable.
- The tape drive exceeds the maximum recommended time between cleaning.

The maximum recommended time between preventive-maintenance cleaning is 75 tape motion hours. Tape motion hours are defined as the time that the tape drive is moving tape. If the tape drive reaches 75 tape motion hours since the tape drive was last cleaned the drive will turn on the cleaning required LED to indicate the drive needs cleaning. The tape drive will continue to operate but it is recommended the tape drive be cleaned at the next opportunity to insert a cleaning cartridge.

To clean the tape drive, complete the following steps:

### Procedure

1. Make sure that the power is on to the tape drive.
2. If a tape cartridge is in the tape drive, eject and remove the cartridge.

**Note:** Some cleaning cartridges have white dots on the window side that are designed to be used to log the use of the cartridge. Each time the cartridge is used, mark one of the dots on the cartridge with a pen or marker. When all of the dots have been marked, discard the cleaning cartridge.

3. Grasp the cleaning cartridge by the outer edges, with the window-side up and the write-protect switch facing you.
4. Slide the cartridge into the opening on the front of the drive until the loading mechanism pulls the cartridge into the drive and the drive door closes.

### Results

After the cleaning cartridge has been inserted, the remainder of the cleaning process is automatic. The tape drive does the following actions:

- Loads the cleaning cartridge into the tape drive.
- Cleans the drive by moving the cleaning tape forward for approximately 30 seconds.
- Unloads the cleaning cartridge when the cleaning operation is complete.
- Indicates a successful cleaning operation by turning off the Cleaning status light (if the Cleaning light was on prior to the cleaning process. Otherwise, the Cleaning light remains solid to indicate that the cleaning cartridge is no longer usable. Obtain a new cleaning cartridge and repeat the process.)

**Note:** If the cleaning operation completes but the Cleaning light remains on, repeat the cleaning procedure with a new cleaning cartridge. If the light still remain on, contact your authorized service representative.

To determine how many times a cleaning cartridge may be used, check the information printed on the cartridge. If you attempt to use a depleted cleaning cartridge, the drive automatically detects the error and ejects the cartridge. If the Cleaning status light was on prior to the cleaning process, it stays on; if the Cleaning light was off, the depleted cartridge causes the light to come on.

If a system error occurs, clean the drive and retry the operation. If the operation fails, replace the data cartridge, clean the drive again, then retry the operation.

## Loading and unloading cartridges

Learn about loading and unloading tape cartridges from this drive.

### About this task

To avoid problems with loading and unloading, use only one label on a cartridge. If the cartridge has too many or poorly-placed labels, the drive-load mechanism might clog.

### Loading a cartridge

#### About this task

To load a cartridge, complete the following steps:

#### Procedure

1. Make sure that the tape device power is on.
2. Grasp the cartridge by the outer edges, with the window side up and the write-protect switch facing you.

**Note:** Make sure that the write-protect switch is correctly set.

3. Slide the cartridge into the opening on the front of the device until the loading mechanism pulls the cartridge into the drive and the drive door closes.

#### Results

To indicate that the load operation was successful, the Ready status light comes on.

### Unloading a cartridge

#### About this task

To unload a cartridge, complete the following steps:

#### Procedure

1. Make sure that the tape device power is on.
2. Press the Unload button. The device rewinds, unloads, and ejects the tape cartridge.

The process might take from 15 seconds to several minutes, depending on the position of the tape and the amount of data written. During this task, the status lights do the following sequence:

- The Ready status light turns off.
- The Activity status light flashes during the unload operation.
- The Activity status light turns off when the cartridge is ejected from the tape drive.

## Results

**Attention:** An emergency eject and reset feature can be used to release the tape cartridge and reset the drive. Use the emergency eject feature if the cartridge does not move correctly or if the unload process fails. The emergency eject and reset feature procedure might result in loss of data. To perform an emergency eject operation of the tape cartridge or a reset operation of the drive, press and hold the Unload button for at least 10 seconds. If a cartridge is in the drive, the cartridge automatically ejects without rewinding the tape.

## Setting the write-protect switch (FC 6279)

You might need to set the write-protect switch on the media. Use the information in this topic to perform this task.

**Attention:** Do not attempt to change the write-protect settings after the tape cartridge is loaded in the drive because this might cause unpredictable results and might damage the tape or the drive.

The position of the write-protect switch on the tape cartridge determines when you can write to the tape.

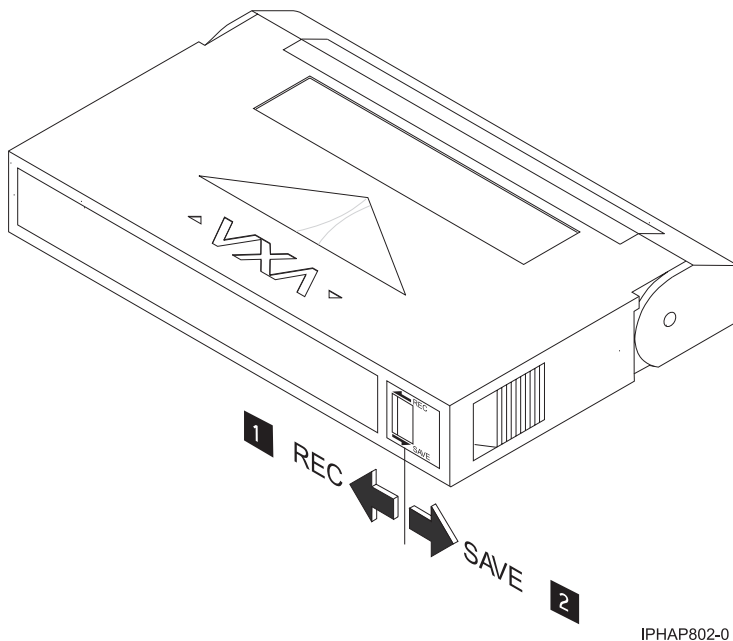

- 1 When the switch is set to the left, data can be written to and read from the tape.
- 2 When the switch is set to the right, data can only be read.

## Status lights (FC 6279)

You might need to read the status lights on your tape drive to determine the operating status of the drive. Use the information in this topic to perform this task.

The following is a front view of the tape drive:

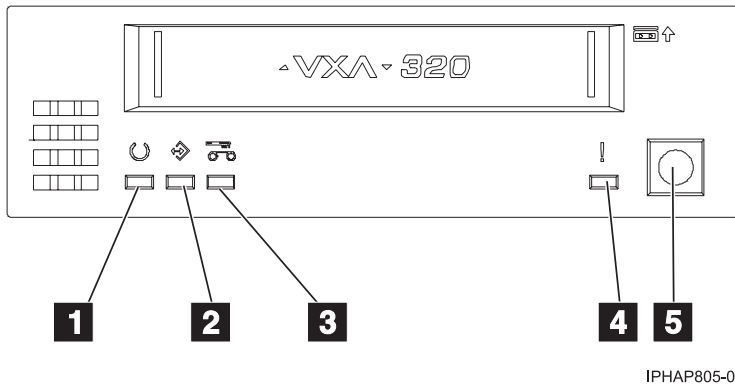



Figure 3. Front view of tape drive

- 1 Ready (green)
- 2 Active (green)
- 3 Cleaning (amber)
- 4 Fault (amber)
- 5 Eject button

The status lights and their ISO symbols are on the device as follows:

Ready  (green)

Activity  (green)

Cleaning  (amber)

Fault  (amber)

The combinations of the lights and their definitions are shown in the following table.

Table 16. Definition of Status Light Combinations









Operation	Ready 	Activity 	Cleaning 	Fault 
Power-on self-test <sup>1</sup>	Flashing	Off	Off	Off
Power On LED Test	On for 2.0 seconds	On for 2.0 seconds	On for 2.0 seconds	On for 2.0 seconds
No tape loaded	Off	Off	On <sup>2</sup> /Off	Off
Cartridge loaded, no activity	On	Off	On <sup>2</sup> /Off	Off
Data or Cleaning Cartridge loaded, activity	On	Flashing	On <sup>2</sup> /Off	Off
Cleaning Cartridge loaded, cleaning failed <sup>2</sup>	Off	Off	On <sup>2</sup>	Off

Table 16. Definition of Status Light Combinations (continued)

Operation	Ready 	Activity 	Cleaning 	Fault 
Cartridge loading or unloading <sup>2</sup>	Off	Flashing	On <sup>2</sup> /Off	Off
Unrecoverable drive failure <sup>3</sup>	On/Off	Off	On <sup>2</sup> /Off	Flashing <sup>3</sup>
Firmware Download	Flashing	Off	On <sup>2</sup> /Off	Off
Firmware Update	Flashing	Flashing	On <sup>2</sup> /Off	Off
Microcode Download failure <sup>4</sup>	Off	Off	On <sup>2</sup> /Off	Flashing <sup>3</sup>
Over Temperature <sup>5</sup>	Off	Off	On <sup>2</sup> /Off	On

#### Notes:

1. If the drive completes the power-on self-test (POST) within the 2.0 second Power On LED Test time, the POST indicator sequence is eliminated.
2. A solid amber LED indicates the drive needs cleaning. The drive will continue to function, but, needs cleaning as soon as possible. A power cycle does not turn off this indicator.
3. The Fault LED will flash to indicate an unrecoverable error. An unrecoverable error is an error condition that results in the drive not being able to function unless initiator, operator, or service intervention is applied. An unrecoverable drive failure is usually the result of a hardware error condition. One of the following actions will be needed to clear the flashing Fault LED:
  - Hard SCSI Reset
  - Cartridge Eject
  - Power Cycle
  - Retry microcode download

An unrecoverable cartridge (media) failure is usually the result of a defective cartridge, media, or cartridge state and will require the drive to eject the cartridge (if possible) to clear the flashing LED.
4. The firmware download failed and the drive is not functional. The drive boot code is in control and the microcode download should be retried. The drive can be identified using the Inquiry command and is bootable while in this state.
5. The Fault LED will be on solid to indicate an over temperature condition.

## Performing the internal self-test (FC 6120 or 6279)

Use the information in this topic to perform an internal self-test on your tape drive.

### Prerequisites

In order to perform the test, you need the following items:

- One VXA-2 tape drive with firmware code V2123 or higher, or one VXA-320 tape drive with firmware V3209 or higher
- One VXA cleaning cartridge X style
- One blank VXA X23 data cartridge

## Performing the test

Follow these steps to perform the internal self-test:

**Attention:** Use a blank tape to perform the test. During the test, the tape is overwritten with a test pattern and all data on the tape is destroyed.

1. Clean the tape drive.
2. Press the blue eject button for 7 seconds. When the Ready LED blinks rapidly, insert the blank, X23 data cartridge.

The tape drive performs the internal self-test. The test can take up to 15 minutes. After successful completion, the media is ejected.

## Interpreting the results





The following table shows how to interpret the results of the internal self-test using the status lights. To see a front-view illustration of the tape drive and status lights, see one of the following illustrations.

VXA-320 tape drive: Figure 3 on page 32

VXA-2 tape drive: Figure 4 on page 39

If the internal self-test passes, then the tape drive has no hardware fault and no further tests are required. If the internal self-test indicates a drive failure, contact your service provider.

Table 17. Internal self-test status light combinations

Internal self-test operation	Ready 	Activity 	Cleaning 	Fault 	Media status
Initiated	Flashing rapidly	Off	Off	Off	Unloaded
Running	Flashing rapidly	Flashing	Off	Off	Loaded
Passed	Off	Off	Off	Off	Unloaded
Passed, cleaning needed	Off	Off	On	Off	Unloaded
Media failure <sup>1</sup>	Off	Off	Flashing	Off	Loaded
Media write-protected <sup>2</sup>	Off	Flashing	Flashing	Off	Unloaded
Internal self-test media not compatible <sup>1</sup>	Off	Flashing	Flashing	Off	Unloaded
Drive failure	Off	Off	Off	Flashing	Loaded

<sup>1</sup> Repeat the internal self-test with a different, blank X23 data cartridge.

<sup>2</sup> Repeat the internal self-test with a write-enabled, blank X23 data cartridge.

## Tape cartridges (FC 6279)

Learn about the types of tape cartridges that are available for this drive.

### Compatible tape cartridges

Types of tape cartridges are supported by this tape drive:

- X cartridges are the newer version of the VXA cartridge
- V cartridges are the original VXA cartridge

The V and X cartridges have similar shells and come in a variety of tape lengths. Both cartridges use Advanced Metal Evaporated (AME) media and offer the similar read/write speeds and capacities.

## Available tape cartridges

Table 18. X tape cartridges

Part Number	Description	Type	Other information
24R2137	230m 80/160GB	X23 Data Cartridge	Teal Accent
24R2136	124 m 40/80GB	X10 Data Cartridge	Teal Accent
24R2134	20/40GB	X6 Data Cartridge	Teal Accent
24R2135	62m 20/40GB	X6 Test Cartridge	Teal Accent
24R2138	X Cleaning Cartridge	VXA 20 usage	Teal Accent

Table 19. V tape cartridges

Part Number	Description	Type	Other information
19P4876	230m 80/160GB	V23 Data Cartridge	Purple accent

Most bulk eraser devices do not have the capability to erase the data cartridge. To properly erase a VXA data cartridge with a bulk eraser device, the erasure field strength must be a minimum of 4000 gauss.

## Resetting the tape drive

You might need to reset your tape drive. Use the procedure in this topic to perform this task.

### About this task

Use this information to reset your tape drive, without affecting server operation. Allow up to 2 minutes for the entire tape drive process to complete.

**Attention:** Resetting a tape drive before the current backup operation has completed can cause loss of customer data.

To reset the tape drive, follow these steps:

### Procedure

1. Press and hold the eject button for 20 seconds, and then release the button. The LEDs on the drive will be flashing while the reset function is in process.
2. When the LEDs stop flashing, wait approximately one minute for the drive to complete the reset operation. The drive will then be ready to use.

## 80/160 GB internal tape drive VXA-2 (FC 6120)

Learn about the features of this media device.

<b>Description</b>	<p>The 80/160 GB Internal Tape Drive with VXA Technology is a 5.25-inch, half-high, Ultra2 LVD 16-bit tape drive, which provides a high capacity for save/restore and achieve functions. This tape drive uses VXA tape data cartridges and is capable of compression, providing a capacity of up to 160 GB.</p> <p>Characteristics:</p> <ul style="list-style-type: none"><li>• FRU part number: 19P4898</li><li>• Custom card identification number (CCIN): 63A0</li><li>• Capacity: 80 GB native mode, 160 GB (typical) compression mode</li><li>• Form Factor: 5.25-inch half high</li><li>• Media: uses VXA tape data cartridges</li><li>• Technology: Helical scan, rotating head</li><li>• Operation: Streaming</li><li>• Data Transfer Rate: 6 MBps native mode, 12 MBps (typical) compression</li><li>• Interface: SCSI-2 (LVD/SE) asynchronous/synchronous</li><li>• Compatibility: 80 GB mode (Read/Write), 160 GB compression (Read/Write)</li><li>• Attributes provided: One 80/160 GB internal tape drive</li><li>• Attributes required: One 1.6-inch (41 mm) half-high media bay and one SCSI-2 internal 16-bit address</li></ul>
<b>Tools</b>	<p>The following tools and documentation are needed to complete the installation:</p> <ul style="list-style-type: none"><li>• A flat-blade screwdriver (if this device is not an auto-docking feature on your system)</li><li>• Your system unit documentation, including any service documentation</li><li>• Your operating system documentation</li></ul> <p>If an item is missing or damaged, contact the place of purchase.</p>
<b>Related information</b>	<p>Check that your package contains the following items:</p> <ul style="list-style-type: none"><li>• The device</li><li>• Media kit containing:<ul style="list-style-type: none"><li>– 1 data cartridge</li><li>– 1 cleaning cartridge</li><li>– 1 test tape</li><li>– Jumpers (located in a plastic bag)</li></ul></li><li>• Specific hardware for attaching the device to your specific system, as detailed on the parts listing provided with your device</li></ul>

## Cleaning the tape drive (FC 6120 and 6279)

You will need to clean your tape drive. Use the procedure in this topic to perform this task.

### About this task

Clean the device whenever the Fault status light comes on or a system I/O error related to the device occurs.

**Attention:** Use only the recommended cleaning cartridge to clean the tape drive. Use of other than recommended cleaning cartridges can damage your drive and might void the warranty.

The tape drive will turn on the cleaning indication for several reasons:



- The tape drive exceeds internal preset error thresholds in the drive.
- A cleaning cartridge that has been used the maximum number of times is inserted in the drive. The cleaning indicator is turned on to indicate that the cleaning process was not done and the cleaning cartridge is no longer usable.
- The tape drive exceeds the maximum recommended time between cleaning.

The maximum recommended time between preventive-maintenance cleaning is 75 tape motion hours. Tape motion hours are defined as the time that the tape drive is moving tape. If the tape drive reaches 75 tape motion hours since the tape drive was last cleaned the drive will turn on the cleaning required LED to indicate the drive needs cleaning. The tape drive will continue to operate but it is recommended the tape drive be cleaned at the next opportunity to insert a cleaning cartridge.

To clean the tape drive, complete the following steps:

## Procedure

1. Make sure that the power is on to the tape drive.
2. If a tape cartridge is in the tape drive, eject and remove the cartridge.

**Note:** Some cleaning cartridges have white dots on the window side that are designed to be used to log the use of the cartridge. Each time the cartridge is used, mark one of the dots on the cartridge with a pen or marker. When all of the dots have been marked, discard the cleaning cartridge.

3. Grasp the cleaning cartridge by the outer edges, with the window-side up and the write-protect switch facing you.
4. Slide the cartridge into the opening on the front of the drive until the loading mechanism pulls the cartridge into the drive and the drive door closes.

## Results

After the cleaning cartridge has been inserted, the remainder of the cleaning process is automatic. The tape drive does the following actions:

- Loads the cleaning cartridge into the tape drive.
- Cleans the drive by moving the cleaning tape forward for approximately 30 seconds.
- Unloads the cleaning cartridge when the cleaning operation is complete.
- Indicates a successful cleaning operation by turning off the Cleaning status light (if the Cleaning light was on prior to the cleaning process. Otherwise, the Cleaning light remains solid to indicate that the cleaning cartridge is no longer usable. Obtain a new cleaning cartridge and repeat the process.)

**Note:** If the cleaning operation completes but the Cleaning light remains on, repeat the cleaning procedure with a new cleaning cartridge. If the light still remain on, contact your authorized service representative.

To determine how many times a cleaning cartridge may be used, check the information printed on the cartridge. If you attempt to use a depleted cleaning cartridge, the drive automatically detects the error and ejects the cartridge. If the Cleaning status light was on prior to the cleaning process, it stays on; if the Cleaning light was off, the depleted cartridge causes the light to come on.

If a system error occurs, clean the drive and retry the operation. If the operation fails, replace the data cartridge, clean the drive again, then retry the operation.

## Loading and unloading cartridges

Learn about loading and unloading tape cartridges from this drive.

## About this task

To avoid problems with loading and unloading, use only one label on a cartridge. If the cartridge has too many or poorly-placed labels, the drive-load mechanism might clog.

### Loading a cartridge

#### About this task

To load a cartridge, complete the following steps:

#### Procedure

1. Make sure that the tape device power is on.
2. Grasp the cartridge by the outer edges, with the window side up and the write-protect switch facing you.

**Note:** Make sure that the write-protect switch is correctly set.

3. Slide the cartridge into the opening on the front of the device until the loading mechanism pulls the cartridge into the drive and the drive door closes.

#### Results

To indicate that the load operation was successful, the Ready status light comes on.

### Unloading a cartridge

#### About this task

To unload a cartridge, complete the following steps:

#### Procedure

1. Make sure that the tape device power is on.
2. Press the Unload button. The device rewinds, unloads, and ejects the tape cartridge.  
The process might take from 15 seconds to several minutes, depending on the position of the tape and the amount of data written. During this task, the status lights do the following sequence:
  - The Ready status light turns off.
  - The Activity status light flashes during the unload operation.
  - The Activity status light turns off when the cartridge is ejected from the tape drive.

#### Results

**Attention:** An emergency eject and reset feature can be used to release the tape cartridge and reset the drive. Use the emergency eject feature if the cartridge does not move correctly or if the unload process fails. The emergency eject and reset feature procedure might result in loss of data. To perform an emergency eject operation of the tape cartridge or a reset operation of the drive, press and hold the Unload button for at least 10 seconds. If a cartridge is in the drive, the cartridge automatically ejects without rewinding the tape.

## Setting the write-protect switch (FC 6120)

You might need to set the write-protect switch on the media. Use the information in this topic to perform this task.

**Attention:** Do not attempt to change the write-protect settings after the tape cartridge is loaded in the drive because this might cause unpredictable results and might damage the tape or the drive.

The position of the write-protect switch on the tape cartridge determines when you can write to the tape.

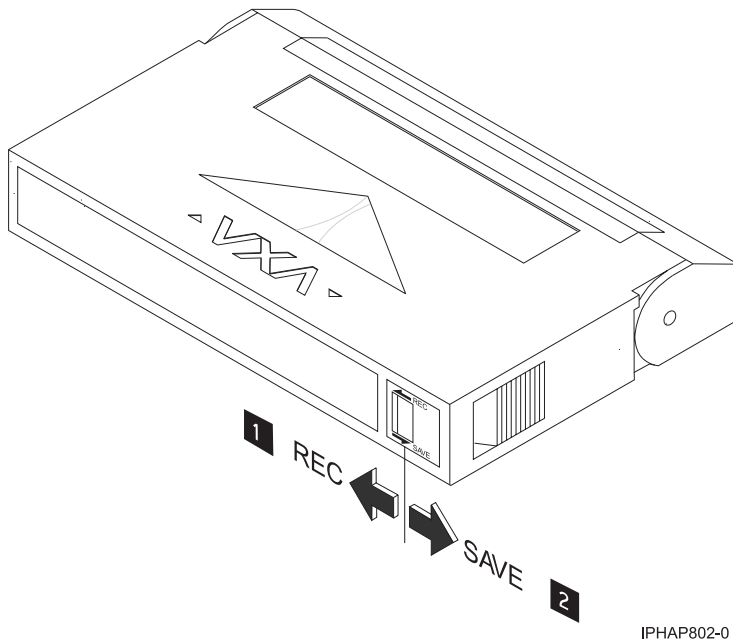

- 1 When the switch is set to the left, data can be written to and read from the tape.
- 2 When the switch is set to the right, data can only be read.

### Status lights (FC 6120)

You might need to read the status lights on your tape drive to determine the operating status of the drive. Use the information in this topic to perform this task.

The following illustration is a front view of the tape drive:

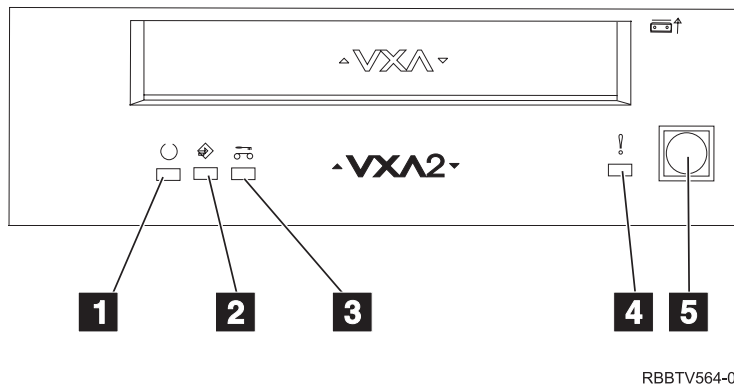

Figure 4. Front view of tape drive

- 1 Ready (green)
- 2 Active (green)

- 3 Cleaning (amber)
- 4 Fault (amber)
- 5 Eject button

The status lights and their ISO symbols are on the device as follows:

**Ready**  (green)





**Activity**  (green)

**Cleaning**  (amber)

**Fault**  (amber)

The combinations of the lights and their definitions are shown in the following table.

Table 20. Definition of status light combinations

Operation	Ready 	Activity 	Cleaning 	Fault 
Power-on self-test <sup>1</sup>	Flashing	Off	Off	Off
Power On LED Test	On for 2.0 seconds	On for 2.0 seconds	On for 2.0 seconds	On for 2.0 seconds
No tape loaded	Off	Off	On <sup>2</sup> /Off	Off
Cartridge loaded, no activity	On	Off	On <sup>2</sup> /Off	Off
Data or Cleaning Cartridge loaded, activity	On	Flashing	On <sup>2</sup> /Off	Off
Cleaning Cartridge loaded, cleaning failed <sup>2</sup>	Off	Off	On <sup>2</sup>	Off
Cartridge loading or unloading <sup>2</sup>	Off	Flashing	On <sup>2</sup> /Off	Off
Unrecoverable drive failure <sup>3</sup>	On/Off	Off	On <sup>2</sup> /Off	Flashing <sup>3</sup>
Firmware Download	Flashing	Off	On <sup>2</sup> /Off	Off
Firmware Update	Flashing	Flashing	On <sup>2</sup> /Off	Off
Microcode Download failure <sup>4</sup>	Off	Off	On <sup>2</sup> /Off	Flashing <sup>3</sup>
Over Temperature <sup>5</sup>	Off	Off	On <sup>2</sup> /Off	On

**Notes:**

1. If the drive completes the power-on self-test (POST) within the 2.0 second Power On LED Test time, the POST indicator sequence is eliminated
2. A solid amber LED indicates the drive needs cleaning. The drive will continue to function, but needs cleaning as soon as possible. A power cycle does not turn off this indicator.

3. The Fault LED will flash to indicate an unrecoverable error. An unrecoverable error is an error condition that results in the drive not being able to function unless initiator, operator, or service intervention is applied. An unrecoverable drive failure is usually the result of a hardware error condition. One of the following actions will be needed to clear the flashing Fault LED:

- Hard SCSI reset
- Cartridge eject
- Power cycle
- Retry microcode download

An unrecoverable cartridge (media) failure is usually the result of a defective cartridge, media, or cartridge state and will require the drive to eject the cartridge (if possible) to clear the flashing LED.

4. The firmware download failed and the drive is not functional. The drive boot code is in control and the microcode download should be retried. The drive can be identified using the Inquiry command and is bootable while in this state.

5. The Fault LED will be on solid to indicate an over-temperature condition.

## Performing the internal self-test (FC 6120 or 6279)

Use the information in this topic to perform an internal self-test on your tape drive.

### Prerequisites

In order to perform the test, you need the following items:

- One VXA-2 tape drive with firmware code V2123 or higher, or one VXA-320 tape drive with firmware V3209 or higher
- One VXA cleaning cartridge X style
- One blank VXA X23 data cartridge

### Performing the test

Follow these steps to perform the internal self-test:

**Attention:** Use a blank tape to perform the test. During the test, the tape is overwritten with a test pattern and all data on the tape is destroyed.

1. Clean the tape drive.
2. Press the blue eject button for 7 seconds. When the Ready LED blinks rapidly, insert the blank, X23 data cartridge.

The tape drive performs the internal self-test. The test can take up to 15 minutes. After successful completion, the media is ejected.

### Interpreting the results





The following table shows how to interpret the results of the internal self-test using the status lights. To see a front-view illustration of the tape drive and status lights, see one of the following illustrations.

VXA-320 tape drive: Figure 3 on page 32

VXA-2 tape drive: Figure 4 on page 39

If the internal self-test passes, then the tape drive has no hardware fault and no further tests are required. If the internal self-test indicates a drive failure, contact your service provider.

Table 21. Internal self-test status light combinations

Internal self-test operation	Ready 	Activity 	Cleaning 	Fault 	Media status
Initiated	Flashing rapidly	Off	Off	Off	Unloaded
Running	Flashing rapidly	Flashing	Off	Off	Loaded
Passed	Off	Off	Off	Off	Unloaded
Passed, cleaning needed	Off	Off	On	Off	Unloaded
Media failure <sup>1</sup>	Off	Off	Flashing	Off	Loaded
Media write-protected <sup>2</sup>	Off	Flashing	Flashing	Off	Unloaded
Internal self-test media not compatible <sup>1</sup>	Off	Flashing	Flashing	Off	Unloaded
Drive failure	Off	Off	Off	Flashing	Loaded

<sup>1</sup> Repeat the internal self-test with a different, blank X23 data cartridge.

<sup>2</sup> Repeat the internal self-test with a write-enabled, blank X23 data cartridge.

## Tape cartridges (FC 6120)

Learn about the types of tape cartridges that are available for this drive.

### Compatible tape cartridges

Two types of tape cartridges are supported by this tape drive:

- X cartridges are the newest version of the VXA cartridge
- V cartridges are the original VXA cartridge

The V and X cartridges have similar shells and come in a variety of tape lengths. Both cartridges utilize AME media and offer the similar read/write speeds and capacities.

#### Note:

1. To use X cartridges, the tape drive must have a minimum microcode level of 2105. To display the microcode level of the tape drive in the AIX operating system, do the following steps:
  - a. Open an AIX command prompt.
  - b. Type the `lscfg -vl rmtx` command, where x is the tape drive number, then press Enter.

The output will contain the following line:

```
Device Specific.(Z1).....2105
```

In the previous example, 2105 represents the microcode level. If the command output contains a value of 2105 or higher, the tape drive supports the use of X cartridges. If the command output contains a value of 2104 or lower, update your microcode to 2105 or higher to use X cartridges in this tape drive.

2. X cartridges are only supported in VXA-2 tape drives. A user can write an X cartridge in VXA-1 format on a VXA-2 tape drive, but it will only be readable on a VXA-2 drive.
3. The VXA-2 drive supports use of V10 media., but this cartridge is not offered.

## Available tape cartridges

Table 22. X tape cartridges

Part Number	Description	Type	Other information
24R2137	230m 80/160GB	X23 Data Cartridge	Green accent
24R2136	124 m 40/80GB	X17 Data Cartridge	Green accent
24R2134	20/40GB	X6 Data Cartridge	Green accent
24R2135	62m 20/40GB	X6 Test Cartridge	Green accent
24R2138	X Cleaning Cartridge	VXA 20 usage	Green accent

Table 23. V tape cartridges

Part Number	Description	Type	Other information
19P4876	230m 80/160GB	V23 Data Cartridge	Purple accent
19P4877	124 m 40/80GB	V17 Data Cartridge	Red accent
19P4878	20/40GB	V6 Data Cartridge	Blue accent
19P4879	62m 20/40GB	V6 Test Cartridge	Blue accent
19P4880	X Cleaning Cartridge	VXA 20 usage	Gray accent

## Resetting the tape drive

You might need to reset your tape drive. Use the procedure in this topic to perform this task.

### About this task

Use this information to reset your tape drive, without affecting server operation. Allow up to 2 minutes for the entire tape drive process to complete.

**Attention:** Resetting a tape drive before the current backup operation has completed can cause loss of customer data.

To reset the tape drive, follow these steps:

### Procedure

1. Press and hold the eject button for 20 seconds, and then release the button. The LEDs on the drive will be flashing while the reset function is in process.
2. When the LEDs stop flashing, wait approximately one minute for the drive to complete the reset operation. The drive will then be ready to use.

## 60/150 GB 16-bit 8-mm internal tape drive (FC 6134)

Learn about the features of this media device.

<b>Description</b>	<p>The 60/150GB 16-bit 8-mm Internal Tape Drive consists of a 5.25-inch half-high, 16-bit tape drive. This drive provides a high capacity tape drive for save/restore and archiving functions. This tape drive uses 8-mm data cartridges and is capable of compression, providing a capacity of up to 150 GB. The 60/150 GB 16-bit 8-mm Internal Tape Drive, is limited to a maximum system ambient operating temperature of 31C (87.8F) at a maximum operating altitude of 2134m (7000 ft). Lower altitudes have higher maximum ambient operating temperatures.</p> <p>Characteristics:</p> <ul style="list-style-type: none"><li>• FRU part number: 19P0708</li><li>• Custom card identification number (CCIN): 63A0</li><li>• Capacity: 60 GB Native Mode, 150 GB (typical) Compression Mode</li><li>• Form Factor: 5.25-inch Half-high</li><li>• Media: 8-mm Data Cartridge with SmartClean Technology</li><li>• Operation: Streaming</li><li>• Data Transfer Rate: 12 MB/Sec. Native Mode, 30 MB/Sec. (typical) Compression M</li><li>• Interface: SCSI-2 16-bit Low Voltage Differential (LVD) / Single-ended (SE) Asynchronous/Synchronous</li><li>• Compatibility: Contact your authorized service provider</li><li>• Attributes provided: 60/150GB 16-bit 8-mm Internal Tape Drive</li><li>• Attributes required: One 1.6-inch (41mm) half-high media bay and one SCSI-2 internal 16-bit address</li></ul>
<b>Tools</b>	<p>The following tools and documentation are needed to complete the installation:</p> <ul style="list-style-type: none"><li>• A flat-blade screwdriver (if this device is not an auto-docking feature on your system)</li><li>• Your system unit documentation, including any service documentation</li><li>• Your operating system documentation</li></ul> <p>If an item is missing or damaged, contact the place of purchase.</p> <p><b>Note:</b> If you are installing the auto-docking version of this device on your system, the remainder of this information does not apply to your system. See your system documentation for information about the auto-docking feature.</p>
<b>Related information</b>	<p>Check that your package contains the following items:</p> <ul style="list-style-type: none"><li>• The device</li><li>• Media kit containing:<ul style="list-style-type: none"><li>– 1 data cartridge</li><li>– 1 cleaning cartridge</li><li>– 1 test tape</li><li>– Jumpers (located in a plastic bag)</li></ul></li><li>• Specific hardware for attaching the device to your specific system, as detailed on the parts listing provided with your device</li></ul>

## Cleaning the tape drive (FC 6134)

You will need to clean your tape drive. Use the procedure in this topic to perform this task.

### About this task

Clean the device whenever the Fault status light comes on or a system I/O error related to the device occurs.



**Attention:** Use only the recommended cleaning cartridge to clean the tape drive. Use of other than recommended cleaning cartridges can damage your drive and might void the warranty.

The tape drive will turn on the cleaning indication for several reasons:

- The tape drive exceeds internal preset error thresholds in the drive.
- A cleaning cartridge that has been used the maximum number of times is inserted in the drive. The cleaning indicator is turned on to indicate that the cleaning process was not done and the cleaning cartridge is no longer usable.
- The tape drive exceeds the maximum recommended time between cleaning.

If SmartClean data cartridges are not used, clean the tape drive with a cleaning cartridge when the tape drive amber LED (Disturbance LED) indicates the drive needs cleaning due to time of tape movement or recording quality problems. The LCD will say "CLEAN SOON". The maximum time between cleaning will be 30 tape motion hours.

**Note:** The 6134 tape drive is optimized to use SmartClean media. Extended use of AME media that is not SmartClean media is not recommended.

To clean the tape drive, complete the following steps:

## Procedure

1. Make sure that the power is on to the tape drive.
2. If a tape cartridge is in the tape drive, eject and remove the cartridge.

**Note:** Some cleaning cartridges have white dots on the window side that are designed to be used to log the use of the cartridge. Each time the cartridge is used, mark one of the dots on the cartridge with a pen or marker. When all of the dots have been marked, discard the cleaning cartridge.

3. Grasp the cleaning cartridge by the outer edges, with the window-side up and the write-protect switch facing you.
4. Slide the cartridge into the opening on the front of the drive until the loading mechanism pulls the cartridge into the drive and the drive door closes.

## Results

After the cleaning cartridge has been inserted, the remainder of the cleaning process is automatic. The tape drive does the following actions:

- Loads the cleaning cartridge into the tape drive.
- Cleans the drive by moving the cleaning tape forward for approximately 30 seconds.
- Unloads the cleaning cartridge when the cleaning operation is complete.
- Indicates a successful cleaning operation by turning off the Fault status light (if the Fault light was on prior to the cleaning process).

**Note:** If the cleaning operation completes but the Fault light remains on, repeat the cleaning procedure with a new cleaning cartridge. If the light still remains on, contact your authorized service provider.

To determine how many times a cleaning cartridge can be used, check the information printed on the cartridge. If you attempt to use a depleted cleaning cartridge, the tape drive automatically detects the error and ejects the cartridge. If the Fault status light was on prior to the cleaning process, it stays on; if the Fault light was off, the depleted cartridge causes the light to come on.

If a system error occurs, clean the drive and retry the operation. If the operation fails, replace the data cartridge, clean the drive again, then retry the operation.

## Loading and unloading cartridges

Learn about loading and unloading tape cartridges from this drive.

### About this task

To avoid problems with loading and unloading, use only one label on a cartridge. If the cartridge has too many or poorly-placed labels, the drive-load mechanism might clog.

### Loading a cartridge

#### About this task

To load a cartridge, complete the following steps:

#### Procedure

1. Make sure that the tape device power is on.
2. Grasp the cartridge by the outer edges, with the window side up and the write-protect switch facing you.

**Note:** Make sure that the write-protect switch is correctly set.

3. Slide the cartridge into the opening on the front of the device until the loading mechanism pulls the cartridge into the drive and the drive door closes.

#### Results

To indicate that the load operation was successful, the Ready status light comes on.

### Unloading a cartridge

#### About this task

To unload a cartridge, complete the following steps:

#### Procedure

1. Make sure that the tape device power is on.
2. Press the Unload button. The device rewinds, unloads, and ejects the tape cartridge.

The process might take from 15 seconds to several minutes, depending on the position of the tape and the amount of data written. During this task, the status lights do the following sequence:

- The Ready status light turns off.
- The Activity status light flashes during the unload operation.
- The Activity status light turns off when the cartridge is ejected from the tape drive.

#### Results

**Attention:** An emergency eject and reset feature can be used to release the tape cartridge and reset the drive. Use the emergency eject feature if the cartridge does not move correctly or if the unload process fails. The emergency eject and reset feature procedure might result in loss of data. To perform an emergency eject operation of the tape cartridge or a reset operation of the drive, press and hold the Unload button for at least 10 seconds. If a cartridge is in the drive, the cartridge automatically ejects without rewinding the tape.

## Setting the write-protect switch (FC 6134)

You might need to set the write-protect switch on the media. Use the information in this topic to perform this task.

The position of the write-protect switch on the tape cartridge determines when you can write to the tape.

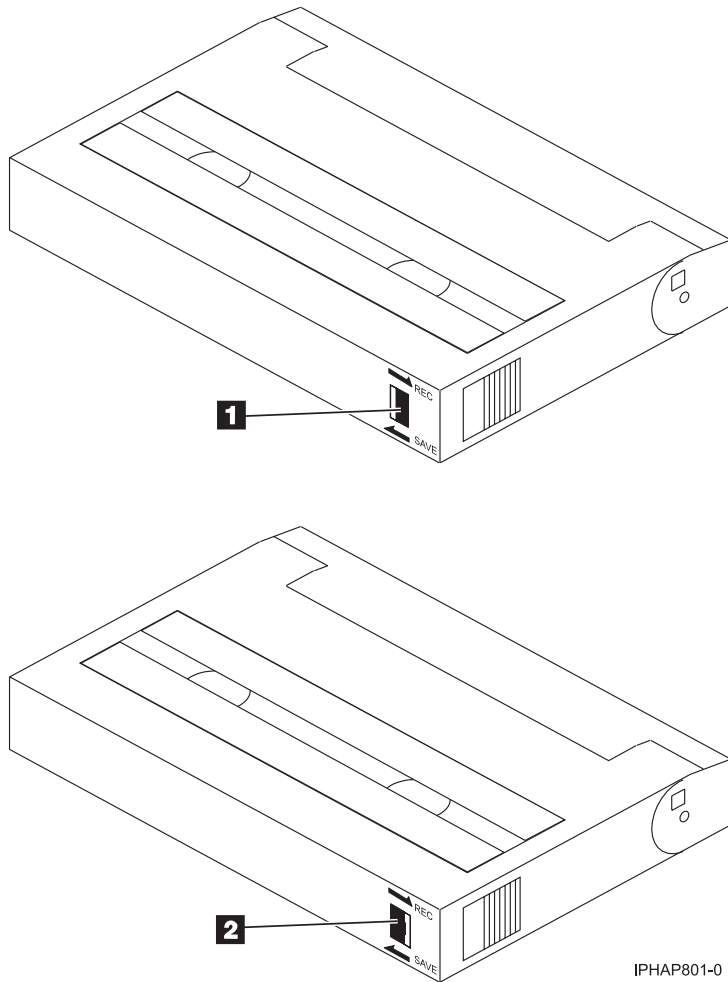

IPHAP801-0

When the switch is set to the left in the SAVE position **1**, data cannot be written to or read from the tape (data is saved).

When the switch is set to the right in the REC (Record) position **2**, data can be written to and read from the tape.

## Status lights (FC 6134)

You might need to read the status lights on your tape drive to determine the operating status of the drive. Use the information in this topic to perform this task.

The following illustration is a front view of the tape drive:

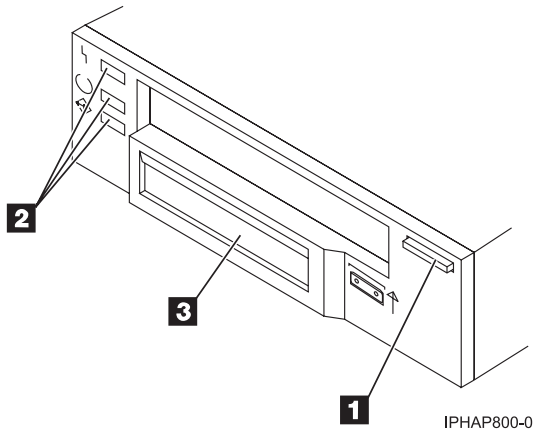



Figure 5. Front view of tape drive

- 1 Unload button
- 2 Status lights
- 3 Liquid crystal display (LCD)

The status lights and their ISO symbols are on the device as follows:



Ready  (green)

Activity  (green)

Fault  (amber)

The combinations of the lights and their definitions are shown in the following table.

Table 24. Definition of status light combinations

Operation	Ready 	Activity 	Fault 
POST or Reset	On	On	On
Error or Failed POST	Off	Off	Flash
Ready (No Cartridge Loaded)	Off	Off	
Ready (Cartridge Loaded)	On	Off	
Normal Cartridge Motion	On	Flashing	
High Speed Motion	On	Fast Flashing	
Time to Clean Cartridge	N/A	N/A	On
Cleaning in Progress	On	Flashing	On

## Tape cartridges (FC 6134)

Learn about the types of tape cartridges that are available for this drive.

## Available tape cartridges

Table 25. 8-mm data cartridges

Part Number	Type of Cartridge	Length
35L1044	20 GB AME with SmartClean Data Cartridge	75 m (246 ft)
09L5323	40 GB AME with SmartClean Data Cartridge	150 m (492 ft)
18P6484	60 GB AME with SmartClean Data Cartridge	225 m (738 ft)
35L1409	Cleaning Cartridge	

## Resetting the tape drive

You might need to reset your tape drive. Use the procedure in this topic to perform this task.

### About this task

Use this information to reset your tape drive, without affecting server operation. Allow up to 2 minutes for the entire tape drive process to complete.

**Attention:** Resetting a tape drive before the current backup operation has completed can cause loss of customer data.

To reset the tape drive, follow these steps:

### Procedure

1. Press and hold the eject button for 20 seconds, and then release the button. The LEDs on the drive will be flashing while the reset function is in process.
2. When the LEDs stop flashing, wait approximately one minute for the drive to complete the reset operation. The drive will then be ready to use.

## 36/72 GB Data72 4 mm internal tape drive (FC 6258 or 5907)

Learn about the features of this media device.

<p><b>Description</b></p>	<p>The 36/72 GB Data72 4 mm Internal Tape Drive is a 5.25-inch, half-high, LVD or SAS drive, which provides a high capacity for save/restore and achieve functions. This tape drive uses 4 mm data cartridges and is capable of compression, providing a capacity of up to 72 GB.</p> <p>Characteristics:</p> <ul style="list-style-type: none"> <li>• FRU part number for FC 6258: 95P1988</li> <li>• FRU part number for FC 5907: 23R2530</li> <li>• Custom card identification number (CCIN): 63A0</li> <li>• Capacity: 36 GB native mode, 72 GB (typical) compression mode</li> <li>• Form Factor: 5.25-inch half high</li> <li>• Media: DAT72, DDS4, and DDS3 media</li> <li>• Technology: Helical scan, rotating head</li> <li>• Operation: Streaming</li> <li>• Data Transfer Rate: 3 MBps native mode, 6 MBps (typical) compression</li> <li>• Interface for FC 6258: Low voltage differential</li> <li>• Interface for FC 5907: Serial-Attached SCSI</li> <li>• Compatibility: 12 GB mode (read/write), 20 GB (read/write), and 36 GB mode (read/write)</li> <li>• Attributes provided: 4 mm tape capability</li> <li>• Attributes required: One 1.6-inch (41 mm) half-high media bay and one SCSI internal LVD or SAS 16-bit address</li> </ul>
<p><b>Tools</b></p>	<p>The following tools and documentation are needed to complete the installation:</p> <ul style="list-style-type: none"> <li>• A flat-blade screwdriver (if this device is not an auto-docking feature on your system)</li> <li>• Your system unit documentation, including any service documentation</li> <li>• Your operating system documentation</li> </ul> <p>Contact the place of purchase if an item is missing or damaged.</p> <p><b>Note:</b> If you are installing the auto-docking version of this device on your system, the remainder of this section does not apply to your system. See your system documentation for information about the auto-docking feature.</p>
<p><b>Media</b></p>	<p>This tape drive uses 4mm data cartridges for saving and restoring system data. It is designed to use only DDS (Digital Data Storage) data cartridges. The cartridges are identified by one of the following DDS symbols:</p> <div style="text-align: center;">  </div> <p>The tape drive reads and writes data to tape cartridges that are DDS-3, DDS-4, or DAT 72 format.</p> <p><b>Note:</b> This tape drive only supports DDS-3, DDS-4, and DAT 72 tape cartridges. If any other cartridge is inserted in the drive, it will be ejected.</p> <p>This tape drive has been designed to operate with DDS media that meet the following standards of the European Computer Manufacturers Association (ECMA):</p> <ul style="list-style-type: none"> <li>• ECMA-236 DDS-3 format</li> <li>• ECMA-288 DDS-4 format</li> </ul>

<b>Related information</b>	<p>Your package contains the following items:</p> <ul style="list-style-type: none"> <li>• The tape drive</li> <li>• Media kit containing: <ul style="list-style-type: none"> <li>– 1 cleaning cartridge</li> <li>– 1 test tape</li> <li>– Jumpers (located in a plastic bag)</li> </ul> </li> <li>• Specific hardware for attaching the drive to your specific system, as detailed on the parts listing provided with your drive.</li> </ul>
----------------------------	---

## Cleaning the tape drive (FC 6258 or 5907)

You will need to clean your tape drive. Use the procedure in this topic to perform this task.

### About this task

Clean the device whenever the Fault status light comes on or a system I/O error related to the device occurs.

**Attention:** Use only the recommended cleaning cartridge to clean the tape drive. Use of other than recommended cleaning cartridges can damage your drive and might void the warranty.

The tape drive will turn on the cleaning indicator for the following reasons:

- The tape drive exceeds internal preset error thresholds in the drive.
- A cleaning cartridge that has been used the maximum number of times is inserted in the drive. The cleaning indicator is turned on to indicate that the cleaning process was not done and the cleaning cartridge is no longer usable.
- The tape drive exceeds the maximum recommended time between cleaning.

The maximum recommended time between preventive-maintenance cleaning is 50 tape motion hours. Tape motion hours are defined as the time that the tape drive is moving tape. If the tape drive reaches 50 tape motion hours since the tape drive was last cleaned, the drive will turn on the cleaning required LED to indicate the drive needs cleaning. The tape drive will continue to operate but the tape drive should be cleaned at the next opportunity to insert a cleaning cartridge.

To clean the tape drive, complete the following steps:

### Procedure

1. Make sure that the power is on to the tape drive.
2. If a tape cartridge is in the tape drive, eject and remove the cartridge.

**Note:** Some cleaning cartridges have white dots on the window side that are designed to be used to log the use of the cartridge. Each time the cartridge is used, mark one of the dots on the cartridge with a pen or marker. When all of the dots have been marked, discard the cleaning cartridge.

3. Grasp the cleaning cartridge by the outer edges, with the window-side up and the write-protect switch facing you.
4. Slide the cartridge into the opening on the front of the drive until the loading mechanism pulls the cartridge into the drive and the drive door closes.

### Results

After the cleaning cartridge has been inserted, the remainder of the cleaning process is automatic. The tape drive does the following actions:

- Loads the cleaning cartridge into the tape drive.

- Cleans the drive by moving the cleaning tape forward for approximately 30 seconds.
- Unloads the cleaning cartridge when the cleaning operation is complete.
- Indicates a successful cleaning operation by turning off the Fault status light (if the Fault light was on prior to the cleaning process).

**Note:** If the cleaning operation completes but the Fault light remains on, repeat the cleaning procedure with a new cleaning cartridge. If the light still remains on, contact your authorized service provider.

To determine how many times a cleaning cartridge can be used, check the information printed on the cartridge. If you attempt to use a depleted cleaning cartridge, the tape drive automatically detects the error and ejects the cartridge. If the Fault status light was on prior to the cleaning process, it stays on; if the Fault light was off, the depleted cartridge causes the light to come on.

If a system error occurs, clean the drive and retry the operation. If the operation fails, replace the data cartridge, clean the drive again, then retry the operation.

## Loading and unloading cartridges

Learn about loading and unloading tape cartridges from this drive.

### About this task

To avoid problems with loading and unloading, use only one label on a cartridge. If the cartridge has too many or poorly-placed labels, the drive-load mechanism might clog.

### Loading a cartridge

#### About this task

To load a cartridge, complete the following steps:

#### Procedure

1. Make sure that the tape device power is on.
2. Grasp the cartridge by the outer edges, with the window side up and the write-protect switch facing you.

**Note:** Make sure that the write-protect switch is correctly set.

3. Slide the cartridge into the opening on the front of the device until the loading mechanism pulls the cartridge into the drive and the drive door closes.

#### Results

To indicate that the load operation was successful, the Ready status light comes on.

### Unloading a cartridge

#### About this task

To unload a cartridge, complete the following steps:

#### Procedure

1. Make sure that the tape device power is on.
2. Press the Unload button. The device rewinds, unloads, and ejects the tape cartridge.

The process might take from 15 seconds to several minutes, depending on the position of the tape and the amount of data written. During this task, the status lights do the following sequence:

- The Ready status light turns off.



- The Activity status light flashes during the unload operation.
- The Activity status light turns off when the cartridge is ejected from the tape drive.

## Results

**Attention:** An emergency eject and reset feature can be used to release the tape cartridge and reset the drive. Use the emergency eject feature if the cartridge does not move correctly or if the unload process fails. The emergency eject and reset feature procedure might result in loss of data. To perform an emergency eject operation of the tape cartridge or a reset operation of the drive, press and hold the Unload button for at least 10 seconds. If a cartridge is in the drive, the cartridge automatically ejects without rewinding the tape.

## Setting the write-protect switch (FC 6258 or 5907)

You might need to set the write-protect switch on the media. Use the information in this topic to perform this task.

**Attention:** Do not attempt to change the write-protect settings after the tape cartridge is loaded in the drive because this might cause unpredictable results and might damage the tape or the drive.

The position of the write-protect switch on the tape cartridge determines when you can write to the tape.

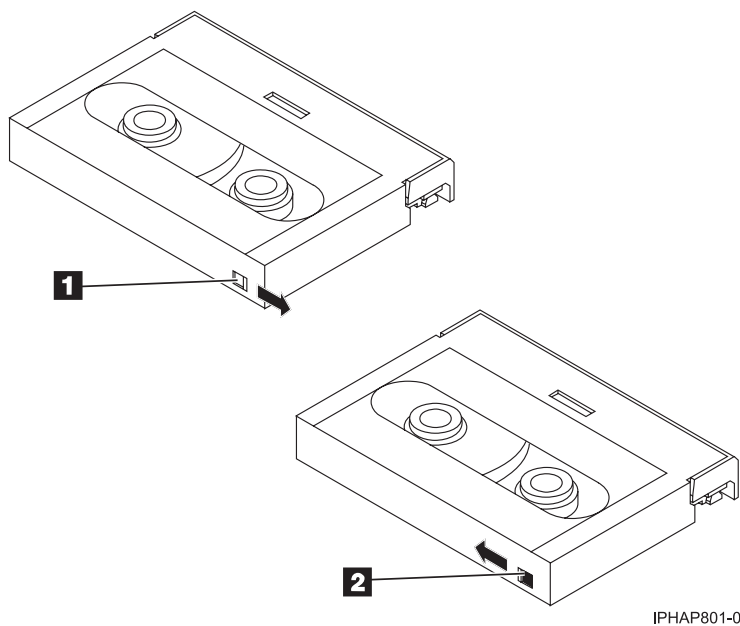

- 1 When the switch is set to the right, data can be written to and read from the tape
- 2 When the switch is set to the left, data can only be read.

## Status lights (FC 6258 or 5907)

You might need to read the status lights on your tape drive to determine the operating status of the drive. Use the information in this topic to perform this task.

The following illustration is a front view of the tape drive:

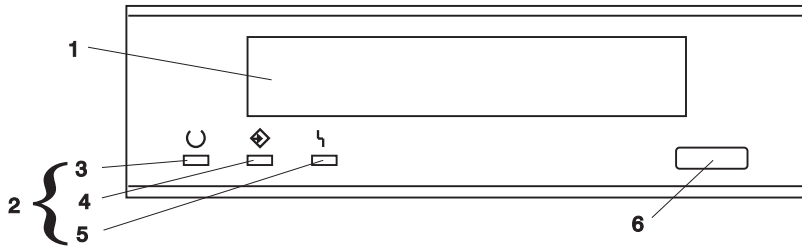

Figure 6. Front view of tape drive

- 1 Tape drive door
- 2 Status lights
- 3 Ready (green)
- 4 Active (green)
- 5 Fault (amber)
- 6 Unload/Reset button

The status lights and their ISO symbols are on the device as follows:

### Ready

○ **Ready** (green)

### Activity

◊ **Activity** (green)

### Fault



⌋ **Fault** (amber)

The combinations of the lights and their definitions are shown in the following table.

Table 26. Definition of status light combinations

Ready ○ <b>Ready</b> (green)	Activity ◊ <b>Activity</b> (green)	Fault ⌋ <b>Fault</b> (amber)	Definition
Flashing	Off	Off	The power-on self-test (POST) is running or the test cartridge is running.
Off or On	Off or Flashing	On	The tape drive requires cleaning. See Cleaning the tape drive. <ul style="list-style-type: none"> <li>• If the Ready light is on, a tape cartridge is in the drive. If the light is off, a cartridge is not in the drive.</li> <li>• If the Activity light flashes, a tape cartridge is in the drive and tape movement is occurring. If the light is off, no tape movement is occurring.</li> </ul>

Table 26. Definition of status light combinations (continued)

 <b>Ready</b> <b>Ready</b> (green)	 <b>Activity</b> <b>Activity</b> (green)	 <b>Fault</b> <b>Fault</b> (amber)	Definition
Off	Off	Off or On	One of the following conditions exists: <ul style="list-style-type: none"> <li>The power is off (Fault light is off).</li> <li>The POST completed successfully, but no tape cartridge has been inserted.</li> <li>If the Fault light is on, cleaning is required. See Cleaning the tape drive.</li> </ul>
On	Off or Flashing	Off or On	A data cartridge has been inserted. <ul style="list-style-type: none"> <li>The device is ready to receive commands from the system (whether the Fault light is on or off).</li> <li>If the Fault light is on, cleaning is required. See Cleaning the tape drive.</li> <li>If the Activity light flashes, a tape cartridge is in the drive and tape movement is occurring. If the light is off, no tape movement is occurring.</li> </ul>
On	Flashing	Off or On	The tape is in motion, and the device is running an operation or is cleaning.
Off	Off	Flashing	The device detected an internal fault that requires corrective action. <ol style="list-style-type: none"> <li>Reset the error by turning the power off to the device, then turning it back on, or by holding down the Unload/Reset button for 8 seconds.</li> <li>If the Fault light still flashes after the reset, contact your service provider.</li> </ol>

**Notes:**

- The device needs cleaning when the tape drive turns on the Fault status light (solid amber). The light turns on when the device exceeds a preset operating limit.
- The recommended preventive-maintenance cleaning frequency is approximately 50 tape motion hours. Tape motion hours are defined as the time that the tape drive is moving tape.
- When the Fault light turns on (solid amber), the device causes AIX to log an information error (TAPE\_ERR6) in the AIX log, indicating that the tape drive needs to be cleaned.
- Use only quality media and cleaning cartridges.
- The device is designed to operate in typical office environments. Dirty environments or other poor environments might damage the tape drive. It is the customer's responsibility to provide the proper operating environment.
- When the tape drive indicates that the drive needs to be cleaned, it is the customer's responsibility to clean the tape drive with the recommended cleaning cartridge.
- If a tape cartridge that is not DDS-3, DDS-4, or DAT72 format is used, that cartridge will be immediately ejected as an incorrect cartridge type.

**Tape cartridges (FC 6258 or 5907)**

Learn about the types of tape cartridges that are available for this drive.

## Available tape cartridges

Table 27. 4-mm Data Cartridges

Part Number	Type of Cartridge	Native (uncompressed) Capacity
18P7912	DAT 72 Data Cartridge	36 GB
59H4456	4-mm Test Cartridge	--
21F8763	4-mm Cleaning Cartridge	--
59H3465	Data Cartridge DDS3	12 GB
59H4458	Data Cartridge DDS4	20 GB

Most bulk eraser devices do not have the capability to erase the 4mm data cartridge. To correctly erase a 4mm data cartridge with a bulk eraser device, the erasure coercivity rating must be a minimum of 3900 Oersted.

## Resetting the tape drive

You might need to reset your tape drive. Use the procedure in this topic to perform this task.

### About this task

Use this information to reset your tape drive, without affecting server operation. Allow up to 2 minutes for the entire tape drive process to complete.

**Attention:** Resetting a tape drive before the current backup operation has completed can cause loss of customer data.

To reset the tape drive, follow these steps:

### Procedure

1. Press and hold the eject button for 20 seconds, and then release the button. The LEDs on the drive will be flashing while the reset function is in process.
2. When the LEDs stop flashing, wait approximately one minute for the drive to complete the reset operation. The drive will then be ready to use.

## 80/160 GB DAT160 SAS Tape Drive (FC 5619)

Learn about the features of this media device.

<p><b>Description</b></p>	<p>The 80/160 GB DAT160 SAS Tape Drive is a 5.25-inch, half-high, SAS drive, which provides a high capacity for save/restore and achieve functions. To see an illustration of this drive, see Figure 7 on page 61. This tape drive uses DAT160, 4 mm data cartridges and is compression capable, providing a capacity of up to 160 GB with 2:1 compression ratio.</p> <p>Characteristics:</p> <ul style="list-style-type: none"> <li>• FRU part number: 23R9723</li> <li>• Custom card identification number (CCIN): 63A0</li> <li>• Media part numbers: see “Tape cartridges (FC 5619)” on page 62</li> <li>• Capacity: 80 GB native mode, 160 GB (typical) compression mode</li> <li>• Form factor: 5.25-inch half high</li> <li>• Media: DAT160, DAT72, and DDS4 media</li> <li>• Technology: helical scan, rotating head</li> <li>• Operation: streaming</li> <li>• Data transfer rate: 6 MBps native mode, 12 MBps (typical) compression</li> <li>• Interface: integrated, internal SAS</li> <li>• Compatibility: DDS4 (read/write), DAT72 (read/write), and DAT160 (read/write)</li> <li>• Attributes provided: 4 mm tape capability, test cartridge, cleaning cartridge, and a data cartridge</li> <li>• Attributes required: One 1.6-inch (41 mm) half-high media bay and one integrated, internal SAS</li> </ul>
<p><b>Tools</b></p>	<p>The following tools and documentation are needed to complete the installation:</p> <ul style="list-style-type: none"> <li>• A flat-blade screwdriver (if this device is not an auto-docking feature on your system)</li> <li>• Your system unit documentation, including any service documentation</li> <li>• Your operating system documentation</li> </ul> <p>Contact the place of purchase if an item is missing or damaged.  <b>Note:</b> If you are installing the auto-docking version of this device on your system, see your system documentation for information about the auto-docking feature.</p>
<p><b>Media</b></p>	<p>This tape drive uses 4 mm data cartridges for saving and restoring system data. It is designed to use only DDS (Digital Data Storage) data cartridges. The cartridges are identified by one of the following DDS symbols:</p> <div style="text-align: center;">  <p>The image shows three logos for digital data storage formats: 'DDS4 Digital Data Storage', 'DAT 72 Digital Data Storage', and 'DAT 160 Digital Data Storage'. They are arranged horizontally with 'Or' between them.</p> </div> <p>The tape drive reads and writes data to tape cartridges that are in the DDS4, DAT72, or DAT160 format.</p>
<p><b>Related information</b></p>	<p>Your package contains the following items:</p> <ul style="list-style-type: none"> <li>• The tape drive</li> <li>• Media kit containing: <ul style="list-style-type: none"> <li>– One cleaning cartridge</li> <li>– One test tape</li> </ul> </li> <li>• Specific hardware for attaching the drive to your specific system, as detailed on the parts listing provided with your drive.</li> </ul>

## Cleaning the tape drive (FC 5619)

You will need to clean your tape drive. Use the procedure in this topic to perform this task.

### About this task

Clean the device whenever the Fault status light comes on or a system I/O error related to the device occurs.

**Attention:** Use only the recommended cleaning cartridge to clean the tape drive. Use of other than recommended cleaning cartridges can damage your drive and might void the warranty. The cleaning cartridge for this drive is P/N 23R5638. The cartridge is physically larger than previous cleaning cartridges and it is the only cleaning cartridge that can be used in this drive. The older, narrower cleaning cartridges do not work in the 5619 tape drive and are ejected from the drive without cleaning the drive.

The tape drive will turn on the cleaning indicator for the following reasons:

- The tape drive exceeds internal preset error thresholds in the drive.
- A cleaning cartridge that has been used the maximum number of times is inserted in the drive. The cleaning indicator is turned on to indicate that the cleaning process was not done and the cleaning cartridge is no longer usable.
- The tape drive exceeds the maximum recommended time between cleaning.

The maximum recommended time between preventive-maintenance cleaning is 50 tape motion hours. Tape motion hours are defined as the time that the tape drive is moving tape. If the tape drive reaches 50 tape motion hours since the tape drive was last cleaned, the drive will turn on the cleaning required LED to indicate the drive needs cleaning. The tape drive will continue to operate but the tape drive should be cleaned at the next opportunity to insert a cleaning cartridge.

**Note:** Operating the tape drive in a low-humidity environment causes the drive to request cleaning more often than in normal humidity environment. In extreme low-humidity conditions of less than 15% relative humidity, the tape drive might request cleaning every 10 tape motion hours or even more frequently. For this reason, it is best not to use the tape drive in extremely low-humidity environments.

To clean the tape drive, complete the following steps:

### Procedure

1. Make sure that the power is on for the tape drive.
2. If a tape cartridge is in the tape drive, eject and remove the cartridge.
3. Grasp the cleaning cartridge by the outer edges, with the window-side up and the write-protect switch facing you.
4. Slide the cartridge into the opening on the front of the drive until the loading mechanism pulls the cartridge into the drive and the drive door closes.

### Results

After the cleaning cartridge has been inserted, the remainder of the cleaning process is automatic. The tape drive does the following actions:

- Loads the cleaning cartridge into the tape drive.
- Cleans the drive by moving the cleaning tape forward for approximately 30 seconds.
- Unloads the cleaning cartridge when the cleaning operation is complete.
- Indicates a successful cleaning operation by turning off the Cleaning status light (if the Cleaning light was on prior to the cleaning process. Otherwise, the Cleaning light remains solid to indicate that the cleaning cartridge is no longer usable. Obtain a new cleaning cartridge and repeat the process.)

**Note:** If the cleaning operation completes but the Cleaning light remains on, repeat the cleaning procedure with a new cleaning cartridge. If the light still remain on, contact your authorized service representative.

If you attempt to use a depleted cleaning cartridge, the drive automatically detects the error and ejects the cartridge. If the Cleaning status light was on prior to the cleaning process, it stays on; if the Cleaning light was off, the depleted cartridge causes the light to come on.

If a system error occurs, clean the drive and retry the operation. If the operation fails, replace the data cartridge, clean the drive again, then retry the operation.

## Loading and unloading cartridges

Learn about loading and unloading tape cartridges from this drive.

### About this task

To avoid problems with loading and unloading, use only one label on a cartridge. If the cartridge has too many or poorly-placed labels, the drive-load mechanism might clog.

### Loading a cartridge

#### About this task

To load a cartridge, complete the following steps:

#### Procedure

1. Make sure that the tape device power is on.
2. Grasp the cartridge by the outer edges, with the window side up and the write-protect switch facing you.

**Note:** Make sure that the write-protect switch is correctly set.

3. Slide the cartridge into the opening on the front of the device until the loading mechanism pulls the cartridge into the drive and the drive door closes.

#### Results

To indicate that the load operation was successful, the Ready status light comes on.

### Unloading a cartridge

#### About this task

To unload a cartridge, complete the following steps:

#### Procedure

1. Make sure that the tape device power is on.
2. Press the Unload button. The device rewinds, unloads, and ejects the tape cartridge.

The process might take from 15 seconds to several minutes, depending on the position of the tape and the amount of data written. During this task, the status lights do the following sequence:

- The Ready status light turns off.
- The Activity status light flashes during the unload operation.
- The Activity status light turns off when the cartridge is ejected from the tape drive.

## Results

**Attention:** An emergency eject and reset feature can be used to release the tape cartridge and reset the drive. Use the emergency eject feature if the cartridge does not move correctly or if the unload process fails. The emergency eject and reset feature procedure might result in loss of data. To perform an emergency eject operation of the tape cartridge or a reset operation of the drive, press and hold the Unload button for at least 10 seconds. If a cartridge is in the drive, the cartridge automatically ejects without rewinding the tape.

## Setting the write-protect switch (FC 5619)

You might need to set the write-protect switch on the media. Use the information in this topic to perform this task.

**Attention:** Do not attempt to change the write-protect settings after the tape cartridge is loaded in the drive because this might cause unpredictable results and might damage the tape or the drive.

The position of the write-protect switch on the tape cartridge determines when you can write to the tape.

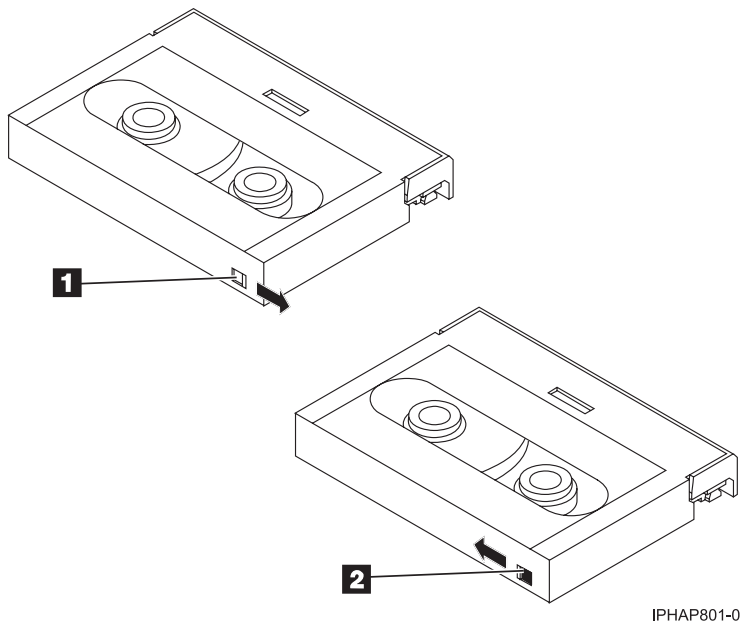

- 1** When the switch is set to the right, data can be written to and read from the tape.
- 2** When the switch is set to the left, data can only be read.

## Status lights (FC 5619)

You might need to read the status lights on your tape drive to determine the operating status of the drive. Use the information in this topic to perform this task.

The following illustration is a front view of the tape drive:



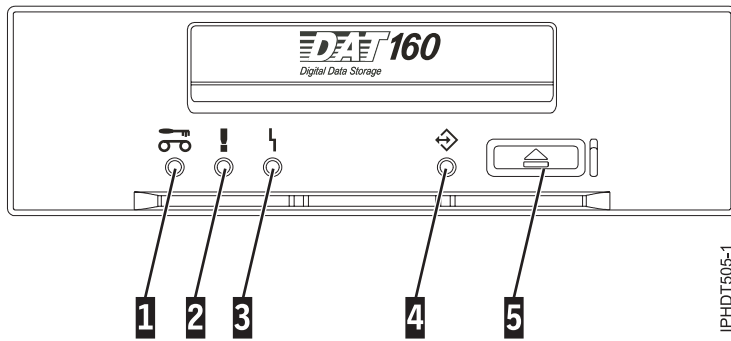

Figure 7. Front-view of tape drive

- 1** Cleaning LED (amber)
- 2** Media fault LED (amber)
- 3** Drive fault LED (amber)
- 4** Ready/Activity LED (green)
- 5** Unload/Reset button

The combinations of the lights and their definitions are shown in the following table.

Table 28. Definition of status light combinations









Activity	Cleaning (amber) 	Media fault (amber) 	Drive fault (amber) 	Ready/Activity (green) 
Power on LED test (2.0 seconds)	On	On	On	On
Power on self-test (POST) activity	Off	Off	Off	Flashing
POST failed	Off	Off	Flashing	Off
POST passed	On <sup>1</sup> or off	Off	Off	Off
Data cartridge loading	On <sup>1</sup> or off	Off	Off	Flashing
Data cartridge loaded, no activity	On <sup>1</sup> or off	On <sup>2</sup> or off	Flashing <sup>3</sup> or off	On
Data cartridge loaded, activity	On <sup>1</sup> or off	On <sup>2</sup> or off	Flashing <sup>3</sup> or off	Flashing
Data cartridge unloading	On <sup>1</sup> or off	On <sup>2</sup> or off	Flashing <sup>3</sup> or off	Flashing
Data cartridge ejected	On <sup>1</sup> or off	On or off	Flashing <sup>3</sup> or off	Off
Cleaning cartridge loaded, activity	On	Off	Flashing <sup>3</sup> or off	Flashing
Cleaning succeeded, cleaning cartridge ejected	Off	Off	Flashing <sup>3</sup> or off	Off
Cleaning failed, cleaning cartridge ejected	On <sup>1</sup>	On	Flashing <sup>3</sup> or off	Off
Unrecoverable drive failure <sup>4</sup>	On <sup>1</sup> or off	On or off	Flashing	Flashing

Table 28. Definition of status light combinations (continued)

Activity	Cleaning (amber) 	Media fault (amber) 	Drive fault (amber) 	Ready/Activity (green) 
Unrecoverable media failure <sup>4</sup>	On <sup>1</sup>	On	Off	Flashing, on, or off
Firmware download: download and reprogram	Flashing	Off	Off	Flashing
Firmware download: possible unload	See Data cartridge unloading			
Firmware download: reset in 1 second	On	On	On	On
Firmware download: self-test	See Power on self-test activity, and then see either POST passed or POST failed.			
Firmware download reprogram failure	Off	Off	Flashing	Off
SCSI diagnostics test in progress	See Data cartridge loaded, activity			
SCSI diagnostics test passed	See Data cartridge loaded, no activity			
SCSI diagnostics test failed, tape ejected	On	On	On	Flashing
	After data cartridge ejects, see Data cartridge ejected.			
Tape diagnostics test in progress	See Data cartridge loading and then:			
	Flashing	Off	Off	Flashing
Tape diagnostics test passed, tape ejected	Off	Off	Off	Flashing
	After data cartridge ejects, see Data cartridge ejected.			
Tape diagnostics test failed, tape ejected	On	On	On	Flashing
	After data cartridge ejects, see Data cartridge ejected.			
<p><sup>1</sup> A solid amber Cleaning LED indicates that the drive needs cleaning. The drive will continue to function but needs cleaning as soon as possible. Do not ignore the indicator by cycling the power to turn it off.</p> <p><sup>2</sup> The media has reached the end of its useful life and should be replaced. Any data should be copied to a new cartridge as soon as possible.</p> <p><sup>3</sup> Flashing in this state indicates a problem with write/read performance.</p> <p><sup>4</sup> An unrecoverable drive failure is an error condition that results in the drive not being able to function unless initiator, operator, or service intervention is applied. An unrecoverable drive failure is usually the result of a hardware error condition. One of the following actions is needed to clear the flashing fault LED:</p> <ul style="list-style-type: none"> <li>• Hard SCSI reset</li> <li>• Cartridge emergency eject</li> <li>• Power cycle</li> <li>• Retry firmware download</li> </ul> <p>An unrecoverable media failure is usually the result of a defective cartridge, media, or cartridge state, and will require the drive to eject the cartridge (if possible) to clear the On LED.</p>				

## Tape cartridges (FC 5619)

Learn about the types of tape cartridges that are available for this drive.

## Available tape cartridges

Table 29. 4 mm data cartridges

part number	Type of cartridge
23R5635 (cartridge feature code 5689)	DAT160 80 GB Data Cartridge
23R5636	4 mm Test Cartridge
23R5638	4 mm Cleaning Cartridge (Only use the DAT160 cleaning cartridge on the DAT160 tape drive)

Most bulk eraser devices do not have the capability to erase the 4 mm data cartridge.

## Resetting the tape drive

You might need to reset your tape drive. Use the procedure in this topic to perform this task.

### About this task

Use this information to reset your tape drive, without affecting server operation. Allow up to 2 minutes for the entire tape drive process to complete.

**Attention:** Resetting a tape drive before the current backup operation has completed can cause loss of customer data.

To reset the tape drive, follow these steps:

### Procedure

1. Press and hold the eject button for 20 seconds, and then release the button. The LEDs on the drive will be flashing while the reset function is in process.
2. When the LEDs stop flashing, wait approximately one minute for the drive to complete the reset operation. The drive will then be ready to use.

## 160/320 GB DAT320 SAS tape drive (FC 5661)

Learn about the features of this media device.

<p><b>Description</b></p>	<p>The 160/320 GB DAT320 SAS Tape Drive is a 5.25-inch, half-high, SAS drive, which provides a high capacity for save/restore and achieve functions. To see an illustration of this drive, see Figure 8 on page 68. This tape drive uses DAT320, 4 mm data cartridges and is compression capable, providing a capacity of up to 320 GB with 2:1 compression ratio.</p> <p>Characteristics:</p> <ul style="list-style-type: none"> <li>• FRU part number: 46C1933</li> <li>• Custom card identification number (CCIN): 63A0</li> <li>• Media part numbers: see “Tape cartridges (FC 5661)” on page 70</li> <li>• Capacity: 160 GB native mode, 320 GB (typical) compression mode</li> <li>• Form factor: 5.25-inch half high</li> <li>• Media: DAT320, DAT160</li> <li>• Technology: helical scan, rotating head</li> <li>• Operation: streaming</li> <li>• Data transfer rate: 12 MBps native mode</li> <li>• Interface: integrated, internal SAS with right-angle connector.</li> <li>• Compatibility: DAT160 (read/write) and DAT320 (read/write)</li> </ul> <p><b>Note:</b> DAT160 media is more abrasive than DAT320 media and can be used for occasional use only.</p> <ul style="list-style-type: none"> <li>• Attributes provided: DAT320 tape, test cartridge, and a cleaning cartridge</li> <li>• Attributes required: One 1.6-inch (41 mm) half-high media bay and Feature Code 3657, SAS cable with right angle connector.</li> </ul>
<p><b>Tools</b></p>	<p>The following tools and documentation are needed to complete the installation:</p> <ul style="list-style-type: none"> <li>• A flat-blade screwdriver (if this device is not an auto-docking feature on your system)</li> <li>• Your system unit documentation, including any service documentation</li> <li>• Your operating system documentation</li> </ul> <p>Contact the place of purchase if an item is missing or damaged.</p> <p><b>Note:</b> If you are installing the auto-docking version of this device on your system, see your system documentation for information about the auto-docking feature.</p>
<p><b>Media</b></p>	<p>This tape drive uses 4 mm data cartridges for saving and restoring system data. It is designed to use only DDS (Digital Data Storage) data cartridges. The cartridges are identified by one of the following DDS symbols:</p> <div style="text-align: center;">  <p>The image shows two logos for Digital Data Storage (DDS) cartridges. On the left is the 'DAT160' logo, and on the right is the 'DAT320' logo. Both logos feature the word 'DAT' in a stylized font with horizontal lines through it, followed by the capacity number '160' or '320'. Below each logo is the text 'Digital Data Storage'. Between the two logos is the word 'Or'. To the right of the 'DAT320' logo is a vertical label 'P7HDT501-0'.</p> </div> <p>The tape drive reads and writes data to tape cartridges that are in the DAT160 or DAT320 format.</p>
<p><b>Related information</b></p>	<p>Your package contains the following items:</p> <ul style="list-style-type: none"> <li>• The tape drive</li> <li>• Media kit containing: <ul style="list-style-type: none"> <li>– One cleaning cartridge</li> <li>– One test cartridge</li> </ul> </li> <li>• Specific hardware for attaching the drive to your specific system, as detailed on the parts listing provided with your drive.</li> </ul>

## Cleaning the tape drive (FC 5661)

You will need to clean your tape drive. Use the procedure in this topic to perform this task.

### About this task

Clean the device whenever the Fault status light comes on or a system I/O error related to the device occurs.

**Attention:** Use only the recommended cleaning cartridge to clean the tape drive. Use of other than recommended cleaning cartridge damages your drive and voids the warranty. The cleaning cartridge for this drive is P/N 46C1937 and it is the only cleaning cartridge that can be used in this drive.

The tape drive will turn on the cleaning indicator for the following reasons:

- The tape drive exceeds internal preset error thresholds in the drive.
- A cleaning cartridge that has been used the maximum number of times is inserted in the drive. The cleaning indicator is turned on to indicate that the cleaning process was not done and the cleaning cartridge is no longer usable.
- The tape drive exceeds the maximum recommended time between cleaning.

The tape drive determines how much to clean the drive and uses less or more cleaning media depending on what the drive determines is necessary. The average number of uses expected from a cleaning cartridge is 50, the minimum is 27, and the maximum is 70.

The maximum recommended time between preventive-maintenance cleaning is 50 tape motion hours. Tape motion hours are defined as the time that the tape drive is moving tape. If the tape drive reaches 50 tape motion hours since the tape drive was last cleaned, the drive turns on the cleaning required LED to indicate the drive needs cleaning. The tape drive will continue to operate but the tape drive must be cleaned at the next opportunity to insert a cleaning cartridge.

**Note:** Operating the tape drive in a low-humidity environment causes the drive to request cleaning more often than in normal humidity environment. In extreme low-humidity conditions of less than 15% relative humidity, the tape drive might request cleaning every 10 tape motion hours or even more frequently. For this reason, it is best not to use the tape drive in extremely low-humidity environments.

To clean the tape drive, complete the following steps:

### Procedure

1. Make sure that the power is on for the tape drive.
2. If a tape cartridge is in the tape drive, eject and remove the cartridge.
3. Grasp the cleaning cartridge by the outer edges, with the window-side up and the write-protect switch facing you.
4. Slide the cartridge into the opening on the front of the drive until the loading mechanism pulls the cartridge into the drive and the drive door closes.

### Results

After the cleaning cartridge has been inserted, the remainder of the cleaning process is automatic. The tape drive does the following actions:

- Loads the cleaning cartridge into the tape drive.
- Cleans the drive by moving the cleaning tape forward for approximately 30 seconds.
- Unloads the cleaning cartridge when the cleaning operation is complete.

- Indicates a successful cleaning operation by turning off the Cleaning status light (if the Cleaning light was on prior to the cleaning process. Otherwise, the Cleaning light remains solid to indicate that the cleaning cartridge is no longer usable. Obtain a new cleaning cartridge and repeat the process.)

**Note:** If the cleaning operation completes but the Cleaning light remains on, repeat the cleaning procedure with a new cleaning cartridge. If the light still remain on, contact your authorized service representative.

If you attempt to use a depleted cleaning cartridge, the drive automatically detects the error and ejects the cartridge. If the Cleaning status light was on prior to the cleaning process, it stays on; if the Cleaning light was off, the depleted cartridge causes the light to come on.

If a system error occurs, clean the drive and retry the operation. If the operation fails, replace the data cartridge, clean the drive again, then retry the operation.

## Loading and unloading cartridges

Learn about loading and unloading tape cartridges from this drive.

### About this task

To avoid problems with loading and unloading, use only one label on a cartridge. If the cartridge has too many or poorly-placed labels, the drive-load mechanism might clog.

### Loading a cartridge

#### About this task

To load a cartridge, complete the following steps:

#### Procedure

1. Make sure that the tape device power is on.
2. Grasp the cartridge by the outer edges, with the window side up and the write-protect switch facing you.

**Note:** Make sure that the write-protect switch is correctly set.

3. Slide the cartridge into the opening on the front of the device until the loading mechanism pulls the cartridge into the drive and the drive door closes.

#### Results

To indicate that the load operation was successful, the Ready status light comes on.

### Unloading a cartridge

#### About this task

To unload a cartridge, complete the following steps:

#### Procedure

1. Make sure that the tape device power is on.
2. Press the Unload button. The device rewinds, unloads, and ejects the tape cartridge.

The process might take from 15 seconds to several minutes, depending on the position of the tape and the amount of data written. During this task, the status lights do the following sequence:

- The Ready status light turns off.
- The Activity status light flashes during the unload operation.

- The Activity status light turns off when the cartridge is ejected from the tape drive.

## Results

**Attention:** An emergency eject and reset feature can be used to release the tape cartridge and reset the drive. Use the emergency eject feature if the cartridge does not move correctly or if the unload process fails. The emergency eject and reset feature procedure might result in loss of data. To perform an emergency eject operation of the tape cartridge or a reset operation of the drive, press and hold the Unload button for at least 10 seconds. If a cartridge is in the drive, the cartridge automatically ejects without rewinding the tape.

## Setting the write-protect switch (FC 5661)

You might need to set the write-protect switch on the media. Use the information in this topic to perform this task.

**Attention:** Do not attempt to change the write-protect settings after the tape cartridge is loaded in the drive because this might cause unpredictable results and might damage the tape or the drive.

The position of the write-protect switch on the tape cartridge determines when you can write to the tape.

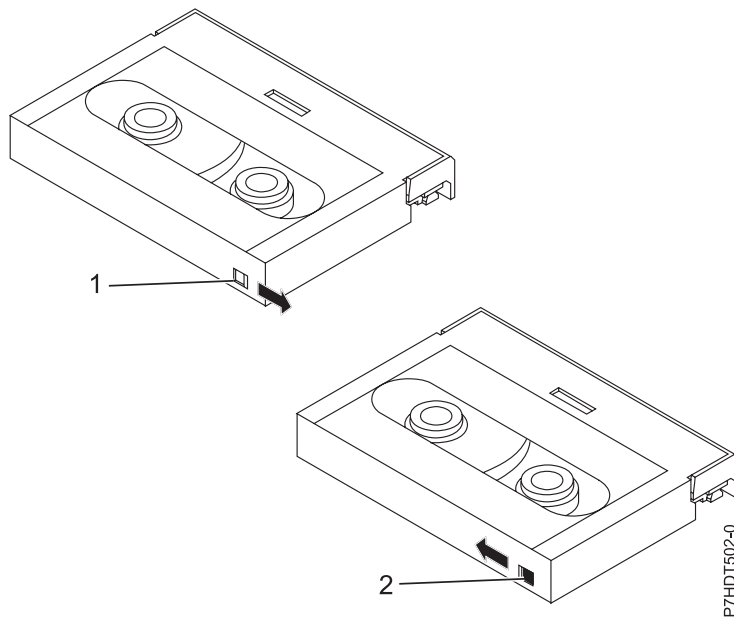

- 1** When the switch is set to the right, data can be written to and read from the tape.
- 2** When the switch is set to the left, data can only be read.

## Status lights (FC 5661)

You might need to read the status lights on your tape drive to determine the operating status of the drive. Use the information in this topic to perform this task.

The following illustration is a front view of the tape drive:

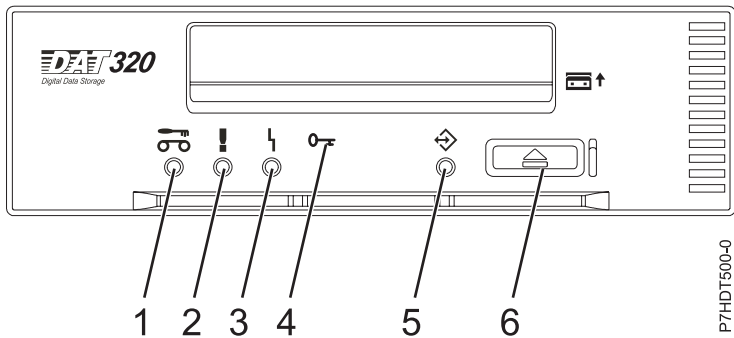

Figure 8. Front view of tape drive

- |          |                            |
|----------|----------------------------|
| <b>1</b> | Cleaning LED (amber)       |
| <b>2</b> | Media fault LED (amber)    |
| <b>3</b> | Drive fault LED (amber)    |
| <b>4</b> | Encrypt LED (blue)         |
| <b>5</b> | Ready/Activity LED (green) |
| <b>6</b> | Unload/Reset button        |

The combinations of the lights and their definitions are shown in the following table.

Table 30. Definition of status light combinations

Activity	Cleaning (amber) 	Tape fault (amber) 	Drive fault (amber) 	Encrypt fault (blue) 	Ready/ Activity (green) 
Power on LED test (5 seconds)	On	On	On	On	On
Power on self-test (POST) activity	Off	Off	Off	Off	Flash_2Hz
POST failed	Off	Off	Flash_2Hz	Off	Off
POST passed	On <sup>1</sup> or off	Off	Off	Off	Off
<b>Data cartridge</b>					
Loading	On <sup>1</sup> or off	Off	Off <sup>8</sup>	Off	Flash_2Hz
Loaded, no activity	On <sup>1</sup> or off	On <sup>2</sup> or off	Flash_2Hz <sup>4</sup> or off	Off	On
Loaded, activity	On <sup>1</sup> or off	On <sup>2</sup> or off	Flash_2Hz <sup>4</sup> or off	Off	Flash_2Hz
Unloading	On <sup>1</sup> or off	On <sup>2</sup> or off	Flash_2Hz <sup>4</sup> or off	Off	Flash_2Hz
Ejected	On <sup>1</sup> or off	On <sup>2</sup> or off	Flash_2Hz <sup>4</sup> or off	Off	Off
<b>Cleaning cartridge</b>					
Loading, cleaning, unloading	On	Off	Flash_2Hz <sup>4</sup> or off	Off	Flash_2Hz
Ejected, clean success	Off	Off	Flash_2Hz <sup>4</sup> or off	Off	Off
Ejected, clean failure	On <sup>1</sup>	On <sup>3</sup>	Flash_2Hz <sup>4</sup> or off	Off	Off



Table 30. Definition of status light combinations (continued)











Activity	Cleaning (amber) 	Tape fault (amber) 	Drive fault (amber) 	Encrypt fault (blue) 	Ready/ Activity (green) 	
Unrecoverable media failure	On	On	Off	Off	Flash_2Hz or on or off	
<b>Firmware download</b>						
Unload (if cartridge present)	See: Data Cartridge Unloading					
Download and reprogram	Flash_8Hz	Off	Off	Off	Flash_8Hz	
Reset (5 seconds)	On	On	On	Off	On	
Self-tests	See Power on self-test activity, and then see either POST passed or POST failed.					
Firmware download fail <sup>5</sup> <b>Note:</b> This is cleared when other activity occurs <sup>10</sup>	Off	Off	Flash_2Hz	Off	Off	
<b>Diagnostic tape test</b>						
Eject initiated primed drive to treat inserted data cartridge as diagnostic tape	Normal	Normal	Normal	Off	Flash_4Hz	
Initiated by SCSI diagnostic using normal data tape	In progress	See Data cartridge: Loaded, activity				
	Passed <sup>7</sup>	See Data cartridge: Loaded, no activity				
	Failed <sup>6</sup>	On	On	On	Normal	Flash_4Hz
	Until tape ejected. See Data cartridge: ejected					
Using tape with diagnostic tape recognition holes	In progress	See Data cartridge: loading				
		Flash_4Hz	Off	Off	Normal	Flash_4Hz
	Passed <sup>9</sup> , tape ejected	Off	Off	Off	Normal	Flash_4Hz
		See Data cartridge: ejected				
	Failed <sup>6</sup>	On	On	On	Normal	Flash_4Hz
	See Data cartridge: ejected					
<b>Encryption related<sup>11</sup></b>						
No encryption or decryption activity	Normal	Normal	Normal	Off	Normal	
Encryption parameters are loaded; the drive is ready to read/write encrypted data	Normal	Normal	Normal	On	Normal	
Drive is reading/writing encrypted data	Normal	Normal	Normal	Flash_2Hz	Flash_2Hz	
Encryption parameters loaded, but the drive is reading/writing unencrypted data.	Normal	Normal	Normal	On	Flash_2Hz	
Encryption related error exists	Normal	Normal	Flash_4Hz	Flash_4Hz	Normal	

Table 30. Definition of status light combinations (continued)

Activity	Cleaning (amber) 	Tape fault (amber) 	Drive fault (amber) 	Encrypt fault (blue) 	Ready/ Activity (green) 
<p><sup>1</sup> CLEAN_LED activation in this state means the drive needs cleaning. It will be set due to hard or soft errors. It is cleared upon successful cleaning cartridge usage. State is preserved over a power cycle.</p> <p><sup>2</sup> TAPE_LED activation in this state can only be due to a repeated hard or soft error. It is cleared when data or cleaning cartridge is inserted.</p> <p><sup>3</sup> TAPE_LED activation in this state can only be due to a cleaning cartridge failure. It is cleared when data or cleaning cartridge is inserted.</p> <p><sup>4</sup> DRIVE_LED activation in this state can only be due to the media management algorithm determining that the drive has a serious problem with regard to its write/read performance. It is not preserved over power cycle.</p> <p><sup>5</sup> The firmware download failed. The firmware download should be retried.  <b>Note:</b> This does not happen if the problem is simply due to an incorrect firmware image being attempted, for example, the DAT72 image being downloaded to DAT160. The purpose of this LED sequence is to show the user that the download failed and to retry the download. Examples of this are if the host failed to send all the data or if the hardware was unable to complete the task. This sequence is not activated if the microcode headers are invalid or if the code fails its checksum.</p> <p><sup>6</sup> The LED states for SCSI/tape diagnostic failed remain until the ejection is completed and then either the Eject button is pressed or another tape is inserted.</p> <p><sup>7</sup> The LEDs revert to nondiagnostic tape state (for example, for a loaded data tape).</p> <p><sup>8</sup> If the drive LED is on, the tape load is not initiated.</p> <p><sup>9</sup> The LED states for tape diagnostic passed remain until the auto-eject operation is completed.</p> <p><sup>10</sup> The firmware download failed LEDs continue to show until another change to the LEDs is required that is due to either cartridge loading or unloading or due to tape motion. So it is not SCSI commands, as such, that clear this but the response of the LED display to those SCSI commands. Tape access commands cause cartridge or tape motion to occur.</p>					

## Tape cartridges (FC 5661)

Learn about the types of tape cartridges that are available for this drive.

### Available tape cartridges

Table 31. 4 mm data cartridges

part number	Type of cartridge
46C1936	DAT320 160 GB Data Cartridge
46C1938	4 mm Test Cartridge
46C1937	4 mm Cleaning Cartridge (Only use on the DAT320 tape drive)

Most bulk eraser devices do not have the capability to erase the 4 mm data cartridge.

## Resetting the tape drive

You might need to reset your tape drive. Use the procedure in this topic to perform this task.

## About this task

Use this information to reset your tape drive, without affecting server operation. Allow up to 2 minutes for the entire tape drive process to complete.

**Attention:** Resetting a tape drive before the current backup operation has completed can cause loss of customer data.

To reset the tape drive, follow these steps:

### Procedure

1. Press and hold the eject button for 20 seconds, and then release the button. The LEDs on the drive will be flashing while the reset function is in process.
2. When the LEDs stop flashing, wait approximately one minute for the drive to complete the reset operation. The drive will then be ready to use.



---

## Managing DVD drives for the 9117-MMB or 9179-MHB

Learn about using and managing removable media devices. Find specifications and installation notes for specific drives.

---

### SATA Slimline DVD-RAM Drive (FC 5762)

Learn about the specifications of this DVD-RAM drive.

The serial advanced technology attachment (SATA) Slimline DVD-RAM Drive is an internal, low profile DVD-RAM drive that is capable of reading and writing 4.7 GB DVD-RAM discs, as well as reading a multitude of other optical media discs. This drive reads type II (removable from cartridge) DVD-RAM discs. The drive also reads CD-ROM, CD-R, CD-RW, DVD-R, DVD+R, DVD-RW, and DVD+RW. System boot and installation functions are supported with CD and DVD media.

#### Specifications

- FRU part number: 44V4220
- Custom card identification number (CCIN): 6331 model 004

**Note:** The model field is subject to change.

- Media:
  - Reads CD-ROM, CD-R, CD-RW, DVD-ROM, DVD-RAM, DVD-R, DVD+R, DVD-RW, and DVD+RW discs
  - Writes 4.7 GB DVD-RAM discs
- Interface: SATA
- Connector: Slimline SATA
- Connector: SATA
- Loading tray: supports 12 cm and 8 cm discs
- Operating positions: vertical or horizontal (8 cm discs require horizontal operation)
- Form factor: 12.7 mm Slimline
- DVD video: not supported
- AIX 5.1 only reads CD-type formatted DVD media
- Requirements: 1 Slimline media bay

---

### Handling and storing the DVD media

Learn how to handle and store the DVD media.

DVD media must be handled with care. Leaving the media exposed allows dirt particles to accumulate and to become a source of contamination. Handling the DVD media with care reduces errors and improves the performance.

#### Restrictions on using DVD media

**Correct ways to handle DVD media:**

1. Handle media by the outer edge or the center hole.
2. Store media in jewel cases specified for DVDs.
3. Return media to storage cases immediately after use to minimize the effects of environmental changes.

4. Store media in a cool, dry environment in which the air is clean.
5. Remove dirt, foreign materials, fingerprints, smudges, and liquids by wiping with a clean cotton fabric in a straight line from the center of the disc toward the outer edge.
6. Check the media surface before recording.

**Incorrect ways to handle DVD media:**

1. Touch the surface of the media.
2. Bend the media.
3. Use adhesive labels on the media.
4. Expose media to extreme heat or high humidity.
5. Expose media to prolonged sunlight or other sources of ultraviolet light.
6. Write or mark in the data area of the media.
7. Clean by wiping in a circular direction going around the disc.

---

## Opening a DVD tray manually

Under usual conditions, the tray automatically opens when you press the Load/Unload button. If it does not automatically open, you can use the emergency eject feature to open the tray manually.

Follow these steps to manually open the tray:

1. Follow your operating system instructions for shutting down your system, then turn off the power to your system unit. Unplug the power cord from the wall outlet.
2. Insert the straightened end of a paper clip into the emergency eject hole until you feel some resistance.
3. Continue to push in the paper clip while you pull out the tray with your fingernail.
4. Pull the tray completely open and remove the disc. It is usual for the tray to make a clicking sound while you are pulling it open.

---

## DVD-RAM type II disc

The DVD-RAM type II disc can be removed from its cartridge and played in a DVD-ROM or DVD-RAM drive that is compatible with the DVD-RAM type II disc.

**Attention:** Be careful when handling removed discs. Debris, dust particles, fingerprints, smears, or scratches can affect recording and playback of discs. Do not use solvents to clean disc surfaces. To clean a disc, use a soft, lint free cloth and gently wipe the disc surface outwards from the center hole to the outer edge. Do not rub, make circular motions or try to follow the circular lines in the disc. When labeling a disc, write only on the printed label side, using a soft felt-tip marker. Do not use a hard-tip pen to write on disc surface. Keep out of direct sunlight, high temperatures, and humidity. Do not attach labels to either side of the disc.

## Removing a disc from the cartridge

To remove a disc from the cartridge, do the following steps:

**Note:** Handle the disc only by its edges.

1. Use the tip of a ballpoint pen to push the locking pin up and out of the disc cartridge.
2. Use the tip of a ballpoint pen to push down on the lock button while pulling the cartridge lid open.
3. With the cartridge lid open, slide the disc out of the cartridge.

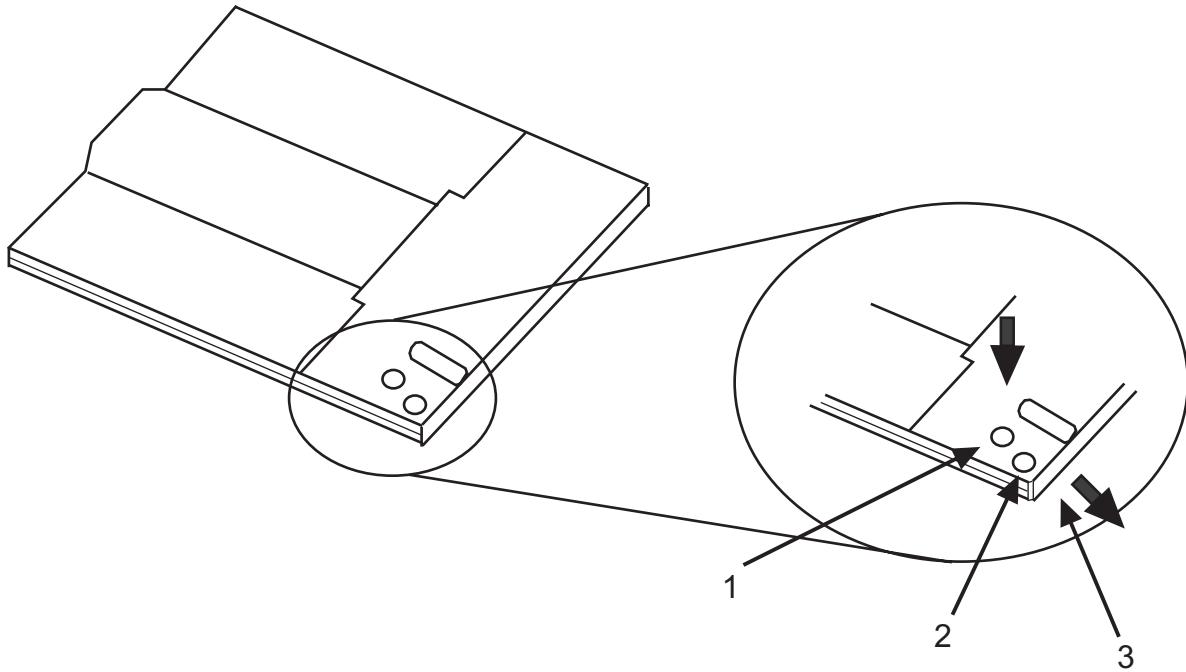

- 1 Locking Pin
- 2 Lock Button
- 3 Cartridge Lid

### Returning a disc to the cartridge

To return a disc to the cartridge, do the following steps:

**Notes:** Both the disc label and the cartridge label should be facing up. Handle the disc only by its edges.

1. Slide the disc into the cartridge.
2. Close the cartridge lid. Make sure the lock button snaps into position.
3. Install the locking pin.





---

## Managing diskette drives

Learn about the features of specific diskette drives.

---

### External USB 1.44 MB diskette drive (FC 2591)

Learn about the features of this media device.

The following provides information about the external USB 1.44 MB diskette drive.

<b>Installation and removal</b>	<p>To install this external USB 1.44 MB diskette drive, complete the following steps:</p> <ol style="list-style-type: none"><li>1. Unpack the device and ensure you have all the cables and parts.</li><li>2. Connect the USB cables to an available USB port on the system unit.</li><li>3. Wait for the system to recognize the new device (approximately 1-3 minutes).</li></ol> <p>To remove this external USB 1.44 MB diskette drive, complete the following steps:</p> <ol style="list-style-type: none"><li>1. Ensure you complete any processes running from or to the diskette drive.</li><li>2. Eject any diskette you have in the device.</li><li>3. Disconnect the device from the system unit.</li></ol>
<b>Description</b>	<p>The externally attached USB diskette drive provides storage capacity up to 1.44 MB on a high-density (2HD) diskette and 720 KB on a double-density diskette. Includes 350mm (13.7 in) captured cable with standard USB connector.</p> <p>Limitations:</p> <ul style="list-style-type: none"><li>• Maximum 1 USB diskette per adapter</li><li>• Up to 1 Keyboard and Mouse also supported on the adapter with the diskette drive at the same time</li><li>• No system boot capability</li><li>• Not to be operated upside down or with eject button down</li></ul> <p>Characteristics:</p> <ul style="list-style-type: none"><li>• FRU part number: 033P3339</li><li>• Capacity - 1.44 MB (2HD disk) or 720 KB (double-density disk)</li><li>• Physical Dimensions: Width=103mm (4.05 in), Height=17.6mm (.69 in), Depth=141.8-mm (5.58 in)</li><li>• Color: Black</li><li>• Data Rate: 12 Mbits/sec</li><li>• Maximum Power Consumption: 2.36 Watt (seek)</li><li>• Operates in all positions except those noted in the preceding limitations</li><li>• Attributes provided: External diskette drive</li><li>• Attributes required: 1 available USB port</li></ul>



---

## Managing removable disk drives

Learn about using and managing removable disk drives. Find specifications and installation notes for specific drives.

---

### USB Removable Disk Drive (FC 1104, 1106, 1107, 1123, EU01, and EU08)

Learn about the features of this drive.

#### Description

The FC 1123 information applies only to the 31E/2B, 31E/1C, or 31E/2C systems.

The USB Removable Disk Drive consists of a docking station, which holds a removable disk drive. The docking station is available as an internal or external device. The disk drive is a backup and restore device that can be used as an alternative to tape drives. The removable disk drive is not a replacement for regular disk drives and cannot be used as part of a disk array. The following illustrations show the internal and external drives.

Figure 9. Internal drive, front view

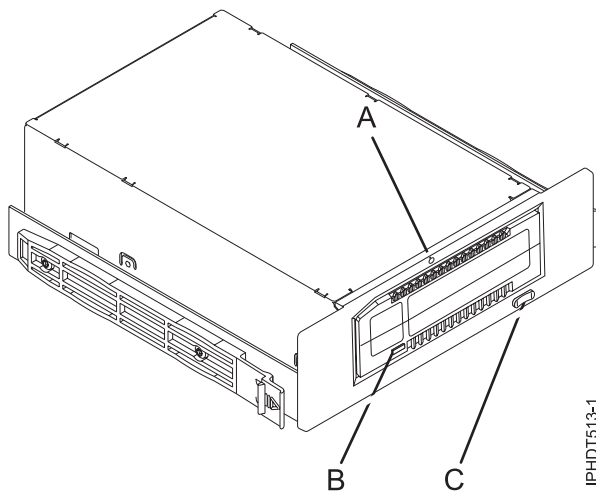

- A Emergency eject hole
- B Cartridge indicator light
- C Eject button and power indicator light

Figure 10. External drive, front view

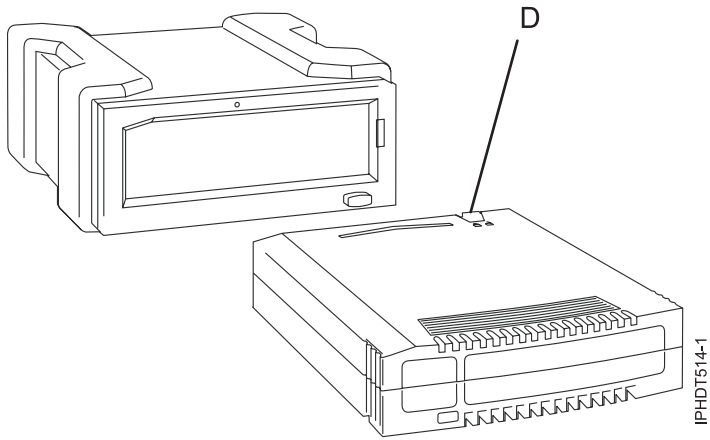

D Write-protect switch

Figure 11. Internal drive, rear view, and connectors

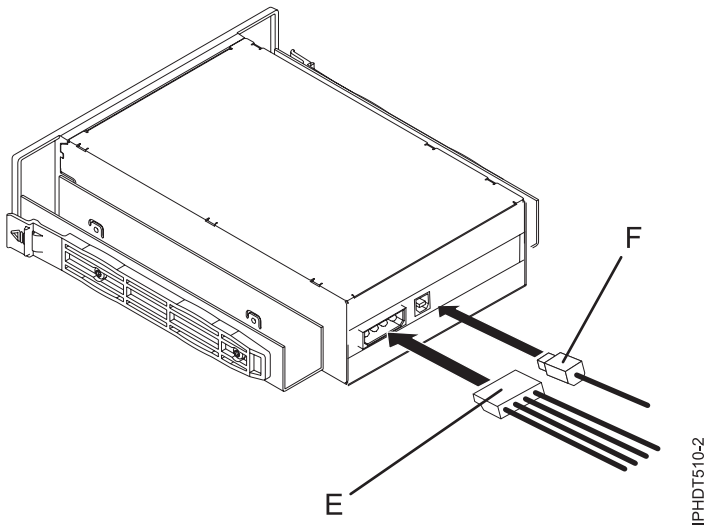

E Power connector

F USB connector

Figure 12. External drive, rear view, and connectors

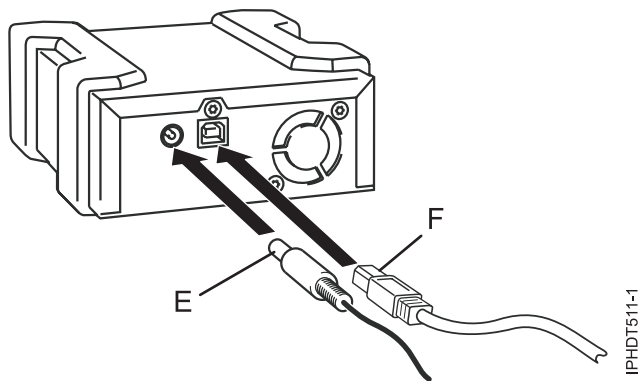

- E Power connector
- F USB connector

## Feature codes and part numbers

Learn about the feature codes (FCs) and part numbers for the USB Removable Disk Drive.

### FC 1103 - USB Internal Docking Station for Removable Disk Drive

FC 1103 uses an internal USB cable to connect to the internal USB port on the control panel of a system that supports this feature. The USB and power cable are included in the feature code.

FC 1103 provides the following parts:

- 46C5370 (FRU: 46C5380) - USB Internal docking station
- 46K7435 - Internal USB cable (12 inch)
- 46K7434 - Internal power cable (11 inch) with right angle power connector
- 44V3429 - Two drive slide assembly rails
- 1621187 - Four flat blade screws

### FC 1104 - USB External Docking Station for Removable Disk Drive

FC 1104 uses an external USB cable to connect to an external USB port. The 1104 feature code includes a USB cable, external power supply, and power cord as part of the feature code.

FC 1104 provides the following parts:

- 46C5381 - USB external docking station
- 44E8889 - External USB cable
- 49Y9890 - External power supply with power cord and universal plugs for all supported geographies
- 39M5516 - Power cord (1 m) from the power supply to the rack power distribution unit

## Removable disk drives

Table 32. Removable disk drives

Feature code	Part number	Description
1106	46C5375	160 GB Removable Disk Drive
EU08	46C5377	320 GB Removable Disk Drive
1107	46C5379	500 GB Removable Disk Drive
EU01	46C2335	1 TB Removable Disk Drive

## Storing removable disk drives

Store removable disk drives in their protective containers, on a flat surface with the top side up. The storage area must be clean, dry, normal room temperature, and away from any magnetic fields. For best storage life, use the removable disk drives every six months.

## Supported USB adapters and cables

**Attention:** The docking station only supports the USB cable that is provided as part of the feature code. The docking station does not support attachment using USB hubs, add-on USB cables, or USB cable extenders.

The external docking station can be connected to the external, integrated USB ports on POWER7 systems or to the USB ports on 4-Port USB PCI Express<sup>®</sup> Adapter (FC 2728).

The internal docking station can be connected to the internal USB port on the control panel of POWER7 systems.

### Note:

When the USB port on the control panel is used for the docking station, the port is disabled for any other use. This information does not apply to 31E/2B, 31E/1C, or 31E/2C systems.

## Specifications

### Interface

USB 2.0

### Mksysb

Yes

### Bootable

Yes

### Physical form factor (internal docking station)

5.25 inch half high

3.5 inch half high for the 31E/2B, 31E/1C, 31E/2C systems (FC 1123)

### Environmental

USB Removable Disk Drive	Operating conditions	Nonoperating conditions
Temperature	5 -55°C	-40 -65°C
Relative humidity	8 -90% noncondensing	5 -95% noncondensing
Maximum wet bulb temperature	29.4°C noncondensing	40°C noncondensing
Maximum temperature gradient	20°C per hour	20°C per hour
Altitude	-300 -3048 m (10,000 ft)	-300 -12,192 m (40,000 ft)

## Supported operating systems

USB Removable Disk Drive is supported on the following versions of operating systems:

- AIX 5L Version 5.3 with the 5300-11 Technology Level, or later
- AIX Version 6.1 with the 6100-04 Technology Level, or later
- Red Hat Enterprise Linux version 3 Update 7, or later
- SUSE Linux Enterprise Server 10, or later

## Using the USB Removable Disk Drive for backup and restore

The disk drive is a backup and restore device that can be used as an alternative to tape drives. The removable disk drive is not a replacement for regular disk drives and cannot be used as part of a disk array.

**Note:** If power is lost during a backup to the disk, the data can be compromised. Verify the data or rerun the backup.

## Using the drive with AIX

AIX names the drive `usbmsx`. For example, `usbms1` and `usbms2`. AIX also can use the device as a raw device. For example, `rusbms1` and `rusbms2`.

AIX uses the removable disk drive differently depending on the program being used. The AIX `mksysb` command builds a list of files to back up, creates a universal disk format (UDF) file system, and puts a boot image and the root volume group on the removable disk drive. When the `mksysb` process is complete the removable disk drive can be used to boot the system. If you mount the removable disk drive, you can display and copy files to and from the UDF file system on the removable disk drive.

The AIX `tar`, `backup`, `restore`, `dd`, and `cpio` commands can write to the removable disk drive as a raw device or non raw device. You might get improved performance by using the device as a raw device.

See the AIX documentation for additional information.

## Using the drive with Linux

Linux configures the drive as a disk drive with a name in the format `sdx`, for example, `sda`, `sdb`, and `sdc`.

See the Linux documentation for information about using Linux copy and backup commands.

## Setting the write-protect switch

The removable disk drives have a red, write-protect tab that is located on the back of the drive. To write-protect a drive, slide the write-protect tab toward the lock symbol. To disengage write protection, slide the tab to the unlock symbol.

## Using the emergency eject function

To eject a removable disk drive, press the eject button. If a drive is stuck, follow these steps:

1. If you using the internal docking station, power off the system. If you are using the external docking station, unplug the power cable from the device.
2. Insert a large straightened paper clip (or similar object) into the emergency eject hole. Do not insert the object in the hole at an angle. Keep the object straight and apply some force to eject the drive.
3. When the drive has been ejected by the docking station, grasp the exposed sides of the drive and pull the drive straight out.
4. Restart your system to reset the docking station. If you are using the external docking station, reconnect the power cable for the docking station and then restart the system.

## Status lights

Learn about the power indicator and drive indicator status lights on the USB Removable Disk Drive.

### Power indicator

The eject button is illuminated by a power indicator light. The following table describes the operation of the power indicator.

*Table 33. Power indicator*

Indicator status	Meaning	Description
Off	No power	Docking station does not have power.
Steady green	Ready	Power is on and the docking station is working correctly.
Flashing green	Ejecting	Cartridge is ejecting.
Flashing amber	Fault	Docking station has detected a fault condition with the docking station.

### Removable disk drive indicator

The disk drive has an indicator light that displays the status of the drive. The following table describes the operation of the drive indicator.

*Table 34. Cartridge indicator*

Indicator status	Meaning	Description
Off	Not ready	Drive is not inserted correctly or the docking station has no power
Steady green	Ready	Drive is ready
Flashing green	Activity	Drive is reading, writing, or seeking
Flashing amber	Fault	Docking station has detected a fault condition with the cartridge

### Installing the docking station for the removable disk drive

For comprehensive installation instructions, see the Media devices topic.

Keep in mind the following points when you install FC 1104, the USB External Docking Station for Removable Disk Drive:

- A rack shelf is not included with FC 1104.
- The docking station can be rested on a flat surface in a rack or on a table top next to a rack.
- Ensure that the device is on a flat surface, is right side up, and is not likely to be bumped, dropped, or otherwise damaged or jolted.
- If the docking station is placed by itself on a rack shelf, it will have space on the sides of the device. No filler panels are provided with the docking station.
- If the docking station is placed on a rack shelf, ensure that the docking station has sufficient air flow but that it does not affect the air flow of the other systems in the rack.
- Do not block the fan on the back of the docking station.



---

## Notices

This information was developed for products and services offered in the U.S.A.

The manufacturer may not offer the products, services, or features discussed in this document in other countries. Consult the manufacturer's representative for information on the products and services currently available in your area. Any reference to the manufacturer's product, program, or service is not intended to state or imply that only that product, program, or service may be used. Any functionally equivalent product, program, or service that does not infringe any intellectual property right of the manufacturer may be used instead. However, it is the user's responsibility to evaluate and verify the operation of any product, program, or service.

The manufacturer may have patents or pending patent applications covering subject matter described in this document. The furnishing of this document does not grant you any license to these patents. You can send license inquiries, in writing, to the manufacturer.

**The following paragraph does not apply to the United Kingdom or any other country where such provisions are inconsistent with local law:** THIS PUBLICATION IS PROVIDED "AS IS" WITHOUT WARRANTY OF ANY KIND, EITHER EXPRESS OR IMPLIED, INCLUDING, BUT NOT LIMITED TO, THE IMPLIED WARRANTIES OF NON-INFRINGEMENT, MERCHANTABILITY OR FITNESS FOR A PARTICULAR PURPOSE. Some states do not allow disclaimer of express or implied warranties in certain transactions, therefore, this statement may not apply to you.

This information could include technical inaccuracies or typographical errors. Changes are periodically made to the information herein; these changes will be incorporated in new editions of the publication. The manufacturer may make improvements and/or changes in the product(s) and/or the program(s) described in this publication at any time without notice.

Any references in this information to websites not owned by the manufacturer are provided for convenience only and do not in any manner serve as an endorsement of those websites. The materials at those websites are not part of the materials for this product and use of those websites is at your own risk.

The manufacturer may use or distribute any of the information you supply in any way it believes appropriate without incurring any obligation to you.

Any performance data contained herein was determined in a controlled environment. Therefore, the results obtained in other operating environments may vary significantly. Some measurements may have been made on development-level systems and there is no guarantee that these measurements will be the same on generally available systems. Furthermore, some measurements may have been estimated through extrapolation. Actual results may vary. Users of this document should verify the applicable data for their specific environment.

Information concerning products not produced by this manufacturer was obtained from the suppliers of those products, their published announcements or other publicly available sources. This manufacturer has not tested those products and cannot confirm the accuracy of performance, compatibility or any other claims related to products not produced by this manufacturer. Questions on the capabilities of products not produced by this manufacturer should be addressed to the suppliers of those products.

All statements regarding the manufacturer's future direction or intent are subject to change or withdrawal without notice, and represent goals and objectives only.

The manufacturer's prices shown are the manufacturer's suggested retail prices, are current and are subject to change without notice. Dealer prices may vary.

This information is for planning purposes only. The information herein is subject to change before the products described become available.

This information contains examples of data and reports used in daily business operations. To illustrate them as completely as possible, the examples include the names of individuals, companies, brands, and products. All of these names are fictitious and any similarity to the names and addresses used by an actual business enterprise is entirely coincidental.

If you are viewing this information in softcopy, the photographs and color illustrations may not appear.

The drawings and specifications contained herein shall not be reproduced in whole or in part without the written permission of the manufacturer.

The manufacturer has prepared this information for use with the specific machines indicated. The manufacturer makes no representations that it is suitable for any other purpose.

The manufacturer's computer systems contain mechanisms designed to reduce the possibility of undetected data corruption or loss. This risk, however, cannot be eliminated. Users who experience unplanned outages, system failures, power fluctuations or outages, or component failures must verify the accuracy of operations performed and data saved or transmitted by the system at or near the time of the outage or failure. In addition, users must establish procedures to ensure that there is independent data verification before relying on such data in sensitive or critical operations. Users should periodically check the manufacturer's support websites for updated information and fixes applicable to the system and related software.

### **Ethernet connection usage restriction**

This product is not intended to be connected directly or indirectly by any means whatsoever to interfaces of public telecommunications networks.

---

## **Trademarks**

IBM, the IBM logo, and [ibm.com](http://ibm.com) are trademarks or registered trademarks of International Business Machines Corp., registered in many jurisdictions worldwide. Other product and service names might be trademarks of IBM or other companies. A current list of IBM trademarks is available on the web at [www.ibm.com/legal/copytrade.shtml](http://www.ibm.com/legal/copytrade.shtml).

Linux is a registered trademark of Linus Torvalds in the United States, other countries, or both.

Red Hat, the Red Hat "Shadow Man" logo, and all Red Hat-based trademarks and logos are trademarks or registered trademarks of Red Hat, Inc., in the United States and other countries.

Other product and service names might be trademarks of IBM or other companies.

---

## **Electronic emission notices**

When attaching a monitor to the equipment, you must use the designated monitor cable and any interference suppression devices supplied with the monitor.

## **Class A Notices**

The following Class A statements apply to the servers.

## **Federal Communications Commission (FCC) statement**

**Note:** This equipment has been tested and found to comply with the limits for a Class A digital device, pursuant to Part 15 of the FCC Rules. These limits are designed to provide reasonable protection against harmful interference when the equipment is operated in a commercial environment. This equipment generates, uses, and can radiate radio frequency energy and, if not installed and used in accordance with the instruction manual, may cause harmful interference to radio communications. Operation of this equipment in a residential area is likely to cause harmful interference, in which case the user will be required to correct the interference at his own expense.

Properly shielded and grounded cables and connectors must be used in order to meet FCC emission limits. IBM is not responsible for any radio or television interference caused by using other than recommended cables and connectors or by unauthorized changes or modifications to this equipment. Unauthorized changes or modifications could void the user's authority to operate the equipment.

This device complies with Part 15 of the FCC rules. Operation is subject to the following two conditions: (1) this device may not cause harmful interference, and (2) this device must accept any interference received, including interference that may cause undesired operation.

## **Industry Canada Compliance Statement**

This Class A digital apparatus complies with Canadian ICES-003.

## **Avis de conformité à la réglementation d'Industrie Canada**

Cet appareil numérique de la classe A est conforme à la norme NMB-003 du Canada.

## **European Community Compliance Statement**

This product is in conformity with the protection requirements of EU Council Directive 2004/108/EC on the approximation of the laws of the Member States relating to electromagnetic compatibility. IBM® cannot accept responsibility for any failure to satisfy the protection requirements resulting from a non-recommended modification of the product, including the fitting of non-IBM option cards.

This product has been tested and found to comply with the limits for Class A Information Technology Equipment according to European Standard EN 55022. The limits for Class A equipment were derived for commercial and industrial environments to provide reasonable protection against interference with licensed communication equipment.

European Community contact:  
IBM Deutschland GmbH  
Technical Regulations, Department M456  
IBM-Allee 1, 71139 Ehningen, Germany  
Tele: +49 7032 15-2937  
email: tjahn@de.ibm.com

**Warning:** This is a Class A product. In a domestic environment, this product may cause radio interference, in which case the user may be required to take adequate measures.

## VCCI Statement - Japan

この装置は、クラスA 情報技術装置です。この装置を家庭環境で使用すると電波妨害を引き起こすことがあります。この場合には使用者が適切な対策を講ずるよう要求されることがあります。

VCCI-A

The following is a summary of the VCCI Japanese statement in the box above:

This is a Class A product based on the standard of the VCCI Council. If this equipment is used in a domestic environment, radio interference may occur, in which case, the user may be required to take corrective actions.

### Japanese Electronics and Information Technology Industries Association (JEITA) Confirmed Harmonics Guideline (products less than or equal to 20 A per phase)

高調波ガイドライン適合品

### Japanese Electronics and Information Technology Industries Association (JEITA) Confirmed Harmonics Guideline with Modifications (products greater than 20 A per phase)

高調波ガイドライン準用品

## Electromagnetic Interference (EMI) Statement - People's Republic of China

### 声 明

此为 A 级产品, 在生活环境中, 该产品可能会造成无线电干扰。在这种情况下, 可能需要用户对其干扰采取切实可行的措施。

Declaration: This is a Class A product. In a domestic environment this product may cause radio interference in which case the user may need to perform practical action.

## Electromagnetic Interference (EMI) Statement - Taiwan

警告使用者：  
這是甲類的資訊產品，在居住的環境中使用時，可能會造成射頻干擾，在這種情況下，使用者會被要求採取某些適當的對策。

The following is a summary of the EMI Taiwan statement above.

Warning: This is a Class A product. In a domestic environment this product may cause radio interference in which case the user will be required to take adequate measures.

## Electromagnetic Interference (EMI) Statement - Korea

이 기기는 업무용(A급)으로 전자파적합기기로서 판매자 또는 사용자는 이 점을 주의하시기 바라며, 가정외의 지역에서 사용하는 것을 목적으로 합니다.

## Germany Compliance Statement

**Deutschsprachiger EU Hinweis: Hinweis für Geräte der Klasse A EU-Richtlinie zur Elektromagnetischen Verträglichkeit**

Dieses Produkt entspricht den Schutzanforderungen der EU-Richtlinie 2004/108/EG zur Angleichung der Rechtsvorschriften über die elektromagnetische Verträglichkeit in den EU-Mitgliedsstaaten und hält die Grenzwerte der EN 55022 Klasse A ein.

Um dieses sicherzustellen, sind die Geräte wie in den Handbüchern beschrieben zu installieren und zu betreiben. Des Weiteren dürfen auch nur von der IBM empfohlene Kabel angeschlossen werden. IBM übernimmt keine Verantwortung für die Einhaltung der Schutzanforderungen, wenn das Produkt ohne Zustimmung von IBM verändert bzw. wenn Erweiterungskomponenten von Fremdherstellern ohne Empfehlung von IBM gesteckt/eingebaut werden.

EN 55022 Klasse A Geräte müssen mit folgendem Warnhinweis versehen werden:

"Warnung: Dieses ist eine Einrichtung der Klasse A. Diese Einrichtung kann im Wohnbereich Funk-Störungen verursachen; in diesem Fall kann vom Betreiber verlangt werden, angemessene Maßnahmen zu ergreifen und dafür aufzukommen."

**Deutschland: Einhaltung des Gesetzes über die elektromagnetische Verträglichkeit von Geräten**

Dieses Produkt entspricht dem "Gesetz über die elektromagnetische Verträglichkeit von Geräten (EMVG)". Dies ist die Umsetzung der EU-Richtlinie 2004/108/EG in der Bundesrepublik Deutschland.

## Zulassungsbescheinigung laut dem Deutschen Gesetz über die elektromagnetische Verträglichkeit von Geräten (EMVG) (bzw. der EMC EG Richtlinie 2004/108/EG) für Geräte der Klasse A

Dieses Gerät ist berechtigt, in Übereinstimmung mit dem Deutschen EMVG das EG-Konformitätszeichen - CE - zu führen.

Verantwortlich für die Einhaltung der EMV Vorschriften ist der Hersteller:

International Business Machines Corp.  
New Orchard Road  
Armonk, New York 10504  
Tel: 914-499-1900

Der verantwortliche Ansprechpartner des Herstellers in der EU ist:

IBM Deutschland GmbH  
Technical Regulations, Abteilung M456  
IBM-Allee 1, 71139 Ehningen, Germany  
Tel: +49 7032 15-2937  
email: tjahn@de.ibm.com

Generelle Informationen:

Das Gerät erfüllt die Schutzanforderungen nach EN 55024 und EN 55022 Klasse A.

### Electromagnetic Interference (EMI) Statement - Russia

**ВНИМАНИЕ!** Настоящее изделие относится к классу А.  
В жилых помещениях оно может создавать радиопомехи, для снижения которых необходимы дополнительные меры

---

## Terms and conditions

Permissions for the use of these publications are granted subject to the following terms and conditions.

**Applicability:** These terms and conditions are in addition to any terms of use for the the manufacturer website.

**Personal Use:** You may reproduce these publications for your personal, noncommercial use provided that all proprietary notices are preserved. You may not distribute, display or make derivative works of these publications, or any portion thereof, without the express consent of the manufacturer.

**Commercial Use:** You may reproduce, distribute and display these publications solely within your enterprise provided that all proprietary notices are preserved. You may not make derivative works of these publications, or reproduce, distribute or display these publications or any portion thereof outside your enterprise, without the express consent of the manufacturer.

**Rights:** Except as expressly granted in this permission, no other permissions, licenses or rights are granted, either express or implied, to the Publications or any information, data, software or other intellectual property contained therein.

The manufacturer reserves the right to withdraw the permissions granted herein whenever, in its discretion, the use of the publications is detrimental to its interest or, as determined by the manufacturer, the above instructions are not being properly followed.

You may not download, export or re-export this information except in full compliance with all applicable laws and regulations, including all United States export laws and regulations.

THE MANUFACTURER MAKES NO GUARANTEE ABOUT THE CONTENT OF THESE PUBLICATIONS. THE PUBLICATIONS ARE PROVIDED "AS-IS" AND WITHOUT WARRANTY OF ANY KIND, EITHER EXPRESSED OR IMPLIED, INCLUDING BUT NOT LIMITED TO IMPLIED WARRANTIES OF MERCHANTABILITY, NON-INFRINGEMENT, AND FITNESS FOR A PARTICULAR PURPOSE.

