

Beginning troubleshooting and problem analysis

ESCALA Power7



REFERENCE  
86 A1 44FF 04



# ESCALA Power7

## Beginning troubleshooting and problem analysis

The ESCALA Power7 publications concern the following models:

- Bull Escala E5-700 (Power 750 / 8233-E8B)
- Bull Escala M6-700 (Power 770 / 9117-MMB)
- Bull Escala M6-705 (Power 770 / 9117-MMC)
- Bull Escala M7-700 (Power 780 / 9179-MHB)
- Bull Escala M7-705 (Power 780 / 9179-MHC)
- Bull Escala E1-700 (Power 710 / 8231-E2B)
- Bull Escala E1-705 (Power 710 / 8231-E1C)
- Bull Escala E2-700 / E2-700T (Power 720 / 8202-E4B)
- Bull Escala E2-705 / E2-705T (Power 720 / 8202-E4C)
- Bull Escala E3-700 (Power 730 / 8231-E2B)
- Bull Escala E3-705 (Power 730 / 8231-E2C)
- Bull Escala E4-700 / E4-700T (Power 740 / 8205-E6B)
- Bull Escala E4-705 (Power 740 / 8205-E6C)

References to Power 755 / 8236-E8C models are irrelevant.

## Hardware

October 2011

BULL CEDOC  
357 AVENUE PATTON  
B.P.20845  
49008 ANGERS CEDEX 01  
FRANCE

**REFERENCE**  
**86 A1 44FF 04**

The following copyright notice protects this book under Copyright laws which prohibit such actions as, but not limited to, copying, distributing, modifying, and making derivative works.

Copyright © Bull SAS 2011

Printed in France

Suggestions and criticisms concerning the form, content, and presentation of this book are invited. A form is provided at the end of this book for this purpose.

To order additional copies of this book or other Bull Technical Publications, you are invited to use the Ordering Form also provided at the end of this book.

### **Trademarks and Acknowledgements**

We acknowledge the right of proprietors of trademarks mentioned in this book.

*The information in this document is subject to change without notice. Bull will not be liable for errors contained herein, or for incidental or consequential damages in connection with the use of this material.*

---

# Contents

<b>Safety notices</b> . . . . .	<b>v</b>
<b>Beginning troubleshooting and problem analysis</b> . . . . .	<b>1</b>
Beginning problem analysis . . . . .	1
AIX and Linux problem analysis. . . . .	8
IBM i problem analysis . . . . .	10
Problem analysis for 7874-024, 7874-040, 7874-120, and 7874-240 switches. . . . .	14
Isolating InfiniBand switch link errors for 7874-024, 7874-040, 7874-120, and 7874-240 switches . . . . .	18
Collecting data for InfiniBand switch errors for 7874-024, 7874-040, 7874-120, and 7874-240 switches. . . . .	19
Collecting data from the cluster systems management server for 7874-024, 7874-040, 7874-120, and 7874-240 switches . . . . .	22
Collecting data from the fabric management server for 7874-024, 7874-040, 7874-120, and 7874-240 switches . . . . .	23
Collecting data for Fast Fabric Health Check for 7874-024, 7874-040, 7874-120, and 7874-240 switches . . . . .	23
Capturing switch CLI output using a script command for 7874-024, 7874-040, 7874-120, and 7874-240 switches . . . . .	24
Light path diagnostics on Power Systems . . . . .	24
Replacing FRUs using enclosure fault indicators . . . . .	26
Service labels . . . . .	28
Problem reporting form . . . . .	28
Starting a repair action . . . . .	30
Reference information for problem determination. . . . .	32
Symptom index . . . . .	32
IBM i server or IBM i partition symptoms . . . . .	32
AIX server or AIX partition symptoms . . . . .	36
MAP 0410: Repair checkout . . . . .	46
Linux server or Linux partition symptoms . . . . .	50
Linux fast-path problem isolation . . . . .	58
Detecting problems. . . . .	70
IBM i problem determination procedures . . . . .	70
Searching the service action log. . . . .	70
Using the product activity log . . . . .	72
Using the problem log. . . . .	72
Problem determination procedure for AIX or Linux servers or partitions . . . . .	73
System unit problem determination . . . . .	73
Management console machine code problems . . . . .	76
Launching an xterm shell. . . . .	76
Viewing the management console logs . . . . .	76
Problem determination procedures . . . . .	78
Disk drive module power-on self-tests . . . . .	78
SCSI card power-on self-tests . . . . .	78
7031-D24 or 7031-T24 disk-drive enclosure LEDs . . . . .	79
7031-D24 or 7031-T24 maintenance analysis procedures. . . . .	82
Analyzing problems . . . . .	92
Problems with loading and starting the operating system (AIX and Linux) . . . . .	93
PFW1540: Problem isolation procedures . . . . .	96
PFW1542: I/O problem isolation procedure. . . . .	97
PFW1548: Memory and processor subsystem problem isolation procedure . . . . .	112
PFW1548: Memory and processor subsystem problem isolation procedure when a management console is attached . . . . .	125
PFW1548: Memory and processor subsystem problem isolation procedure without a management console attached . . . . .	132
Problems with noncritical resources . . . . .	140
Intermittent problems . . . . .	140
About intermittent problems . . . . .	141

General intermittent problem checklist . . . . .	142
Analyzing intermittent problems . . . . .	144
Intermittent symptoms . . . . .	144
Failing area intermittent isolation procedures. . . . .	144
IPL problems . . . . .	145
Cannot perform IPL from the control panel (no SRC) . . . . .	145
Cannot perform IPL at a specified time (no SRC) . . . . .	146
Cannot automatically perform an IPL after a power failure . . . . .	149
Power problems . . . . .	150
Cannot power on system unit . . . . .	150
Cannot power on SPCN-controlled I/O expansion unit . . . . .	154
Cannot power off system or SPCN-controlled I/O expansion unit . . . . .	159

**Notices . . . . . 167**

Trademarks . . . . .	168
Electronic emission notices . . . . .	168
Class A Notices. . . . .	168
Class B Notices. . . . .	172
Terms and conditions. . . . .	175

---

## Safety notices

Safety notices may be printed throughout this guide:

- **DANGER** notices call attention to a situation that is potentially lethal or extremely hazardous to people.
- **CAUTION** notices call attention to a situation that is potentially hazardous to people because of some existing condition.
- **Attention** notices call attention to the possibility of damage to a program, device, system, or data.

### World Trade safety information

Several countries require the safety information contained in product publications to be presented in their national languages. If this requirement applies to your country, a safety information booklet is included in the publications package shipped with the product. The booklet contains the safety information in your national language with references to the U.S. English source. Before using a U.S. English publication to install, operate, or service this product, you must first become familiar with the related safety information in the booklet. You should also refer to the booklet any time you do not clearly understand any safety information in the U.S. English publications.

### German safety information

Das Produkt ist nicht für den Einsatz an Bildschirmarbeitsplätzen im Sinne § 2 der Bildschirmarbeitsverordnung geeignet.

### Laser safety information

IBM® servers can use I/O cards or features that are fiber-optic based and that utilize lasers or LEDs.

### Laser compliance

IBM servers may be installed inside or outside of an IT equipment rack.

## DANGER

When working on or around the system, observe the following precautions:

Electrical voltage and current from power, telephone, and communication cables are hazardous. To avoid a shock hazard:

- Connect power to this unit only with the IBM provided power cord. Do not use the IBM provided power cord for any other product.
- Do not open or service any power supply assembly.
- Do not connect or disconnect any cables or perform installation, maintenance, or reconfiguration of this product during an electrical storm.
- The product might be equipped with multiple power cords. To remove all hazardous voltages, disconnect all power cords.
- Connect all power cords to a properly wired and grounded electrical outlet. Ensure that the outlet supplies proper voltage and phase rotation according to the system rating plate.
- Connect any equipment that will be attached to this product to properly wired outlets.
- When possible, use one hand only to connect or disconnect signal cables.
- Never turn on any equipment when there is evidence of fire, water, or structural damage.
- Disconnect the attached power cords, telecommunications systems, networks, and modems before you open the device covers, unless instructed otherwise in the installation and configuration procedures.
- Connect and disconnect cables as described in the following procedures when installing, moving, or opening covers on this product or attached devices.

To Disconnect:

1. Turn off everything (unless instructed otherwise).
2. Remove the power cords from the outlets.
3. Remove the signal cables from the connectors.
4. Remove all cables from the devices

To Connect:

1. Turn off everything (unless instructed otherwise).
2. Attach all cables to the devices.
3. Attach the signal cables to the connectors.
4. Attach the power cords to the outlets.
5. Turn on the devices.

(D005)

## DANGER



Observe the following precautions when working on or around your IT rack system:

- Heavy equipment—personal injury or equipment damage might result if mishandled.
- Always lower the leveling pads on the rack cabinet.
- Always install stabilizer brackets on the rack cabinet.
- To avoid hazardous conditions due to uneven mechanical loading, always install the heaviest devices in the bottom of the rack cabinet. Always install servers and optional devices starting from the bottom of the rack cabinet.
- Rack-mounted devices are not to be used as shelves or work spaces. Do not place objects on top of rack-mounted devices.



- Each rack cabinet might have more than one power cord. Be sure to disconnect all power cords in the rack cabinet when directed to disconnect power during servicing.
- Connect all devices installed in a rack cabinet to power devices installed in the same rack cabinet. Do not plug a power cord from a device installed in one rack cabinet into a power device installed in a different rack cabinet.
- An electrical outlet that is not correctly wired could place hazardous voltage on the metal parts of the system or the devices that attach to the system. It is the responsibility of the customer to ensure that the outlet is correctly wired and grounded to prevent an electrical shock.

#### CAUTION

- Do not install a unit in a rack where the internal rack ambient temperatures will exceed the manufacturer's recommended ambient temperature for all your rack-mounted devices.
- Do not install a unit in a rack where the air flow is compromised. Ensure that air flow is not blocked or reduced on any side, front, or back of a unit used for air flow through the unit.
- Consideration should be given to the connection of the equipment to the supply circuit so that overloading of the circuits does not compromise the supply wiring or overcurrent protection. To provide the correct power connection to a rack, refer to the rating labels located on the equipment in the rack to determine the total power requirement of the supply circuit.
- *(For sliding drawers.)* Do not pull out or install any drawer or feature if the rack stabilizer brackets are not attached to the rack. Do not pull out more than one drawer at a time. The rack might become unstable if you pull out more than one drawer at a time.
- *(For fixed drawers.)* This drawer is a fixed drawer and must not be moved for servicing unless specified by the manufacturer. Attempting to move the drawer partially or completely out of the rack might cause the rack to become unstable or cause the drawer to fall out of the rack.

(R001)

**CAUTION:**

Removing components from the upper positions in the rack cabinet improves rack stability during relocation. Follow these general guidelines whenever you relocate a populated rack cabinet within a room or building:

- Reduce the weight of the rack cabinet by removing equipment starting at the top of the rack cabinet. When possible, restore the rack cabinet to the configuration of the rack cabinet as you received it. If this configuration is not known, you must observe the following precautions:
  - Remove all devices in the 32U position and above.
  - Ensure that the heaviest devices are installed in the bottom of the rack cabinet.
  - Ensure that there are no empty U-levels between devices installed in the rack cabinet below the 32U level.
- If the rack cabinet you are relocating is part of a suite of rack cabinets, detach the rack cabinet from the suite.
- Inspect the route that you plan to take to eliminate potential hazards.
- Verify that the route that you choose can support the weight of the loaded rack cabinet. Refer to the documentation that comes with your rack cabinet for the weight of a loaded rack cabinet.
- Verify that all door openings are at least 760 x 230 mm (30 x 80 in.).
- Ensure that all devices, shelves, drawers, doors, and cables are secure.
- Ensure that the four leveling pads are raised to their highest position.
- Ensure that there is no stabilizer bracket installed on the rack cabinet during movement.
- Do not use a ramp inclined at more than 10 degrees.
- When the rack cabinet is in the new location, complete the following steps:
  - Lower the four leveling pads.
  - Install stabilizer brackets on the rack cabinet.
  - If you removed any devices from the rack cabinet, repopulate the rack cabinet from the lowest position to the highest position.
- If a long-distance relocation is required, restore the rack cabinet to the configuration of the rack cabinet as you received it. Pack the rack cabinet in the original packaging material, or equivalent. Also lower the leveling pads to raise the casters off of the pallet and bolt the rack cabinet to the pallet.

(R002)

(L001)



(L002)

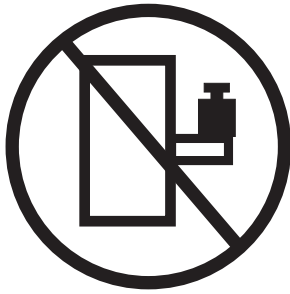

(L003)

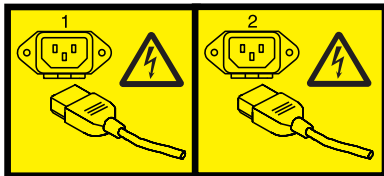

or



All lasers are certified in the U.S. to conform to the requirements of DHHS 21 CFR Subchapter J for class 1 laser products. Outside the U.S., they are certified to be in compliance with IEC 60825 as a class 1 laser product. Consult the label on each part for laser certification numbers and approval information.

**CAUTION:**

This product might contain one or more of the following devices: CD-ROM drive, DVD-ROM drive, DVD-RAM drive, or laser module, which are Class 1 laser products. Note the following information:

- Do not remove the covers. Removing the covers of the laser product could result in exposure to hazardous laser radiation. There are no serviceable parts inside the device.
- Use of the controls or adjustments or performance of procedures other than those specified herein might result in hazardous radiation exposure.

(C026)

**CAUTION:**

Data processing environments can contain equipment transmitting on system links with laser modules that operate at greater than Class 1 power levels. For this reason, never look into the end of an optical fiber cable or open receptacle. (C027)

**CAUTION:**

This product contains a Class 1M laser. Do not view directly with optical instruments. (C028)

**CAUTION:**

Some laser products contain an embedded Class 3A or Class 3B laser diode. Note the following information: laser radiation when open. Do not stare into the beam, do not view directly with optical instruments, and avoid direct exposure to the beam. (C030)

**CAUTION:**

The battery contains lithium. To avoid possible explosion, do not burn or charge the battery.

*Do Not:*

- \_\_\_ Throw or immerse into water
- \_\_\_ Heat to more than 100°C (212°F)
- \_\_\_ Repair or disassemble

Exchange only with the IBM-approved part. Recycle or discard the battery as instructed by local regulations. In the United States, IBM has a process for the collection of this battery. For information, call 1-800-426-4333. Have the IBM part number for the battery unit available when you call. (C003)

## **Power and cabling information for NEBS (Network Equipment-Building System) GR-1089-CORE**

The following comments apply to the IBM servers that have been designated as conforming to NEBS (Network Equipment-Building System) GR-1089-CORE:

The equipment is suitable for installation in the following:

- Network telecommunications facilities
- Locations where the NEC (National Electrical Code) applies

The intrabuilding ports of this equipment are suitable for connection to intrabuilding or unexposed wiring or cabling only. The intrabuilding ports of this equipment *must not* be metallically connected to the interfaces that connect to the OSP (outside plant) or its wiring. These interfaces are designed for use as intrabuilding interfaces only (Type 2 or Type 4 ports as described in GR-1089-CORE) and require isolation from the exposed OSP cabling. The addition of primary protectors is not sufficient protection to connect these interfaces metallically to OSP wiring.

**Note:** All Ethernet cables must be shielded and grounded at both ends.

The ac-powered system does not require the use of an external surge protection device (SPD).

The dc-powered system employs an isolated DC return (DC-I) design. The DC battery return terminal *shall not* be connected to the chassis or frame ground.

---

## Beginning troubleshooting and problem analysis

This information provides a starting point for analyzing problems.

This information is the starting point for diagnosing and repairing servers. From this point, you are guided to the appropriate information to help you diagnose server problems, determine the appropriate repair action, and then perform the necessary steps to repair the server. A system attention light, an enclosure fault light, or a system information light indicates there is a serviceable event (an SRC in the control panel or in one of the serviceable event views) on the system. This information guides you through finding the serviceable event.

---

### Beginning problem analysis

You can use problem analysis to gather information that helps you determine the nature of a problem encountered on your system. This information is used to determine if you can resolve the problem yourself or to gather sufficient information to communicate with a service provider and quickly determine the service action that needs to be taken.

The method of finding and collecting error information depends on the state of the hardware at the time of the failure. This procedure directs you to one of the following places to find error information:

- The management console error logs
- The operating system's error log
- The control panel
- The Integrated Virtualization Manager
- The Advanced System Management Interface (ASMI) error logs
- Light path diagnostics

If you are using this information because of a problem with your Hardware Management Console (HMC), see [Managing the HMC](#) .

If you are using this information because of a problem with your IBM Systems Director Management Console (SDMC), see [Managing the SDMC](#).

To begin analyzing the problem, complete the following steps:

1. Did you observe an activated LED on your system unit or expansion unit? To view an example of the control panel LEDs, see [Control panel LEDs](#).

- **Yes:** Continue with the next step.
  - **No:** Go to step 7 on page 2.
- 

2. Was the activated LED on the system unit?

- **Yes:** Continue with the next step.
  - **No:** The activated LED is on an expansion unit that is connected to the system unit. Go to step 4 on page 2.
- 

3. Is the activated LED the system information indicator (designated by an *i*)?

- **Yes:** Go to step 7 on page 2.
  - **No:** Continue with the next step.
-

4. Is the activated LED the enclosure fault indicator (designated by an !)?

- **Yes:** Use Light Path diagnostics to identify and service the failing part. Continue with the next step.
  - **No:** Go to step 7.
- 

5. The reference code description might provide information or an action that you can take to correct the failure.

Use the information center search function to find the reference code details. The information center search function is located in the upper left corner of this information center. Read the reference code description and return here. Do not take any other action at this time.

Was there a reference code description that enabled you to resolve the problem?

- **Yes: This ends the procedure.**
  - **No:** Continue with the next step.
- 

6. In the serviceable event view of the error, record the part number and location code of the first field-replaceable unit (FRU). Other FRUs might be listed but the first FRU has a high probability of resolving the problem. When you have identified the first FRU in the list, contact your service provider to obtain a replacement part. Do not remove power to the unit until you are ready to exchange the FRU with a replacement FRU.

When you have the replacement part and are ready to exchange it, go to “Replacing FRUs using enclosure fault indicators” on page 26. **This ends the procedure.**

---

7. Are all processor enclosures and I/O enclosures powered on or are you able to power them on?

**Note:** An enclosure is powered on when its green power indicator is on and not flashing.

- **Yes:** Go to step 9 on page 3.
  - **No:** Continue with the next step.
- 

8. Ensure that the power supplied to the system is adequate. If your processor enclosures and I/O enclosures are protected by an emergency power off (EPO) circuit, check that the EPO switch is not activated. Verify that all power cables are correctly connected to the electrical outlet. When power is available, the Function/Data display on the control panel is lit. If you have an uninterruptible power supply, verify that the cables are correctly connected to the system, and that it is functioning. Power on all processor and I/O enclosures.

Did all enclosures power on?

**Note:** An enclosure is powered on when its green power indicator is on and not blinking.

In a single-enclosure server with a redundant service processor, a progress code displays on the control (operator) panel several seconds after ac power is first applied. This progress code remains on the control panel for 1-2 minutes, then the progress code is updated every 20-30 seconds as the system powers on.

In a multiple-enclosure server with a redundant service processor, a progress code does not display on the control (operator) panel until 1-2 minutes after ac power is first applied. After the first progress code displays, the progress code is updated every 20-30 seconds as the system unit powers on.

- **Yes: This ends the procedure.**
  - **No:** Continue with the next step.
- 

9. Is the failing hardware managed by a management console?

- **Yes:** Go to step 18 on page 5.
  - **No:** Continue with the next step.
- 

10. Is your system being managed by the Integrated Virtualization Manager?

- **Yes:** Go to step 22 on page 6.
  - **No:** Continue with the next step. Refer to the appropriate procedure:
    - If you are having a problem with an AIX® or Linux system unit, go to “AIX and Linux problem analysis” on page 8.
    - If you are having a problem with an IBM i system unit, go to “IBM i problem analysis” on page 10.
    - If you are having a problem with an InfiniBand switch, go to “Problem analysis for 7874-024, 7874-040, 7874-120, and 7874-240 switches” on page 14.
- 

11. If an operating system was running at the time of the failure, information about the failure is found in the operating system's serviceable event view unless the failure prevented the operating system from doing so. If that operating system is no longer running, attempt to reboot it before answering the following question.

Was an operating system running at the time of the failure and is the operating system running now?

- **Yes:** Go to step 17 on page 5.
  - **No:** Continue with the next step.
- 

12. Details about errors that occur when an operating system is not running or is now not accessible can be found in the control panel or in the Advanced System Management Interface (ASMI).

Do you choose to look for error details using ASMI?

- **Yes:** Go to step 25 on page 7.
  - **No:** Continue with the next step.
- 

13. At the control panel, complete the following steps.

1. Press the increment or decrement button until the number 11 is displayed in the upper-left corner of the display.
2. Press **Enter** to display the contents of function 11.
3. Look in the upper-right corner for a reference code.

Is there a reference code displayed on the control panel in function 11?

- **Yes:** Continue with the next step.
  - **No:** Contact your hardware service provider.
- 

14. The reference code description might provide information or an action that you can take to correct the failure.

Go to the Reference code finder and type the reference code in the field provided. Read the reference code description and return here. Do not take any other action at this time.

Was there a reference code description that enabled you to resolve the problem?

- **Yes: This ends the procedure.**
  - **No:** Continue with the next step.
- 

15. Service is required to resolve the error. Collect as much error data as possible and record it. You and your service provider will develop a corrective action to resolve the problem based on the following guidelines:

- If a field-replaceable unit (FRU) location code is provided in the serviceable event view or control panel, that location should be used to determine which FRU to replace.
- If an isolation procedure is listed for the reference code in the reference code lookup information, include it as a corrective action even if it is not listed in the serviceable event view or control panel.
- If any FRUs are marked for block replacement, replace all FRUs in the block replacement group at the same time.

To find error details:

1. Press **Enter** to display the contents of function 14. If data is available in function 14, the reference code has a FRU list.
2. Record the information in functions 11 through 20 on the control panel.
3. Contact your service provider and report the reference code and other information.

**This ends the procedure.**

---

16. Is your system being managed by the Integrated Virtualization Manager?

**Note:** If you install the Virtual I/O Server on a system unit that is not managed by a management console, the Integrated Virtualization Manager is enabled.

- **Yes:** Go to step 22 on page 6.
  - **No:** Continue with the next step.
-



17. If you are having a problem with an AIX, Linux, or IBM i system unit, or InfiniBand switch, go to the appropriate procedure.
  - If you are having a problem with an AIX or Linux system unit, go to “AIX and Linux problem analysis” on page 8.
  - If you are having a problem with an IBM i system unit, go to “IBM i problem analysis” on page 10.
  - If you are having a problem with an InfiniBand switch, go to “Problem analysis for 7874-024, 7874-040, 7874-120, and 7874-240 switches” on page 14.

**This ends the procedure.**

---

18. Is the management console functional and connected to the hardware?

- **Yes:** Continue with the next step.
  - **No:** Start the management console and attach it to the system unit. Then return here and continue with the next step.
- 

19. On management console that is used to manage the system unit, complete the following steps:

For HMC:

1. In the navigation area, click **Service Management** → **Manage Events**. The Manage Serviceable Events - Select Serviceable Events window is shown.
2. In the Event Criteria area, for Serviceable Event Status, select **Open**. For all other criteria, select **ALL**, then click **OK**.

**Note:** If you are unable to locate the reported problem, and there is more than one open problem near the time of the reported failure, use the earliest problem in the log.

For SDMC:

1. From the main Service and Support Manager page click **Serviceable Problems** within the **Electronic Services Links** box.  
**Tip:** The Serviceable Problems link displays a filtered list of only those problems associated with systems that are monitored by Service and Support Manager.
2. Click the problem listed in the **Name** column that you want to work with. This step displays the properties of the selected problem.

Scroll through the log and verify that there is a problem with the status of Open to correspond with the failure.

Do you find a serviceable event, or an open problem near the time of the failure?

- **Yes:** Continue with the next step.
  - **No:** Contact your hardware service provider. If you believe that there might be a problem with the InfiniBand switch, go to “Problem analysis for 7874-024, 7874-040, 7874-120, and 7874-240 switches” on page 14.
- 

20. The reference code description might provide information or an action that you can take to correct the failure.

Go to the Reference code finder and type the reference code in the field provided. Read the reference code description and return here. Do not take any other action at this time.

Was there a reference code description that enabled you to resolve the problem?

- **Yes: This ends the procedure.**
  - **No:** Continue with the next step.
- 

21. Service is required to resolve the error. Collect as much error data as possible and record it. You and your service provider will develop a corrective action to resolve the problem based on the following guidelines:

- If a FRU location code is provided in the serviceable event view or control panel, that location should be used to determine which FRU to replace.
- If an isolation procedure is listed for the reference code in the reference code lookup information, include it as a corrective action even if it is not listed in the serviceable event view or control panel.
- If any FRUs are marked for block replacement, replace all FRUs in the block replacement group at the same time.

From the Repair Serviceable Event window, complete the following steps:

1. Record the problem management record (PMR) number for the problem if one is listed.
2. Select the serviceable event from the list.
3. Select Selected and View Details.
4. Record the reference code and FRU list found in the Serviceable Event Details.
5. If a PMH number was found for the problem on the Serviceable Event Overview panel, the problem has already been reported. If there was no PMH number for the problem, contact your service provider.

**This ends the procedure.**

---

22. Logon to the Integrated Virtualization Manager interface if not already logged on.

- In the Integrated Virtualization Manager Navigation bar, select **Manage Serviceable Events** (under Service Management).
- Scroll through the log and verify that there is a problem with the status of Open to correspond with the failure.

Do you find a serviceable event, or an open problem near the time of the failure?

- **Yes:** Continue with the next step.
  - **No:** Go to step 17 on page 5.
- 

23. The reference code description might provide information or an action that you can take to correct the failure.

Go to the Reference code finder and type the reference code in the field provided. Read the reference code description and return here. Do not take any other action at this time.

Was there a reference code description that enabled you to resolve the problem?

- **Yes: This ends the procedure.**
  - **No:** Continue with the next step.
- 

24. Service is required to resolve the error. Collect as much error data as possible and record it. You and your service provider will develop a corrective action to resolve the problem based on the following guidelines:

- If a FRU location code is provided in the serviceable event view or control panel, that location should be used to determine which FRU to replace.
- If an isolation procedure is listed for the reference code in the reference code lookup information, it should be included as a corrective action even if it is not listed in the serviceable event view or control panel.
- If any FRUs are marked for block replacement, all FRUs in the block replacement group should be replaced at the same time.

From the Selected Serviceable Events table, complete the following steps.

- Record the reference code.
- Select the serviceable event.
- Select View Associated FRUs.
- Contact your service provider

**This ends the procedure.**

---

25. On the console connected to the ASMI, complete the following steps .

1. Log in with a user ID that has general, administrator, or authorized service provider authority level.
2. In the navigation area, expand System Service Aids and click Error/Event Logs. If log entries exist, a list of error and event log entries is displayed in a summary view.
3. Scroll through the log under Serviceable Customer Attention Events and verify that there is a problem to correspond with the failure.

**Note:** If you are unable to locate the reported problem, and there is more than one open problem near the time of the reported failure, use the earliest problem in the log.

For more detailed information on the ASMI, see Managing the Advanced System Management Interface

Do you find a serviceable event, or an open problem near the time of the failure?

- **Yes:** Continue with the next step.
  - **No:** Contact your hardware service provider.
- 

26. The reference code description might provide information or an action that you can take to correct the failure.

Go to the Reference code finder and type the reference code in the field provided. Read the reference code description and return here. Do not take any other action at this time.

Was there a reference code description that enabled you to resolve the problem?

- **Yes: This ends the procedure.**
  - **No:** Continue with the next step.
- 

27. Service is required to resolve the error. Collect as much error data as possible and record it. You and your service provider will develop a corrective action to resolve the problem based on the following guidelines:

- If a FRU location code is provided in the serviceable event view or control panel, that location should be used to determine which FRU to replace.
- If an isolation procedure is listed for the reference code in the reference code lookup information, include it as a corrective action even if it is not listed in the serviceable event view or control panel.
- If any FRUs are marked for block replacement, replace all FRUs in the block replacement group at the same time.

From the Error Event Log view, complete the following steps:

1. Record the reference code.
2. Select the corresponding check box on the log and click **Show details**.
3. Record the error details.
4. Contact your service provider.

**This ends the procedure.**

---

## AIX and Linux problem analysis

You can use this procedure to find information about a problem with your server hardware that is running the AIX or Linux operating system.

1. Is the operating system operational?

- **Yes:** Continue with the next step.
  - **No:** Go to step 4 of the *Beginning problem analysis* topic to diagnose the problem.
- 

2. Are any messages (for example, a device is not available or reporting errors) related to this problem displayed on the system console or sent to you in e-mail that provides a reference code?

**Note:** A reference code can be an 8 character system reference code (SRC) or an service request number (SRN) of 5, 6, or 7 characters, with or without a hyphen.

- **Yes:** Continue with the next step.
  - **No:** Go to step 4.
- 

3. The reference code description might provide information or an action that you can take to correct the failure.

Go to the Reference code finder and type the reference code in the field provided. Read the reference code description and return here. Do not take any other action at this time.

Was there a reference code description that enabled you to resolve the problem?

- **Yes: This ends the procedure.**
  - **No:** Continue with the next step.
- 

4. Are you running Linux?

- **Yes:** Continue with the next step.
  - **No:** Go to step 6 on page 9.
- 

5. To locate the error information in a system or logical partition running the Linux operating system, complete these steps:

**Note:** Before proceeding with this step, verify if IBM Installation Toolkit (IBMIT) is installed in the system. For instructions to install IBMIT, go to IBM Installation Toolkit.

1. Log in as root user.
2. At the command line, type `grep diagela /var/log/platform` and press **Enter**.
3. Look for the most recent entry that contains a reference code.

Continue with step 8.

---

6. To locate the error information in a system or logical partition running AIX, complete these steps:

1. Log in to the AIX operating system as root user, or use CE login. If you need help, contact the system administrator.
2. Type `diag` to load the diagnostic controller, and display the online diagnostic menus.
3. From the Function selection menu, select **Task selection**.
4. From the Task selection list menu, select **Display previous diagnostic results**.
5. From the Previous diagnostic results menu, select **Display diagnostic log summary**.

Continue with the next step.

---

7. A display diagnostic log is shown with a time ordered table of events from the error log.

Look in the T column for the most recent entry that has an S entry. Press **Enter** to select the row in the table and then select **Commit**.

The details of this entry from the table are shown; look for the SRN entry near the end of the entry and record the information shown.

Continue with the next step.

---

8. Do you find a serviceable event or an open problem near the time of the failure?

- **Yes:** Continue with the next step.
  - **No:** Contact your hardware service provider.
- 

9. The reference code description might provide information or an action that you can take to correct the failure.

Go to the Reference code finder and type the reference code in the field provided. Read the reference code description and return here. Do not take any other action at this time.

Was there a reference code description that enabled you to resolve the problem?

- **Yes: This ends the procedure.**
  - **No:** Continue with the next step.
- 

10. Service is required to resolve the error. Collect as much error data as possible and record it. You and your service provider will develop a corrective action to resolve the problem based on the following guidelines:

- If a field-replaceable unit (FRU) location code is provided in the serviceable event view or control panel, that location should be used to determine which FRU to replace.
- If an isolation procedure is listed for the reference code in the reference code lookup information, include it as a corrective action even if it is not listed in the serviceable event view or control panel.
- If any FRUs are marked for block replacement, replace all FRUs in the block replacement group at the same time.

From the Error Event Log view, complete the following steps:

1. Record the reference code.
2. Record the error details.
3. Contact your service provider.

**This ends the procedure.**

## IBM i problem analysis

You can use this procedure to find information about a problem with your server hardware that is running the IBM i operating system.

If you experience a problem with your system or logical partition, attempt to gather more information about the problem to either solve it, or to help your next level of support or your hardware service provider to solve it more quickly and accurately.

This procedure refers to the IBM i control language (CL) commands that provide a flexible means of entering commands on the IBM i logical partition or system. You can use CL commands to control most of the IBM i functions by entering them from either the character-based interface or System i<sup>®</sup> Navigator. While the CL commands might be unfamiliar at first, they follow a consistent syntax, and IBM i includes many features to help you use them successfully. The Programming navigation category in the IBM i Information Center includes a complete CL reference and a CL Finder to look up specific CL commands.

### Keep the following in mind while troubleshooting problems:

- Has an external power outage or momentary power loss occurred?
- Has the hardware configuration changed?
- Has system software been added?
- Have any new programs or program updates (including PTFs) been installed recently?

To make sure that your IBM software has been correctly installed, use the Check Product Option (CHKPRDOPT) command.

- Have any system values changed?
- Has any system tuning been done?

After reviewing these considerations, follow these steps:

1. Is the IBM i operating system up and running?

- **Yes:** Continue with the next step.
  - **No:** Go to step 4 of the *Beginning problem analysis* topic to diagnose the problem.
- 

2. If you have a management console, ensure you performed the steps in “Beginning problem analysis” on page 1, and then return here if you are directed to do so.

#### Note:

- For details on accessing a 5250 console session on the HMC, see *Managing the HMC 5250 console*.
-

3. Are you troubleshooting a problem related to the System i integration with BladeCenter® and System x® within an internet small computer system interface (iSCSI) environment?

- **Yes:** Refer to the IBM i integration with BladeCenter and System x Web site.
  - **No:** Continue with the next step.
- 

4. Are you experiencing problems with the Operations Console?

- **Yes:** See Troubleshooting Operations Console connections.
  - **No:** Continue with the next step.
- 

5. The reference code description might provide information or an action that you can take to correct the failure.

Go to the Reference code finder and type the reference code in the field provided. Read the reference code description and return here. Do not take any other action at this time.

Was there a reference code description that enabled you to resolve the problem?

- **Yes: This ends the procedure.**
  - **No:** Continue with the next step.
- 

6. Does the console show a Main Storage Dump Manager display?

- **Yes:** Go to Copying a dump .
  - **No:** Continue with the next step.
- 

7. Is the console that was in use when the problem occurred (or any console) operational?

**Note:** The console is operational if a sign-on display or a command line is present. If another console is operational, use it to resolve the problem.

- **Yes:** Continue with the next step.
  - **No:** Choose from the following options:
    - If your console does not show a sign-on display or a menu with a command line, go to Recovering when the console does not show a sign-on display or a menu with a command line.
    - For all other workstations, see the Troubleshooting navigation category in the IBM i Information Center.
- 

8. Is a message related to this problem shown on the console?

- **Yes:** Continue with the next step.
  - **No:** Go to step 13 on page 12.
- 

9. Is this a system operator message?

**Note:** It is a system operator message if the display indicates that the message is in the QSYSOPR message queue. Critical messages can be found in the QSYSMSG message queue. For more information, see the Create message queue QSYSMSG for severe messages topic in the Troubleshooting navigation category of the IBM i Information Center.

- **Yes:** Continue with the next step.
  - **No:** Go to step 11 on page 12.
-

10. Is the system operator message highlighted, or does it have an asterisk (\*) next to it?

- **Yes:** Go to step 20 on page 13.
  - **No:** Go to step 15.
- 

11. Move the cursor to the message line and press F1 (Help). Does the Additional Message Information display appear?

- **Yes:** Continue with the next step.
  - **No:** Go to step 13.
- 

12. Record the additional message information on the appropriate problem reporting form. For details, see "Problem reporting form" on page 28.

Follow the recovery instructions on the Additional Message Information display.

Did this solve the problem?

- **Yes: This ends the procedure.**
  - **No:** Continue with the next step.
- 

13. To display system operator messages, type `dspmsg qsysopr` on any command line and then press **Enter**.

Did you find a message that is highlighted or has an asterisk (\*) next to it?

- **Yes:** Go to step 20 on page 13.
- **No:** Continue with the next step.

**Note:** The message monitor in System i Navigator can also inform you when a problem has developed. For details, see the Scenario: Message monitor topic in the Systems Management navigation category of the IBM i Information Center.

---

14. Did you find a message with a date or time that is at or near the time the problem occurred?

**Note:** Move the cursor to the message line and press F1 (Help) to determine the time a message occurred. If the problem is shown to affect only one console, you might be able to use information from the JOB menu to diagnose and solve the problem. To find this menu, type **GO JOB** and press **Enter** on any command line.

- **Yes:** Continue with the next step.
  - **No:** Go to step 17 on page 13.
- 

15. Perform the following steps:

1. Move the cursor to the message line and press F1 (Help) to display additional information about the message.
2. Record the additional message information on the appropriate problem reporting form. For details, see "Problem reporting form" on page 28.
3. Follow any recovery instructions that are shown.

Did this solve the problem?



- **Yes: This ends the procedure.**
  - **No:** Continue with the next step.
- 

16. Did the message information indicate to look for additional messages in the system operator message queue (QSYSOPR)?

- **Yes:** Press F12 (Cancel) to return to the list of messages and look for other related messages. Then return to step 13 on page 12.
  - **No:** Continue with the next step.
- 

17. Do you know which input/output device is causing the problem?

- **Yes:** Continue with step 19.
  - **No:** Continue with the next step.
- 

18. If you do not know which input/output device is causing the problem, describe the problems that you have observed by performing the following steps:

1. Type GO USERHELP on any command line and then press **Enter**.
  2. Select option 10 (Save information to help resolve a problem).
  3. Type a brief description of the problem and then press **Enter**. If you specify the default **Y** in the **Enter notes about problem** field, you can enter more text to describe your problem.
  4. Report the problem to your hardware service provider.
- 

19. Perform the following steps:

1. Type ANZPRB on the command line and then press **Enter**. For details, see Using the Analyze Problem (ANZPRB) command in the Troubleshooting navigation category in the IBM i Information Center.
2. Contact your next level of support. **This ends the procedure.**

**Note:** To describe your problem in greater detail, see Using the Analyze Problem (ANZPRB) command in the Troubleshooting navigation category in the IBM i Information Center. This command also can run a test to further isolate the problem.

---

20. Perform the following steps:

1. Move the cursor to the message line and press F1 (Help) to display additional information about the message.
  2. Press F14, or use the Work with Problem (WRKPRB) command. For details, see Using the Work with Problems (WRKPRB) command in the Troubleshooting navigation category in the IBM i Information Center.
  3. If this does not solve the problem, see the Symptom and recovery actions.
- 

21. Choose from the following options:

- If there are reference codes appearing on the control panel or the management console, record them. Then go to the Reference codes to see if there are additional details available for the code you received.
- If there are no reference codes appearing on the control panel or the management console, there should be a serviceable event indicated by a message in the problem log. Use the WRKPRB command. For details, see Using the Work with Problems (WRKPRB) command.

## Problem analysis for 7874-024, 7874-040, 7874-120, and 7874-240 switches

You can use problem analysis to gather information that helps you determine the nature of a problem encountered on your system.

Use the following table to begin problem analysis and to start service.

In the following table, find the first failure indication that you observed, and then follow the action specified in the right column. After you have completed the actions in that row, that problem should be repaired. If not, continue with the next failure indication.

*Table 1. Switch failure analysis and action*

Failure indication	Description and action
1. Serviceable event on the management console.	<p><b>Description:</b> A hardware system unit, I/O drawer, or frame power problem requires parts or service procedures to correct the failure.</p> <p><b>Action:</b> Follow normal service procedures for the failed part. Depending on effects of the serviceable event, this might also fix problems on the InfiniBand switch fabric.</p>
2. InfiniBand switch light emitting diodes (LEDs) are all off	<p><b>Description:</b> There is no power to the switch, or there is a power supply failure, or a fan failure.</p> <p><b>Action:</b></p> <ol style="list-style-type: none"> <li>1. Check the power cables at the switch, and determine if the power is active. If you find a problem, replace the power cable or work with the customer to fix the power problem.</li> <li>2. If there is no problem with input power, the problem is the switch. Replace the power supplies one at a time until the problem is fixed.</li> </ol>

Table 1. Switch failure analysis and action (continued)

Failure indication	Description and action
<p>3. InfiniBand switch has a red LED that is lit. Some examples are the following items:</p> <ul style="list-style-type: none"> <li>• Chassis Status LED on managed spine</li> <li>• Status LED on leaf module</li> <li>• Red LED on power or fan module</li> </ul>	<p><b>Description:</b> The red LED indicates a hardware failure.</p> <p>A red chassis LED indicates one of the following conditions:</p> <ul style="list-style-type: none"> <li>• The system ambient temperature exceeds 60 degree C.</li> <li>• No functional fan trays are present.</li> <li>• No functional spines are present.</li> <li>• No functional leaves are present.</li> </ul> <p><b>Action:</b></p> <ul style="list-style-type: none"> <li>• If the red LED is on a managed spine or leaf module:               <ol style="list-style-type: none"> <li>1. Reseat this managed spine or leaf module.</li> <li>2. If the LED is still red, insert this managed spine or leaf module into another slot.</li> <li>3. If the LED is still red, replace this managed spine or leaf module.</li> </ol> </li> <li>• If the red LED is on a power supply or fan module, replace the power or fan module.</li> </ul>
<p>4. InfiniBand switch has an amber Attention LED that is lit. Some examples are the following items:</p> <ul style="list-style-type: none"> <li>• Attention LED on managed spine</li> <li>• Attention LED on leaf module</li> </ul>	<p><b>Description:</b> An amber Attention LED indicates a possible hardware failure. Data needs to be collected for analysis.</p> <p>An amber chassis LED indicates one of the following conditions:</p> <ul style="list-style-type: none"> <li>• The system ambient temperature exceeds 52 degrees C, but is less than 60 degrees C.</li> <li>• There is a fan problem.</li> <li>• A power supply AC OK LED is off.</li> <li>• A power supply DC OK LED is off.</li> <li>• Any spine module Attention LED is on, or any spine is not functioning (even if unable to light the LED).</li> <li>• Any leaf module Attention LED is on, or any leaf is not functioning (even if unable to light the LED).</li> </ul> <p><b>Action:</b> Collect data. Go to “Collecting data for InfiniBand switch errors for 7874-024, 7874-040, 7874-120, and 7874-240 switches” on page 19 and perform that procedure.</p>

Table 1. Switch failure analysis and action (continued)

Failure indication	Description and action
<p>5. InfiniBand switch port link has a blue LED that is not lit.</p>	<p><b>Description:</b> A blue link LED on the switch indicates a good physical connection between the switch port and the device at the other end of the cable. If the LED is not lit, there is a problem with the port, the cable, or the InfiniBand host channel adapter.</p> <p><b>Action:</b></p> <ul style="list-style-type: none"> <li>• Go to “Isolating InfiniBand switch link errors for 7874-024, 7874-040, 7874-120, and 7874-240 switches” on page 18 for problem determination.</li> <li>• When the blue link LED is lit at the switch, the link is physically connected; however, also check the reliability of the link.</li> </ul> <p>When the blue link LED is lit at the switch port, the link is physically connected; however, the link might still be experiencing intermittent errors. The customer can monitor and check for intermittent errors on the link. In most cases, intermittent errors result from a bad cable or connection.</p>
<p>6. One of the following logs indicate a loss of InfiniBand switch communication with a server or logical partition:</p> <ul style="list-style-type: none"> <li>• Subnet manager log from fabric management server (or from InfiniBand switch)</li> <li>• Switch log (switch chassis)</li> <li>• Fast Fabric Health Check result from fabric management server</li> <li>• Fast Fabric Report from fabric management server (<i>Iba_report</i>)</li> </ul>	<p><b>Description:</b> The loss of InfiniBand switch connections can result from different failures, including server, logical partition, host channel adapter, cable, InfiniBand switch failures, partitioning configuration errors, or operating system configuration problems.</p> <p><b>Isolation:</b></p> <ol style="list-style-type: none"> <li>1. Collect data. Go to “Collecting data for InfiniBand switch errors for 7874-024, 7874-040, 7874-120, and 7874-240 switches” on page 19 and perform that procedure.</li> <li>2. If multiple link errors are reported, look for patterns to the failures that might help to isolate the failing part, such as the following situations:             <ol style="list-style-type: none"> <li>a. All links are connected to a single server.</li> <li>b. All links are connected to a single logical partition.</li> <li>c. All links are connected to a single host channel adapter (that is, InfiniBand host channel adapter).</li> <li>d. All links are connected to a single InfiniBand switch.</li> <li>e. All links are connected to a single InfiniBand switch leaf.</li> </ol> </li> </ol> <p><b>Note:</b> If the InfiniBand switch fabric has more than one independent failure, you might treat them separately.</p>

Table 1. Switch failure analysis and action (continued)

Failure indication	Description and action
<p>7. Logs indicate loss of InfiniBand switch communication with a server or logical partition (continued)</p>	<p><b>Action:</b></p> <ol style="list-style-type: none"> <li>1. If all links connected to a single server or logical partition are not functioning, complete the following steps:               <ol style="list-style-type: none"> <li>a. Check for obvious down or hung conditions on the server or logical partition. If found, the customer should recover the server or the logical partition, or contact IBM service representative, as necessary. The IBM service representative will then use normal server procedures to fix the problem.</li> <li>b. Have the customer check for an InfiniBand switch adapter configuration problem. This could be a host-channel-adapter partitioning problem or an InfiniBand switch interface error in the operating system. If found, the customer corrects the problem.</li> <li>c. If the links are from a single host channel adapter, skip to step 4.</li> </ol> </li> <li>2. If all links connected to a single InfiniBand switch are down, complete the following steps:               <ol style="list-style-type: none"> <li>a. Check for a switch power problem and fix, as necessary.</li> <li>b. If no power problem is found, collect data as indicated under Isolation and send the data to IBM for analysis.</li> </ol> </li> <li>3. If all links that are connected to a single InfiniBand switch leaf are down, replace the switch leaf.</li> <li>4. If all links are connected to a single host channel adapter are down, complete the following steps:               <ol style="list-style-type: none"> <li>a. Have the customer check for an InfiniBand host channel adapter configuration problem. This problem could be a host-channel-adapter partitioning problem or an InfiniBand switch-interface error in the operating system. If found, the customer must correct the problem.</li> <li>b. If no other problems are found, replace the host channel adapter.</li> </ol> </li> <li>5. If no other problems are found with the server or the logical partition, then the problem might be isolated to InfiniBand switch links. Go to “Isolating InfiniBand switch link errors for 7874-024, 7874-040, 7874-120, and 7874-240 switches” on page 18 to continue problem determination.</li> </ol>

Table 1. Switch failure analysis and action (continued)

Failure indication	Description and action
<p>8. Subnet manager log</p> <ul style="list-style-type: none"> <li>• If using host-based subnet manager, the subnet manager log is found on the fabric management server under <code>/var/log/messages</code>.</li> <li>• If using the embedded subnet manager, the subnet manager log is found on the switch.</li> </ul>	<p>The subnet manager monitors the fabric and manages recovery operations.</p> <p>Errors should also be logged on the cluster systems management (CSM) server under <code>/var/log/csm/errorlog/CSM MS hostname</code>.</p> <p><b>Action:</b> Go to “Collecting data from the fabric management server for 7874-024, 7874-040, 7874-120, and 7874-240 switches” on page 23 and perform that procedure.</p>
<p>9. Switch log</p> <p>Some examples are the following items:</p> <ul style="list-style-type: none"> <li>• Switch (through logShow)</li> <li>• Also errors on CSM server in file <code>/var/log/csm/errorlog/CSM MS hostname</code></li> </ul>	<p>The switch log reflects problems within the switch chassis.</p> <p><b>Action:</b></p> <ol style="list-style-type: none"> <li>1. Go to “Collecting data from the fabric management server for 7874-024, 7874-040, 7874-120, and 7874-240 switches” on page 23 and perform that procedure.</li> <li>2. Go to “Capturing switch CLI output using a script command for 7874-024, 7874-040, 7874-120, and 7874-240 switches” on page 24 and perform that procedure.</li> </ol>
<p>10. Fast fabric health check result</p> <p>Some examples are the following items:</p> <ul style="list-style-type: none"> <li>• Fabric management server in files: <ul style="list-style-type: none"> <li>– <code>/var/opt/iba/analysis/latest/chassis*.diff</code></li> <li>– <code>/var/opt/iba/analysis/latest/chassis*.errors</code></li> </ul> </li> </ul>	<p>The Fast Fabric Health Check is used during install, repair, and monitoring of the fabric to find errors and configuration changes that might cause problems in the fabric.</p> <p><b>Action:</b> Go to “Collecting data for Fast Fabric Health Check for 7874-024, 7874-040, 7874-120, and 7874-240 switches” on page 23 and perform that procedure.</p>
<p>11. Fast Fabric Report</p> <p>Some examples are the following items:</p> <ul style="list-style-type: none"> <li>• Fabric management server in file <code>/var/opt/iba/analysis/latest/*.stderr</code></li> </ul>	<p>See the Fast Fabric Report</p> <p><b>Action:</b></p> <ol style="list-style-type: none"> <li>1. Collect all health check history data. Go to “Collecting data for Fast Fabric Health Check for 7874-024, 7874-040, 7874-120, and 7874-240 switches” on page 23 and perform that procedure.</li> <li>2. From the fabric management server, collect that data from the file <code>/var/log/messages</code>.</li> </ol>
<p>12. Other error indicators or reporting methods</p>	<p>This problem includes other ways that you might hear about an error, such as a user complaint. Review this table for other failure indications.</p>

For more information about cluster fabric that incorporates InfiniBand switches, see the *IBM System p<sup>®</sup> HPC Clusters Fabric Guide* at the IBM clusters with the InfiniBand switch Web site.

### Isolating InfiniBand switch link errors for 7874-024, 7874-040, 7874-120, and 7874-240 switches

You can isolate switch link errors with this procedure.

Ensure that you have eliminated the failures in Table 1 on page 14.

To fix symptoms, such as the blue link LED is not lit, permanent link errors are reported in error logs, or intermittent link errors are reported in errors logs, perform the following steps until the original symptom is resolved.

1. Reseat the switch cable at the switch end.
2. At the node end, check that the InfiniBand™ host channel adapter is shown as active (some adapter LEDs) and reseat the cable.
  - a. If the node is down, fix that problem. If only this adapter is down, it might be guarded or broken.
  - b. Fix any problems, and then recheck for the original symptom.
3. For isolation, replace the InfiniBand cable, and then recheck for the original symptom.
4. If possible, identify another switch port that is functional and connect this node port to it (it must be on the same subnet, preferably an unused port). Then, disconnect the InfiniBand cable at the switch end and plug the cable into the other port.
  - a. If the link works with the new port, then the original switch port is bad, and the switch leaf must be replaced.
  - b. If link still does not work, then the port on the InfiniBand adapter is bad, and the adapter must be replaced.

After the original symptom is fixed, check or monitor for other link errors.

### Collecting data for InfiniBand switch errors for 7874-024, 7874-040, 7874-120, and 7874-240 switches

For InfiniBand™ host channel adapter, switch, or management errors, you need to determine what data to collect.

Because of the complexity of the hardware and software configurations, determine which case most closely matches your situation. If you cannot determine which scenario applies to your situation, contact your IBM service representative.

Table 2. Failure scenarios and data collection

Failure scenario	Location of data and data to collect
Scenario A: Switch LED or stopped fan indicates the problem	<p><b>Where to look:</b></p> <ul style="list-style-type: none"> <li>• Physical InfiniBand switch LEDs or fan</li> <li>• Fabric management server graphical interface</li> </ul> <p><b>Data to collect and record:</b></p> <ol style="list-style-type: none"> <li>1. Record the status and the location of the problem.</li> <li>2. Go to “Collecting data from the fabric management server for 7874-024, 7874-040, 7874-120, and 7874-240 switches” on page 23, and perform that procedure.</li> </ol>
Scenario B: Subnet manager log message indicates the problem	<p><b>Where to look:</b></p> <ul style="list-style-type: none"> <li>• Fabric management server, file <code>/var/log/messages</code></li> <li>• Cluster systems management (CSM) server, file <code>/var/log/csm/errorlog/CSM MS hostname</code></li> </ul> <p><b>Data to collect and record:</b></p> <ol style="list-style-type: none"> <li>1. Go to “Collecting data from the fabric management server for 7874-024, 7874-040, 7874-120, and 7874-240 switches” on page 23, and perform that procedure.</li> </ol>

Table 2. Failure scenarios and data collection (continued)

Failure scenario	Location of data and data to collect
Scenario C: Switch log message indicates the problem	<p><b>Where to look:</b></p> <ul style="list-style-type: none"> <li>• On switch (through logShow)</li> <li>• CSM server, file <code>/var/log/csm/errorlog/CSM MS hostname</code></li> </ul> <p><b>Data to collect and record:</b></p> <ol style="list-style-type: none"> <li>1. Go to “Collecting data from the fabric management server for 7874-024, 7874-040, 7874-120, and 7874-240 switches” on page 23, and perform that procedure.</li> <li>2. If directed to collect switch log data, go to “Capturing switch CLI output using a script command for 7874-024, 7874-040, 7874-120, and 7874-240 switches” on page 24, and perform that procedure.</li> </ol>
Scenario D: Fast fabric health check indicates the problem	<p><b>Where to look:</b></p> <ul style="list-style-type: none"> <li>• Fabric management server <ul style="list-style-type: none"> <li>– file <code>/var/opt/iba/analysis/latest/chassis*.diff</code></li> <li>– file <code>/var/opt/iba/analysis/latest/chassis*.errors</code></li> <li>– file <code>/var/opt/iba/analysis/latest/fabric*.errors</code></li> </ul> </li> </ul> <p><b>Data to collect and record:</b></p> <ol style="list-style-type: none"> <li>1. Go to “Collecting data for Fast Fabric Health Check for 7874-024, 7874-040, 7874-120, and 7874-240 switches” on page 23, and perform that procedure.</li> </ol>
Scenario E: One or more switches is missing from the configuration	<p><b>Where to look:</b></p> <ul style="list-style-type: none"> <li>• Fabric management server, file <code>/var/log/messages</code></li> <li>• CSM server, file <code>/var/log/csm/errorlog/CSM/MS hostname</code></li> <li>• Fast fabric, dir <code>/var/opt/iba/analysis/latest</code> files: <code>hostsm*.diff</code>, <code>hostsm*.errors</code>, <code>esm*.diff</code>, <code>hostsm*.errors</code></li> </ul> <p><b>Data to collect and record:</b></p> <ol style="list-style-type: none"> <li>1. Go to “Collecting data from the fabric management server for 7874-024, 7874-040, 7874-120, and 7874-240 switches” on page 23, and perform that procedure.</li> <li>2. Go to “Collecting data for Fast Fabric Health Check for 7874-024, 7874-040, 7874-120, and 7874-240 switches” on page 23, and perform that procedure.</li> </ol>
Scenario F: Fast fabric health check tool problems	<p><b>Where to look:</b></p> <ul style="list-style-type: none"> <li>• Fast fabric, file <code>/var/opt/iba/analysis/latest/*.stderr</code></li> </ul> <p><b>Data to collect and record:</b></p> <ol style="list-style-type: none"> <li>1. Collect all health check history data. Go to “Collecting data for Fast Fabric Health Check for 7874-024, 7874-040, 7874-120, and 7874-240 switches” on page 23, and perform that procedure.</li> <li>2. From the Fabric management server, collect the data from the file <code>/var/log/messages</code>.</li> </ol>



Table 2. Failure scenarios and data collection (continued)

Failure scenario	Location of data and data to collect
Scenario G: Host channel adapter hardware failure	<p><b>Where to look:</b></p> <ul style="list-style-type: none"> <li>• Host channel adapter LED status</li> <li>• Service focal point serviceable event that calls the host channel adapter.</li> </ul> <p><b>Data to collect and record:</b></p> <ol style="list-style-type: none"> <li>1. Perform normal data collection of an iqqylog and a dump (if applicable) from the management console.</li> <li>2. If LEDs indicate link problem, go to “Collecting data from the fabric management server for 7874-024, 7874-040, 7874-120, and 7874-240 switches” on page 23, and perform that procedure.</li> </ol>

Table 2. Failure scenarios and data collection (continued)

Failure scenario	Location of data and data to collect
Scenario H: Host channel adapter cannot ping	<p><b>Where to look:</b></p> <ul style="list-style-type: none"> <li>• Users cannot ping this host channel adapter.</li> </ul> <p><b>Data to collect and record:</b></p> <ol style="list-style-type: none"> <li>1. Go to “Collecting data from the fabric management server for 7874-024, 7874-040, 7874-120, and 7874-240 switches” on page 23, and perform that procedure.</li> <li>2. If collecting data from the cluster systems management (CSM) server, perform the following steps:               <ol style="list-style-type: none"> <li>a. On the CSM server, make a data collection directory. In this directory, you will be storing node data to a file with the name of <code>ibdata.customer.timestamp</code>. Where you see <i>file</i> in the following substeps, use that directory and file name, for example, <code>dir/ibdata.IBM.20080508-1034</code>.</li> <li>b. <code>dsh -av "netstat -i   grep ib" &gt; file.netstat</code></li> <li>c. For AIX nodes:                   <ul style="list-style-type: none"> <li>• <code>dsh -av "ibstat -n" &gt; file.ibstat</code></li> <li>• <code>dsh -av "lscfg -vp" &gt; file.lscfg</code></li> </ul> </li> <li>d. For Linux nodes:                   <ul style="list-style-type: none"> <li>• <code>dsh -av "ibv_devinfo -v" &gt; file.devinfo</code></li> <li>• <code>dsh -av "lspci" &gt; file.lspci</code></li> </ul> </li> </ol> </li> <li>3. If collecting data from the node directly, perform the following steps:               <ol style="list-style-type: none"> <li>a. On the node, create a data collection directory. In this directory you will be storing the node data to a file with name of <code>ibdata.customer.timestamp</code>. Where you see <i>file</i> in the following substeps, use that directory and file name, for example, <code>dir/ibdata.IBM.20080508-1034</code>.</li> <li>b. <code>netstat -i   grep ib &gt; file.netstat</code></li> <li>c. For AIX nodes:                   <ul style="list-style-type: none"> <li>• <code>ibstat -n &gt; file.ibstat</code></li> <li>• <code>lscfg -vp &gt; file.lscfg</code></li> </ul> </li> <li>d. For Linux nodes:                   <ul style="list-style-type: none"> <li>• <code>ibv_devinfo -v &gt; file.devinfo</code></li> <li>• <code>lspci &gt; file.lspci</code></li> </ul> </li> <li>e. Send all files from that directory to your IBM service representative.</li> </ol> </li> </ol>
Scenario I: General debug with no specific problem	<p><b>Where to look:</b> No specific symptom</p> <p><b>Data to collect and record:</b> Collect the same data as for scenario H.</p>

**Collecting data from the cluster systems management server for 7874-024, 7874-040, 7874-120, and 7874-240 switches:**

You can use the cluster systems management (CSM) server to collect data that helps you analyze switch problems.

- Ensure that the secure shell (ssh) has been set up without a password between all of the fabric management servers.
- Various hosts and chassis files should already be configured to help target subsets of fabric management servers or switches if you do not want to query all of them.

By default, results go into the `./uploads` directory, which is under the current working directory. For remote processing, this is the root directory for the user (usually `/`). This could take the form of `/uploads`, or `/home/root/uploads`, depending on user setup of the fabric management server. This directory is referred to as `captureall_dir`.

To collect data using the CSM server, perform the following steps:

1. Log on to the CSM server.
2. Get data from the fabric management server by using the following command: `dsh -d [Primary fabric management server] captureall`
3. Get data from InfiniBand switches by using the following command `dsh -d Primary fabric management server captureall - C`
4. Copy data from the primary data collection fabric management server to the CSM server:
  - a. Create a directory on the CSM server to store data. This is also used for IBM system data. For the remainder of this procedure, this directory is referred to as `captureDir_on_CSM`.
  - b. Run the command `dcp -d Primary Fabric MSuploads/. captureDir_on_CSM`.
5. Get host channel adapter information from the IBM system:
  - a. For AIX, run the command `lsdev -c snap -gc`.
  - b. For Linux, get the output of `ibv_devices`, the output of `ibv_devinfo -v`, and a copy of `/var/log/messages`.

#### **Collecting data from the fabric management server for 7874-024, 7874-040, 7874-120, and 7874-240 switches:**

You can use the fabric management server to collect data that helps you analyze switch problems.

- The `/etc/sysconfig/iba/hosts` path must point to all fabric management servers.
- Various hosts and chassis files should already be configured, which can help target subsets of fabric management servers or switches. For host files, use "f", and for chassis files, use "F".

By default, data is captured to files in the `./uploads` directory, which is under the current directory when you run the command.

To collect data using the fabric management server, perform the following steps:

1. Log on to the fabric management server.
2. Create a directory to store data (referred to hereafter as *dir*).
3. Change the directory by using the command: `cd dir`
4. Get data from fabric management servers by using the command `captureall`.
5. Get data from the switches, by using the command `captureall -C`. Data is in `dir/uploads`. Files are `chassiscapture.all.tgz` and `hostcapture.all.tgz`.
6. Send files to the appropriate support team.

#### **Collecting data for Fast Fabric Health Check for 7874-024, 7874-040, 7874-120, and 7874-240 switches:**

You can use the Fast Fabric Health Check to collect data that helps you analyze switch problems.

To collect data using the Fast Fabric Health Check, perform the following steps:

1. Log on to fabric management server.

2. If instructed to gather all of the health check history data, skip to step 4.
3. Collect baseline data and the latest health check data:
  - a. Change the directory by using the following command: `cd /var/opt/iba/analysis.`
  - b. Collect .tar file data using following command: `tar -cvf healthcheck.customer.timestampbaseline latest` Example: `tar -cvf healthcheck.IBM.20080508-1742 baseline latest`
  - c. Skip to step 5.
4. Gather all of the health check history data:
  - a. Change the directory by using the following command: `cd /var/log/iba.`
  - b. Collect .tar file data by using the following command: `tar -cvf healthcheck.customer.timestampanalysis.`
5. Zip the .tar file using the following command: `gzip healthcheck.customer.timestamp.tar.`
6. Send the resulting file to the appropriate support team - Example: `healthcheck.IBM.20080508-2013.tar.gz.`

### **Capturing switch CLI output using a script command for 7874-024, 7874-040, 7874-120, and 7874-240 switches:**

You can use script commands in the command-line interface (CLI) to collect data that helps you analyze switch problems.

If you are directed to collect data directly from a switch CLI, capture the output using the script command (available on both Linux and AIX). The script command captures the standard output (stdout) from the Telnet or secure shell (ssh) session that has the switch and places it into a file.

To collect data using the script command, perform the following steps:

1. On the host to be used to log into the switch, run the command `script -a /[dir]/[switchname].capture.[timestamp]` where:
  - *dir* is the directory where data is stored
  - *switchname* is the name of the switch in the output file name
  - *timestamp* is the timestamp that differentiates the time from other data collected from this switch. An example format is `yyyymmdd_hhmm` (for year month day\_hour minute).
2. Use a Telnet or ssh session to access the switch CLI. See the *Switch Users Guide* on the QLogic Web site for instructions.
3. Run the command to get data that is being requested.
4. Exit from the switch CLI.
5. Press Ctrl+D to stop the script command from collecting data.
6. Forward the output file to the appropriate support team.

## **Light path diagnostics on Power Systems**

Light path diagnostics is a simplified approach for repair actions on Power Systems™ hardware that provides fault indicators to identify parts that need to be replaced.

Light path diagnostics is a system of light-emitting diodes (LEDs) on the control panel and on various internal components of the Power Systems hardware. When an error occurs, LEDs are lit throughout the system to help identify the source of the error.

With light path diagnostics, the fault LED for the FRUs to be replaced will be active when the unit is powered on. The failing FRUs can be attached to another FRU, which must be first removed to access the failing FRUs. For those cases, light path diagnostics provides a blue switch on the FRU that has to be

removed first. When the first FRU is removed, you can press and hold the light path diagnostics switch to light the LEDs and locate the failing part. In most of the situations, the switch will have enough power stored to activate the LEDs for two hours after the unit has been powered off. However, this can vary significantly and therefore the switch should be used as soon as possible. The amber LEDs can normally be kept active for 30 seconds, however, this can also vary. Associated with the light path diagnostics switch is a green LED that will be activated when the switch is used and there is enough power stored to activate the amber LEDs. If the green LED does not activate when the switch is pressed then there is not enough power remaining to activate any amber LEDs on that FRU. If that happens then light path diagnostics and FRU identify function cannot be used for replacing the failing FRUs. Perform the repair action using the location codes in the error log or if determined by problem analysis as if the unit did not have light path diagnostics and did not have functioning identify LEDs.

At the core of light path diagnostics is a set of fault indicators that are implemented as amber LEDs. These LEDs provide a way for the diagnostics to identify which field-replaceable unit (FRU) needs to be replaced. Service labels, color-coded touch points for the FRUs, and a no tools required design for FRU removal and installation are all elements of light path diagnostics.

With light path diagnostics, at the same time that the diagnostics create an error log for the problem, it also activates the fault indicator when a FRU has a failed or failing component. This includes predictive failure analysis (PFA). The FRU fault LED is turned on solid (not blinking). Whenever a fault indicator is activated the enclosure's external Fault indicator on the operator panel is also turned on solid. The enclosure fault indicator on the panel means that inside the unit one or more FRU fault indicators is on. The error log shows the part number and location code of the FRU that must be replaced along with other FRUs or procedures to follow if replacing the first FRU does not resolve the problem.

If the diagnostics determine that the problem is firmware related, configuration related, or not isolated to a specific FRU then no fault indicator is activated. For these kinds of problems the amber System Info indicator on the operator panel is activated. The error log shows the procedures to follow and the possible FRUs that could be causing the problem.

During the repair action, the service label on the service access cover shows the FRUs and the steps required to remove or install the FRUs. Therefore, the basic flow of the repair is that the LEDs show which part to replace, the color-coded touch points indicate if the unit must be powered off to remove or install the part, and the service label shows the steps needed on the touch points. The FRU fault LED is not an indication that the FRU is ready to be replaced. To replace the FRU, some preparation steps might be necessary, such as removing the resource from use or powering off the unit. The service label and the touch point colors give the initial guidance for FRU removal.

When a FRU has been replaced, the fault indicator automatically turns off either when the new FRU is installed, or when the power is restored to the new FRU. This automatic shut off might take several seconds to a minute as the new FRU is powered on, brought online and tested by the system. When there are no more FRU fault indicators on in an enclosure then the enclosure's Fault indicator on the operator panel turns off automatically.

In addition to the fault indicators, there are also amber identify indicators for each FRU. The identify indicators blink when activated. Identify indicators are used to help a servicer identify where a location is. The location may be occupied or empty. The servicer can turn them on and off from a user interface either during a repair action or during the installation of new parts or when removing parts. The identify indicator visually confirms where a location code is. Whenever an identify indicator is activated, the enclosure's blue *locate* or *beacon* LED on the operator panel is activated (blinking) also.

The same amber LED on a FRU can be used for both fault and identify indications. Whenever the LED is on solid for a fault, the LED switches to blinking when the FRU identify function is turned on. When identify function is turned off, the LED returns to fault (solid on) if that was the previous state of the LED.

## Replacing FRUs using enclosure fault indicators

When you have obtained a replacement part, use this procedure to identify the location of the part that needs to be replaced.

To identify and locate the part that requires replacement, complete the following steps.

1. Before moving the unit into the service position, refer to the service label. It might be necessary to identify and remove cables attached to the FRU you are about to exchange. Go to “Service labels” on page 28 to locate the service label for your system. Use the FRU location code and the service label to determine if there are any actions prior to moving the unit into the service position. Perform those actions and return to the next step in this procedure.
2. Identify the unit with the active enclosure fault indicator. Use the service label that is affixed to the service access cover and the amber light-emitting diode (LED) on the FRU to find the failing FRU. Move the unit into the service position, but do not remove the service access cover.
  - If the unit is rack-mounted, the service label is visible on the service access cover. Continue with the next step.
  - If the unit is a stand-alone system, the exterior cover must be removed to view the service label. Remove the exterior cover using the procedure found in the following table and then return to the next step in this procedure.

Table 3. Exterior cover removal procedures for the stand-alone 8202-E4B, 8202-E4C, or 8205-E6B servers

Machine type and model	Removal procedure
8202-E4B, 8202-E4C, or 8205-E6B	Removing the service access cover on a stand-alone 8202-E4B, 8202-E4C, or 8205-E6B system

3. Using the service label, determine if the FRU you are replacing can be exchanged without removing the service access cover. Is the FRU fault LED visible externally and active (on solid, not blinking) and does the service label show that the service access cover does not need to be removed to exchange the FRU? (Choose No if you are unsure.)

**Note:** If you used the identify function in a user interface to help locate the FRU, then the amber LED is blinking. Otherwise, the amber LED is solid (not blinking).

- **Yes:** Go to step 6 on page 27.
  - **No:** To identify which FRU to exchange, you must remove the service access cover and locate the FRU that has an active FRU fault indicator (amber LED on). Continue with the next step.
4. Remove the service access cover and locate the FRU that has an active fault indicator (amber LED on, not blinking). Use the following table to determine if you must power off the unit before removing the cover.

Table 4. Determining power off requirements

Machine type and model	Power off before removing the cover?	Comments
8202-E4B or 8202-E4C	Yes	<b>CAUTION:</b> The server will automatically power off when the service access cover is removed. To prevent data loss, end all applications and jobs, and then power off the operating system and the unit normally before removing the service access cover.
8205-E6B or 8205-E6C	Yes	
8231-E2B, 8231-E1C, or 8231-E2C	Yes	
All other models	No	You can remove the service access cover while the unit is powered on.

5. Search for the FRU to be replaced by locating the active amber LED.

**Notes:**

- If you used the identify function in a user interface to help locate the FRU, then the amber LED is blinking. Otherwise, the amber LED is solid (not blinking).
- Some FRUs might be an integral part of another FRU. This might make it difficult to see the FRU you need to exchange or the amber LED that designates the FRU that needs to be exchanged. If this is the case, you will need to remove all FRUs that are associated with the failing FRU.

Do you have to remove another FRU to replace the FRU designated by the amber LED?

- **Yes:** Go to step 10 on page 28.
  - **No:** Continue with the next step.
6. For the FRU you located with its fault LED active, was it replaced for this problem or service action?
    - **Yes:** The FRU replaced for the original problem did not resolve the problem. Go back to the serviceable event for the original problem and address the remaining FRUs that are listed. Use the Advanced System Management Interface (ASMI) to turn off the fault indicator for the FRU. **This ends the procedure.**
    - **No:** Continue with the next step.
  7. For the FRU you located with the active fault LED, compare the location code you recorded for the replacement FRU of the problem you are working on with the location code of the active fault indicator. If they do not match, you are working a problem from the log that is different from the problem that activated the fault indicators. Do the location codes match?
    - **Yes:** You are working the same problem that activated the fault indicators. Continue with the next step.
    - **No:** If you have the correct replacement FRU for where the fault indicator is active, you can continue with this repair action. When replacing the FRU, record the location codes of the active fault indicators for use later to identify which problem to close when the repair is complete, then continue with the next step. Otherwise, contact your service provider to obtain the replacement part for the FRU with an active fault indicator and begin problem analysis again. **This ends the procedure.**
  8. For the FRU you located with its fault LED active, is the color of the touch points (latches, knobs, or levers that are used to secure or remove the FRU) blue?
    - **Yes:** You must power off the unit to exchange the FRU. At the system administrator's earliest convenience, power off the unit and use the information on the service label to exchange the FRU. When the FRU is exchanged, use the service label to guide you in reassembling the unit. Power on the unit. The FRU fault indicator is turned off during the power on process if it was not already turned off. If the enclosure fault indicator turns on again within a few minutes of powering on the unit, then begin problem analysis again. Otherwise, close the problem. **This ends the procedure.**
    - **No:** The color of the touch points is *terra cotta*. Continue with the next step.
  9. If you have not already done so, record the location of the FRU you are about to exchange either by where the service label shows the FRU or where it is in the unit by the location labeling. Use the Table 5 table to access the locations and addresses for the machine type and model of the unit you are working on. In the locations and addresses information for your system, locate the FRU and the corresponding FRU exchange procedure. The exchange procedure provides the steps necessary to exchange the FRU. If the FRU can be replaced while the unit is powered on the exchange procedure provides that option and the necessary instructions. If the enclosure fault indicator turns on again within a few minutes of completing the replacement and returning to normal use of the unit, then begin problem analysis again. Otherwise, close the problem. **This ends the procedure.**

Table 5. Locations and addresses

Machine type and model	Locations and addresses
8202-E4B or 8202-E4C	8202-E4B or 8202-E4C Locations
8205-E6B or 8205-E6C	8205-E6B or 8205-E6C Locations
8231-E2B, 8231-E1C, or 8231-E2C	8231-E2B, 8231-E1C, or 8231-E2C Locations

10. For this FRU, is the color of the touch points (latches, knobs, or levers that are used to free and remove the FRU) blue?
  - **Yes:** You must power off the unit to remove the FRU. At the system administrator's earliest convenience power off the unit and use the information on the service label to remove the FRU. When you remove this FRU, the fault indicator for the FRU you plan to exchange will turn off. This FRU has an LED activation button you can press that powers the amber indicator of the FRU you plan to exchange. Use the button to locate the FRU. Go to step 12.
  - **No:** The color of the touch points is *terra cotta*. Continue with the next step.
11. If you have not already done so, record the location of the FRU you plan to remove either by where the service label shows the FRU or where it is in the unit by the location labeling. Use Table 5 on page 27 to access the locations and addresses for the machine type and model of the unit you are working on. In the locations and addresses information, locate the FRU and the corresponding FRU exchange procedure. The exchange procedure provides the steps necessary to remove this FRU. If the FRU can be removed while the unit is powered on, the exchange procedure provides that option and the necessary instructions. When you remove this FRU, the fault indicator for the associated FRU you are exchanging turns off. This FRU has an LED activation button that you can press that powers the amber indicator of the FRU you are exchanging. Use the button to locate the FRU you are exchanging. Go to step 8 on page 27.

**Note:** If the button's green LED does not activate then there is not enough charge remaining in the switch to activate the amber fault LED. Use the FRU location code from the error log or if determined by problem analysis to identify the failing FRU.

12. For the FRU you located that has its fault LED active, were any of them replaced for this problem or service action?
  - **Yes:** The FRU replaced for the original problem did not resolve the problem. Go back to the serviceable event for the original problem and work the remaining FRUs listed. Use ASMI to turn off the fault indicator for the FRU. **This ends the procedure.**
  - **No:** Use the information on the service label to exchange the FRU. When the FRU is exchanged, use the service label to guide you in reassembling the unit. Power on the unit. The FRU fault indicator is turned off during the power-on process if it was not already turned off. This ends the procedure. If the enclosure fault indicator turns on again within a few minutes of powering on the unit, then begin problem analysis again. Otherwise, close this problem. **This ends the procedure.**

## Service labels

Use this information to view the service labels on system models 8202-E4B, 8202-E4C, 8205-E6B, 8205-E6C, 8231-E2B, 8231-E1C, 8231-E2C, 8233-E8B, 8236-E8C, or 5802 and 5877 expansion units.

To view the service label, select the system model you are servicing.

- 8202-E4B or 8205-E6B service label
- 8202-E4C or 8205-E6C service label
- 8231-E2B service label
- 8231-E1C or 8231-E2C service label
- 8233-E8B service label
- 8236-E8C service label
- 5802 and 5877 service label

## Problem reporting form

Use the problem reporting form to record information about your server that will assist you in problem analysis.

Collect as much information as possible in the tables below, using either the control panel or the management console to gather the information.



Table 6. Customer, system, and problem information

Customer information and problem description	
Your name	
Telephone number	
IBM customer number, if available	
Date and time that the problem occurred	
Describe the problem	
System Information	
Machine type	
Model	
Serial number	
IPL type	
IPL mode	
Message information	
Message ID	
Message text	
Service request number (SRN)	
In which mode were IBM hardware diagnostics run?	<input type="checkbox"/> Online or <input type="checkbox"/> stand-alone ? <input type="checkbox"/> Service mode or <input type="checkbox"/> concurrent mode?

Go to the management console or the control panel and indicate whether the following lights are on.

Table 7. Control panel lights

Control panel light	Place a check if light is on
Power On	
System Attention	

Go to the management console or control panel to find and record the values for functions 11 through 20. Use the following grid to record the characters shown on the management console or Function/Data display.

Table 8. Function values

Function	Value
11	----- --
12	----- --
13	----- --
14	----- --
15	----- --

Table 8. Function values (continued)

Function	Value
16	----- -- --
17	----- -- --
18	----- -- --
19	----- -- --
20 (for control panel users)	----- -- --
20 (for management console users)	Machine type:  Model:  Processor feature code:  IPL type:

---

## Starting a repair action

This is the starting point for repair actions. All repair actions should begin with this procedure. From this point, you are guided to the appropriate information to help you perform the necessary steps to repair the server. This procedure was formerly the starting a service call procedure.

**Note:** In this topic, **control panel** and **operator panel** are synonymous.

Before beginning, record information to help you return the server to the same state that the customer typically uses, such as:

- The IPL type that the customer typically uses for the server.
- The IPL mode that is used by the customer on this server.
- The way in which the server is configured or partitioned.

---

1. Has problem analysis been performed using the procedures in problem analysis?

- **Yes:** Continue with the next step.
- **No:** Perform problem analysis using the procedures in problem analysis.

---

2. Is the failing server managed by a management console?

- **Yes:** Continue with step 5 on page 31.
- **No:** Continue with the next step.

---

3. Do you have an action plan to perform an isolation procedure?

- **Yes:** Go to Isolation procedures.
  - **No:** Continue with the next step.
-

4. Do you have a field replaceable unit (FRU), location code, and an action plan to replace a failing FRU?

- **Yes:** Go to removal and replacement procedures for the system you are servicing.
- **No:** Go to Part locations and location codes to find the part that you need, then go to the removal and replacement procedures for the system you are servicing.

**This ends the procedure.**

---

5. Is the management console connected and functional?

- **Yes:** Continue with the next step.
  - **No:** Start the management console and attach it to the server. When the management console is connected and functional, continue with the next step.
- 

6. Perform the following steps from the management console that is used to manage the server. During these steps, refer to the service data that was gathered earlier:

- For Hardware Management Console (HMC), complete the following steps:
  1. In the Navigation Area, open **Service Management**.
  2. Select **Manage Events**. The Manage Serviceable Events - Select Serviceable Events panel will be displayed.
  3. Select the status of **Open**.
  4. Select all other selections to **ALL** and click **OK**.
  5. Scroll through the list and verify that there is a problem with the status of **Open** to correspond with the customer's reported problem.
  6. Do you find the reported problem, or an open problem near the time of the reported problem?
- For IBM Systems Director Management Console (SDMC), complete the following steps:
  1. From the main Service and Support Manager page, click **Serviceable Problems** within the **Electronic Services Links** box.  
**Tip:** The Serviceable Problems link displays a filtered list of only those problems associated with systems that are monitored by Service and Support Manager.
  2. Scroll through the list and verify that there is a problem that has a status of **Open** to correspond with the customer's reported problem.
  3. Do you find the reported problem, or an open problem near the time of the reported problem?

**Note:** If you are unable to locate the reported problem, and there is more than one open problem near the time of the reported failure, use the earliest problem in the list.

- **Yes:** Continue with the next step.
  - **No:** Go to step 4, or if a serviceable event was not found, see the appropriate problem analysis procedure for the operating system you are using.
    - If the server or partition is running the AIX or Linux operating system, see AIX and Linux problem analysis.
    - If the server or partition is running the IBM i operating system, see IBM i problem analysis.
- 

7. To perform a repair operation from the management console, complete the following steps:

- For HMC, complete the following steps:
  - a. Select the serviceable event you want to repair, and click **Repair** from the Selected menu.

- b. Follow the instructions displayed on the HMC.

After you complete the repair procedure, the system automatically closes the serviceable event.

**This ends the procedure.**

- For SDMC, complete the following steps:
  - a. Select the serviceable event you want to repair, and select **Repair** from the **Actions** menu. Follow the instructions displayed on the SDMC.
  - b. After you complete the repair procedure, the system automatically closes the serviceable event. **This ends the procedure.**

**Note:** If the **Repair** procedures are not available, go to step 4 on page 31.

## Reference information for problem determination

The problem determination reference information is provided as an additional resource for problem detection and analysis when you are directed here by your service representative.

All repair actions should start with “Beginning problem analysis” on page 1 and be followed by “Starting a repair action” on page 30 before you use these tools and techniques for problem determination.

## Symptom index

Use this symptom index only when you are guided here by your service representative.

**Note:** If you were not guided here by your service representative, go to “Beginning problem analysis” on page 1.

Review the symptoms in the left column. Look for the symptom that most closely matches the symptoms on the server that you are troubleshooting. When you find the matching symptom, perform the appropriate action as described in the right column.

*Table 9. Determining symptom types*

Symptom	What you should do:
You do not have a symptom.	Go to the Starting a repair action.
The symptom or problem is on a server or a partition running IBM i	Go to “IBM i server or IBM i partition symptoms.”
The symptom or problem is on a server or a partition running AIX.	Go to “AIX server or AIX partition symptoms” on page 36.
The symptom or problem is on a server or a partition running Linux.	Go to “Linux server or Linux partition symptoms” on page 50.

## IBM i server or IBM i partition symptoms

Use the following tables to find the symptom you are experiencing. If you cannot find your symptom, contact your next level of support.

- General symptoms
- Symptoms occurring when the system is not operational
- Symptoms related to a logical partition on a server that has multiple logical partitions
- Obvious physical symptoms
- Time-of-day symptoms

Table 10. General IBM i server or IBM i partition symptoms

Symptom	Service action
You have an intermittent problem or you suspect that the problem is intermittent.	Go to "Intermittent problems" on page 140.
DST/SST functions are available on the logical partition console and: <ul style="list-style-type: none"> <li>The customer reports reduced system function.</li> <li>There is a server performance problem.</li> <li>There are failing, missing, or inoperable server resources.</li> </ul>	On most servers with logical partitions, it is common to have one or more missing or non-reporting system bus resource's under Hardware Service Manager (see Hardware Service Manager for more information).
Operations Console, or the remote control panel is not working properly.	Contact Software Support.
The system has a processor or memory problem.	Use the Service action log to check for a reference code or any failing items. See Service action log for instructions, replacing any hardware FRUs if necessary.
The system has detected a bus problem. An SRC of the form B600 69xx or B700 69xx will be displayed on the control panel or management console.	Go to Service action log.

Table 11. Symptoms occurring when the system is not operational

Symptom	Service action
A bouncing or scrolling ball (moving row of dots) remains on the operator panel display, or the operator panel display is filled with dashes or blocks.	<p>Verify that the operator panel connections to the system backplane are connected and properly seated. Also, reseal the Service Processor card.</p> <p>If a client computer (such as a PC with Ethernet capability and a Web browser) is available, connect it to the service processor in the server that is displaying the symptom.</p> <p>To connect a personal computer with Ethernet capability and a Web browser, or an ASCII terminal, to access the Advanced System Management Interface (ASMI), go to Managing your server using the Advanced System Management Interface.</p> <ul style="list-style-type: none"> <li>If you can successfully access the ASMI, replace the operator panel assembly. Refer to Finding parts, locations, and addresses to determine the part number and correct exchange procedure.</li> <li>If you cannot successfully access the ASMI, replace the service processor. Refer to Finding parts, locations, and addresses to determine the part number and correct exchange procedure.</li> </ul> <p>If you do not have a PC or ASCII terminal, replace the following one at a time (go to Finding parts, locations, and addresses to determine the part number and correct exchange procedure):</p> <ol style="list-style-type: none"> <li>Operator panel assembly.</li> <li>Service processor.</li> </ol>

Table 11. Symptoms occurring when the system is not operational (continued)

Symptom	Service action
You have a blank display on the operator panel. Other LEDs on the operator panel appear to behave normally.	<p>Verify that the operator panel connections to the system backplane are connected and properly seated.</p> <p>If a client computer (such as a PC with Ethernet capability and a Web browser) is available, connect it to the service processor in the server that is displaying the symptom.</p> <p>To connect a personal computer with Ethernet capability and a Web browser, or an ASCII terminal, to access the Advanced System Management Interface (ASMI), go to Managing your server using the Advanced System Management Interface.</p> <ul style="list-style-type: none"> <li>• If you can successfully access the ASMI, replace the operator panel assembly. Refer to Finding parts, locations, and addresses to determine the part number and correct exchange procedure.</li> <li>• If you cannot successfully access the ASMI, replace the service processor. Refer to Finding parts, locations, and addresses to determine the part number and correct exchange procedure.</li> </ul> <p>If you do not have a PC or ASCII terminal, replace the following one at a time (go to Finding parts, locations, and addresses to determine the part number and correct exchange procedure):</p> <ol style="list-style-type: none"> <li>1. Control (operator) panel assembly.</li> <li>2. Service processor.</li> </ol>
There is an IPL problem, the system attention light is on, and blocks of data appear for 5 seconds at a time before moving to the next block of data for 5 seconds, and so on until 5 seconds of a blank control panel is displayed at which time the cycle repeats.	These blocks of data are functions 11 through 20. The first data block after the blank screen is function 11, the second block is function 12, and so on. Use this information to fill out the Problem reporting forms. Then go to Reference codes.
You have a power problem, the system or an attached unit will not power on or will not power off, or there is a 1xxx-xxxx reference code.	Go to Power problems.
There is an SRC in function 11.	Look up the reference code (see Reference codes).
There is an IPL problem.	Go to "IPL problems" on page 145.
There is a Device Not Found message during an installation from an alternate installation device.	Go to TUIPIP06.

Table 12. Symptoms related to a logical partition on a server that has multiple logical partitions

Symptom	Service action
The console is not working for a logical partition.	See Recovering when the console does not show a sign-on display or a menu with a command line.

Table 12. Symptoms related to a logical partition on a server that has multiple logical partitions (continued)

Symptom	Service action
<ul style="list-style-type: none"> <li>• There is an SRC on the panel of an I/O expansion unit owned by a logical partition.</li> <li>• You suspect a power problem with resources owned by a logical partition.</li> <li>• There is an IPL problem with a logical partition and there is an SRC on the management console.</li> <li>• The logical partition's operations have stopped or the partition is in a loop and there is an SRC on the management console.</li> </ul> <p>The logical partition's console is functioning, but the state of the partition in the management console is "Failed" or "Unit Attn" and there is an SRC.</p>	<ul style="list-style-type: none"> <li>• Search Service Focal Point™ for a serviceable event.</li> <li>• If you do not find a serviceable event in Service Focal Point, then record the partition's SRC from the Operator Panel Values field in the management console: For HMC:               <ol style="list-style-type: none"> <li>1. In the Navigation Area, expand <b>Server and Partition</b> → <b>Server Management</b>.</li> <li>2. In the right pane, expand or select your system or partition.</li> <li>3. Use that SRC and look up the reference code (see Reference codes).</li> </ol>               For SDMC:               <ol style="list-style-type: none"> <li>1. In the IBM Systems Director navigation area, click <b>Welcome</b>.</li> <li>2. On the Welcome page, click <b>Resources &gt; Virtual Servers</b>. The list of virtual servers is displayed with the corresponding reference code.</li> </ol> </li> </ul> <p>Use the logical partition's SRC. From the partition's console search for that SRC in the partition's Service Action Log. See Service action log.</p>
<p>There is an IPL problem with a logical partition and there is no SRC displayed in the management console.</p>	<p>Perform the following to look for the panel value for the partition in the management console:</p> <p>For HMC:</p> <ol style="list-style-type: none"> <li>1. In the Navigation Area, expand <b>Server and Partition</b> → <b>Server Management</b>.</li> <li>2. In the right pane expand the system that contains the partition.</li> <li>3. Open <b>Partitions</b>.</li> <li>4. Right-click the logical partition and select <b>Properties</b>.</li> <li>5. Select the <b>Reference Code</b> tab to view the codes.</li> <li>6. When finished, click <b>Cancel</b>.</li> </ol> <p>For SDMC:</p> <ol style="list-style-type: none"> <li>1. In the IBM Systems Director navigation area, click <b>Welcome</b>.</li> <li>2. On the Welcome page, click <b>Resources &gt; Virtual Servers</b>. The list of virtual servers is displayed with the corresponding reference code.</li> </ol> <p>Go to Reference codes. If no reference code can be found, contact your next level of support.</p>
<p>The partition's operations have stopped or the partition is in a loop and there is no SRC displayed on the management console.</p>	<p>Perform function 21 from the management console. If this fails to resolve the problem, contact your next level of support.</p>

Table 12. Symptoms related to a logical partition on a server that has multiple logical partitions (continued)

Symptom	Service action
One or more of the following was reported: <ul style="list-style-type: none"> <li>• There is a system reference code or message on the logical partition's console.</li> <li>• The customer reports reduced function in the partition.</li> <li>• There is a logical partition performance problem.</li> <li>• There are failing, missing, or inoperable resources.</li> </ul>	From the partition's console search the partition's Service Action Log. Go to Service action log. <b>Note:</b> On most systems with logical partitions, it is common to have one or more "Missing or Non-reporting" system bus resource's under Hardware Service Manager. See Hardware Service Manager for details.
There is a Device Not Found message during an installation from an alternate installation device.	Go to TUPIP06.
There is a problem with a guest partition. <b>Note:</b> These are problems reported from the operating system (other than IBM i) running in a guest partition or reported from the hosting partition of a guest partition.	If there are serviceable events in the logical partition or hosting partition, work on these problems first. If there are no SAL entries in the logical partition and no SAL entries in the hosting partition, contact your next level of support.

Table 13. Obvious physical symptoms

Symptom	Service action
A power indicator light or display on the system unit control panel or an attached I/O unit is not working correctly.	Perform PWR1920.
One or more of the following was reported: <ul style="list-style-type: none"> <li>• Noise</li> <li>• Smoke</li> <li>• Odor</li> </ul>	Go to the system safety inspection procedures for your specific system.
A part is broken or damaged.	Go to the System parts to get the part number. Then go to the remove and replace procedures for your specific system to exchange the part.

Table 14. Time-of-day problems

Symptom	Service action
System clock loses or gains more than 1 second per day when the system is connected to utility power.	Replace the service processor. See symbolic FRU SVCPROC.
System clock loses or gains more than 1 second per day when the system is disconnected from utility power.	Replace the time-of-day battery on the service processor. Go to symbolic FRU TOD_BAT.

## AIX server or AIX partition symptoms

Use the following tables to find the symptom you are experiencing. If you cannot find your symptom, contact your next level of support.

Choose the description that best describes your situation:

- You have a service action to perform
- Integrated Virtualization Manager (IVM) problem
- An LED is not operating as expected
- Control (operator) panel problems
- Reference codes
- Management consoles



- There is a display or monitor problem (for example, distortion or blurring)
- Power and cooling problems
- Other symptoms or problems

### You have a service action to perform

Symptom	What you should do:
You have an open service event in the service action event log.	Go to Starting a repair action.
You have parts to exchange or a corrective action to perform.	<ol style="list-style-type: none"> <li>1. Go to the remove and replace procedures for your specific server.</li> <li>2. Go to Close of call procedure.</li> </ol>
You need to verify that a part exchange or corrective action corrected the problem.	<ol style="list-style-type: none"> <li>1. Go to Verifying the repair.</li> <li>2. Go to the Close of call procedure.</li> </ol>
You need to verify correct system operation.	<ol style="list-style-type: none"> <li>1. Go to Verifying the repair.</li> <li>2. Go to Close of call procedure.</li> </ol>

### Integrated Virtualization Manager (IVM) problem

Symptom	What you should do:
The partitions do not activate - partition configuration is damaged	Restore the partition configuration data using IVM. See Backing up and restoring partition data.
Other partition problems when the server is managed by IVM	Perform Troubleshooting with the Integrated Virtualization Manager.

### An LED is not operating as expected

Symptom	What you should do:
The system attention LED on the control panel is on.	Go to Starting a repair action.
The rack identify LED does not operate properly.	Go to AIX fast-path problem isolation.
The rack indicator LED does not turn on, but a drawer identify LED is on.	<ol style="list-style-type: none"> <li>1. Make sure the rack indicator LED is properly mounted to the rack.</li> <li>2. Make sure that the rack identify LED is properly cabled to the bus bar on the rack and to the drawer identify LED connector.</li> <li>3. Replace the following parts one at a time: <ul style="list-style-type: none"> <li>• Rack LED to bus bar cable</li> <li>• LED bus bar to drawer cable</li> <li>• LED bus bar</li> </ul> </li> <li>4. Contact your next level of support</li> </ol>

## Control (operator) panel problems

Symptom	What you should do:
<p>01 does not appear in the upper-left corner of the operator panel display after the power is connected and before pressing the power-on button. Other symptoms appear in the operator panel display or LEDs before the power on button is pressed.</p>	<p>Go to Power problems.</p>
<p>A bouncing or scrolling ball (moving row of dots) remains on the operator panel display, or the operator panel display is filled with dashes or blocks.</p>	<p>Verify that the operator panel connections to the system backplane are connected and properly seated. Also, reseal the Service Processor card.</p> <p>If a client computer (such as a PC with Ethernet capability and a Web browser) is available, connect it to the service processor in the server that is displaying the symptom.</p> <p>To connect a personal computer with Ethernet capability and a Web browser, or an ASCII terminal, to access the Advanced System Management Interface (ASMI), go to <i>Managing your server using the Advanced System Management Interface</i>.</p> <ul style="list-style-type: none"> <li>• If you can successfully access the ASMI, replace the operator panel assembly. See <i>Finding parts, locations, and addresses to determine the part number and correct exchange procedure</i>.</li> <li>• If you cannot successfully access the ASMI, replace the service processor. See <i>Finding parts, locations, and addresses to determine the part number and correct exchange procedure</i>.</li> </ul> <p>If you do not have a PC or ASCII terminal, replace the following one at a time (go to <i>Finding parts, locations, and addresses to determine the part number and correct exchange procedure</i>):</p> <ol style="list-style-type: none"> <li>1. Operator panel assembly.</li> <li>2. Service processor.</li> </ol>

Symptom	What you should do:
You have a blank display on the operator panel. Other LEDs on the operator panel appear to behave normally.	<p>Verify that the operator panel connections to the system backplane are connected and properly seated.</p> <p>If a client computer (such as a PC with Ethernet capability and a Web browser) is available, connect it to the service processor in the server that is displaying the symptom.</p> <p>To connect a personal computer with Ethernet capability and a Web browser, or an ASCII terminal, to access the Advanced System Management Interface (ASMI), go to <i>Managing your server using the Advanced System Management Interface</i>.</p> <ul style="list-style-type: none"> <li>• If you can successfully access the ASMI, replace the operator panel assembly. See <i>Finding parts, locations, and addresses to determine the part number and correct exchange procedure</i>.</li> <li>• If you cannot successfully access the ASMI, replace the service processor. See <i>Finding parts, locations, and addresses to determine the part number and correct exchange procedure</i>.</li> </ul> <p>If you do not have a PC or ASCII terminal, replace the following one at a time (go to <i>Finding parts, locations, and addresses to determine the part number and correct exchange procedure</i>):</p> <ol style="list-style-type: none"> <li>1. Control (operator) panel assembly.</li> <li>2. Service processor.</li> </ol>
You have a blank display on the operator panel. Other LEDs on the operator panel are off.	Go to Power problems.
An 888 sequence is displayed in the operator panel display.	Go to AIX fast-path problem isolation.

## Reference codes

Symptom	What you should do:
You have an 8-digit error code displayed.	<p>Look up the reference code in the Reference codes section of the Information Center.</p> <p><b>Note:</b> If the repair for this code does not involve replacing a FRU (for instance, running an AIX command that fixes the problem or changing a hot-pluggable FRU), then update the AIX error log after the problem is resolved by performing the following steps:</p> <ol style="list-style-type: none"> <li>1. In the online diagnostics, select <b>Task Selection</b> → <b>Log Repair Action</b>.</li> <li>2. Select resource <b>sysplanar0</b>.</li> </ol> <p>On systems with a fault indicator LED, this changes the fault indicator LED from the fault state to the normal state.</p>
The system stops with an 8-digit error code displayed when booting.	Look up the reference code in the Reference codes section of the information center.
The system stops and a 4-digit code displays on the control panel that does <b>not</b> begin with 0 or 2.	Look up the reference code in the Reference codes section of the information center.

<b>Symptom</b>	<b>What you should do:</b>
The system stops and a 4-digit code displays on the control panel that begins with 0 or 2.	Record SRN 101-xxxx where xxxx is the 4-digit code displayed in the control panel, then look up this reference code in the Reference codes section of the information center. Follow the instructions given in the Description and Action column for your SRN.
The system stops and a 3-digit number displays on the control panel.	<p>Add 101- to the left of the three digits to create an SRN, then look up this reference code in the Reference codes section of the information center. Follow the instructions given in the Description and Action column for your SRN.</p> <p>If there is a location code displayed under the 3-digit error code, look at the location to see if it matches the failing component that the SRN pointed to. If they do not match, perform the action given in the error code table. If the problem still exists, replace the failing component from the location code.</p> <p>If there is a location code displayed under the 3-digit error code, record the location code.</p> <p>Record SRN 101-xxx, where xxx is the 3-digit number displayed in the operator panel display, then look up this reference code in the Reference codes section of the information center. Follow the instructions given in the Description and Action column for your SRN.</p>

## Management consoles

Symptom	What you should do:
<p>The management console cannot be used to manage a managed system, or the connection to the managed system is failing.</p>	<p>If the managed system is operating normally (that is, no error codes or other symptoms) the management console might have a problem, or the connection to the managed system might be damaged or incorrectly cabled. Complete the following steps:</p> <ol style="list-style-type: none"> <li>1. Check the connections between the management console and the managed system. Correct any cabling errors, if found. If another cable is available, connect it in place of the existing cable and refresh the management console interface. You might have to wait up to 30 seconds for the managed system to reconnect.</li> <li>2. Verify that any connected management console is connected to the managed system.  <b>Note:</b> The managed system must have power connected, and either be waiting for a power-on instruction (that is, 01 is in the upper-left corner of the operator panel) or be running.            If the managed system does not appear in the navigation area of the management console management environment, the management console or the connection to the managed system might be failing.</li> <li>3. Go to the entry MAP:               <ul style="list-style-type: none"> <li>• For HMC: Managing the HMC section.</li> <li>• For SDMC: Managing the SDMC section.</li> </ul> </li> <li>4. If there is a problem with the service processor card or the system backplane, follow these steps.               <ul style="list-style-type: none"> <li>• If you cannot fix the problem using the HMC tests in the Managing the HMC section:</li> <li>• If you cannot fix the problem using the SDMC tests in the Managing the SDMC section:                   <ol style="list-style-type: none"> <li>a. Replace the service processor card. See the remove and replace procedures for your specific system.</li> <li>b. Replace the system backplane if not already replaced in substep a. See the remove and replace procedures for your specific system.</li> </ol> </li> </ul> </li> </ol>
<p>The management console (HMC only) cannot call out by using the attached modem and the customer's telephone line.</p>	<p>If the managed system is operating normally (that is, no error codes or other symptoms), the management console might have a problem, or the connection to the modem and telephone line might have a problem. Complete the following steps:</p> <ol style="list-style-type: none"> <li>1. Check the connections between the management console, the modem, and the telephone line. Correct any cabling errors, if found.</li> <li>2. Go to the entry MAP in the Managing your server using the Hardware Management Console section.</li> </ol>

## There is a display problem (for example, distortion or blurring)

Symptom	What you should do:
All display problems.	<ol style="list-style-type: none"> <li>1. If you are using the management console: <ul style="list-style-type: none"> <li>• Hardware Management Console: Go to the Managing the HMC section.</li> <li>• Systems Director Management Console: Go to the Managing the SDMC section.</li> </ul> </li> <li>2. If you are using a graphics display: <ol style="list-style-type: none"> <li>a. Go to the problem determination procedures for the display.</li> <li>b. If you do not find a problem: <ul style="list-style-type: none"> <li>• Replace the graphics display adapter. See the remove and replace procedures for your specific system.</li> <li>• Replace the backplane into which the card is plugged. See the remove and replace procedures for your specific system.</li> </ul> </li> </ol> </li> <li>3. If you are using an ASCII terminal: <ol style="list-style-type: none"> <li>a. Make sure that the ASCII terminal is connected to S1.</li> <li>b. If problems persist, go to the problem determination procedures for the terminal.</li> <li>c. If you do not find a problem, replace the service processor. See the remove and replace procedures for your specific system.</li> </ol> </li> </ol>
There appears to be a display problem (distortion, blurring, and so on)	Go to the problem determination procedures for the display.

## Power and cooling problems

Symptom	What you should do:
The system will not power on and no error codes are available.	Go to Power problems.
The power LEDs on the operator panel and the power supply do not come on or stay on.	<ol style="list-style-type: none"> <li>1. Check the service processor error log.</li> <li>2. Go to Power problems.</li> </ol>
The power LEDs on the operator panel and the power supply come on and stay on, but the system does not power on.	<ol style="list-style-type: none"> <li>1. Check the service processor error log.</li> <li>2. Go to Power problems.</li> </ol>
A rack or a rack-mounted unit will not power on.	<ol style="list-style-type: none"> <li>1. Check the service processor error log.</li> <li>2. Go to Power problems.</li> </ol>
The cooling fan(s) do not come on, or come on but do not stay on.	<ol style="list-style-type: none"> <li>1. Check the service processor error log.</li> <li>2. Go to Power problems.</li> </ol>
The system attention LED on the operator panel is on and there is no error code displayed.	<ol style="list-style-type: none"> <li>1. Check the service processor error log.</li> <li>2. Go to Power problems.</li> </ol>

## Other symptoms or problems

Symptom	What you should do:
The system stopped and a code is displayed on the operator panel.	Go to Starting a repair action.
01 is displayed in the upper-left corner of the operator panel and the fans are off.	The service processor is ready. The system is waiting for power-on. Boot the system. If the boot is unsuccessful, and the system returns to the default display (indicated by 01 in the upper-left corner of the operator panel), go to MAP 0200: Problem determination procedure.
The operator panel displays STBY.	The service processor is ready. The server was shut down by the operating system and is still powered on. This condition can be requested by a privileged system user with no faults. Go to Starting a repair action. <b>Note:</b> See the service processor error log for possible operating system fault indications.
All of the system POST indicators are displayed on the firmware console, the system pauses and then restarts. The term <i>POST indicators</i> refers to the device mnemonics (the words memory, keyboard, network, scsi, and speaker) that appear on the firmware console during the power-on self-test (POST).	Go to Problems with loading and starting the operating system.
The system stops and all of the POST indicators are displayed on the firmware console. The term <i>POST indicators</i> refers to the device mnemonics (the words memory, keyboard, network, scsi, and speaker) that appear on the firmware console during the power-on self-test (POST).	Go to Problems with loading and starting the operating system.
The system stops and the message starting software please wait... is displayed on the firmware console.	Go to Problems with loading and starting the operating system.
The system does not respond to the password being entered or the system login prompt is displayed when booting in service mode.	<ol style="list-style-type: none"> <li>If the password is being entered from the management console: <ul style="list-style-type: none"> <li>For Hardware Management Console (HMC): Go to the Managing the HMC.</li> <li>For Systems Director Management Console (SDMC): Go to the Managing the SDMC.</li> </ul> </li> <li>If the password is being entered from a keyboard attached to the system, the keyboard or its controller may be faulty. In this case, replace these parts in the following order: <ol style="list-style-type: none"> <li>Keyboard</li> <li>Service processor</li> </ol> </li> <li>If the password is being entered from an ASCII terminal, use the problem determination procedures for the ASCII terminal. Make sure the ASCII terminal is connected to S1. If the problem persists, replace the service processor.</li> </ol> <p>If the problem is fixed, go to "MAP 0410: Repair checkout" on page 46.</p>
The system stops with a prompt to enter a password.	Enter the password. You cannot continue until a correct password has been entered. When you have entered a valid password, go to the beginning of this table and wait for one of the other conditions to occur.

Symptom	What you should do:
The system does not respond when the password is entered.	Go to Step 1020-2.
No codes are displayed on the operator panel within a few seconds of turning on the system. The operator panel is blank before the system is powered on.	<p>Reseat the operator panel cable. If the problem is not resolved, replace in the following order:</p> <ol style="list-style-type: none"> <li>1. Operator panel assembly. See the remove and replace procedures for your specific system</li> <li>2. Service processor. See the remove and replace procedures for your specific system.</li> </ol> <p>If the problem is fixed, go to "MAP 0410: Repair checkout" on page 46.</p> <p>If the problem is still not corrected, go to MAP 0200: Problem determination procedure.</p>
The SMS configuration list or boot sequence selection menu shows more SCSI devices attached to a controller/adaptor than are actually attached.	<p>A device may be set to use the same SCSI bus ID as the control adapter. Note the ID being used by the controller/adaptor (this can be checked and/or changed through an SMS utility), and verify that no device attached to the controller is set to use that ID.</p> <p>If settings do not appear to be in conflict:</p> <ol style="list-style-type: none"> <li>1. Go to MAP 0200: Problem determination procedure.</li> <li>2. Replace the SCSI cable.</li> <li>3. Replace the device.</li> <li>4. Replace the SCSI adapter</li> </ol> <p><b>Note:</b> In a "twin-tailed" configuration where there is more than one initiator device (normally another system) attached to the SCSI bus, it may be necessary to use SMS utilities to change the ID of the SCSI controller or adapter.</p>
You suspect a cable problem.	<p>Go to Adapters, Devices and Cables for Multiple Bus Systems.</p> <p><b>Note:</b> The above link will take you to the home page of the pSeries® and AIX Information Center. To access the document mentioned above, do the following:</p> <ol style="list-style-type: none"> <li>1. Select the continent (for example, North America)</li> <li>2. Select one of the three languages listed from the AIX listing (for example, English)</li> <li>3. Select "Hardware Documentation" from the navigation bar, located on the left side of the screen.</li> <li>4. In the "Hardware Documentation" window, go to the "general service documentation" section and select "Adapters, Devices, and Cable".</li> <li>5. Select "Adapters, Devices and Cable Information for Multiple Bus Systems.</li> </ol>
You have a problem that does not prevent the system from booting. The operator panel is functional and the rack indicator LED operates as expected.	Go to MAP 0200: Problem determination procedure.
All other symptoms.	Go to MAP 0200: Problem determination procedure.
All other problems.	Go to MAP 0200: Problem determination procedure.
You do not have a symptom.	Go to MAP 0200: Problem determination procedure.



Symptom	What you should do:
You have parts to exchange or a corrective action to perform.	<ol style="list-style-type: none"> <li>1. Go to Starting a repair action.</li> <li>2. Go to Close of call procedure.</li> </ol>
You need to verify that a part exchange or corrective action corrected the problem.	Go to "MAP 0410: Repair checkout" on page 46.
You need to verify correct system operation.	Go to "MAP 0410: Repair checkout" on page 46.
The system stopped. A POST indicator is displayed on the system console and an eight-digit error code is not displayed.	<p>If the POST indicator represents:</p> <ol style="list-style-type: none"> <li>1. Memory, go to PFW 1548: Memory and processor subsystem problem isolation procedure.</li> <li>2. Keyboard <ol style="list-style-type: none"> <li>a. Replace the keyboard.</li> <li>b. Replace the service processor, location: model dependent.</li> <li>c. Go to PFW 1548: Memory and processor subsystem problem isolation procedure.</li> </ol> </li> <li>3. Network, go to PFW 1548: Memory and processor subsystem problem isolation procedure.</li> <li>4. SCSI, go to PFW 1548: Memory and processor subsystem problem isolation procedure.</li> <li>5. Speaker <ol style="list-style-type: none"> <li>a. Replace the control panel. The location is model dependent, see Installing and configuring 8233-E8B and 8236-E8C systems and system features or Installing and configuring 9117-MMB, 9117-MMC, 9179-MHB, or 9179-MHC systems and system features</li> <li>b. Replace the service processor. The location is model dependent.</li> <li>c. Go to PFW 1548: Memory and processor subsystem problem isolation procedure.</li> </ol> </li> </ol>
The diagnostic operating instructions are displayed.	Go to MAP 0200: Problem determination procedure.

Symptom	What you should do:
The system login prompt is displayed.	<p>If you are loading the diagnostics from a CD-ROM, you may not have pressed the correct key or you may not have pressed the key soon enough when you were trying to indicate a service mode IPL of the diagnostic programs. If this is the case, try to boot the CD-ROM again and press the correct key.</p> <p><b>Note:</b> Perform the system shutdown procedure before turning off the system.</p> <p>If you are sure you pressed the correct key in a timely manner, go to Step 1020-2.</p> <p>If you are loading diagnostics from a Network Installation Management (NIM) server, check for the following:</p> <ul style="list-style-type: none"> <li>• The bootlist on the client may be incorrect.</li> <li>• Cstate on the NIM server may be incorrect.</li> <li>• There may be network problems preventing you from connecting to the NIM server.</li> </ul> <p>Verify the settings and the status of the network. If you continue to have problems see Problems with loading and starting the operating system and follow the steps for network boot problems.</p>
The System Management Services (SMS) menu is displayed when you were trying to boot standalone AIX diagnostics.	<p>If you are loading diagnostics from the CD-ROM, you may not have pressed the correct key when you were trying to indicate a service mode IPL of the diagnostic programs. If this is the case, try to boot the CD-ROM again and press the correct key.</p> <p>If you are sure you pressed the correct key, the device or media you are attempting to boot from may be faulty.</p> <ol style="list-style-type: none"> <li>1. Try to boot from an alternate boot device connected to the same controller as the original boot device. If the boot succeeds, replace the original boot device (for removable media devices, try the media first). If the boot fails, go to Problems with loading and starting the operating system.</li> <li>2. Go to PFW 1548: Memory and processor subsystem problem isolation procedure.</li> </ol>
The SMS boot sequence selection menu or remote IPL menu does not show all of the bootable devices in the partition or system.	<p>If an AIX or Linux partition is being booted, verify that the devices that you expect to see in the list are assigned to this partition. If they are not, use the management console to reassign the required resources. If they are assigned to this partition, go to Problems with loading and starting the operating system to resolve the problem.</p>

**MAP 0410: Repair checkout:**

Use this MAP to check out the server after a repair is completed.

**Purpose of this MAP**

Use this MAP to check out the server after a repair is completed.

**Note:** Only use standalone diagnostics for repair verification when no other diagnostics are available on the system. Standalone diagnostics do not log repair actions.

If you are servicing an SP system, go to the End-of-call MAP in the *SP System Service Guide*.

If you are servicing a clustered system, go to the End of Call MAP in the *Clustered eServer Installation and Service Guide*.

- **Step 0410-1**

**Did you use an AIX diagnostics service aid hot-swap operation to change the FRU?**

**No** Go to Step 0410-2.

**Yes** Go to Step 0410-4.

- **Step 0410-2**

**Note:** If the system planar or battery has been replaced and you are loading diagnostics from a server over a network, it may be necessary for the customer to set the network boot information for this system before diagnostics can be loaded. The system time and date information should also be set when the repair is completed.

**Do you have any FRUs (for example cards, adapters, cables, or devices) that were removed during problem analysis that you want to put back into the system?**

**No** Go to Step 0410-3.

**Yes** Reinstall all of the FRUs that were removed during problem analysis. Go to Step 0410-3.

- **Step 0410-3**

**Is the system or logical partition that you are performing a repair action on running the AIX operating system?**

**No** Go to Step 0410-5.

**Yes** Go to Step 0410-4.

- **Step 0410-4**

**Does the system or logical partition you are performing a repair action on have AIX installed?**

**Note:** Answer "No" to this question if you have just replaced a hard disk in the root volume group.

**No** Go to Step 0410-5.

**Yes** Go to Step 0410-6.

- **Step 0410-5**

Run standalone diagnostics from either a CD ROM or from a NIM server.

**Did you encounter any problems?**

**No** Go to Step 0410-14.

**Yes** Go to MAP 0020: Problem determination procedure.

- **Step 0410-6**

1. Perform the action specified in the following table.

<b>System:</b>	<b>Action:</b>
8233-E8B, 8236-E8C	Determine the level of firmware the system is running. Is system firmware AL710_xxx installed? <b>Yes:</b> Perform a slow boot. See Performing a slow boot. <b>No:</b> Perform a normal boot.

System:	Action:
9117-MMB, 9117-MMC, 9179-MHB, or 9179-MHC	Determine the level of firmware the system is running. Is system firmware AM710_xxx installed?  <b>Yes:</b> Perform a slow boot. See Performing a slow boot. <b>No:</b> Perform a normal boot.
8202-E4B, 8202-E4C, 8205-E6B, 8205-E6C, 8231-E2B, 8231-E1C, 8231-E2C, or 9119-FHB	Perform a normal boot. <b>Note:</b> Slow boot is not supported.

2. Power on the system.
3. Wait until the AIX operating system login prompt displays or until system activity on the operator panel or display apparently has stopped.

**Did the AIX Login Prompt display?**

**No** Go to MAP 0020: Problem determination procedure.

**Yes** Go to Step 0410-7.

• **Step 0410-7**

If the **Resource Repair Action** menu is already displayed, go to Step 0410-10; otherwise, do the following:

1. Log into the operating system either with root authority (if needed, ask the customer to enter the password) or use the CE login.
2. Enter the `diag -a` command and check for missing resources. Follow any instructions that display. If an SRN displays, suspect a loose card or connection. If no instructions display, no resources were detected as missing. Continue on to Step 0410-8

• **Step 0410-8**

1. Enter `diag` at the command prompt.
2. Press Enter.
3. Select the **Diagnostics Routines** option.
4. When the DIAGNOSTIC MODE SELECTION menu displays, select **Problem determination**.
5. When the ADVANCED DIAGNOSTIC SELECTION menu displays, select the **All Resources** option or test the FRUs you exchanged, and any devices that are attached to the FRU(s) you exchanged, by selecting the diagnostics for the individual FRU.

**Did the RESOURCE REPAIR ACTION menu (801015) display?**

**No** Go to Step 0410-9.

**Yes** Go to Step 0410-10.

• **Step 0410-9**

**Did the TESTING COMPLETE, no trouble was found menu (801010) display?**

**No** There is still a problem. Go to MAP 0020: Problem determination procedure.

**Yes** Use the **Log Repair Action** option, if not previously logged, in the TASK SELECTION menu to update the AIX error log. If the repair action was reseating a cable or adapter, select the resource associated with that repair action.

If the resource associated with your action is not displayed on the resource list, select **sysplanar0**.

**Note:** If the system attention indicator is on, this will set it back to the normal state.

Go to Step 0410-12.

• **Step 0410-10**

When a test is run on a resource in system verification mode, and that resource has an entry in the AIX error log, if the test on the resource was successful, the RESOURCE REPAIR ACTION menu displays. After replacing a FRU, you must select the resource for that FRU from the RESOURCE REPAIR ACTION menu. This updates the AIX error log to indicate that a system-detectable FRU has been replaced.

**Note:** If the system attention indicator is on, this action will set it back to the normal state.

Do the following:

1. Select the resource that has been replaced from the RESOURCE REPAIR ACTION menu. If the repair action was reseating a cable or adapter, select the resource associated with that repair action. If the resource associated with your action is not displayed on the resource list, select **sysplanar0**.
2. Press **Commit** after you make your selections.

**Did another Resource Repair Action (801015) display?**

**No** If the No Trouble Found menu displays, go to Step 0410-12.

**Yes** Go to Step 0410-11.

• **Step 0410-11**

The parent or child of the resource you just replaced may also require that you run the RESOURCE REPAIR ACTION service aid on it.

When a test is run on a resource in system verification mode, and that resource has an entry in the AIX error log, if the test on the resource was successful, the RESOURCE REPAIR ACTION menu displays.

After replacing that FRU, you must select the resource for that FRU from the RESOURCE REPAIR ACTION menu. This updates the AIX error log to indicate that a system-detectable FRU has been replaced.

**Note:** If the system attention indicator is on, this action will set it back to the normal state.

Do the following:

1. From the RESOURCE REPAIR ACTION menu, select the parent or child of the resource that has been replaced. If the repair action was reseating a cable or adapter, select the resource associated with that repair action. If the resource associated with your action is not displayed on the resource list, select **sysplanar0**.
2. Press **COMMIT** after you make your selections.
3. If the No Trouble Found menu displays, go to Step 0410-12.

• **Step 0410-12**

If you changed the service processor or network settings, as instructed in previous MAPs, restore the settings to the value they had prior to servicing the system. If you ran standalone diagnostics from CD-ROM, remove the standalone diagnostics CD-ROM from the system.

**Did you perform service on a RAID subsystem involving changing of the PCI RAID adapter cache card or changing the configuration?**

**Note:** This does not refer to the PCI-X RAID adapter or cache.

**No** Go to Step 0410-14.

**Yes** Go to Step 0410-13.

• **Step 0410-13**

Use the **Recover Options** selection to resolve the RAID configuration. To do this, do the following:

1. On the PCI SCSI Disk Array Manager screen, select **Recovery options**.
2. If a previous configuration exists on the replacement adapter, this must be cleared. Select **Clear PCI SCSI Adapter Configuration**. Press F3.
3. On the Recovery Options screen, select **Resolve PCI SCSI RAID Adapter Configuration**.

4. On the Resolve PCI SCSI RAID Adapter Configuration screen, select **Accept Configuration on Drives**.
  5. On the PCI SCSI RAID Adapter selections menu, select the adapter that you changed.
  6. On the next screen, press Enter.
  7. When you get the Are You Sure selection menu, press Enter to continue.
  8. You should get an OK status message when the recover is complete. If you get a Failed status message, verify that you selected the correct adapter, then repeat this procedure. When recover is complete, exit the operating system.
  9. Go to Step 0410-14.
- **Step 0410-14**  
If the system you are servicing has a management console, go to the end-of-call procedure for systems with Service Focal Point.

This completes the repair; return the server to the customer.

### Linux server or Linux partition symptoms

Use the following tables to find the symptom you are experiencing. If you cannot find your symptom, contact your next level of support.

Choose the description that best describes your situation:

- You have a service action to perform
- Integrated Virtualization Manager (IVM) Problem
- An LED is not operating as expected
- Control (operator) panel problems
- Reference codes
- Management consoles
- There is a display or monitor problem (for example, distortion or blurring)
- Power and cooling problems
- Other symptoms or problems

#### You have a service action to perform

Symptom	What you should do:
You have an open service event in the service action event log.	Go to Starting a repair action.
You have parts to exchange or a corrective action to perform.	<ol style="list-style-type: none"> <li>1. Go to the remove and replace procedures for your specific system.</li> <li>2. Go to Close of call procedure.</li> </ol>
You need to verify that a part exchange or corrective action corrected the problem.	<ol style="list-style-type: none"> <li>1. Go to Verifying the repair.</li> <li>2. Go to the Close of call procedure.</li> </ol>
You need to verify correct system operation.	<ol style="list-style-type: none"> <li>1. Go to Verifying the repair.</li> <li>2. Go to the Close of call procedure.</li> </ol>

#### Integrated Virtualization Manager (IVM) Problem

Symptom	What you should do:
The partitions do not activate - partition configuration is damaged	Restore the partition configuration data using IVM. See Backing up and restoring partition data

Symptom	What you should do:
Other partition problems when the server is managed by IVM	Perform Troubleshooting with the Integrated Virtualization Manager

### An LED is not operating as expected

Symptom	What you should do:
The system attention LED on the control panel is on.	Go to “Linux fast-path problem isolation” on page 58.
The rack identify LED does not operate properly.	Go to the “Linux fast-path problem isolation” on page 58.
The rack indicator LED does not turn on, but a drawer identify LED is on.	<ol style="list-style-type: none"> <li>1. Make sure the rack indicator LED is properly mounted to the rack.</li> <li>2. Make sure that the rack identify LED is properly cabled to the bus bar on the rack and to the drawer identify LED connector.</li> <li>3. Replace the following parts one at a time: <ul style="list-style-type: none"> <li>• Rack LED to bus bar cable</li> <li>• LED bus bar to drawer cable</li> <li>• LED bus bar</li> </ul> </li> <li>4. Contact your next level of support</li> </ol>

### Control (operator) panel problems

Symptom	What you should do:
01 does not appear in the upper-left corner of the operator panel display after the power is connected and before pressing the power-on button. Other symptoms appear in the operator panel display or LEDs before the power on button is pressed.	Go to Power problems.

Symptom	What you should do:
<p>A bouncing or scrolling ball (moving row of dots) remains on the operator panel display, or the operator panel display is filled with dashes or blocks.</p>	<p>Verify that the operator panel connections to the system backplane are connected and properly seated. Also, reseal the Service Processor card.</p> <p>If a client computer (such as a PC with Ethernet capability and a Web browser) is available, connect it to the service processor in the server that is displaying the symptom.</p> <p>To connect a personal computer with Ethernet capability and a Web browser, or an ASCII terminal, to access the Advanced System Management Interface (ASMI), go to Managing your server using the Advanced System Management Interface.</p> <ul style="list-style-type: none"> <li>• If you can successfully access the ASMI, replace the operator panel assembly. Refer to Finding parts, locations, and addresses to determine the part number and correct exchange procedure.</li> <li>• If you cannot successfully access the ASMI, replace the service processor. Refer to Finding parts, locations, and addresses to determine the part number and correct exchange procedure.</li> </ul> <p>If you do not have a PC or ASCII terminal, replace the following one at a time (go to Finding parts, locations, and addresses to determine the part number and correct exchange procedure):</p> <ol style="list-style-type: none"> <li>1. Operator panel assembly.</li> <li>2. Service processor.</li> </ol>
<p>You have a blank display on the operator panel. Other LEDs on the operator panel appear to behave normally.</p>	<p>Verify that the operator panel connections to the system backplane are connected and properly seated.</p> <p>If a client computer (such as a PC with Ethernet capability and a Web browser) is available, connect it to the service processor in the server that is displaying the symptom.</p> <p>To connect a personal computer with Ethernet capability and a Web browser, or an ASCII terminal, to access the Advanced System Management Interface (ASMI), go to Managing your server using the Advanced System Management Interface.</p> <ul style="list-style-type: none"> <li>• If you can successfully access the ASMI, replace the operator panel assembly. Refer to Finding parts, locations, and addresses to determine the part number and correct exchange procedure.</li> <li>• If you cannot successfully access the ASMI, replace the service processor. Refer to Finding parts, locations, and addresses to determine the part number and correct exchange procedure.</li> </ul> <p>If you do not have a PC or ASCII terminal, replace the following one at a time (go to Finding parts, locations, and addresses to determine the part number and correct exchange procedure):</p> <ol style="list-style-type: none"> <li>1. Control (operator) panel assembly.</li> <li>2. Service processor.</li> </ol>



Symptom	What you should do:
You have a blank display on the operator panel. Other LEDs on the operator panel are off.	Go to Power problems.

## Reference codes

Symptom	What you should do:
You have an 8-digit error code displayed.	<p>Look up the reference code in the Reference codes section of the information center.</p> <p><b>Note:</b> If the repair for this code does not involve replacing a FRU (for instance, running an AIX command that fixes the problem or changing a hot-pluggable FRU), then update the AIX error log after the problem is resolved by performing the following steps:</p> <ol style="list-style-type: none"> <li>1. In the online diagnostics, select <b>Task SelectionLog Repair Action</b>.</li> <li>2. Select resource <b>sysplanar0</b>.</li> </ol> <p>On systems with a fault indicator LED, this changes the "fault indicator" LED from the "fault" state to the "normal" state.</p>
The system stops with an 8-digit error code displayed when booting.	Look up the reference code in the Reference codes section of the information center.
The system stops and a 4-digit code displays on the control panel that does <b>not</b> begin with 0 or 2.	Look up the reference code in the Reference codes section of the information center.
The system stops and a 4-digit code displays on the control panel that begins with 0 or 2 is displayed in the operator panel display.	Record SRN 101-xxxx where xxxx is the 4-digit code displayed in the control panel, then look up this reference code in the Reference codes section of the information center. Follow the instructions given in the Description and Action column for your SRN.
The system stops and a 3-digit number displays on the control panel.	<p>Add 101- to the left of the three digits to create an SRN, then look up this reference code in the Reference codes section of the information center. Follow the instructions given in the Description and Action column for your SRN.</p> <p>If there is a location code displayed under the 3-digit error code, look at the location to see if it matches the failing component that the SRN pointed to. If they do not match, perform the action given in the error code table. If the problem still exists, then replace the failing component from the location code.</p> <p>If there is a location code displayed under the 3-digit error code, record the location code.</p> <p>Record SRN 101-xxx, where xxx is the 3-digit number displayed in the operator panel display, then look up this reference code in the Reference codes section of the information center. Follow the instructions given in the Description and Action column for your SRN.</p>

## Management consoles

Symptom	What you should do:
<p>The management console cannot be used to manage a managed system, or the connection to the managed system is failing.</p>	<p>If the managed system is operating normally (no error codes or other symptoms), the management console might have a problem, or the connection to the managed system might be damaged or incorrectly cabled. Do the following:</p> <ol style="list-style-type: none"> <li>1. Check the connections between the management console and the managed system. Correct any cabling errors if found. If another cable is available, connect it in place of the existing cables and refresh the management console interface. You may have to wait up to 30 seconds for the managed system to reconnect.</li> <li>2. Verify that any connected management console is connected to the managed system by checking the Management Environment of the management console.  <b>Note:</b> The managed system must have power connected and the system running, or waiting for a power-on instruction (01 is in the upper-left corner of the operator panel.)                      If the managed system does not appear in the Navigation area of the management console Management Environment, the management console or the connection to the managed system might be failing.</li> <li>3. Go to the                             <ul style="list-style-type: none"> <li>• For HMC: Managing the HMC section.</li> <li>• For SDMC: Managing the SDMC section.</li> </ul> </li> <li>4. There might be a problem with the service processor card or the system backplane.                      If you cannot fix the problem using the HMC tests in the Managing the HMC section:                      If you cannot fix the problem using the SDMC tests in the Managing the SDMC section:                             <ol style="list-style-type: none"> <li>a. Replace the service processor card. Refer to the remove and replace procedures for your specific system.</li> <li>b. Replace the management console system backplane. Refer to the remove and replace procedures for your specific system.</li> </ol> </li> </ol>
<p>The management console (HMC only) cannot call out using the attached modem and the customer's telephone line.</p>	<p>If the managed system is operating normally (no error codes or other symptoms), the management console might have a problem, or the connection to the modem and telephone line might have a problem. Do the following:</p> <ol style="list-style-type: none"> <li>1. Check the connections between the management console, the modem, and the telephone line. Correct any cabling errors, if found.</li> <li>2. Go to the Managing your server using the Hardware Management Console section.</li> </ol>

## There is a display problem (for example, distortion or blurring)

Symptom	What you should do:
All display problems.	<ol style="list-style-type: none"> <li>1. If you are using the management console: <ul style="list-style-type: none"> <li>• Hardware Management Console: Go to the Managing the HMC section.</li> <li>• Systems Director Management Console: Go to the Managing the SDMC section.</li> </ul> </li> <li>2. If you are using a graphics display: <ol style="list-style-type: none"> <li>a. Go to the problem determination procedures for the display.</li> <li>b. If you do not find a problem: <ul style="list-style-type: none"> <li>• Replace the graphics display adapter. Refer to the remove and replace procedures for your specific system.</li> <li>• Replace the backplane into which the graphics display adapter is plugged. Refer to the remove and replace procedures for your specific system.</li> </ul> </li> </ol> </li> </ol>
There appears to be a display problem (distortion, blurring, and so on)	Go to the problem determination procedures for the display.

## Power and cooling problems

Symptom	What you should do:
The system will not power on and no error codes are available.	Go to Power problems.
The power LEDs on the operator panel and the power supply do not come on or stay on.	<ol style="list-style-type: none"> <li>1. Check the service processor error log.</li> <li>2. Go to Power problems.</li> </ol>
The power LEDs on the operator panel and the power supply come on and stay on, but the system does not power on.	<ol style="list-style-type: none"> <li>1. Check the service processor error log.</li> <li>2. Go to Power problems.</li> </ol>
A rack or a rack-mounted unit will not power on.	<ol style="list-style-type: none"> <li>1. Check the service processor error log.</li> <li>2. Go to Power problems.</li> </ol>
The cooling fan(s) do not come on, or come on but do not stay on.	<ol style="list-style-type: none"> <li>1. Check the service processor error log.</li> <li>2. Go to Power problems.</li> </ol>
The system attention LED on the operator panel is on and there is no error code displayed.	<ol style="list-style-type: none"> <li>1. Check the service processor error log.</li> <li>2. Go to Power problems.</li> </ol>

## Other symptoms or problems

Symptom	What you should do:
The system stopped and a code is displayed on the operator panel.	Go to Starting a repair action.
01 is displayed in the upper-left corner of the operator panel and the fans are off.	The service processor is ready. The system is waiting for power-on. Boot the system. If the boot is unsuccessful, and the system returns to the default display (indicated by 01 in the upper-left corner of the operator panel), go to MAP 0020: Problem determination procedure.

Symptom	What you should do:
The operator panel displays STBY.	The service processor is ready. The server was shut down by the operating system and is still powered on. This condition can be requested by a privileged system user with no faults. Go to Starting a repair action. <b>Note:</b> See the service processor error log for possible operating system fault indications.
All of the system POST indicators are displayed on the firmware console, the system pauses and then restarts. The term <i>POST indicators</i> refers to the device mnemonics (the words memory, keyboard, network, scsi, and speaker) that appear on the firmware console during the power-on self-test (POST).	Go to Problems with loading and starting the operating system.
The system stops and all of the POST indicators are displayed on the firmware console. The term <i>POST indicators</i> refers to the device mnemonics (the words memory, keyboard, network, scsi, and speaker) that appear on the firmware console during the power-on self-test (POST).	Go to Problems with loading and starting the operating system.
The system stops and the message starting software please wait...is displayed on the firmware console.	Go to Problems with loading and starting the operating system.
The system does not respond to the password being entered or the system login prompt is displayed when booting in service mode.	<ol style="list-style-type: none"> <li>1. If the password is being entered from the management console: <ul style="list-style-type: none"> <li>• For Hardware Management Console (HMC): Go to the Managing the HMC.</li> <li>• For Systems Director Management Console (SDMC): Go to the Managing the SDMC.</li> </ul> </li> <li>2. If the password is being entered from a keyboard attached to the system, the keyboard or its controller may be faulty. In this case, replace these parts in the following order: <ol style="list-style-type: none"> <li>a. Keyboard</li> <li>b. Service processor</li> </ol> </li> </ol> <p>If the problem is fixed, go to "MAP 0410: Repair checkout" on page 46.</p>
The system stops with a prompt to enter a password.	Enter the password. You cannot continue until a correct password has been entered. When you have entered a valid password, go to the beginning of this table and wait for one of the other conditions to occur.
The system does not respond when the password is entered.	Go to Step 1020-2.
No codes are displayed on the operator panel within a few seconds of turning on the system. The operator panel is blank before the system is powered on.	Reseat the operator panel cable. If the problem is not resolved, replace in the following order: <ol style="list-style-type: none"> <li>1. Operator panel assembly. Refer to the remove and replace procedures for your specific system</li> <li>2. Service processor. Refer to the remove and replace procedures for your specific system.</li> </ol> <p>If the problem is fixed, go to "MAP 0410: Repair checkout" on page 46.</p> <p>If the problem is still not corrected, go to MAP 0020: Problem determination procedure.</p>

Symptom	What you should do:
The SMS configuration list or boot sequence selection menu shows more SCSI devices attached to a controller/adaptor than are actually attached.	<p>A device may be set to use the same SCSI bus ID as the control adapter. Note the ID being used by the controller/adaptor (this can be checked and/or changed through an SMS utility), and verify that no device attached to the controller is set to use that ID.</p> <p>If settings do not appear to be in conflict:</p> <ol style="list-style-type: none"> <li>1. Go to MAP 0020: Problem determination procedure.</li> <li>2. Replace the SCSI cable.</li> <li>3. Replace the device.</li> <li>4. Replace the SCSI adapter</li> </ol> <p><b>Note:</b> In a "twin-tailed" configuration where there is more than one initiator device (normally another system) attached to the SCSI bus, it may be necessary to use SMS utilities to change the ID of the SCSI controller or adapter.</p>
You suspect a cable problem.	Go to Adapters, Devices and Cables for Multiple Bus Systems.
You have a problem that does not prevent the system from booting. The operator panel is functional and the rack indicator LED operates as expected.	Go to MAP 0020: Problem determination procedure.
All other symptoms.	Go to MAP 0020: Problem determination procedure.
All other problems.	Go to MAP 0020: Problem determination procedure.
You do not have a symptom.	Go to MAP 0020: Problem determination procedure.
You have parts to exchange or a corrective action to perform.	<ol style="list-style-type: none"> <li>1. Go to Starting a repair action.</li> <li>2. Go to Close of call procedure.</li> </ol>
You need to verify that a part exchange or corrective action corrected the problem.	Go to "MAP 0410: Repair checkout" on page 46.
You need to verify correct system operation.	Go to "MAP 0410: Repair checkout" on page 46.
The system stopped. A POST indicator is displayed on the system console and an eight-digit error code is not displayed.	<p>If the POST indicator represents:</p> <ol style="list-style-type: none"> <li>1. Memory, go to PFW 1548: Memory and processor subsystem problem isolation procedure.</li> <li>2. Keyboard <ol style="list-style-type: none"> <li>a. Replace the keyboard.</li> <li>b. Replace the service processor, location: model dependent.</li> <li>c. Go to PFW 1548: Memory and processor subsystem problem isolation procedure.</li> </ol> </li> <li>3. Network, go to PFW 1548: Memory and processor subsystem problem isolation procedure.</li> <li>4. SCSI, go to PFW 1548: Memory and processor subsystem problem isolation procedure.</li> <li>5. Speaker <ol style="list-style-type: none"> <li>a. Replace the control panel. The location is model dependent; refer to Installing features.</li> <li>b. Replace the service processor. The location is model dependent.</li> <li>c. Go to PFW 1548: Memory and processor subsystem problem isolation procedure.</li> </ol> </li> </ol>

Symptom	What you should do:
The diagnostic operating instructions are displayed.	Go to MAP 0020: Problem determination procedure.
The system login prompt is displayed.	<p>If you are loading the diagnostics from a CD-ROM, you may not have pressed the correct key or you may not have pressed the key soon enough when you were trying to indicate a service mode IPL of the diagnostic programs. If this is the case, start again at the beginning of this step.</p> <p><b>Note:</b> Perform the system shutdown procedure before turning off the system.</p> <p>If you are sure you pressed the correct key in a timely manner, go to Step 1020-2.</p> <p>If you are loading diagnostics from a Network Installation Management (NIM) server, check for the following:</p> <ul style="list-style-type: none"> <li>• The bootlist on the client may be incorrect.</li> <li>• Cstate on the NIM server may be incorrect.</li> <li>• There may be network problems preventing you from connecting to the NIM server.</li> </ul> <p>Verify the settings and the status of the network. If you continue to have problems refer to Problems with loading and starting the operating system and follow the steps for network boot problems.</p>
The System Management Services (SMS) menu is displayed when you were trying to boot standalone diagnostics.	<p>If you are loading diagnostics from the CD-ROM, you may not have pressed the correct key when you were trying to indicate a service mode IPL of the diagnostic programs. If this is the case, try to boot the CD-ROM again and press the correct key.</p> <p>If you are sure you pressed the correct key, the device or media you are attempting to boot from may be faulty.</p> <ol style="list-style-type: none"> <li>1. Try to boot from an alternate boot device connected to the same controller as the original boot device. If the boot succeeds, replace the original boot device (for removable media devices, try the media first). If the boot fails, go to problems with loading and starting the operating system.</li> <li>2. Go to PFW 1548: Memory and processor subsystem problem isolation procedure.</li> </ol>
The SMS boot sequence selection menu or remote IPL menu does not show all of the bootable devices in the partition or system.	If an AIX or Linux partition is being booted, verify that the devices that you expect to see in the list are assigned to this partition. If they are not, use the management console to reassign the required resources. If they are assigned to this partition, go to Problems with loading and starting the operating system to resolve the problem.

### Linux fast-path problem isolation:

Use this information to help you isolate a hardware problem when using the Linux operating system.

### Notes:

1. If the server or partition has an external SCSI disk drive enclosure attached and you have not been able to find a reference code or other symptom, go to “MAP 2010: 7031-D24 or 7031-T24 START” on page 83
2. If you are servicing an SP system, go to the Start of Call MAP 100 in the *SP System Service Guide*.
3. If you are servicing a clustered server, go to the Start of Call MAP 100 in the *Clustered Installation and Service Guide*.
4. If you are servicing a clustered server that has InfiniBand switch networks, go to IBM Clusters with the InfiniBand Switch.



### Linux fast path table

Locate the problem in the following table and then go to the action indicated for the problem.

Symptoms	Action
You have an eight-digit reference code.	Go to Reference codes, and do the listed action for the eight-digit reference code.
You are trying to isolate a problem on a Linux server or a partition that is running Linux.	<b>Note:</b> This procedure is used to help display an eight-digit reference code using system log information. Before using this procedure, if you are having a problem with a media device such as a tape or DVD-ROM drive, continue through this table and follow the actions for the appropriate device. Go to “Linux problem isolation procedure” on page 62.
You suspect a problem with your server but you do not have any specific symptom.	Go to MAP 0020: Problem determination procedure for problem determination procedures.
You need to run the eServer™ standalone diagnosticsAIX and Linux diagnostics and service aids	Go to AIX and Linux diagnostics and service aids
<b>SRNs</b>	
You have an SRN.	Look up the SRN in the Service request numbers and do the listed action.
An SRN is displayed when running the eServer standalone diagnostics.	<ol style="list-style-type: none"> <li>1. Record the SRN and location code.</li> <li>2. Look up the SRN in the Service request numbers and do the listed action.</li> </ol>
<b>Tape Drive Problems</b>	
You suspect a tape drive problem.	<ol style="list-style-type: none"> <li>1. Refer to the tape drive documentation and clean the tape drive.</li> <li>2. Refer to the tape drive documentation and do any listed problem determination procedures.</li> <li>3. Go to MAP 0020: Problem determination procedure for problem determination procedures.</li> </ol> <p><b>Note:</b> Information on tape cleaning and tape-problem determination is normally either in the tape drive operator guide or the system operator guide.</p>
<b>Optical Drive Problems</b>	
You suspect a optical drive problem.	<ol style="list-style-type: none"> <li>1. Refer to the optical documentation and do any listed problem determination procedures.</li> <li>2. Before servicing a optical Drive ensure that it is not in use and that the power connector is correctly attached to the drive. If the load or unload operation does not function, replace the optical drive.</li> <li>3. Go to MAP 0020: Problem determination procedure for problem determination procedures.</li> </ol> <p><b>Note:</b> If the optical has its own user documentation, follow any problem determination for the optical drive.</p>

Symptoms	Action
<b>SCSI Disk Drive Problems</b>	
<p>You suspect a disk drive problem.</p> <p>Disk problems are logged in the error log and are analyzed when the standalone disk diagnostics are run in problem determination mode. Problems are reported if the number of errors is above defined thresholds.</p>	<p>Go to MAP 0020: Problem determination procedure for problem determination procedures.</p>
<b>Diskette Drive Problems</b>	
<p>You suspect a diskette drive problem.</p>	<p>1. Go to MAP 0020: Problem determination procedure for problem determination procedures.</p>
<b>Token-Ring Problems</b>	
<p>You suspect a token-ring adapter or network problem.</p>	<p>1. Check with the network administrator for known problems.</p> <p>2. Go to MAP 0020: Problem determination procedure for problem determination procedures.</p>
<b>Ethernet Problems</b>	
<p>You suspect an Ethernet adapter or network problem.</p>	<p>1. Check with the network administrator for known problems.</p> <p>2. Go to MAP 0020: Problem determination procedure for problem determination procedures.</p>
<b>Display Problems</b>	
<p>You suspect a display problem.</p>	<p>1. If your display is connected to a KVM switch, go to Troubleshooting the keyboard, video, and mouse (KVM) switch for the 1x8 and 2x8 console manager. If you are still having display problems after performing the KVM switch procedures, come back here and continue with step 2.</p> <p>2. If you are using the management console:</p> <ul style="list-style-type: none"> <li>• For Hardware Management Console: Go to the Managing your server using the Hardware Management Console section.</li> <li>• For Systems Director Management Console: Go to the Managing your server using the Systems Director Management Console section.</li> </ul> <p>3. If you are using a graphics display:</p> <p>a. Go to the problem determination procedures for the display.</p> <p>b. If you do not find a problem:</p> <ul style="list-style-type: none"> <li>• Replace the graphics display adapter. Refer to the remove and replace procedures for your specific system..</li> <li>• Replace the backplane into which the graphics display adapter is plugged. Refer to the remove and replace procedures for your specific system.</li> </ul>
<b>Keyboard or Mouse</b>	



Symptoms	Action
You suspect a keyboard or mouse problem.	<p>If your keyboard is connected to a KVM switch, go to Troubleshooting the keyboard, video, and mouse (KVM) switch for the 1x8 and 2x8 console manager. If you are still having keyboard problems after performing the KVM switch procedures, come back here and continue to the next paragraph. Go to MAP 0020: Problem determination procedure for problem determination procedures.</p> <p>If you are unable to run diagnostics because the system does not respond to the keyboard, replace the keyboard or system planar.</p> <p><b>Note:</b> If the problem is with the keyboard it could be caused by the mouse device. To check, unplug the mouse and then recheck the keyboard. If the keyboard works, replace the mouse.</p>
<b>System Messages</b>	
A System Message is displayed.	<ol style="list-style-type: none"> <li>1. If the message describes the cause of the problem, attempt to correct it.</li> <li>2. Look for another symptom to use.</li> </ol>
<b>System Hangs or Loops When Running the OS or Diagnostics</b>	
The system hangs in the same application.	<p>Suspect the application. To check the system:</p> <ol style="list-style-type: none"> <li>1. Power off the system.</li> <li>2. Go to MAP 0020: Problem determination procedure for problem determination procedures.</li> <li>3. If an SRN is displayed at anytime, record the SRN and location code.</li> <li>4. Look up the SRN in the Service request numbers and do the listed action.</li> </ol>
The system hangs in various applications.	<ol style="list-style-type: none"> <li>1. Power off the system.</li> <li>2. Go to MAP 0020: Problem determination procedure for problem determination procedures.</li> <li>3. If an SRN is displayed at anytime, record the SRN and location code.</li> <li>4. Look up the SRN in the Service request numbers and do the listed action.</li> </ol>
The system hangs when running diagnostics.	Replace the resource that is being tested.
<b>Exchanged FRUs Did Not Fix the Problem</b>	
A FRU or FRUs you exchanged did not fix the problem.	Go to MAP 0020: Problem determination procedure.
<b>RAID Problems</b>	
You suspect a problem with a RAID.	<p>A potential problem with a RAID adapter exists. Run diagnostics on the RAID adapter. Refer to the <i>RAID Adapters User's Guide and Maintenance Information</i>, refer to IBM eServer pSeries Information Center (<a href="http://publib16.boulder.ibm.com/pseries/en_US/infocenter/base">http://publib16.boulder.ibm.com/pseries/en_US/infocenter/base</a>).</p> <p>If the RAID adapter is a PCI-X RAID adapter, refer to the <i>PCI-X SCSI RAID Controller Reference Guide for AIX</i> in the IBM eServer pSeries Information Center (<a href="http://publib16.boulder.ibm.com/pseries/en_US/infocenter/base">http://publib16.boulder.ibm.com/pseries/en_US/infocenter/base</a>).</p> 
<b>SSA Problems</b>	
You suspect an SSA problem.	<p>A potential problem with an SSA adapter exists. Run diagnostics on the SSA adapter. If the system has external SSA drives, refer to the <i>SSA Adapters User's Guide and Maintenance Information</i> (IBM eServer pSeries Information Center (<a href="http://publib16.boulder.ibm.com/pseries/en_US/infocenter/base">http://publib16.boulder.ibm.com/pseries/en_US/infocenter/base</a>))</p>  <p>, or the service guide for your disk subsystem.</p>
<b>You Cannot Find the Symptom in This Table</b>	

Symptoms	Action
All other problems.	Go to MAP 0020: Problem determination procedure.

*Linux problem isolation procedure:*

Use this procedure when servicing a Linux partition or a server that has Linux as its only operating system.

## DANGER

**When working on or around the system, observe the following precautions:**

**Electrical voltage and current from power, telephone, and communication cables are hazardous. To avoid a shock hazard:**

- **Connect power to this unit only with the IBM provided power cord. Do not use the IBM provided power cord for any other product.**
- **Do not open or service any power supply assembly.**
- **Do not connect or disconnect any cables or perform installation, maintenance, or reconfiguration of this product during an electrical storm.**
- **The product might be equipped with multiple power cords. To remove all hazardous voltages, disconnect all power cords.**
- **Connect all power cords to a properly wired and grounded electrical outlet. Ensure that the outlet supplies proper voltage and phase rotation according to the system rating plate.**
- **Connect any equipment that will be attached to this product to properly wired outlets.**
- **When possible, use one hand only to connect or disconnect signal cables.**
- **Never turn on any equipment when there is evidence of fire, water, or structural damage.**
- **Disconnect the attached power cords, telecommunications systems, networks, and modems before you open the device covers, unless instructed otherwise in the installation and configuration procedures.**
- **Connect and disconnect cables as described in the following procedures when installing, moving, or opening covers on this product or attached devices.**

**To Disconnect:**

1. Turn off everything (unless instructed otherwise).
2. Remove the power cords from the outlets.
3. Remove the signal cables from the connectors.
4. Remove all cables from the devices

**To Connect:**

1. Turn off everything (unless instructed otherwise).
2. Attach all cables to the devices.
3. Attach the signal cables to the connectors.
4. Attach the power cords to the outlets.
5. Turn on the devices.

(D005)

These procedures define the steps to take when servicing a Linux partition or a server that has Linux as its only operating system.

Before continuing with this procedure it is recommended that you review the additional software available to enhance your Linux solutions. This software is available at: Linux on POWER® Web site at

<http://techsupport.services.ibm.com/server/lopdiaqs> .

**Note:** If the server is attached to a management console, the various codes that might display on the management console are all listed as reference codes by Service Focal Point (SFP). Use the following table to help you identify the type of error information that might be displayed when you are using this procedure.

Number of digits in reference code	Reference code	Name or code type
Any	Contains # (pound sign)	Menu goal
Any	Contains - (hyphen)	Service request number (SRN)
5	Does not contain # or -	SRN
8	Does not contain # or -	Service reference code (SRC)

1. Is the server managed by a management console that is running Service Focal Point (SFP)?

**No** Go to step 3.

**Yes** Go to step 2.

2. Servers with Service Focal Point

Look at the service action event log in SFP for errors. Focus on those errors with a timestamp near the time at which the error occurred. Follow the steps indicated in the error log entry to resolve the problem. If the problem is not resolved, continue with step 3.

3. Look for and record all reference code information or software messages on the operator panel and in the service processor error log (which is accessible by viewing the ASMI menus).
4. Choose a Linux partition that is running correctly (preferably the partition with the problem).

**Is Linux usable in any partition with Linux installed?**

**No** Go to step 11 on page 67.

**Yes** Go to step 5.

5. Do the following steps:

**Attention:** Items 5 through 16 on page 68 must be performed on a server or partition running the Linux operating system.

- a. Determine if there is a file named **platform** under **/var/log** directory of the server or partition. Log into the server or partition as the root user and enter the following command:

```
ls -l /var/log/platform
```

Does the **/var/log/platform** file exist?

**No** Continue with substep 5b.

**Yes** Go to substep 5c on page 64.

- b. Record that, for this Linux partition, you performed substep 5b of 5 for later steps. Examine the Linux system log by entering the following command:

```
cat /var/log/messages |grep RTAS |more
```

Linux run-time RTAS error messages are logged in the **messages** file under **/var/log**. The following is an example of the Linux system RTAS error log messages.

```
Aug 27 18:13:41 rasler kernel: RTAS: ----- event-scan begin -----
Aug 27 18:13:41 rasler kernel: RTAS: Location Code: U0.1-P1-C1
Aug 27 18:13:41 rasler kernel: RTAS: WARNING: (FULLY RECOVERED) type: INTERN_DEV_FAIL
Aug 27 18:13:41 rasler kernel: RTAS: initiator: UNKNOWN target: UNKNOWN
Aug 27 18:13:41 rasler kernel: RTAS: Status: predictive new
Aug 27 18:13:41 rasler kernel: RTAS: Date/Time: 20020827 18134000
Aug 27 18:13:41 rasler kernel: RTAS: CPU Failure
Aug 27 18:13:41 rasler kernel: RTAS: CPU id: 0
Aug 27 18:13:41 rasler kernel: RTAS: Failing element: 0x0000
Aug 27 18:13:41 rasler kernel: RTAS: A reboot of the system may correct the problem
Aug 27 18:13:41 rasler kernel: RTAS: ----- event-scan end -----
```

**Did you find any RTAS error log messages that are similar to the above messages?**

**No** Go to Running the online and stand-alone diagnostics and run the eServer standalone diagnostics on the server or partition. If you receive a reference code go to the Reference codes. If you cannot determine the problem using the diagnostic programs, contact your next level of support.

**Yes** Go to step 6 on page 66.

- c. Record that for this Linux partition, you performed substep 5c of 5 on page 63 for later steps.

Use the following command to list diagela messages recorded in the Linux system log:

```
cat /var/log/platform |grep diagela |more
```

Linux run-time diagela error messages are logged in the **platform** file under **/var/log**.

The following is an example of the Linux system error log diagela messages.

```
Aug 13 09:38:45 larry diagela: 08/13/2003 09:38:44
Aug 13 09:38:45 larry diagela: Automatic Error Log Analysis has detected a problem.
Aug 13 09:38:45 larry diagela: Aug 13 09:38:45 larry diagela: The Service Request
Number(s)/Probable Cause(s)
Aug 13 09:38:45 larry diagela: (causes are listed in descending order of probability):
Aug 13 09:38:45 larry diagela:
Aug 13 09:38:45 larry diagela: 651-880: The CEC or SPCN reported an error. Report the
SRN and the following reference and physical location codes to your service provider.
Aug 13 09:38:45 larry diagela: Location: n/a FRU: n/a Ref-Code: B1004699
Aug 13 09:38:45 larry diagela:
Aug 13 09:38:45 larry diagela: Analysis of Error log sequence number: 3
Aug 29 07:13:04 larry diagela: 08/29/2003 07:13:04
Aug 29 07:13:04 larry diagela: Automatic Error Log Analysis has detected a problem.
Aug 29 07:13:04 larry diagela:
Aug 29 07:13:04 larry diagela: The Service Request Number(s)/Probable Cause(s)
Aug 29 07:13:04 larry diagela: (causes are listed in descending order of probability):
Aug 29 07:13:04 larry diagela:
Aug 29 07:13:04 larry diagela: 651-880: The CEC or SPCN reported an error. Report the
SRN and the following reference and physical location codes to your service provider.
Aug 29 07:13:04 larry diagela: Location: U0.1-F4 FRU: 09P5866 Ref-Code: 10117661
Aug 29 07:13:04 larry diagela:
Aug 29 07:13:04 larry diagela: Analysis of /var/log/platform sequence number: 24
Sep 4 06:00:55 larry diagela: 09/04/2003 06:00:55
Sep 4 06:00:55 larry diagela: Automatic Error Log Analysis reports the following:
Sep 4 06:00:55 larry diagela:
Sep 4 06:00:55 larry diagela: 651204 ANALYZING SYSTEM ERROR LOG
Sep 4 06:00:55 larry diagela: A loss of redundancy on input power was detected.
Sep 4 06:00:55 larry diagela:
Sep 4 06:00:55 larry diagela: Check for the following:
Sep 4 06:00:55 larry diagela: 1. Loose or disconnected power source connections.
Sep 4 06:00:55 larry diagela: 2. Loss of the power source.
Sep 4 06:00:55 larry diagela: 3. For multiple enclosure systems, loose or
Sep 4 06:00:55 larry diagela: disconnected power and/or signal connections
Sep 4 06:00:55 larry diagela: between enclosures.
Sep 4 06:00:55 larry diagela:
Sep 4 06:00:55 larry diagela: Supporting data:
Sep 4 06:00:55 larry diagela: Ref. Code: 10111520
Sep 4 06:00:55 larry diagela: Location Codes: P1 P2
Sep 4 06:00:55 larry diagela:
Sep 4 06:00:55 larry diagela: Analysis of /var/log/platform sequence number: 13
```

- d. Also use the following command to list RTAS messages recorded in the Linux system log:

```
cat /var/log/platform |grep RTAS |more
```

Linux RTAS error messages are logged in the **platform** file under **/var/log**. The following is an example of RTAS messages in the Linux system error log.

```

Aug 27 12:16:33 larry kernel: RTAS: 15 ----- RTAS event begin -----
Aug 27 12:16:33 larry kernel: RTAS 0: 04440040 000003f8 96008508 19155800
Aug 27 12:16:33 larry kernel: RTAS 1: 20030827 00000001 20000000 00000000
Aug 27 12:16:33 larry kernel: RTAS 2: 00000000 00000000 00000000 00000000
Aug 27 12:16:33 larry kernel: RTAS 3: 49424d00 55302e31 2d463400 00503034
Aug 27 12:16:33 larry kernel: RTAS 4: 10117661 04a0005d 10110000 00000000
Aug 27 12:16:33 larry kernel: RTAS 5: 00007701 000000e0 00000003 000000e3
Aug 27 12:16:33 larry kernel: RTAS 6: 00000000 01000000 00000000 31303131
Aug 27 12:16:33 larry kernel: RTAS 7: 37363631 20202020 20202020 55302e31
Aug 27 12:16:33 larry kernel: RTAS 8: 2d463420 20202020 20202020 03705a39
Aug 27 12:16:33 larry kernel: RTAS 9: 00000000 00000000 00000000 00000000
Aug 27 12:16:33 larry kernel: RTAS 10: 00000000 00000000 00000000 00000000
Aug 27 12:16:33 larry kernel: RTAS 11: 00000000 00000000 00000000 00000000
Aug 27 12:16:33 larry kernel: RTAS 12: 00000000 00000000 00000000 00000000
Aug 27 12:16:33 larry kernel: RTAS 13: 00000000 00000000 00000000 00000000
Aug 27 12:16:33 larry kernel: RTAS 14: 00000000 00000000 00000000 00000000
Aug 27 12:16:33 larry kernel: RTAS 15: 00000000 00000000 00000000 00000000
Aug 27 12:16:33 larry kernel: RTAS 16: 00000000 00000000 00000000 00000000
Aug 27 12:16:33 larry kernel: RTAS 17: 00000000 00000000 00000000 00000000
Aug 27 12:16:33 larry kernel: RTAS 18: 00000000 00000000 00000000 00000000
Aug 27 12:16:33 larry kernel: RTAS 19: 00000000 00000000 00000000 00000000
Aug 27 12:16:33 larry kernel: RTAS 20: 00000000 00000000 00000000 00000000
Aug 27 12:16:33 larry kernel: RTAS 21: 00000000 00000000 00000000 00000000
Aug 27 12:16:33 larry kernel: RTAS 22: 00000000 00000000 00000000 00000000
Aug 27 12:16:33 larry kernel: RTAS 23: 00000000 00000000 00000000 00000000
Aug 27 12:16:33 larry kernel: RTAS 24: 00000000 00000000 00000000 00000000
Aug 27 12:16:33 larry kernel: RTAS 25: 00000000 00000000 00000000 00000000
Aug 27 12:16:33 larry kernel: RTAS 26: 00000000 00000000 00000000 00000000
Aug 27 12:16:33 larry kernel: RTAS 27: 00000000 00000000 00000000 00000000
Aug 27 12:16:33 larry kernel: RTAS 28: 00000000 00000000 00000000 00000000
Aug 27 12:16:33 larry kernel: RTAS 29: 00000000 00000000 00000000 00000000
Aug 27 12:16:33 larry kernel: RTAS 30: 00000000 00000000 00000000 00000000
Aug 27 12:16:33 larry kernel: RTAS 31: 00000000 00000000 00000000 00000000
Aug 27 12:16:33 larry kernel: RTAS 32: 00000000 00000000 00000000 00000000
Aug 27 12:16:33 larry kernel: RTAS 33: 00000000 00000000 00000000 00000000
Aug 27 12:16:33 larry kernel: RTAS 34: 00000000 00000000 00000000 00000000
Aug 27 12:16:33 larry kernel: RTAS 35: 00000000 00000000 00000000 00000000
Aug 27 12:16:33 larry kernel: RTAS 36: 00000000 00000000 00000000 00000000
Aug 27 12:16:33 larry kernel: RTAS 37: 00000000 00000000 00000000 00000000
Aug 27 12:16:33 larry kernel: RTAS 38: 00000000 00000000 00000000 00000000
Aug 27 12:16:33 larry kernel: RTAS 39: 00000000 00000000 00000000 00000000
Aug 27 12:16:33 larry kernel: RTAS 40: 00000000 00000000 00000000 00000000
Aug 27 12:16:33 larry kernel: RTAS 41: 00000000 00000000 00000000 00000000
Aug 27 12:16:33 larry kernel: RTAS 42: 00000000 00000000 00000000 00000000
Aug 27 12:16:33 larry kernel: RTAS 43: 00000000 00000000 00000000 00000000
Aug 27 12:16:33 larry kernel: RTAS 44: 00000000 00000000 00000000 00000000
Aug 27 12:16:33 larry kernel: RTAS 45: 00000000 00000000 00000000 00000000

```

```

Aug 27 12:16:33 larry kernel: RTAS 46: 00000000 00000000 00000000 00000000
Aug 27 12:16:33 larry kernel: RTAS 47: 00000000 00000000 00000000 00000000
Aug 27 12:16:33 larry kernel: RTAS 48: 00000000 00000000 00000000 00000000
Aug 27 12:16:33 larry kernel: RTAS 49: 00000000 00000000 00000000 00000000
Aug 27 12:16:33 larry kernel: RTAS 50: 00000000 00000000 00000000 00000000
Aug 27 12:16:33 larry kernel: RTAS 51: 00000000 00000000 00000000 00000000
Aug 27 12:16:33 larry kernel: RTAS 52: 00000000 00000000 00000000 00000000
Aug 27 12:16:33 larry kernel: RTAS 53: 00000000 00000000 00000000 00000000
Aug 27 12:16:33 larry kernel: RTAS 54: 00000000 00000000 00000000 00000000
Aug 27 12:16:33 larry kernel: RTAS 55: 00000000 00000000 00000000 00000000
Aug 27 12:16:33 larry kernel: RTAS 56: 00000000 00000000 00000000 00000000
Aug 27 12:16:33 larry kernel: RTAS 57: 00000000 00000000 00000000 00000000
Aug 27 12:16:33 larry kernel: RTAS 58: 00000000 00000000 00000000 00000000
Aug 27 12:16:33 larry kernel: RTAS 59: 00000000 00000000 00000000 00000000
Aug 27 12:16:33 larry kernel: RTAS 60: 00000000 00000000 00000000 00000000
Aug 27 12:16:33 larry kernel: RTAS 61: 00000000 00000000 00000000 00000000
Aug 27 12:16:33 larry kernel: RTAS 62: 00000000 00000000 00000000 00000000
Aug 27 12:16:33 larry kernel: RTAS 63: 00000000 00000000 00000000 00020000
Aug 27 12:16:33 larry kernel: RTAS: 15 ----- RTAS event end -----

```

Reference codes and location codes may appear as RTAS messages. The extended data is also provided in the form of an RTAS message. The extended data contains other reference code words that help in isolating the correct FRUs. The start of the extended data is marked, for example, by the line: Aug 27 12:16:33 larry kernel: RTAS: 15 ----- RTAS event begin -----

The number after the colon is a sequence number that correlates this data with any diagela data having the same sequence number. The end of the extended data is marked by the line:

```
Aug 27 12:16:33 larry kernel: RTAS: 15 ----- RTAS event end -----
```

with the same sequence number. Word 13 and word 19 are found in the RTAS messages. For example, to find word 13, first find the reference code in the left column of words of the extended data, 10117661. In this example, we find the reference code to the right of "RTAS 4:". This is also word 11. To get word 13, 10110000, simply count the words left-to-right, beginning at word 11.

6. If you performed substep 5b on page 63 of step 5 on page 63, then record any RTAS messages found in the Linux system log in step 5 on page 63. Or, if you performed substep 5c on page 64 of step 5 on page 63, then record any RTAS and diagela messages found in the Linux system log in step 5 on page 63, and also record any extended data found in the RTAS messages, especially word 13 and word 19. Ignore all other messages in the Linux system log.

If the system is configured with more than one logical partition with Linux installed, repeat step 5 on page 63 and step 6 for all logical partitions that have Linux installed.

7. If you performed substep 5c on page 64 of step 5 on page 63 for the current Linux partition, go to step 8 on page 67, and when asked in step 8 on page 67, do not record any RTAS messages from step 7 for the current Linux partition.

Examine the Linux boot (IPL) log by logging in to the system as the root user and entering the following command:

```
cat /var/log/boot.msg |grep RTAS |more
```

Linux boot (IPL) error messages are logged into the **boot.msg** file under **/var/log**. The following is an example of the Linux boot error log.



**No** Go to step 12.

**Yes** Go to the Linux fast-path problem isolation with each reference code that was recorded. Perform the indicated actions one at a time for each reference code until the problem has been corrected. If all recorded reference codes have been processed and the problem has not been corrected, go to step 12.

12. If no additional error information is available and the problem has not been corrected, do the following:

a. Shut down the system.

b. If a management console is not attached, see *Accessing the Advanced System Management Interface (ASMI)* for instructions to access the ASMI.

**Note:** The ASMI functions can also be accessed by using a personal computer connected to system port 1.

You need a personal computer (and cable, part number 62H4857) capable of connecting to system port 1 on the system unit. (The Linux login prompt cannot be seen on a personal computer connected to system port 1.) If the ASMI functions are not otherwise available, use the following procedure:

1) Attach the personal computer and cable to system port 1 on the system unit.

2) With 01 displayed in the operator panel, press a key on the virtual terminal on the personal computer. The service ASMI menus are available on the attached personal computer.

3) If the service processor menus are not available on the personal computer, perform the following steps:

a) Examine and correct all connections to the service processor.

b) Replace the service processor.

**Note:** The service processor might be contained on a separate card or board; in some systems, the service processor is built into the system backplane. Contact your next level of support for help before replacing a system backplane.

c. Examine the service processor error log. Record all reference codes and messages written to the service processor error log. Go to step 13.

13. Were any reference codes recorded in step 12?

**No** Go to step 21 on page 70.

**Yes** Go to the Linux fast-path problem isolation with each reference code or symptom you have recorded. Perform the indicated actions, one at a time, until the problem has been corrected. If all recorded reference codes have been processed and the problem has not been corrected, go to 21 on page 70.

14. Reboot the system and bring all partitions to the login prompt. If Linux is not usable in all partitions, go to step 18 on page 69.

15. Use the `lscfg` command to list all resources assigned to all partitions. Record the adapter and the partition for each resource.

16. To determine if any device(s) or adapter(s) are missing, compare the list of partition assignments, and resources found, to the customer's known configuration. Record the location of any missing devices. Also record any differences in the descriptions or the locations of devices.

You may also compare this list of resources that were found to a prior version of the device tree as follows:

**Note:** Every time that the partition is booted, the `update-device-tree` command is run and the device tree is stored in the `/var/lib/lsvpd/` directory in a file with the file name `device-tree-YYYY-MM-DD-HH:MM:SS`, where YYYY is the year, MM is the month, DD is the day, and HH, MM, and SS are the hour, minute and second, respectively, of the date of creation.



- At the command line, type the following:  
cd /var/lib/lsvpd/
- At the command line, type the following:  
lscfg -vpd db-2003-03-31-12:26:31.

This displays the device tree created on 03/31/2003 at 12:26:31.

The **diff** command offers a way to compare the output from a current **lscfg** command to the output from an older **lscfg** command. If the files names for the current and old device trees are **current.out** and **old.out**, respectively, type: diff old.out current.out. Any lines that exist in the old, but not in the current will be listed and preceded by a less-than symbol (<). Any lines that exist in the current, but not in the old will be listed and preceded by a greater-than symbol (>). Lines that are the same in both files are not listed; for example, files that are identical will produce no output from the diff command. If the location or description changes, lines preceded by both < and > will be output.

If the system is configured with more than one logical partition with Linux installed, repeat 15 on page 68 and 16 on page 68 for all logical partitions that have Linux installed.

17. Was the location of one and only one device recorded in 16 on page 68?

**No** If you previously answered Yes to step 17, return the system to its original configuration. This ends the procedure. Go to MAP 0410: Repair checkout.

If you did not previously answer Yes to step 17, go to step 18.

**Yes** Perform the following steps one at a time. Power off the system before performing each step. After performing each step, power on the system and go to step 14 on page 68.

- Check all connections from the system to the device.
- Replace the device (for example, tape or DASD)
- If applicable, replace the device backplane.
- Replace the device cable.
- Replace the adapter.
- If the adapter resides in an I/O drawer, replace the I/O backplane.
- If the device adapter resides in the CEC, replace the I/O riser card, or the CEC backplane in which the adapter is plugged.
- Call service support. Do not go to step 14 on page 68.

18. Does the system appear to stop or hang before reaching the login prompt or did you record any problems with resources in step 16 on page 68?

**Note:** If the system console or VTERM window is always blank, choose NO. If you are sure the console or VTERM is operational and connected correctly, answer the question for this step.

**No** Go to step 19.

**Yes** There may be a problem with an I/O device. Go to PFW1542: I/O problem isolation procedure. When instructed to boot the system, boot a full system partition.

19. Boot the eServer standalone diagnostics, refer to Running the online and stand-alone diagnostics. Run diagnostics in problem determination mode on all resources. Be sure to boot a full system partition. Ensure that diagnostics were run on all known resources. You may need to select each resource individually and run diagnostics on each resource one at a time.

**Did standalone diagnostics find a problem?**

**No** Go to step 23 on page 70.

**Yes** Go to the Reference codes and perform the actions for each reference code you have recorded. For each reference code not already processed in step 17, repeat this action until the problem has been corrected. Perform the indicated actions, one at a time. If all recorded reference codes have been processed and the problem has not been corrected, go to step 23 on page 70.

20. Does the system have Linux installed on one or more partitions?
- No** Return to the Start a repair action.
- Yes** Go to step 3 on page 63.
21. Were any location codes recorded in steps 3 on page 63, 6 on page 66, 8 on page 67, 10 on page 67, 11 on page 67, or 12 on page 68?
- No** Go to step 14 on page 68.
- Yes** Replace, one at a time, all parts whose location code was recorded in steps 3 on page 63, 6 on page 66, 8 on page 67, 10 on page 67, 11 on page 67, or 12 on page 68 that have not been replaced. Power off the system before replacing a part. After replacing the part, power on the system to check if the problem has been corrected. Go to step 22 when the problem has been corrected, or all parts in the location codes list have been replaced.
22. Was the problem corrected in step 21?
- No** Go to step 14 on page 68.
- Yes** Return the system to its original configuration. This ends the procedure. Go to MAP 0410: Repair checkout.
23. Were any other symptoms recorded in step 3 on page 63?
- No** Call support.
- Yes** Go to the Start a repair action with each symptom you have recorded. Perform the indicated actions for all recorded symptoms, one at a time, until the problem has been corrected. If all recorded symptoms have been processed and the problem has not been corrected, call your next level of support.

## Detecting problems

Provides information on using various tools and techniques to detect and identify problems.

### IBM i problem determination procedures

There are several tools you can use to determine a problem with an IBM i system or partition.

These include:

#### Searching the service action log:

Use this procedure to search for an entry in the service action log that matches the time, reference code, or resource of the reported problem.

1. On the command line, enter the start system service tools (STRSST) command. If you cannot get to system service tools (SST), use function 21 to get to dedicated service tools (DST).
2. On the Start Service Tools Sign On display, type in a user ID with QSRV authority and password.
3. Select **Start a Service Tool** → **Hardware Service Manager** → **Work with service action log**.
4. On the Select Timeframe display, change the From: **Date** and **Time** to a date and time prior to when the customer reported having the problem.
5. Search for an entry that matches one or more conditions of the problem:
  - Reference code
  - Resource
  - Time
  - Failing item list
6. Perform the following actions:
  - Choose **Display the failing item information** to display the service action log entry.
  - Use the **Display details** option to display part location information.

All new entries in the service action log represent problems that require a service action. It may be necessary to handle any problem in the log even if it does not match the original problem symptom. The information displayed in the date and time fields are the **Date** and **Time** for the first occurrence of the specific reference code for the resource displayed during the time range selected.

7. Did you find an entry in the service action log?

- **Yes:** Continue with the next step.
- **No:** Go to “Problems with noncritical resources” on page 140. **This ends the procedure.**

8. Does "See the service information system reference code tables for further problem isolation" appear near the top of the display or are there procedures in the field replaceable unit (FRU) list?

- **Yes:** Perform the following steps:
  - a. Go to the list of reference codes and use the reference code that is indicated in the log to find the correct reference code table and unit reference code.
  - b. Perform all actions in the Description/Action column before replacing failing items.

**Note:** When replacing failing items, the part numbers and locations found in the service action log entry should be used.

**This ends the procedure.**

- **No:** Display the failing item information for the service action log entry. Items at the top of the failing item list are more likely to fix the problem than items at the bottom of the list.

**Notes:**

- a. Some failing items are required to be replaced in groups until the problem is solved.
- b. Other failing items are flagged as mandatory exchange and must be replaced before the service action is complete, even if the problem appears to have been repaired.
- c. Use the **Part Action Code** field in the service action log display to determine if failing items are to be replaced in groups or as mandatory exchanges.
- d. Unless the **Part Action Code** of a FRU indicates group or mandatory exchange, exchange the failing items one at a time until the problem is repaired. Use the help function to determine the meaning of part action codes.

Continue with the next step.

9. Perform the following steps to help resolve the problem:

- a. To display location information, choose the function key for **Additional details**. If location information is available, go to Part locations and location codes for the model you are working on to determine what removal and replacement procedure to perform. To turn on the failing item's identify light, use the indicator on option.

**Note:** In some cases where the failing item does not contain a physical identify light, a higher level identify light is activated (for example, the planar or unit containing the failing item). The location information should then be used to locate the actual failing item.

- b. If the failing item is Licensed Internal Code, contact your next level of support for the correct fix to apply.

10. After exchanging an item, perform the following steps:

- a. Go to Verifying a repair.
- b. If the failing item indicator was turned on during the removal and replacement procedure, use the indicator off option to turn off the indicator.
- c. If all problems have been resolved for the partition, use the Acknowledge all errors function at the bottom of the service action log display.
- d. Close the log entry by selecting **Close a NEW entry** on the service action log Report display. **This ends the procedure.**

## Using the product activity log:

This procedure can help you learn how to use the product activity log (PAL).

1. To locate a problem, find an entry in the product activity log for the symptom you are seeing.

- a. On the command line, enter the Start System Service Tools command:

```
STRSST
```

If you cannot get to SST, select DST.

**Note:** Do not IPL the system or partition to get to DST.

- b. On the Start Service Tools Sign On display, type in a User ID with service authority and password.
- c. From the System Service Tools display, select **Start a Service Tool** → **Product activity log** → **Analyze log**.
- d. On the Select Subsystem Data display, select the option to view **All Logs**.

**Note:** You can change the From: and To: Dates and Times from the 24-hour default if the time that the customer reported having the problem was more than 24 hours ago.

- e. Use the defaults on the Select Analysis Report Options display by pressing the Enter key.
- f. Search the entries on the Log Analysis Report display.

**Note:** For example, a 6380 Tape Unit error would be identified as follows:

**System Reference Code:** 6380CC5F

**Class:** Perm

**Resource Name:** TAP01

2. Find an SRC from the product activity log that best matches the time and type of the problem the customer reported.

Did you find an SRC that matches the time and type of problem the customer reported?

**Yes:** Use the SRC information to correct the problem. **This ends the procedure.**

**No:** Contact your next level of support. **This ends the procedure.**

## Using the problem log:

Use this procedure to find and analyze a problem log entry that relates to the problem reported.

**Note:** For on-line problem analysis (WRKPRB), ensure that you are logged on with QSRV authority. During problem isolation, this will allow access to test procedures that are not available under any other log-on.

1. On the command line, enter the Work with Problems command:

```
WRKPRB
```

**Note:** Use F4 to change the WRKPRB parameters to select and sort on specific problem log entries that match the problem. Also, F11 displays the dates and times the problems were logged by the system.

Was an entry that relates to the problem found?

**Note:** If the WRKPRB function was not available answer NO.

**Yes:** Continue with the next step.

**No:** Go to Problems with noncritical resources. **This ends the procedure.**

2. Select the problem entry by moving the cursor to the problem entry option field and entering option 8 to work with the problem.

Is Analyze Problem (option 1) available on the Work with Problem display?

**No:** Perform the following:

- a. Return to the initial problem log display (F12).
- b. Select the problem entry by moving the cursor to the problem entry option field and selecting the option to display details.
- c. Select the function key to display possible causes.

**Note:** If this function key is not available, use the customer reported symptom string for customer perceived information about this problem. Then, go to “Using the product activity log” on page 72.

- d. Use the list of possible causes as the FRU list and go to step 5.

**Yes:** Run Analyze Problem (option 1) from the Work with Problem display.

**Notes:**

- a. For SRCs starting with 6112 or 9337, use the SRC and go to the Reference codes topic.
- b. If the message on the display directs you to use SST (System Service Tools), go to COMIP01.

Was the problem corrected by the analysis procedure?

**No:** Continue with the next step.

**Yes: This ends the procedure.**

3. Did problem analysis send you to another entry point in the service information?

**No:** Continue with the next step.

**Yes:** Go to the entry point indicated by problem analysis. **This ends the procedure.**

4. Was the problem isolated to a list of failing items?

**Yes:** Continue with the next step.

**No:** Go to Problems with noncritical resources. **This ends the procedure.**

5. Exchange the failing items one at a time until the problem is repaired.

**Notes:**

- a. For Symbolic FRUs, see Symbolic FRUs.
- b. When exchanging FRUs, go to the remove and replace procedures for your specific system.

Has the problem been resolved?

**No:** Contact your next level of support. **This ends the procedure.**

**Yes: This ends the procedure.**

### **Problem determination procedure for AIX or Linux servers or partitions**

This procedure helps to produce or retrieve a service request number (SRN) if the customer or a previous procedure did not provide one.

If your server is running AIX or Linux, use one of the following procedures to test the server or partition resources to help you determine where a problem might exist.

If you are servicing a server running the AIX operating system, go to MAP 0020: Problem determination procedure.

If you are servicing a server running the Linux operating system, go to the Linux problem isolation procedure.

### **System unit problem determination**

Use this procedure to obtain a reference code if the customer did not provide you with one, or you are unable to load server diagnostics.

If you are able to load the diagnostics, go to Problem determination procedure for AIX or Linux servers or partitions.

The service processor may have recorded one or more symptoms in its error log. Examine this error log before proceeding (see the Advanced System Management Interface for details). The server may have been set up by using the management console. Check the Service Action Event (SAE) log in the Service Focal Point. The SAE log may have recorded one or more symptoms in the Service Focal Point. To avoid unnecessary replacement of the same FRU for the same problem, it is necessary to check the SAE log for evidence of prior service activity on the same subsystem.

The service processor may have been set by the user to monitor system operations and to attempt recoveries. You can disable these actions while you diagnose and service the system. If the system maintenance policies were saved using the "save/restore hardware maintenance policies", all the settings of the service processor (except language) were saved and you can use the same service aid to restore the settings at the conclusion of your service action.

If you disable the service processor settings, note their current settings so that you can restore when you are done.

If the system is set to power on using one of the parameters in the following table, disconnect the modem to prevent incoming signals that could cause the system to power on.

Following are the service processor settings. See the Advanced System Management Interface information for more information about the service processor settings.

*Table 15. Service processor settings*

Setting	Description
Monitoring (also called surveillance)	From the ASMI menu, expand the System Configuration menu, then click on Monitoring. Disable both types of surveillance.
Auto power restart (also called unattended start mode)	From the ASMI menu, expand Power/Restart Control, then click on Auto Power Restart, and set it to disabled.
Wake on LAN	From the ASMI menu, expand Wake on LAN, and set it to disabled
Call out	From the ASMI menu, expand the Service Aids menu, then click on Call-Home/Call-In Setup. Set the call-home system port and the call-in system port to disabled.

## Step 1020-1

Be prepared to record code numbers to help analyze a problem.

### Analyze a failure to load the diagnostic programs

Follow these steps to analyze a failure to load the diagnostic programs.

**Note:** Be prepared to answer questions regarding the control panel and to perform certain actions based on displayed POST indicators. Please be observant of these conditions.

1. Run diagnostics on any partition. Find your symptom in the following table, then follow the instructions given in the Action column. If no fault is identified, continue to the next step.
2. Run diagnostics on the failing partition. Find your symptom in the following table, then follow the instructions given in the Action column. If no fault is identified, continue to the next step.
3. Power off the system.
4. Load the standalone diagnostics in service mode to test the full system partition; refer to Running the online and stand-alone diagnostics
5. Wait until the diagnostics are loaded or the system appears to stop. If you receive an error code or if the system stops before diagnostics are loaded, find your symptom in the following table, then follow the instructions given in the Action column. If no fault is identified, continue to the next step.

6. Run the standalone diagnostics on the entire system. Find your symptom in the following table, then follow the instructions given in the Action column. If no fault is identified, call service support for assistance.

Symptom	Action
One or more logical partitions does not boot.	<ol style="list-style-type: none"> <li>1. Check service processor error log. If an error is indicated, go to Starting a repair action.</li> <li>2. Check the Serviceable action event log, go to Starting a repair action.</li> <li>3. Go to Problems with loading and starting the operating system.</li> </ol>
The rack identify LED does not operate properly.	Go to Starting a repair action.
The system stopped and a system reference code is displayed on the operator panel.	Go to Starting a repair action.
The system stops with a prompt to enter a password.	Enter the password. You cannot continue until a correct password has been entered. When you have entered a valid password, go to the beginning of this table and wait for one of the other conditions to occur.
The diagnostic operating instructions are displayed.	Go to MAP 0020: AIX or Linux problem determination procedure.
The power good LED does not come on or does not stay on, or you have a power problem.	Go to Power problems.
The system login prompt is displayed.	<p>You may not have pressed the correct key or you may not have pressed the key soon enough when you were to trying to indicate a service mode IPL of the diagnostic programs. If this is the case, start again at the beginning of this step.</p> <p><b>Note:</b> Perform the system shutdown procedure before turning off the system.</p> <p>If you are sure you pressed the correct key in a timely manner, go to Step 1020-2.</p>
The system does not respond when the password is entered.	Go to Step 1020-2.
The system stopped. A POST indicator is displayed on the system console and an eight-digit error code is not displayed.	<p>If the POST indicator represents:</p> <ol style="list-style-type: none"> <li>1. Memory, go to PFW 1548: Memory and processor subsystem problem isolation procedure.</li> <li>2. Keyboard <ol style="list-style-type: none"> <li>a. Replace the keyboard cable.</li> <li>b. Replace the keyboard.</li> <li>c. Replace the service processor. Location is model dependent.</li> <li>d. Go to PFW1542: I/O problem isolation procedure.</li> </ol> </li> <li>3. Network, go to PFW1542: I/O problem isolation procedure.</li> <li>4. SCSI, go to PFW1542: I/O problem isolation procedure.</li> <li>5. Speaker <ol style="list-style-type: none"> <li>a. Replace the operator panel. Location is model dependent.</li> <li>b. Replace the service processor. Location is model dependent.</li> <li>c. Go to PFW1542: I/O problem isolation procedure</li> </ol> </li> </ol>
The System Management Services menu is displayed.	Go to PFW1542: I/O problem isolation procedure.
All other symptoms.	If you were directed here from the Entry MAP, go to PFW1542: I/O problem isolation procedure. Otherwise, find the symptom in the Starting a repair action.

## Step 1020-2

Use this procedure to analyze a keyboard problem.

Find the type of keyboard you are using in the following table; then follow the instructions given in the Action column.

Keyboard Type	Action
Type 101 keyboard (U.S.). Identified by the size of the Enter key. The Enter key is in only one horizontal row of keys.	Record error code M0KB D001; then go to Step 1020-3.
Type 102 keyboard (W.T.). Identified by the size of the Enter key. The Enter key extends into two horizontal rows.	Record error code M0KB D002; then go to Step 1020-3.
Type 106 keyboard. (Identified by the Japanese characters.)	Record error code M0KB D003; then go to Step 1020-3.
ASCII terminal keyboard	Go to the documentation for this type of ASCII terminal and continue with problem determination.

## Step 1020-3

Perform the following steps:

1. Find the 8-digit error code in Reference codes.

**Note:** If you do not locate the 8-digit code, look for it in one of the following places:

- Any supplemental service manuals for attached devices
- The diagnostic problem report screen for additional information
- The Service Hints service aid
- The CEREADME file

2. Perform the action listed.

### Management console machine code problems

The support organization uses the *pesh* command to look at the management console internal machine code to determine how to fix a machine code problem. Only a service representative or support representative can access this feature.

#### Launching an xterm shell:

You may need to launch an xterm shell to perform directed support from the support center. This may be required if the support center needs to analyze a system dump in order to better understand machine code operations at the time of a failure. To launch an xterm shell, perform the following:

1. Open a terminal by right-clicking the background and selecting **Terminals** → **rshterm**.
2. Type the *pesh* command followed by the serial number of the management console and press Enter.
3. You will be prompted for a password, which you must obtain from your next level of support.

Additional information: “Viewing the management console logs.”

#### Viewing the management console logs:

The console logs display error and information messages that the console has logged while running commands.



The service representative can use this information to learn more about what caused an error and how to resolve it. The management console classifies log entries as either an informational message or an error message. Log entries are identified with an *I* or *E*, respectively. The management console lists these log entries chronologically, with the most recent shown at the top of the list.

Use the management console Log to view a record of management console system events. System events are activities that indicate when processes begin and end. These events also indicate whether the attempted action was successful.

To view the HMC log, perform the following:

1. Launch an xterm shell (see “Launching an xterm shell” on page 76).
2. When you have entered the password, use the `showLog` command to launch the HMC log window.

The log includes the following information:

- The event's unique ID code
- The date the event occurred
- The time the event occurred
- The log's type
- The name of the attempted action
- The log's reference code
- The status of the log

To view the SDMC log:

- In the IBM Systems Director Web interface navigation area, expand **System Status and Health**, and click **Event Log**.

*View a particular event:*

To view a particular event, perform the following:

1. Select an event by clicking once on it.
2. Press Enter to get to a summary of the log you selected. From here, you must select a Block ID to display. The blocks are listed next to the buttons and include the following options:
  - Standard Data Block
  - Secondary Data Block
  - Microcode Reason / ID Error Information
3. Select the data block you want to view.
4. Press Enter. The extended information shown for the data blocks you selected includes the following items:
  - Program name
  - Current process ID
  - Parent process ID
  - Current thread priority
  - Current thread ID
  - Screen group
  - Subscreen group
  - Current foreground screen process group
  - Current background screen process group

## Problem determination procedures

Problem determination procedures are provided by power-on self-tests (POSTs), service request numbers, and maintenance analysis procedures (MAPs). Some of these procedures use the service aids that are described in the user or maintenance information for your system SCSI attachment.

### Disk drive module power-on self-tests:

The disk drive module Power-on Self-Tests (POSTs) start each time that the module is switched on, or when a Send Diagnostic command is received. They check whether the disk drive module is working correctly. The POSTs also help verify a repair after a Field Replaceable Unit (FRU) has been exchanged.

The tests are POST-1 and POST-2.

POST-1 runs immediately after the power-on reset line goes inactive, and before the disk drive module motor starts. POST-1 includes the following tests:

- Microprocessor
- ROM
- Checking circuits

If POST-1 completes successfully, POST-2 is enabled.

If POST-1 fails, the disk drive module is not configured into the system.

POST-2 runs after the disk drive module motor has started. POST-2 includes the following tests:

- Motor control
- Servo control
- Read and write on the diagnostic cylinder (repeated for all heads)
- Error checking and correction (ECC).

If POST-2 completes successfully, the disk drive module is ready for use with the system.

If POST-2 fails, the disk drive module is not configured into the system.

### SCSI card power-on self-tests:

The SCSI card Power-On Self Tests (POSTs) start each time power is switched on, or when a Reset command is sent from the using system SCSI attachment. They check only the internal components of the SCSI card; they do not check any interfaces to other FRUs.

If the POSTs complete successfully, control passes to the functional microcode of the SCSI card. This microcode checks all the internal interfaces of the I/O enclosure, and reports failures to the host system.

If the POSTs fail, one of the following events occur:

- The SCSI card check LED and the enclosure check LED come on.
- If the SCSI was configured for high availability using a dual initiator card the error will be reported. However, the functional operation of the enclosure is not affected. For example, the customer still has access to all the disk drive modules.

The failure is reported when:

- the failure occurs at system bring-up time, the host system might detect that the enclosure is missing, and reports an error.
- the failure occurs at any time other than system bring-up time, the hourly health check reports the failure.

## 7031-D24 or 7031-T24 disk-drive enclosure LEDs:

Disk drive enclosure LED positions and definitions.

The 7031-D24 and 7031-T24 use a series of green and amber LEDs. The light emitting diodes (LED)s are located on the front and the back of the disk-drive enclosure and are used to indicate disk drive enclosure and component activity, fault, and power status. The following definition list identifies, defines, and explains the on and off state of each LED. Following the definition list are two illustrations that show the location of each LED.

### Disk drive enclosure status LEDs

The two disk drive enclosure status LEDs indicate the following:

- Power good LED - (solid, not blinking) when lit this green colored LED indicates that the disk-drive enclosure is receiving dc electrical power.
- Cage Fault LED - (solid, not blinking) when lit this amber colored LED indicates that one of the components located in the disk-drive enclosure has failed.

#### Notes:

- The failing component can be located either on the front or the rear of the subsystem.
- The disk-drive enclosure might be able to continue operating satisfactorily although the failure of a particular part has been detected.

### Disk drive LEDs

Up to twenty four disk drives can be installed into the front and back of the disk-drive enclosure (twelve disk drives per side). Each disk drive contains three LEDs that are visible via light pipes. The light pipes are attached to the disk-drive carrier and extend out the left side of each disk drive.

- Disk drive activity LED (green) - The disk drive activity LED is controlled by the disk. For most disk drives the green LED is lit when the disk is processing a command. However, for some disk drives a different mode page setting allows the green LED to be lit when the disk drive motor is spinning and the LED blinks toward an off state when a command is in progress.
- Disk drive fault LED (amber) - The disk fault LED is controlled by the SES processor on the SCSI interface card. The disk drive fault LED can be viewed in one of the following three states:
  - Off - This is the normal state for the disk-drive fault LED
  - On - (solid, not blinking) indicates one of the following:
    - A drive is to be removed
    - The disk drive is faulty
    - Appears on an empty slot where a drive is to be installed
  - Blinking - The disk drive is rebuilding
- Disk drive identify (green) - The light pipe for this LED is located on the lower left side of the disk drive and is used for the identify function by disk-drive enclosures that are connected to an System i systems.

### Power supply LEDs

This disk drive enclosure contains two power supplies and they are located on the back lower third portion of the chassis. The power supply located on the left of the chassis is power supply 1. The power supply located on the right side of the chassis is power supply 2. Each power supply contains four LEDs located on the lower right side. The following list identifies and defines each of the power supply LEDs.

- Cage fault LED - This is an amber colored LED and is labeled C/F. The power supply cage fault LED provides the same information as the cage fault indicator located on the front of the enclosure.

- AC good LED - This a green colored LED and is labeled I/G
- DC power good LED - This green colored LED is labeled D/G. Indicates that the enclosure is getting good dc power. It is on when +1.8 V, +3.3 V, +5 V, and +12 V are good. It goes off when any of the mentioned voltages are not good.
- Power supply fault LED - This amber colored LED is labeled FLT and comes on solid when there is a fault with the power supply.

The following table explains the fault condition or power supply state indicated by each power supply LED:

*Table 16. Power supply fault condition*

LED name	Normal operation state	Input not present state	Input present state	Fault state
Cage fault LED	OFF	OFF	ON	
AC good LED	ON	OFF	ON	ON
DC power good LED	ON	OFF	OFF	OFF
Power supply fault LED	OFF	OFF	ON	OFF

#### **Fan assembly LEDs**

The three disk-drive enclosure fan assemblies are located on the front lower third of the enclosure chassis. There are two LEDs located on each fan. The green colored LED is lit when power to the fan is present. The second LED is amber colored when lit and comes on when the fan needs to be replaced.

#### **Note:**

- The fan does not need to be completely dead before the fan fault LED is lit. The fan can be turning either to slow or to fast indicating to the system that it is having a problem.
- The fans green LED will remain lit even when the amber LED is indicating a fan fault.

#### **SCSI interface card LEDs**

Each SCSI interface card has a green and amber colored LED. The green colored LED indicates that activity is taking place through the interface card. The amber colored LED is used as an identify LED and indicates which one of the SCSI interface cards needs to be replaced.

The following two figures show the location of each LEDs found on the 7031-D24 or 7031-T24.

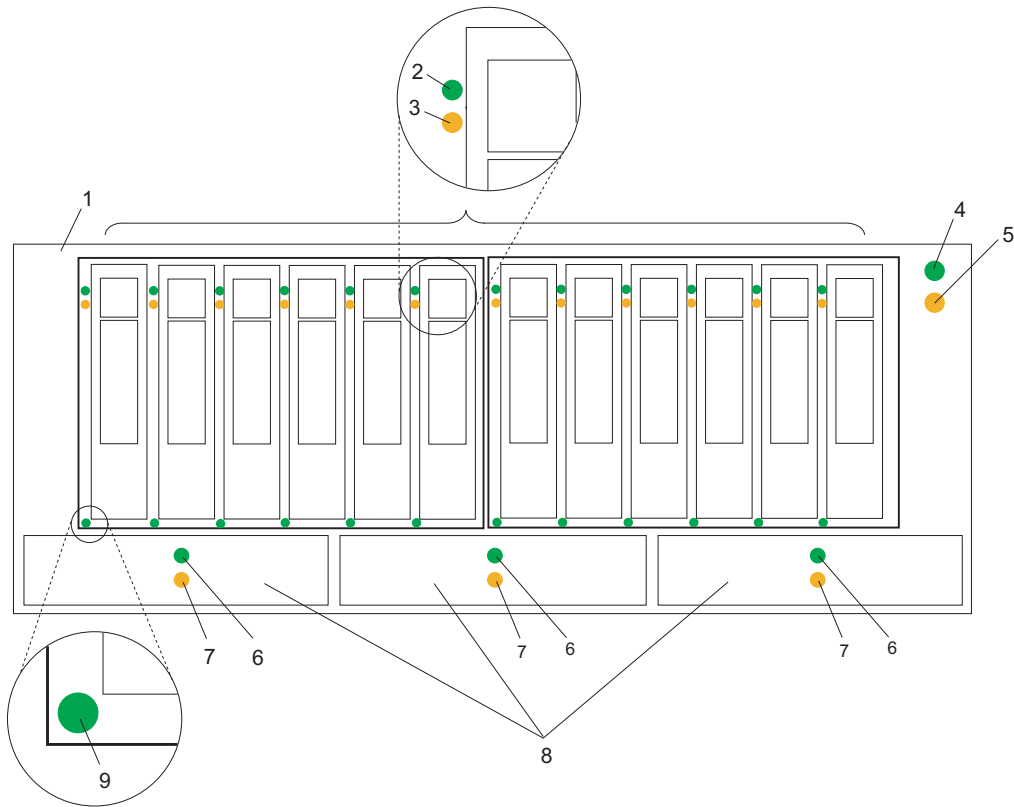

Figure 1. Front view showing maintenance LEDs on the 7031-D24 and 7031-T24

Index Number	Component LED	Index Number	Component LED
1	7031-D24 or 7031-T24	6	Fan power LED
2	Disk drive activity LED	7	Fan fault LED
3	Disk drive fault LED	8	Fan assembly
4	Status panel power good LED	9	Disk drive identify LED (activated on System i models only)
5	Status panel cage fault LED		

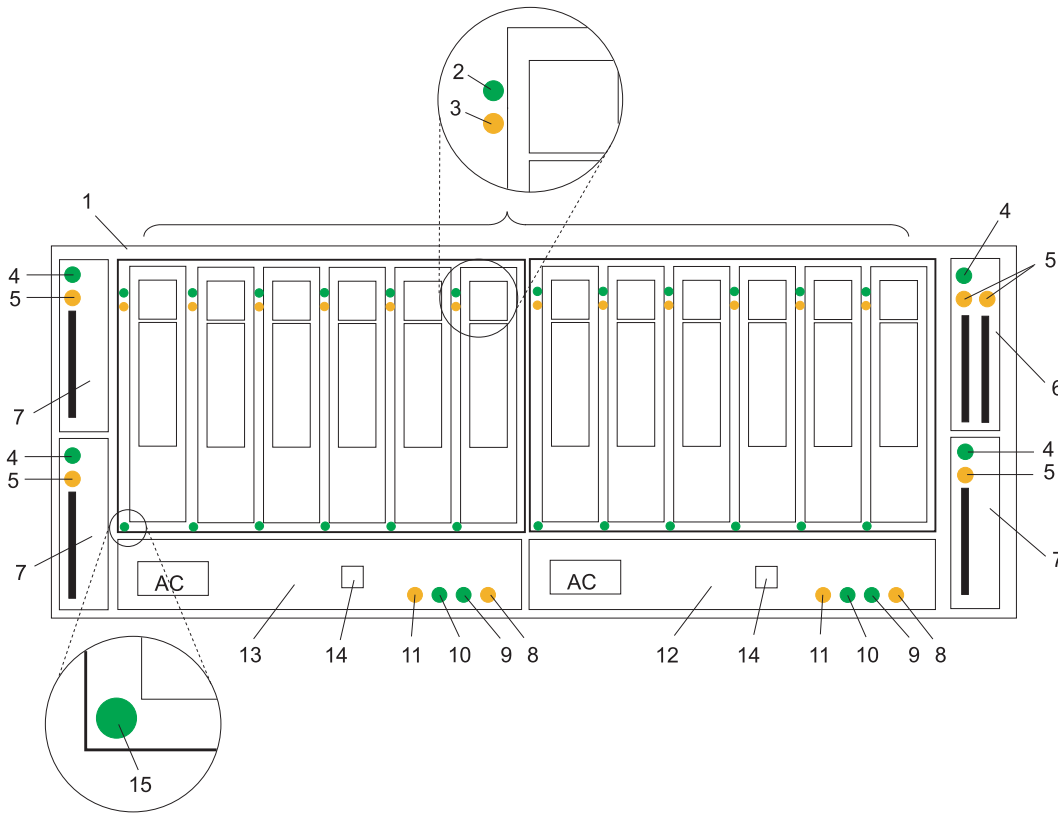

Figure 2. Rear view showing maintenance LEDs on the 7031-D24 and 7031-T24

Index Number	Component LED	Index Number	Component LED
1	7031-D24 or 7031-T24	9	Power supply dc power good LED
2	Disk drive activity LED	10	Power supply ac power good LED
3	Disk drive fault LED	11	Cage fault LED
4	SCSI interface card fault LED	12	Power supply 2
5	SCSI interface card activity LED	13	Power supply 1
6	Dual initiator SCSI interface card	14	Rack indicator connector
7	Single initiator SCSI interface card	15	Disk drive identify LED (activated on System i models only)
8	Power supply fault LED		

#### 7031-D24 or 7031-T24 maintenance analysis procedures:

These maintenance analysis procedures (MAPs) describe how to analyze a continuous failure that has occurred in a 7031-D24 or 7031-T24 that contains one or more SCSI disk drive modules. Failing FRUs of the 7031-D24 or 7031-T24 can be isolated with these MAPs.

For more information on additional tools to identify missing resources on Linux, go to “Linux tools” on page 83.

## Using the MAPs

**Attention:** Do not remove power from the host system or 7031-D24 or 7031-T24 unless you are told to in the instructions that you are following. Power cables and external SCSI cables that connect the 7031-D24 or 7031-T24 to the host system can be disconnected while that system is running.

To isolate the FRUs in the failing 7031-D24 or 7031-T24, perform the following actions and answer the questions given in these MAPs:

1. When instructed to exchange two or more FRUs in sequence:
  - a. Exchange the first FRU in the list for a new one.
  - b. Verify that the problem is solved. For some problems, verification means running the diagnostic programs (see the using system service procedures).
  - c. If the problem remains:
    - 1) Reinstall the original FRU.
    - 2) Exchange the next FRU in the list for a new one.
  - d. Repeat steps 1b and 1c until either the problem is solved, or all the related FRUs have been exchanged.
  - e. Perform the next action that the MAP indicates.
2. Refer to Component and attention LEDs often when servicing your server and enclosure. The LEDs are one of the diagnostic tools used by your server and enclosure to aid you in identifying failing components. They are also used to identify specific component locations on your system.

**Attention:** Disk drive modules are fragile. Handle them with care, and keep them well away from strong magnetic fields.

## Linux tools

Use the `lscfg` command to list all the resources that are available at start up. This information is also saved at each start up and you can use it to identify any missing resources.

To determine if any devices or adapters are missing, compare the list of found resources and partition assignments to the customer's known configuration. Record the location of any missing devices. You can also compare this list of found resources to a prior version of the device tree as the following example shows.

When the partition is restarted, the update device tree command is run and the device tree is stored in the `/var/lib/lsvpd/` directory in a file with the file name device tree `YYYY-MM-DDHH:MM:SS`, where `YYYY` is the year, `MM` is the month, `DD` is the day, and `HH`, `MM`, and `SS` are the hour, minute and second, respectively of the date of creation.

Type the following command at the command line: `cd /var/lib/lsvpd/`, then type the following command: `lscfg -vpd device-tree-2003-03-31-12:26:31`. This command displays the device tree that was created on 03/31/2003 at 12:26:31.

*MAP 2010: 7031-D24 or 7031-T24 START:*

This MAP is the entry point to the MAPs for the 7031-D24 or 7031-T24.

If you are not familiar with these MAPs, read "Using the MAPs" first.

You might have been directed to this section because:

- The system problem determination procedures sent you here.
- Action from an SRN list sent you here.

- A problem occurred during the installation of a 7031-D24 or 7031-T24 or a disk drive module.
- Another MAP sent you here.
- A customer observed a problem that was not detected by the system problem determination procedures.

**Attention:** Do not remove power from the host system or 7031-D24 or 7031-T24 unless you are told to in the instructions that you are following. Power cables and external SCSI cables that connect the 7031-D24 or 7031-T24 to the host system can be disconnected while that system is running.

**1. Does the 7031-D24 or 7031-T24 emit smoke or is there a burning smell?**

**NO** Go to step 2.

**YES** Go to “MAP 2022: 7031-D24 or 7031-T24 Power-on” on page 88.

**2. Are you at this MAP because power is not removed completely from the 7031-D24 or 7031-T24 when the host systems are switched off?**

**Note:** Power will remain on the 7031 for approximately 30 seconds after the last system is powered off.

**NO** Go to step 3.

**YES** Go to “MAP 2030: 7031-D24 or 7031-T24 power control” on page 90.

**3. Have you been sent to this MAP from an SRN?**

**NO** Go to step 4.

**YES** Go to step 7.

**4. Have the system diagnostics or problem determination procedures given you an SRN for the 7031-D24 or 7031-T24?**

**NO**

- If the system diagnostics for the 7031-D24 or 7031-T24 are available, go to step 5.
- If the system diagnostics for the 7031-D24 or 7031-T24 are not available, but the stand-alone diagnostics are available, do the following:
  - a. Run the stand-alone diagnostics.
  - b. Go to step 6.
- If neither the system diagnostics nor the standalone diagnostics are available, go to step 7.

**YES** Go to Service request numbers.

**5.**

- a. Run the concurrent diagnostics to the 7031-D24 or 7031-T24. For information about how to run concurrent diagnostics, see Running the online and stand-alone diagnostics.
- b. When the concurrent diagnostics are complete, go to step 6.

**6. Did the diagnostics give you an SRN for the 7031-D24 or 7031-T24?**

**NO** Go to step 7.

**YES** Go to Service request numbers.

**7. Is the subsystem check LED flashing?**

**NO** Go to step 8.

**YES** A device is in Identify mode. A power supply, SCSI card, or disk drive module is to be added or installed.

**8. Is the subsystem check LED on continuously?**

**NO** Go to step 12 on page 86.

**YES** Go to step 9 on page 85.



9. Does the power-supply assembly have its FLT LED on because its DC On/Off switch is set to Off?

NO Go to step 10.

YES

- a. Set the DC On/Off switch to On.
- b. If you still have a problem, return to step 2 on page 84. Otherwise, go to “MAP 2410: 7031-D24 or 7031-T24 repair verification” on page 92 to verify the repair.

10. Does any FRU have its Check or Fault LED on?

**Note:** The check LED might be on any of the following parts:

- A SCSI interface card assembly (CARD FAULT LED)
- A power-supply assembly (FLT LED)
- A fan assembly (CHK LED)
- A disk drive module (CHK LED)

NO In the following sequence, exchange the following FRUs for new FRUs. Ensure that for *each* FRU exchange, you go to “MAP 2410: 7031-D24 or 7031-T24 repair verification” on page 92 to verify the repair.

- a. SCSI interface card assembly (go to the 5786, 5787, and 7031 models D24 and T24 removal and replacement procedures), and select the appropriate part.
- b. Power supply (go to the 5786, 5787, and 7031 models D24 and T24 removal and replacement procedures), and select the appropriate part.
- c. Fan assembly (go to the 5786, 5787, and 7031 models D24 and T24 removal and replacement procedures), and select the appropriate part.
- d. Frame assembly (go to the 5786, 5787, and 7031 models D24 and T24 removal and replacement procedures), and select the appropriate part.

YES

- a. If the FRU is a fan-and-power-supply assembly, go to step 11. Otherwise, exchange the FRU whose Check LED is on.
- b. Go to “MAP 2410: 7031-D24 or 7031-T24 repair verification” on page 92 to verify the repair.

11. Is the enclosure set up for remote power control (that is, is the power control switch of the SCSI interface card assembly set to Off)?

NO

- a. Exchange, for a new one, the power supply whose FLT LED is on (go to the 5786, 5787, and 7031 models D24 and T24 removal and replacement procedures), and select Power supply.
- b. Go to “MAP 2410: 7031-D24 or 7031-T24 repair verification” on page 92 to verify the repair.

YES

- a. Ensure that:
  - The DC On/Off switch is set to On.
  - Both ends of the SCSI cable are correctly connected.
  - The host system is switched on.
- b. If the FLT LED of a power supply is still on, pull out the power supply to disconnect it from the 7031-D24 or 7031-T24, then push it back to reseat its connectors (go to the 5786, 5787, and 7031 models D24 and T24 removal and replacement procedures), and select the appropriate part.

- c. If the FLT LED is still on, exchange, in the sequence shown, the following FRUs for new FRUs. Ensure that for *each* FRU exchange, you go to “MAP 2410: 7031-D24 or 7031-T24 repair verification” on page 92 to verify the repair.
  - 1) Power supply whose FLT LED is NOT on, (go to the 5786, 5787, and 7031 models D24 and T24 removal and replacement procedures), and select Power supply.
  - 2) SCSI interface card
  - 3) Frame assembly

**12. Is the subsystem power LED on?**

**NO** Go to “MAP 2020: 7031-D24 or 7031-T24 Power.”

**YES** Go to step 13.

**13. Does either power supply assembly have its DC PWR LED off when it should be on?**

**NO** Go to step 14.

**YES**

- a. Exchange the power-supply assembly whose LED is off.
- b. Go to “MAP 2410: 7031-D24 or 7031-T24 repair verification” on page 92 to verify the repair.

**14. Are you here because access to all the SCSI devices that are in the 7031-D24 or 7031-T24 has been lost?**

**NO** No problem has been found on the 7031-D24 or 7031-T24. For a final check, go to “MAP 2410: 7031-D24 or 7031-T24 repair verification” on page 92.

**YES** Go to “MAP 2340: 7031-D24 or 7031-T24 SCSI bus” on page 91.

*MAP 2020: 7031-D24 or 7031-T24 Power:*

This MAP helps you to isolate FRUs that are causing a power problem on a 7031-D24 or 7031-T24. This MAP assumes that the disk subsystem is connected to a system that is powered on.

**Attention:** Do not remove power from the host system or the disk subsystem unless you are directed to in the following procedures. Power cables and external SCSI cables that connect the disk subsystem to the host system can be disconnected while that system is running.

1. You are here because the subsystem's power Light Emitting Diode (LED) is off.

**Are the 2 middle green LEDs illuminated (AC and DC) on either power supply?**

**No** Go to step 2.

**Yes** In the sequence shown, exchange the following FRUs for new FRUs. Ensure that for *each* FRU exchange, you go to “MAP 2410: 7031-D24 or 7031-T24 repair verification” on page 92 to verify the repair.

- a. Power supply (or power supplies if two are present)
- b. Frame assembly

2. Observe the power supply (or power supplies, if two are present).

**Does at least one power supply have its AC PWR LED on?**

**No** Go to step 3.

**Yes** Go to step 4 on page 87.

3. Observe the power supplies.

**Are the power supplies switched on?**

**No**

- a. Set the On/Off switch to On.

- b. If the problem is still not solved, go to “MAP 2010: 7031-D24 or 7031-T24 START” on page 83.

**Yes** Go to step 4.

**4. Does either of the power supplies have its DC PWR LED on or flashing?**

**No**

- a. Set the DC On/Off switch to Off, then to On again.
- b. Go to step 5.

**Yes** In the sequence shown, exchange the following FRUs for new FRUs. Ensure that for *each* FRU exchange, you go to “MAP 2410: 7031-D24 or 7031-T24 repair verification” on page 92 to verify the repair.

- a. Power supply (or power supplies if two are present)
- b. Frame assembly

If the DC PWR LED is flashing, replace the SCSI interface card assembly. Go to 5.

**5. Does the power supply have its DC PWR LED on now?**

**No** Replace the power supply (or power supplies, if two are present).

**Yes** Go to 6.

**6. Is the subsystem power LED on continuously?**

**No** In the sequence shown, exchange the following FRUs for new FRUs. Ensure that for *each* FRU exchange, you go to “MAP 2410: 7031-D24 or 7031-T24 repair verification” on page 92 to verify the repair.

- a. Fan assembly
- b. SCSI interface card assembly
- c. Frame assembly

**Yes** Go to step “MAP 2410: 7031-D24 or 7031-T24 repair verification” on page 92 to verify the repair.

**7. (from step 6)**

Observe the SCSI interface card assemblies.

**Does either SCSI interface card have its TERM POWER LED illuminated?**

**No** Go to step 8.

**Yes** In the sequence shown, exchange the following FRUs for new FRUs. Ensure that for *each* FRU exchange, you go to “MAP 2410: 7031-D24 or 7031-T24 repair verification” on page 92 to verify the repair.

- a. Power-supply (go to the 5786, 5787, and 7031 models D24 and T24 removal and replacement procedures),
- b. Fan (go to the 5786, 5787, and 7031 models D24 and T24 removal and replacement procedures),
- c. SCSI interface card assembly (go to the 5786, 5787, and 7031 models D24 and T24 removal and replacement procedures),

**8. (from step 7)**

**Is the host system switched on?**

**No** Switch on the host system (see the host system-service information). The 2104 Model DS4 or Model TS4 should switch on when the host system switches on.

If the problem is still not solved, go to “MAP 2010: 7031-D24 or 7031-T24 START” on page 83.

**Yes** In the sequence shown, exchange the following FRUs for new FRUs. Ensure that for *each* FRU exchange, you go to “MAP 2410: 7031-D24 or 7031-T24 repair verification” on page 92 to verify the repair.

- a. External SCSI cables
- b. SCSI interface card assembly (go to the 5786, 5787, and 7031 models D24 and T24 removal and replacement procedures),

**Note:** If the TERM POWER LED is still off, you might have a problem with the SCSI attachment that is in the host system (see the using system service information).

*MAP 2022: 7031-D24 or 7031-T24 Power-on:*

This MAP helps you to isolate FRUs that are causing a power problem on a 7031-D24 or 7031-T24 disk subsystem.

**Attention:** Do not remove power from the host system or the disk subsystem unless you are directed to in the following procedures. Power cables and external SCSI cables that connect the disk subsystem to the host system can be disconnected while that system is running.

1. In this step you remove most of the FRUs from the 7031-D24 or 7031-T24 disk subsystem.
  - a. Remove both power supply assemblies, if two are present.
  - b. Remove the fan assemblies.
  - c. Remove the SCSI interface card assemblies. If your disk subsystem has only one SCSI interface card assembly, you do not need to remove the dummy assembly.
  - d. Disconnect all the disk drive modules from the backplane.

**Note:** You do not need to completely remove the disk drive modules.

- e. Go to step 2.
2. Do the following procedure to check the disk subsystem as you reinstall parts.
  - a. Reinstall a power supply into position 1.
  - b. Reinstall the fan assemblies.
  - c. Connect a power cable to the power supply.
  - d. Set the DC On/Off switch of the power supply to On.
  - e. Reinstall one SCSI interface card and connect the appropriate cables to a powered-on system.

**Note:** Unless a procedure needs you to switch off the disk subsystem, leave it switched on for the remainder of this MAP.

**Does the disk subsystem emit smoke or is there a burning smell?**

**No** Go to step 3.

**Yes**

- a. In the sequence shown, exchange the following FRUs for new FRUs. Ensure that for each FRU exchange, you go to “MAP 2410: 7031-D24 or 7031-T24 repair verification” on page 92 to verify the repair.
  - 1) Power supply that you just reinstalled
  - 2) Fan assemblies
  - 3) SCSI interface card
  - 4) Frame assembly
- b. Go to step 3.

3. Reinstall the other power supply into position 2.
  - a. Connect a power cable to the power supply.

- b. Set the DC On/Off switch of the power supply assembly to On.

**Note:** Unless a procedure needs you to switch off the disk subsystem, leave it switched on for the remainder of this MAP.

**Does the disk subsystem emit smoke or is there a burning smell?**

**No** Go to step 4.

**Yes** Replace the power supplies.

4. Reinstall a SCSI interface card assembly into position 1.

**Does the disk subsystem emit smoke or is there a burning smell?**

**No** If the disk subsystem has 2, 3, or 4 SCSI interface cards, go to step 5. Otherwise, go to step 6.

**Yes**

a. Exchange, for a new one, the SCSI interface card assembly that you have just reinstalled.

b. If the disk subsystem has two SCSI interface cards, go to step 5. Otherwise, go to step 6.

5. Reinstall the other SCSI interface card assembly into position 2.

**Does the disk subsystem emit smoke or is there a burning smell?**

**No** Go to step 6.

**Yes**

a. Exchange, for a new one, the SCSI interface card assembly that you just reinstalled.

b. Go to step 6.

6. Reconnect a disk drive.

**Note:** To engage the disk drive you must close its handle.

**Does the disk subsystem emit smoke or is there a burning smell?**

**No** Go to step 7.

**Yes**

a. Exchange, for a new one, the disk drive module that you just reconnected.

b. Go to step 7.

7. Reconnect the next disk drive module.

**Note:** To engage the disk drive you must close its handle.

**Does the disk subsystem emit smoke or is there a burning smell?**

**No** Go to step 8.

**Yes**

a. Exchange, for a new one, the disk drive module that you just reconnected.

b. Go to step 8.

8. Have you reconnected all the disk drive modules?

**No** Return to step 7.

**Yes** Go to step 9.

9. Have you solved the problem?

**No** Remove all power from the disk subsystem, and call for assistance.

**Yes** Go to step "MAP 2410: 7031-D24 or 7031-T24 repair verification" on page 92 to verify the repair.

MAP 2030: 7031-D24 or 7031-T24 power control:

This MAP helps isolate FRUs that are causing a power problem that do not allow the 7031-D24 or 7031-T24 disk subsystem to power off when it should.

**Attention:** Do not remove power from the host system or the disk subsystem unless you are directed to in the following procedures. Power cables and external SCSI cables that connect the disk subsystem to the host system can be disconnected while that system is running.

You are here because power is still present at the disk subsystem although the host system is switched off.

1. Observe the cards.

**Does the disk subsystem remain powered on for more than 30 seconds after the last connected system powers off?**

**No** Go to “MAP 2410: 7031-D24 or 7031-T24 repair verification” on page 92 to verify the repair.

**Yes** Go to step 2.

2. Disconnect all SCSI cables and wait 30 seconds.

**Is the disk subsystem still powered on?**

**No** Go to step 3.

**Yes** Suspect an adapter problem in the host system.

3. Remove all SCSI initiator cards.

**Is the disk subsystem still powered on?**

**No**

- a. Replug the SCSI interface cards one at a time to determine which one is bad.
- b. If the disk subsystem powers on after replacing a SCSI interface card, replace that SCSI interface card.
- c. Go to “MAP 2410: 7031-D24 or 7031-T24 repair verification” on page 92 to verify the repair.

**Yes** Go to step 4.

4. **Does the disk subsystem have two power supplies?**

**No**

- a. In the sequence shown, exchange the following FRUs for new FRUs:
  - 1) Power supply assemblies
  - 2) Frame assembly
- b. Go to step 7 on page 91.

**Yes** Go to step 5.

5. **Do both power supplies have their DC PWR LEDs on?**

**No** Go to step 6.

**Yes** In the sequence shown, exchange the following FRUs for new FRUs. Ensure that for *each* FRU exchange, you go to “MAP 2410: 7031-D24 or 7031-T24 repair verification” on page 92 to verify the repair.

- a. Power supplies
- b. Frame assembly

6. **Does only one power supply have its DC PWR LED on?**

**No** Go to step 7 on page 91.

**Yes**

- a. Exchange, for a new one, the power supply whose DC PWR LED remains illuminated.
- b. Go to step 7.

**7. Is the disk subsystem still powered on?**

**No** The problem is solved.

**Yes** Call for assistance.

*MAP 2340: 7031-D24 or 7031-T24 SCSI bus:*

You are here because the host system cannot access any SCSI device (disk drive module or enclosure services) in a 7031-D24 or 7031-T24 disk subsystem.

**Attention:** Do not remove power from the host system or the disk subsystem unless you are directed to in the following procedures. Power cables and external SCSI cables that connect the disk subsystem to the host system can be disconnected while that system is running.

**1. Observe the SCSI Bus Split switch.**

**Is the disk subsystem powered on?**

**No** Ensure that a SCSI cable is attached to a powered system, and the disk subsystem is powered on. Go to step 2.

**Yes** Go to step 2.

**2. Is the yellow LED illuminated on the SCSI repeater card?**

**No** Go to step 3.

**Yes** Replace the SCSI interface card. Go to step 3.

**3. Is the green power LED illuminated on the SCSI repeater card?**

**No** Go to "MAP 2020: 7031-D24 or 7031-T24 Power" on page 86.

**Yes** Go to step 4.

**4. Is the SCSI interface card a dual SCSI interface card?**

**No** Go to step 5.

**Yes** Disconnect one of the SCSI cables, go to step 5.

**5. Note the positions of all the disk drive modules and the dummy disk drive modules so that you can reinstall the modules into their correct slots later.**

a. Remove all of the disk drive modules.

b. Go to step 6.

**6. Can the host system access enclosure services?**

**No** In the sequence shown, exchange the following FRUs for new FRUs. Ensure that for each FRU exchange, you check whether you can access the disk drive module, to verify the repair.

a. External SCSI cable

b. SCSI interface card assembly

c. Frame assembly

d. Power supplies

e. If the repair is successful, reinstall all of the disk drive modules and cables that were removed in a previous steps.

f. Go to "MAP 2410: 7031-D24 or 7031-T24 repair verification" on page 92 to verify the repair.

**Yes** Go to step 7.

**7. Reinsert the disk drive modules that you just removed, one at a time, checking for accessibility.**

**Can the host system access this disk drive module?**

**No**

- a. In the sequence shown, exchange the following FRUs for new FRUs. Ensure that for *each* FRU exchange, you check whether you can access the disk drive module, to verify the repair.
  - 1) Exchange the disk drive module for a new one.
  - 2) External SCSI cable
  - 3) SCSI interface card assembly
  - 4) Power supply
  - 5) Frame assembly
- b. If the repair is successful, reinstall all the disk drive modules and if removed, the SCSI interface card assembly.
- c. Go to “MAP 2410: 7031-D24 or 7031-T24 repair verification” to verify the repair.

**Yes** Go to step 8.

**8. Have you reinstalled all the disk drive modules?**

**No** Go to step 7 on page 91

**Yes** Go to step 9.

**9. (from step 8)**

**Can the host system get access to all of the plugged disk drive module and enclosure services?**

**No** Call your support center for assistance.

- a. Exchange the disk drive module for a new one.
- b. Return to step 8.

**Yes** Go to “MAP 2410: 7031-D24 or 7031-T24 repair verification” to verify the repair.

*MAP 2410: 7031-D24 or 7031-T24 repair verification:*

Use this MAP to help you verify a repair after a FRU is exchanged for a new one on a 7031-D24 or 7031-T24 disk subsystem.

**Attention:** Do not remove power from the host system or the disk subsystem unless you are directed to in the following procedures. Power cables and external SCSI cables that connect the disk subsystem to the host system can be disconnected while that system is running.

- 1. Ensure that the DC On/Off switch of each power supply assembly is set to On.

**Are all Check LEDs off?**

**No** Go to “MAP 2010: 7031-D24 or 7031-T24 START” on page 83.

**Yes** Go to step 2.

**2. Can the host system access all SCSI devices?**

**No** Go to “MAP 2010: 7031-D24 or 7031-T24 START” on page 83.

**Yes** The repair is complete.

Go to “MAP 0410: Repair checkout” on page 46 for system level repair verification.

## Analyzing problems

Use these instructions and procedures to help you determine the cause of the problem.



## Problems with loading and starting the operating system (AIX and Linux)

If the system is running partitions from partition standby (LPAR), the following procedure addresses the problem in which one partition will not boot AIX or Linux while other partitions boot successfully and run the operating system successfully.

It is the customer's responsibility to move devices between partitions. If a device must be moved to another partition to run standalone diagnostics, contact the customer or system administrator. If the optical drive must be moved to another partition, all SCSI devices connected to that SCSI adapter must be moved because moves are done at the slot level, not at the device level.

Depending on the boot device, a checkpoint may be displayed on the operator panel for an extended period of time while the boot image is retrieved from the device. This is particularly true for tape and network boot attempts. If booting from an optical drive or tape drive, watch for activity on the drive's LED indicator. A blinking LED indicates that the loading of either the boot image or additional information required by the operating system being booted is still in progress. If the checkpoint is displayed for an extended period of time and the drive LED is not indicating any activity, there might be a problem loading the boot image from the device.

### Notes:

1. For network boot attempts, if the system is not connected to an active network or if the target server is inaccessible (which can also result from incorrect IP parameters being supplied), the system will still attempt to boot. Because time-out durations are necessarily long to accommodate retries, the system may appear to be hung. Refer to checkpoint CA00 E174.
2. If the partition hangs with a 4-character checkpoint in the display, the partition must be deactivated, then reactivated before attempting to reboot.
3. If a BA06 000x error code is reported, the partition is already deactivated and in the error state. Reboot by activating the partition. If the reboot is still not successful, go to step 3.

This procedure assumes that a diagnostic CD-ROM and an optical drive from which it can be booted are available, or that diagnostics can be run from a NIM (Network Installation Management) server. Booting the diagnostic image from an optical drive or a NIM server is referred to as running standalone diagnostics.

1. Is a management console attached to the managed system?  
**Yes:** Continue with the next step.  
**No:** Go to step 3.
2. Look at the service action event error log on the management console. Perform the actions necessary to resolve any open entries that affect devices in the boot path of the partition or that indicate problems with I/O cabling. Then try to reboot the partition. Does the partition reboot successfully?  
**Yes: This ends the procedure.**  
**No:** Continue with the next step.
3. Boot to the SMS main menu:
  - If you are rebooting a partition from partition standby (LPAR), go to the properties of the partition and select **Boot to SMS**, then activate the partition.
  - If you are rebooting from platform standby, access the ASMI. See Accessing the Advanced system Management Interface using a Web browser. Select **Power/Restart Control**, then **Power On/Off System**. In the AIX/Linux partition mode boot box, select **Boot to SMS menu** → **Save Settings and Power On**.

At the SMS main menu, select **Select Boot Options** and verify whether the intended boot device is correctly specified in the boot list. Is the intended load device correctly specified in the boot list?

- **Yes:** Perform the following steps:
  - a. Remove all removable media from devices in the boot list from which you do not want to load the operating system.

- b. If you are attempting to load the operating system from a network, go to step 4.
  - c. If you are attempting to load the operating system from a disk drive or an optical drive, go to step 7.
  - d. **No:** Go to step 5.
4. If you are attempting to load the operating system from the network, perform the following steps:
- Verify that the IP parameters are correct.
  - Use the SMS ping utility to attempt to ping the target server. If the ping is not successful, have the network administrator verify the server configuration for this client.
  - Check with the network administrator to ensure that the network is up. Also ask the network administrator to verify the settings on the server from which you are trying to load the operating system.
  - Check the network cabling to the adapter.

Restart the partition and try loading the operating system. Does the operating system load successfully?

**Yes:** This ends the procedure.

**No:** Go to step 7.

5. Use the SMS menus to add the intended boot device to the boot sequence. Can you add the device to the boot sequence?
- Yes:** Restart the partition. **This ends the procedure.**
- No:** Continue with the next step.
6. Ask the customer or system administrator to verify that the device you are trying to load from is assigned to the correct partition. Then select **List All Devices** and record the list of bootable devices that displays. Is the device from which you want to load the operating system in the list?
- Yes:** Go to step 7.
- No:** Go to step 10.
7. Try to load and run standalone diagnostics against the devices in the partition, particularly against the boot device from which you want to load the operating system. You can run standalone diagnostics from an optical drive or a NIM server. To boot standalone diagnostics, follow the detailed procedures in Running the AIX online and standalone diagnostics log.

**Note:** When attempting to load diagnostics on a partition from partition standby, the device from which you are loading standalone diagnostics must be made available to the partition that is not able to load the operating system, if it is not already in that partition. Contact the customer or system administrator if a device must be moved between partitions in order to load standalone diagnostics.

Did standalone diagnostics load and start successfully?

**Yes:** Go to step 8.

**No:** Go to step 14 on page 95.

8. Was the intended boot device present in the output of the option **Display Configuration and Resource List**, that is run from the Task Selection menu?
- **Yes:** Continue with the next step.
  - **No:** Go to step 10.
9. Did running diagnostics against the intended boot device result in a **No Trouble Found** message?
- Yes:** Go to step 12 on page 95.
- No:** Go to the list of service request numbers and perform the repair actions for the SRN reported by the diagnostics. When you have completed the repair actions, go to step 13 on page 95.
10. Perform the following actions:
- a. Perform the first item in the action list below. In the list of actions below, choose SCSI or IDE based on the type of device from which you are trying to boot the operating system.

- b. Restart the system or partition.
- c. Stop at the SMS menus and select **Select Boot Options**.
- d. Is the device that was not appearing previously in the boot list now present?

**Yes:** Go to Verify a repair. **This ends the procedure.**

**No:** Perform the next item in the action list and then return to step 10b. If there are no more items in the action list, go to step 11.

**Action list:**

**Note:** See System FRU locations for part numbers and links to exchange procedures.

- a. Verify that the SCSI or IDE cables are properly connected. Also verify that the device configuration and address jumpers are set correctly.
  - b. Do one of the following:
    - **SCSI boot device:** If you are attempting to boot from a SCSI device, remove all hot-swap disk drives (except the intended boot device, if the boot device is a hot-swap drive). If the boot device is present in the boot list after you boot the system to the SMS menus, add the hot-swap disk drives back in one at a time, until you isolate the failing device.
    - **IDE boot device:** If you are attempting to boot from an IDE device, disconnect all other internal SCSI or IDE devices. If the boot device is present in the boot list after you boot the system to the SMS menus, reconnect the internal SCSI or IDE devices one at a time, until you isolate the failing device or cable.
  - c. Replace the SCSI or IDE cables.
  - d. Replace the SCSI backplane (or IDE backplane, if present) to which the boot device is connected.
  - e. Replace the intended boot device.
  - f. Replace the system backplane.
11. Choose from the following:
    - If the intended boot device is not listed, go to “PFW1548: Memory and processor subsystem problem isolation procedure” on page 112. **This ends the procedure.**
    - If an SRN is reported by the diagnostics, go to the list of service request numbers and follow the action listed. **This ends the procedure.**
  12. Have you disconnected any other devices?
 

**Yes:** Reinstall each device that you disconnected, one at a time. After you reinstall each device, reboot the system. Continue this procedure until you isolate the failing device. Replace the failing device, then go to step 13.

**No:** Perform an operating system-specific recovery process or reinstall the operating system. **This ends the procedure.**
  13. Is the problem corrected?
 

**Yes:** Go to Verify a repair. **This ends the procedure.**

**No:** If replacing the indicated FRUs did not correct the problem, or if the previous steps did not address your situation, go to “PFW1548: Memory and processor subsystem problem isolation procedure” on page 112. **This ends the procedure.**
  14. Is a SCSI boot failure (where you cannot boot from a SCSI-attached device) also occurring?
    - **Yes:** Go to “PFW1548: Memory and processor subsystem problem isolation procedure” on page 112. **This ends the procedure.**
    - **No:** Continue to the next step.
  15. Perform the following actions to determine if another adapter is causing the problem:
    - a. Remove all adapters except the one to which the optical drive is attached and the one used for the console.
    - b. Reload the standalone diagnostics. Can you successfully reload the standalone diagnostics?

- **Yes:** Perform the following steps:
    - 1) Reinstall the adapters that you removed (and attach devices as applicable) one at a time. After you reinstall each adapter, retry the boot operation until the problem reoccurs.
    - 2) Replace the adapter or device that caused the problem.
    - 3) Go to Verify a repair. **This ends the procedure.**
  - **No:** Continue with the next step.
16. The graphics adapter (if installed), optical drive, IDE or SCSI cable, or system board is most likely defective. Does your system have a PCI graphics adapter installed?
- Yes:** Continue with the next step.  
**No:** Go to step 18
17. Perform the following steps to determine if the graphics adapter is causing the problem:
- a. Remove the graphics adapter.
  - b. Attach a TTY terminal to the system port.
  - c. Try to reload standalone diagnostics. Do the standalone diagnostics load successfully?
    - Yes:** Replace the graphics adapter. **This ends the procedure.**
    - No:** Continue with the next step.
18. Replace the following (if not already replaced), one at a time, until the problem is resolved:
- a. Optical drive
  - b. IDE or SCSI cable that goes to the optical drive
  - c. System board that contains the integrated SCSI or IDE adapters.
- If this resolves the problem, go to Verify a repair. If the problem still persists or if the previous descriptions did not address your particular situation, go to “PFW1548: Memory and processor subsystem problem isolation procedure” on page 112.
- This ends the procedure.**

## PFW1540: Problem isolation procedures

The PFW1540 procedures are used to locate problems in the processor subsystem or I/O subsystem.

If a problem is detected, these procedures help you isolate the problem to a failing unit. Find the symptom in the following table; then follow the instructions given in the Action column.

Problem Isolation Procedures	
Symptom/Reference Code/Checkpoint	Action
You have or suspect an I/O card or I/O subsystem failure. You received one of the following SRNs or reference codes: 101-000, 101-517, 101-521, 101-538, 101-551 to 101-557, 101-559 to 101-599, 101-662, 101-727, 101-c32, 101-c33, 101-c70	Go to “PFW1542: I/O problem isolation procedure” on page 97.
You have or suspect a memory or processor subsystem problem. You received the following SRN or reference code: 101-185	Go to “PFW1548: Memory and processor subsystem problem isolation procedure” on page 112.
If you were directed to the PFW1540 procedure by an SRN and that SRN is not listed in this table.	Go to “PFW1542: I/O problem isolation procedure” on page 97.

## FRU identify LEDs

Your system is configured with an arrangement of LEDs that help identify various components of the system. These include but are not limited to:

- Rack identify beacon LED (optional rack status beacon)

- Processor subsystem drawer identify LED
- I/O drawer identify LED
- RIO port identify LED
- FRU identify LED
- Power subsystem FRUs
- Processor subsystem FRUs
- I/O subsystem FRUs
- I/O adapter identify LED
- DASD identify LED

The identify LEDs are arranged hierarchically with the FRU identify LED at the bottom of the hierarchy, followed by the corresponding processor subsystem or I/O drawer identify LED, and the corresponding rack identify LED to locate the failing FRU more easily. Any identify LED in the system may be flashed; see *Managing the Advanced system Management Interface (ASMI)*.

Any identify LED in the system may also be flashed by using the AIX diagnostic programs task “Identify and Attention Indicators”. The procedure to use the AIX diagnostics task “Identify and Attention Indicators” is outlined in “diagnostic and service aids” in *Running the AIX online and standalone diagnostics log*.

### **PFW1542: I/O problem isolation procedure**

This I/O problem-determination procedure isolates I/O card and I/O subsystem failures. When I/O problem isolation is complete, all cables and cards that are failing will have been replaced or reseated.

If you need additional information for failing part numbers, location codes, or removal and replacement procedures, see *Part locations and location codes*. Select your machine type and model number to find additional location codes, part numbers, or replacement procedures for your system.

#### **Notes:**

1. To avoid damage to the system or subsystem components, unplug the power cords before removing or installing a part.
2. This procedure assumes that either:
  - An optical drive is installed and connected to the integrated EIDE adapter, and an AIX standalone diagnostic CD-ROM is available.
  - OR
  - AIX standalone diagnostics can be booted from a NIM server.
3. If a power-on password or privileged-access password is set, you are prompted to enter the password before the AIX standalone diagnostic CD-ROM can load.
4. The term POST indicators refers to the device mnemonics that appear during the power-on self-test (POST).
5. The service processor might have been set by the user to monitor system operations and to attempt recoveries. You might want to disable these options while you diagnose and service the system. If these settings are disabled, make notes of their current settings so that they can be restored before the system is turned back over to the customer.

The following settings may be of interest.

#### **Monitoring**

(also called surveillance) From the ASMI menu, expand the System Configuration menu, then click **Monitoring**. Disable both types of surveillance.

#### **Auto power restart**

(also called unattended start mode) From the ASMI menu, expand **Power/Restart Control**, then click **Auto Power Restart**, and set it to disabled.

## Wake on LAN

From the ASMI menu, expand **Wake on LAN**, and set it to disabled.

## Call Out

From the ASMI menu, expand the Service Aids menu, then click **Call-Home/Call-In Setup**. Set the call-home system port and the call-in system port to disabled.

6. Verify that the system has not been set to boot to the SMS menus or to the open firmware prompt. From the ASMI menu, expand **Power/Restart Control** to view the menu, then click **Power On/Off System**. The AIX/Linux partition mode boot indicates **Continue to Operating System**.

Use this procedure to locate defective FRUs not found by normal diagnostics. For this procedure, diagnostics are run on a minimally configured system. If a failure is detected on the minimally configured system, the remaining FRUs are exchanged one at a time until the failing FRU is identified. If a failure is not detected, FRUs are added back until the failure occurs. The failure is then isolated to the failing FRU.

Perform the following procedure:

### • PFW1542-1

1. Ensure that the diagnostics and the operating system are shut down.
2. Turn off the power.
3. Is system firmware Ax710\_xxx installed?

**No:** Continue to the next sub-step.

**Yes:** Select slow system boot speed on the power on/off system menu under the power/restart control menu on the ASMI.

4. Turn on the power.
5. Insert the AIX diagnostic CD-ROM into the optical drive.

Does the optical drive appear to operate correctly?

**No** Go to "Problems with loading and starting the operating system (AIX and Linux)" on page 93.

**Yes** Continue to PFW1542-2.

### • PFW1542-2

1. When the keyboard indicator is displayed (the word "keyboard"), if the system or partition gets that far in the IPL process, press the 5 key on the firmware console.
2. If you are prompted to do so, enter the appropriate password.

Is the "Please define the System Console" screen displayed?

**No** Continue to PFW1542-3.

**Yes** Go to PFW1542-4.

### • PFW1542-3

The system is unable to boot AIX standalone diagnostics.

Was a slow boot performed?

**No:** Go to "PFW1548: Memory and processor subsystem problem isolation procedure" on page 112. If you were sent here because the system is hanging on a partition firmware checkpoint, and the hang condition did not change as a result of the slow boot, go to PFW1542-5.

**Yes:** Check the service processor error log (using the ASMI) and the operator panel for additional error codes resulting from the slow boot that was performed in PFW1542-1.

Did the slow boot generate a different error code or partition firmware hang from the one that originally sent you to PFW1542?

**No** If you were sent here by an error code, and the error code did not change as the result of a slow boot, you have a processor subsystem problem. Go to "PFW1548: Memory and processor

subsystem problem isolation procedure” on page 112. If you were sent here because the system is hanging on a partition firmware checkpoint, and the hang condition did not change as a result of the slow boot, go to PFW1542-5.

**Yes** Restore fast boot on the power on/off system menu from the ASMI. Look up the new error code in the reference code index and perform the listed actions.

• **PFW1542-4**

The system stopped with the **Please define the System Console** prompt on the system console. AIX standalone diagnostics can be booted. Perform the following steps:

1. Follow the instructions on the screen to select the system console.
2. When the DIAGNOSTIC OPERATING INSTRUCTIONS screen is displayed, press Enter.
3. If the terminal type has not been defined, you must use the option **Initialize Terminal** on the FUNCTION SELECTION menu to initialize the AIX operating system environment before you can continue with the diagnostics. This is a separate operation from selecting the firmware console.
4. Select **Advanced Diagnostic Routines**.
5. When the DIAGNOSTIC MODE SELECTION menu displays, select **System Verification** to run diagnostics on all resources.

Did running diagnostics produce a different symptom?

**No** Continue with the following sub-step.

**Yes** Return to the Problem Analysis procedures with the new symptom.

6. Record any devices missing from the list of all adapters and devices. Continue with this procedure. When you have fixed the problem, use this record to verify that all devices appear when you run system verification.

Are there any devices missing from the list of all adapters and devices?

**No** Reinstall all remaining adapters, if any, and reconnect all devices. Return the system to its original configuration. Be sure to select fast boot on the power on/off system menu on the ASMI. Go to Verify a repair.

**Yes** The boot attempts that follow will attempt to isolate any remaining I/O subsystem problems with missing devices. Ignore any codes that may display on the operator panel unless stated otherwise. Continue to PFW1542-5.

• **PFW1542-5**

Examine RIO port 0 of the first RIO bus card in the base system unit drawer.

Are there any I/O subsystems attached to this RIO card?

**No** Go to PFW1542-29.

**Yes** Continue to PFW1542-6.

• **PFW1542-6**

There may be devices missing from one of more of the I/O subsystems, or one or more devices in the I/O subsystems may be causing the system or a partition to hang during IPL.

**Note:**

- Various types of I/O subsystems might be connected to this system.
- The order in which the RIO or GX+ adapters are listed is the order in which the adapters are used for attaching external I/O boxes. The first adapter listed for the system units should be used in step PFW1548-2. The second adapter listed should be used in step PFW1548-7.

The RIO and 12X ports on these subsystems are shown in the following table. Use this table to determine the physical location codes of the RIO or 12X connectors that are mentioned in the remainder of this MAP.

Table 17. RIO and 12X ports location table

Port	8202-E4B or 8205-E6B (base system)	8202-E4C, 8205-E6C, 8231-E1C, or 8231-E2C (base system)	8231-E2B (base system)	8233-E8B or 8236-E8C (base system)	9117-MMB, 9117-MMC, 9179-MHB, or 9179-MHC (base system drawer)	7314-G30 or 5796
Port 0	Un-P1-C2-T2 Un-P1-C8-T2	Un-P1-C1-T2 Un-P1-C8-T2	Un-P1-C1-T2 Un-P1-C7-T2	Un-P1-C8-T2 Un-P1-C7-T2	Un-P1-C2-T2 (and Un-P1-C3-T2 if present)	Un-P1-C7-T2
Port 1	Un-P1-C2-T1 Un-P1-C8-T1	Un-P1-C1-T1 Un-P1-C8-T1	Un-P1-C1-T1 Un-P1-C7-T1	Un-P1-C8-T1 Un-P1-C7-T1	Un-P1-C2-T1 (and Un-P1-C3-T1 if present)	Un-P1-C7-T1

**Note:** Before continuing, check the cabling from the base system to the I/O subsystem to ensure that the system is cabled correctly. See the cabling information for your I/O enclosure for valid configurations. Record the current cabling configuration and then continue with the following steps.

In the following steps, the term *RIO* means either RIO or 12X.

1. Turn off the power. Record the location and machine type and model number, or feature number, of each I/O drawer or tower. In the following steps, use this information to determine the physical location codes of the RIO connectors that are referred to by their logical names. For example, if I/O subsystem 1 is a 7311-D20 drawer, RIO port 0 is Un-P1-C05-T2.
2. At the base system drawer, disconnect the cable connection at RIO port 0.
3. At the other end of the RIO cable referred to in step 2 of PFW1542-6, disconnect the I/O subsystem port connector 0. The RIO cable that was connected to RIO port 0 in the base system should now be loose; remove it. Record the location of this I/O subsystem and call it "subsystem 1".
4. Examine the connection at the I/O port connector 1 of the I/O subsystem recorded in step 3 of PFW1542-6. If the RIO cable attached to I/O port connector 1 connects to the I/O port connector 0 of another I/O subsystem, record the location of the next I/O subsystem that is connected to I/O port 1 of subsystem 1, then go to step 8 of PFW1542-6.
5. At the base system, disconnect the cable connection at RIO port 1 and reconnect it to RIO port 0.
6. At the I/O subsystem recorded in step 3 of PFW1542-6, disconnect the I/O port connector 1 and reconnect to I/O port 0.
7. Verify that a single RIO cable connects the base system RIO port 0 to port 0 of the I/O subsystem recorded in step 4. Go to step 28 of PFW1542-6.
8. Record the location of the next I/O subsystem and call it "subsystem 2". This is the I/O subsystem that is connected to I/O port 1 of subsystem 1.
9. Examine the connection at the I/O port 1 of subsystem 2 recorded in step 8 of PFW1542-6. If the RIO cable attached to I/O port 1 connects to the I/O port 0 of another I/O subsystem, record the location of the next I/O subsystem that is connected to I/O port 1 of subsystem 2 and call it "subsystem 3". Go to step 13 of PFW1542-6.
10. The RIO cable attached to the I/O port 1 of subsystem 2 is attached to port 1 of the base system. At the base system, disconnect the cable connection at RIO port 1 and reconnect it to RIO port 0.
11. On subsystem 2, disconnect the cable from I/O port 1 and reconnect it to I/O port 0 of subsystem 1.
12. Verify that a single RIO cable connects base system RIO port 0 to one or two I/O subsystems. Go to step 28 of PFW1542-6.



13. Examine the connection at the I/O port 1 of subsystem 3 recorded in step 9 of PFW1542-6. If the RIO cable attached to I/O port 1 connects to the I/O port 0 of another I/O subsystem, record the location of the next I/O subsystem that is connected to I/O port 1 of the subsystem 3 and call it "subsystem 4". Go to step 17 of PFW1542-6.
14. The RIO cable attached to the I/O port 1 of subsystem 3 is attached to port 1 of the base system. At the base system, disconnect the cable connection at RIO port 1 and reconnect it to RIO port 0.
15. On subsystem 3, disconnect the cable from I/O port 1 and reconnect it to I/O port 0 of subsystem 1.
16. Verify that a single RIO cable connects base system RIO port 0 to three I/O subsystems. Go to step 28 of PFW1542-6.
17. Examine the connection at the I/O port 1 of subsystem 4 recorded in step step 13 of PFW1542-6. If the RIO cable attached to I/O port 1 connects to the I/O port 0 of another I/O subsystem, record the location of the next I/O subsystem that is connected to I/O port 1 of subsystem 4 and call it "subsystem 5". Go to step step 21 of PFW1542-6.
18. The RIO cable attached to the I/O port 1 of subsystem 4 is attached to port 1 of the base system. At the base system, disconnect the cable connection at RIO port 1 and reconnect it to RIO port 0.
19. On subsystem 4, disconnect the cable from I/O port 1 and reconnect it to I/O port 0 of subsystem 1.
20. Verify that a single RIO cable connects base system RIO port 0 to four I/O subsystems. Continue to step 28 of PFW1542-6.
21. Examine the connection at the I/O port 1 of subsystem 5 recorded in step step 17 of PFW1542-6. If the RIO cable attached to I/O port 1 connects to the I/O port 0 of another I/O subsystem, record the location of the next I/O subsystem that is connected to I/O port 1 of subsystem 5 and call it "subsystem 6". Go to step step 25 of PFW1542-6
22. The RIO cable attached to the I/O port 1 of subsystem 5 is attached to port 1 of the base system. At the base system, disconnect the cable connection at RIO port 1 and reconnect it to RIO port 0.
23. On subsystem 5, disconnect the cable from I/O port 1 and reconnect it to I/O port 0 of subsystem 1.
24. Verify that a single RIO cable connects base system RIO port 0 to five I/O subsystems. Go to step 28 of PFW1542-6
25. The RIO cable attached to the I/O port 1 of subsystem 6 is attached to port 1 of the base system. At the base system, disconnect the cable connection at RIO port 1 and reconnect it to RIO port 0.
26. On subsystem 6, disconnect the cable from I/O port 1 and reconnect it to I/O port 0 of subsystem 1.
27. Verify that a single RIO cable connects base system RIO port 0 to six I/O subsystems. Continue with step 28 of PFW1542-6
28. Turn on the power to boot the AIX standalone diagnostics from CD-ROM.
29. If the "Please define the system console" screen is displayed, follow the directions to select the system console.
30. Use the option **Display Configuration and Resource List** to list all of the attached devices and adapters.
31. Verify that all adapters and the attached devices are listed.

Did the "Please define the System Console" screen display and are all adapters and attached devices listed?

**No** Go to PFW1542-7.

**Yes** The RIO cable that was removed in step 3 above is defective. Replace this RIO cable.

- If six I/O subsystems are chained to RIO port 0 of the base system, connect the new RIO cable from subsystem 6 I/O port 1 to base system RIO port 1.
- If five I/O subsystems are chained to RIO port 0 of the base system, connect the new RIO cable from subsystem 5 I/O port 1 to base system RIO port 1.

- If four I/O subsystems are chained to RIO port 0 of the base system, connect the new RIO cable from subsystem 4 I/O port 1 to base system RIO port 1.
- If three I/O subsystems are chained to RIO port 0 of the base system, connect the new RIO cable from subsystem 3 I/O port 1 to base system RIO port 1.
- If two I/O subsystems are chained to RIO port 0 of the base system, connect the new RIO cable from subsystem 2 I/O port 1 to base system RIO port 1.
- If one I/O subsystem is chained to RIO port 0 of the base system, connect the new RIO cable from subsystem 1 I/O port 1 to base system RIO port 1.

Restore the system to its original configuration. Go to Verify a repair.

- **PFW1542-7**

The I/O device attached to the other RIO ports are now isolated. Power off the system. Disconnect the cable connection at RIO port 0 of the base system.

- **PFW1542-8**

1. Turn on the power to boot the AIX standalone diagnostic CD-ROM.
2. If the "Please define the system console" screen is displayed, follow the directions to select the system console.
3. Use the option **Display Configuration and Resource List** to list all of the attached devices and adapters.
4. Check that all adapters and attached devices in the base system are listed.

If the "Please define the system console" screen was not displayed or all adapters and attached devices are not listed, the problem is in the base system.

Was the "Please define the system console" screen displayed and were all adapters and attached devices listed?

**No** Go to PFW1542-29.

**Yes** Go to PFW1542-21.

- **PFW1542-9**

For subsystem 1: **Are there any adapters in the I/O subsystem?**

**No** Go to PFW1542-10.

**Yes** Go to PFW1542-15.

- **PFW1542-10**

For subsystem 2: **Are there any adapters in the I/O subsystem?**

**No** Go to PFW1542-11.

**Yes** Go to PFW1542-16.

- **PFW1542-11**

For subsystem 3: **Are there any adapters in the I/O subsystem?**

**No** Go to PFW1542-12.

**Yes** Go to PFW1542-17.

- **PFW1542-12**

For subsystem 4: **Are there any adapters in the I/O subsystem?**

**No** Go to PFW1542-13.

**Yes** Go to PFW1542-18.

- **PFW1542-13**

For subsystem 5: **Are there any adapters in the I/O subsystem?**

**No** Go to PFW1542-14.

**Yes** Go to PFW1542-19.

• **PFW1542-14**

For subsystem 6: **Are there any adapters in the I/O subsystem?**

**No** Go to PFW1542-23.

**Yes** Go to PFW1542-20.

• **PFW1542-15 (Subsystem 1)**

1. If it is not already off, turn off the power.
2. Label and record the locations of any cables attached to the adapters, then disconnect the cables.
3. Record the slot numbers of the adapters.
4. Remove all adapters from the I/O subsystem.
5. Turn on the power to boot the AIX standalone diagnostic CD-ROM.
6. If the ASCII terminal displays **Enter 0 to select this console**, press the 0 (zero) key on the ASCII terminal's keyboard.
7. If the "Please select the system console" screen is displayed, follow the directions to select the system console.
8. Use the option **Display Configuration and Resource List** to list all adapters and attached devices.
9. Check that all adapters and attached devices are listed.

Was the "Please define the system console" screen displayed and were all adapters and attached devices listed?

**No** Go to PFW1542-10.

**Yes** Go to PFW1542-21.

• **PFW1542-16 (Subsystem 2)**

1. If it is not already off, turn off the power.
2. Label and record the locations of any cables attached to the adapters, then disconnect the cables.
3. Record the slot numbers of the adapters.
4. Remove all adapters from the I/O subsystem.
5. Turn on the power to boot the AIX standalone diagnostic CD-ROM.
6. If the ASCII terminal displays **Enter 0 to select this console**, press the 0 (zero) key on the ASCII terminal's keyboard.
7. If the "Please select the system console" screen is displayed, follow the directions to select the system console.
8. Use the option **Display Configuration and Resource List** to list all adapters and attached devices.
9. Check that all adapters and attached devices are listed.

Was the "Please define the system console" screen displayed and were all adapters and attached devices listed?

**No** Go to PFW1542-11.

**Yes** Go to PFW1542-21.

• **PFW1542-17 (Subsystem 3)**

1. If it is not already off, turn off the power.
2. Label and record the locations of any cables attached to the adapters, then disconnect the cables.
3. Record the slot numbers of the adapters.
4. Remove all adapters from the I/O subsystem.
5. Turn on the power to boot the AIX standalone diagnostic CD-ROM.
6. If the ASCII terminal displays **Enter 0 to select this console**, press the 0 (zero) key on the ASCII terminal's keyboard.

7. If the "Please select the system console" screen is displayed, follow the directions to select the system console.
8. Use the option **Display Configuration and Resource List** to list all adapters and attached devices.
9. Check that all adapters and attached devices are listed.

Was the "Please define the system console" screen displayed and were all adapters and attached devices listed?

**No** Go to PFW1542-12.

**Yes** Go to PFW1542-21.

• **PFW1542-18 (Subsystem 4)**

1. If it is not already off, turn off the power.
2. Label and record the locations of any cables attached to the adapters, then disconnect the cables.
3. Record the slot numbers of the adapters.
4. Remove all adapters from the I/O subsystem.
5. Turn on the power to boot the AIX standalone diagnostic CD-ROM.
6. If the ASCII terminal displays **Enter 0 to select this console**, press the 0 (zero) key on the ASCII terminal's keyboard.
7. If the "Please define the system console" screen is displayed, follow the directions to select the system console.
8. Use the option **Display Configuration and Resource List** to list all adapters and attached devices.
9. Check that all adapters and attached devices are listed.

Was the "Please define the system console" screen displayed and were all adapters and attached devices listed?

**No** Go to PFW1542-13.

**Yes** Go to PFW1542-21.

• **PFW1542-19 (Subsystem 5)**

1. If it is not already off, turn off the power.
2. Label and record the locations of any cables attached to the adapters, then disconnect the cables.
3. Record the slot numbers of the adapters.
4. Remove all adapters from the I/O subsystem.
5. Turn on the power to boot the AIX standalone diagnostic CD-ROM.
6. If the ASCII terminal displays **Enter 0 to select this console**, press the 0 (zero) key on the ASCII terminal's keyboard.
7. If the "Please define the system console" screen is displayed, follow the directions to select the system console.
8. Use the option **Display Configuration and Resource List** to list all adapters and attached devices.
9. Check that all adapters and attached devices are listed.

Was the "Please define the system console" screen displayed and were all adapters and attached devices listed?

**No** Go to PFW1542-14.

**Yes** Go to PFW1542-21.

• **PFW1542-20 (Subsystem 6)**

1. If it is not already off, turn off the power.
2. Label and record the locations of any cables attached to the adapters, then disconnect the cables.
3. Record the slot numbers of the adapters.
4. Remove all adapters from the I/O subsystem.

5. Turn on the power to boot the AIX standalone diagnostic CD-ROM.
6. If the ASCII terminal displays **Enter 0 to select this console**, press the 0 (zero) key on the ASCII terminal's keyboard.
7. If the "Please define the system console" screen is displayed, follow the directions to select the system console.
8. Use the option **Display Configuration and Resource List** to list all adapters and attached devices.
9. Check that all adapters and attached devices are listed.

Was the "Please define the system console" screen displayed and were all adapters and attached devices listed?

**No** Go to PFW1542-23.

**Yes** Go to PFW1542-21.

- **PFW1542-21**

If the "Please define the system console" screen was displayed and all adapters and attached devices were not listed, the problem is with one of the adapters or attached devices that was removed or disconnected from the I/O subsystem.

1. Turn off the power.
2. Reinstall one adapter or device that was removed. Use the original adapters in their original slots when reinstalling adapters.
3. Turn on the power to boot the AIX standalone diagnostic CD-ROM.
4. If the "Please define the system console" screen is displayed, follow the directions to select the system console.
5. Use the option **Display Configuration and Resource List** to list all adapters and attached devices.
6. Check that all adapters and attached devices are listed.

Was the "Please define the system console" screen displayed and were all adapters and attached devices listed?

**No** Go to PFW1542-22.

**Yes** Reinstall the next adapter and device and return to the beginning of this step. Repeat this process until an adapter or device causes the "Please define the System Console" screen to not display, or all attached devices and adapters to not be listed.

After installing all of the adapters and the "Please define the System Console" screen does display and all attached devices and adapters are listed, return the system to its original configuration. Go to Verify a repair.

- **PFW1542-22**

Replace the adapter you just installed with a new adapter and retry booting AIX standalone diagnostics from CD-ROM.

1. If the "Please define the system console" screen is displayed, follow the directions to select the system console.
2. Use the option **Display Configuration and Resource List** to list all adapters and attached devices.
3. Check that all adapters and attached devices are listed.

Was the "Please define the system console" screen displayed and were all adapters and attached devices listed?

**No** The I/O subsystem backplane is defective. Replace the I/O subsystem backplane. In all 4 subsystem types, the I/O subsystem backplane is *Un-CB1*. Then go to PFW1542-24.

**Yes** The adapter was defective. Go to PFW1542-24.

- **PFW1542-23**

1. Turn off the power.
2. Disconnect the I/O subsystem power cables.

3. Replace the following parts, one at a time, if present, in the sequence listed:
  - a. I/O subsystem 1 backplane
  - b. I/O subsystem 2 backplane
  - c. I/O subsystem 3 backplane
  - d. I/O subsystem 4 backplane
  - e. I/O subsystem 5 backplane
  - f. I/O subsystem 6 backplane
  - g. The RIO interface in the base system to which the RIO cables are presently attached.
4. Reconnect the I/O subsystem power cables.
5. Turn on the power.
6. Boot AIX standalone diagnostics from CD.
7. If the "Please define the System Console" screen is displayed, follow directions to select the system console.
8. Use the option **Display Configuration and Resource List** to list all adapters and attached devices.
9. Check that all attached devices and adapters are listed.

Did the "Please define the System Console" screen display and are all attached devices and adapters listed?

**No** Replace the next part in the list and return to the beginning of this step. Repeat this process until a part causes the "Please define the System Console" screen to be displayed and all adapters and attached devices to be listed. If you have replaced all the items listed above and the "Please define the System Console" screen does not display or all attached devices and adapters are not listed, check all external devices and cabling. If you do not find a problem, contact your next level of support for assistance.

**Yes** Go to PFW1542-22.

• **PFW1542-24**

The item you just replaced fixed the problem.

1. Turn off the power.
2. If a display adapter with keyboard and mouse were installed, reinstall the display adapter, keyboard, and mouse.
3. Reconnect the tape drive (if previously installed) to the internal SCSI bus cable.
4. Plug in all adapters that were previously removed but not reinstalled.
5. Reconnect the I/O subsystem power cables that were previously disconnected.

Return the system to its original condition. Go to Verify a repair.

• **PFW1542-25**

1. Turn off the power.
2. At the base system, reconnect the cable connection at RIO port 0 recorded in PFW1542-7.
3. At the base system, reconnect the cable connection at RIO port 1 recorded in PFW1542-7.
4. Reconnect the power cables to the I/O subsystems that were found attached to the base system RIO ports mentioned in step 2 and step 3 of PFW1542-25. All I/O subsystems that were attached to the base system RIO port 0 and RIO port 1 should now be reconnected to the base system.
5. Make sure the I/O subsystem are cabled correctly. See the cabling information for your I/O subsystem.
6. Turn on the power to boot AIX standalone diagnostics from CD-ROM.
7. If the "Please define the System Console" screen is displayed, follow the directions to select the system console.
8. Use the option **Display Configuration and Resource List** to list all adapters and attached devices.
9. Check that all adapters and attached devices are listed.

Did the "Please define the System Console" screen display and are all attached devices and adapters listed?

**No** Go to PFW1542-9 to isolate a problem in an I/O subsystem attached to the base system RIO bus on the system backplane.

**Yes** Go to PFW1542-26.

- **PFW1542-26**

Is there a second RIO/12X in the base system, and if so, is there at least one I/O subsystem attached to it?

**No** Go to PFW1542-29.

**Yes** Continue to PFW1542-27.

- **PFW1542-27**

1. Turn off the power.
2. At the base system, reconnect the cable connection at RIO port 0 on the second RIO/12X controller recorded in PFW1542-7.
3. At the base system, reconnect the cable connection at RIO port 1 on the second RIO/12X controller recorded in PFW1542-7.
4. Reconnect the power cables to the I/O subsystems that were attached to the second ports mentioned in substeps 2 and 3 in this step. All I/O subsystems that were attached to RIO port 0 on the second RIO/12X controller and RIO port 1 on the second RIO/12X controller in the base system should now be reconnected to the system.
5. Make sure that the I/O subsystem are cabled correctly as shown in the cabling information for your I/O expansion unit.
6. Turn on the power to boot the AIX standalone diagnostic CD-ROM.
7. If the Please define the system console screen is displayed, follow the directions to select the system console.
8. Use the option **Display Configuration and Resource List** to list all adapters and attached devices.
9. Verify that all adapters and attached devices are listed.

Did the "Please define the system console" screen display and are all adapters and attached devices listed?

**No** Go to PFW1542-28 to isolate the problems in the I/O subsystems that are attached to the second RIO expansion card or GX adapter in the base system.

**Yes** Go to PFW1542-29.

- **PFW1542-28**

At the base system, reconnect the second I/O subsystem to the RIO ports on the base system's RIO expansion cards or GX adapters

The RIO ports on these subsystems are shown in the following table. Use this table to determine the physical location codes of the RIO connectors that are mentioned in the remainder of this MAP.

**Note:** The order in which the RIO or GX+ adapters are listed is the order in which the adapters are used for attaching external I/O boxes. The first adapter listed for the system units should be used in step PFW1548-2. The second adapter listed should be used in step PFW1548-7.

Table 18. RIO and 12X ports location table

Port	8202-E4B or 8205-E6B (base system)	8202-E4C, 8205-E6C, 8231-E1C, or 8231-E2C (base system)	8231-E2B (base system)	8233-E8B or 8236-E8C (base system)	9117-MMB, 9117-MMC, 9179-MHB, or 9179-MHC (base system drawer)	7314-G30 or 5796
Port 0	Un-P1-C2-T2 Un-P1-C8-T2	Un-P1-C1-T2 Un-P1-C8-T2	Un-P1-C1-T2 Un-P1-C7-T2	Un-P1-C8-T2 Un-P1-C7-T2	Un-P1-C2-T2 (and Un-P1-C3-T2 if present)	Un-P1-C7-T2
Port 1	Un-P1-C2-T1 Un-P1-C8-T1	Un-P1-C1-T1 Un-P1-C8-T1	Un-P1-C1-T1 Un-P1-C7-T1	Un-P1-C8-T1 Un-P1-C7-T1	Un-P1-C2-T1 (and Un-P1-C3-T1 if present)	Un-P1-C7-T1

**Note:** Before continuing, check the cabling from the base system to the I/O subsystem to ensure that the system is cabled correctly. Record the current cabling configuration and then continue with the following steps.

1. Turn off the power. Record the location and machine type and model number, or feature number, of each I/O drawer or tower. In the following steps, use this information to determine the physical location codes of the RIO connectors that are referred to by their logical names. For example, if I/O subsystem 1 is a 7311/D20 drawer, RIO port 0 is Un-P1-C05-T2.
2. At the base system, disconnect the cable connection at RIO port 0.
3. At the other end of the RIO cable referred to in step 2 of PFW1542-28, disconnect the I/O subsystem port connector 0. The RIO cable that was connected to RIO port 0 on the expansion card should now be loose; remove it. Record the location of this I/O subsystem and call it "subsystem 1".
4. Examine the connection at the I/O port connector 1 of the I/O subsystem recorded in step 3 of PFW1542-28. If the RIO cable attached to I/O port connector 1 connects to the I/O port connector 0 of another I/O subsystem, record the location of the next I/O subsystem that is connected to I/O port 1 of subsystem 1, then go to step 8 of PFW1542-28.
5. At the base system, disconnect the cable connection at RIO port 1 and reconnect it to RIO port 0.
6. At the I/O subsystem recorded in step 3 of PFW1542-28, disconnect the I/O port connector 1 and reconnect to I/O port 0.
7. Verify that a single RIO cable connects the base system RIO port 0 to port 0 of the I/O subsystem recorded in step 4 of PFW1542-28. Go to step 28 of PFW1542-28.
8. Record the location of the next I/O subsystem and call it "subsystem 2". This is the I/O subsystem that is connected to I/O port 1 of subsystem 1.
9. Examine the connection at the I/O port 1 of subsystem 2 recorded in step 8 of PFW1542-28. If the RIO cable attached to I/O port 1 connects to the I/O port 0 of another I/O subsystem, record the location of the next I/O subsystem that is connected to I/O port 1 of subsystem 2 and call it "subsystem 3". Go to step 13 of PFW1542-28.
10. The RIO cable attached to the I/O port 1 of subsystem 2 is attached to port 1 of the base system. At the base system, disconnect the cable connection at RIO port 1 and reconnect it to RIO port 0.
11. On subsystem 2, disconnect the cable from I/O port 1 and reconnect it to I/O port 0 of subsystem 1.
12. Verify that a single RIO cable connects base system RIO port 0 to two I/O subsystems. Go to step 28 of PFW1542-28.



13. Examine the connection at the I/O port 1 of subsystem 3 recorded in step 9 of PFW1542-28. If the RIO cable attached to I/O port 1 connects to the I/O port 0 of another I/O subsystem, record the location of the next I/O subsystem that is connected to I/O port 1 of the subsystem 3 and call it "subsystem 4". Go to step 17 of PFW1542-28.
14. The RIO cable attached to the I/O port 1 of subsystem 3 is attached to port 1 of the base system. At the base system, disconnect the cable connection at RIO port 1 and reconnect it to RIO port 0.
15. On subsystem 3, disconnect the cable from I/O port 1 and reconnect it to I/O port 0 of subsystem 1.
16. Verify that a single RIO cable connects base system RIO port 0 to three I/O subsystems. Go to step 28 of PFW1542-28.
17. Examine the connection at the I/O port 1 of subsystem 4 recorded in step 13 of PFW1542-28. If the RIO cable attached to I/O port 1 connects to the I/O port 0 of another I/O subsystem, record the location of the next I/O subsystem that is connected to I/O port 1 of subsystem 4 and call it "subsystem 5". Go to step 21 of PFW1542-28
18. The RIO cable attached to the I/O port 1 of subsystem 4 is attached to port 1 of the base system. At the base system, disconnect the cable connection at RIO port 1 and reconnect it to RIO port 0.
19. On subsystem 4, disconnect the cable from I/O port 1 and reconnect it to I/O port 0 of subsystem 1.
20. Verify that a single RIO cable connects base system RIO port 0 to four I/O subsystems. Go to step 27 of PFW1542-28.
21. Examine the connection at the I/O port 1 of subsystem 5 recorded in step 17 of PFW1542-28. If the RIO cable attached to I/O port 1 connects to the I/O port 0 of another I/O subsystem, record the location of the next I/O subsystem that is connected to I/O port 1 of the subsystem 5 and call it "subsystem 6". Go to step 25 of PFW1542-28.
22. The RIO cable attached to the I/O port 1 of subsystem 5 is attached to port 1 of the base system. At the base system, disconnect the cable connection at RIO port 1 and reconnect it to RIO port 0.
23. On subsystem 5, disconnect the cable from I/O port 1 and reconnect it to I/O port 0 of subsystem 1.
24. Verify that a single RIO cable connects base system RIO port 0 to five I/O subsystems. Go to step 28 of PFW1542-28.
25. The RIO cable attached to the I/O port 1 of subsystem 6 is attached to port 1 of the base system. At the base system, disconnect the cable connection at RIO port 1 and reconnect it to RIO port 0.
26. On subsystem 6, disconnect the cable from I/O port 1 and reconnect it to I/O port 0 of subsystem 1.
27. Verify that a single RIO cable connects base system RIO port 0 to six I/O subsystems. Go to step 28 of PFW1542-28.
28. Turn on the power to boot the AIX standalone diagnostics from CD-ROM.
29. If the "Please define the system console" screen is displayed, follow the directions to select the system console.
30. Use the option **Display Configuration and Resource List** to list all of the attached devices and adapters.
31. Verify that all adapters and the attached devices are listed.

Did the "Please define the system console" screen display and are all adapters and attached devices listed?

**No** Go to PFW1542-9.

**Yes** The RIO cable that was removed in step 3 above is defective. Replace this RIO cable.

- If six I/O subsystems are chained to RIO port 0 of the base system, connect the new RIO cable from subsystem 6 I/O port 1 to base system RIO port 1.
- If five I/O subsystems are chained to RIO port 0 of the base system, connect the new RIO cable from subsystem 5 I/O port 1 to base system RIO port 1.

- If four I/O subsystems are chained to RIO port 0 of the base system, connect the new RIO cable from subsystem 4 I/O port 1 to base system RIO port 1.
- If three I/O subsystems are chained to RIO port 0 of the base system, connect the new RIO cable from subsystem 3 I/O port 1 to base system RIO port 1.
- If two I/O subsystems are chained to RIO port 0 of the base system, connect the new RIO cable from subsystem 2 I/O port 1 to base system RIO port 1.
- If one I/O subsystem is chained to RIO port 0 of the base system, connect the new RIO cable from subsystem 1 I/O port 1 to base system RIO port 1.

Restore the system back to its original configuration. Go to Verify a repair.

- **PFW1542-29**

Are there any adapters in the PCI slots in the base system?

**No** Go to PFW1542-30.

**Yes** Go to PFW1542-32.

- **PFW1542-30**

Replace the system backplane, Un-P1. Continue to PFW1542-31.

- **PFW1542-31**

1. Boot AIX standalone diagnostics from CD.
2. If the "Please define the System Console" screen is displayed, follow directions to select the system console.
3. Use the Display Configuration and Resource List to list all adapters and attached devices.
4. Check that all adapters and attached devices are listed.

Did the "Please define the System Console" screen display and are all attached devices and adapters listed?

**No** Go to PFW1542-35.

**Yes** Go to PFW1542-24.

- **PFW1542-32**

1. If it is not already off, turn off the power.
2. Label and record the location of any cables attached to the adapters.
3. Record the slot number of the adapters.
4. Remove all adapters from slots 1, 2, 3, 4, 5, and 6 in the base system that are not attached to the boot device.
5. Turn on the power to boot AIX standalone diagnostics from CD-ROM.
6. If the ASCII terminal displays **Enter 0 to select this console**, press the 0 key on the ASCII terminal's keyboard.
7. If the "Please define the System Console" screen is displayed, follow directions to select the system console.
8. Use the option **Display Configuration and Resource List** to list all adapters and attached devices.
9. Check that all adapters and attached devices are listed.

Did the "Please define the System Console" screen display and are all attached devices and adapters listed?

**No** Go to PFW1542-35.

**Yes** Continue to PFW1542-33.

- **PFW1542-33**

If the "Please define the System Console" screen does display and all adapters and attached devices are listed, the problem is with one of the adapters or devices that was removed or disconnected from the base system.

1. Turn off the power.
2. Reinstall one adapter and device that was removed. Use the original adapters in their original slots when reinstalling adapters.
3. Turn on the power to boot AIX standalone diagnostics from the optical drive.
4. If the "Please define the System Console" screen is displayed, follow the directions to select the system console.
5. Use the Display Configuration and Resource List to list all adapters and attached devices.
6. Check that all adapters and attached devices are listed.

Did the "Please define the System Console" screen display and are all attached devices and adapters listed?

**No** Continue to PFW1542-34.

**Yes** Return to the beginning of this step to continue reinstalling adapters and devices.

- **PFW1542-34**

Replace the adapter you just installed with a new adapter and retry the boot to AIX standalone diagnostics from CD-ROM.

1. If the "Please Define the System Console" screen is displayed, follow directions to select the system console.
2. Use the option **Display Configuration and Resource List** to list all adapters and attached devices.
3. Check that all adapters and attached devices are listed.

Did the "Please define the System Console" screen display and are all attached devices and adapters listed?

**No** Go to PFW1542-30.

**Yes** The adapter you just replaced was defective. Go to PFW1542-24.

- **PFW1542-35**

1. Turn off the power.
2. Disconnect the base system power cables.
3. Replace the following parts, one at a time, in the sequence listed:
  - a. Optical drive
  - b. Removable media backplane and cage assembly
  - c. Disk drive backplane and cage assembly
  - d. I/O backplane, location *Un-P1*
  - e. Service processor
4. Reconnect the base system power cables.
5. Turn on the power.
6. Boot AIX standalone diagnostics from CD.
7. If the "Please define the System Console" screen is displayed, follow directions to select the system console.
8. Use the option **Display Configuration and Resource List** to list all adapters and attached devices.
9. Check that all adapters and attached devices are listed.

Did the "Please define the System Console" screen display and are all adapters and attached devices listed?

**No** Replace the next part in the list and return to the beginning of this step. Repeat this process until a part causes the Please define the System Console screen to be displayed and all adapters and attached devices to be listed. If you have replaced all the items listed above and the Please define the System Console screen does not display or all adapters and attached

devices are not listed, check all external devices and cabling. If you do not find a problem, contact your next level of support for assistance.

**Yes** Go to PFW1542-24.

## **PFW1548: Memory and processor subsystem problem isolation procedure**

Use this problem isolation procedure to aid in solving memory and processor problems that are not found by normal diagnostics.

### **Notes:**

1. To avoid damage to the system or subsystem components, unplug the power cords before removing or installing any part.
2. This procedure assumes that either:
  - An optical drive is installed and connected to the integrated EIDE adapter, and an AIX diagnostic CD-ROM is available.
  - OR
  - AIX standalone diagnostics can be booted from a NIM server.
3. If a power-on password or privileged-access password is set, you are prompted to enter the password before the AIX diagnostic CD-ROM can load.
4. The term POST indicators refers to the device mnemonics that appear during the power-on self-test (POST).
5. The service processor might have been set by the user to monitor system operations and to attempt recoveries. You might want to disable these options while you diagnose and service the system. If these settings are disabled, make notes of their current settings so that they can be restored before the system is turned back over to the customer. The following settings may be of interest.

### **Monitoring**

(also called surveillance) From the ASMI menu, expand the **System Configuration** menu, then click **Monitoring**. Disable both types of surveillance.

### **Auto power restart**

(also called unattended start mode) From the ASMI menu, expand **Power/Restart Control**, then click **Auto Power Restart**, and set it to disabled.

### **Wake on LAN**

From the ASMI menu, expand **Wake on LAN**, and set it to disabled.

### **Call Out**

From the ASMI menu, expand the **Service Aids** menu, then click **Call-Home/Call-In Setup**. Set the call-home system port and the call-in system port to disabled.

6. Verify that the system has not been set to boot to the System Management Services (SMS) menus or to the open firmware prompt. From the ASMI menu, expand **Power/Restart Control** to view the menu, then click **Power On/Off System**. The AIX/Linux partition mode boot should say "Continue to Operating System".
7. The service processor might have recorded one or more symptoms in its error/event log. Use the Advanced System Management Interface (ASMI) menus to view the error/event log.
  - If you arrived here after performing a slow boot, look for a possible new error that occurred during the slow boot. If there is a new error, and its actions call for a FRU replacement, perform those actions. If this does not resolve the problem, go to PFW1548-1.
  - If an additional slow boot has not been performed, or if the slow boot did not yield a new error code, look at the error that occurred just before the original error. Perform the actions associated with that error. If this does not resolve the problem, go to PFW1548-1.
  - If a slow boot results in the same error code, and there are no error codes before the original error code, go to PFW1548-1.

Perform the following procedure:

- **PFW1548-1**

1. Ensure that the diagnostics and the operating system are shut down.

Is the system at "service processor standby", indicated by 01 in the control panel?

**No** Replace the system backplane, location: *Un-P1*. Return to the beginning of this step.

**Yes** Continue with substep 2.

2. Turn on the power using either the white button or the ASMI menus.

If an HMC is attached, does the system reach hypervisor standby as indicated on the management console? If a management console is not attached, does the system reach an operating system login prompt, or if booting the AIX standalone diagnostic CD-ROM, is the Please define the System Console screen displayed?

**No** Go to PFW1548-3.

**Yes** Go to PFW1548-2.

3. Insert the AIX standalone diagnostic CD-ROM into the optical drive.

**Note:** If you cannot insert the diagnostic CD-ROM, go to PFW1548-2.

4. When the word *keyboard* is displayed on an ASCII terminal, a directly attached keyboard, or management console, press the number 5 key.

5. If you are prompted to do so, enter the appropriate password.

Is the "Please define the System Console" screen displayed?

**No** Go to PFW1548-2.

**Yes** Go to PFW1548-14.

- **PFW1548-2**

Insert the AIX standalone diagnostic CD-ROM into the optical drive.

**Note:** If you cannot insert the AIX standalone diagnostic CD-ROM, go to step PFW1548-3.

Turn on the power using either the white button or the ASMI menus. (If the AIX standalone diagnostic CD-ROM is not in the optical drive, insert it now.) If a management console is attached, after the system has reached hypervisor standby, activate a Linux or AIX partition by clicking the **Advanced** button on the activation screen. On the Advanced activation screen, select **Boot in service mode using the default boot list** to boot the AIX standalone diagnostic CD-ROM.

If you are prompted to do so, enter the appropriate password.

Is the "Please define the System Console" screen displayed?

**No** Go to PFW1548-3.

**Yes** Go to PFW1548-14.

- **PFW1548-3**

1. Turn off the power.

2. If you have not already done so, configure the service processor (using the ASMI menus) with the instructions in note 6 at the beginning of this procedure, then return here and continue.

3. Exit the service processor (ASMI) menus and remove the power cords.

4. Disconnect all external cables (parallel, system port 1, system port 2, keyboard, mouse, USB devices, SPCN, Ethernet on the system planar, and so on). Also disconnect all of the external cables attached to the service processor except the Ethernet cable going to the management console, if a management console is attached.

5. Is the system a 9117-MMB, 9117-MMC, 9179-MHB, or 9179-MHC, and is there more than one processor drawer in the system?

**No:** Go to PFW1548-4.

**Yes:** Go to PFW1548-3.1.

Go to the next step.

- **PFW1548-3.1**

Disconnect the flex cables from the front and the back of all the processor drawers if not already disconnected. Does the processor drawer with the service processor card power on OK?

**No:** Go to the next step.

**Yes:** Go to PFW1548-13.2.

- **PFW1548-4**

Locate the system machine type and model you are servicing and determine the action to perform.

**8202-E4B, 8202-E4C, 8205-E6B, 8205-E6C, 8231-E1C, 8231-E2B, 8231-E2C:**

Perform the following task:

1. Place the drawer into the service position and remove the service access cover.
2. Record the slot numbers of the PCI adapters and I/O expansion cards if present. Label and record the locations of all cables attached to the adapters. Disconnect all cables attached to the adapters and remove all of the adapters.
3. Remove the removable media or disk drive enclosure assembly by pulling out the blue tabs at the bottom of the enclosure (8202-E4B, 8202-E4C, 8205-E6B, or 8205-E6C) or on the sides of the enclosure (8231-E1C, 8231-E2B, or 8231-E2C), then sliding the enclosure out approximately three centimeters.
4. Remove and label the disk drives from the media or disk drive enclosure assembly.
5. Remove memory cards 2, 3, and 4 (if installed). If memory cards 2, 3, and 4 are removed, ensure that memory card 1 is installed.
6. Record the slot numbers of the memory DIMMs on memory card 1. Remove all memory DIMMs except for one pair from memory card 1.

**Notes:**

- a. Place the memory DIMM locking tabs in the locked (upright) position to prevent damage to the tabs.
  - b. Memory DIMMs must be installed in pairs and in the correct connectors. See System FRU locations for information about memory DIMMs locations.
7. Plug in the power cords and wait for 01 in the upper-left corner of the control panel display.
  8. Turn on the power using either the management console or the white button.

**8233-E8B, 8236-E8C:**

Perform the following task:

1. If this is a desktide system, remove the service access cover. If this is a rack-mounted system, place the drawer into the service position and remove the service access cover. Also remove the front cover.
2. Record the slot numbers of the PCI adapters and I/O expansion cards if present. Label and record the locations of all cables attached to the adapters. Disconnect all cables attached to the adapters and remove all of the adapters.
3. Remove the removable media or disk drive enclosure assembly by pulling out the blue tabs at the bottom of the enclosure, then sliding the enclosure out approximately three centimeters.
4. Remove and label the disk drives from the media or disk drive enclosure assembly.
5. Remove processor cards 2, 3, and 4 (if installed). If processor cards 2, 3, and 4 are removed, ensure that processor card 1 is installed and has at least one quad of DIMMs.
6. Record the slot numbers of the memory DIMMs on processor card 1. Remove all memory DIMMs except for one quad from processor card 1.

**Notes:**

- a. Place the memory DIMM locking tabs in the locked (upright) position to prevent damage to the tabs.
  - b. Memory DIMMs must be installed in quads and in the correct connectors. See System FRU locations for information about memory DIMMs locations.
7. Plug in the power cords and wait for 01 in the upper-left corner of the control panel display.
  8. Turn on the power using either the management console or the white button.

**9117-MMB, 9117-MMC, 9179-MHB, 9179-MHC:**

Perform the following task:

1. Place the drawer into the service position and remove the service access cover.
2. Record the slot numbers of the PCI adapters and I/O expansion cards if present. Label and record the locations of all cables attached to the adapters. Disconnect all cables attached to the adapters and remove all of the adapters.
3. Remove the removable media enclosure assembly by pulling out the orange tabs and then sliding the media enclosure toward you approximately three centimeters.
4. Ensure that the processor card is installed and contains at least one quad of DIMMs.
5. Record the slot numbers of the memory DIMMs on the processor card. Remove all memory DIMMs except for one quad from the processor card.

**Notes:**

- a. Place the memory DIMM locking tabs in the locked (upright) position to prevent damage to the tabs.
  - b. Memory DIMMs must be installed in quads and in the correct connectors. See System FRU locations for information about memory DIMMs locations.
6. Remove the disk drives from the disk drive enclosure assembly.
  7. Release and disconnect the disk drive enclosure assembly by using the cam levers at the lower front part of the enclosure.
  8. Plug in the power cords and wait for 01 in the upper-left-hand corner of the control panel display.
  9. Turn on the power using either the management console or the white button.

If a management console is attached, does the managed system reach power on at hypervisor standby as indicated on the management console? If a management console is not attached, does the system reach an operating system login prompt, or if booting the AIX standalone diagnostic CD-ROM, is the Please define the System Console screen displayed?

**No** Go to PFW1548-7.

**Yes** Go to the next step.

**• PFW1548-5**

For 8202-E4B, 8202-E4C, 8205-E6B, 8205-E6C, 8231-E1C, 8231-E2B, 8231-E2C, 8233-E8B, or 8236-E8C, were any memory DIMMs removed from system backplane?

For 9117-MMB, 9117-MMC, 9179-MHB, or 9179-MHC, were any memory DIMMs removed from the processor card?

**No** Go to PFW1548-8.

**Yes** Go to the next step.

**• PFW1548-6**

1. Turn off the power, and remove the power cords.
2. Replug the memory DIMMs that were removed from memory card 1 (8202-E4B, 8202-E4C, 8205-E6B, 8205-E6C, 8231-E1C, 8231-E2B, or 8231-E2C) or processor card 1 (8233-E8B or 8236-E8C) in PFW1548-2 in their original locations.

**Notes:**

- a. Place the memory DIMM locking tabs into the locked (upright) position to prevent damage to the tabs.
  - b. Memory DIMMs must be installed in quads in the correct connectors. See System FRU locations for information about memory DIMMs locations for the system that you are servicing.
3. Plug in the power cords and wait for 01 in the upper-left corner of the control panel display.
  4. Turn on the power using either the management console or the white button.

If a management console is attached, does the managed system reach power on at hypervisor standby as indicated on the management console? If a management console is not attached, does the system reach an operating system login prompt, or if booting the AIX diagnostic CD-ROM, is the Please define the System Console screen displayed?

**No:** Using the following table, locate the system machine type and model you are servicing and determine the action to perform.

8202-E4B, 8202-E4C, 8205-E6B, 8205-E6C, 8231-E1C, 8231-E2B, 8231-E2C	8233-E8B, 8236-E8C	9117-MMB, 9117-MMC, 9179-MHB, 9179-MHC
A memory DIMM in the pair you just replaced in the system is defective. Turn off the power, remove the power cords, and exchange the memory DIMM pair with new or previously removed memory DIMM pair. Repeat this step until the defective memory DIMM pair is identified, or all memory DIMM pairs have been replaced.	A memory DIMM in the quad you just replaced in the system is defective. Turn off the power, remove the power cords, and exchange the memory DIMM quad with new or previously removed memory DIMM quad. Repeat this step until the defective memory DIMM quad is identified, or all memory DIMM quads have been replaced.	A memory DIMM in the quad you just replaced in the system is defective. Turn off the power, remove the power cords, and exchange the memory DIMMs in that quad one at a time with new or previously removed memory DIMMs. Repeat this step until the defective memory DIMM is identified, or all memory DIMMs have been replaced.
If your symptom did not change and all the memory DIMM pairs have been exchanged, call your service support person for assistance. If the symptom changed, check for loose cards and obvious problems.	If your symptom did not change and all the memory DIMM quads have been exchanged, call your service support person for assistance. If the symptom changed, check for loose cards and obvious problems.	If your symptom did not change and all the memory DIMMs have been exchanged, call your service support person for assistance. If the symptom changed, check for loose cards and obvious problems.
If you do not find a problem, go to Problem Analysis and follow the instructions for the new symptom.	If you do not find a problem, go to Problem Analysis and follow the instructions for the new symptom.	If you do not find a problem, go to Problem Analysis and follow the instructions for the new symptom.

**Yes:** Using the following table, locate the system machine type and model you are servicing and determine the action to perform.

8202-E4B, 8202-E4C, 8205-E6B, 8205-E6C, 8231-E1C, 8231-E2B, 8231-E2C	8233-E8B, 8236-E8C	9117-MMB, 9117-MMC, 9179-MHB, 9179-MHC
Was one or more memory cards removed from the system? <b>NO:</b> Go to PFW1548-8. <b>Yes:</b> Go to PFW1548-7.1.	Was one or more processor cards removed from the system (other than processor card 1 to remove DIMMs)? <b>NO:</b> Go to PFW1548-8. <b>Yes:</b> Go to PFW1548-7.1.	Go to PFW1548-8.

- **PFW1548-7**  
One of the FRUs remaining in the system unit is defective.



**Note:** If a memory DIMM is exchanged, ensure that the new memory DIMM is the same size and speed as the original memory DIMM.

1. Turn off the power and remove the power cords. Using the following table, locate the system machine type and model you are servicing and exchange the FRUs, one at a time, in the order listed.

8202-E4B, 8202-E4C, 8205-E6B, 8205-E6C	8231-E1C, 8231-E2C	8231-E2B	8233-E8B, 8236-E8C	9117-MMB, 9117-MMC, 9179-MHB, 9179-MHC
<ol style="list-style-type: none"> <li>1. Memory DIMMs. Exchange one pair at a time with new or previously removed DIMM pairs.</li> <li>2. Memory card 1, location: Un-P1-C18.</li> <li>3. System backplane, location: Un-P1.</li> <li>4. Power supplies, locations: Un-E1 and Un-E2.</li> <li>5. Processor modules, locations Un-P1-C11 or Un-P1-C10</li> </ol>	<ol style="list-style-type: none"> <li>1. Memory DIMMs. Exchange one pair at a time with new or previously removed DIMM pairs.</li> <li>2. Memory card 1, location: Un-P1-C17.</li> <li>3. System backplane, location: Un-P1.</li> <li>4. Power supplies, locations: Un-E1 and Un-E2.</li> <li>5. Processor modules, locations Un-P1-C11 or Un-P1-C10</li> </ol>	<ol style="list-style-type: none"> <li>1. Memory DIMMs. Exchange one pair at a time with new or previously removed DIMM pairs.</li> <li>2. Memory card 1, location: Un-P1-C17.</li> <li>3. System backplane, location: Un-P1.</li> <li>4. Power supplies, locations: Un-E1 and Un-E2.</li> <li>5. Processor modules, locations Un-P1-C10 or Un-P1-C9</li> </ol>	<ol style="list-style-type: none"> <li>1. Memory DIMMs. Exchange one quad at a time with new or previously removed DIMM quads.</li> <li>2. Processor card 1, location: Un-P1-C13.</li> <li>3. System backplane, location: Un-P1.</li> <li>4. Power supplies, locations: Un-E1 and Un-E2.</li> </ol>	<ol style="list-style-type: none"> <li>1. Memory DIMMs. Replace one at a time with new or previously removed DIMMs.</li> <li>2. Processor card, location: Un-P3.</li> <li>3. Midplane, location: Un-P1.</li> <li>4. Power supplies, locations: Un-E1 and Un-E2.</li> <li>5. Service processor, location: Un-P1-C1.</li> <li>6. I/O backplane, location: Un-P2.</li> </ol>

2. Plug in the power cords and wait for 01 in the upper-left corner of the control panel display.
3. Turn on the power using either the management console or the white button.

If a management console is attached, does the managed system reach power on at hypervisor standby as indicated on the management console? If a management console is not attached, does the system reach an operating system login prompt, or if booting the AIX diagnostic CD-ROM, is the Please define the System Console screen displayed?

**No** Reinstall the original FRU.

Repeat the FRU replacement steps until the defective FRU is identified or all the FRUs have been exchanged.

If the symptom did not change and all the FRUs have been exchanged, call service support for assistance.

If the symptom has changed, check for loose cards, cables, and obvious problems. If you do not find a problem, go to Problem Analysis and follow the instructions for the new symptom.

**Yes** Go to Verify a repair.

- **PFW1548-7.1**

Using the following table, locate the system machine type and model you are servicing and determine the action to perform.

8202-E4B, 8202-E4C, 8205-E6B, 8205-E6C, 8231-E1C, 8231-E2B, 8231-E2C, 8233-E8B, or 8236-E8C

No failure was detected with this configuration.

1. Turn off the power and remove the power cords.
2. Reinstall the next memory card (8202-E4B, 8202-E4C, 8205-E6B, 8205-E6C, 8231-E1C, 8231-E2B, or 8231-E2C) or processor card (8233-E8B or 8236-E8C).
3. Plug in the power cords and wait for 01 in the upper-left corner of the control panel display.
4. Turn on the power using either the management console or the white button.

If a management console is attached, does the managed system reach power on at hypervisor standby as indicated on the management console? If a management console is not attached, does the system reach an operating system login prompt, or if booting the AIX diagnostic CD-ROM, is the Please define the System Console screen displayed?

**NO:** One of the FRUs remaining in the system is defective. Exchange the FRUs (that have not already been changed) in the following order:

- a. Memory DIMMs (if present) on the memory card (8202-E4B, 8202-E4C, 8205-E6B, 8205-E6C, 8231-E1C, 8231-E2B, or 8231-E2C) or the processor card (8233-E8B or 8236-E8C) that was just reinstalled. Exchange the DIMM quads one at a time with new or previously removed DIMM quads.
- b. For 8233-E8B or 8236-E8C only: The processor card that was just reinstalled.
- c. System backplane, location:  $Un-P1$ .
- d. Power supplies, locations:  $Un-E1$  and  $Un-E2$ .
- e. For 8202-E4B, 8202-E4C, 8205-E6B, 8205-E6C, 8231-E1C, 8231-E2C: Processor modules at locations  $Un-P1-C11$  and  $Un-P1-C10$ . For 8231-E2B: Processor modules at locations  $Un-P1-C10$  and  $Un-P1-C9$ .

Repeat the FRU replacement steps until the defective FRU is identified or all the FRUs have been exchanged.

If the symptom did not change and all the FRUs have been exchanged, call service support for assistance.

If the symptom has changed, check for loose cards, cables, and obvious problems. If you do not find a problem, go to Problem Analysis and follow the instructions for the new symptom.

**Yes:** If all of the processor cards have been reinstalled, go to the next step. Otherwise, repeat this step.

• **PFW1548-8**

1. Turn off the power.
2. Reconnect the system console.

**Notes:**

- a. If an ASCII terminal has been defined as the firmware console, attach the ASCII terminal cable to the S1 connector on the rear of the system unit.
  - b. If a display attached to a display adapter has been defined as the firmware console, install the display adapter and connect the display to the adapter. Plug the keyboard and mouse into the keyboard connector on the rear of the system unit.
3. Turn on the power using either the management console or the white button. (If the AIX standalone diagnostic CD-ROM is not in the optical drive, insert it now.) If a management console is attached, after the system has reached hypervisor standby, activate a Linux or AIX partition by clicking the **Advanced** button on the activation screen. On the Advanced activation screen, select **Boot in service mode using the default boot list** to boot the AIX standalone diagnostic CD-ROM.
  4. If the ASCII terminal or graphics display (including display adapter) is connected differently from the way it was previously, the console selection screen appears. Select a firmware console.
  5. Immediately after the word *keyboard* is displayed, press the number 1 key on the directly attached keyboard, an ASCII terminal or management console. This activates the system management services (SMS).

6. Enter the appropriate password if you are prompted to do so.

Is the SMS screen displayed?

**No** One of the FRUs remaining in the system unit is defective.

Replace the FRUs that have not been exchanged, in the following order:

1. If you are using an ASCII terminal, go to the problem determination procedures for the display. If you do not find a problem, do the following:

8202-E4B, 8202-E4C, 8205-E6B, 8205-E6C, 8231-E1C, 8231-E2B, 8231-E2C, 8233-E8B, or 8236-E8C	9117-MMB, 9117-MMC, 9179-MHB, or 9179-MHC
Replace the system backplane, location: Un-P1.	<ol style="list-style-type: none"><li>1. Replace the service processor, location: Un-P1-C1.</li><li>2. Replace the midplane, location: Un-P1.</li></ol>

2. If you are using a graphics display, go to the problem determination procedures for the display. If you do not find a problem, do the following:

- a. Replace the display adapter.
- b. Replace the backplane in which the graphics adapter is plugged.

Repeat this step until the defective FRU is identified or all the FRUs have been exchanged.

If the symptom did not change and all the FRUs have been exchanged, call service support for assistance.

If the symptom changed, check for loose cards, cables, and obvious problems. If you do not find a problem, go to Problem Analysis and follow the instructions for the new symptom.

**Yes** Go to the next step.

• **PFW1548-9**

1. Make sure the AIX standalone diagnostic CD-ROM is inserted into the optical drive.
2. Turn off the power and remove the power cords.
3. Use the cam levers to reconnect the disk drive enclosure assembly to the I/O backplane.
4. Using the following table, locate the system machine type and model you are servicing and determine the action to perform.

8202-E4B, 8202-E4C, 8205-E6B, 8205-E6C, 8231-E1C, 8231-E2B, 8231-E2C, 8233-E8B, or 8236-E8C	9117-MMB, 9117-MMC, 9179-MHB, or 9179-MHC
Reconnect the removable media or disk drive enclosure assembly by sliding the media enclosure toward the rear of the system, then pressing the blue tabs.	Reconnect the removable media enclosure assembly by sliding the media enclosure toward the disk drive backplane and then pressing the orange tabs.

5. Plug in the power cords and wait for 01 in the upper-left corner of the operator panel display.
  6. Turn on the power using either the management console or the white button. (If the AIX standalone diagnostic CD-ROM is not in the optical drive, insert it now.) If a management console is attached, after the system has reached hypervisor standby, activate a Linux or AIX partition by clicking the **Advanced** button on the activation screen. On the Advanced activation screen, select **Boot in service mode using the default boot list** to boot the AIX standalone diagnostic CD-ROM.
  7. Immediately after the word *keyboard* is displayed, press the number 5 key on either the directly attached keyboard or an ASCII terminal keyboard.
  8. Enter the appropriate password if you are prompted to do so.
- Is the "Please define the System Console" screen displayed?

**No:** One of the FRUs remaining in the system unit is defective.

Using the following table, locate the system machine type and model you are servicing and exchange the FRUs in the order listed that have not been exchanged.

8202-E4B, 8202-E4C, 8205-E6B, 8205-E6C, 8231-E1C, 8231-E2B, 8231-E2C, 8233-E8B, or 8236-E8C	9117-MMB, 9117-MMC, 9179-MHB, or 9179-MHC
<ol style="list-style-type: none"> <li>Optical drive</li> <li>Removable media enclosure</li> <li>System backplane, <math>U_n</math>-P1.</li> </ol>	<ol style="list-style-type: none"> <li>Optical drive</li> <li>Removable media enclosure</li> <li>Disk drive enclosure (no disk drives at this time)</li> <li>I/O backplane, <math>U_n</math>-P2.</li> </ol>

Repeat this step until the defective FRU is identified or all the FRUs have been exchanged.

If the symptom did not change and all the FRUs have been exchanged, call service support for assistance.

If the symptom has changed, check for loose cards, cables, and obvious problems. If you do not find a problem, go to Problem Analysis and follow the instructions for the new symptom.

**Yes:** Go to the next step.

• **PFW1548-10**

The system is working correctly with this configuration. One of the disk drives that you removed from the disk drive backplanes may be defective.

- Make sure the AIX standalone diagnostic CD-ROM is inserted into the optical drive.
- Turn off the power and remove the power cords.
- Using the following table, locate the system machine type and model you are servicing and determine the action to perform.

8202-E4B, 8202-E4C, 8205-E6B, 8205-E6C, 8231-E1C, 8231-E2B, 8231-E2C, 8233-E8B, or 8236-E8C	9117-MMB, 9117-MMC, 9179-MHB, or 9179-MHC
Install a disk drive in the media or disk drive enclosure assembly.	Install a disk drive in the disk drive enclosure assembly.

- Plug in the power cords and wait for the OK prompt to display on the operator panel display.
- Turn on the power.
- Immediately after the word *keyboard* is displayed, press the number 5 key on either the directly attached keyboard or an ASCII terminal keyboard.
- Enter the appropriate password if you are prompted to do so.

Is the "Please define the System Console" screen displayed?

**No** Using the following table, locate the system machine type and model you are servicing and exchange the FRUs in the order listed that have not been exchanged.

8202-E4B, 8202-E4C, 8205-E6B, 8205-E6C, 8231-E1C, 8231-E2B, 8231-E2C, 8233-E8B, or 8236-E8C	9117-MMB, 9117-MMC, 9179-MHB, or 9179-MHC
<ol style="list-style-type: none"> <li>Last disk drive installed</li> <li>Disk drive backplane</li> </ol>	<ol style="list-style-type: none"> <li>Last disk drive installed</li> <li>Disk drive enclosure assembly</li> </ol>

Repeat this step until the defective FRU is identified or all the FRUs have been exchanged.

If the symptom did not change and all the FRUs have been exchanged, call service support for assistance.

If the symptom has changed, check for loose cards, cables, and obvious problems. If you do not find a problem, go to Problem Analysis and follow the instructions for the new symptom.

**Yes** Repeat this step with all disk drives that were installed in the disk drive backplane.

After all of the disk drives have been reinstalled, go to the next step.

• **PFW1548-11**

The system is working correctly with this configuration. One of the devices that was disconnected from the system backplane may be defective.

1. Turn off the power and remove the power cords.
2. Attach a system backplane device (for example: system port 1, system port 2, USB, keyboard, mouse, Ethernet) that had been removed.

After all of the I/O backplane device cables have been reattached, reattached the cables to the service processor one at a time.

3. Plug in the power cords and wait for 01 in the upper-left corner on the operator panel display.
4. Turn on the power using either the management console or the white button. (If the AIX standalone diagnostic CD-ROM is not in the optical drive, insert it now.) If a management console is attached, after the system has reached hypervisor standby, activate a Linux or AIX partition by clicking the **Advanced** button on the activation screen. On the Advanced activation screen, select **Boot in service mode using the default boot list** to boot the AIX standalone diagnostic CD-ROM.
5. If the Console Selection screen is displayed, choose the system console.
6. Immediately after the word *keyboard* is displayed, press the number 5 key on either the directly attached keyboard or on an ASCII terminal keyboard.
7. Enter the appropriate password if you are prompted to do so.

Is the "Please define the System Console" screen displayed?

**No** The last device or cable that you attached is defective.

To test each FRU, use the following table to locate the system machine type and model you are servicing, then exchange the FRUs in the order listed.

8202-E4B, 8202-E4C, 8205-E6B, 8205-E6C, 8231-E1C, 8231-E2B, 8231-E2C, 8233-E8B, or 8236-E8C	9117-MMB, 9117-MMC, 9179-MHB, or 9179-MHC
1. Device and cable (last one attached). 2. System backplane, location: Un-P1.	1. Device and cable (last one attached). 2. If the last cable in this step was reconnected to the service processor, replace the service processor. 3. I/O backplane, location: Un-P2.

If the symptom did not change and all the FRUs have been exchanged, call service support for assistance.

If the symptom has changed, check for loose cards, cables, and obvious problems. If you do not find a problem, go to Problem Analysis and follow the instructions for the new symptom.

**Yes** Repeat this step until all of the devices are attached. Go to the next step.

• **PFW1548-12**

The system is working correctly with this configuration. One of the FRUs (adapters) that you removed may be defective.

1. Turn off the power and remove the power cords.
2. Install a FRU (adapter) and connect any cables and devices that were attached to the FRU.
3. Plug in the power cords and wait for the OK prompt to display on the operator panel display.
4. Turn on the power using either the management console or the white button. (If the AIX standalone diagnostic CD-ROM is not in the optical drive, insert it now.) If a management console is attached, after the system has reached hypervisor standby, activate a Linux or AIX partition by clicking the **Advanced** button on the activation screen. On the Advanced activation screen, select **Boot in service mode using the default boot list** to boot the AIX standalone diagnostic CD-ROM.

5. If the Console Selection screen is displayed, choose the system console.
6. Immediately after the word *keyboard* is displayed, press the number 5 key on either the directly attached keyboard or on an ASCII terminal keyboard.
7. Enter the appropriate password if you are prompted to do so.

Is the "Please define the System Console" screen displayed?

**No** Go to the next step.

**Yes** Repeat this step until all of the FRUs (adapters) are installed. Go to Verify a repair.

• **PFW1548-13**

The last FRU installed or one of its attached devices is probably defective.

1. Make sure the AIX standalone diagnostic CD-ROM is inserted into the optical drive.
2. Turn off the power and remove the power cords.
3. Starting with the last installed adapter, disconnect one attached device and cable.
4. Plug in the power cords and wait for the 01 in the upper-left corner on the operator panel display.
5. Turn on the power using either the management console or the white button. (If the AIX standalone diagnostic CD-ROM is not in the optical drive, insert it now.) If a management console is attached, after the system has reached hypervisor standby, activate a Linux or AIX partition by clicking the **Advanced** button on the Advanced activation screen. On the Advanced activation screen, select **Boot in service mode using the default boot list** to boot the AIX standalone diagnostic CD-ROM.
6. If the Console Selection screen is displayed, choose the system console.
7. Immediately after the word *keyboard* is displayed, press the number 5 key on either the directly attached keyboard or on an ASCII terminal keyboard.
8. Enter the appropriate password if you are prompted to do so.

Is the "Please define the System Console" screen displayed?

**No** Repeat this step until the defective device or cable is identified or all devices and cables have been disconnected.

If all the devices and cables have been removed, then one of the FRUs remaining in the system unit is defective.

To test each FRU, use the following table to locate the system machine type and model you are servicing, then exchange the FRUs in the order listed.

8202-E4B, 8202-E4C, 8205-E6B, 8205-E6C, 8231-E1C, 8231-E2B, 8231-E2C, 8233-E8B, or 8236-E8C	9117-MMB, 9117-MMC, 9179-MHB, or 9179-MHC
1. Adapter (last one installed). 2. System backplane, location: Un-P1.	1. Adapter (last one installed). 2. I/O backplane, location: Un-P2.

If the symptom did not change and all the FRUs have been exchanged, call service support for assistance.

If the symptom has changed, check for loose cards, cables, and obvious problems. If you do not find a problem, go to the Problem Analysis and follow the instructions for the new symptom.

**Yes** The last device or cable that you disconnected is defective. Exchange the defective device or cable then go to the next step.

• **PFW1548-13.1**

Is the system a 9117-MMB or 9179-MHB?

**No:** Go to PFW1548-14.

**Yes:** Go to the next step.

- **PFW1548-13.2**

Reattach the flex cables, if present, both front and back. Return the system to its original configuration. Reinstall the control panel, the VPC card, and the service processor in the original primary processor drawer. Reattach the power cords and power on the system.

Does the system come up properly?

**NO:** Go to the next step.

**Yes:** Go to Verify a repair..

- **PFW1548-13.3**

Have all of the drawers been tested individually with the physical control panel (if present), service processor, and VPD card?

**No:**

1. Detach the flex cables from the front and back of the system if not already disconnected.
2. Remove the service processor card, the VPD card, and the control panel from the processor drawer that was just tested.
3. Install these parts in the next drawer in the rack, going top to bottom.
4. Go to PFW1548-3.

**YES:** Reinstall the control panel, the VPD card, and the service processor card in the original primary processor drawer. Return the system to its original configuration. Suspect a problem with the flex cables. If the error code indicates a problem with the SPCN or service processor communication between drawers, replace the flex cable in the rear. If the error code indicates a problem with inter-processor drawer communication, replace the flex cable on the front of the system. Continue with the next step.

- **PFW1548-13.4**

Did replacing the flex cables resolve the problem?

**NO:** Go to step the next step.

**Yes:** The problem is resolved. Go to Verify a repair.

- **PFW1548-13.5**

Replacing the flex cables did not resolve the problem. If the problem appears to be with the service processor or SPCN signals, suspect the I/O backplanes. If the problem appears to be with processor communication, suspect the processor cards. Replace the I/O backplanes, or processor cards, one at a time until the defective part is found.

Did this resolve the problem?

**NO:** Contact your next level of support.

**Yes:** The problem is resolved. Go to Verify a repair.

- **PFW1548-14**

1. Follow the instructions on the screen to select the system console.
2. When the DIAGNOSTIC OPERATING INSTRUCTIONS screen is displayed, press Enter.
3. Select **Advanced Diagnostics Routines**.
4. If the terminal type has not been defined, you must use the option **Initialize Terminal** on the FUNCTION SELECTION menu to initialize the AIX diagnostic environment before you can continue with the diagnostics. This is a separate operation from selecting the console display.
5. If the NEW RESOURCE screen is displayed, select an option from the bottom of the screen.

**Note:** Adapters and devices that require supplemental media are not shown in the new resource list. If the system has adapters or devices that require supplemental media, select option 1.

6. When the DIAGNOSTIC MODE SELECTION screen is displayed, press Enter.

7. Select **All Resources**. (If you were sent here from step PFW1548-18, select the adapter or device that was loaded from the supplemental media).

Did you get an SRN?

**No** Go to step PFW1548-16.

**Yes** Go to the next step.

• **PFW1548-15**

Look at the FRU part numbers associated with the SRN.

Have you exchanged all the FRUs that correspond to the failing function codes (FFCs)?

**No** Exchange the FRU with the highest failure percentage that has not been changed.

Repeat this step until all the FRUs associated with the SRN have been exchanged or diagnostics run with no trouble found. Run diagnostics after each FRU is exchanged. Go to Verify a repair.

**Yes** If the symptom did not change and all the FRUs have been exchanged, call service support for assistance.

• **PFW1548-16**

Does the system have adapters or devices that require supplemental media?

**No** Go to step the next step.

**Yes** Go to step PFW1548-18.

• **PFW1548-17**

Consult the PCI adapter configuration documentation for your operating system to verify that all adapters are configured correctly.

Go to Verify a repair.

If the symptom did not change and all the FRUs have been exchanged, call service support for assistance.

• **PFW1548-18**

1. Select **Task Selection**.

2. Select **Process Supplemental Media** and follow the on-screen instructions to process the media. Supplemental media must be loaded and processed one at a time.

Did the system return to the TASKS SELECTION SCREEN after the supplemental media was processed?

**No** Go to the next step.

**Yes** Press F3 to return to the FUNCTION SELECTION screen. Go to step PFW1548-14 substep 4.

• **PFW1548-19**

The adapter or device is probably defective.

If the supplemental media is for an adapter, replace the FRUs in the following order:

1. Adapter
2. System backplane, location: *Un-P1*.

If the supplemental media is for a device, replace the FRUs in the following order:

8202-E4B, 8202-E4C, 8205-E6B, 8205-E6C, 8231-E1C, 8231-E2B, 8231-E2C, 8233-E8B, or 8236-E8C	9117-MMB, 9117-MMC, 9179-MHB, or 9179-MHC
1. Device and any associated cables. 2. The adapter to which the device is attached.	1. Adapter. 2. I/O backplane, location: <i>Un-P2</i> .



Repeat this step until the defective FRU is identified or all the FRUs have been exchanged.

If the symptom did not change and all the FRUs have been exchanged, call service support for assistance.

If the symptom has changed, check for loose cards, cables, and obvious problems. If you do not find a problem, go to Problem Analysis and follow the instructions for the new symptom.

Go to Verify a repair.

**This ends the procedure.**

**PFW1548: Memory and processor subsystem problem isolation procedure when a management console is attached:** This procedure is used to locate defective FRUs not found by normal diagnostics. For this procedure, diagnostics are run on a minimally configured system. If a failure is detected on the minimally configured system, the remaining FRUs are exchanged one at a time until the failing FRU is identified. If a failure is not detected, FRUs are added back until the failure occurs. The failure is then isolated to the failing FRU.

**Note:** the system backplane has two memory DIMM quads: *Un-P1-C14* to *Un-P1-C17*, and *Un-P1-C21* to *Un-P1-C24*. See System FRU locations for information about system FRU locations.

Perform the following procedure:

• **PFW1548-1**

1. Ensure that the diagnostics and the operating system are shut down.

Is the system at "service processor standby", indicated by 01 in the control panel?

**No** Replace the system backplane, location: *Un-P1*. Return to step PFW1548-1.

**Yes** Continue with substep 2.

2. Turn on the power using either the white button or the ASMI menus.

Does the system reach hypervisor standby as indicated on the management console?

**No** Go to PFW1548-3.

**Yes** Go to PFW1548-2.

3. Insert the AIX diagnostic CD-ROM into the optical drive.

**Note:** If you cannot insert the diagnostic CD-ROM, go to PFW1548-2.

4. When the word *keyboard* is displayed on an ASCII terminal, a directly attached keyboard, or management console, press the number 5 key.

5. If you are prompted to do so, enter the appropriate password.

Is the "Please define the System Console" screen displayed?

**No** Go to PFW1548-2.

**Yes** Go to PFW1548-14.

• **PFW1548-2**

Insert the AIX diagnostic CD-ROM into the optical drive.

**Note:** If you cannot insert the diagnostic CD-ROM, go to step PFW1548-3.

Turn on the power using either the white button or the ASMI menus. (If the diagnostic CD-ROM is not in the optical drive, insert it now.) After the system has reached hypervisor standby, activate a Linux or AIX partition by clicking the **Advanced** button on the activation screen. On the Advanced activation screen, select **Boot in service mode using the default boot list** to boot the diagnostic CD-ROM.

If you are prompted to do so, enter the appropriate password.

Is the "Please define the System Console" screen displayed?

**No** Go to PFW1548-3.

**Yes** Go to PFW1548-14.

• **PFW1548-3**

1. Turn off the power.
2. If you have not already done so, configure the service processor (using the ASMI menus), follow the instructions in note 6 located in “PFW1548: Memory and processor subsystem problem isolation procedure” on page 112 and then return here and continue.
3. Exit the service processor (ASMI) menus and remove the power cords.
4. Disconnect all external cables (parallel, system port 1, system port 2, keyboard, mouse, USB devices, SPCN, Ethernet on the system planar, and so on). Also disconnect all of the external cables attached to the service processor except the Ethernet cable going to the management console.

Go to the next step.

• **PFW1548-4**

1. If this is a desktside system, remove the service access cover. If this is a rack-mounted system, place the drawer into the service position and remove the service access cover. Also remove the front cover.
2. Record the slot numbers of the PCI adapters and I/O expansion cards if present. Label and record the locations of all cables attached to the adapters. Disconnect all cables attached to the adapters and remove all of the adapters.
3. Remove the removable media or disk drive enclosure assembly by pulling out the blue tabs at the bottom of the enclosure, then sliding the enclosure out approximately three centimeters.
4. Remove and label the disk drives from the media or disk drive enclosure assembly.
5. Remove one of the two memory DIMMs quads.

**Notes:**

- a. Place the memory DIMM locking tabs in the locked (upright) position to prevent damage to the tabs.
  - b. Memory DIMMs must be installed in quads and in the correct connectors. See System FRU locations for information about memory DIMMs locations.
6. Plug in the power cords and wait for 01 in the upper-left corner of the control panel display.
  7. Turn on the power using either the management console or the white button.

Does the managed system reach power on at hypervisor standby as indicated on the management console?

**No** Go to PFW1548-7.

**Yes** Go to the next step.

• **PFW1548-5**

Were any memory DIMMs removed from system backplane?

**No** Go to PFW1548-8.

**Yes** Go to the next step.

• **PFW1548-6**

1. Turn off the power, and remove the power cords.
2. Replug the memory DIMMs that were removed from system backplane in PFW1548-2 in their original locations.

**Notes:**

- a. Place the memory DIMM locking tabs into the locked (upright) position to prevent damage to the tabs.
- b. Memory DIMMs must be installed in quads in the correct connectors. See System FRU locations for information about memory DIMM locations.

3. Plug in the power cords and wait for 01 in the upper-left corner of the control panel display.
4. Turn on the power using either the management console or the white button.

Does the managed system reach power on at hypervisor standby as indicated on the management console?

**No** A memory DIMM in the quad you just replaced in the system is defective. Turn off the power, remove the power cords, and exchange the memory DIMM quad with new or previously removed memory DIMM quad. Repeat this step until the defective memory DIMM quad is identified, or both memory DIMM quads have been exchanged.

**Note:** the system backplane has two memory DIMM quads:  $U_n$ -P1-C1x-C1 to  $U_n$ -P1-C1x-C4, and  $U_n$ -P1-C1x-C6 to  $U_n$ -P1-C1x-C9. See System FRU locations.

If your symptom did not change and both the memory DIMM quads have been exchanged, call your service support person for assistance.

If the symptom changed, check for loose cards and obvious problems. If you do not find a problem, go to the Problem Analysis procedures and follow the instructions for the new symptom.

**Yes** Go to the next step.

- **PFW1548-7**

One of the FRUs remaining in the system unit is defective.

**Note:** If a memory DIMM is exchanged, ensure that the new memory DIMM is the same size and speed as the original memory DIMM.

1. Turn off the power, remove the power cords, and exchange the following FRUs, one at a time, in the order listed:
  - a. Memory DIMMs. Exchange one quad at a time with new or previously removed DIMM quads
  - b. System backplane, location:  $U_n$ -P1
  - c. Power supplies, locations:  $U_n$ -E1 and  $U_n$ -E2.
2. Plug in the power cords and wait for 01 in the upper-left corner of the control panel display.
3. Turn on the power using either the management console or the white button.

Does the managed system reach power on at hypervisor standby as indicated on the management console?

**No** Reinstall the original FRU.

Repeat the FRU replacement steps until the defective FRU is identified or all the FRUs have been exchanged.

If the symptom did not change and all the FRUs have been exchanged, call service support for assistance.

If the symptom has changed, check for loose cards, cables, and obvious problems. If you do not find a problem, go to the Problem Analysis procedures and follow the instructions for the new symptom.

**Yes** Go to Verify a repair.

- **PFW1548-8**

1. Turn off the power.
2. Reconnect the system console.

**Notes:**

- a. If an ASCII terminal has been defined as the firmware console, attach the ASCII terminal cable to the S1 connector on the rear of the system unit.

- b. If a display attached to a display adapter has been defined as the firmware console, install the display adapter and connect the display to the adapter. Plug the keyboard and mouse into the keyboard connector on the rear of the system unit.
3. Turn on the power using either the management console or the white button. (If the diagnostic CD-ROM is not in the optical drive, insert it now.) After the system has reached hypervisor standby, activate a Linux or AIX partition by clicking the **Advanced** button on the activation screen. On the Advanced activation screen, select **Boot in service mode using the default boot list** to boot the diagnostic CD-ROM.
4. If the ASCII terminal or graphics display (including display adapter) is connected differently from the way it was previously, the console selection screen appears. Select a firmware console.
5. Immediately after the word *keyboard* is displayed, press the number 1 key on the directly attached keyboard, an ASCII terminal or management console. This activates the system management services (SMS).
6. Enter the appropriate password if you are prompted to do so.

Is the SMS screen displayed?

**No** One of the FRUs remaining in the system unit is defective.

Exchange the FRUs that have not been exchanged, in the following order:

1. If you are using an ASCII terminal, go to the problem determination procedures for the display. If you do not find a problem, do the following:
  - a. Replace the system backplane, location: U $n$ -P1.
2. If you are using a graphics display, go to the problem determination procedures for the display. If you do not find a problem, do the following:
  - a. Replace the display adapter.
  - b. Replace the backplane in which the graphics adapter is plugged.

Repeat this step until the defective FRU is identified or all the FRUs have been exchanged.

If the symptom did not change and all the FRUs have been exchanged, call service support for assistance.

If the symptom changed, check for loose cards, cables, and obvious problems. If you do not find a problem, go to the Problem Analysis procedures and follow the instructions for the new symptom.

**Yes** Go to the next step.

• **PFW1548-9**

1. Make sure the diagnostic CD-ROM is inserted into the optical drive.
2. Turn off the power and remove the power cords.
3. Use the cam levers to reconnect the disk drive enclosure assembly to the I/O backplane.
4. Reconnect the removable media or disk drive enclosure assembly by sliding the media enclosure toward the rear of the system, then pressing the blue tabs.
5. Plug in the power cords and wait for 01 in the upper-left corner of the operator panel display.
6. Turn on the power using either the management console or the white button. (If the diagnostic CD-ROM is not in the optical drive, insert it now.) After the system has reached hypervisor standby, activate a Linux or AIX partition by clicking the **Advanced** button on the activation screen. On the Advanced activation screen, select **Boot in service mode using the default boot list** to boot the diagnostic CD-ROM.
7. Immediately after the word *keyboard* is displayed, press the number 5 key on either the directly attached keyboard or an ASCII terminal keyboard.
8. Enter the appropriate password if you are prompted to do so.

Is the "Please define the System Console" screen displayed?

**No** One of the FRUs remaining in the system unit is defective.

Exchange the FRUs that have not been exchanged, in the following order:

1. Optical drive
2. Removable media enclosure.
3. System backplane, *Un-P1*.

Repeat this step until the defective FRU is identified or all the FRUs have been exchanged.

If the symptom did not change and all the FRUs have been exchanged, call service support for assistance.

If the symptom has changed, check for loose cards, cables, and obvious problems. If you do not find a problem, go to Problem Analysis procedures and follow the instructions for the new symptom.

**Yes** Go to the next step.

• **PFW1548-10**

The system is working correctly with this configuration. One of the disk drives that you removed from the disk drive backplanes may be defective.

1. Make sure the diagnostic CD-ROM is inserted into the optical drive.
2. Turn off the power and remove the power cords.
3. Install a disk drive in the media or disk drive enclosure assembly.
4. Plug in the power cords and wait for the OK prompt to display on the operator panel display.
5. Turn on the power.
6. Immediately after the word *keyboard* is displayed, press the number 5 key on either the directly attached keyboard or an ASCII terminal keyboard.
7. Enter the appropriate password if you are prompted to do so.

Is the "Please define the System Console" screen displayed?

**No** Exchange the FRUs that have not been exchanged, in the following order:

1. Last disk drive installed
2. Disk drive backplane.

Repeat this step until the defective FRU is identified or all the FRUs have been exchanged.

If the symptom did not change and all the FRUs have been exchanged, call service support for assistance.

If the symptom has changed, check for loose cards, cables, and obvious problems. If you do not find a problem, go to Problem Analysis procedures and follow the instructions for the new symptom.

**Yes** Repeat this step with all disk drives that were installed in the disk drive backplane.

After all of the disk drives have been reinstalled, go to the next step.

• **PFW1548-11**

The system is working correctly with this configuration. One of the devices that was disconnected from the system backplane may be defective.

1. Turn off the power and remove the power cords.
2. Attach a system backplane device (for example: system port 1, system port 2, USB, keyboard, mouse, Ethernet) that had been removed.

After all of the I/O backplane device cables have been reattached, reattached the cables to the service processor one at a time.

3. Plug in the power cords and wait for 01 in the upper-left corner on the operator panel display.

4. Turn on the power using either the management console or the white button. (If the diagnostic CD-ROM is not in the optical drive, insert it now.) After the system has reached hypervisor standby, activate a Linux or AIX partition by clicking the **Advanced** button on the activation screen. On the Advanced activation screen, select **Boot in service mode using the default boot list** to boot the diagnostic CD-ROM.
5. If the Console Selection screen is displayed, choose the system console.
6. Immediately after the word *keyboard* is displayed, press the number 5 key on either the directly attached keyboard or on an ASCII terminal keyboard.
7. Enter the appropriate password if you are prompted to do so.

Is the "Please define the System Console" screen displayed?

**No** The last device or cable that you attached is defective.

To test each FRU, exchange the FRUs in the following order:

1. Device and cable (last one attached)
2. System backplane, location: Un-P1.

If the symptom did not change and all the FRUs have been exchanged, call service support for assistance.

If the symptom has changed, check for loose cards, cables, and obvious problems. If you do not find a problem, go to Problem Analysis procedures and follow the instructions for the new symptom.

**Yes** Repeat this step until all of the devices are attached. Go to the next step.

• **PFW1548-12**

The system is working correctly with this configuration. One of the FRUs (adapters) that you removed may be defective.

1. Turn off the power and remove the power cords.
2. Install a FRU (adapter) and connect any cables and devices that were attached to the FRU.
3. Plug in the power cords and wait for the OK prompt to display on the operator panel display.
4. Turn on the power using either the management console or the white button. (If the diagnostic CD-ROM is not in the optical drive, insert it now.) After the system has reached hypervisor standby, activate a Linux or AIX partition by clicking the **Advanced** button on the activation screen. On the Advanced activation screen, select **Boot in service mode using the default boot list** to boot the diagnostic CD-ROM.
5. If the Console Selection screen is displayed, choose the system console.
6. Immediately after the word *keyboard* is displayed, press the number 5 key on either the directly attached keyboard or on an ASCII terminal keyboard.
7. Enter the appropriate password if you are prompted to do so.

Is the "Please define the System Console" screen displayed?

**No** Go to the next step.

**Yes** Repeat this step until all of the FRUs (adapters) are installed. Go to Verify a repair.

• **PFW1548-13**

The last FRU installed or one of its attached devices is probably defective.

1. Make sure the diagnostic CD-ROM is inserted into the optical drive.
2. Turn off the power and remove the power cords.
3. Starting with the last installed adapter, disconnect one attached device and cable.
4. Plug in the power cords and wait for the 01 in the upper-left corner on the operator panel display.
5. Turn on the power using either the management console or the white button. (If the diagnostic CD-ROM is not in the optical drive, insert it now.) After the system has reached hypervisor

standby, activate a Linux or AIX partition by clicking the **Advanced** button on the Advanced activation screen. On the Advanced activation screen, select **Boot in service mode using the default boot list** to boot the diagnostic CD-ROM.

6. If the Console Selection screen is displayed, choose the system console.
7. Immediately after the word *keyboard* is displayed, press the number 5 key on either the directly attached keyboard or on an ASCII terminal keyboard.
8. Enter the appropriate password if you are prompted to do so.

Is the "Please define the System Console" screen displayed?

**No** Repeat this step until the defective device or cable is identified or all devices and cables have been disconnected.

If all the devices and cables have been removed, then one of the FRUs remaining in the system unit is defective.

To test each FRU, exchange the FRUs in the following order:

1. Adapter (last one installed)
2. System backplane, location: Un-P1.

If the symptom did not change and all the FRUs have been exchanged, call service support for assistance.

If the symptom has changed, check for loose cards, cables, and obvious problems. If you do not find a problem, go to the Problem Analysis procedures and follow the instructions for the new symptom.

**Yes** The last device or cable that you disconnected is defective. Exchange the defective device or cable then go to the next step.

- **PFW1548-14**

1. Follow the instructions on the screen to select the system console.
2. When the DIAGNOSTIC OPERATING INSTRUCTIONS screen is displayed, press Enter.
3. Select **Advanced Diagnostics Routines**.
4. If the terminal type has not been defined, you must use the option **Initialize Terminal** on the FUNCTION SELECTION menu to initialize the AIX diagnostic environment before you can continue with the diagnostics. This is a separate operation from selecting the console display.
5. If the NEW RESOURCE screen is displayed, select an option from the bottom of the screen.

**Note:** Adapters and devices that require supplemental media are not shown in the new resource list. If the system has adapters or devices that require supplemental media, select option 1.

6. When the DIAGNOSTIC MODE SELECTION screen is displayed, press Enter.
7. Select **All Resources**. (If you were sent here from step PFW1548-18, select the adapter or device that was loaded from the supplemental media).

Did you get an SRN?

**No** Go to step PFW1548-16.

**Yes** Go to the next step.

- **PFW1548-15**

Look at the FRU part numbers associated with the SRN.

Have you exchanged all the FRUs that correspond to the failing function codes (FFCs)?

**No** Exchange the FRU with the highest failure percentage that has not been changed.

Repeat this step until all the FRUs associated with the SRN have been exchanged or diagnostics run with no trouble found. Run diagnostics after each FRU is exchanged. Go to Verify a repair.

**Yes** If the symptom did not change and all the FRUs have been exchanged, call service support for assistance.

- **PFW1548-16**

Does the system have adapters or devices that require supplemental media?

**No** Go to step the next step.

**Yes** Go to step PFW1548-18.

- **PFW1548-17**

Consult the PCI adapter configuration documentation for your operating system to verify that all adapters are configured correctly.

Go to Verify a repair.

If the symptom did not change and all the FRUs have been exchanged, call service support for assistance.

- **PFW1548-18**

1. Select **Task Selection**.

2. Select **Process Supplemental Media** and follow the on-screen instructions to process the media. Supplemental media must be loaded and processed one at a time.

Did the system return to the TASKS SELECTION SCREEN after the supplemental media was processed?

**No** Go to the next step.

**Yes** Press F3 to return to the FUNCTION SELECTION screen. Go to step PFW1548-14, substep 4 on page 131.

- **PFW1548-19**

The adapter or device is probably defective.

If the supplemental media is for an adapter, replace the FRUs in the following order:

1. Adapter
2. System backplane, location: *Un-P1*.

If the supplemental media is for a device, replace the FRUs in the following order:

1. Device and any associated cables
2. The adapter to which the device is attached

Repeat this step until the defective FRU is identified or all the FRUs have been exchanged.

If the symptom did not change and all the FRUs have been exchanged, call service support for assistance.

If the symptom has changed, check for loose cards, cables, and obvious problems. If you do not find a problem, go to the Problem Analysis procedures and follow the instructions for the new symptom.

Go to Verify a repair.

This ends the procedure.

**PFW1548: Memory and processor subsystem problem isolation procedure without a management console attached:** This procedure is used to locate defective FRUs not found by normal diagnostics. For this procedure, diagnostics are run on a minimally configured system. If a failure is detected on the minimally configured system, the remaining FRUs are exchanged one at a time until the failing FRU is identified. If a failure is not detected, FRUs are added back until the failure occurs. The failure is then isolated to the failing FRU.

**Note:** the system backplane has two memory DIMM quads: *Un-P1-C14* to *Un-P1-C17*, and *Un-P1-C21* to *Un-P1-C24*. See System FRU locations.

Perform the following procedure:



- **PFW1548-1**

1. Ensure that the diagnostics and the operating system are shut down.

Is the system at "service processor standby", indicated by 01 in the control panel?

**No** Replace the system backplane, location: Un-P1. Return to step PFW1548-1.

**Yes** Continue with substep 2.

2. Turn on the power using either the white button or the ASMI menus.

Does the system reach an operating system login prompt, or if booting the AIX diagnostic CD-ROM, is the "Please define the System Console" screen displayed?

**No** Go to PFW1548-3.

**Yes** Go to PFW1548-2.

3. Insert the AIX diagnostic CD-ROM into the optical drive.

**Note:** If you cannot insert the diagnostic CD-ROM, go to PFW1548-2.

4. When the word *keyboard* is displayed on an ASCII terminal or a directly attached keyboard, press the number 5 key.

5. If you are prompted to do so, enter the appropriate password.

Is the "Please define the System Console" screen displayed?

**No** Go to PFW1548-2.

**Yes** Go to PFW1548-14.

- **PFW1548-2**

1. Insert the AIX diagnostic CD-ROM into the optical drive.

**Note:** If you cannot insert the diagnostic CD-ROM, go to step PFW1548-3.

2. Turn on the power using either the white button or the ASMI menus. If the diagnostic CD-ROM is not in the optical drive, insert it now. If you are prompted to do so, enter the appropriate password.

Is the "Please define the System Console" screen displayed?

**No** Go to PFW1548-3.

**Yes** Go to PFW1548-14.

- **PFW1548-3**

1. Turn off the power.
2. If you have not already done so, configure the service processor (using the ASMI menus) with the instructions in note 6 on page 112 at the beginning of this procedure, then return here and continue.
3. Exit the service processor (ASMI) menus and remove the power cords.
4. Disconnect all external cables (parallel, system port 1, system port 2, keyboard, mouse, USB devices, SPCN, Ethernet on the system planar, and so on). Also disconnect all of the external cables attached to the service processor.

Go to the next step.

- **PFW1548-4**

1. If this is a deskside system, remove the service access cover. If this is a rack-mounted system, place the drawer into the service position and remove the service access cover. Also remove the front cover.
2. Record the slot numbers of the PCI adapters and I/O expansion cards if present. Label and record the locations of all cables attached to the adapters. Disconnect all cables attached to the adapters and remove all of the adapters.

3. Remove the removable media or disk drive enclosure assembly by pulling out the blue tabs at the bottom of the enclosure, then sliding the enclosure out approximately three centimeters.
4. Remove and label the disk drives from the media or disk drive enclosure assembly.
5. Remove a memory DIMM quad.

**Notes:**

- a. Place the memory DIMM locking tabs in the locked (upright) position to prevent damage to the tabs.
  - b. Memory DIMMs must be installed in quads and in the correct connectors. See System FRU locations for information about memory DIMM locations.
6. Plug in the power cords and wait for 01 in the upper-left corner of the control panel display.
  7. Turn on the power using the white button.

Does the system reach an operating system login prompt, or if booting the AIX diagnostic CD-ROM, is the "Please define the System Console" screen displayed?

**No** Go to PFW1548-7.

**Yes** Go to the next step.

• **PFW1548-5**

Were any memory DIMMs removed from system backplane?

**No** Go to PFW1548-8.

**Yes** Go to the next step.

• **PFW1548-6**

1. Turn off the power, and remove the power cords.
2. Replug the memory DIMMs that were removed from the system backplane in PFW1548-2 in their original locations.

**Notes:**

- a. Place the memory DIMM locking tabs into the locked (upright) position to prevent damage to the tabs.
  - b. Memory DIMMs must be installed in quads in the correct connectors. See System FRU locations for information about memory DIMM locations.
3. Plug in the power cords and wait for 01 in the upper-left corner of the control panel display.
  4. Turn on the power using the white button.

Does the system reach an operating system login prompt, or if booting the AIX diagnostic CD-ROM, is the "Please define the System Console" screen displayed?

**No** A memory DIMM in the quad you just replaced in the system is defective. Turn off the power, remove the power cords, and exchange the memory DIMMs quad with new or previously removed memory DIMM quad. Repeat this step until the defective memory DIMM quad is identified, or both memory DIMM quads have been exchanged.

**Note:** the system backplane has two memory DIMM quads: *Un-P1-C14* to *Un-P1-C17* and *Un-P1-C21* to *Un-P1-C24*. See System FRU locations.

If your symptom did not change and both the memory DIMM quads have been exchanged, call your service support person for assistance.

If the symptom changed, check for loose cards and obvious problems. If you do not find a problem, go to the Problem Analysis procedures and follow the instructions for the new symptom.

**Yes** Go to the next step.

- **PFW1548-7**

One of the FRUs remaining in the system unit is defective.

**Note:** If a memory DIMM is exchanged, ensure that the new memory DIMM is the same size and speed as the original memory DIMM.

1. Turn off the power, remove the power cords, and exchange the following FRUs, one at a time, in the order listed:
  - a. Memory DIMMs. Exchange one quad at a time with new or previously removed DIMM quads
  - b. System backplane, location:  $Un-P1$
  - c. Power supplies, locations:  $Un-E1$  and  $Un-E2$ .
2. Plug in the power cords and wait for 01 in the upper-left corner of the control panel display.
3. Turn on the power using the white button.

Does the system reach an operating system login prompt, or if booting the AIX diagnostic CD-ROM, is the "Please define the System Console" screen displayed?

**No** Reinstall the original FRU.

Repeat the FRU replacement steps until the defective FRU is identified or all the FRUs have been exchanged.

If the symptom did not change and all the FRUs have been exchanged, call service support for assistance.

If the symptom has changed, check for loose cards, cables, and obvious problems. If you do not find a problem, go to the Problem Analysis procedures and follow the instructions for the new symptom.

**Yes** Go to Verify a repair.

- **PFW1548-8**

1. Turn off the power.
2. Reconnect the system console.

**Notes:**

- a. If an ASCII terminal has been defined as the firmware console, attach the ASCII terminal cable to the S1 connector on the rear of the system unit.
  - b. If a display attached to a display adapter has been defined as the firmware console, install the display adapter and connect the display to the adapter. Plug the keyboard and mouse into the keyboard connector on the rear of the system unit.
3. Turn on the power using the white button. (If the diagnostic CD-ROM is not in the optical drive, insert it now.)
  4. If the ASCII terminal or graphics display (including display adapter) is connected differently from the way it was previously, the console selection screen appears. Select a firmware console.
  5. Immediately after the word *keyboard* is displayed, press the number 1 key on the directly attached keyboard, or an ASCII terminal. This action activates the system management services (SMS).
  6. Enter the appropriate password if you are prompted to do so.

Is the SMS screen displayed?

**No** One of the FRUs remaining in the system unit is defective.

Exchange the FRUs that have not been exchanged, in the following order:

1. If you are using an ASCII terminal, go to the problem determination procedures for the display. If you do not find a problem, do the following:
  - a. Replace the system backplane, location:  $Un-P1$ .

2. If you are using a graphics display, go to the problem determination procedures for the display. If you do not find a problem, do the following:

- a. Replace the display adapter.
- b. Replace the backplane in which the graphics adapter is plugged.

Repeat this step until the defective FRU is identified or all the FRUs have been exchanged.

If the symptom did not change and all the FRUs have been exchanged, call service support for assistance.

If the symptom changed, check for loose cards, cables, and obvious problems. If you do not find a problem, go to the Problem Analysis procedures and follow the instructions for the new symptom.

**Yes** Go to the next step.

• **PFW1548-9**

1. Make sure the diagnostic CD-ROM is inserted into the optical drive.
2. Turn off the power and remove the power cords.
3. Use the cam levers to reconnect the disk drive enclosure assembly to the I/O backplane.
4. Reconnect the removable media or disk drive enclosure assembly by sliding the media enclosure toward the rear of the system, then pressing the blue tabs.
5. Plug in the power cords and wait for 01 in the upper-left corner of the operator panel display.
6. Turn on the power using the white button. (If the diagnostic CD-ROM is not in the optical drive, insert it now.)
7. Immediately after the word *keyboard* is displayed, press the number 5 key on either the directly attached keyboard or an ASCII terminal keyboard.
8. Enter the appropriate password if you are prompted to do so.

Is the "Please define the System Console" screen displayed?

**No** One of the FRUs remaining in the system unit is defective.

Exchange the FRUs that have not been exchanged, in the following order:

1. Optical drive
2. Removable media enclosure.
3. System backplane, Un-P1.

Repeat this step until the defective FRU is identified or all the FRUs have been exchanged.

If the symptom did not change and all the FRUs have been exchanged, call service support for assistance.

If the symptom has changed, check for loose cards, cables, and obvious problems. If you do not find a problem, go to Problem Analysis procedures and follow the instructions for the new symptom.

**Yes** Go to the next step.

• **PFW1548-10**

The system is working correctly with this configuration. One of the disk drives that you removed from the disk drive backplanes may be defective.

1. Make sure the diagnostic CD-ROM is inserted into the optical drive.
2. Turn off the power and remove the power cords.
3. Install a disk drive in the media or disk drive enclosure assembly.
4. Plug in the power cords and wait for the OK prompt to display on the operator panel display.
5. Turn on the power.

6. Immediately after the word *keyboard* is displayed, press the number 5 key on either the directly attached keyboard or an ASCII terminal keyboard.
7. Enter the appropriate password if you are prompted to do so.

Is the "Please define the System Console" screen displayed?

**No** Exchange the FRUs that have not been exchanged, in the following order:

1. Last disk drive installed
2. Disk drive backplane.

Repeat this step until the defective FRU is identified or all the FRUs have been exchanged.

If the symptom did not change and all the FRUs have been exchanged, call service support for assistance.

If the symptom has changed, check for loose cards, cables, and obvious problems. If you do not find a problem, go to Problem Analysis procedures and follow the instructions for the new symptom.

**Yes** Repeat this step with all disk drives that were installed in the disk drive backplane.

After all of the disk drives have been reinstalled, go to the next step.

• **PFW1548-11**

The system is working correctly with this configuration. One of the devices that was disconnected from the system backplane may be defective.

1. Turn off the power and remove the power cords.
2. Attach a system backplane device (for example: system port 1, system port 2, USB, keyboard, mouse, Ethernet) that had been removed.  
After all of the I/O backplane device cables have been reattached, reattached the cables to the service processor one at a time.
3. Plug in the power cords and wait for 01 in the upper-left corner on the operator panel display.
4. Turn on the power using the white button. (If the diagnostic CD-ROM is not in the optical drive, insert it now.)
5. If the Console Selection screen is displayed, choose the system console.
6. Immediately after the word *keyboard* is displayed, press the number 5 key on either the directly attached keyboard or on an ASCII terminal keyboard.
7. Enter the appropriate password if you are prompted to do so.

Is the "Please define the System Console" screen displayed?

**No** The last device or cable that you attached is defective.

To test each FRU, exchange the FRUs in the following order:

1. Device and cable (last one attached)
2. System backplane, location: Un-P1.

If the symptom did not change and all the FRUs have been exchanged, call service support for assistance.

If the symptom has changed, check for loose cards, cables, and obvious problems. If you do not find a problem, go to Problem Analysis procedures and follow the instructions for the new symptom.

**Yes** Repeat this step until all of the devices are attached. Go to the next step.

• **PFW1548-12**

The system is working correctly with this configuration. One of the FRUs (adapters) that you removed may be defective.

1. Turn off the power and remove the power cords.

2. Install a FRU (adapter) and connect any cables and devices that were attached to the FRU.
3. Plug in the power cords and wait for the OK prompt to display on the operator panel display.
4. Turn on the power using the white button. (If the diagnostic CD-ROM is not in the optical drive, insert it now.)
5. If the Console Selection screen is displayed, choose the system console.
6. Immediately after the word *keyboard* is displayed, press the number 5 key on either the directly attached keyboard or on an ASCII terminal keyboard.
7. Enter the appropriate password if you are prompted to do so.

Is the "Please define the System Console" screen displayed?

**No** Go to the next step.

**Yes** Repeat this step until all of the FRUs (adapters) are installed. Go to Verify a repair.

• **PFW1548-13**

The last FRU installed or one of its attached devices is probably defective.

1. Make sure the diagnostic CD-ROM is inserted into the optical drive.
2. Turn off the power and remove the power cords.
3. Starting with the last installed adapter, disconnect one attached device and cable.
4. Plug in the power cords and wait for the 01 in the upper-left corner on the operator panel display.
5. Turn on the power using either the white button. (If the diagnostic CD-ROM is not in the optical drive, insert it now.)
6. If the Console Selection screen is displayed, choose the system console.
7. Immediately after the word *keyboard* is displayed, press the number 5 key on either the directly attached keyboard or on an ASCII terminal keyboard.
8. Enter the appropriate password if you are prompted to do so.

Is the "Please define the System Console" screen displayed?

**No** Repeat this step until the defective device or cable is identified or all devices and cables have been disconnected.

If all the devices and cables have been removed, then one of the FRUs remaining in the system unit is defective.

To test each FRU, exchange the FRUs in the following order:

1. Adapter (last one installed)
2. System backplane, location: Un-P1.

If the symptom did not change and all the FRUs have been exchanged, call service support for assistance.

If the symptom has changed, check for loose cards, cables, and obvious problems. If you do not find a problem, go to the Problem Analysis procedures and follow the instructions for the new symptom.

**Yes** The last device or cable that you disconnected is defective. Exchange the defective device or cable and then go to the next step.

• **PFW1548-14**

1. Follow the instructions on the screen to select the system console.
2. When the DIAGNOSTIC OPERATING INSTRUCTIONS screen is displayed, press Enter.
3. Select **Advanced Diagnostics Routines**.
4. If the terminal type has not been defined, you must use the option **Initialize Terminal** on the FUNCTION SELECTION menu to initialize the AIX diagnostic environment before you can continue with the diagnostics. This is a separate operation from selecting the console display.
5. If the NEW RESOURCE screen is displayed, select an option from the bottom of the screen.

**Note:** Adapters and devices that require supplemental media are not shown in the new resource list. If the system has adapters or devices that require supplemental media, select option 1.

6. When the DIAGNOSTIC MODE SELECTION screen is displayed, press Enter.

7. Select **All Resources**. If you were sent here from step PFW1548-18, select the adapter or device that was loaded from the supplemental media.

Did you get an SRN?

**No** Go to step PFW1548-16.

**Yes** Go to the next step.

- **PFW1548-15**

Look at the FRU part numbers associated with the SRN.

Have you exchanged all the FRUs that correspond to the failing function codes (FFCs)?

**No** Exchange the FRU with the highest failure percentage that has not been changed.

Repeat this step until all the FRUs associated with the SRN have been exchanged or diagnostics run with no trouble found. Run diagnostics after each FRU is exchanged. Go to Verify a repair.

**Yes** If the symptom did not change and all the FRUs have been exchanged, call service support for assistance.

- **PFW1548-16**

Does the system have adapters or devices that require supplemental media?

**No** Go to step the next step.

**Yes** Go to step PFW1548-18.

- **PFW1548-17**

Consult the PCI adapter configuration documentation for your operating system to verify that all adapters are configured correctly.

Go to Verify a repair.

If the symptom did not change and all the FRUs have been exchanged, call service support for assistance.

- **PFW1548-18**

1. Select **Task Selection**.

2. Select **Process Supplemental Media** and follow the on-screen instructions to process the media. Supplemental media must be loaded and processed one at a time.

Did the system return to the TASKS SELECTION SCREEN after the supplemental media was processed?

**No** Go to the next step.

**Yes** Press F3 to return to the FUNCTION SELECTION screen. Go to step PFW1548-14, substep 4 on page 138.

- **PFW1548-19**

The adapter or device is probably defective.

If the supplemental media is for an adapter, replace the FRUs in the following order:

1. Adapter
2. System backplane, location: Un-P1.

If the supplemental media is for a device, replace the FRUs in the following order:

1. Device and any associated cables
2. The adapter to which the device is attached

Repeat this step until the defective FRU is identified or all the FRUs have been exchanged.

If the symptom did not change and all the FRUs have been exchanged, call service support for assistance.

If the symptom has changed, check for loose cards, cables, and obvious problems. If you do not find a problem, go to the Problem Analysis procedures and follow the instructions for the new symptom.

Go to Verify a repair.

This ends the procedure.

## Problems with noncritical resources

Use this procedure to help you determine the cause of problems with noncritical resources.

1. Is there an SRC in an 8-character format available on the problem summary form?

**Note:** If the operator has not filled out the problem summary form, go to the problem reporting procedure for the operating system in use.

**No:** Continue with the next step.

**Yes:** Perform problem analysis using the SRC. **This ends the procedure.**

2. Does the problem involve a workstation resource?

- **No:** Continue with the next step.

- **Yes:** Perform the following steps:

- Check that the workstation is operational.

- Verify that the cabling and addressing for the workstation is correct.

- Perform any actions indicated in the system operator message.

If you need further assistance, contact your next level of support. **This ends the procedure.**

3. Does the problem involve a removable media resource?

**No:** Continue with the next step.

**Yes:** Go to “Using the product activity log” on page 72 to resolve the problem. **This ends the procedure.**

4. Does the problem involve a communications resource?

- **No:** Contact your next level of support. **This ends the procedure.**

- **Yes:** Are there any system operator messages that indicate a communications-related problem has occurred?

- **No:** Contact your next level of support. **This ends the procedure.**

- **Yes:** Perform any actions indicated in the system operator message. If you need further assistance, contact your next level of support. **This ends the procedure.**

## Intermittent problems

An intermittent problem is a problem that occurs for a short time, and then goes away.

The problem may not occur again until some time in the future, if at all. Intermittent problems cannot be made to appear again easily.

Some examples of intermittent problems are:

- A reference code appears on the control panel (the system attention light is on) but disappears when you power off, then power on the system. An entry does not appear in the Product Activity Log.
- An entry appears in the problem log when you use the Work with Problems (WRKPRB) command. For example, the 5094 expansion unit becomes powered off, but starts working again when you power it on.
- The workstation adapter is in a hang condition but starts working normally when it gets reset.

**Note:** You can get equipment for the following conditions from your branch office or installation planning representative:



- If you suspect that the air at the system site is too hot or too cold, you need a thermometer to check the temperature.
- If you suspect the moisture content of the air at the system site is too low or too high, use a wet/dry bulb to check the humidity. See “General intermittent problem checklist” on page 142 for more information.
- If you need to check ac receptacles for correct wiring, you need an ECOS tester, Model 1023-100, or equivalent tester. The tester lets you quickly check the receptacles. If you cannot find a tester, use an analog multimeter instead. Do not use a digital multimeter.

Follow the steps below to correct an intermittent problem:

1. Read the information in “About intermittent problems” before you attempt to correct an intermittent problem. Then continue with the next step of this procedure.
2. Perform *all* steps in the “General intermittent problem checklist” on page 142. Then continue with the next step of this procedure.
3. Did you correct the intermittent problem?

**Yes: This ends the procedure.**

**No:** Go to “Analyzing intermittent problems” on page 144. **This ends the procedure.**

### About intermittent problems:

An intermittent problem can show many different symptoms, so it might be difficult for you to determine the real cause without completely analyzing the failure.

To help with this analysis, you should determine as many symptoms as possible.

- The complete reference code is necessary to determine the exact failing area and the probable cause.
- Product activity log (PAL) information can provide time and device relationships.
- Information about environmental conditions when the failure occurred can be helpful (for example, an electrical storm occurring when the failure happened).

**Note:** If you suspect that an intermittent problem is occurring, increase the log sizes to the largest sizes possible. Select the PAL option on the Start a Service Tool display (see Product activity log for details).

### Types of intermittent problems

Following are the major types of intermittent problems:

- Code (PTFs):
  - Licensed internal code
  - IBM i
  - Licensed program products
  - Other application software
- Configuration:
  - Non-supported hardware that is used on the system
  - Non-supported system configurations
  - Non-supported communication networks
  - Model and feature upgrades that are not performed correctly
  - Incorrectly configured or incorrectly cabled devices
- Environment:
  - Power line disturbance (for example, reduced voltage, a pulse, a surge, or total loss of voltage on the incoming ac voltage line)
  - Power line transient (for example, lightning strike)

- Electrical noise (constant or intermittent)
- Defective grounding or a ground potential difference
- Mechanical vibration
- Intermittent hardware failure

### General intermittent problem checklist:

Use the following procedure to correct intermittent problems.

Performing these steps removes the known causes of most intermittent problems.

1. Discuss the problem with the customer. Look for the following symptoms:
  - A reference code that goes away when you power off and then power on the system.
  - Repeated failure patterns that you cannot explain. For example, the problem occurs at the same time of day or on the same day of the week.
  - Failures that started after system relocation.
  - Failures that occurred during the time specific jobs or software were running.
  - Failures that started after recent service or customer actions, system upgrade, addition of I/O devices, new software, or program temporary fix (PTF) installation.
  - Failures occurring only during high system usage.
  - Failures occur when people are close to the system or machines are attached to the system.
2. Recommend that the customer install the latest cumulative PTF package, since code PTFs have corrected many problems that seem to be hardware failures. The customer can order the latest cumulative PTF package electronically through Electronic Customer Support or by calling the Software Support Center.
3. If you have not already done so, use the maintenance package to see the indicated actions for the symptom described by the customer. Attempt to perform the on-line problem analysis procedure first. If this is not possible, such as when the system is down, go to the Starting a repair action Use additional diagnostic tools, if necessary, and attempt to recreate the problem.

**Note:** Ensure that the service information you are using is at the same level as the operating system.

4. Check the site for the following environmental conditions:
  - a. Any electrical noise that matches the start of the intermittent problems. Ask the customer such questions as:
    - Have any external changes or additions, such as building wiring, air conditioning, or elevators been made to the site?
    - Has any arc welding occurred in the area?
    - Has any heavy industrial equipment, such as cranes, been operating in the area?
    - Have there been any thunderstorms in the area?
    - Have the building lights become dim?
    - Has any equipment been relocated, especially computer equipment?
 If there was any electrical noise, find its source and prevent the noise from getting into the system.
  - b. Site temperature and humidity conditions that are within the system specifications. See temperature and humidity design criteria in the Planning topic.
  - c. Poor air quality in the computer room:
    - Look for dust on top of objects. Dust particles in the air cause poor electrical connections and may cause disk unit failures.
    - Smell for unusual odors in the air. Some gases can corrode electrical connections.

- d. Any large vibration (caused by thunder, an earthquake, an explosion, or road construction) that occurred in the area at the time of the failure.

**Note:** A failure that is caused by vibration is more probable if the server is on a raised floor.

5. Ensure that all ground connections are tight. These items reduce the effects of electrical noise. Check the ground connections by measuring the resistance between a conductive place on the frame to building ground or to earth ground. The resistance must be 1.0 ohm or less.
6. Ensure proper cable retention is used, as provided. If no retention is provided, the cable should be strapped to the frame to release tension on cable connections.  
Ensure that you pull the cable ties tight enough to fasten the cable to the frame bar tightly. A loose cable can be accidentally pulled with enough force to unseat the logic card in the frame to which the cable is attached. If the system is powered on, the logic card could be destroyed.
7. Ensure that all workstation and communications cables meet hardware specifications:
  - All connections are tight.
  - Any twinaxial cables that are not attached to devices must be removed.
  - The lengths and numbers of connections in the cables must be correct.
  - Ensure that lightning protection is installed on any twinaxial cables that enter or leave the building.
8. Perform the following:
  - a. Review recent repair actions. Contact your next level of support for assistance.
  - b. Review entries in the problem log (WRKPRB). Look for problems that were reported to the user.
  - c. Review entries in the PAL, SAL, and service processor log. Look for a pattern:
    - SRCs on multiple adapters occurring at the same time
    - SRCs that have a common time-of-day or day-of-week pattern
    - Log is wrapping (hundreds of recent entries and no older entries)Check the PAL sizes and increase them if they are smaller than recommended.
  - d. Review entries in the history log (Display Log (DSPLDG)). Look for a change that matches the start of the intermittent problems.
  - e. Ensure that the latest engineering changes are installed on the system and on all system I/O devices.
9. Ensure that the hardware configuration is correct and that the model configuration rules have been followed. Use the **Display hardware configuration** service function (under SST or DST) to check for any missing or failed hardware.
10. Was a system upgrade, feature, or any other field bill of material or feature field bill of material installed just before the intermittent problems started occurring?  
**No:** Continue with the next step.  
**Yes:** Review the installation instructions to ensure that each step was performed correctly. Then continue with the next step of this procedure.
11. Is the problem associated with a removable media storage device?  
**No:** Continue with the next step.  
**Yes:** Ensure that the customer is using the correct removable media storage device cleaning procedures and good storage media. Then continue with the next step of this procedure.
12. Perform the following to help prevent intermittent thermal checks:
  - Ensure that the AMDs are working.
  - Exchange all air filters as recommended.
13. If necessary, review the intermittent problems with your next level of support and installation planning representative. Ensure that all installation planning checks were made on the system. Because external conditions are constantly changing, the site may need to be checked again. **This ends the procedure.**

## Analyzing intermittent problems:

This procedure enables you to begin analyzing an intermittent problem.

Use this procedure only after you have first reviewed the information in “About intermittent problems” on page 141 and gone through the “General intermittent problem checklist” on page 142.

1. Is a reference code associated with the intermittent problem?

**No:** Continue with the next step.

**Yes:** Go to Reference codes. If the actions in the reference code tables do not correct the intermittent problem, return here and continue with the next step.

2. Is a symptom associated with the intermittent problem?

**No:** Continue with the next step.

**Yes:** Go to “Intermittent symptoms.” If the information there does not help to correct the intermittent problem, return here and continue with the next step.

3. Go to “Failing area intermittent isolation procedures.” If the information there does not help to correct the intermittent problem, return here and continue with the next step.

4. Send the data you have collected to your next level of support so that an Authorized Program Analysis Report (APAR) can be written. **This ends the procedure.**

## Intermittent symptoms:

Use the table below to find the symptom and description of the intermittent problem. Then perform the corresponding intermittent isolation procedures.

Although an isolation procedure may correct the intermittent problem, use your best judgment to determine if you should perform the remainder of the procedure shown for the symptom.

**Note:** If the symptom for the intermittent problem you have is not listed, go to “Failing area intermittent isolation procedures.”

Table 19. Intermittent symptoms

Symptom	Description	Isolation procedure
System powered off.	The system was operating correctly, then the system powered off. A 1xxx SRC may occur when this happens, and this SRC info should be logged in the service processor log.	INTIP09
System stops.	The system is powered on but is not operating correctly. No SRC is displayed. The system attention light is off and the processor activity lights may be on or off. Noise on the power-on reset line can cause the processor to stop.	INTIP18
System or subsystem runs slow.	The system or the subsystem is not processing at its normal speed.	INTIP20

## Failing area intermittent isolation procedures:

This procedure helps you determine how to resolve intermittent problems when you do not have a system reference code (SRC) or cannot determine the symptom.

Use this table only if you do not have a system reference code (SRC), or cannot find your symptom in “Intermittent symptoms.”

1. Perform all of the steps in “General intermittent problem checklist” on page 142 for all failing areas. Then continue with the next step.

2. Refer to the table below, and perform the following:
  - a. Find the specific area of failure under **Failing area**.
  - b. Look down the column of the area of failure until you find an X.
  - c. Look across to the **Isolation procedure** column and perform the procedure indicated.
  - d. If the isolation procedure does not correct the intermittent problem, continue down the column of the area of failure until you have performed all of the procedures shown for the failing area.
3. Although an isolation procedure may correct the intermittent problem, use your best judgment to determine if you should perform the remainder of the procedures shown for the failing area.

Table 20. Failing area intermittent isolation procedures

Failing area						Isolation procedure to perform:
Power	Work station I/O processor	Disk unit adapter	Comm-unication	Processor bus	Tape optical	Perform all steps in:
X	X	X	X	X	X	"General intermittent problem checklist" on page 142
X	X			X		INTIP09
	X	X	X	X	X	INTIP07
X						INTIP09
X						INTIP14
		X				INTIP16
X	X	X	X	X	X	INTIP18
	X	X	X	X	X	INTIP20

## IPL problems

Use these scenarios to help you diagnose your IPL problem:

### Cannot perform IPL from the control panel (no SRC):

Use this procedure when you cannot perform an IBM i IPL from the control panel (no SRC).

### DANGER

An electrical outlet that is not correctly wired could place hazardous voltage on the metal parts of the system or the devices that attach to the system. It is the responsibility of the customer to ensure that the outlet is correctly wired and grounded to prevent an electrical shock. (D004)

1. Perform the following:
  - a. Verify that the power cable is plugged into the power outlet.
  - b. Verify that power is available at the customer's power outlet.
2. Start an IPL by doing the following:
  - a. Select Manual mode and IPL type A or B on the control panel. See Control panel functions for details.
  - b. Power on the system. See Powering on and off.

Does the IPL complete successfully?

**No:** Continue with the next step.

**Yes: This ends the procedure.**
3. Have all the units in the system become powered on that you expected to become powered on?
 

**Yes:** Continue with the next step.

**No:** Go to Power problems and find the symptom that matches the problem. **This ends the procedure.**

4. Is an SRC displayed on the control panel?
  - **Yes:** Go to Power problems and use the displayed SRC to correct the problem. **This ends the procedure.**
  - **No:** For all models, exchange the following FRUs, one at a time. Refer to the remove and replace procedures for your specific system for additional information.
    - a. SPCN card unit. See symbolic FRU TWRCARD.
    - b. Power Supply. See symbolic FRU PWRSPLY. **This ends the procedure.**

#### **Cannot perform IPL at a specified time (no SRC):**

Use this procedure when you cannot perform an IBM i IPL at a specified time (no SRC). To correct the IPL problem, perform this procedure until you determine the problem and can perform an IPL at a specified time.

#### **DANGER**

**An electrical outlet that is not correctly wired could place hazardous voltage on the metal parts of the system or the devices that attach to the system. It is the responsibility of the customer to ensure that the outlet is correctly wired and grounded to prevent an electrical shock. (D004)**

1. Verify the following:
  - a. The power cable is plugged into the power outlet.
  - b. That power is available at the customer's power outlet.
2. Power on the system in normal mode. See Powering on and off.

Does the IPL complete successfully?

**Yes:** Continue with the next step.

**No:** Go to the Starting a repair action procedure. **This ends the procedure.**
3. Have all the units in the system become powered on that you expected to become powered on?

**Yes:** Continue with the next step.

**No:** Go to Starting a repair action and find the symptom that matches the problem. **This ends the procedure.**
4. Verify the requested system IPL date and time by doing the following:
  - a. On the command line, enter the Display System Value command:  
DPSYSVAL QIPLDATTIM  
Observe the system value parameters.  
  
**Note:** The system value parameters are the date and time the system operator requested a timed IPL.

```

+-----+
| Display System Value
| System: S0000000
| System value . . . . . : QIPLDATTIM
|
| Description . . . . . : Date and time to automatically IPL
|
| IPL date . . . . . : MM/DD/YY
| IPL time . . . . . : HH:MM:SS
+-----+

```

Figure 3. Display for QIPLDATTIM

- b. Verify the system date. On the command line, enter the Display System Value command:  
 DSPSYSVAL QDATE  
 Check the system values for the date.

```

+-----+
| Display System Value
| System: S0000000
| System value . . . . . : QDATE
|
| Description . . . . . : System date
|
| Date . . . . . : MM/DD/YY
+-----+

```

Figure 4. Display for QDATE

Does the operating system have the correct date?

- **Yes:** Continue with this step.
- **No:** Set the correct date by doing the following:
  - 1) On the command line, enter the Change System Value command (CHGSYSVAL QDATE VALUE('mmdyy')).
  - 2) Set the date by entering
    - mm=month
    - dd=day
    - yy=year
  - 3) Press **Enter**.

- c. Verify the system time. On the command line, enter the Display System Value command:  
 DSPSYSVAL QTIME  
 Check the system values for the time.

```

+-----+
| Display System Value
| System: S0000000
| System value . . . . . : QTIME
|
| Description . . . . . : Time of day
|
| Time . . . . . : HH:MM:SS
+-----+

```

Figure 5. Display for QTIME

Does the operating system have the correct time?

- **Yes:** Continue with this step.
- **No:** Set the correct time by doing the following:

- 1) On the command line, enter the Change System Value command (CHGSYSVAL QTIME VALUE('hhmmss')).
  - 2) Set the time by entering
    - hh=24 hour time clock
    - mm=minutes
    - ss=seconds
  - 3) Press **Enter** and continue with the next step.
5. Verify that the system can perform an IPL at a specified time by doing the following:
- a. Set the IPL time to 5 minutes past the present time by entering the Change System Value command (CHGSYSVAL SYSVAL(QIPLDATTIM) VALUE('mmddy hhmmss')) on the command line.
    - mm = month to power on
    - dd = day to power on
    - yy = year to power on
    - hh = hour to power on
    - mm = minute to power on
    - ss = second to power on
  - b. Power off the system by entering the Power Down System Immediate command (PWRDWN SYS \*IMMED) on the command line.
  - c. Wait 5 minutes.
 

Does the IPL start at the time you specified?

**No:** Continue with the next step.

**Yes: This ends the procedure.**
6. Power on the system in normal mode. See Powering on and off.
- Does the IPL complete successfully?
- Yes:** Continue with the next step.
- No:** Go to Starting a repair action. **This ends the procedure.**
7. Find an entry in the Service Action Log that matches the time, SRC, and/or resource that compares to the reported problem.
- a. On the command line, enter the Start System Service Tools command:
 

```
STRSST
```

If you cannot get to SST, select DST. See Dedicated service tools (DST) for details.

**Note:** Do not IPL the system or partition to get to DST.
  - b. On the Start Service Tools Sign On display, type in a user ID with service authority and password.
  - c. Select **Start a Service Tool** → **Hardware Service Manager** → **Work with service action log**.
  - d. On the Select Timeframe display, change the From: Date and Time to a date and time prior to when the customer reported having the problem.
  - e. Find an entry that matches one or more conditions of the problem:
    - SRC
    - Resource
    - Time
    - FRU list (choose **Display the failing item information** to display the FRU list).

**Notes:**

- a. All entries in the service action log represent problems that require a service action. It may be necessary to handle any problem in the log even if it does not match the original problem symptom.



- b. The information displayed in the date and time fields are the time and date for the first occurrence of the specific system reference code (SRC) for the resource displayed during the time range selected.

Did you find an entry in the Service Action Log?

**No:** Continue with the next step.

**Yes:** Go to step 9.

8. Exchange the following parts one at a time. See the remove and replace procedures for your specific system. After exchanging each part, return to step 5 on page 148 to verify that the system can perform an IPL at a specified time.

**Note:** If you exchange the control panel or the system backplane, you must set the correct date and time by performing step 4 on page 146.

**Attention:** Before exchanging any part, power off the system. See Powering on and off.

- System unit backplane (see symbolic FRU SYSBKPL).
- System control panel
- System control panel cable

Did the IPL complete successfully after you exchanged all of the parts listed above?

**No:** Contact your next level of support. **This ends the procedure.**

**Yes:** Continue with the next step.

9. Was the entry isolated (is there a Y in the Isolated column)?

- **No:** Go to the Reference codes and use the SRC indicated in the log. **This ends the procedure.**
- **Yes:** Display the failing item information for the Service Action Log entry. Items at the top of the failing item list are more likely to fix the problem than items at the bottom of the list.

Exchange the failing items one at a time until the problem is repaired. After exchanging each one of the items, verify that the item exchanged repaired the problem.

**Notes:**

- a. For symbolic FRUs see Symbolic FRUs.
- b. When exchanging FRUs, refer to the remove and replace procedures for your specific system.
- c. After exchanging an item, go to Verifying the repair.

After the problem has been resolved, close the log entry by selecting **Close a NEW entry** on the Service Actions Log Report display. **This ends the procedure.**

**Cannot automatically perform an IPL after a power failure:**

Use this procedure when you cannot automatically perform an IBM i IPL after a power failure.

1. Normal or Auto mode on the control panel must be selected when power is returned to the system.

Is Normal or Auto mode on the control panel selected?

**Yes:** Continue with the next step.

**No:** Select **Normal** or **Auto** mode on the control panel. **This ends the procedure.**

2. Use the Display System Value command (DSPSYSVAL) to verify that the system value under QPWRRSTIPL on the Display System Value display is equal to 1.

Is QPWRRSTIPL equal to 1?

**Yes:** Continue with the next step.

**No:** Use the Change System Value command (CHGSYSVAL) to set QPWRRSTIPL equal to 1. **This ends the procedure.**

3. For Models 520 and 570, exchange the Tower card. See symbolic FRU TWRCARD. Refer to the remove and replace procedures for your specific system. Also, before exchanging any part, power off the system. See Powering on and off.

**Note:** If you exchange the tower card or the system unit backplane, you must set the system date (QDATE) and time (QTIME). **This ends the procedure.**

## Power problems

Use the following table to learn how to begin analyzing a power problem.

*Table 21. Analyzing power problems*

Symptom	What you should do
System unit does not power on.	See "Cannot power on system unit."
The processor or I/O expansion unit does not power off.	See "Cannot power off system or SPCN-controlled I/O expansion unit" on page 159.
The system does not remain powered on during a loss of incoming ac voltage and has an uninterruptible power supply (UPS) installed.	See the UPS user's guide that was provided with your unit.
An I/O expansion unit does not power on.	See "Cannot power on SPCN-controlled I/O expansion unit" on page 154.

### Cannot power on system unit:

Perform this procedure until you correct the problem and you can power on the system.

For important safety information before continuing with this procedure, see "Power isolation procedures" on page 153.

1. Attempt to power on the system. See Powering on and powering off the system for information about powering on or off your system. Does the system power on, and is the system power status indicator light on continuously?

**Note:** The system power status indicator blinks at the slower rate (one blink per two seconds) while powered off, and at the faster rate (one blink per second) during a normal power-on sequence.

**No:** Continue with the next step.

**Yes:** Go to step 18 on page 153.

2. Are there any characters displayed on the control panel (a scrolling dot may be visible as a character)?

**No:** Continue with the next step.

**Yes:** Go to step 5 on page 151.

3. Are the mainline ac power cables from the power supply, power distribution unit, or external uninterruptible power supply (UPS) to the customer's ac power outlet connected and seated correctly at both ends?

**Yes:** Continue with the next step.

**No:** Connect the mainline ac power cables correctly at both ends and go to step 1.

4. Perform the following steps:

- a. Verify that the UPS is powered on (if it is installed). If the UPS will not power on, follow the service procedures for the UPS to ensure proper line voltage and UPS operation.
- b. Disconnect the mainline ac power cable or ac power jumper cable from the system's ac power connector at the system.
- c. Use a multimeter to measure the ac voltage at the system end of the mainline ac power cable or ac power jumper cable.

**Note:** Some system models have more than one mainline ac power cable or ac power jumper cable. For these models, disconnect all the mainline ac power cables or ac power jumper cables and measure the ac voltage at each cable before continuing with the next step.

Is the ac voltage from 200 V ac to 240 V ac, or from 100 V ac to 127 V ac?

**No:** Go to step 13 on page 152.

**Yes:** Continue with the next step.

5. Perform the following steps:
  - a. Disconnect the mainline ac power cables from the power outlet.
  - b. Exchange the system unit control panel (Un-D1). See System FRU locations.
  - c. Reconnect the mainline ac power cables to the power outlet.
  - d. Attempt to power on the system.

Does the system power on?

**No:** Continue with the next step.

**Yes:** The system unit control panel was the failing item. **This ends the procedure.**

6. Perform the following steps:
  - a. Disconnect the mainline ac power cables from the power outlet.
  - b. Exchange the power supply or supplies (Un-E1, Un-E2). See System FRU locations.
  - c. Reconnect the mainline ac power cables to the power outlet.
  - d. Attempt to power on the system. See Powering on and powering off the system.

Does the system power on?

**No:** Continue with the next step.

**Yes:** The power supply was the failing item. **This ends the procedure.**

7. Is the system a 9117-MMB, 9117-MMC, 9179-MHB, or 9179-MHC?

**No:** Go to step 12.

**Yes:** Continue with the next step.

8. Perform the following steps:
  - a. Disconnect the mainline ac power cables.
  - b. Replace the service processor card in the primary processor enclosure.
  - c. Reconnect the mainline ac power cables to the power outlet.
  - d. Attempt to power on the system. Does the system power on?

**No:** Continue with the next step.

**Yes:** The service processor card was the failing item. **This ends the procedure.**

9. Perform the following steps:
  - a. Disconnect the mainline ac power cables.
  - b. Replace the service processor card in the first secondary processor enclosure.
  - c. Reconnect the mainline ac power cables to the power outlet.
  - d. Attempt to power on the system. Does the system power on?

**No:** Continue with the next step.

**Yes:** The service processor card was the failing item. This ends the procedure.

10. Perform the following steps:
  - a. Disconnect the mainline ac power cables.
  - b. Replace the midplane in the primary processor enclosure.
  - c. Reconnect the mainline ac power cables to the power outlet.
  - d. Attempt to power on the system. Does the system power on?

**No:** Continue with the next step.

**Yes:** The midplane was the failing item. **This ends the procedure.**

11. Perform the following steps:
  - a. Disconnect the mainline ac power cables.
  - b. Replace the midplane in the first secondary processor enclosure.
  - c. Reconnect the mainline ac power cables to the power outlet.
  - d. Attempt to power on the system. Does the system power on?

**No:** Contact your next level of support.

**Yes:** The midplane was the failing item. **This ends the procedure.**
12. Perform the following steps:
  - a. Disconnect the mainline ac power cables.
  - b. Replace the system backplane (Un-P1). See System FRU locations.
  - c. Reconnect the mainline ac power cables to the power outlet.
  - d. Attempt to power on the system.Does the system power on?

**No:** Continue with the next step.

**Yes:** The system backplane was the failing item. **This ends the procedure.**
13. Are you working with a system unit with a power distribution unit with tripped breakers?
  - **No:** Continue with the next step.
  - **Yes:** Perform the following steps:
    - a. Reset the tripped power distribution breaker.
    - b. Verify that the removable ac power cable is not the problem. Replace the cord if it is defective.
    - c. If the breaker continues to trip, install a new power supply in each location until the defective one is found. **This ends the procedure.**
14. Does the system have an external UPS installed?

**Yes:** Continue with the next step.

**No:** Go to step 16.
15. Use a multimeter to measure the ac voltage at the external UPS outlets. Is the ac voltage from 200 V ac to 240 V or from 100 V ac to 127 V ac?

**No:** The UPS needs service. For 9910 type UPS, call IBM Service Support. For all other UPS types, have the customer call the UPS provider. In the meantime, go to step 17 to bypass the UPS.

**Yes:** Replace the ac power cable. See System parts for FRU part number. **This ends the procedure.**
16. Perform the following steps:
  - a. Disconnect the mainline ac power cable from the customer's ac power outlet.
  - b. Use a multimeter to measure the ac voltage at the customer's ac power outlet.

**Note:** Some system models have more than one mainline ac power cable. For these models, disconnect all the mainline ac power cables and measure the ac voltage at all ac power outlets before continuing with this step.

Is the ac voltage from 200 V ac to 240 V ac or from 100 V ac to 127 V ac?

**Yes:** Exchange the mainline ac power cable. See System parts for the FRU part number. Then go to step 1 on page 150.

**No:** Inform the customer that the ac voltage at the power outlet is not correct. When the ac voltage at the power outlet is correct, reconnect the mainline ac power cables to the power outlet. **This ends the procedure.**
17. Perform the following steps to bypass the UPS unit:
  - a. Power off your system and the UPS unit.
  - b. Remove the signal cable used between the UPS and the system.

- c. Remove any power jumper cords used between the UPS and the attached devices.
- d. Remove the country or region-specific power cord used from the UPS to the wall outlet.
- e. Use the correct power cord (the original country or region-specific power cord that was provided with your system) and connect it to the power inlet on the system. Plug the other end of this cord into a compatible wall outlet.
- f. Attempt to power on the system.

Does the power-on standby sequence complete successfully?

**Yes:** Go to Verify a repair. **This ends the procedure.**

**No:** Go to step 5 on page 151.

18. Display the selected IPL mode on the system unit control panel. Is the selected mode the same mode that the customer was using when the power-on failure occurred?

**No:** Go to step 20.

**Yes:** Continue with the next step.

19. Is a function 11 reference code displayed on the system unit control panel?

**No:** Go to step 21.

**Yes:** Return to Start of call. **This ends the procedure.**

20. Perform the following steps:

- a. Power off the system. See Powering on and powering off the system for information about powering on and off your system.
- b. Select the mode on the system unit control panel that the customer was using when the power-on failure occurred.
- c. Attempt to power on the system.

Does the system power on?

**Yes:** Continue with the next step.

**No:** Exchange the system unit control panel (Un-D1). See System FRU locations. **This ends the procedure.**

21. Continue the IPL. Does the IPL complete successfully?

**Yes:** **This ends the procedure.**

**No:** Return to Start of call. **This ends the procedure.**

#### *Power isolation procedures:*

Use power isolation procedures for isolating a problem in the power system. Use isolation procedures if there is not a management console attached to the server. If the server is connected to a management console, use the procedures that are available on the management console to continue FRU isolation.

Some field replaceable units (FRUs) can be replaced with the unit powered on. Follow the instructions in System FRU locations when directed to remove, exchange, or install a FRU.

The following safety notices apply throughout the power isolation procedures. Read all safety procedures before servicing the system and observe all safety procedures when performing a procedure.

## DANGER

When working on or around the system, observe the following precautions:

Electrical voltage and current from power, telephone, and communication cables are hazardous. To avoid a shock hazard:

- Connect power to this unit only with the IBM provided power cord. Do not use the IBM provided power cord for any other product.
- Do not open or service any power supply assembly.
- Do not connect or disconnect any cables or perform installation, maintenance, or reconfiguration of this product during an electrical storm.
- The product might be equipped with multiple power cords. To remove all hazardous voltages, disconnect all power cords.
- Connect all power cords to a properly wired and grounded electrical outlet. Ensure that the outlet supplies proper voltage and phase rotation according to the system rating plate.
- Connect any equipment that will be attached to this product to properly wired outlets.
- When possible, use one hand only to connect or disconnect signal cables.
- Never turn on any equipment when there is evidence of fire, water, or structural damage.
- Disconnect the attached power cords, telecommunications systems, networks, and modems before you open the device covers, unless instructed otherwise in the installation and configuration procedures.
- Connect and disconnect cables as described in the following procedures when installing, moving, or opening covers on this product or attached devices.

To Disconnect:

1. Turn off everything (unless instructed otherwise).
2. Remove the power cords from the outlets.
3. Remove the signal cables from the connectors.
4. Remove all cables from the devices

To Connect:

1. Turn off everything (unless instructed otherwise).
2. Attach all cables to the devices.
3. Attach the signal cables to the connectors.
4. Attach the power cords to the outlets.
5. Turn on the devices.

(D005)

### Cannot power on SPCN-controlled I/O expansion unit:

You are here because an SPCN-controlled I/O expansion unit cannot be powered on, and might be displaying a 1xxxC62E reference code.

For important safety information before continuing with this procedure, see "Power isolation procedures" on page 153.

1. Power on the system.
2. Start from SPCN 0 or SPCN 1 on the system unit. See System FRU locations, then go to the first unit in the SPCN frame-to-frame cable sequence that does not power on. Is the Data display background light on, or is the power-on LED blinking, or are there any characters displayed on the I/O expansion unit display panel?

**Note:** The background light is a dim yellow light in the Data area of the display panel.

**Yes:** Go to step 12 on page 156.

**No:** Continue with the next step.

3. Use a multimeter to measure the ac voltage at the customer's ac power outlet.

Is the ac voltage from 200 V ac to 240 V ac, or from 100 V ac to 127 V ac?

- **Yes:** Continue with the next step.
- **No:** Inform the customer that the ac voltage at the power outlet is not correct.

**This ends the procedure.**

4. Is the mainline ac power cable from the ac module, power supply, or power distribution unit to the customer's ac power outlet connected and seated correctly at both ends?

- **Yes:** Continue with the next step.
- **No:** Connect the mainline ac power cable correctly at both ends.

**This ends the procedure.**

5. Perform the following steps:

- a. Disconnect the mainline ac power cable from the ac module, power supply, or power distribution unit.
- b. Use a multimeter to measure the ac voltage at the ac module, power supply, or power distribution unit end of the mainline ac power cable.

Is the ac voltage from 200 V ac to 240 V ac, or from 100 V ac to 127 V ac?

**No:** Continue with the next step.

**Yes:** Go to step 7.

6. Are you working on a power distribution unit with tripped breakers?

- **No:** Replace the mainline ac power cable or power distribution unit.

**This ends the procedure.**

- **Yes:** Perform the following steps:

- a. Reset the tripped power distribution breaker.
- b. Verify that the removable ac line cord is not the problem. Replace the cord if it is defective.
- c. Install a new power supply (one with the same part number as the one that is currently installed) in all power locations until the defective one is found.

**This ends the procedure.**

7. Does the unit you are working on have ac power jumper cables installed?

**Note:** The ac power jumper cables connect from the ac module, or the power distribution unit, to the power supplies.

**Yes:** Continue with the next step.

**No:** Go to step 11 on page 156.

8. Are the ac power jumper cables connected and seated correctly at both ends?

- **Yes:** Continue with the next step.
- **No:** Connect the ac power jumper cables correctly at both ends.

**This ends the procedure.**

9. Perform the following steps:

- a. Disconnect the ac power jumper cables from the ac module or power distribution unit.
- b. Use a multimeter to measure the ac voltage at the ac module or power distribution unit (that goes to the power supplies).

Is the ac voltage at the ac module or power distribution unit from 200 V ac to 240 V ac, or from 100 V ac to 127 V ac?

- **Yes:** Continue with the next step.
- **No:** Replace the following items (see System parts for location and part number information):
  - ac module
  - Power distribution unit

**This ends the procedure.**

10. Perform the following steps:
  - a. Connect the ac power jumper cables to the ac module, or power distribution unit.
  - b. Disconnect the ac power jumper cable at the power supplies.
  - c. Use a multimeter to measure the voltage input that the power jumper cables provide to the power supplies.

Is the voltage 200 V ac to 240 V ac or 100 V ac to 127 V ac for each power jumper cable?

- **No:** Exchange the power jumper cable.

**This ends the procedure.**

- **Yes:** Replace the following parts one at a time:

- a. One of the FRUs listed in the following table, according to the enclosure:

*Table 22. Enclosures FRU to be exchanged*

Enclosure	FRU
5796, 7314-G30	I/O backplane

- b. Display unit
- c. Power supply 1
- d. Power supply 2
- e. Power supply 3

**This ends the procedure.**

11. Perform the following steps:
  - a. Disconnect the mainline ac power cable (to the expansion unit) from the customer's ac power outlet.
  - b. Exchange the following FRUs, one at a time:
    - Power supply.
    - One of the FRUs listed in the following table, according to the enclosure:

*Table 23. Enclosures FRU to be exchanged*

Enclosure	FRU
5796, 7314-G30	I/O backplane

- c. Reconnect the mainline ac power cables (from the expansion unit) into the power outlet.
- d. Attempt to power on the system.

Does the expansion unit power on?

- **Yes:** The unit you exchanged was the failing item.

**This ends the procedure.**

- **No:** Repeat this step and exchange the next FRU in the list. If you have exchanged all of the FRUs in the list, ask your next level of support for assistance.

**This ends the procedure.**

12. Is there a reference code displayed on the display panel for the I/O unit that does not power on?
  - **Yes:** Continue with the next step.
  - **No:** Replace the FRU listed in the following table, according to the enclosure:

*Table 24. Enclosures FRU to be exchanged*

Enclosure	FRU
5796, 7314-G30	I/O backplane

**This ends the procedure.**



13. Is the reference code 1xxxxx2E?

- **Yes:** Continue with the next step.
- **No:** Use the new reference code and return to Start of call.

**This ends the procedure.**

14. Do the SPCN optical cables (A) connect the failing unit (B) to the preceding unit in the chain or loop?

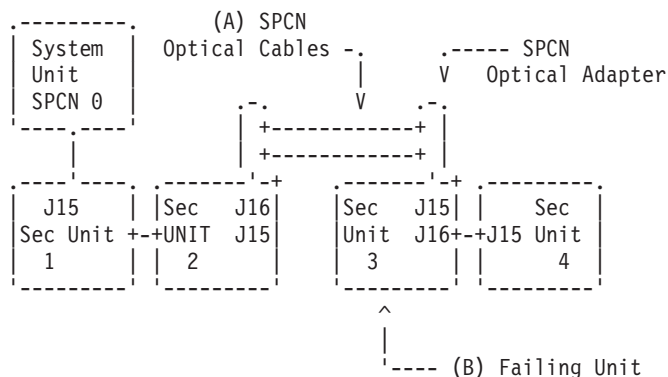

**Yes:** Continue with the next step.

**No:** Go to step 18 on page 158.

15. Remove the SPCN optical adapter (A) from the frame that precedes the frame that cannot become powered on.

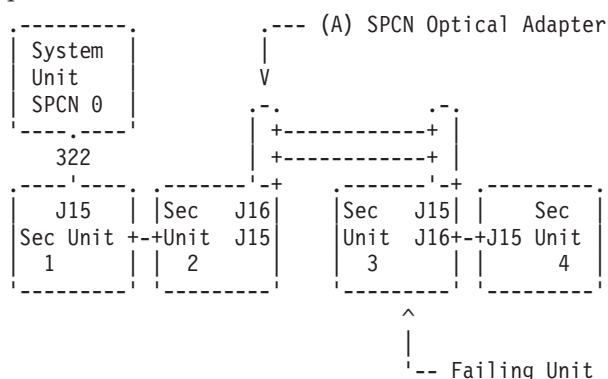

16. Perform the following steps:

**Notes:**

- The cable may be connected to either J15 or J16.
- Use an insulated probe or jumper when performing the voltage readings.
- Connect the negative lead of a multimeter to the system frame ground.
- Connect the positive lead of a multimeter to pin 2 of the connector from which you removed the SPCN optical adapter in the previous step of this procedure.
- Note the voltage reading on pin 2.
- Move the positive lead of the multimeter to pin 3 of the connector or SPCN card.
- Note the voltage reading on pin 3.

Is the voltage on both pin 2 and pin 3 from 1.5 V dc to 5.5 V dc?

- **Yes:** Continue with the next step.
- **No:** Exchange the FRU listed in the following table, according to the enclosure:

Table 25. Enclosures FRU to be exchanged

Enclosure	FRU
5796, 7314-G30	I/O backplane

**This ends the procedure.**

17. Exchange the following FRUs, one at a time:

- a. In the failing unit (first frame with a failure indication), replace the following:

Table 26. Enclosures FRU to be exchanged

Enclosure	FRU
5796, 7314-G30	I/O backplane

- b. In the preceding unit in the string, replace the FRU in Table 26.
- c. SPCN optical adapter (A) in the preceding unit in the string.
- d. SPCN optical adapter (B) in the failing unit.
- e. SPCN optical cables (C) between the preceding unit in the string and the failing unit.

**This ends the procedure.**

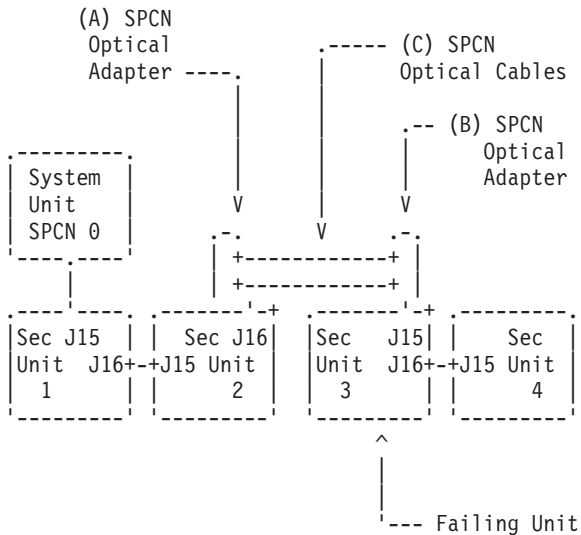

18. Perform the following steps:

- a. Power off the system.
- b. Disconnect the SPCN frame-to-frame cable from the connector of the first unit that cannot be powered on.
- c. Connect the negative lead of a multimeter to the system frame ground.
- d. Connect the positive lead of the multimeter to pin 2 of the SPCN cable.

**Note:** Use an insulated probe or jumper when performing the voltage readings.

- e. Note the voltage reading on pin 2.
- f. Move the positive lead of the multimeter to pin 3 of the SPCN cable.
- g. Note the voltage reading on pin 3.

Is the voltage on both pin 2 and pin 3 from 1.5 V dc to 5.5 V dc?

- **No:** Continue with the next step.
- **Yes:** Exchange the following FRUs one at a time:
  - a. In the failing unit, replace the FRU listed in the following table.

Table 27. Enclosures FRU to be exchanged

Enclosure	FRU
5796, 7314-G30	I/O backplane

- b. In the preceding unit in the string, replace the FRU in Table 27.
- c. SPCN frame-to-frame cable.

**This ends the procedure.**

19. Perform the following steps:

- a. Follow the SPCN frame-to-frame cable back to the preceding unit in the string.
- b. Disconnect the SPCN cable from the connector.
- c. Connect the negative lead of a multimeter to the system frame ground.
- d. Connect the positive lead of a multimeter to pin 2 of the connector.

**Note:** Use an insulated probe or jumper when performing the voltage readings.

- e. Note the voltage reading on pin 2.
- f. Move the positive lead of the multimeter to pin 3 of the connector.
- g. Note the voltage reading on pin 3.

Is the voltage on both pin 2 and pin 3 from 1.5 V dc to 5.5 V dc?

- **Yes:** Exchange the following FRUs one at a time:
  - a. SPCN frame-to-frame cable.
  - b. In the failing unit, replace the following:

Table 28. Enclosures FRU to be exchanged

Enclosure	FRU
5796, 7314-G30	I/O backplane

- c. In the preceding unit in the string, replace the FRU in Table 28.

**This ends the procedure.**

- **No:** Exchange the FRU in Table 28 from the unit from which you disconnected the SPCN cable in the previous step of this procedure.

**This ends the procedure.**

#### Cannot power off system or SPCN-controlled I/O expansion unit:

Use this procedure to analyze a failure of the normal command and control panel procedures to power off the system unit or an SPCN-controlled I/O expansion unit.

**Attention:** To prevent loss of data, ask the customer to verify that no interactive jobs are running before you perform this procedure.

For important safety information before continuing with this procedure, see “Power isolation procedures” on page 153.

1. Is the power off problem on the system unit?
  - No:** Continue with the next step.
  - Yes:** Go to step 3 on page 160.
2. Ensure that the SPCN cables that connect the units are connected and seated correctly at both ends. Does the I/O unit power off, and is the power indicator light blinking slowly?
  - Yes: This ends the procedure.**
  - No:** Go to step 7 on page 160.

3. Attempt to power off the system. Does the system unit power off, and is the power indicator light blinking slowly?
  - No:** Continue with the next step.
  - Yes:** The system is not responding to normal power off procedures which could indicate a Licensed Internal Code problem. Contact your next level of support. **This ends the procedure.**
4. Attempt to power off the system using ASMI. Does the system power off?
  - Yes:** The system is not responding to normal power off procedures which could indicate a Licensed Internal Code problem. Contact your next level of support. **This ends the procedure.**
  - No:** Continue with the next step.
5. Attempt to power off the system using the control panel power button. Does the system power off?
  - Yes:** Continue with the next step.
  - No:** Go to step 10.
6. Is there a reference code logged in the ASMI, the control panel, or the management console that indicates a power problem?
  - Yes:** Perform problem analysis for the reference code in the log. **This ends the procedure.**
  - No:** Contact your next level of support. **This ends the procedure.**
7. Is the I/O expansion unit that will not power off part of a shared I/O tower loop?
  - Yes:** Go to step 9.
  - No:** Continue with the next step.
8. Attempt to power off the I/O expansion unit. Were you able to power off the expansion unit?
  - Yes: This ends the procedure.**
  - No:** Go to step 10.
9. The unit will only power off under certain conditions:
  - If the unit is in private mode, it should power off with the system unit that is connected by the SPCN frame-to-frame cable.
  - If the unit is in switchable mode, it should power off if the "owning" system is powered off or is powering off, and the system unit that is connected by the SPCN frame-to-frame cable is powered off or is powering off.

Does the I/O expansion unit power off?

  - No:** Continue with the next step.
  - Yes: This ends the procedure.**
10. Ensure there are no jobs running on the system or partition, and verify that an uninterruptible power supply (UPS) is not powering the system or I/O expansion unit. Then continue with the next step.
11. Perform the following steps:
  - a. Remove the system or I/O expansion unit ac power cord from the external UPS or, if an external UPS is not installed, from the customer's ac power outlet. If the system or I/O expansion unit has more than one ac line cord, disconnect all the ac line cords.
  - b. Exchange the following FRUs one at a time. See System FRU locations and System parts for information about FRU locations and parts for the system that you are servicing.
    - If the system unit is failing:
      - 1) Power supply (*Un*-E1 or *Un*-E2). Go to step 12 on page 161.
      - 2) For 8233-E8B and 8236-E8C, replace the system backplane (*Un*-P1). For 9117-MMB, 9117-MMC, 9179-MHB, and 9179-MHC, replace the service processor (*Un*-P1-C1). If that does not resolve the problem, replace the midplane (*Un*-P1). For 8202-E4B, 8202-E4C, 8205-E6B, 8205-E6C, 8231-E2B, 8231-E1C, and 8231-E2C systems, exchange the service processor (*Un*-P1).
      - 3) System control panel (*Un*-D1)
    - If an I/O expansion unit is failing:

- 1) Each power supply. Go to step 12.
- 2) I/O backplane
- 3) I/O backplane for the expansion unit that is sequentially configured before the expansion unit that will not power off
- 4) SPCN frame-to-frame cable

**This ends the procedure.**

12. A power supply might be the failing item.

**Attention:** When replacing a redundant power supply, a 1xxx1504, 1xxx1514, 1xxx1524, or 1xxx1534 reference code may be logged in the error log. If you just removed and replaced the power supply in the location associated with this reference code, and the power supply came ready after the install, disregard this reference code. If you had not previously removed and replaced a power supply, the power supply did not come ready after installation, or there are repeated fan fault errors after the power supply replacement, continue to follow these steps.

Is the reference code 1xxx15xx?

**No:** Continue with the next step.

**Yes:** Perform the following steps:

- a. Find the unit reference code in one of the following tables to determine the failing power supply.
- b. Ensure that the power cables are properly connected and seated.
- c. Is the reference code 1xxx1500, 1xxx1510, 1xxx1520, or 1xxx1530 and is the failing unit configured with a redundant power supply option (or dual line cord feature)?
  - **Yes:** Perform “PWR1911” on page 162 before replacing parts.
  - **No:** Continue with step 12d.
- d. See System FRU locations for information about FRU locations for the system that you are servicing.
- e. Replace the failing power supply (see the following tables to determine which power supply to replace).
- f. If the new power supply does not fix the problem, perform the following :
  - 1) Reinstall the original power supply.
  - 2) Try the new power supply in each of the other positions listed in the table.
  - 3) If the problem still is not fixed, reinstall the original power supply and go to the next FRU in the list.
  - 4) For reference codes 1xxx1500, 1xxx1510, 1xxx1520, and 1xxx1530, exchange the power distribution backplane if a problem persists after replacing the power supply.

*Table 29. System Unit*

Unit Reference Code	Power Supply
1510, 1511, 1512, 1513, 1514, 7110	E1
1520, 1521, 1522, 1523, 1524, 7120	E2

**Attention:** For reference codes 1500, 1510, 1520, and 1530, perform “PWR1911” on page 162 before replacing parts.

*Table 30. 7314-G30 expansion unit*

Unit Reference Code	Power Supply
1510, 1511, 1512, 1513, 1514, 1516, 1517	P01/E1
1520, 1521, 1522, 1523, 1524, 1526, 1527	P02/E2

**This ends the procedure.**

13. Is the reference code 1xxx2600, 1xxx2603, 1xxx2605, or 1xxx2606?

- **No:** Continue with the next step.
- **Yes:** Perform the following steps:
  - a. See System FRU locations for information about FRU locations for the system you are servicing.
  - b. Replace the failing power supply.
  - c. Perform the following if the new power supply does not fix the problem:
    - 1) Reinstall the original power supply.
    - 2) Try the new power supply in each of the other positions listed in the table.
    - 3) If the problem still is not fixed, reinstall the original power supply and go to the next FRU in the list.

**Attention:** Do not install power supplies P00 and P01 ac jumper cables on the same ac input module.

*Table 31. Failing power supplies*

System or Feature Code	Failing Power Supply
System unit	Un-E1, Un-E2
7314-G30	E1, E2

**This ends the procedure.**

14. Is the reference code 1xxx8455 or 1xxx8456?
  - **No:** Return to Start of call. **This ends the procedure.**
  - **Yes:** One of the power supplies is missing, and must be installed. Use the following table to determine which power supply is missing, and install the power supply. See System FRU locations for information about FRU locations for the system you are servicing.

*Table 32. Missing power supplies*

Reference Code	Missing Power Supply
1xxx8455	Un-E1
1xxx8456	Un-E2

**This ends the procedure.**

*PWR1911:*

You are here because of a power problem on a dual line cord system. If the failing unit does not have a dual line cord, return to the procedure that sent you here or go to the next item in the FRU list.

The following steps are for the system unit, unless other instructions are given. For important safety information before servicing the system, see "Power isolation procedures" on page 153.

1. If an uninterruptible power supply is installed, verify that it is powered on before proceeding.
2. Are all the units powered on?

**Note:** In an 8233-E8B or 8236-E8C system, there are two internal ac power cables that run from the back of the drawer to the power supplies in the front. The upper ac power connector on the back of the system goes to power supply E1. The lower ac power connector on the back of the system goes to power supply E2.

- **Yes:** Go to step 7 on page 164.
- **No:** On the unit that does not power on, perform the following steps:
  - a. Disconnect the ac line cords from the unit that does not power on.
  - b. Use a multimeter to measure the ac voltage at the system end of both ac line cords.

Table 33. Correct ac voltage

Model or expansion unit	Correct ac voltage
8202-E4B, 8202-E4C, 8205-E6B, 8205-E6C, 8231-E2B, 8231-E1C, 8231-E2C, 8233-E8B, and 8236-E8C system units	100 V to 127 V or 200 V to 240 V
9117-MMB, 9117-MMC, 9179-MHB, and 9179-MHC system units, 5796 and 7314-G30 expansion units	200 V to 240 V
5802 expansion unit	90 V to 259 V

c. Is the voltage correct (see Table 33)?

**Yes:** Continue with the next step.

**No:** Go to step 6 on page 164.

3. Are you working on a system 8202-E4B, 8202-E4C, 8205-E6B, 8205-E6C, 8231-E2B, 8231-E1C, 8231-E2C, 8233-E8B, 8236-E8C, 9117-MMB, 9117-MMC, 9179-MHB, 9179-MHC or a 5796, 7314-G30 expansion unit?

- **No:** Continue with the next step.
- **Yes:** Perform the following steps:
  - a. Reconnect the ac line cords.
  - b. Verify that the failing unit fails to power on.
  - c. Replace the failing power supply. Use the table below to determine which power supply needs replacing, and then see System FRU locations for its location, part number, and exchange procedure.

Table 34. Failing power supply for 8202-E4B, 8202-E4C, 8205-E6B, 8205-E6C, 8231-E2B, 8231-E1C, 8231-E2C, 8233-E8B, 8236-E8C, 9117-MMB, 9117-MMC, 9179-MHB, 9179-MHC or 5796, 5802, 5877, 7314-G30 expansion units

Reference code	Models or expansion units	Failing item name
1510	8202-E4B, 8202-E4C, 8205-E6B, 8205-E6C, 8231-E2B, 8231-E1C, 8231-E2C, 8233-E8B, 8236-E8C, 9117-MMB, 9117-MMC, 9179-MHB, 9179-MHC	Power supply 1
	5796, 5802, 5877, 7314-G30	Power supply 1
1520	8202-E4B, 8202-E4C, 8205-E6B, 8205-E6C, 8231-E2B, 8231-E1C, 8231-E2C, 8233-E8B, 8236-E8C, 9117-MMB, 9117-MMC, 9179-MHB, 9179-MHC	Power supply 2
	5796, 5802, 5877, 7314-G30	Power supply 2

**This ends the procedure.**

4. Perform the following steps:
- a. Reconnect the ac line cord to the ac modules.
  - b. Remove the ac jumper cables at the power supplies.
  - c. Use a multimeter to measure the ac voltage at the power-supply end of the jumper cable.

Is the ac voltage from 200 V to 240 V?

- **No:** Continue with the next step.
- **Yes:** Replace the failing power supply. See System FRU locations for its location, part number, and exchange procedure.

**Attention:** Do not install power supplies P00 and P01 ac jumper cables on the same ac module.

**This ends the procedure.**

5. Perform the following steps:
  - a. Disconnect the ac jumper cable at the ac module output.
  - b. Use a multimeter to measure the ac voltage at the ac module output.  
Is the ac voltage from 200 V to 240 V?
    - **Yes:** Exchange the ac jumper cable.  
**This ends the procedure.**
    - **No:** Exchange the ac module. See System FRU locations for FRU location information for the system that you are servicing.  
**This ends the procedure.**
6. Perform the following steps:
  - a. Disconnect the ac line cords from the customer's ac power outlet.
  - b. Use a multimeter to measure the ac voltage at the customer's ac power outlet.  
Is the ac voltage correct (see Table 33 on page 163)?
    - **Yes:** Exchange the failing ac line cord.  
**This ends the procedure.**
    - **No:** Perform the following steps:
      - a. Inform the customer that the ac voltage at the power outlet is not correct.
      - b. Reconnect the ac line cords to the power outlet after the ac voltage at the power outlet is correct.  
**This ends the procedure.**
7. Is the reference code 1xxx00AC?
  - **No:** Continue with the next step.
  - **Yes:** This reference code may have been caused by an ac outage. If the system will power on without an error, no parts need to be replaced.  
**This ends the procedure.**
8. Is the reference code 1xxx1510 or 1520?
  - **No:** Continue with the next step.
  - **Yes:** Perform the following steps:
    - a. Use the following table, figures and location codes to locate the failing parts. See System FRU locations for information about FRU location for the system that you are servicing.

Table 35. Power reference code table

Model or expansion unit	Reference code	Locate these parts
8202-E4B, 8202-E4C, 8205-E6B, 8205-E6C, 8231-E2B, 8231-E1C, 8231-E2C, 8233-E8B, 8236-E8C, 9117-MMB, 9117-MMC, 9179-MHB, 9179-MHC	1xxx 1510	Power supply E1 and ac line cord 1
	1xxx 1520	Power supply E2 and ac line cord 2
5796, 5802, 5877, 7314-G30	1xxx 1510	Power supply 1 and ac line cord 1
	1xxx 1520	Power supply 2 and ac line cord 2

- b. Locate the ac line cord or the ac jumper cable for the reference code you are working on.
  - c. Go to step 10 on page 165.
9. Is the reference code 1xxx 1500 or 1xxx 1530?
  - **No:** Perform Problem Analysis using the reference code.  
**This ends the procedure.**



- **Yes:** Locate the ac jumper cables for the reference code you are working on (see Table 35 on page 164), and then continue with the next step:
  - If the reference code is 1xxx 1500, determine the locations of ac jumper cables that connect to power supply P00 (see the preceding figures).
  - If the reference code is 1xxx 1530, determine the locations of ac jumper cables that connect to power supply P03 (see the preceding figures).

10. Perform the following steps:

**Attention:** Do not disconnect the other system line cord or the other ac jumper cable when powered on.

- a. For the reference code you are working on, disconnect either the ac jumper cable or the ac line cord from the power supply.
- b. Use a multimeter to measure the ac voltage at the power supply end of the ac jumper cable **or** the ac line cord.

Is the ac voltage correct (see Table 33 on page 163)?

**No:** Continue with the next step.

**Yes:** Exchange the failing power supply. See Table 34 on page 163 for its position, and then see System FRU locations for part numbers and directions to the correct exchange procedures. **This ends the procedure.**

11. Perform the following steps:

- a. Disconnect the ac line cords from the power outlet.
- b. Use a multimeter to measure the ac voltage at the customer's ac power outlet.

Is the ac voltage correct (see Table 33 on page 163)?

- **Yes:** Exchange the following, one at a time:
  - Failing ac line cord
  - Failing ac jumper cable (if installed)
  - Failing ac module (if installed) (see System FRU locations for part numbers and directions to the correct exchange procedures)

**This ends the procedure.**

- **No:** Perform the following steps:
  - a. Inform the customer that the ac voltage at the power outlet is not correct.
  - b. Reconnect the ac line cords to the power outlet after the ac voltage at the power outlet is correct.

**This ends the procedure.**



---

## Notices

This information was developed for products and services offered in the U.S.A.

The manufacturer may not offer the products, services, or features discussed in this document in other countries. Consult the manufacturer's representative for information on the products and services currently available in your area. Any reference to the manufacturer's product, program, or service is not intended to state or imply that only that product, program, or service may be used. Any functionally equivalent product, program, or service that does not infringe any intellectual property right of the manufacturer may be used instead. However, it is the user's responsibility to evaluate and verify the operation of any product, program, or service.

The manufacturer may have patents or pending patent applications covering subject matter described in this document. The furnishing of this document does not grant you any license to these patents. You can send license inquiries, in writing, to the manufacturer.

**The following paragraph does not apply to the United Kingdom or any other country where such provisions are inconsistent with local law:** THIS INFORMATION IS PROVIDED "AS IS" WITHOUT WARRANTY OF ANY KIND, EITHER EXPRESS OR IMPLIED, INCLUDING, BUT NOT LIMITED TO, THE IMPLIED WARRANTIES OF NON-INFRINGEMENT, MERCHANTABILITY OR FITNESS FOR A PARTICULAR PURPOSE. Some states do not allow disclaimer of express or implied warranties in certain transactions, therefore, this statement may not apply to you.

This information could include technical inaccuracies or typographical errors. Changes are periodically made to the information herein; these changes will be incorporated in new editions of the publication. The manufacturer may make improvements and/or changes in the product(s) and/or the program(s) described in this publication at any time without notice.

Any references in this information to websites not owned by the manufacturer are provided for convenience only and do not in any manner serve as an endorsement of those websites. The materials at those websites are not part of the materials for this product and use of those websites is at your own risk.

The manufacturer may use or distribute any of the information you supply in any way it believes appropriate without incurring any obligation to you.

Any performance data contained herein was determined in a controlled environment. Therefore, the results obtained in other operating environments may vary significantly. Some measurements may have been made on development-level systems and there is no guarantee that these measurements will be the same on generally available systems. Furthermore, some measurements may have been estimated through extrapolation. Actual results may vary. Users of this document should verify the applicable data for their specific environment.

Information concerning products not produced by this manufacturer was obtained from the suppliers of those products, their published announcements or other publicly available sources. This manufacturer has not tested those products and cannot confirm the accuracy of performance, compatibility or any other claims related to products not produced by this manufacturer. Questions on the capabilities of products not produced by this manufacturer should be addressed to the suppliers of those products.

All statements regarding the manufacturer's future direction or intent are subject to change or withdrawal without notice, and represent goals and objectives only.

The manufacturer's prices shown are the manufacturer's suggested retail prices, are current and are subject to change without notice. Dealer prices may vary.

This information is for planning purposes only. The information herein is subject to change before the products described become available.

This information contains examples of data and reports used in daily business operations. To illustrate them as completely as possible, the examples include the names of individuals, companies, brands, and products. All of these names are fictitious and any similarity to the names and addresses used by an actual business enterprise is entirely coincidental.

If you are viewing this information in softcopy, the photographs and color illustrations may not appear.

The drawings and specifications contained herein shall not be reproduced in whole or in part without the written permission of the manufacturer.

The manufacturer has prepared this information for use with the specific machines indicated. The manufacturer makes no representations that it is suitable for any other purpose.

The manufacturer's computer systems contain mechanisms designed to reduce the possibility of undetected data corruption or loss. This risk, however, cannot be eliminated. Users who experience unplanned outages, system failures, power fluctuations or outages, or component failures must verify the accuracy of operations performed and data saved or transmitted by the system at or near the time of the outage or failure. In addition, users must establish procedures to ensure that there is independent data verification before relying on such data in sensitive or critical operations. Users should periodically check the manufacturer's support websites for updated information and fixes applicable to the system and related software.

### **Ethernet connection usage restriction**

This product is not intended to be connected directly or indirectly by any means whatsoever to interfaces of public telecommunications networks.

---

## **Trademarks**

IBM, the IBM logo, and [ibm.com](http://ibm.com) are trademarks or registered trademarks of International Business Machines Corp., registered in many jurisdictions worldwide. Other product and service names might be trademarks of IBM or other companies. A current list of IBM trademarks is available on the Web at Copyright and trademark information at [www.ibm.com/legal/copytrade.shtml](http://www.ibm.com/legal/copytrade.shtml).

INFINIBAND, InfiniBand Trade Association, and the INFINIBAND design marks are trademarks and/or service marks of the INFINIBAND Trade Association.

Linux is a registered trademark of Linus Torvalds in the United States, other countries, or both.

Other product and service names might be trademarks of IBM or other companies.

---

## **Electronic emission notices**

When attaching a monitor to the equipment, you must use the designated monitor cable and any interference suppression devices supplied with the monitor.

## **Class A Notices**

The following Class A statements apply to the IBM servers that contain the POWER7<sup>®</sup> processor and its features unless designated as electromagnetic compatibility (EMC) Class B in the feature information.

## **Federal Communications Commission (FCC) statement**

**Note:** This equipment has been tested and found to comply with the limits for a Class A digital device, pursuant to Part 15 of the FCC Rules. These limits are designed to provide reasonable protection against harmful interference when the equipment is operated in a commercial environment. This equipment generates, uses, and can radiate radio frequency energy and, if not installed and used in accordance with the instruction manual, may cause harmful interference to radio communications. Operation of this equipment in a residential area is likely to cause harmful interference, in which case the user will be required to correct the interference at his own expense.

Properly shielded and grounded cables and connectors must be used in order to meet FCC emission limits. IBM is not responsible for any radio or television interference caused by using other than recommended cables and connectors or by unauthorized changes or modifications to this equipment. Unauthorized changes or modifications could void the user's authority to operate the equipment.

This device complies with Part 15 of the FCC rules. Operation is subject to the following two conditions: (1) this device may not cause harmful interference, and (2) this device must accept any interference received, including interference that may cause undesired operation.

## **Industry Canada Compliance Statement**

This Class A digital apparatus complies with Canadian ICES-003.

## **Avis de conformité à la réglementation d'Industrie Canada**

Cet appareil numérique de la classe A est conforme à la norme NMB-003 du Canada.

## **European Community Compliance Statement**

This product is in conformity with the protection requirements of EU Council Directive 2004/108/EC on the approximation of the laws of the Member States relating to electromagnetic compatibility. IBM cannot accept responsibility for any failure to satisfy the protection requirements resulting from a non-recommended modification of the product, including the fitting of non-IBM option cards.

This product has been tested and found to comply with the limits for Class A Information Technology Equipment according to European Standard EN 55022. The limits for Class A equipment were derived for commercial and industrial environments to provide reasonable protection against interference with licensed communication equipment.

European Community contact:  
IBM Deutschland GmbH  
Technical Regulations, Department M456  
IBM-Allee 1, 71139 Ehningen, Germany  
Tele: +49 7032 15-2937  
email: tjahn@de.ibm.com

**Warning:** This is a Class A product. In a domestic environment, this product may cause radio interference, in which case the user may be required to take adequate measures.

## VCCI Statement - Japan

この装置は、クラスA 情報技術装置です。この装置を家庭環境で使用すると電波妨害を引き起こすことがあります。この場合には使用者が適切な対策を講ずるよう要求されることがあります。

VCCI-A

The following is a summary of the VCCI Japanese statement in the box above:

This is a Class A product based on the standard of the VCCI Council. If this equipment is used in a domestic environment, radio interference may occur, in which case, the user may be required to take corrective actions.

### Japanese Electronics and Information Technology Industries Association (JEITA) Confirmed Harmonics Guideline (products less than or equal to 20 A per phase)

高調波ガイドライン適合品

### Japanese Electronics and Information Technology Industries Association (JEITA) Confirmed Harmonics Guideline with Modifications (products greater than 20 A per phase)

高調波ガイドライン準用品

## Electromagnetic Interference (EMI) Statement - People's Republic of China

### 声 明

此为 A 级产品, 在生活环境中, 该产品可能会造成无线电干扰。在这种情况下, 可能需要用户对其干扰采取切实可行的措施。

Declaration: This is a Class A product. In a domestic environment this product may cause radio interference in which case the user may need to perform practical action.

## Electromagnetic Interference (EMI) Statement - Taiwan

警告使用者：  
這是甲類的資訊產品，在居住的環境中使用時，可能會造成射頻干擾，在這種情況下，使用者會被要求採取某些適當的對策。

The following is a summary of the EMI Taiwan statement above.

Warning: This is a Class A product. In a domestic environment this product may cause radio interference in which case the user will be required to take adequate measures.

### IBM Taiwan Contact Information:

台灣IBM 產品服務聯絡方式：  
台灣國際商業機器股份有限公司  
台北市松仁路7號3樓  
電話：0800-016-888

## Electromagnetic Interference (EMI) Statement - Korea

이 기기는 업무용(A급)으로 전자파적합기기로서 판매자 또는 사용자는 이 점을 주의하시기 바라며, 가정외의 지역에서 사용하는 것을 목적으로 합니다.

## Germany Compliance Statement

### Deutschsprachiger EU Hinweis: Hinweis für Geräte der Klasse A EU-Richtlinie zur Elektromagnetischen Verträglichkeit

Dieses Produkt entspricht den Schutzanforderungen der EU-Richtlinie 2004/108/EG zur Angleichung der Rechtsvorschriften über die elektromagnetische Verträglichkeit in den EU-Mitgliedsstaaten und hält die Grenzwerte der EN 55022 Klasse A ein.

Um dieses sicherzustellen, sind die Geräte wie in den Handbüchern beschrieben zu installieren und zu betreiben. Des Weiteren dürfen auch nur von der IBM empfohlene Kabel angeschlossen werden. IBM übernimmt keine Verantwortung für die Einhaltung der Schutzanforderungen, wenn das Produkt ohne Zustimmung von IBM verändert bzw. wenn Erweiterungskomponenten von Fremdherstellern ohne Empfehlung von IBM gesteckt/eingebaut werden.

EN 55022 Klasse A Geräte müssen mit folgendem Warnhinweis versehen werden:  
"Warnung: Dieses ist eine Einrichtung der Klasse A. Diese Einrichtung kann im Wohnbereich Funk-Störungen verursachen; in diesem Fall kann vom Betreiber verlangt werden, angemessene Maßnahmen zu ergreifen und dafür aufzukommen."

#### **Deutschland: Einhaltung des Gesetzes über die elektromagnetische Verträglichkeit von Geräten**

Dieses Produkt entspricht dem "Gesetz über die elektromagnetische Verträglichkeit von Geräten (EMVG)". Dies ist die Umsetzung der EU-Richtlinie 2004/108/EG in der Bundesrepublik Deutschland.

#### **Zulassungsbescheinigung laut dem Deutschen Gesetz über die elektromagnetische Verträglichkeit von Geräten (EMVG) (bzw. der EMC EG Richtlinie 2004/108/EG) für Geräte der Klasse A**

Dieses Gerät ist berechtigt, in Übereinstimmung mit dem Deutschen EMVG das EG-Konformitätszeichen - CE - zu führen.

Verantwortlich für die Einhaltung der EMV Vorschriften ist der Hersteller:  
International Business Machines Corp.  
New Orchard Road  
Armonk, New York 10504  
Tel: 914-499-1900

Der verantwortliche Ansprechpartner des Herstellers in der EU ist:  
IBM Deutschland GmbH  
Technical Regulations, Abteilung M456  
IBM-Allee 1, 71139 Ehningen, Germany  
Tel: +49 7032 15-2937  
email: tjahn@de.ibm.com

Generelle Informationen:

Das Gerät erfüllt die Schutzanforderungen nach EN 55024 und EN 55022 Klasse A.

#### **Electromagnetic Interference (EMI) Statement - Russia**

**ВНИМАНИЕ!** Настоящее изделие относится к классу А.  
В жилых помещениях оно может создавать радиопомехи, для снижения которых необходимы дополнительные меры

#### **Class B Notices**

The following Class B statements apply to features designated as electromagnetic compatibility (EMC) Class B in the feature installation information.

#### **Federal Communications Commission (FCC) statement**

This equipment has been tested and found to comply with the limits for a Class B digital device, pursuant to Part 15 of the FCC Rules. These limits are designed to provide reasonable protection against harmful interference in a residential installation.



This equipment generates, uses, and can radiate radio frequency energy and, if not installed and used in accordance with the instructions, may cause harmful interference to radio communications. However, there is no guarantee that interference will not occur in a particular installation.

If this equipment does cause harmful interference to radio or television reception, which can be determined by turning the equipment off and on, the user is encouraged to try to correct the interference by one or more of the following measures:

- Reorient or relocate the receiving antenna.
- Increase the separation between the equipment and receiver.
- Connect the equipment into an outlet on a circuit different from that to which the receiver is connected.
- Consult an IBM-authorized dealer or service representative for help.

Properly shielded and grounded cables and connectors must be used in order to meet FCC emission limits. Proper cables and connectors are available from IBM-authorized dealers. IBM is not responsible for any radio or television interference caused by unauthorized changes or modifications to this equipment. Unauthorized changes or modifications could void the user's authority to operate this equipment.

This device complies with Part 15 of the FCC rules. Operation is subject to the following two conditions: (1) this device may not cause harmful interference, and (2) this device must accept any interference received, including interference that may cause undesired operation.

### **Industry Canada Compliance Statement**

This Class B digital apparatus complies with Canadian ICES-003.

### **Avis de conformité à la réglementation d'Industrie Canada**

Cet appareil numérique de la classe B est conforme à la norme NMB-003 du Canada.

### **European Community Compliance Statement**

This product is in conformity with the protection requirements of EU Council Directive 2004/108/EC on the approximation of the laws of the Member States relating to electromagnetic compatibility. IBM cannot accept responsibility for any failure to satisfy the protection requirements resulting from a non-recommended modification of the product, including the fitting of non-IBM option cards.

This product has been tested and found to comply with the limits for Class B Information Technology Equipment according to European Standard EN 55022. The limits for Class B equipment were derived for typical residential environments to provide reasonable protection against interference with licensed communication equipment.

European Community contact:  
IBM Deutschland GmbH  
Technical Regulations, Department M456  
IBM-Allee 1, 71139 Ehningen, Germany  
Tele: +49 7032 15-2937  
email: tjahn@de.ibm.com

## VCCI Statement - Japan

この装置は、クラスB情報技術装置です。この装置は、家庭環境で使用することを目的としていますが、この装置がラジオやテレビジョン受信機に近接して使用されると、受信障害を引き起こすことがあります。

取扱説明書に従って正しい取り扱いをして下さい。 VCCI-B

## Japanese Electronics and Information Technology Industries Association (JEITA) Confirmed Harmonics Guideline (products less than or equal to 20 A per phase)

高調波ガイドライン適合品

## Japanese Electronics and Information Technology Industries Association (JEITA) Confirmed Harmonics Guideline with Modifications (products greater than 20 A per phase)

高調波ガイドライン準用品

## IBM Taiwan Contact Information

台灣IBM 產品服務聯絡方式：  
台灣國際商業機器股份有限公司  
台北市松仁路7號3樓  
電話：0800-016-888

## Electromagnetic Interference (EMI) Statement - Korea

이 기기는 가정용(B급)으로 전자파적합기기로서 주로 가정에서 사용하는 것을 목적으로 하며, 모든 지역에서 사용할 수 있습니다.

## Germany Compliance Statement

Deutschsprachiger EU Hinweis: Hinweis für Geräte der Klasse B EU-Richtlinie zur Elektromagnetischen Verträglichkeit

Dieses Produkt entspricht den Schutzanforderungen der EU-Richtlinie 2004/108/EG zur Angleichung der Rechtsvorschriften über die elektromagnetische Verträglichkeit in den EU-Mitgliedsstaaten und hält die Grenzwerte der EN 55022 Klasse B ein.

Um dieses sicherzustellen, sind die Geräte wie in den Handbüchern beschrieben zu installieren und zu betreiben. Des Weiteren dürfen auch nur von der IBM empfohlene Kabel angeschlossen werden. IBM übernimmt keine Verantwortung für die Einhaltung der Schutzanforderungen, wenn das Produkt ohne Zustimmung von IBM verändert bzw. wenn Erweiterungskomponenten von Fremdherstellern ohne Empfehlung von IBM gesteckt/eingebaut werden.

#### **Deutschland: Einhaltung des Gesetzes über die elektromagnetische Verträglichkeit von Geräten**

Dieses Produkt entspricht dem "Gesetz über die elektromagnetische Verträglichkeit von Geräten (EMVG)". Dies ist die Umsetzung der EU-Richtlinie 2004/108/EG in der Bundesrepublik Deutschland.

#### **Zulassungsbescheinigung laut dem Deutschen Gesetz über die elektromagnetische Verträglichkeit von Geräten (EMVG) (bzw. der EMC EG Richtlinie 2004/108/EG) für Geräte der Klasse B**

Dieses Gerät ist berechtigt, in Übereinstimmung mit dem Deutschen EMVG das EG-Konformitätszeichen - CE - zu führen.

Verantwortlich für die Einhaltung der EMV Vorschriften ist der Hersteller:  
International Business Machines Corp.  
New Orchard Road  
Armonk, New York 10504  
Tel: 914-499-1900

Der verantwortliche Ansprechpartner des Herstellers in der EU ist:  
IBM Deutschland GmbH  
Technical Regulations, Abteilung M456  
IBM-Allee 1, 71139 Ehningen, Germany  
Tel: +49 7032 15-2937  
email: tjahn@de.ibm.com

Generelle Informationen:

**Das Gerät erfüllt die Schutzanforderungen nach EN 55024 und EN 55022 Klasse B.**

---

## **Terms and conditions**

Permissions for the use of these publications is granted subject to the following terms and conditions.

**Personal Use:** You may reproduce these publications for your personal, noncommercial use provided that all proprietary notices are preserved. You may not distribute, display or make derivative works of these publications, or any portion thereof, without the express consent of the manufacturer.

**Commercial Use:** You may reproduce, distribute and display these publications solely within your enterprise provided that all proprietary notices are preserved. You may not make derivative works of these publications, or reproduce, distribute or display these publications or any portion thereof outside your enterprise, without the express consent of the manufacturer.

Except as expressly granted in this permission, no other permissions, licenses or rights are granted, either express or implied, to the publications or any information, data, software or other intellectual property contained therein.

The manufacturer reserves the right to withdraw the permissions granted herein whenever, in its discretion, the use of the publications is detrimental to its interest or, as determined by the manufacturer, the above instructions are not being properly followed.

You may not download, export or re-export this information except in full compliance with all applicable laws and regulations, including all United States export laws and regulations.

THE MANUFACTURER MAKES NO GUARANTEE ABOUT THE CONTENT OF THESE PUBLICATIONS. THESE PUBLICATIONS ARE PROVIDED "AS-IS" AND WITHOUT WARRANTY OF ANY KIND, EITHER EXPRESSED OR IMPLIED, INCLUDING BUT NOT LIMITED TO IMPLIED WARRANTIES OF MERCHANTABILITY, NON-INFRINGEMENT, AND FITNESS FOR A PARTICULAR PURPOSE.