

SAS subsystem for the E2-705, E2-705T,
E4-705 or E4-705T

ESCALA Power7



REFERENCE
86 A1 99FG 03

SAS subsystem for the E2-705, E2-705T, E4-705 or E4-705T

The ESCALA Power7 publications concern the following models:

- Bull Escala E1-700 (Power 710 / 8231-E2B)
- Bull Escala E1-705 (Power 710 / 8231-E1C)
- Bull Escala E2-700 / E2-700T (Power 720 / 8202-E4B)
- Bull Escala E2-705 / E2-705T (Power 720 / 8202-E4C)
- Bull Escala E3-700 (Power 730 / 8231-E2B)
- Bull Escala E3-705 (Power 730 / 8231-E2C)
- Bull Escala E4-700 / E4-700T (Power 740 / 8205-E6B)
- Bull Escala E4-705 (Power 740 / 8205-E6C)
- Bull Escala E5-700 (Power 750 / 8233-E8B)
- Bull Escala M6-700 (Power 770 / 9117-MMB)
- Bull Escala M6-705 (Power 770 / 9117-MMC)
- Bull Escala M6-715 (Power 770 / 9117-MMD)
- Bull Escala M7-700 (Power 780 / 9179-MHB)
- Bull Escala M7-705 (Power 780 / 9179-MHC)
- Bull Escala M7-715 (Power 780 / 9179-MHD)

References to Power 755 / 8236-E8C models are irrelevant.

Hardware

November 2012

BULL CEDOC
357 AVENUE PATTON
B.P.20845
49008 ANGERS CEDEX 01
FRANCE

REFERENCE
86 A1 99FG 03

The following copyright notice protects this book under Copyright laws which prohibit such actions as, but not limited to, copying, distributing, modifying, and making derivative works.

Copyright © Bull SAS 2012

Printed in France

Trademarks and Acknowledgements

We acknowledge the rights of the proprietors of the trademarks mentioned in this manual.

All brand names and software and hardware product names are subject to trademark and/or patent protection.

Quoting of brand and product names is for information purposes only and does not represent trademark misuse.

The information in this document is subject to change without notice. Bull will not be liable for errors contained herein, or for incidental or consequential damages in connection with the use of this material.

Contents

Safety notices	v
SAS subsystem for the 02E/4C or 05E/6C	1
SAS architecture	1
02E/4C or 05E/6C SAS subsystem overview	1
SAS storage configurations	5
02E/4C or 05E/6C SAS subsystem base configuration	6
02E/4C or 05E/6C SAS base subsystem with two-way split drive backplane	7
02E/4C or 05E/6C SAS dual-RAID subsystem	9
02E/4C or 05E/6C SAS dual-RAID subsystem with internal drives	9
02E/4C or 05E/6C SAS dual-RAID subsystem with external drives.	10
02E/4C or 05E/6C SAS subsystem service considerations	13
Service considerations for the cache battery pack	13
Problem determination and recovery	15
Notices	17
Trademarks	18
Electronic emission notices	18
Class A Notices	18
Class B Notices	22
Terms and conditions	24

Safety notices

Safety notices may be printed throughout this guide:

- **DANGER** notices call attention to a situation that is potentially lethal or extremely hazardous to people.
- **CAUTION** notices call attention to a situation that is potentially hazardous to people because of some existing condition.
- **Attention** notices call attention to the possibility of damage to a program, device, system, or data.

World Trade safety information

Several countries require the safety information contained in product publications to be presented in their national languages. If this requirement applies to your country, a safety information booklet is included in the publications package shipped with the product. The booklet contains the safety information in your national language with references to the U.S. English source. Before using a U.S. English publication to install, operate, or service this product, you must first become familiar with the related safety information in the booklet. You should also refer to the booklet any time you do not clearly understand any safety information in the U.S. English publications.

German safety information

Das Produkt ist nicht für den Einsatz an Bildschirmarbeitsplätzen im Sinne § 2 der Bildschirmarbeitsverordnung geeignet.

Laser safety information

IBM® servers can use I/O cards or features that are fiber-optic based and that utilize lasers or LEDs.

Laser compliance

IBM servers may be installed inside or outside of an IT equipment rack.

DANGER

When working on or around the system, observe the following precautions:

Electrical voltage and current from power, telephone, and communication cables are hazardous. To avoid a shock hazard:

- Connect power to this unit only with the provided power cord. Do not use the provided power cord for any other product.
- Do not open or service any power supply assembly.
- Do not connect or disconnect any cables or perform installation, maintenance, or reconfiguration of this product during an electrical storm.
- The product might be equipped with multiple power cords. To remove all hazardous voltages, disconnect all power cords.
- Connect all power cords to a properly wired and grounded electrical outlet. Ensure that the outlet supplies proper voltage and phase rotation according to the system rating plate.
- Connect any equipment that will be attached to this product to properly wired outlets.
- When possible, use one hand only to connect or disconnect signal cables.
- Never turn on any equipment when there is evidence of fire, water, or structural damage.
- Disconnect the attached power cords, telecommunications systems, networks, and modems before you open the device covers, unless instructed otherwise in the installation and configuration procedures.
- Connect and disconnect cables as described in the following procedures when installing, moving, or opening covers on this product or attached devices.

To Disconnect:

1. Turn off everything (unless instructed otherwise).
2. Remove the power cords from the outlets.
3. Remove the signal cables from the connectors.
4. Remove all cables from the devices

To Connect:

1. Turn off everything (unless instructed otherwise).
2. Attach all cables to the devices.
3. Attach the signal cables to the connectors.
4. Attach the power cords to the outlets.
5. Turn on the devices.

(D005a)

DANGER

Observe the following precautions when working on or around your IT rack system:

- Heavy equipment—personal injury or equipment damage might result if mishandled.
- Always lower the leveling pads on the rack cabinet.
- Always install stabilizer brackets on the rack cabinet.
- To avoid hazardous conditions due to uneven mechanical loading, always install the heaviest devices in the bottom of the rack cabinet. Always install servers and optional devices starting from the bottom of the rack cabinet.
- Rack-mounted devices are not to be used as shelves or work spaces. Do not place objects on top of rack-mounted devices.



- Each rack cabinet might have more than one power cord. Be sure to disconnect all power cords in the rack cabinet when directed to disconnect power during servicing.
- Connect all devices installed in a rack cabinet to power devices installed in the same rack cabinet. Do not plug a power cord from a device installed in one rack cabinet into a power device installed in a different rack cabinet.
- An electrical outlet that is not correctly wired could place hazardous voltage on the metal parts of the system or the devices that attach to the system. It is the responsibility of the customer to ensure that the outlet is correctly wired and grounded to prevent an electrical shock.

CAUTION

- Do not install a unit in a rack where the internal rack ambient temperatures will exceed the manufacturer's recommended ambient temperature for all your rack-mounted devices.
- Do not install a unit in a rack where the air flow is compromised. Ensure that air flow is not blocked or reduced on any side, front, or back of a unit used for air flow through the unit.
- Consideration should be given to the connection of the equipment to the supply circuit so that overloading of the circuits does not compromise the supply wiring or overcurrent protection. To provide the correct power connection to a rack, refer to the rating labels located on the equipment in the rack to determine the total power requirement of the supply circuit.
- *(For sliding drawers.)* Do not pull out or install any drawer or feature if the rack stabilizer brackets are not attached to the rack. Do not pull out more than one drawer at a time. The rack might become unstable if you pull out more than one drawer at a time.
- *(For fixed drawers.)* This drawer is a fixed drawer and must not be moved for servicing unless specified by the manufacturer. Attempting to move the drawer partially or completely out of the rack might cause the rack to become unstable or cause the drawer to fall out of the rack.

(R001)

CAUTION:

Removing components from the upper positions in the rack cabinet improves rack stability during relocation. Follow these general guidelines whenever you relocate a populated rack cabinet within a room or building:

- Reduce the weight of the rack cabinet by removing equipment starting at the top of the rack cabinet. When possible, restore the rack cabinet to the configuration of the rack cabinet as you received it. If this configuration is not known, you must observe the following precautions:
 - Remove all devices in the 32U position and above.
 - Ensure that the heaviest devices are installed in the bottom of the rack cabinet.
 - Ensure that there are no empty U-levels between devices installed in the rack cabinet below the 32U level.
- If the rack cabinet you are relocating is part of a suite of rack cabinets, detach the rack cabinet from the suite.
- Inspect the route that you plan to take to eliminate potential hazards.
- Verify that the route that you choose can support the weight of the loaded rack cabinet. Refer to the documentation that comes with your rack cabinet for the weight of a loaded rack cabinet.
- Verify that all door openings are at least 760 x 230 mm (30 x 80 in.).
- Ensure that all devices, shelves, drawers, doors, and cables are secure.
- Ensure that the four leveling pads are raised to their highest position.
- Ensure that there is no stabilizer bracket installed on the rack cabinet during movement.
- Do not use a ramp inclined at more than 10 degrees.
- When the rack cabinet is in the new location, complete the following steps:
 - Lower the four leveling pads.
 - Install stabilizer brackets on the rack cabinet.
 - If you removed any devices from the rack cabinet, repopulate the rack cabinet from the lowest position to the highest position.
- If a long-distance relocation is required, restore the rack cabinet to the configuration of the rack cabinet as you received it. Pack the rack cabinet in the original packaging material, or equivalent. Also lower the leveling pads to raise the casters off of the pallet and bolt the rack cabinet to the pallet.

(R002)

(L001)



(L002)



(L003)



or



All lasers are certified in the U.S. to conform to the requirements of DHHS 21 CFR Subchapter J for class 1 laser products. Outside the U.S., they are certified to be in compliance with IEC 60825 as a class 1 laser product. Consult the label on each part for laser certification numbers and approval information.

CAUTION:

This product might contain one or more of the following devices: CD-ROM drive, DVD-ROM drive, DVD-RAM drive, or laser module, which are Class 1 laser products. Note the following information:

- Do not remove the covers. Removing the covers of the laser product could result in exposure to hazardous laser radiation. There are no serviceable parts inside the device.
- Use of the controls or adjustments or performance of procedures other than those specified herein might result in hazardous radiation exposure.

(C026)

CAUTION:

Data processing environments can contain equipment transmitting on system links with laser modules that operate at greater than Class 1 power levels. For this reason, never look into the end of an optical fiber cable or open receptacle. (C027)

CAUTION:

This product contains a Class 1M laser. Do not view directly with optical instruments. (C028)

CAUTION:

Some laser products contain an embedded Class 3A or Class 3B laser diode. Note the following information: laser radiation when open. Do not stare into the beam, do not view directly with optical instruments, and avoid direct exposure to the beam. (C030)

CAUTION:

The battery contains lithium. To avoid possible explosion, do not burn or charge the battery.

Do Not:

- ___ Throw or immerse into water
- ___ Heat to more than 100°C (212°F)
- ___ Repair or disassemble

Exchange only with the approved part. Recycle or discard the battery as instructed by local regulations. (C003a)

Power and cabling information for NEBS (Network Equipment-Building System) GR-1089-CORE

The following comments apply to the IBM servers that have been designated as conforming to NEBS (Network Equipment-Building System) GR-1089-CORE:

The equipment is suitable for installation in the following:

- Network telecommunications facilities
- Locations where the NEC (National Electrical Code) applies

The intrabuilding ports of this equipment are suitable for connection to intrabuilding or unexposed wiring or cabling only. The intrabuilding ports of this equipment *must not* be metallically connected to the interfaces that connect to the OSP (outside plant) or its wiring. These interfaces are designed for use as intrabuilding interfaces only (Type 2 or Type 4 ports as described in GR-1089-CORE) and require isolation from the exposed OSP cabling. The addition of primary protectors is not sufficient protection to connect these interfaces metallically to OSP wiring.

Note: All Ethernet cables must be shielded and grounded at both ends.

The ac-powered system does not require the use of an external surge protection device (SPD).

The dc-powered system employs an isolated DC return (DC-I) design. The DC battery return terminal *shall not* be connected to the chassis or frame ground.

SAS subsystem for the 02E/4C or 05E/6C

Review the SAS subsystem features, configurations, and limitations for the 02E/4C or 05E/6C system.

SAS architecture

Serial-attached SCSI (SAS) architecture describes a serial device interconnection and transportation protocol that defines the rules for information exchange between devices.

SAS is an evolution of the parallel SCSI device interface into a serial point-to-point interface. SAS physical links are a set of four wires used as two differential signal pairs. One differential signal transmits in one direction, while the other differential signal transmits in the opposite direction. Data can be transmitted in both directions simultaneously. Physical links are contained in SAS ports, which contain one or more physical links. A port is a wide port if there are more than one physical link in the port. If there is only one physical link in the port, it is a narrow port. A port is identified by a unique SAS worldwide name (also called SAS address).

A *SAS adapter* contains one or more SAS ports. A *path* is a logical point-to-point link between a SAS initiator port in the adapter and a SAS target port in the I/O device (for example, a disk). A *connection* is a temporary association between an adapter and an I/O device through a path. A connection enables communication to a device. The adapter can communicate to the I/O device over this connection by using either the SCSI command set or the Advanced Technology Attachment (ATA) and Advanced technology Attachment Packet Interface (ATAPI) command set depending on the device type.

A *SAS expander* enables connections between an adapter port and multiple I/O device ports by routing connections between the expander ports. Only a single connection through an expander can exist at any given time. Using expanders creates more nodes in the path from the adapter to the I/O device. If an I/O device supports multiple ports, more than one path to the device can exist when there are expander devices included in the path.

A *SAS fabric* refers to the summation of all paths between all SAS adapter ports and all I/O device ports in the SAS subsystem including cables, enclosures, and expanders.

02E/4C or 05E/6C SAS subsystem overview

Review the SAS subsystem features and locations for the 02E/4C or 05E/6C system.

Use this information with your specific system unit and operating system documentation. General information is intended for all users of this product. Service information is intended for a service representative specifically trained on the system unit and subsystem being serviced.

Note: All SAS subsystem features for 02E/4C or 05E/6C systems share the same integrated base system board (CCINs 2B4A and 2B4B), physical location code Un-P1.

Feature locations

Review the supported SAS features and their system locations.

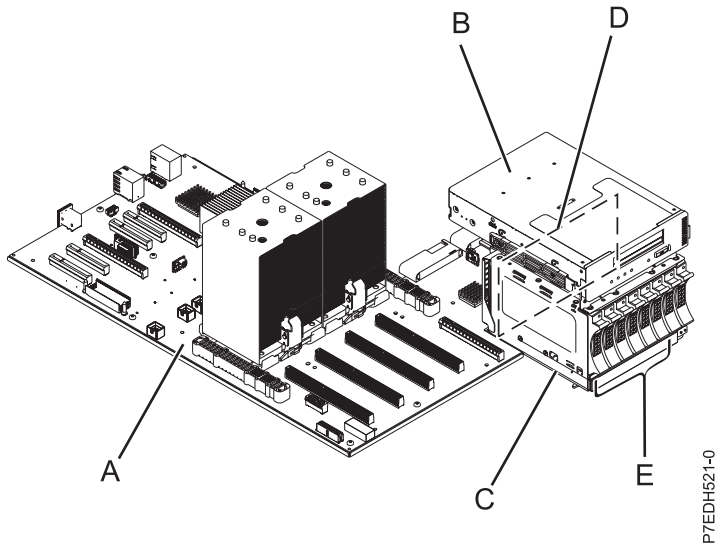

Figure 1. SAS base subsystem overview

Table 1. SAS base subsystem (feature code 5618) components

Diagram location	Part name	CCINs	Physical location codes
A	Base backplane ¹	2B4A, 2B4B	Un-P1
B	Tape drive (optional) ¹	NA	Un-P1-D1 (SAS connector) or Un-P1-D2 (USB connector) Note: The tape drive bay is the same for both.
C	DVD drive ¹	NA	Un-P2-D9
D	Disk drive backplane	2BD5	Un-P2
E	Disk drives (6 SFF drive disk bays, 2 closed "filler" bays)	NA	Un-P2-D1 - Un-P2-D6

¹ Feature is part of the SAS subsystem but separate from feature code 5618.

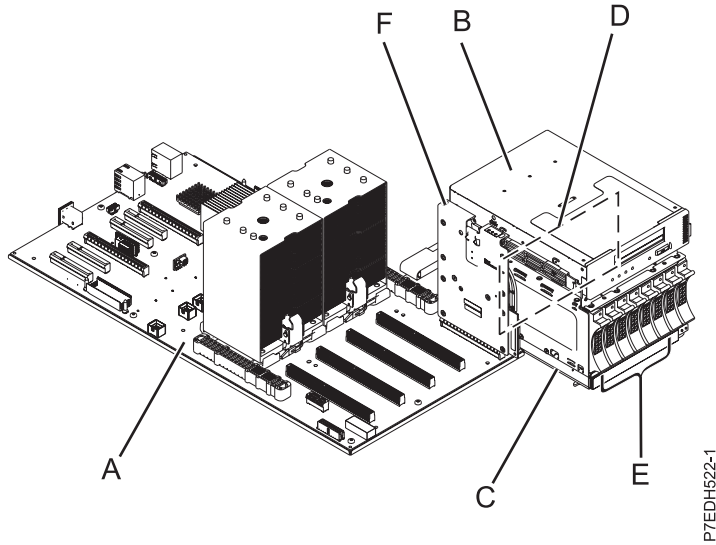

Figure 2. SAS two-way split drive backplane overview

Table 2. SAS base subsystem with two-way split drive backplane components (feature code EJ02)

Diagram location	Part name	CCINs	Physical location codes
A	Base backplane ¹	2B4A, 2B4B	Un-P1
B	Tape drive (optional) ¹	NA	Un-P1-D1 (SAS connector) or Un-P1-D2 (USB connector) Note: The tape drive bay is the same for both.
C	DVD drive ¹	NA	Un-P2-D9
D	Disk drive backplane	2BD5	Un-P2
E	Disk drives (JBOD, RAID-0, RAID-1, or RAID-10)	NA	Un-P2-D1 - Un-P2-D6 (Un-P2-D7 and Un-P2-D8 are closed "filler" bays)
F	RAID-10 storage controller	2B4F (feature code EJ02)	Un-P1-C19

¹ Feature is part of the SAS subsystem but separate from feature code EJ02.

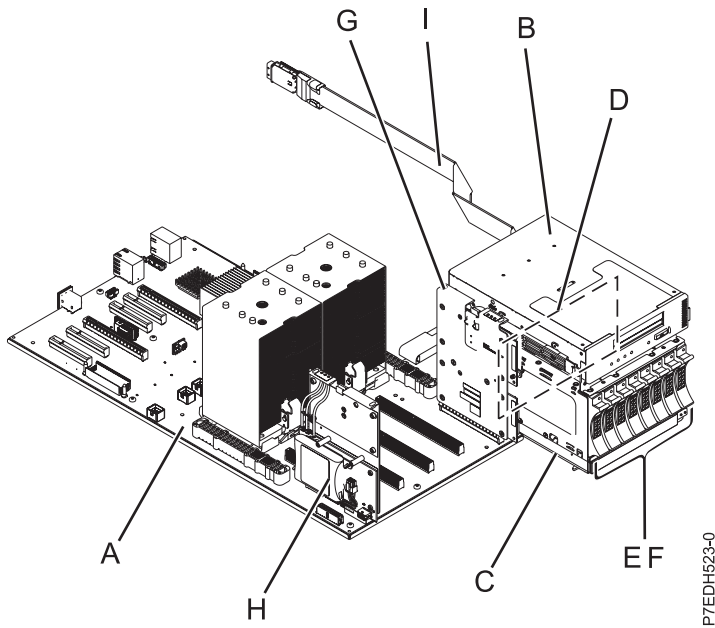

Figure 3. SAS dual-RAID subsystem overview

Table 3. SAS dual-RAID subsystem components (feature code EJ01)

Diagram location	Part name	CCINs	Physical location codes
A	Base backplane ¹	2B4A, 2B4B	Un-P1
B	Tape drive (optional) ¹	NA	Un-P1-D1 (SAS connector) or Un-P1-D2 (USB connector) Note: The tape drive bay is the same for both.
C	DVD drive ¹	NA	Un-P2-D9
D	8-disk-drive dual storage IOA backplane with removable media	2BD6	Un-P2
E, F	8 SFF disk drives	NA	Un-P2-D1 - Un-P2-D8
G	RAID/Cache storage controller	2B4C	Un-P1-C19
H	Cache battery card	2BCF	Un-P1-C14
I	SAS I/O attachment cable		Un-P2-T1
(not pictured)	Optional external SAS cables for storage on integrated RAID ¹ <ul style="list-style-type: none"> • 1.5 m: FC 3686 • 3.0 m: FC 3687 		

¹ Feature is part of the SAS subsystem but separate from feature code EJ01.

Feature details

SAS RAID adapters

The SAS RAID adapters have the following features:

- A host PCI-x at 66 MHz.
- Physical link (phy) speed of 3 Gbps SAS supporting transfer rates of 300 MB per second

- Optimized for SAS disk configurations that use dual paths through dual expanders for redundancy and reliability
- Adapter managed path redundancy and path switching for multiport SAS devices
- Embedded PowerPC® RISC Processor, hardware XOR DMA Engine, and hardware Finite Field Multiplier (FFM) DMA Engine (for Redundant Array of Independent Disks (RAID) 6)
- Support for RAID 0 and 10 disk arrays
- RAID disk arrays supported as a boot device
- Advanced RAID features:
 - Hot spares for RAID 10 disk arrays
 - Background parity checking
 - Background data scrubbing
 - Disks formatted to 528 bytes per sector, providing cyclical redundancy checking (CRC) and logically bad block checking
 - Optimized skip read/write disk support for transaction workloads

Related concepts:

“SAS storage configurations”

Several SAS subsystem configurations are supported on the 02E/4C or 05E/6C system.

Related information:

 Serial attached SCSI cable planning

 System parts

SAS storage configurations

Several SAS subsystem configurations are supported on the 02E/4C or 05E/6C system.

The configuration you use depends on the combination of SAS features that you have installed on your system. The following table provides an overview of the features and related configurations.

Note: All SAS subsystem configurations for 02E/4C or 05E/6C systems share the same integrated base system board (CCIN 2B4A/2B4B), physical location code Un-P1.

Table 4. SAS subsystem configurations for the 02E/4C or 05E/6C system

SAS subsystem configuration	RAID cache enablement card	External SAS components	SAS port cables	SAS cables	Limitations
SAS base subsystem (FC 5618)	No	None	None	Not applicable	<ul style="list-style-type: none"> • Either solid-state drives (SSDs) or hard disk drives (HDDs) can be used, but the two can never be mixed in the same RAID array. • is not supported.

Table 4. SAS subsystem configurations for the 02E/4C or 05E/6C system (continued)

SAS subsystem configuration	RAID cache enablement card	External SAS components	SAS port cables	SAS cables	Limitations
SAS base subsystem with two-way split drive backplane (FC EJ02)	No	None	None	Not applicable	<ul style="list-style-type: none"> is not supported. Connecting to an external disk enclosure is not supported. Each set of three drives can be HDDs or SSDs.
SAS dual-RAID subsystem configuration using internal disk drives and external disk enclosure (FC EJ01)	Yes Note: The internal dual RAID input/output adapters (IOAs) report as CCIN 2BE1 and CCIN 2BD9.	External SAS port	SAS cable assembly for connecting to an external SAS drive enclosure	<ul style="list-style-type: none"> YI cable (FC 3686) <ul style="list-style-type: none"> System to SAS disk enclosure, single adapter/dual path 1.5 meter YI cable (FC 3687) <ul style="list-style-type: none"> System to SAS disk enclosure, single adapter/dual path 3 meter 	Both SSDs and HDDs can be used in the internal disk enclosure, but can never be mixed in the same RAID array. SSDs and HDDs cannot be mixed in the external disk enclosure. If an external SAS drawer is attached, only HDDs are supported.

Related concepts:

“02E/4C or 05E/6C SAS subsystem service considerations” on page 13

Review several considerations before servicing features within the SAS subsystem for the 02E/4C or 05E/6C system.

“Service considerations for the cache battery pack” on page 13

To prevent data loss, follow the procedures before replacing the cache battery pack on the cache RAID cards.

Related information:

 Serial attached SCSI cable planning

02E/4C or 05E/6C SAS subsystem base configuration

This configuration uses the base backplane.

The following rules apply to this configuration:

- This feature is not available with the operating system.
- The base backplane uses six drives and cannot function in dual-storage I/O-adapter (IOA) mode or in high-availability (HA) RAID mode.
- There is a single path to drives.
- Internal adapter slots must be empty (slots Un-P1-C14 and Un-P1-C19).
- Non-volatile RAM (NVRAM) provided by embedded Obsidian module, so drives include JBOD and RAID 0, 1, and 10.
- Solid-state drives (SSDs) and hard disk drives (HDDs) can be mixed in any combination within the internal disk enclosure.

Example: Base backplane

This example shows a base backplane configuration on the 02E/4C and 05E/6C systems.

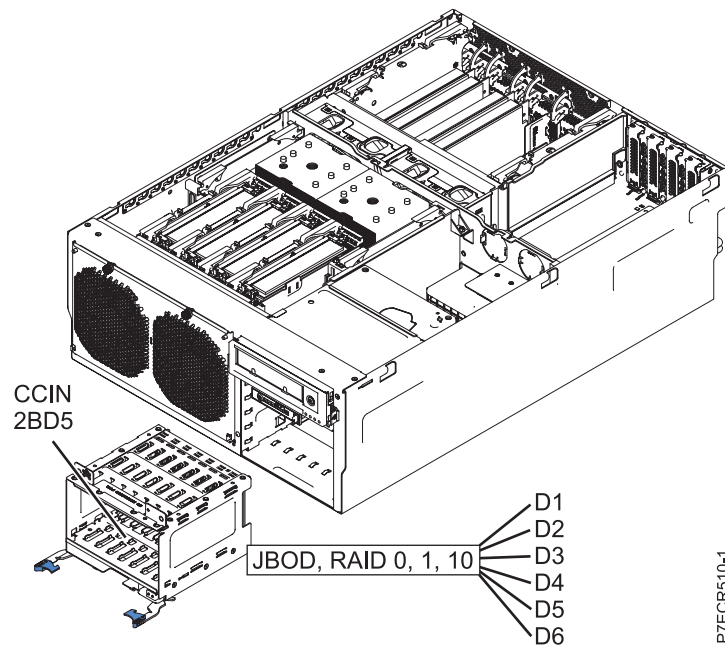

Figure 4. Disk bays controlled by base backplane

The following table lists the details of the base backplane configuration on the 02E/4C and 05E/6C systems.

Table 5. Configuration details

Embedded SAS	Configuration details
Storage controller (on base system board)	<ul style="list-style-type: none"> The base backplane is located at Un-P1. The controller reports as CCIN 57C7. Six JBOD drives (Un-P2-D1 - Un-P2-D6, two closed filler bays) are included on base disk drive backplane. Embedded Obsidian module supports JBOD and RAID 0, 1, and 10. There is a single path to each drive. RAID-0 storage is supported.

02E/4C or 05E/6C SAS base subsystem with two-way split drive backplane

This configuration uses a two-way split backplane.

The following rules apply to this configuration:

- Each SAS adapter can detect only three of the disk drives and cannot function in dual-storage I/O adapter (IOA) mode or in high availability (HA) RAID mode. One SAS adapter (RAID-10 storage controller) connects to D1, D2, and D3. The other SAS adapter (JBOD storage controller) connects to D4, D5, and D6.
- The SAS adapters can be assigned to separate partitions for boot devices.

- This configuration supports disks without RAID (referred to as JBOD) or RAID drives. However, RAID drives are limited to three drives and no write cache.
- RAID 10 with two drives is limited. A RAID 10 array with two drives is equivalent to RAID 1 (mirrored drives). A RAID 0 disk array with one drive is similar to JBOD support. A RAID 10 array with one or three drives is not allowed.
- Solid-state drives (SSDs) and hard disk drives (HDDs) can be used, but can never be mixed in the same disk enclosure.
- SSDs and HDDs can both be present in a split backplane if each side of the split backplane has only SSDs or HDDs. The supported configurations are as follows:
 - SSD on D1 - D3, and HDD on D4 - D6
 - HDD on D1 - D3, and SSD on D4 - D6
 - SSD on D1 - D6
 - HDD on D1 - D6

Example: Two-way split drive backplane

This example shows a two-way split drive backplane configuration on the 02E/4C and 05E/6C systems. The embedded SAS adapter controls three disk drives and the backplane storage controller controls three drives in addition to DVD and optional tape storage.

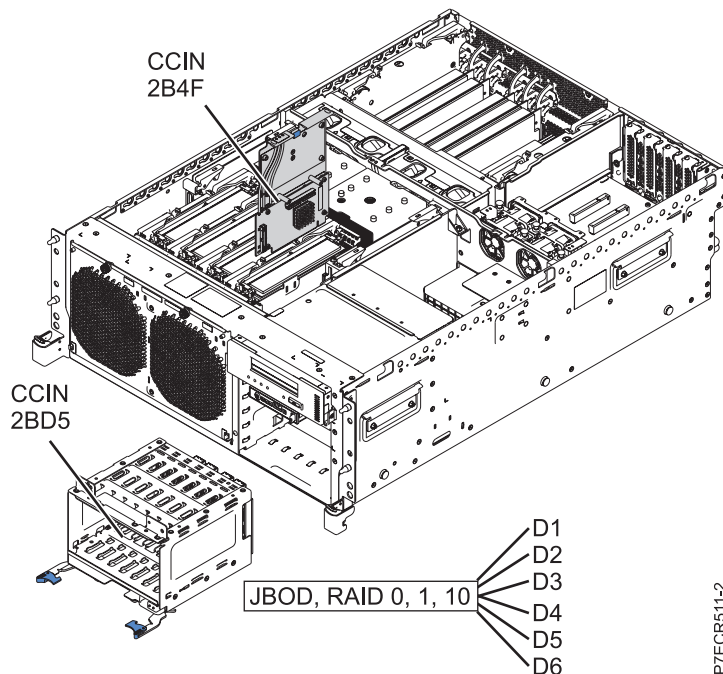

Figure 5. Embedded SAS adapter in a two-way split drive backplane

The following table lists the details of the two-way split drive backplane configuration on the 02E/4C and 05E/6C systems.

Table 6. Configuration details

Embedded SAS	Configuration details
RAID-10 storage controller	<ul style="list-style-type: none"> • Features are located at Un-P1-C19. • The configuration controls D1, D2, and D3. • A single path goes to each drive. • JBOD, RAID 0, RAID 1, and RAID 10 are supported. • Physical connections to the SAS cable are disabled. If the external SAS port is installed, it is not functional. • The SAS adapter reports as CCIN 2B4F.
JBOD storage controller (base backplane)	<ul style="list-style-type: none"> • Features are located at Un-P1. • The configuration controls D4, D5, and D6. • A single path goes to each drive. • JBOD and RAID 0 are supported. • Physical connections to the SAS cable are disabled. If the external SAS port is installed, it is not functional. • The controller reports as CCIN 57C7.

02E/4C or 05E/6C SAS dual-RAID subsystem

The dual-RAID subsystem configuration can be used with both internal and external disk drives or with only internal disk drives.

02E/4C or 05E/6C SAS dual-RAID subsystem with internal drives

This configuration uses dual-storage I/O adapter (IOA) mode or high availability (HA) RAID mode with internal disk drives.

This configuration increases availability by using dual-storage IOA or high availability (HA) to connect multiple adapters to a common set of internal disk drives. It also increases the performance of RAID arrays. The following rules apply to this configuration:

- This configuration uses dual cache RAID adapters.
- Using the RAID adapters with port expanders, the two embedded adapters can connect to each other and all eight disk drives.
- The disk drives are required to be in RAID arrays.
- Separate SAS cables are not required to connect the two embedded SAS RAID adapters to each other. The connection is contained within the backplane.
- RAID 0, 1, 5, 6, and 10 support up to eight drives.
- Solid-state drives (SSDs) and hard disk drives (HDDs) can be used but can never be mixed in the same RAID array. An SSD-only RAID set and an HDD-only RAID set is supported.
- SAS I/O attachment cable is supported for optional connection to external storage.

Example: SAS dual-RAID subsystem with internal drives

This example provides an overview of the dual-storage I/O adapter (IOA) configuration by using internal disk drives on the 02E/4C or 05E/6C system.

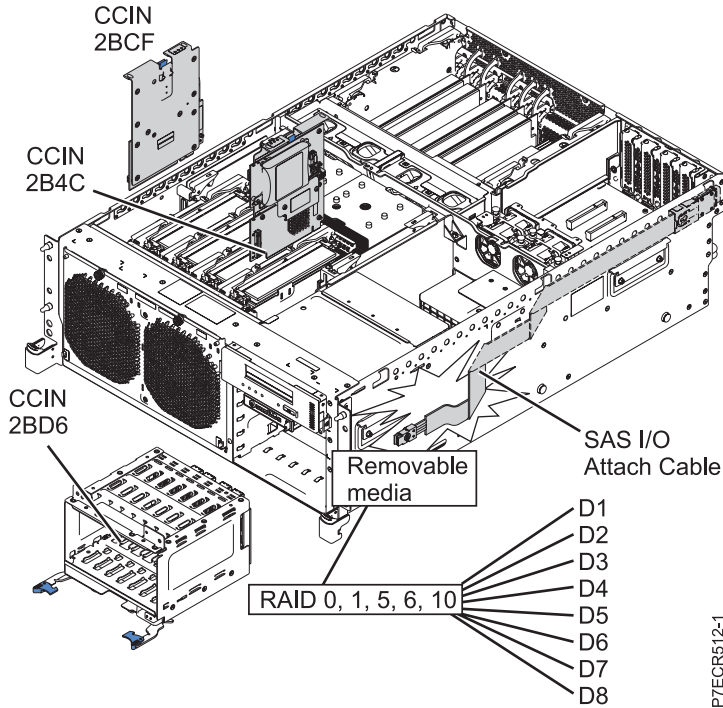

Figure 6. Disk bays controlled by both embedded SAS adapters when using SAS dual-RAID subsystem with internal drives

The following table lists the configuration details.

Table 7. Configuration details

Embedded SAS	Configuration details
Embedded Obsidian-E module (Un-P1-T9) RAID/Cache storage controller (Un-P1-C19, Un-P1-C19-E1) (CCIN 2B4C) Cache battery card (Un-P1-C14) (CCIN 2BCF)	<ul style="list-style-type: none"> • The RAID controller card with cache battery card attached (CCIN 2B4C) creates a RAID adapter. • The SAS adapter connects to all eight disk drives. • Physical connections to the SAS cable are enabled in order to attach to another SAS port expander in an external disk enclosure by using a YI cable.

Related concepts:

“02E/4C or 05E/6C SAS subsystem service considerations” on page 13

Review several considerations before servicing features within the SAS subsystem for the 02E/4C or 05E/6C system.

“Service considerations for the cache battery pack” on page 13

To prevent data loss, follow the procedures before replacing the cache battery pack on the cache RAID cards.

02E/4C or 05E/6C SAS dual-RAID subsystem with external drives

This configuration uses dual-storage I/O adapter (IOA) mode or high availability (HA) RAID mode with internal and external disk drives.

You can increase availability by using high availability to connect multiple adapters to a common set of internal disk drives and external disk enclosures. The following rules apply to this configuration:

- This configuration uses dual cache RAID enablement cards.
- Using the RAID enablement cards with port expanders, the two embedded adapters can connect to each other and all eight disk drives.

- The disk drives are required to be in RAID arrays.
- Separate SAS cables are not required to connect the two embedded SAS RAID adapters to each other. The connection is contained within the backplane.
- RAID 0, 1, 5, 6, and 10 support up to eight drives.
- Solid-state drives (SSDs) and hard disk drives (HDDs) can be used, but can never be mixed in the same RAID array. An SSD-only RAID set and an HDD-only RAID set is supported.
- The external SAS port is used for expansion to external SAS devices or drawers.
- The external SAS port cannot connect to a SAS drawer that is populated with SSDs.
- The external SAS port cannot connect to a SAS drawer at all (even if it is populated with HDDs) if any SSDs are used in the RAID configuration.

Example: SAS dual-RAID subsystem with external drives

This example provides an overview of the SAS dual-RAID subsystem configuration by using external disk drives on the 02E/4C and 05E/6C systems.

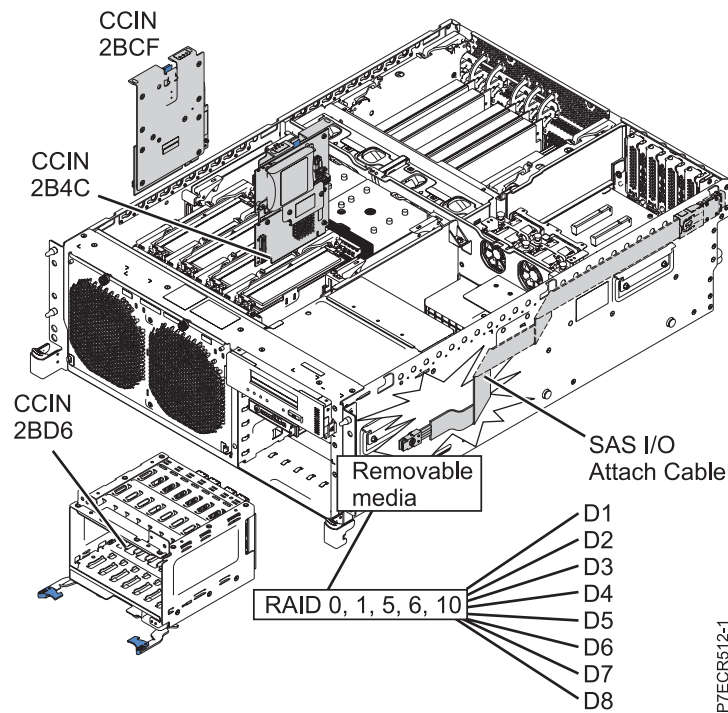

Figure 7. Disk bays controlled by both embedded SAS adapters when using SAS dual-RAID subsystem with external drives

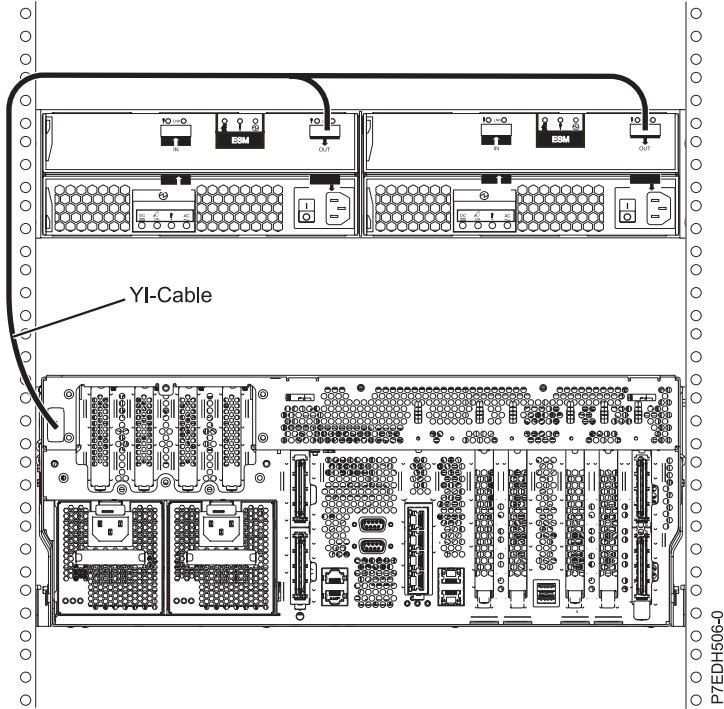

Figure 8. Physical connection to attach external disk enclosures

The following table lists the configuration details.

Table 8. Configuration details

Embedded SAS	Configuration details
RAID/cache storage controller (Un-P1-C19) Cache battery card (Un-P1-C14) Eight-bay disk drive backplane (Un-P2)	<ul style="list-style-type: none"> • RAID controller card with a cache battery card attached (CCIN 2B4C) creates a RAID adapter. • The SAS adapters connect to all eight disk drives and any drives attached by the external cable. • Physical connections to the SAS cable are enabled in order to attach to another SAS port expander in an external disk enclosure by using a YI cable.

Related concepts:

“02E/4C or 05E/6C SAS subsystem service considerations”

Review several considerations before servicing features within the SAS subsystem for the 02E/4C or 05E/6C system.

“Service considerations for the cache battery pack”

To prevent data loss, follow the procedures before replacing the cache battery pack on the cache RAID cards.

02E/4C or 05E/6C SAS subsystem service considerations







Review several considerations before servicing features within the SAS subsystem for the 02E/4C or 05E/6C system.

Attention: Do not attempt to remove any parts related to the SAS subsystem if the cache data present LED on the card in either P1-C19 or P1-C14 is flashing. To see this LED, you must shut down the system and remove the service cover. The LED shows a no-touch icon (a hand with a slash through it), and indicates that data might be in the cache on the adapter. To prevent data loss, first make sure that the system is shut down correctly. If either cache data present LED is flashing, see one of the following topics before removing any SAS subsystem parts. You can safely replace the cache battery pack when Yes is displayed next to Battery pack can be safely replaced on the Battery Information panel (for Linux and IBM i systems) or COMMAND STATUS panel (for AIX® systems).

Before servicing any features, review the I/O configurations for each logical partition on your system. It is important to understand the differences between the various configurations and the resulting service considerations. In addition, consider possible impacts to the following areas.

- Logical partitions and their I/O adapter assignments
- RAID array configurations
- Physical disk locations
- Path to your boot device

Related information:

-  [Displaying rechargeable battery information](#)
-  [Displaying rechargeable battery information](#)
-  [Displaying rechargeable battery information](#)
-  [Logical partitioning](#)
-  [SAS RAID controllers for IBM i](#)
-  [SAS RAID controllers for Linux](#)
-  [SAS RAID controllers for AIX](#)

Service considerations for the cache battery pack

To prevent data loss, follow the procedures before replacing the cache battery pack on the cache RAID cards.

Note: Concurrent maintenance of adapter battery is not supported. Even with failed or missing batteries, the card associated with the battery must first be removed. For more information, see Removing and replacing SAS RAID adapters and batteries.

Attention: To maintain system availability and prevent possible data loss, you must understand that these features have implications on the SAS configuration and data accessibility of the system.

Attention: Do not attempt to remove any parts related to the SAS subsystem if the cache data present LED on the card in either P1-C19 or P1-C14 is flashing. To see this LED, you must shut down the system and remove the service cover. The LED shows a no-touch icon (a hand with a slash through it), and indicates that data might be in the cache on the adapter. To prevent data loss, first make sure the system is shut down correctly. If either cache data present LED is flashing, see one of the following topics before removing any SAS subsystem parts. You can safely replace the cache battery pack when Yes is displayed next to Battery pack can be safely replaced on the Battery Information panel (for the Linux and IBM i systems) or the COMMAND STATUS panel (for AIX systems).

The following figure shows the location of the cache data present LED in the 02E/4C or 05E/6C SAS subsystem.

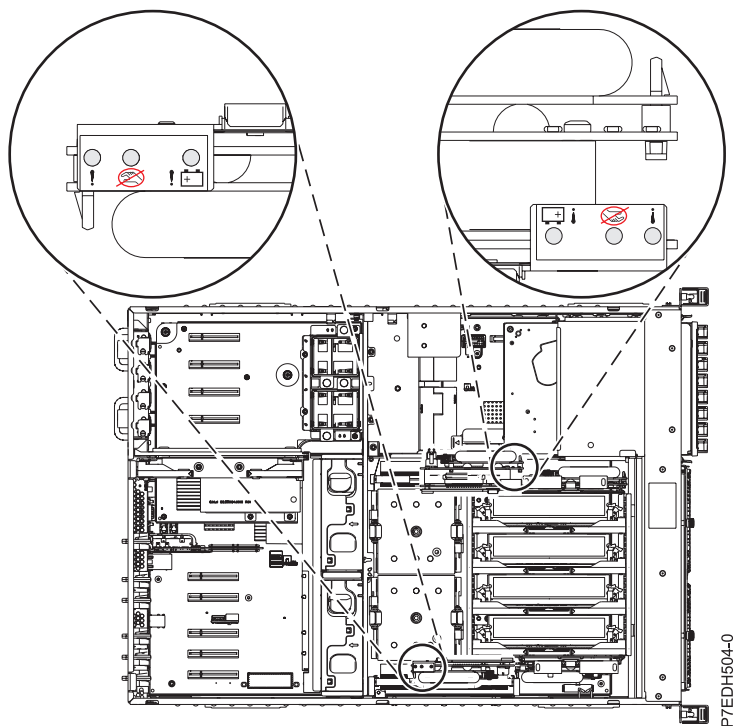



Figure 9. Cache data present LED

The following table describes the states of the cache data present LED and what to consider before attempting a service action.





Table 9. LED indications and actions

Cache battery card (Un-P1-C14)	RAID/Cache storage controller (Un-P1-C19)	Indication	Action
 Off	 Off	Cache is not active.	Service actions can proceed.
 Off	 Flashing	Cache is active on C19. Cache might have been flushed on C14 if C19 failed.	Attempt to power on and shut down prior to any service action.
 Flashing	 Off	Cache is active on C14. Cache might have been flushed on C19 if C14 failed.	Attempt to power on and shut down prior to any service action.

Table 9. LED indications and actions (continued)

Cache battery card (Un-P1-C14)	RAID/Cache storage controller (Un-P1-C19)	Indication	Action
 Flashing	 Flashing	Cache is active on the dual controllers.	Attempt to power on and shut down prior to any service action. If this is unsuccessful in clearing the cache active LEDs, contact support.

Related information:

-  [Displaying rechargeable battery information](#)
-  [Displaying rechargeable battery information](#)
-  [Displaying rechargeable battery information](#)
-  [Removing and Replacing a cache battery pack](#)
-  [Contacting IBM support](#)

Problem determination and recovery





Review the following information about using problem determination and recovery procedures for the 02E/4C or 05E/6C system.

Attention: To maintain system availability and prevent possible data loss, contact your next level of support for any service related to the SAS storage subsystem on the 02E/4C or 05E/6C system.

For more details on service, support, service request numbers (SRNs), and feature information for the SAS storage subsystem, see the following information:

- Planning for cables
- Removing and replacing SAS RAID adapters and batteries
- Installing the external SAS port on a 02E/4B or 05F/6B
- Service request numbers

Related information:

-  [SAS RAID controllers for AIX](#)
-  [SAS RAID controllers for IBM i](#)
-  [SAS RAID controllers for Linux](#)
-  [Serial attached SCSI cable planning](#)

Notices

This information was developed for products and services offered in the U.S.A.

The manufacturer may not offer the products, services, or features discussed in this document in other countries. Consult the manufacturer's representative for information on the products and services currently available in your area. Any reference to the manufacturer's product, program, or service is not intended to state or imply that only that product, program, or service may be used. Any functionally equivalent product, program, or service that does not infringe any intellectual property right of the manufacturer may be used instead. However, it is the user's responsibility to evaluate and verify the operation of any product, program, or service.

The manufacturer may have patents or pending patent applications covering subject matter described in this document. The furnishing of this document does not grant you any license to these patents. You can send license inquiries, in writing, to the manufacturer.

The following paragraph does not apply to the United Kingdom or any other country where such provisions are inconsistent with local law: THIS PUBLICATION IS PROVIDED "AS IS" WITHOUT WARRANTY OF ANY KIND, EITHER EXPRESS OR IMPLIED, INCLUDING, BUT NOT LIMITED TO, THE IMPLIED WARRANTIES OF NON-INFRINGEMENT, MERCHANTABILITY OR FITNESS FOR A PARTICULAR PURPOSE. Some states do not allow disclaimer of express or implied warranties in certain transactions, therefore, this statement may not apply to you.

This information could include technical inaccuracies or typographical errors. Changes are periodically made to the information herein; these changes will be incorporated in new editions of the publication. The manufacturer may make improvements and/or changes in the product(s) and/or the program(s) described in this publication at any time without notice.

Any references in this information to websites not owned by the manufacturer are provided for convenience only and do not in any manner serve as an endorsement of those websites. The materials at those websites are not part of the materials for this product and use of those websites is at your own risk.

The manufacturer may use or distribute any of the information you supply in any way it believes appropriate without incurring any obligation to you.

Any performance data contained herein was determined in a controlled environment. Therefore, the results obtained in other operating environments may vary significantly. Some measurements may have been made on development-level systems and there is no guarantee that these measurements will be the same on generally available systems. Furthermore, some measurements may have been estimated through extrapolation. Actual results may vary. Users of this document should verify the applicable data for their specific environment.

Information concerning products not produced by this manufacturer was obtained from the suppliers of those products, their published announcements or other publicly available sources. This manufacturer has not tested those products and cannot confirm the accuracy of performance, compatibility or any other claims related to products not produced by this manufacturer. Questions on the capabilities of products not produced by this manufacturer should be addressed to the suppliers of those products.

All statements regarding the manufacturer's future direction or intent are subject to change or withdrawal without notice, and represent goals and objectives only.

The manufacturer's prices shown are the manufacturer's suggested retail prices, are current and are subject to change without notice. Dealer prices may vary.

This information is for planning purposes only. The information herein is subject to change before the products described become available.

This information contains examples of data and reports used in daily business operations. To illustrate them as completely as possible, the examples include the names of individuals, companies, brands, and products. All of these names are fictitious and any similarity to the names and addresses used by an actual business enterprise is entirely coincidental.

If you are viewing this information in softcopy, the photographs and color illustrations may not appear.

The drawings and specifications contained herein shall not be reproduced in whole or in part without the written permission of the manufacturer.

The manufacturer has prepared this information for use with the specific machines indicated. The manufacturer makes no representations that it is suitable for any other purpose.

The manufacturer's computer systems contain mechanisms designed to reduce the possibility of undetected data corruption or loss. This risk, however, cannot be eliminated. Users who experience unplanned outages, system failures, power fluctuations or outages, or component failures must verify the accuracy of operations performed and data saved or transmitted by the system at or near the time of the outage or failure. In addition, users must establish procedures to ensure that there is independent data verification before relying on such data in sensitive or critical operations. Users should periodically check the manufacturer's support websites for updated information and fixes applicable to the system and related software.

Homologation statement

This product may not be certified in your country for connection by any means whatsoever to interfaces of public telecommunications networks. Further certification may be required by law prior to making any such connection. Contact an IBM representative or reseller for any questions.

Trademarks

IBM, the IBM logo, and ibm.com are trademarks or registered trademarks of International Business Machines Corp., registered in many jurisdictions worldwide. Other product and service names might be trademarks of IBM or other companies. A current list of IBM trademarks is available on the web at Copyright and trademark information at www.ibm.com/legal/copytrade.shtml.

Linux is a registered trademark of Linus Torvalds in the United States, other countries, or both.

Electronic emission notices

When attaching a monitor to the equipment, you must use the designated monitor cable and any interference suppression devices supplied with the monitor.

Class A Notices

The following Class A statements apply to the servers.

Federal Communications Commission (FCC) statement

Note: This equipment has been tested and found to comply with the limits for a Class A digital device, pursuant to Part 15 of the FCC Rules. These limits are designed to provide reasonable protection against harmful interference when the equipment is operated in a commercial environment. This equipment generates, uses, and can radiate radio frequency energy and, if not installed and used in accordance with the instruction manual, may cause harmful interference to radio communications. Operation of this

equipment in a residential area is likely to cause harmful interference, in which case the user will be required to correct the interference at his own expense.

Properly shielded and grounded cables and connectors must be used in order to meet FCC emission limits. IBM is not responsible for any radio or television interference caused by using other than recommended cables and connectors or by unauthorized changes or modifications to this equipment. Unauthorized changes or modifications could void the user's authority to operate the equipment.

This device complies with Part 15 of the FCC rules. Operation is subject to the following two conditions: (1) this device may not cause harmful interference, and (2) this device must accept any interference received, including interference that may cause undesired operation.

Industry Canada Compliance Statement

This Class A digital apparatus complies with Canadian ICES-003.

Avis de conformité à la réglementation d'Industrie Canada

Cet appareil numérique de la classe A est conforme à la norme NMB-003 du Canada.

European Community Compliance Statement

This product is in conformity with the protection requirements of EU Council Directive 2004/108/EC on the approximation of the laws of the Member States relating to electromagnetic compatibility. IBM cannot accept responsibility for any failure to satisfy the protection requirements resulting from a non-recommended modification of the product, including the fitting of non-IBM option cards.

This product has been tested and found to comply with the limits for Class A Information Technology Equipment according to European Standard EN 55022. The limits for Class A equipment were derived for commercial and industrial environments to provide reasonable protection against interference with licensed communication equipment.

European Community contact:
IBM Deutschland GmbH
Technical Regulations, Department M372
IBM-Allee 1, 71139 Ehningen, Germany
Tele: +49 7032 15 2941
email: lugi@de.ibm.com

Warning: This is a Class A product. In a domestic environment, this product may cause radio interference, in which case the user may be required to take adequate measures.

VCCI Statement - Japan

この装置は、クラスA情報技術装置です。この装置を家庭環境で使用すると電波妨害を引き起こすことがあります。この場合には使用者が適切な対策を講ずるよう要求されることがあります。

VCCI-A

The following is a summary of the VCCI Japanese statement in the box above:

This is a Class A product based on the standard of the VCCI Council. If this equipment is used in a domestic environment, radio interference may occur, in which case, the user may be required to take corrective actions.

**Japanese Electronics and Information Technology Industries Association (JEITA)
Confirmed Harmonics Guideline (products less than or equal to 20 A per phase)**

高調波ガイドライン適合品

**Japanese Electronics and Information Technology Industries Association (JEITA)
Confirmed Harmonics Guideline with Modifications (products greater than 20 A per phase)**

高調波ガイドライン準用品

Electromagnetic Interference (EMI) Statement - People's Republic of China

声 明

此为 A 级产品,在生活环境
中,该产品可能会造成无线电干
扰。在这种情况下,可能需要用
户对其干扰采取切实可行的措
施。

Declaration: This is a Class A product. In a domestic environment this product may cause radio interference in which case the user may need to perform practical action.

Electromagnetic Interference (EMI) Statement - Taiwan

警告使用者：

這是甲類的資訊產品，在居住的環境中使用時，可能會造成射頻干擾，在這種情況下，使用者會被要求採取某些適當的對策。

The following is a summary of the EMI Taiwan statement above.

Warning: This is a Class A product. In a domestic environment this product may cause radio interference in which case the user will be required to take adequate measures.

Electromagnetic Interference (EMI) Statement - Korea

이 기기는 업무용(A급)으로 전자파적합기기로서 판매자 또는 사용자는 이 점을 주의하시기 바라며, 가정외의 지역에서 사용하는 것을 목적으로 합니다.

Germany Compliance Statement

Deutschsprachiger EU Hinweis: Hinweis für Geräte der Klasse A EU-Richtlinie zur Elektromagnetischen Verträglichkeit

Dieses Produkt entspricht den Schutzanforderungen der EU-Richtlinie 2004/108/EG zur Angleichung der Rechtsvorschriften über die elektromagnetische Verträglichkeit in den EU-Mitgliedsstaaten und hält die Grenzwerte der EN 55022 Klasse A ein.

Um dieses sicherzustellen, sind die Geräte wie in den Handbüchern beschrieben zu installieren und zu betreiben. Des Weiteren dürfen auch nur von der IBM empfohlene Kabel angeschlossen werden. IBM übernimmt keine Verantwortung für die Einhaltung der Schutzanforderungen, wenn das Produkt ohne Zustimmung von IBM verändert bzw. wenn Erweiterungskomponenten von Fremdherstellern ohne Empfehlung von IBM gesteckt/eingebaut werden.

EN 55022 Klasse A Geräte müssen mit folgendem Warnhinweis versehen werden:

"Warnung: Dieses ist eine Einrichtung der Klasse A. Diese Einrichtung kann im Wohnbereich Funk-Störungen verursachen; in diesem Fall kann vom Betreiber verlangt werden, angemessene Maßnahmen zu ergreifen und dafür aufzukommen."

Deutschland: Einhaltung des Gesetzes über die elektromagnetische Verträglichkeit von Geräten

Dieses Produkt entspricht dem "Gesetz über die elektromagnetische Verträglichkeit von Geräten (EMVG)". Dies ist die Umsetzung der EU-Richtlinie 2004/108/EG in der Bundesrepublik Deutschland.

Zulassungsbescheinigung laut dem Deutschen Gesetz über die elektromagnetische Verträglichkeit von Geräten (EMVG) (bzw. der EMC EG Richtlinie 2004/108/EG) für Geräte der Klasse A

Dieses Gerät ist berechtigt, in Übereinstimmung mit dem Deutschen EMVG das EG-Konformitätszeichen - CE - zu führen.

Verantwortlich für die Einhaltung der EMV Vorschriften ist der Hersteller:

International Business Machines Corp.

New Orchard Road

Armonk, New York 10504

Tel: 914-499-1900

Der verantwortliche Ansprechpartner des Herstellers in der EU ist:

IBM Deutschland GmbH

Technical Regulations, Abteilung M372

IBM-Allee 1, 71139 Ehningen, Germany

Tel: +49 7032 15 2941

email: lugi@de.ibm.com

Generelle Informationen:

Das Gerät erfüllt die Schutzanforderungen nach EN 55024 und EN 55022 Klasse A.

Electromagnetic Interference (EMI) Statement - Russia

ВНИМАНИЕ! Настоящее изделие относится к классу А.
В жилых помещениях оно может создавать радиопомехи, для снижения которых необходимы дополнительные меры

Class B Notices

The following Class B statements apply to features designated as electromagnetic compatibility (EMC) Class B in the feature installation information.

Federal Communications Commission (FCC) statement

This equipment has been tested and found to comply with the limits for a Class B digital device, pursuant to Part 15 of the FCC Rules. These limits are designed to provide reasonable protection against harmful interference in a residential installation.

This equipment generates, uses, and can radiate radio frequency energy and, if not installed and used in accordance with the instructions, may cause harmful interference to radio communications. However, there is no guarantee that interference will not occur in a particular installation.

If this equipment does cause harmful interference to radio or television reception, which can be determined by turning the equipment off and on, the user is encouraged to try to correct the interference by one or more of the following measures:

- Reorient or relocate the receiving antenna.
- Increase the separation between the equipment and receiver.
- Connect the equipment into an outlet on a circuit different from that to which the receiver is connected.
- Consult an IBM-authorized dealer or service representative for help.

Properly shielded and grounded cables and connectors must be used in order to meet FCC emission limits. Proper cables and connectors are available from IBM-authorized dealers. IBM is not responsible for any radio or television interference caused by unauthorized changes or modifications to this equipment. Unauthorized changes or modifications could void the user's authority to operate this equipment.

This device complies with Part 15 of the FCC rules. Operation is subject to the following two conditions: (1) this device may not cause harmful interference, and (2) this device must accept any interference received, including interference that may cause undesired operation.

Industry Canada Compliance Statement

This Class B digital apparatus complies with Canadian ICES-003.

Avis de conformité à la réglementation d'Industrie Canada

Cet appareil numérique de la classe B est conforme à la norme NMB-003 du Canada.

European Community Compliance Statement

This product is in conformity with the protection requirements of EU Council Directive 2004/108/EC on the approximation of the laws of the Member States relating to electromagnetic compatibility. IBM cannot accept responsibility for any failure to satisfy the protection requirements resulting from a non-recommended modification of the product, including the fitting of non-IBM option cards.

This product has been tested and found to comply with the limits for Class B Information Technology Equipment according to European Standard EN 55022. The limits for Class B equipment were derived for typical residential environments to provide reasonable protection against interference with licensed communication equipment.

European Community contact:
IBM Deutschland GmbH
Technical Regulations, Department M372
IBM-Allee 1, 71139 Ehningen, Germany
Tele: +49 7032 15 2941
email: lugi@de.ibm.com

VCCI Statement - Japan

この装置は、クラスB情報技術装置です。この装置は、家庭環境で使用することを目的としていますが、この装置がラジオやテレビジョン受信機に近接して使用されると、受信障害を引き起こすことがあります。

取扱説明書に従って正しい取り扱いをして下さい。 VCCI-B

Japanese Electronics and Information Technology Industries Association (JEITA) Confirmed Harmonics Guideline (products less than or equal to 20 A per phase)

高調波ガイドライン適合品

Japanese Electronics and Information Technology Industries Association (JEITA) Confirmed Harmonics Guideline with Modifications (products greater than 20 A per phase)

高調波ガイドライン準用品

Electromagnetic Interference (EMI) Statement - Korea

이 기기는 가정용(B급)으로 전자파적합기기로서 주로 가정에서 사용하는 것을 목적으로 하며, 모든 지역에서 사용할 수 있습니다.

Germany Compliance Statement

Deutschsprachiger EU Hinweis: Hinweis für Geräte der Klasse B EU-Richtlinie zur Elektromagnetischen Verträglichkeit

Dieses Produkt entspricht den Schutzanforderungen der EU-Richtlinie 2004/108/EG zur Angleichung der Rechtsvorschriften über die elektromagnetische Verträglichkeit in den EU-Mitgliedsstaaten und hält die Grenzwerte der EN 55022 Klasse B ein.

Um dieses sicherzustellen, sind die Geräte wie in den Handbüchern beschrieben zu installieren und zu betreiben. Des Weiteren dürfen auch nur von der IBM empfohlene Kabel angeschlossen werden. IBM übernimmt keine Verantwortung für die Einhaltung der Schutzanforderungen, wenn das Produkt ohne Zustimmung von IBM verändert bzw. wenn Erweiterungskomponenten von Fremdherstellern ohne Empfehlung von IBM gesteckt/eingebaut werden.

Deutschland: Einhaltung des Gesetzes über die elektromagnetische Verträglichkeit von Geräten

Dieses Produkt entspricht dem "Gesetz über die elektromagnetische Verträglichkeit von Geräten (EMVG)". Dies ist die Umsetzung der EU-Richtlinie 2004/108/EG in der Bundesrepublik Deutschland.

Zulassungsbescheinigung laut dem Deutschen Gesetz über die elektromagnetische Verträglichkeit von Geräten (EMVG) (bzw. der EMC EG Richtlinie 2004/108/EG) für Geräte der Klasse B

Dieses Gerät ist berechtigt, in Übereinstimmung mit dem Deutschen EMVG das EG-Konformitätszeichen - CE - zu führen.

Verantwortlich für die Einhaltung der EMV Vorschriften ist der Hersteller:
International Business Machines Corp.
New Orchard Road
Armonk, New York 10504
Tel: 914-499-1900

Der verantwortliche Ansprechpartner des Herstellers in der EU ist:
IBM Deutschland GmbH
Technical Regulations, Abteilung M372
IBM-Allee 1, 71139 Ehningen, Germany
Tel: +49 7032 15 2941
email: lugi@de.ibm.com

Generelle Informationen:

Das Gerät erfüllt die Schutzanforderungen nach EN 55024 und EN 55022 Klasse B.

Terms and conditions

Permissions for the use of these publications are granted subject to the following terms and conditions.

Applicability: These terms and conditions are in addition to any terms of use for the the manufacturer website.

Personal Use: You may reproduce these publications for your personal, noncommercial use provided that all proprietary notices are preserved. You may not distribute, display or make derivative works of these publications, or any portion thereof, without the express consent of the manufacturer.

Commercial Use: You may reproduce, distribute and display these publications solely within your enterprise provided that all proprietary notices are preserved. You may not make derivative works of

these publications, or reproduce, distribute or display these publications or any portion thereof outside your enterprise, without the express consent of the manufacturer.

Rights: Except as expressly granted in this permission, no other permissions, licenses or rights are granted, either express or implied, to the Publications or any information, data, software or other intellectual property contained therein.

The manufacturer reserves the right to withdraw the permissions granted herein whenever, in its discretion, the use of the publications is detrimental to its interest or, as determined by the manufacturer, the above instructions are not being properly followed.

You may not download, export or re-export this information except in full compliance with all applicable laws and regulations, including all United States export laws and regulations.

THE MANUFACTURER MAKES NO GUARANTEE ABOUT THE CONTENT OF THESE PUBLICATIONS. THE PUBLICATIONS ARE PROVIDED "AS-IS" AND WITHOUT WARRANTY OF ANY KIND, EITHER EXPRESSED OR IMPLIED, INCLUDING BUT NOT LIMITED TO IMPLIED WARRANTIES OF MERCHANTABILITY, NON-INFRINGEMENT, AND FITNESS FOR A PARTICULAR PURPOSE.

Printed in USA