

NIM from A to Z in AIX 5L

Configuring NIM - illustrated

Sample best practices

NIM case scenarios

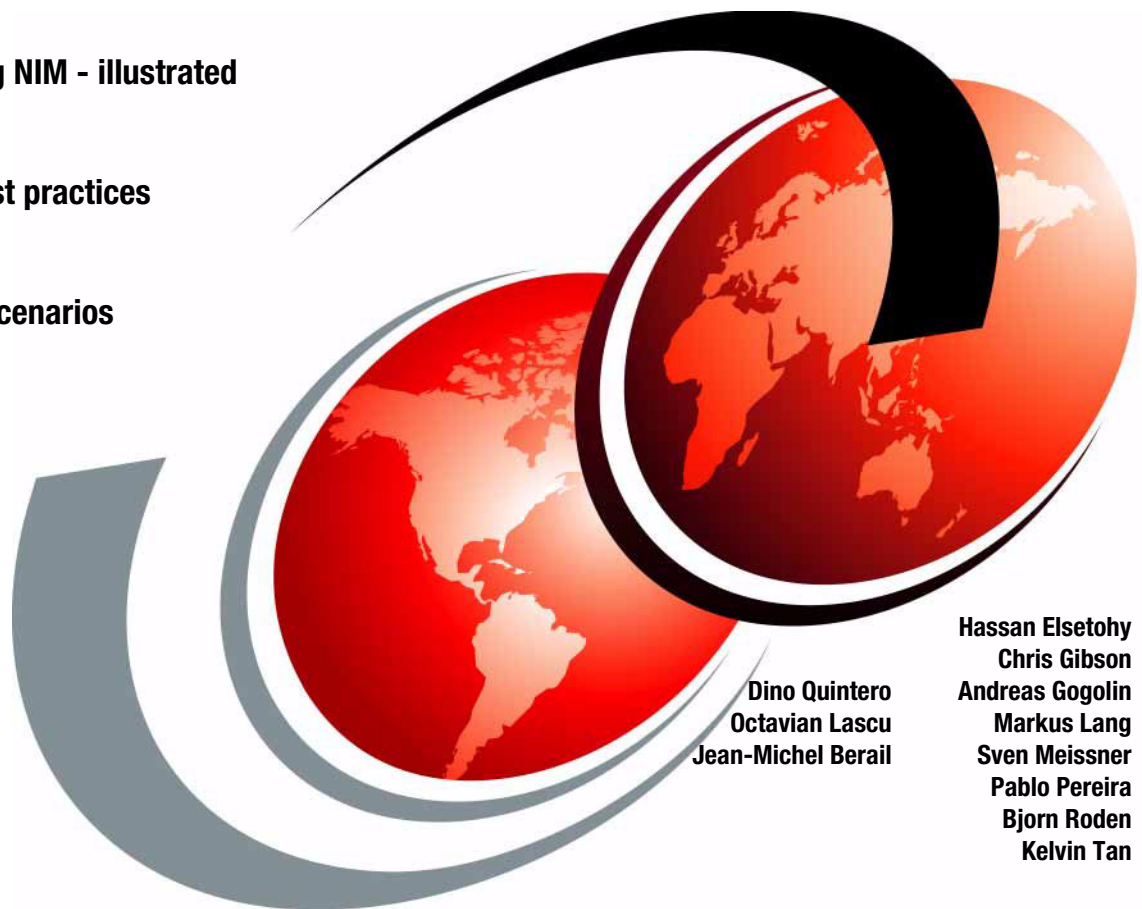

Dino Quintero
Octavian Lascu
Jean-Michel Berail

Hassan Elsetohy
Chris Gibson
Andreas Gogolin
Markus Lang
Sven Meissner
Pablo Pereira
Bjorn Roden
Kelvin Tan



International Technical Support Organization

NIM from A to Z in AIX 5L

May 2006

Note: Before using this information and the product it supports, read the information in “Notices” on page ix.

First Edition (May 2006)

This edition applies to AIX 5L V5.3 Technology Level 5, Cluster Systems Management (CSM) V1.5.1, and IBM Director V5.1.

© Copyright International Business Machines Corporation 2007. All rights reserved.

Note to U.S. Government Users Restricted Rights -- Use, duplication or disclosure restricted by GSA ADP Schedule Contract with IBM Corp.

Contents

Notices	ix
Trademarks	x
Preface	xi
The team that wrote this book	xi
Become a published author	xiv
Comments welcome	xv
Chapter 1. Introduction	1
1.1 Using Network Installation Manager	2
1.1.1 Benefits and features of NIM	2
1.2 Overview of this book	4
1.2.1 The contents of this book	4
1.2.2 Test environment	5
Chapter 2. Network Installation Manager definitions and concepts	7
2.1 Basic NIM configuration	8
2.1.1 NIM overview	8
2.1.2 How a NIM environment works	16
2.1.3 Before working with a NIM environment	25
2.1.4 NIM master selection	26
2.1.5 Easy steps to start with NIM	28
2.1.6 Easy steps to maintain a NIM environment	36
2.2 What is new in NIM for AIX 5L	39
2.2.1 NIM improvements with AIX 5L V5.1	39
2.2.2 NIM improvements with AIX 5L V5.2	39
2.2.3 NIM improvements with AIX 5L V5.3	43
2.3 Planning for your NIM environment	45
2.3.1 Choosing your NIM master	45
2.3.2 Dynamic LPAR operations	47
2.3.3 Defining a consistent naming convention	47
2.3.4 Sizing your NIM master	49
2.3.5 Designing for availability	50
Chapter 3. Basic configuration of a Network Installation Manager environment	51
3.1 Setting up a basic NIM environment	53
3.1.1 Planning the NIM environment	53
3.1.2 Setting up the NIM environment	59

3.2	Web-Based System Manager	96
3.2.1	Configuring a NIM master through WebSM	96
3.2.2	Configuring NIM clients using Web-Based System Management.	106
3.2.3	Installing a NIM client using Web-Based System Management	110
3.3	EZNIM	115
3.3.1	Configuring a NIM master using nim_master_setup	115
3.3.2	Configuring NIM clients using nim_clients_setup	119
Chapter 4. Network Installation Manager scenarios		123
4.1	High Availability Network Installation Manager	124
4.1.1	Configuring the alternate (backup) NIM master	125
4.1.2	Initialize the backup server as the alternate NIM master server	128
4.1.3	Perform NIM synchronization	130
4.1.4	NIM master takeover.	133
4.1.5	NIM master fallback	136
4.2	Using the OS_install command	137
4.2.1	OS_install basics.	138
4.2.2	OS_install resource definition	139
4.2.3	OS_install controlling host definition	140
4.2.4	OS_install client definition	140
4.2.5	OS_install resource allocation and installation	141
4.2.6	OS_install XML repository.	143
4.3	NIM environment with additional resource servers	143
4.3.1	Configuring a resource server.	144
4.3.2	Performing a BOS installation	149
4.4	Using NIM to perform AIX migrations of NIM master and clients	151
4.4.1	Migrating a NIM master to AIX 5L V5.3.	152
4.4.2	Migrating a NIM client to AIX 5L V5.3	163
4.4.3	NIM client AIX migration example	168
4.4.4	Debugging a NIM AIX migration	198
4.5	NIM mksysb migration and nim_move_up POWER5 tools.	205
4.5.1	mksysb migration	205
4.5.2	Performing a mksysb migration with NIM	208
4.5.3	Migrating a NIM client to a POWER5 logical partition using nim_move_up	216
4.5.4	Example nim_move_up operation.	220
4.5.5	POWER5-to-POWER5 nim_move_up	260
4.6	NIM alternate disk migration	261
4.6.1	Local disk caching versus NFS.	263
4.6.2	The 12 phases of nimadm migration.	264
4.6.3	Example nimadm migration.	265
4.6.4	Cleaning up after a failed nimadm operation	283
4.7	Network Installation Manager and Linux distributions	284

4.7.1	Configuring DHCP	285
4.7.2	Intel PXE configuration	296
4.8	Common Operating System Image (COSI) management	298
4.8.1	Thin server, diskless, dataless, and Common Operating System Image 299	
4.8.2	Creating a Common OS Image	302
4.8.3	Creating a thin server	303
4.8.4	Remove a thin server	306
4.9	Using HACMP with HANIM	307
4.10	NIM and Service Update Management Assistant	319
4.10.1	Using SUMA	323
4.10.2	Settings for SUMA	324
4.10.3	SUMA tasks	327
4.10.4	Maintenance models	332
4.10.5	Removing duplicate filesets from a NIM lpp_source directory . . .	339
4.10.6	Checking whether a system has all available updates installed . .	341
4.10.7	IBM AIX Service Strategy	347
4.10.8	IBM Support Fix Central Web site	348
4.11	Backing up clients with NIM	348
4.11.1	Space requirements	351
4.11.2	NFS export during mkysyb image file creation	352
4.11.3	Exclude file for mkysyb image creation	352
4.12	Creating bundles, BFF, and RPM packages	354
4.12.1	BFF (native installp packages)	355
4.12.2	RPM	364
4.13	NIM and Virtual I/O (VIO)	373
4.13.1	Virtual SCSI	373
4.13.2	Virtual Shared Ethernet	374
4.13.3	Considerations when using a VIO server	374
4.13.4	Setting up the VIO server and configuring the NIM master in the VIO client	374
4.14	Backup and restore of the VIO Server using NIM	385
4.14.1	Backup of VIO server	385
4.14.2	Restoring the VIO server	387
4.15	Using RSCT PeerDomain with HANIM	390
	Chapter 5. Network Installation Manager best practices	409
5.1	Updating the NIM environment (lpp_source, SPOT)	410
5.2	Secondary adapter	415
5.2.1	Secondary adapter support	415
5.2.2	Working with secondary adapter file rules	416
5.2.3	Secondary adapter files	417
5.2.4	Configuring a secondary adapter	421

5.3 NIMSH, OpenSSL and firewall considerations	424
5.3.1 Authentication process	426
5.3.2 Setting up NIMSH	427
5.3.3 Verifying NIMSH startup	428
5.3.4 Enabling cryptographic authentication	428
5.3.5 Enabling a secondary port for NIMSH communication	434
5.3.6 Disabling push operations using NIMSH.	435
5.3.7 Disabling pull operations	436
5.3.8 NIM communication within a firewall environment	437
5.3.9 NFS reserved ports	441
5.3.10 Firewall considerations	450
5.4 Cloning NIM clients using mksysb.	451
5.4.1 Using a mksysb image to clone NIM Client.	451
5.4.2 Prerequisites	452
5.4.3 mksysb image installation on a NIM Client	453
5.4.4 Mksysb resource creation	453
5.4.5 Correlating mksysb and SPOT resources	455
5.4.6 SPOT creation from an existing mksysb	456
5.4.7 mksysb installation	457
5.4.8 Monitoring the mksysb installation	459
5.5 Using NIM to migrate systems to new hardware.	460
5.5.1 Migrating the image of an LPAR to another system using NIM . . .	461
5.5.2 Relocating the image of an LPAR to a remote location	464
5.5.3 Migrating to new hardware utilizing custom bosint.data and image.data files	465
5.6 Using SAN zoning for cloning LPARs	475
5.7 System maintenance for NIM clients.	478
5.7.1 Software maintenance approach	479
5.7.2 Booting in maint_boot and diag modes.	497
5.8 Automatic scripts	504
5.8.1 Install time customization	505
5.8.2 Customization for BOS installations	505
5.9 Implementing a standard operating environment for AIX 5L V5.3 systems with NIM.	519
5.9.1 Do you need an SOE for your AIX systems	520
5.9.2 What is an SOE for AIX systems	520
5.10 Backing up and reinstalling a NIM master.	537
5.10.1 Scenario 1: Back up and restore a NIM master on the same machine using a tape	538
5.10.2 Scenario 2: Back up and restore a NIM master on a different machine using a tape	538
5.10.3 Scenario 3: Back up and restore a NIM master using another NIM master.	541

5.10.4	Changing the NIM master hostname	544
5.10.5	Changing the NIM master IP address	548
Chapter 6. Cluster Systems Management and Network Installation Manager		
	559	
6.1	Overview of Cluster Systems Management	560
6.1.1	The management server	560
6.1.2	NIM and CSM	562
Chapter 7. Basic NIM problem determination and tuning		
7.1	Troubleshooting methodologies	566
7.1.1	Troubleshooting a network boot problem	566
7.1.2	Debugging NIM BOS installations	576
7.1.3	Recreating the SPOT from an existing directory	576
7.2	LEDs	577
7.2.1	LED values during NIM operations	577
7.2.2	Hang on LED 611 - NFS mount problem	580
7.2.3	NIM installation hangs on LED 613	581
7.3	Network File System (NFS) usage	581
7.3.1	Exporting NIM resources globally	582
7.4	Booting issues	584
7.4.1	Booting	584
7.5	Log files	587
7.5.1	NIM-related files	587
7.5.2	RSH-related files	589
7.5.3	BOOTP-related files	590
7.5.4	TFTP-related files	591
7.5.5	NFS-related file	592
7.6	Case study: NIM server performance	593
7.6.1	Setting up the environment	593
7.6.2	Monitoring the NIM master using topas	595
7.6.3	Upgrading a NIM environment to Gbit Ethernet	599
7.6.4	Upgrading the disk storage	601
7.6.5	Real workload with spread file system	609
7.6.6	Summary	612
7.6.7	Multi-threaded option for the NIM nimesis daemon	612
Appendix A. General LPAR sizing and creation with mig2p5 tools		
	615	
The mig2p5 tools	616	
/usr/lpp/bos.sysmgt/nim/methods/getSrcUtil	617	
/usr/lpp/bos.sysmgt/nim/methods/getSrcCfg	617	
/usr/lpp/bos.sysmgt/nim/methods/getTgtRsrc	617	
/usr/lpp/bos.sysmgt/nim/methods/genTgtCfg	617	
/usr/lpp/bos.sysmgt/nim/methods/createTgtLPAR	618	

Standalone mig2p5 tool	618
Get the source LPARs hardware configuration	619
Get the source LPARs CPU and memory utilization	620
Flags for getSrcCfg command	620
Flags for the getSrcUtil command	621
Get the target POWER5 machine resources via its HMC	621
Flags for the getTgtRsrc command	622
Flags for the genTgtCfg command	623
Generate the target LPARs profile information	623
Generated Target LPAR configuration information	625
Create the target LPAR definition on the POWER5 machine	625
Flags for the createTgtLPAR command	628
Appendix B. Automatic provisioning NIM and Tivoli Provisioning Manager	
629	
Overview of Tivoli Provisioning Manager	630
Why use Tivoli Provisioning Manager	630
The architectural picture	630
TPM terminology	631
Workflow to define a NIM client	634
Automated provisioning scenario	636
Automation methods (interfaces, command line, Web services)	638
Appendix C. NIM and System i operating system installation for an AIX 5L LPAR.	
639	
IBM System i operating system installation for an AIX 5L LPAR	640
Appendix D. Additional material	643
Locating the Web material	643
Using the Web material	643
System requirements for downloading the Web material	644
How to use the Web material	644
Abbreviations and acronyms	645
Related publications	649
IBM Redbooks	649
Other publications	649
Online resources	649
How to get IBM Redbooks	650
Help from IBM	650
Index	651

Notices

This information was developed for products and services offered in the U.S.A.

IBM may not offer the products, services, or features discussed in this document in other countries. Consult your local IBM representative for information on the products and services currently available in your area. Any reference to an IBM product, program, or service is not intended to state or imply that only that IBM product, program, or service may be used. Any functionally equivalent product, program, or service that does not infringe any IBM intellectual property right may be used instead. However, it is the user's responsibility to evaluate and verify the operation of any non-IBM product, program, or service.

IBM may have patents or pending patent applications covering subject matter described in this document. The furnishing of this document does not give you any license to these patents. You can send license inquiries, in writing, to:
IBM Director of Licensing, IBM Corporation, North Castle Drive, Armonk, NY 10504-1785 U.S.A.

The following paragraph does not apply to the United Kingdom or any other country where such provisions are inconsistent with local law: INTERNATIONAL BUSINESS MACHINES CORPORATION PROVIDES THIS PUBLICATION "AS IS" WITHOUT WARRANTY OF ANY KIND, EITHER EXPRESS OR IMPLIED, INCLUDING, BUT NOT LIMITED TO, THE IMPLIED WARRANTIES OF NON-INFRINGEMENT, MERCHANTABILITY OR FITNESS FOR A PARTICULAR PURPOSE. Some states do not allow disclaimer of express or implied warranties in certain transactions, therefore, this statement may not apply to you.

This information could include technical inaccuracies or typographical errors. Changes are periodically made to the information herein; these changes will be incorporated in new editions of the publication. IBM may make improvements and/or changes in the product(s) and/or the program(s) described in this publication at any time without notice.

Any references in this information to non-IBM Web sites are provided for convenience only and do not in any manner serve as an endorsement of those Web sites. The materials at those Web sites are not part of the materials for this IBM product and use of those Web sites is at your own risk.

IBM may use or distribute any of the information you supply in any way it believes appropriate without incurring any obligation to you.

Information concerning non-IBM products was obtained from the suppliers of those products, their published announcements or other publicly available sources. IBM has not tested those products and cannot confirm the accuracy of performance, compatibility or any other claims related to non-IBM products. Questions on the capabilities of non-IBM products should be addressed to the suppliers of those products.

This information contains examples of data and reports used in daily business operations. To illustrate them as completely as possible, the examples include the names of individuals, companies, brands, and products. All of these names are fictitious and any similarity to the names and addresses used by an actual business enterprise is entirely coincidental.

COPYRIGHT LICENSE:

This information contains sample application programs in source language, which illustrate programming techniques on various operating platforms. You may copy, modify, and distribute these sample programs in any form without payment to IBM, for the purposes of developing, using, marketing or distributing application programs conforming to the application programming interface for the operating platform for which the sample programs are written. These examples have not been thoroughly tested under all conditions. IBM, therefore, cannot guarantee or imply reliability, serviceability, or function of these programs.

Trademarks

The following terms are trademarks of the International Business Machines Corporation in the United States, other countries, or both:

Redbooks (logo) ®
eServer™
pSeries®
xSeries®
AIX 5L™
AIX®
BladeCenter®
Blue Gene®
DB2®

HACMP™
IBM®
Micro-Partitioning™
POWER™
POWER Hypervisor™
POWER3™
POWER4™
POWER5™
Redbooks®

Requisite®
RS/6000®
System i™
System p™
System p5™
Tivoli®
Virtualization Engine™
WebSphere®

The following terms are trademarks of other companies:

Oracle, JD Edwards, PeopleSoft, Siebel, and TopLink are registered trademarks of Oracle Corporation and/or its affiliates.

Andreas, and Portable Document Format (PDF) are either registered trademarks or trademarks of Adobe Systems Incorporated in the United States, other countries, or both.

i386, Intel, Intel logo, Intel Inside logo, and Intel Centrino logo are trademarks or registered trademarks of Intel Corporation or its subsidiaries in the United States, other countries, or both.

UNIX is a registered trademark of The Open Group in the United States and other countries.

Linux is a trademark of Linus Torvalds in the United States, other countries, or both.

Other company, product, or service names may be trademarks or service marks of others.

Preface

This IBM® Redbooks® publication will help the AIX® 5L™ technical community, and in particular system administrators who are well versed in the concepts and terminology of the AIX Operating System, to understand the benefits of implementing a Network Installation Manager (NIM) environment in their data center. The book applies to AIX 5L V5.3 Technology Level 5, Cluster Systems Management (CSM) V1.5.1, and IBM Director V5.1.

The concept of a *cluster* (that is, at least two IBM System p™ machines connected through a network) presents the challenge of installing, maintaining, updating and backing up the various participants in the cluster. NIM, a critical feature of AIX, can perform these tasks for your System p server farm. Using NIM, you can install or upgrade many IBM System p machines and LPARs with the same (or different) images at the same time.

This publication complements the information found in IBM technical AIX 5L manuals, and will be most useful as a reference guide.

The team that wrote this book

This book was produced by a team of specialists from around the world working at the Product and Solutions Support Center PSSC in Montpellier, France.

Dino Quintero is a Senior Certified Consulting IT Specialist, and the worldwide Technical Marketing Manager for the IBM System Blue Gene® Solution. Before joining the deep computing marketing team, he was a Clustering Project Leader for the International Technical Services Organization (ITSO). Dino worked as a Clustering Performance Analyst for the Enterprise Systems Group, focusing on industry benchmarks such as TPC-C, TPC-H, and TPC-W. He also worked as a Disaster Recovery Architect for IBM Global Services, specializing in backup and recovery solutions for large customers. Dino joined IBM in 1996, and has been part of the IT industry since 1992. His areas of expertise include enterprise backup and recovery, disaster recovery planning and implementation, and clustering architecture and solutions. He is an IBM Certified Specialist on System p Administration and System p Clustering, and is also an IBM Senior Certified IT Specialist. Currently, he focuses on planning, influencing, leading, managing, and marketing the IBM Blue Gene Solution. Dino also delivers technical lectures worldwide.

Octavian Lascu is a Project Leader at the ITSO, Poughkeepsie Center, who joined IBM in 1992. He writes extensively and teaches IBM classes worldwide on all areas of IBM System p and Linux® clusters. Before joining the ITSO, he worked in IBM Global Services Romania as a software and hardware services manager. His areas of expertise include High Performance Computing (Blue Gene/L), high availability and disaster recovery solutions, and IT security. Octavian holds a Master's degree in Electronic Engineering from the Polytechnical Institute in Bucharest. He is an IBM Certified Advanced Technical Expert in AIX/PSSP/HACMP™.

Jean-Michel Berail is an AIX Specialist at the Product and Solution Support Center (PSSC) in IBM Montpellier, France, who joined IBM 28 years ago. He has 12 years of experience with AIX, specializing in the installation, backup and migration of System p clusters. He has developed materials about clustering for education and workshops on Parallel System Support Programs (PSSP), Cluster System Management (CSM), and Network Installation Manager (NIM). He teaches CSM and NIM courses in IBM Education Centers and at customer sites. Jean-Michel has co-authored or reviewed several IBM Redbooks on PSSP, CSM and NIM. He is also a Professor of Computer Science at a Montpellier university, and is a graduate of the E.N.S.E.I.R.B. (Bordeaux, France) engineering school.

Hassan Elsetohy works for IBM in Integrated Technology Delivery in Sydney, Australia. He joined IBM in 1994 as a Systems Engineer after attaining his Bachelor of Engineering degree, and also holds a course-work Masters degree in VLSI design. He is an IBM Certified IT Architect, an IBM Certified Specialist, and an IBM Certified Advanced Technical Expert. He has also recently attained SNIA and Linux LPI certifications. Hassan has been performing the Lead IT Architect role, as well as the Method Exponent role, in major engagements. He also often performs the SME role, and has undertaken the development of detailed end-to-end designs in his areas of specialty, which include IT optimization, AIX, System p, SAN Storage, systems performance and capacity management, and disaster recovery planning. He has experience in utilizing field-proven methodologies during engagements, including the IBM GS Method, the IBT Consultancy Methodology, and the Zodiac/ALIGN Server consolidation methodologies.

Chris Gibson is a Senior AIX Systems Administrator for Insurance Australia Group (IAG), Australasia's leading general insurance provider. He has worked with UNIX® systems for more than 12 years. Since 1999, he has been involved with RS/6000®, SP, and pSeries systems running AIX. His areas of expertise include AIX 5L and NIM. He has also worked with HACMP, CSM and PSSP. He is an IBM Certified Advanced Technical Expert in pSeries and AIX 5L.

Andreas Gogolin is an IT Specialist working for HA-Business Ltd. in Germany. Previously, he was a UNIX consultant for Bechtle and Motorola. Andreas has 12

years of experience with AIX, and is an IBM Certified Specialist for AIX, System p, and open systems storage.

Markus Lang is an IT Specialist at Pulsen Systems, an IBM Premier Business Partner in Sweden. He has worked with AIX/UNIX for about 10 years. He is a Red Hat Certified Engineer, an AIX Advanced Technical Expert, and holds various other IBM/AIX certifications. Markus has worked with SP, HACMP, TSM and WebSphere®, as well as AIX/DB performance tuning, disaster recovery, kernel dump analysis, benchmarking and programming.

Sven Meissner is an IT Specialist at Bayer Business Services GmbH in Germany. He has more than 10 years of experience in AIX. His areas of expertise include planning, installation and managing of AIX environments including HMCs, CSM, and HACMP. Sven is an IBM Certified Technical Expert in pSeries Administration and Support for AIX 5L v 5.2.

Pablo Pereira is an Advisory IT Specialist working at the Service Delivery Center (SDC) in IBM Uruguay, who joined IBM in 1997. He has been working with RS/6000, SP, pSeries and storage servers since then. His areas of expertise include AIX, PSSP, HACMP, LPAR, NIM and TCP/IP. He is an IBM Certified Advanced Technical Expert in pSeries and AIX 5L. He has been teaching AIX 5L Administration, AIX 5L Performance, HACMP Administration, LPAR and Virtualization in several countries including Uruguay, Paraguay, Brazil and Argentina. He co-authored the IBM Redbooks publication *An Introduction to the New IBM eServer pSeries High Performance Switch*, SG24-6978.

Bjorn Roden is an AIX Expert from Sweden. He has worked with AIX since version 2.2.1 and 3.1, starting with his work at IBM in the late 1980s and early 1990s, and continuing today at Pulsen Systems. He has worked with most parts of AIX and SP2/PSSP, HACMP, ADSM/TSM, LPAR, and various open source software. He has been continuously IBM AIX certified since 1994, accumulating more than 30 certificates, including Advanced Technical Expert, HACMP, Enterprise and Virtualization Technical Support, and Tivoli® Storage Manager. Bjorn has co-authored the IBM Redbooks publications *RS/6000 SP System Performance Tuning Update*, SG24-5340-01, *AIX 5L Performance Tools Handbook*, SG24-6039, *Tivoli Storage Manager Version 5.1 Technical Guide*, SG24-6554, and *Linux Applications on pSeries*, SG24-6033-01. He has reviewed *IBM Certification Study Guide - pSeries HACMP for AIX*, SG24-6187, as well as *IBM System p5™ Approaches to 24x7 Availability Including AIX 5LS*, SG24-7196.

Kelvin Tan is an Advisory I/T Specialist working in ITS, IBM Singapore, who joined IBM in 2000. He has been providing support on AIX, RS/6000-SP, HACMP, Micro-Partitioning™ and Virtualization. He is an IBM @server® Certified Advanced Technical Expert in pSeries® and AIX 5L. He holds a Bachelor of Computing Engineering degree from Nanyang Technological

University. He has also co-authored the IBM Redbooks publication *Transition from PSSP to Cluster Systems Management (CSM)*, SG24-6967.

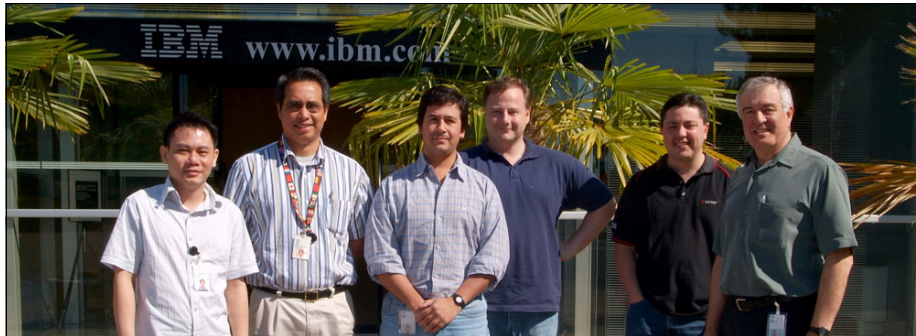

Figure 1 Team members from left: Kelvin Tan, Dino Quintero (project leader), Pablo Pereira, Bjorn Roden, Chris Gibson, Jean-Michel Berail (Octavian Lascu, Hassan Elsetohy, Andreas Gogolin, Markus Lang, Sven Miessner not shown).

Thanks to the following people for their contributions to this project:

Paul Finley, Julie Craft, Eddie Reyes, Roji John
IBM Austin

Brian Crosswell, Ning-Wu Wang, Paul Swaitocha, Linda Mellor, Margaret Moran
IBM Poughkeepsie

Guillermo Diez
IBM Uruguay

Sebastien Llaurency, Olivier Merlet
IBM France

Joefon Jann
IBM T. J. Watson Research Center

Become a published author

Join us for a two- to six-week residency program! Help write a book dealing with specific products or solutions, while getting hands-on experience with leading-edge technologies. You'll team with IBM technical professionals, Business Partners and/or customers.

Your efforts will help increase product acceptance and customer satisfaction. As a bonus, you'll develop a network of contacts in IBM development labs, and increase your productivity and marketability.

Find out more about the residency program, browse the residency index, and apply online at:

ibm.com/redbooks/residencies.html

Comments welcome

Your comments are important to us!

We want our books to be as helpful as possible. Send us your comments about this or other books in one of the following ways:

- ▶ Use the online **Contact us** review book form found at:

ibm.com/redbooks

- ▶ Send your comments in an e-mail to:

redbook@us.ibm.com

- ▶ Mail your comments to:

IBM Corporation, International Technical Support Organization
Dept. HYTD Mail Station P099
2455 South Road
Poughkeepsie, NY 12601-5400



Introduction

This chapter explains why it is beneficial to use Network Installation Manager (NIM) in your AIX 5L environment. The information in this section is aimed at AIX 5L systems administrators who are well versed in the concepts and terminology of the AIX operating system, but who also want to understand the benefits of implementing a Network Installation Manager (NIM) environment in their data center.

The concept of a *cluster* (that is, at least two IBM *@server* machines connected through a network) has existed for several years. Using a cluster implies the need for installing, maintaining, updating, and backing up the different participants of the cluster. NIM performs all of these tasks and is now a crucial feature of the AIX 5L operating system, and an important part of any IBM eServer server farm. For sites that are looking for the most efficient way of installing and/or upgrading their AIX 5L servers, NIM provides an excellent method for performing these activities and more.

The chapter covers the following topics:

- ▶ Using Network Installation Manager
- ▶ Benefits and features of NIM
- ▶ Overview of the book
- ▶ Description of the test scenarios

1.1 Using Network Installation Manager

What is Network Installation Manager (NIM), and why should you consider using it? NIM is a client/server application which uses object oriented technology. It provides an environment to install and manage AIX filesets on machines over the network. NIM provides an easy and efficient way for you to perform various installation and software maintenance tasks over several network types (such as Ethernet). Here are some examples:

- ▶ When you have more than two IBM eServer machines in your AIX 5L environment, you are working with a *cluster*, so you may be seeking a way to install and upgrade your IBM @server systems without the need for multiple CD-ROMs and tapes.
- ▶ You may be seeking a way to manage AIX 5L software installations and upgrades remotely, without actual physical access to the hardware.
- ▶ You may be seeking a standard method for maintaining several AIX 5L operating systems images across many IBM @server systems.

For all these scenarios, NIM is the tool of choice.

You could also use NIM on a large IBM @server machine, such as a p590 or p595 partitioned in several LPARs, using dedicated or virtual I/O resources. Even though a CD/DVD drive may be available to the CEC, installing and maintaining several partitions by passing along the CD/DVD drive from one LPAR to another may be time-consuming and prone to human error (incorrect software selection, for example). By using one LPAR as a NIM server and installing the other LPARs in the same CEC over a virtual network, you can save time and decrease the chance of installing incorrect or incomplete software.

1.1.1 Benefits and features of NIM

Here are some of the benefits and features offered by NIM:

- ▶ It is free! The NIM package is included in the AIX 5L CDs. There is no additional cost required for this package.
- ▶ NIM allows system administrators to install, upgrade, back up and maintain AIX 5L systems remotely. There is no need to use CDs or tapes. Physical access to the systems is no longer required (except perhaps during initial installation; in that case, Cluster Systems Management (CSM) can help—in conjunction with NIM—with the installation of remote systems, so refer to “Overview of Cluster Systems Management” on page 560).

- ▶ Multiple machines can be installed or maintained at the same time. For example, you may choose to install a specific group of systems, while at the same time apply the latest fixes to another specific group of machines.
- ▶ Multiple AIX 5L versions, Maintenance Levels (MLs) or Technology Levels (TLs) can be used in the same NIM environment. This is known as *coexistence*.
- ▶ Disaster recovery - local systems can be recovered quickly with NIM. In many cases, a system can be recovered in as little as 15 to 30 minutes. At disaster recovery sites, NIM can be deployed to quickly recover system images to disaster recovery systems without the need for AIX CDs or mksysb backup tapes.
- ▶ Systems can be installed with standard and consistent AIX 5L operating system images. By defining a standard operating environment (SOE) for your AIX 5L system images, systems can be customized to meet your specific needs and maintain a level of consistency across all AIX 5L servers.

This makes administering multiple servers much easier because the administrator deals with a similar environment (for example, the same LPPs, tools, man pages, file system/logical volume naming, utilities, and so on) across all systems.

Using this SOE image also means new system builds can be accomplished quickly using very little customization or manual labor. In some cases, new builds can be completed in under 30 minutes.

- ▶ Recovering a system backup (mksysb) from tape can be difficult when booting from CD media. You must boot off media that is at the same level as the backup (for example, AIX 5L base install CDs). If the CD media is not at an equal to or higher Technology Level than the level of the backup image being installed from tape, then unpredictable results might occur. As a result, every time a new Technology Level is released and applied to your machine, it is also necessary to immediately obtain the latest install media for that level of AIX 5L at the corresponding Technology Level.

However, if you use NIM to install, back up and recover your systems there is no need to rely on CDs or tapes to recover your system. Machines can be recovered easily using a network boot image at the correct level for that system.

It is possible to create bootable CD media from the source system, but this can be a time-consuming task involving CD/DVD media and may require additional manual tasks for handling the media (for example, sending it offsite). You can avoid this challenge by taking advantage of the flexibility of NIM.

- ▶ Cloning systems is another excellent feature of NIM which can assist you in moving from one server to another, or even from one site to another site. By

taking a backup of your operating system image, you can use NIM to reinstall this image onto another machine, potentially with different hardware (for example, from a IBM @server p650 to a IBM System p p595, which may even reside at a different physical location).

You may want to do this for several reasons, for example moving to new hardware, cloning a system to test an upgrade, or moving a server to a new data center.

There are also several new cloning features with NIM on AIX 5L V5.3 and POWER5™ that can assist you even further when migrating from earlier versions of AIX (4.3.3/AIX 5L V5.1) to AIX 5L V5.3 and POWER5 hardware.

1.2 Overview of this book

Next, we describe both the contents of this book as well as the test environment we used for the scenarios and examples.

1.2.1 The contents of this book

As previously described, NIM is designed to install and maintain machines in a cluster environment. For information about the basic concepts and configuration of NIM, refer to:

- ▶ Chapter 2, “Network Installation Manager definitions and concepts” on page 7
- ▶ Chapter 3, “Basic configuration of a Network Installation Manager environment” on page 51

For information about significant improvements introduced with AIX 5L V5.3, using simple scenarios or guidelines for best practices, refer to:

- ▶ Chapter 4, “Network Installation Manager scenarios” on page 123
- ▶ Chapter 5, “Network Installation Manager best practices” on page 409

In addition to NIM, it is useful to use a single point of control (SPOC) to fully automate, control and manage your environments, and this is provided by Cluster Systems Management (CSM). You can associate CSM with NIM to perform tasks that NIM cannot handle by itself, such as hardware control. For a description of the relationship between NIM and CSM, and for details about how to configure one of the cluster machines as CSM Management Server and NIM master, refer to:

- ▶ Chapter 6, “Cluster Systems Management and Network Installation Manager” on page 559

For a discussion of the most common problem areas in a NIM environment, as well as a brief troubleshooting methodology, refer to:

- ▶ Chapter 7, “Basic NIM problem determination and tuning” on page 565

For general guidelines about backing up and restoring a NIM master, and for information about NIM usage in other environments, such as automatic provisioning (Tivoli Provisioning Manager) and System i™, refer to:

- ▶ Appendix A, “General LPAR sizing and creation with mig2p5 tools” on page 615
- ▶ Appendix B, “Automatic provisioning NIM and Tivoli Provisioning Manager” on page 629
- ▶ Appendix C, “NIM and System i operating system installation for an AIX 5L LPAR” on page 639

1.2.2 Test environment

In order to illustrate the advantages of using NIM to install and maintain machines in a cluster environment, we have documented various scenarios. To run these scenarios, we used different IBM System p machines, as shown in Figure 1-1 on page 6.

Our environment consisted of:

- ▶ A partitionable IBM @server p670 (POWER4™) with its own HMC used for testing basic NIM operations such as:
 - Backup and restore of the NIM master
 - High availability NIM
 - AIX migrations
 - Secure NIM
 - and so forth
- ▶ A partitionable IBM System p p521 and IBM System p p520 with their respective HMCs, used for testing the VIO server features:
 - Micro-partitioning and virtual I/O resources
 - Backup and restore of the VIO server
- ▶ An IBM @server p615 used as a NIM master and server

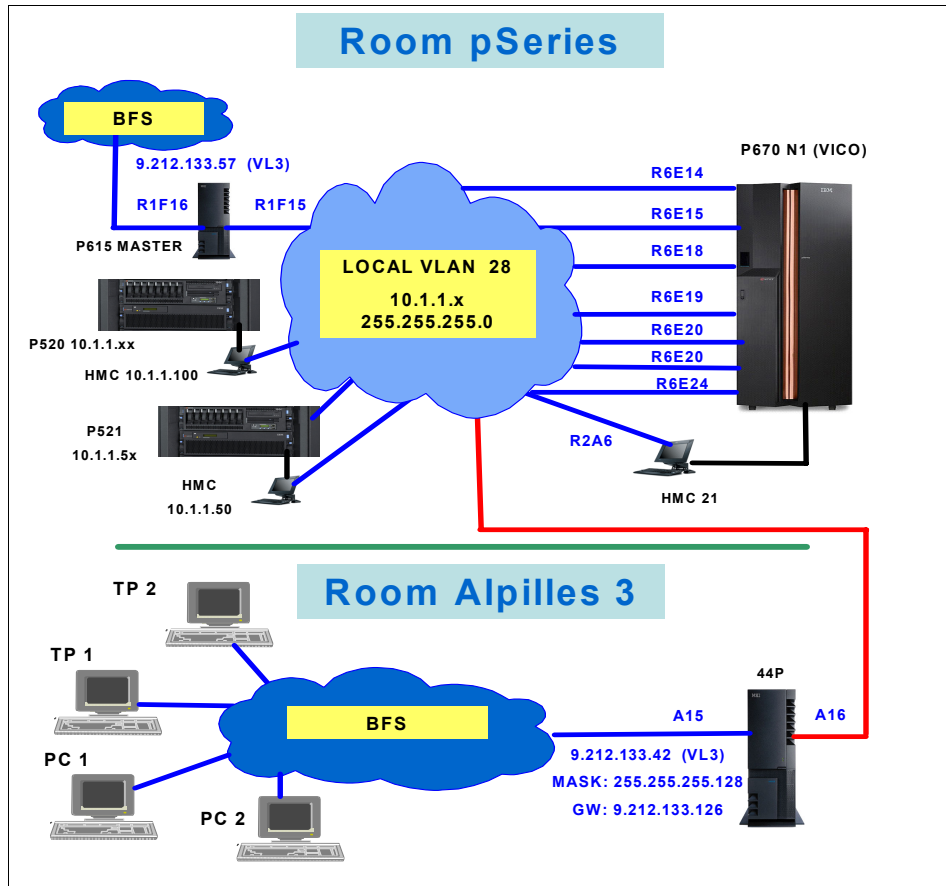

Figure 1-1 ITSO test environment diagram



Network Installation Manager definitions and concepts

This chapter presents NIM basic terminology and definitions, and also covers the basic concepts of a Network Installation Manager (NIM) environment.

These topics are also examined in *AIX 5L V5.3 Installation and Migration*, SC23-4887. However, having a practical understanding of NIM terminology and concepts is key to deploying and using a NIM environment to its full potential, so this chapter provides detailed explanations of these topics. The following topics are covered:

- ▶ Basic NIM configuration
- ▶ NIM terminology
- ▶ How a NIM environment works
- ▶ How to choose a NIM master
- ▶ Easy steps to start with NIM
- ▶ Easy steps to maintain a NIM environment
- ▶ What is new in NIM for AIX 5L

2.1 Basic NIM configuration

In the following sections, we describe the basic NIM configuration. After providing a general overview of what is behind NIM, we define the key terminology used in a NIM environment, and finish by presenting a basic setup of a NIM environment.

The NIM application

As previously mentioned, NIM is a client/server application which uses object oriented technology. It provides an environment to install and manage AIX filesets (base operating system, Maintenance Levels, individual fixes, and so on) on machines over the network. Here we describe an overview of what NIM needs to work properly, and how NIM uses its different components.

2.1.1 NIM overview

A basic NIM environment consists of several IBM System p machines (at least two) connected via a TCP/IP network. A physical network can be shared by several NIM environments, therefore the machines attached to the same physical network can be part of several NIM environments.

Note: A NIM environment is a logical group of machines, and multiple NIM environments can share the same TCP/IP network. However, one machine can be part of only one NIM environment a time, and there can be only one active NIM master per environment.

The machines (or clients) can be standalone systems, LPARs, diskless, and dataless clients (also known as “thin clients”). The machines can be controlled by one (or more) Hardware Service Console (better known as a Hardware Management Console, or HMC), or be standalone machines without a HMC.

Your first task is to determine which machine or LPAR will be the NIM master. This machine will need some disk space, a good network connection and spare CPU cycles; more details about these considerations are provided later in this chapter. The other machines (or LPARs) are then considered potential NIM clients.

Next, you must decide which machines will serve the NIM resources. In complex environments (those with multiple clients or a complex network), “stuffing” all resources on the same machine (the NIM master) may result in having it become a bottleneck, or—even worse—a security exposure. You can avoid this situation by distributing NIM resources on several other standalone machines or LPARs (see “Resources class” on page 14 for further details).

Finally, there are three basic machine roles in a NIM environment: the master, the client (NIM “machine”), and the resource server. The resource server can be either the NIM master or a standalone machine (a system that has its own local copy of the AIX operating system).

Note: The master and client (machines) can be explicitly defined via SMIT menus. However, the resource server is actually tied to the concept of NIM resource, and it cannot be explicitly defined as an entity through SMIT.

Figure 2-1 gives a general picture of two NIM environments sharing the same physical network. We can easily recognize the three machine categories (master, client and resource server) and two NIM environments. Also, two machines are not yet part of a NIM environment.

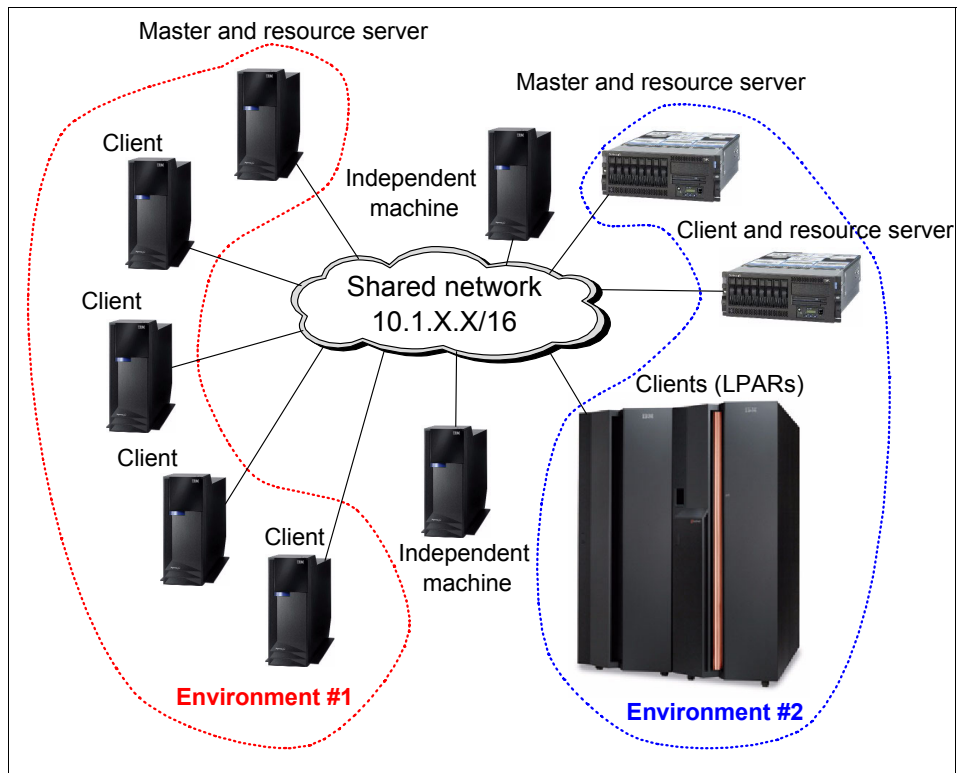

Figure 2-1 NIM environment overview

Your starting point, as mentioned, is to decide which machine is the master. Refer to 2.1.4, “NIM master selection” on page 26 for general information about how to choose this machine.

NIM terminology

Next, we provide definitions of NIM terminology to help you understand the naming conventions used in this book.

Master

Master refers to the machine where you set up and maintain your NIM environment. You can also initiate installations from here (push mode). It is the key piece of the NIM environment. Refer to 2.1.4, “NIM master selection” on page 26, for information about how to choose a machine to become the NIM master.

Client

The NIM client can be the target for NIM master-initiated operations such as installation, updates, and so forth (push mode). Also, a client can initiate its own installation or update (pull mode). A NIM client automatically becomes a resource server when it holds NIM resources.

Resource server

Any machine (the master or a standalone client) can be configured by the master as a server for a particular software resource. In most environments, the master is also resource server.

If other machines are already reporting to the master and they are installed (AIX), you can choose one of them to act as a resource server, thus relieving the NIM master of the heavy I/O load (disk and network). In such cases, the NIM master is only used to run administrative tasks.

Tip: If your environment has many nodes or consists of a complex network environment, you may want to configure standalone clients to act as resource servers, for performance and security reasons.

Push and pull modes

The *push* mode operation is initiated from the *master*. The *pull* mode operation is initiated from the *client*. The very first time a client is installed, only the pull mode can be used. Note the following points:

- ▶ In order for the push mode to be successful, the client must have a minimum AIX image already installed and TCP/IP configured.
- ▶ To use the pull mode, you need access to the clients' SMS menu. For this you either need a console attached to the machine, or for HMC-managed systems, you need access to the HMC.

Figure 2-2 on page 11 illustrates the push and pull modes for NIM operations.

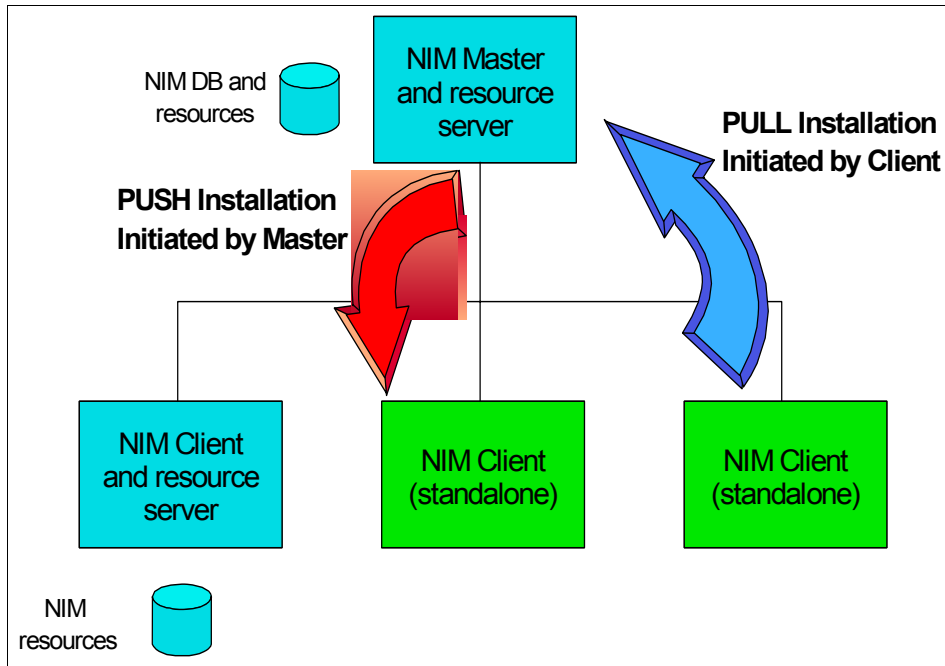

Figure 2-2 Push and pull modes

NIM database

The NIM database is stored in the AIX Object Data Management (ODM) repository on the NIM master and is divided into four classes: machines, networks, resources, groups. These classes are listed in Table 2-1.

Table 2-1 The four NIM classes and their main used types

Machines	Network	Resources	Groups
master	ent	lpp_source	mac_group
standalone	tok	spot	res_group
diskless	fddi	mksysb	
dataless	atm	bosinst_data	
alternate_master	generic	script	
		image_data	
		installp_bundle	
		

To illustrate the contents of this NIM database, we use the `lsnim` command to extract the content (on a NIM master that is already set up and working), as shown in Example 2-1.

Example 2-1 Output of lsnim command

```
{nimmast}:/ # lsnim
master          machines       master
boot            resources     boot
nim_script      resources     nim_script
NET_EN1         networks      ent
LPP_53_ML4      resources     lpp_source
SPOT_53_ML4     resources     spot
BID_NP_HD0      resources     bosinst_data
LPAR1           machines      standalone
LPAR2           machines      standalone
LPAR3           machines      standalone
LPAR4           machines      standalone
LPAR5           machines      standalone
LPAR6           machines      standalone
LPAR123456      groups        mac_group
nimgrp          groups        mac_group
spotaix5104     resources     spot
lpp_sourceaix5204 resources     lpp_source
spotaix5204     resources     spot
AllDevicesKernels resources     installp_bundle
```

Example 2-2 and Example 2-3 on page 13 provide details about each of the four classes represented in the NIM database. We start with the Machines class, followed by the Networks class and Resources class, and end with the Groups class.

Machines class

Example 2-2 gives an example of the output of the `lsnim -c machines` command.

Example 2-2 Example of lsnim -c machines command

```
{nimmast}:/ # lsnim -c machines
master          machines       master
LPAR1           machines      standalone
LPAR2           machines      standalone
LPAR3           machines      standalone
LPAR4           machines      standalone
LPAR5           machines      standalone
LPAR6           machines      standalone
VI01           machines      standalone
VLPAR1          machines      standalone
VLPAR2          machines      standalone
```

```
VLPAR3      machines      standalone
VLPAR4      machines      standalone
LPAR4_p5    machines      standalone
v1par1      machines      alternate_master
VLPAR6      machines      standalone
{nimmast}:/ #
```

The first column lists the NIM names; the second column lists the class name (only machines, in this example); the third column lists the type names related to this class name.

To see detailed client information, run the `lsnim -l <client_name>` command. Example 2-3 shows the output of the command `lsnim -l LPAR3`.

Example 2-3 Output of the `lsnim -l <client_name>` command

```
{nimmast}:/ # lsnim -l LPAR6
LPAR6:
  class      = machines
  type       = standalone
  connect    = shell
  platform   = chrp
  netboot_kernel = mp
  if1        = NET_EN1 lpar6 0
  cable_type1 = tp
  Cstate     = ready for a NIM operation
  prev_state = in the process of booting
  Mstate     = not running
  cpuid      = 001A85D24C00
  Cstate_result = success
  current_master = nimmast
  sync_required = yes
{nimmast}:/ #
```

The Cstate field determines whether the machine object is in use. If the Cstate value does not display ready for a NIM operation, you cannot perform any operation on this object.

Important: The status shown in the Mstate field may not be accurate, because it depends on whether NIM handled the latest shutdown or reboot.

Networks class

The network is what allows the machines in a NIM environment to communicate with each other. If the network is a simple local area network (LAN), the definition of the network object is simplified. The purpose of the network object is

to depict the network topology used by the NIM environment. Each modification made on the physical network must be reflected to the NIM database.

Example 2-4 gives an example of the output of the `lsnim -c networks` command.

Example 2-4 Example of `lsnim -c networks` command

```
{nimmast}:/ # lsnim -c networks
NET_EN1     networks     ent
{nimmast}:/ #
```

Note: NIM supports multiple network types, such as Standard Ethernet, IEEE 802.3 Ethernet, Token-Ring, FDDI, ATM, and Generic. The network type determines how certain NIM operations are handled. For example, network boot is only supported on Standard Ethernet, Token-Ring and FDDI.

In our environment we use only one network type, Standard Ethernet.

To see the details of a particular NIM network object, run the `lsnim -l <network_name>` command, as shown in Example 2-5.

Example 2-5 Output of the `lsnim -l <network_name>` command

```
{nimmast}:/ #
{nimmast}:/ # lsnim -l NET_EN1
NET_EN1:
  class      = networks
  type       = ent
  Nstate     = ready for use
  prev_state = information is missing from this object's definition
  net_addr   = 10.1.1.0
  snm        = 255.255.255.0
{nimmast}:/ #
```

The `Nstate` field determines whether the network object is in use. If the `Nstate` value displayed is different from `ready` for a NIM operation, you cannot perform any operation on this object.

Resources class

A NIM resource is a pointer to a file or a directory located on a Resource Server, and the NIM Master is the default Resource Server. For example, the `bosinst_data` resource points to a file that contains information used to perform the installation process without requiring any manual intervention. The basic characteristics of a resource are the NIM name, the location (the location of the file or directory), and the resource server hosting the resource. Example 2-6 shows a list of resources.

Example 2-6 lsnim -c resources command output

```
{nimmast}:/ # lsnim -c resources
boot                resources      boot
nim_script          resources      nim_script
LPP_53_ML4          resources      lpp_source
SPOT_53_ML4         resources      spot
BID_NP_HD0          resources      bosinst_data
spotaix5104         resources      spot
lpp_sourceaix5204   resources      lpp_source
spotaix5204         resources      spot
spot5304            resources      spot
lpp_sourceaix5104   resources      lpp_source
lpar1nim-mksysb     resources      mksysb
exclude_lpar5       resources      exclude_files
MK_LPAR6_AIX530403  resources      mksysb
MKSYSB_VI012_53_ML3 resources      mksysb
MK_AIX5104          resources      mksysb
mksysb_lpar5c       resources      mksysb
mksysb_lpar5d       resources      mksysb
AIXTFLINUX         resources      lpp_source
BID_NP_HD0_MKMIG    resources      bosinst_data
nim_move_up_bid     resources      bosinst_data
nim_move_up_exclude resources      exclude_files
LPAR4_phys_mksysb   resources      mksysb
LPAR4_p5_mksysb     resources      mksysb
{nimmast}:/ #
```

Example 2-7 shows the details of a resource retrieved using the `lsnim -l <resource_name>` command. Notice the location and server attributes, which determine where the resource is located.

Example 2-7 Resource details

```
{nimmast}:/ # lsnim -l BID_NP_HD0
BID_NP_HD0:
  class      = resources
  type       = bosinst_data
  Rstate    = ready for use
  prev_state = unavailable for use
  location = /other_res/bid.np.hd0
  alloc_count = 0
  server    = master
{nimmast}:/ #
```

The location and the server are well identified. In this case, the server is the master.

Note: Another important attribute is Rstate (for “resource state”). The status shown determines whether the object is currently in use or not. If the Rstate is not `ready`, it cannot be used and a warning message will appear on the console.

Groups class

A *group* is a collection of either machines or resources. Only two types are available:

- ▶ `res_group`, for grouping a set of resources
- ▶ `mac_group`, for grouping a set of machines

Example 2-8 shows the output of the command `lsnim -c groups`.

Example 2-8 Listing NIM groups

```
{nimmast}:/ # lsnim -c groups
LPAR123456      groups      mac_group
nimgrp          groups      mac_group
res_53_m13     groups      res_group
```

2.1.2 How a NIM environment works

Now that you know *what* NIM consists of, you need to understand *how* NIM works—in particular, how NIM uses different components of the operating system to fulfill its duties. This section describes the most commonly used resources and their utilization. A basic diagram of how NIM installation works is shown in Figure 2-3 on page 17.

To start a machine installation, only two resources are mandatory: the LPP source (`lpp_source`), and the Shared Product Object Tree (SPOT). However, to avoid using manual intervention during the installation process, additional resources providing information for the `AIX_install` process can be used (that is, `bosinst_data`, `image_data`, and `script`).

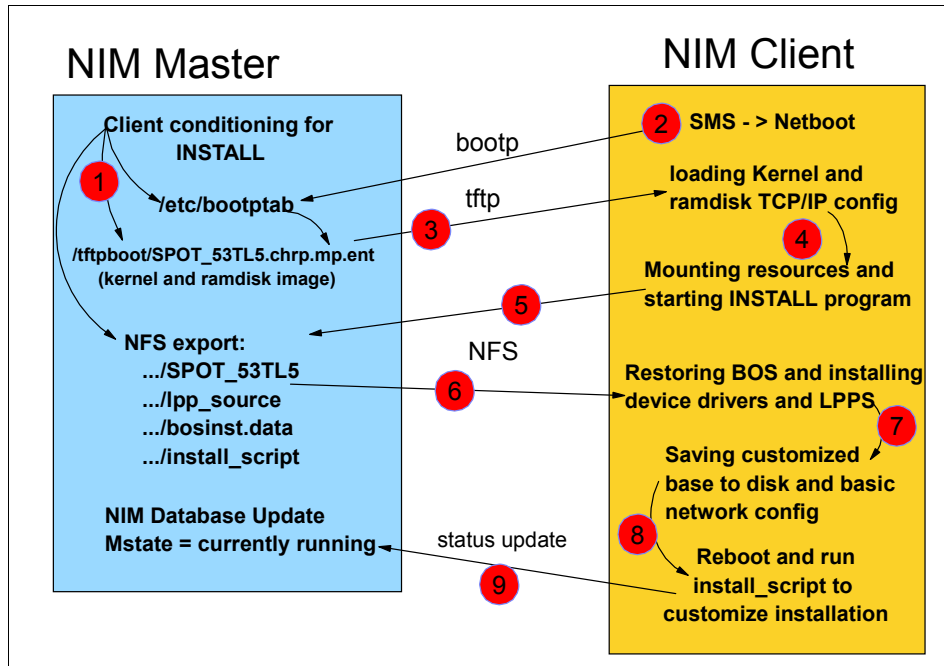

Figure 2-3 How NIM installation works

The following list presents the basic resources needed for installing machines in your environment:

► **SPOT**

SPOT, or Shared Product Object Tree, is a directory of code (installed filesets) that is used during client booting procedure. It is equivalent in content to the code that resides in the /usr file system on a system running AIX 5L (binary objects - executables and libraries, header files and shell scripts). This resource (directory) replaces the content of the basic ramdisk image available on installation CDs.

Remember: The installation is performed over a network, and there are no AIX CDs available. Device drivers, the BOS install program, and other necessary code needed to perform a base operating system installation are found inside the SPOT.

During the installation, the client machine NFS mounts this resource in order to access the code needed for the installation process.

The SPOT also contains the code needed to generate the boot images (kernels, which will be stored in the /tftpboot directory) that the client uses until it can manage to NFS-mount the SPOT directory.

Note: Multiple boot images can exist in the /tftpboot directory. Maintaining multiple smaller boot images helps you to save time when transferring the files via TFTP to the client.

Also, because the number of kernels (boot images) in the /tftpboot directory may increase if you add new operating system levels, we recommend that you to create a separate file system for the /tftpboot directory.

A general structure of a non-/usr SPOT directory is illustrated in Figure 2-4.

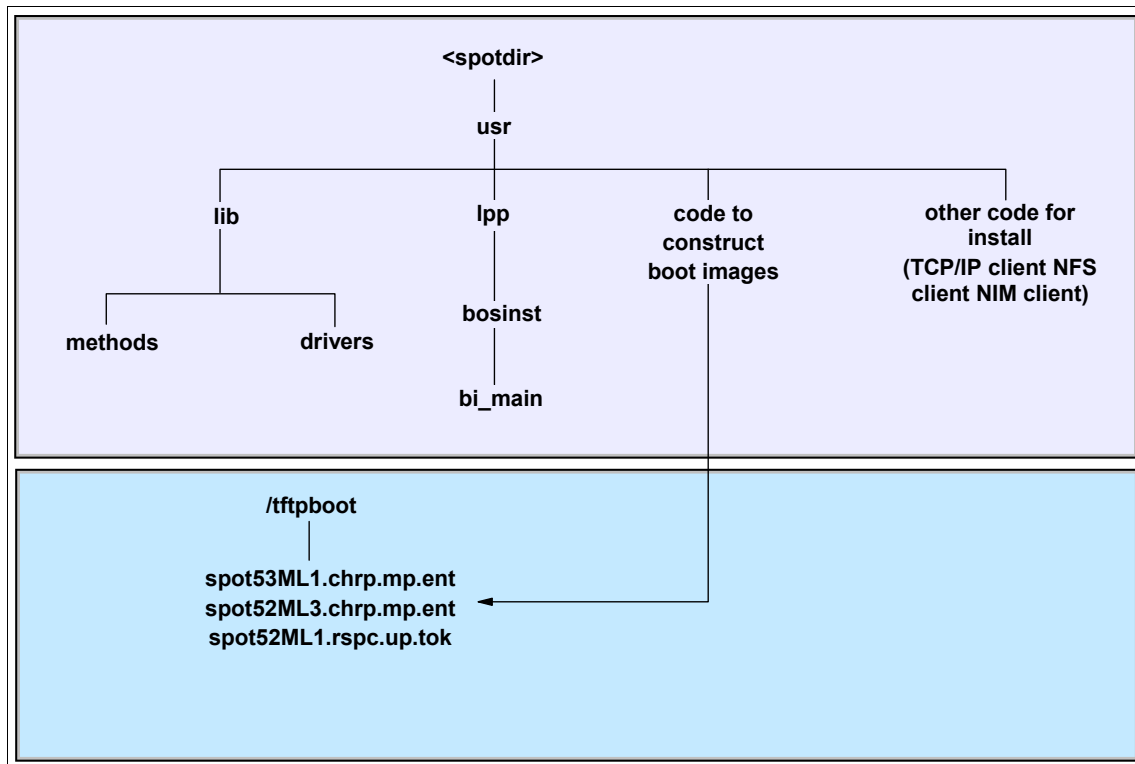

Figure 2-4 General non-/usr SPOT structure

As mentioned, the NIM database consists of several *classes*. Classes also consist of *types*. For example, the resources class consists of several resource types such as spot, lpp_source, and so on.

By running the `lsnim -t spot` command, you can list the different available SPOT resources. Output of the `lsnim -t spot` command is shown in Example 2-9.

Example 2-9 Example of `lsnim -t spot` command

```
{nimmast}:/ #
{nimmast}:/ # lsnim -t spot
SPOT_53_ML4      resources      spot
spotaix5104     resources      spot
spotaix5204     resources      spot
spot5304        resources      spot
{nimmast}:/ #
```

Example 2-10 shows the details of a particular SPOT resource.

Example 2-10 Details of a particular spot resource

```
{nimmast}:/ #
{nimmast}:/ # lsnim -l SPOT_53_ML4
SPOT_53_ML4:
  class      = resources
  type       = spot
  plat_defined = chrp
  arch       = power
  bos_license = yes
  Rstate     = ready for use
  prev_state = verification is being performed
  location   = /AIX53ML4/SPOT_53_ML4/usr
  version    = 5
  release    = 3
  mod        = 0
  oslevel_r = 5300-04
  alloc_count = 1
  server     = master
  if_supported = chrp.mp ent
  Rstate_result = success
{nimmast}:/ #
```

Notes:

- ▶ One of the details returned by the `oslevel -r` command by `lsmim -l <spot_resource_name>` is the AIX level. In our example, this is 5300-04. It is important to know the operating system level when you want to install a client, because the levels of the SPOT resource and mksysb resource should match.
- ▶ If the SPOT and mksysb are not at the same level, installation will only work if the SPOT is at a higher level than the mksysb. However, after the mksysb installation, the level of the system just installed will be updated to match the level of the SPOT using the `lpp_source` object, which also needs to be allocated for the installation.

▶ lpp_source

An `lpp_source` is a directory similar to AIX install CDs. It contains AIX Licensed Program Products (LLPs) in Backup File Format (BFF) format and RPM Package Manager (RPM) filesets that you can install. For more information about RPM, see:

<http://www.rpm.org>

General structure of the `lpp_source` directory is shown in Figure 2-5 on page 21.

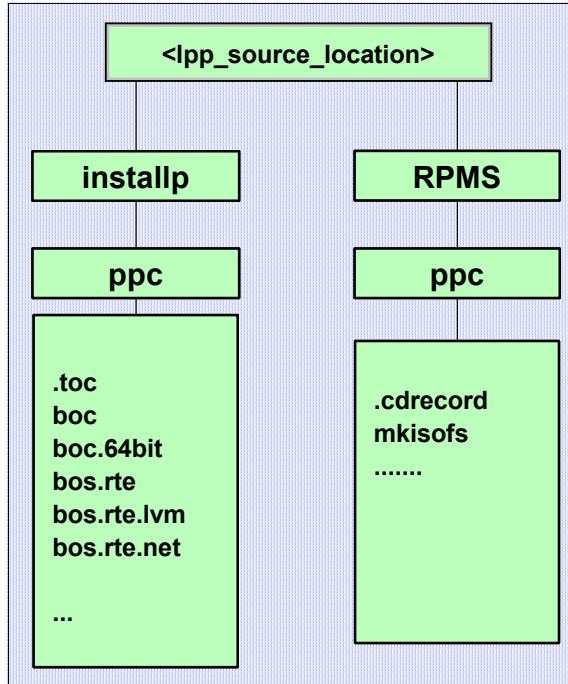

Figure 2-5 *lpp_source* structure

Notes:

- ▶ The AIX `installp` command can handle both AIX installable package files; that is, Backup File Format (BFF) and RPM Package Manager (RPM).
- ▶ The `.toc` file (only found in directories containing BFF packages) *must* be kept up-to-date to reflect the latest filesets in the `lpp_source`.

Example 2-11 shows the various `lpp_source` type resources (using the `lsnim -t lpp_source` command).

Example 2-11 *Example of `lsnim -t lpp_source` command*

```

{nimast}:/ #
{nimast}:/ # lsnim -t lpp_source
LPP_53_ML4          resources      lpp_source
lpp_sourceaix5204  resources      lpp_source
lpp_sourceaix5104  resources      lpp_source
AIXTFLINUX         resources      lpp_source
{nimast}:/ #
  
```

Example 2-12 shows the attributes of one of the lpp_source resource.

Example 2-12 Details of a particular lpp_source resource

```
{nimmast}:/ # lsrim -l LPP_53_ML4
LPP_53_ML4:
  class      = resources
  type       = lpp_source
  arch       = power
  Rstate     = ready for use
  prev_state = ready for use
  location   = /AIX53ML4/LPP_53_ML4
  simages   = yes
  alloc_count = 1
  server     = master
{nimmast}:/ #
```

Important: The simages attribute, when set to *yes*, means that the lpp_source resource contains the necessary filesets to support a base operating system type rte (for Run-Time Environment) installation. The simages attribute is set to yes for an lpp_source resource that contains a minimum set of install images (LPPs) necessary to support the creation of a SPOT resource, or to support the installation of the AIX operating system over the network.

For more information for the minimum list, refer to the following script:

```
/usr/lpp/bos.sysmgt/nim/methods/c_sh_lib
```

► **mksysb**

This resource is a file containing the image of the root volume group (generated with the AIX **mksysb** command) of a machine. It is used to restore a machine, or to install it from scratch (also known as “cloning” a client).

A mksysb resource can be defined by first creating the mksysb image with SMIT or the **mksysb** command, and then defining the resource that references the backup image file.

A mksysb resource can also be defined using CLI:

```
nim -o define -t mksysb -a source=<client_to_backup> -a
server=master -a location=<location to store file> RESOURCE_NAME
```

Example 2-13 shows the different mksysb resources that are part of our NIM environment.

Example 2-13 Example of lsrim -t mksysb command

```
{nimmast}:/ # lsrim -t mksysb
lpar1nim-mksysb      resources      mksysb
```

MK_LPAR6_AIX530403	resources	mksysb
MKSYSB_VIO12_53_ML3	resources	mksysb
MK_AIX5104	resources	mksysb

Example 2-14 shows the detail of one particular mksysb resource.

Example 2-14 Details of a particular mksysb resource

```
{nimmast}:/ # lsnim -l MK_LPAR6_AIX530403
MK_LPAR6_AIX530403:
  class      = resources
  type       = mksysb
  arch       = power
  Rstate     = ready for use
  prev_state = unavailable for use
  location   = /export/images/mk_lpar6_aix530403
  version    = 5
  release    = 3
  mod        = 0
  oslevel_r = 5300-04
  alloc_count = 0
  server     = master
{nimmast}:/ #
```

Note: One of the attributes shown by the `lsnim -l <mksysb_resource_name>` command is the AIX 5L level. This value is actually the one returned by the `oslevel -r` command on the client from which the image has been retrieved (5300-04, in our case).

It is important to know this value when you want to install a client because the levels of the SPOT resource and mksysb resource should match.

► **bosinst_data**

The `bosinst_data` resource is a flat ASCII file similar to the `bosinst.data` file used for restoring system backup images from tape or CD/DVD. When you start the installation of an IBM System p machine, you will be prompted to select the console, language, installation method, the target disk(s) for rootvg, and so on. This resource comes in handy for both push or pull installation of multiple machines at the same time, because it will automate the installation process without requiring interactive answers for the installation parameters.

Example 2-15, Example 2-16 on page 24, and Example 2-17 on page 24 provide the different elements related to a `bosinst_data` resource.

Example 2-15 bosinst_data resources

```
{nimmast}:/ # lsnim -t bosinst_data
BID_NP_HDO          resources      bosinst_data
```

```

BID_NP_HDO_MKMIG    resources    bosinst_data
nim_move_up_bid     resources    bosinst_data
{nimmast}:/ #

```

Example 2-16 Details of a bosinst_data resource

```

{nimmast}:/ # lsnm -l BID_NP_HDO
BID_NP_HDO:
  class      = resources
  type       = bosinst_data
  Rstate    = ready for use
  prev_state = unavailable for use
  location = /other_res/bid.np.hd0
  alloc_count = 0
  server   = master
{nimmast}:/ #

```

Example 2-17 Sample content - a bosinst.data file

```

control_flow:
  CONSOLE = /dev/lft0
  INSTALL_METHOD = overwrite
  PROMPT = no
  EXISTING_SYSTEM_OVERWRITE = yes
  INSTALL_X_IF_ADAPTER = yes
  RUN_STARTUP = yes
  RM_INST_ROOTS = no
  ERROR_EXIT =
  CUSTOMIZATION_FILE =
  TCB = no
  INSTALL_TYPE =
  BUNDLES =
  SWITCH_TO_PRODUCT_TAPE =
  RECOVER_DEVICES = Default
  BOSINST_DEBUG = no
  ACCEPT_LICENSES = yes
  DESKTOP = NONE
  INSTALL_DEVICES_AND_UPDATES = yes
  IMPORT_USER_VGS =
  ENABLE_64BIT_KERNEL = yes
  CREATE_JFS2_FS = yes
  ALL_DEVICES_KERNELS = yes
  GRAPHICS_BUNDLE = yes
  MOZILLA_BUNDLE = no
  KERBEROS_5_BUNDLE = no
  SERVER_BUNDLE = no
  ALT_DISK_INSTALL_BUNDLE = no
  REMOVE_JAVA_118 = no
  HARDWARE_DUMP = yes

```

```
ADD_CDE = no
ADD_GNOME = no
ADD_KDE = no
ERASE_ITERATIONS = 0
ERASE_PATTERNS =
MKSYSB_MIGRATION_DEVICE =
```

locale:

```
BOSINST_LANG = en_US
CULTURAL_CONVENTION = en_US
MESSAGES = en_US
KEYBOARD = en_US
```

target_disk_data:

```
PVID =
PHYSICAL_LOCATION =
CONNECTION =
LOCATION =
SIZE_MB =
HDISKNAME = hdisk0
```

Note: The highlighted parameters in Example 2-17 are the minimum mandatory parameters necessary to perform an installation without a manual entry.

► **script**

The script resource is a file. After the BOS installation is finished on your client, you can perform customization such as file system resizing, additional user creation, and so forth. The script resource points to a file (usually a shell script) that contains all the commands needed to perform customization.

2.1.3 Before working with a NIM environment

Now that you are aware of the various components of a NIM environment, we cover the considerations needed to you build your NIM cluster.

For simplicity, we can say that NIM has two basic elements: AIX and the network. If one of them is not working properly, NIM does not function and its behavior can be erratic. Chapter 7, “Basic NIM problem determination and tuning” on page 565 describes basic problem determination scenarios. But here we introduce a few common troubleshooting examples for problems you may

encounter when working with a NIM environment, even if they are not directly related to NIM.

Background needed

Prior to working with NIM, you should become familiar with the environment and possess basic AIX system administration and problem determination skills in the areas of AIX 5L-related issues and network-related issues. We highlight these areas here:

AIX 5L-related issues

- ▶ A file system becomes full when you are creating a new lpp_source resource.
- ▶ A file system becomes full when you are creating a new mkysyb resource.
- ▶ The file limit is set to 2 GB, but the actual backup file is larger (either on the NIM master or on the NIM clients to be backed up).
- ▶ A file that is part of, or configured as, a resource does not have the right permissions.
- ▶ An lpp_source's table of contents file (.toc) file has not been updated.

Network-related issues:

- ▶ The physical network connection not working properly.
- ▶ Network parameters related to a specific adapter (speed, duplex) are not consistent across systems and network elements.
- ▶ Name resolution not working properly (there are duplicate addresses in the /etc/hosts file; a mix of long names and short names; and so on).

Next, we discuss a method to help you build a NIM environment.

2.1.4 NIM master selection

Choosing the machine that will become the NIM master is perhaps the most important step in building a reliable NIM environment. Before you start working with NIM, ensure that your network is up and running. Then, among the available machines, select the one that will become the NIM master.

To help you make this decision, you can use the following criteria:

- ▶ The machine that will become the NIM master must have AIX installed.

Important: The NIM master should always have the highest version of AIX installed across the entire NIM environment. Using the same AIX level for master and client is acceptable.

- ▶ The NIM master machine must *not* be a production workload machine, because you will have to regularly shut down the NIM master machine to perform AIX upgrades.
- ▶ Most people have the NIM master as a separate dedicated purpose machine or LPAR, so the maintenance of the images and its AIX version does not affect other workloads.
- ▶ A micro-partition (POWER5 or above machine using a shared processor LPAR) is ideal because the NIM master does not use a lot of CPU cycles. However, others prefer to use a separate machine (perhaps a machine from previous hardware generation that is available after an upgrade) as the NIM master machine.
- ▶ Some customers use the NIM master for other system administration tasks like performance monitoring, an operations Web server, and an NFS source of useful tools.
- ▶ Regardless of the network complexity, the number of network adapters in your NIM environment must be planned.

Note: If you have a simple network with all machines on a single segment and a single IP address range, then only one network adapter is required.

- ▶ The disk space must be estimated and compared to any existing resources. There are no official guidelines because NIM environments may vary.

Table 2-2 lists considerations for planning disk space for your NIM master. The two largest resources to consider are the `lpp_source` and the `mksysb` backups.

Keep in mind that a client can become a NIM resource server. Therefore, all disk space information related to this resource must be taken into account for the disk space planning of this machine. See Table 2-2 for average figures for the main files or directories needed by NIM.

Table 2-2 Average recommended values for disk space estimation

Item	Recommended size	Location	Comments
<code>lpp_source</code>	3 GB per AIX version or TL	Set by the administrator	The size of an <code>lpp_source</code> for base install is less than 1 GB per AIX version or TL. It will be more if there are optional <code>lpp_source</code> filesets.
<code>spot</code>	1 GB per AIX version or TL	Set by the administrator	N/A

Item	Recommended size	Location	Comments
mksysb	4 GB	Set by the administrator	This figure is an average. Generally, the size can be between 1 GB (for a basic rte install) to 6GB or 7 GB for a running machine.
other	1GB	Set by the administrator	Used to put other resources, such as bosins_data, scripts and so on. The size of the basic space is negligible.

Notes:

1. Volume groups backups for non-rootvg volume groups are not shown in Table 2-2 on page 27. If you are using NIM to also back up user volume groups, add their space requirements.
2. Consider additional space for future growth.

As an example, two releases of AIX (5.2 and 5.3) with three Maintenance Levels each, 10 mksysb images from production machines and three generations of these require the following disk space:

$$3 \times 6 + 1 \times 6 + 4 \times 10 \times 3 + 1 = 145 \text{ GB as a minimum}$$

After you select your NIM master machine or LPAR, you can refer to the following section for an explanation of what you need to do to set up a basic NIM environment.

2.1.5 Easy steps to start with NIM

In this section, we list the steps to start a NIM environment.

Note: At this point, no NIM definition or object has been yet created, and the objective is to install a system over the network. But first, this system has to become a client to a NIM environment. You only know that one machine will become the NIM master, and that the others will be clients.

Step 1: Select a machine to be the master

Refer to 2.1.4, “NIM master selection” on page 26 for guidance about making this decision.

Step 2: Install AIX for the NIM master

Install a completely fresh copy of the latest AIX release and level you have, to avoid inheriting problems. It is recommended you start with the highest possible AIX level to avoid having to update it later on.

Step 3: Check the software requirements

The following steps are used to satisfy the minimum requirements for your NIM master:

- ▶ The level of AIX 5L that is installed on the NIM master
`oslevel -r` or `oslevel -s`
- ▶ Available disk space
`lspv` and `lsattr -E1 hdisk*`
- ▶ Network adapters
`lscfg` and `netstat -in`

Step 4: Install these NIM filesets

The following NIM filesets must be installed:

- ▶ `bos.sysmgt.nim.master`
- ▶ `bos.sysmgt.nim.spot`

Note: The fileset `bos.sysmgt.nim.spot` is required when you want to allow a client server to serve SPOT resources. This fileset is optional, but should be installed if you are planning to work with thin servers (diskless or dataless clients).

- ▶ SMIT panels are shown in Example 2-18, Example 2-19 on page 30, Example 2-20 on page 31, Example 2-21 on page 32 and Example 2-22 on page 33.

In Example 2-18 we use the AIX CD for TL4 to install the NIM LPPs. We start using the `smitty install_latest` fastpath and select `/dev/cd0` as install source, then select the NIM packages from the list.

Example 2-18 SMIT panel to install NIM filesets

```
                                Install Software
                                Type or select values in entry fields.
                                Press Enter AFTER making all desired changes.

                                [Entry Fields]
* INPUT device / directory for software      /dev/cd0
* SOFTWARE to install                        [@ 5.3.0.40 Network I> +
```

PREVIEW only? (install operation will NOT occur)	no	+
COMMIT software updates?	yes	+
SAVE replaced files?	no	+
AUTOMATICALLY install requisite software?	yes	+
EXTEND file systems if space needed?	yes	+
OVERWRITE same or newer versions?	no	+
VERIFY install and check file sizes?	no	+
Include corresponding LANGUAGE filesets?	yes	+
DETAILED output?	no	+
Process multiple volumes?	yes	+
ACCEPT new license agreements?	no	+
Preview new LICENSE agreements?	no	+

F1=Help	F2=Refresh	F3=Cancel	F4=List
F5=Reset	F6=Command	F7=Edit	F8=Image
F9=Shell	F10=Exit	Enter=Do	

Note: This is a straightforward step to perform. It is a standard AIX fileset installation. The highlighted values must be entered according to your environment.

Step 5: Configure the selected machine as a NIM master

In our configuration we use the **smitty nimconfig** fastpath as shown in Example 2-19. Other tools, such as EZNIM, are detailed in 3.3, “EZNIM” on page 115.

Example 2-19 SMIT panel to configure an AIX machine as a NIM master

Configure Network Installation Manager Master Fileset

Type or select values in entry fields.
Press Enter AFTER making all desired changes.

	[Entry Fields]	
* Network Name	[NET_ENO]	
* Primary Network Install Interface	[en0]	+
Allow Machines to Register Themselves as Clients?	[yes]	+
Alternate Port Numbers for Network Communications (reserved values will be used if left blank)		
Client Registration	[]	#
Client Communications	[]	#

F1=Help	F2=Refresh	F3=Cancel	F4=List
F5=Reset	F6=Command	F7=Edit	F8=Image
F9=Shell	F10=Exit	Enter=Do	

Note: The highlighted values must be entered according to your environment.

Step 6: Creating the file systems for NIM

As explained in 2.1.2, “How a NIM environment works” on page 16, the lpp_source and the SPOT resources are directories and the related file systems must be created. Refer to Table 2-2 on page 27 for sizing information.

Step 7: Defining basic resources

First define the lpp_source resource, followed by the SPOT. The lpp_source resource is a directory containing installable filesets. Use the **smitty nim_mkres** fastpath, select lpp_source, and enter the required values in the input screen shown as shown in Example 2-20.

Notes:

- ▶ You can also consider creating the basic resources using the following steps: **smitty nim-> Configure the NIM Environment-> configure a Basic NIM Environment (Easy Startup)** to create the lpp_source and SPOT together, instead of creating individual resources.
- ▶ We suggest that you create the lpp_source first from CD, then use it to create the SPOT. This way you use the CD only once, thus reducing the time for creating the SPOT.

Example 2-20 SMIT panel to define an lpp_source resource

Define a Resource

Type or select values in entry fields.
Press Enter AFTER making all desired changes.

```
[Entry Fields]
* Resource Name           [LPP_53_ML4]
* Resource Type           lpp_source
* Server of Resource      [master]           +
* Location of Resource    [/nim/aix53m14/lppsour> /
Architecture of Resource []           +
Source of Install Images [cd0]         +/
Names of Option Packages []
Show Progress            [yes]           +
Comments                 []

F1=Help      F2=Refresh  F3=Cancel   F4=List
F5=Reset     F6=Command  F7=Edit     F8=Image
```

Note: The highlighted values must be entered according to your environment. Remember to check the `simages` attribute of the newly created `lpp_source` resource by executing the `lsnim -l <lpp_source_name>` command.

After the `lpp_source` resource is created, define the SPOT resource. Use `smitty nim_mkres` and select **spot**. Then enter the information in the SMIT panel as shown in Example 2-21.

Example 2-21 SMIT panel to define a SPOT resource

```

                                Define a Resource

Type or select values in entry fields.
Press Enter AFTER making all desired changes.

                                [Entry Fields]
* Resource Name                  [SPOT_53_ML4]
* Resource Type                  spot
* Server of Resource             [master]                +
* Source of Install Images      [LPP_53_ML4]            +
* Location of Resource          [/nim/aix53m14/]       /
Expand file systems if space needed?  yes                +
Comments                        []

installp Flags
COMMIT software updates?         no                  +
SAVE replaced files?             yes                +
AUTOMATICALLY install requisite software?  yes                +
OVERWRITE same or newer versions?  no                  +

```

Note: The highlighted values must be entered according to your environment. Remember to check the status of the resource by running the `lsnim -l <spot_name>` command.

Step 8: Defining the client

After the two basic resources have been defined, add the first NIM client. Use the `smitty nim_mkmac` fastpath, enter the name of the machine, and fill in the required fields in the SMIT panel as shown in Example 2-22 on page 33.

Important: The NIM machine name must be a resolvable IP label (usually the same as the short hostname of the machine to be added).

Example 2-22 SMIT panel to define a NIM client

Define a Machine

Type or select values in entry fields.
Press Enter AFTER making all desired changes.

```
[TOP]                                [Entry Fields]
* NIM Machine Name                    [LPAR3]
* Machine Type                        [standalone]      +
* Hardware Platform Type              [chrp]           +
  Kernel to use for Network Boot      [mp]             +
  Communication Protocol used by client []              +
  Primary Network Install Interface
* Cable Type                          tp               +
  Network Speed Setting                []              +
  Network Duplex Setting                []              +
* NIM Network                         NET_EN1
* Host Name                            lpar3
  Network Adapter Hardware Address     [0]
  Network Adapter Logical Device Name  []
[MORE...4]
```

```
F1=Help          F2=Refresh          F3=Cancel          F4=List
F5=Reset         F6=Command          F7=Edit            F8=Image
F9=Shell         F10=Exit            Enter=Do
```

Remember that NIM programs must be able to resolve the IP labels using the /etc/hosts file or a DNS server. Refer to “Setting up IP name resolution” on page 65 for additional information.

Step 9: Start the client installation

At this time, because there is no mksysb resource available yet, the only way to perform a BOS install on a client is by using a Run-Time Environment (rte). Use the **smitty nim_task_inst** fastpath, then select Install the Base Operating System on Standalone Clients, the client to be installed (LPAR3), rte as installation method, and the resources (SPOT_53_ML4 and LPP_53_ML4), as shown in Example 2-23.

Example 2-23 Starting base operating system installation on a client

Install the Base Operating System on Standalone Clients

Type or select values in entry fields.
Press Enter AFTER making all desired changes.

```
[TOP]                                [Entry Fields]
* Installation Target                  LPAR3
```

```

* Installation TYPE                               rte
* SPOT
SPOT_53_ML4
  LPP_SOURCE                                     [LPP_53_ML4]      +
  MKSYSB
  BOSINST_DATA to use during installation        []                +
  IMAGE_DATA to use during installation          []                +
  RESOLV_CONF to use for network configuration  []                +
  Customization SCRIPT to run after installation []                +
  Customization FB Script to run at first reboot []                +
  ACCEPT new license agreements?             [yes]             +
  Remain NIM client after install?              [yes]             +
  PRESERVE NIM definitions for resources on     [yes]             +
  this target?
  FORCE PUSH the installation?                   [no]              +
  Initiate reboot and installation now?       [no]              +
  -OR-
  Set bootlist for installation at the         [no]              +
  next reboot?
[MORE...22]

F1=Help          F2=Refresh      F3=Cancel      F4=List
F5=Reset         F6=Command     F7=Edit       F8=Image
F9=Shell        F10=Exit       Enter=Do

```

Remember: Accept the licence agreements and change the value of Initiate reboot and installation now? from yes to no. Also, because this is the very first time installing this machine, client network boot must be manually initiated (to allow the client to “pull” resources from the server).

Step 10: Additional checks

Perform the following checks before starting the client installation.

Verify that the bos_inst operation is correctly set up. There are three things to always check before you actually perform the installation:

- ▶ Verify that the correct entry has been added in the /etc/bootptab file.

Example 2-24 shows, in highlighted text, the LPAR3 client entry.

Example 2-24 Content of the /etc/bootptab file

```

{nimmast}:/ # tail /etc/bootptab
.....
#      T179 -- (xstation only) -- XDMCP host

```

```
# T180 -- (xstation only) -- enable virtual screen
lpar3:bf=/tftpboot/lpar3:ip=10.1.1.13:ht=ethernet:sa=10.1.1.1:sm=255.255.255.0:
{nimmast}:/ #
```

- Verify that the boot files have been created in the /tftpboot directory. The /tftpboot directory must contain a boot image with the name of the client. This file is a symbolic link to the boot image (kernel) created from the SPOT resource.

This directory also must contain a file <client_name>.info use during the installation to set environment variables which are used by the boot image file and the install scripts.

Example 2-25 lists the files and resources in /tftpboot.

Example 2-25 Content of the /tftpboot directory

```
{nimmast}:/ # ls -l /tftpboot
total 151248
-rw-r--r-- 1 root system 12211712 Jun 20 15:57
AIX53_ML04_debug.chrp.mp.ent
-rw-r--r-- 1 root system 11688960 Jun 12 11:13 SPOT-VIO.chrp.mp.ent
-rw-r--r-- 1 root system 12211712 Jun 19 16:24
SPOT_53_ML4.chrp.mp.ent
-rw-r--r-- 1 root system 12211712 Jun 22 17:43
SPOT_PRUEBA.chrp.mp.ent
-rw-r--r-- 1 root system 12211712 Jun 22 18:01 SPOT_TEST.chrp.mp.ent
lrwxrwxrwx 1 root system 33 Jun 26 09:11 lpar3 ->
/tftpboot/SPOT_53_ML4.chrp.mp.ent
-rw-r--r-- 1 root system 1109 Jun 26 09:11 lpar3.info
-rw-r--r-- 1 root system 8162755 Jun 02 10:37
spotaix5104.chrp.mp.ent
-rw-r--r-- 1 root system 8720910 Jun 02 11:49
spotaix5204.chrp.mp.ent
{nimmast}:/ #
```

- Verify that the required resources are allocated to the client and that its Cstate parameter has the right value. Refer to Example 2-26 for details related to the LPAR3 client. There is information in highlighted text that must be checked before starting the pull mode.

Example 2-26 Output of the lsnim -l LPAR3 command

```
{nimmast}:/ # lsnim -l LPAR3
LPAR3:
class          = machines
type           = standalone
connect        = shell
platform       = chrp
netboot_kernel = mp
```

```
if1           = NET_EN1 lpar3 0
cable_type1  = tp
Cstate      = BOS installation has been enabled
prev_state   = ready for a NIM operation
Mstate       = not running
boot         = boot
lpp_source  = LPP_53_ML4
nim_script   = nim_script
spot        = SPOT_53_ML4
cpuid        = 001A85D24C00
control      = master
current_master = nimmast
sync_required = yes
{nimmast}:/ #
```

Step 11: Start the client installation

To start the client installation, power on the client and go into the SMS menus. Using the console, press the 1 key during the boot sequence. For details about how to reach the SMS menu, see “SMS and console flow during NIM client installation” on page 84.

Step 12: Redo the checks in Step 10: Additional checks

Verify that the /etc/bootptab file no longer contains a specific line related to the machine, or a specific link into the /tftpboot directory and the Cstate of the client must be back to Ready for a NIM operation.

2.1.6 Easy steps to maintain a NIM environment

In this section we provide a simple example to illustrate the different steps needed to maintain a NIM environment. The starting point is a running NIM environment consisting of a master and its clients. One of the clients needs to be updated by a new fileset, a PTF (fix), or an entire Technology Level (TL, formerly known as ML).

Follow these steps:

1. Find a source to install the missing fileset on a client.

Remember that you are working in a NIM environment, thus the installation package source is an lpp_source. Because NIM is able to work with multiple AIX versions and technology/Maintenance Levels, you must know the appropriate lpp_source that is used as the source of the filesets.

2. Check the AIX level of the client by using the commands **oslevel -r** and **oslevel -s**.

3. Check whether the required fileset is part of the current `lpp_source` by performing the **lslpp** operation on an `lpp_source`. You can use: **smitty nim -> Perform NIM Administrative Tasks -> Manage Resources**, as shown in Example 2-27.

Example 2-27 An lslpp operation on an lpp_source resource

```

                                Manage Resources

Move cursor to desired item and press Enter.

List All Network Install Resources
Define a Resource
Change/Show Characteristics of a Resource
Show the Contents of a Resource
Remove a Resource
+-----+
|                                     Network Install Operation to Perform                                     |
|                                                                                                                                           |
| Move cursor to desired item and press Enter.                                                                                             |
| showres = show contents of a resource                                                                                                     |
| lslpp = list LPP information about an object                                                                                             |
| check = check the status of a NIM object                                                                                               |
| lppmgr = eliminate unnecessary software images in an lpp_source                                                                     |
| update = add or remove software to or from an lpp_source                                                                           |
|                                                                                                                                           |
| F1=Help           F2=Refresh           F3=Cancel                                                                                   |
| F8=Image          F10=Exit             Enter=Do                                                                              |
F1| /=Find          n=Find Next
F9+-----+

```

Optionally, you can update the current `lpp_source` if the required fileset is not present by performing the update operation on the related `lpp_source` resource, as shown in Example 2-28. Use **smitty nim -> Perform NIM Software Installation and Maintenance Tasks -> Software Maintenance and Utilities -> Add Software to an lpp_source -> Select Target lpp_source -> Select Software Source**.

Example 2-28 An update operation on an lpp_source resource

```

                                Add Software to an lpp_source

Type or select values in entry fields.
Press Enter AFTER making all desired changes.

TARGET lpp_source
SOURCE of Software to Add

[Entry Fields]
LPP_53_ML4
cd0

```

```

SOFTWARE Packages to Add          []          +
-OR-
INSTALLP BUNDLE containing packages to add  []          +

gencopy Flags
  DIRECTORY for temporary storage during copying  [/tmp]
  EXTEND filesystems if space needed?             yes          +
  Process multiple volumes?                       no           +

F1=Help          F2=Refresh          F3=Cancel          F4=List
F5=Reset         F6=Command          F7=Edit           F8=Image
                F9=Shell           F10=Exit          Enter=Do

```

4. Perform a push operation from your master to the client by using the following SMIT fast path:

```
smitty nim_task_inst
```

Choose **Install Software**. Example 2-29 shows the related SMIT panel.

Example 2-29 SMIT panel to performing a fileset installation on a client

Install and Update Software

Move cursor to desired item and press Enter.

```

Install the Base Operating System on Standalone Clients
Install Software
Update Installed Software to Latest Level (Update All)
Install Software Bundle
Update Software by Fix (APAR)
Install and Update from ALL Available Software

```

```

F1=Help          F2=Refresh          F3=Cancel          F8=Image
F9=Shell         F10=Exit           Enter=Do

```

5. Check the result of the installation by using the following SMIT fast path (see Example 2-30):

```
smitty "nim_list_installed_sw"
```

Example 2-30 SMIT panel to list the installed software on a client

List Installed Software

Type or select values in entry fields.
Press Enter AFTER making all desired changes.

			[Entry Fields]
* Target			LPAR3
* Software Names			[all] +
Show SUPERSEDED levels?			[yes] +
F1=Help	F2=Refresh	F3=Cancel	F4=List
F5=Reset	F6=Command	F7=Edit	F8=Image
F9=Shell	F10=Exit	Enter=Do	

2.2 What is new in NIM for AIX 5L

NIM was introduced with AIX V 4.1. NIM improvements have been added with each release of the AIX operating system. In covering the differences between versions (NIM objects, NIM application, maintenance, administration and the tools to support migration from one level to the next), we start with AIX 5L V5.1 and trace its progress up to AIX 5L V5.3. For AIX versions older than AIX 5L V5.1 refer to *NIM From A to Z in AIX 4.3*, SG24-5524.

2.2.1 NIM improvements with AIX 5L V5.1

A major improvement offered by AIX 5L V5.1 is the capability to use AIX tools to manage RPMS filesets. The basic command **installp** has been replaced by **geninstall**, and the **gencopy** command has been introduced. As a result, it is fairly easy to administer RPM packages.

2.2.2 NIM improvements with AIX 5L V5.2

This section lists the main improvements coming with AIX 5L V5.2.

- ▶ lpp_source management tools
 - Enhancements to the management of lpp_source resources including the following:
 - The lpp_source is no longer required for mksysb installations.
 - The NIM update operation, which allows you to update an lpp_source resource by adding or removing packages. Previously, you could copy or remove packages into or from an lpp_source directory and then run the **nim -o check** command to update the lpp_source.

SMIT allows you to add packages to the lpp_source directory through the **smitty nim_bffcreate** fast path. However, this SMIT function does not

check whether the lpp_source is allocated (or locked), nor does it update the simages attribute when finished. The update operation has been created to address this situation.

- The **lppmgr** operation is available to help you manage your lpp_source resource. The **lppmgr** facility can be used to clean an lpp_source that contains superfluous filesets.

For example, you may have loaded all eight AIX install CDs into the lpp_source, but yet do not want language support other than your own language. Or, if continuing to download ML updates into your lpp_source, you could have superseded fixes that are no longer needed.

Again, a cleanup would help to save space and time when this resource is used. If desired, you can choose to save your cleaned-up filesets by setting the save removed files field to yes as shown by Example 2-31; for example, **smitty nim -> Perform NIM Software Installation and Maintenance Tasks -> Software Maintenance and Utilities -> Eliminate Unnecessary Software Images in an lpp_source -> Select Target lpp_source.**

Example 2-31 Example of SMIT panel for an lppmgr action

Eliminate Unnecessary Software Images in an lpp_source

Type or select values in entry fields.
Press Enter AFTER making all desired changes.

	[Entry Fields]	
TARGET lpp_source	LPP_53_ML4	
PREVIEW only?	yes	+
REMOVE DUPLICATE software	yes	+
REMOVE SUPERSEDED updates	yes	+
REMOVE LANGUAGE software	yes	+
PRESERVE language	[en_US]	
REMOVE NON-SIMAGES software	no	+
SAVE removed files	no	+
DIRECTORY for storing saved files	[]	
EXTEND filesystems if space needed?	yes	+

- ▶ **Creating resources simultaneously**
Previously, when NIM ran a process that calculated and allocated file system space (such as creating an SPOT, lpp_source, and mkysyb resource), no other similar operation could take place at the same time. Because these

operations calculate free space and enlarge the size of a file system, the NIM master was limited to one of these operations at a time.

Starting in AIX 5L V5.2, however, you can use NIM to simultaneously create multiple lpp-source and mkysyb resources in separate file systems on the same server.

Note: You cannot simultaneously create multiple SPOT resources (creating a SPOT requires an installp process, and there can be only one such instance at a time), but you can simultaneously create an SPOT, an lpp_source, and mkysyb resources.

The locking mechanism is set for each file system instead of each server. However, if you know that you have enough space in a file system to create multiple resources simultaneously, you can use the force option (-F flag) to prevent the locking mechanism from being used.

- ▶ Resource groups
This allows you to create a group of resources and specify clients (or a group of clients) as default. Previously, every time a NIM operation occurred, the NIM resources had to be specified to be allocated manually. A default resource group can be created containing the required resources, so when a NIM operation is performed, the resources are already associated to the client (or the group of clients) by the default resource group.
- ▶ Alternate disk migration installation
This allows the user to create a copy of rootvg to a free disk and simultaneously migrate it through NIM to a new release level. Using alternate disk migration installation over a conventional migration provides several advantages:
 - Reduced downtime
 - Quick recovery in case of migration failure
 - High degree of flexibility and customization
 - Easy configuration utilities
- ▶ EZNIM
The SMIT EZNIM menu helps the system administrator by organizing the commonly used NIM operations and simplifies frequently used advanced NIM operations.
- ▶ nim_master_setup
The **nim_master_setup** command performs the basic steps which are further detailed in 3.1.2, “Setting up the NIM environment” on page 59. It installs the bos.sysmgmt.nim.master fileset, configures the NIM master, and creates the resources for installation (SPOT, lpp_source), optionally including a system backup resource (mkysyb). The **nim_master_setup** command uses the rootvg

volume group and creates an /export/nim file system by default. You can change these defaults using the **volume_group** and **file_system** options.

Example 2-32 shows the options available with the **nim_master_setup** command.

Example 2-32 nim_master_setup

```
# nim_master_setup
Usage nim_master_setup: Setup and configure NIM master.
nim_master_setup [-a mk_resource={yes|no}]
[-a file_system=fs_name]
[-a volume_group=vg_name]
[-a disk=disk_name]
[-a device=device]
[-B] [-v]
-B Do not create mksysb resource.
-v Enable debug output.
Default values:
mk_resource = yes
file_system = /export/nim
volume_group = rootvg
device = /dev/cd0
```

► **nim_clients_setup**

The **nim_clients_setup** command as shown in Example 2-33, is used to define your NIM clients, allocate the installation resources, and initiate a NIM BOS installation on the clients (see details in 4.3.2, “Performing a BOS installation” on page 149).

Example 2-33 nim_clients_setup

```
Usage nim_clients_setup: Setup and Initialize BOS install for NIM clients.
nim_clients_setup [-m mksysb_resource]
[-c] [-r] [-v] client_objects
-m specify mksysb resource object name -OR- absolute file path.
-c define client objects from client.defs file.
-r reboot client objects for BOS install.
-v Enables debug output.
```

Note: If no client object names are given, then all clients in the NIM environment are enabled for BOS installation. If the (-c) flag is used, the newly created LPARs are initialized for installation; otherwise, specified clients or all existing LPARs are initialized for installation.

2.2.3 NIM improvements with AIX 5L V5.3

This section gives general information about the improvements coming with AIX 5L V5.3. Among the improvements, nimsh and alternate NIM master are of particular importance:

- ▶ nimsh

By default, the NIM environment uses rsh to communicate with your client when performing push operations. This means using the `~/.rhosts` file, which may not be acceptable (as it is considered not to be secure) in certain environments.

NIM in AIX 5L V5.3 allows an alternate communication method using nimsh. Out of the box, nimsh is also considered semi-secure, because it requires root privileges and uses the NIM master and client `cpu_id` to authenticate. If you require stronger security, you have the option to implement SSL with nimsh. See 5.3, “NIMSH, OpenSSL and firewall considerations” on page 424, for further details.

- ▶ Alternate NIM master

NIM in AIX 5L V5.3 introduces a facility to have a backup NIM master to takeover if your primary NIM master suffers a disaster. See 4.1, “High Availability Network Installation Manager” on page 124 for details about how to set up an alternate NIM master.

- ▶ Detailed output when creating a NIM `lpp_source` resource

Before AIX 5L V5.3, the NIM `lpp_source` creation did not give any information about the progress of the procedure. AIX 5L V5.3 extends the NIM `lpp_source` creation adding verbose output. There is a new attribute (`show_progress`) which has been introduced to the `nim` command. The NIM administrator can modify it to turn the verbose attribute on or off. Example 2-34 shows how to turn on this attribute.

Example 2-34 Turning on the `show_progress` attribute

```
nim -o define -t lpp_source ... -a show_progress=yes
```

- ▶ Creating an SPOT resource from a `mksysb`

Prior to AIX 5L V5.3, the NIM SPOT resource could be created from an existing `lpp_source` resource or from the installation media. The disadvantage of such a generic SPOT is the amount of disk space it consumes and the long creation time.

Note: A SPOT created from a `mksysb` can only be used for that `mksysb`.

The SPOT is created from the mksysb using the /usr/lib/bootpkg/bootpkg_list file that lists only the necessary files for the SPOT. The size of the SPOT created using this method is approximately 50 MB. The size of the SPOT created from the lpp_source is about 400 MB.

- ▶ `nim_move_up` command and operation

The `nim_move_up` command enables users of existing AIX environments to take advantage of the capabilities available on new hardware (namely POWER5 servers or later). The command provides an interface that migrates an existing AIX system onto an LPAR residing on a POWER5 (or later) server.

The level of AIX on the original machine is raised to a level that supports operation on POWER5 hardware. The original system's hardware resources are closely replicated on the equivalent POWER5 hardware. By the end of the migration, the same system is fully running on a POWER5 LPAR.

In addition, `nim_move_up` can use the Virtual I/O capabilities of POWER5 servers by optionally migrating a client onto virtualized hardware, such as virtual disks and virtual Ethernet.

- ▶ mksysb migration using NIM

mksysb migration allows you to restore the mksysb from an old system to a system that supports AIX 5.3 and then migrate the mksysb.

Traditional migration moves the operating system of a supported hardware configuration to a newer level. A mksysb migration installation is the recommended method of installation to move unsupported hardware configurations running AIX 4.3 and later to new supported hardware running AIX 5.3.

A mksysb migration is not intended for systems that you can migrate with a traditional migration. This method allows you to bypass the hardware limitation by restoring the mksysb on the new hardware configuration and migrate it without running AIX 4.3. The resulting system will be running the new level of AIX.

- ▶ Restore the SPOT copy function

In AIX 5L V5.3, the restore SPOT copy function was reintroduced. The administrator can select the SPOT residing on the NIM server to install the BOS on the clients.

- ▶ NIM and Service Update Management Assistant (SUMA); for details, see 4.10, “NIM and Service Update Management Assistant” on page 319.

- ▶ NIM ability to restore volume groups other than the rootvg to clients using the `nim -o restvg` operation.

- ▶ EZNIM enhancements:
 - Creates an lpp_source resource when setting up the master.
 - Adds nimsh and cryptographic authentication option when setting up the master and reinstalling the clients.
 - Adds an rte option to be selected for client reinstall.
 - Adds install options of overwrite, preservation, and migration for client reinstall.
 - Adds new options for viewing the NIM environment.

2.3 Planning for your NIM environment

Successfully implementing a reliable and efficient NIM environment strongly depends on the first step of this endeavor, which is planning. Performing adequate planning for your NIM environment will most likely save you from needing to rebuilding your NIM environment in case of unsatisfactory results.

Planning of your NIM environment involves the following tasks:

- ▶ Choosing your NIM master
- ▶ Defining standard and consistent naming topologies
- ▶ Sizing your NIM master
- ▶ Designing for availability

In the following sections, we explain these tasks in more detail.

2.3.1 Choosing your NIM master

The first step in the planning process is choosing the NIM master. A correct decision when choosing your NIM master will contribute significantly to increasing the resiliency of your entire environment.

Start by determining what you expect NIM to provide in your environment, and what you expect the main role of the NIM master to be. From your experience with NIM, perhaps you found that you spent more time with the NIM master performing upgrades and system backups, than the initial installation of the servers. The NIM master is usually used in server's bare-metal-restore operations in case of major failures or disaster recovery (DR) scenarios.

The following tips will help you make the optimal choice of NIM master:

- ▶ In environments where NIM is needed, there usually exists a network backup server, such as IBM Tivoli Storage Manager (TSM) server. Consolidating the

backup and recovery functionality on one server offers obvious benefits. Therefore, we recommend that you install the NIM master on the same machine or LPAR as the TSM server.

- ▶ The NIM master needs to be installed with the highest AIX version in your environment, and must be maintained at the latest AIX level. This may represent a constraint to installing the NIM master on the same machine or LPAR as the TSM server.
- ▶ The NIM master must not be installed on a production machine or LPAR. And an LPAR cannot be a NIM master and a NIM client at the same time, because of AIX-level constraints.
- ▶ We recommend that the NIM master be installed on a separate physical machine from your production environment. The same recommendation applies to the TSM server.
- ▶ The NIM master needs to have reliable IP connectivity to all NIM clients.
- ▶ The NIM master needs to be implemented in a highly secure zone because, it will probably contain the system backup images of your mission-critical business application servers.
- ▶ We recommend using the NIM master to also store backup images of the NIM clients' volume groups. These images need to be created with appropriate exclude files. Files excluded from backup may include temporary or unnecessary files.
- ▶ The NIM master needs to have access to adequate disk storage with adequate scalability.
- ▶ We have observed dependencies on certain OEM storage subsystem multipath I/O drivers. If you have a non-IBM storage subsystem that comes with a vendor-implemented multi-path driver, verify that you use the appropriate driver version for your VIOS code. Refer to the storage subsystem manufacturer's documentation for the appropriate information.
- ▶ In a dual VIOS environment, with a large number of disks provided by different storage subsystems, when updating any of the components (VIOS version, MPIO driver, and so on), we recommend that you take one of the VIOS offline during this update procedure.

The easiest (and safest) way to do this is by copying the LPAR profile of the VIOS and removing from this profile any adapter that is not needed during the update operation (depending on the updated component). This includes physical and virtual adapters. Then boot the VIOS for the update with the "reduced" profile. After the update has been successfully performed, boot the VIOS with the original profile again.

This is not a technical demand, but if you have a large number of disks or different storage subsystems, this action is highly recommended.

2.3.2 Dynamic LPAR operations

Even though Dynamic LPAR operations are faster than installing additional memory and CPUs in other architectures, these operations must be carefully planned to understand all implications, and thus minimize the time required for management operations.

Our tests have shown that Dynamic LPAR operations with CPU capacity are very fast; it may take up to a few seconds to move several processing units from one LPAR to another. However, Dynamic LPAR memory operations need more time and can even experience some variations, depending on the situation.

The amount of time required depends on the following factors:

- ▶ The system load
- ▶ The number of short-term DMA mapped pages
- ▶ The number of LMBs being moved

Refer to APAR IY97605 for more detailed information about this topic:

<https://techsupport.services.ibm.com/server/aix.srchBroker>

2.3.3 Defining a consistent naming convention

Defining and adhering to a consistent naming convention contributes to increasing the efficiency of the NIM environment management. We strongly recommend that you plan for and define a standard naming topology for:

- ▶ The NIM directory structure
- ▶ The NIM resources

We recommend that you define short but indicative names.

For the NIM directory structure, five main NIM-specific file systems are needed, which are to contain NIM resources directories. Two suggestions are proposed for the NIM directory and file system structure:

- ▶ The first structural suggestion, shown in Figure 2-6 on page 48, has separate file systems for each different AIX Maintenance Level or Technology Level which includes the related lpp_source and SPOT directories.

In addition to those file systems, there is a file system to store the mkysyb images, another one for additional software packages, and the last one for resources related to small files like bosinst_data, script, image_data and so forth. Refer to Table 2-2 on page 27 for an estimate size.

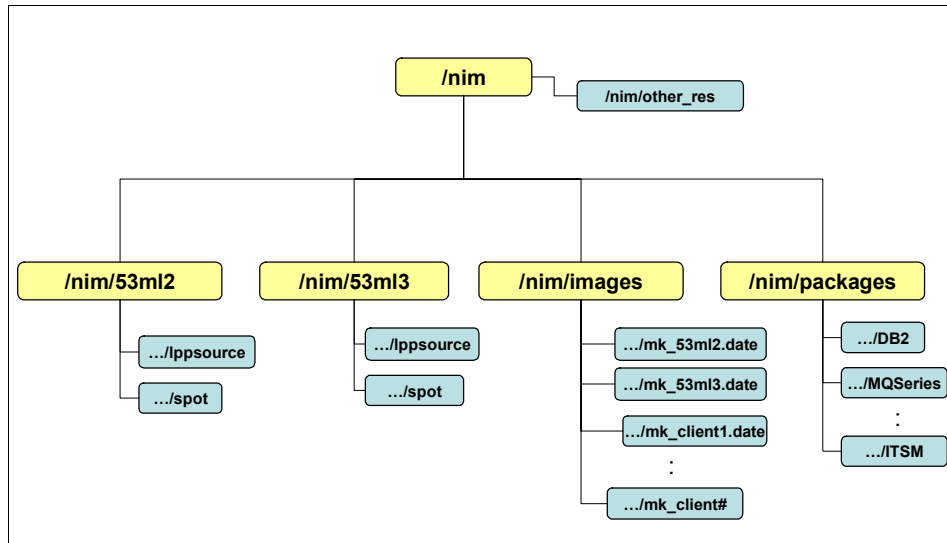

Figure 2-6 NIM directory structure based on PSSP

- The second structural suggestion, shown in Figure 2-7 on page 49, has a different structure: there is one file system for the lpp_source resources and one for the SPOT resources, each of them containing the different AIX Maintenance Levels or Technology Levels.

For the rest of the file systems, we suggest the same organization: one file system to store the mksysb images, another one for additional software packages and the last one for resources related to small files like bosinst_data, script, image_data and so forth. Refer to Table 2-2 on page 27 for an estimate size.

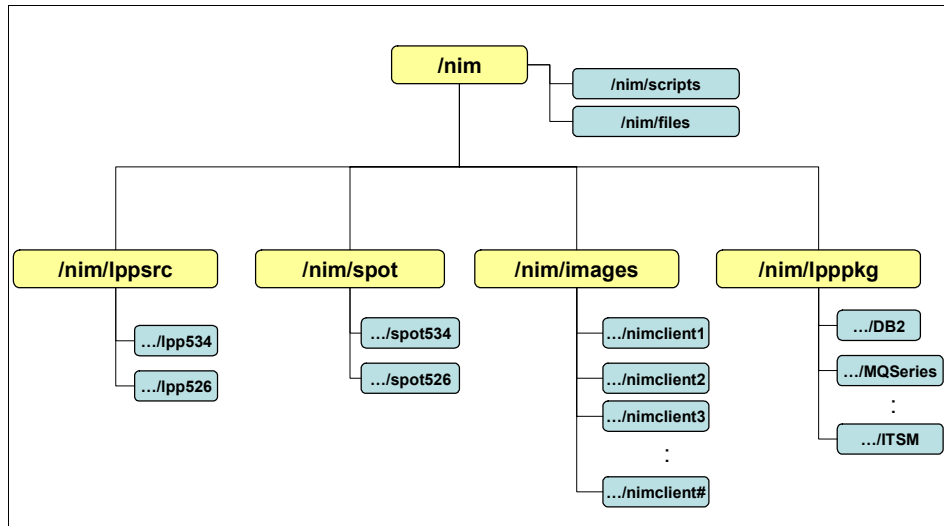

Figure 2-7 Alternative NIM directory structure

Tip: For a naming convention, the following general rule can be applied: for all NIM object names use upper case, and for all AIX names (host names, files, or directories names related to resources) use in lower case. This helps you to quickly identify whether something has to be changed in either AIX (lower case names) or NIM (upper case names).

Of course, there is also a third option: create a large file system (/nim) on a separate volume group dedicated entirely to NIM.

2.3.4 Sizing your NIM master

The NIM master operations do not require extensive CPU and memory resources. This is one of the reasons why we recommend that you consider consolidating it with your TSM network backup server on the same server (LPAR).

As for I/O sizing (disk, network), the NIM master requires an adequate I/O bandwidth for performing regular system backups of the NIM clients and various other administration operations. From our experience, we found that nearly all Fibre Channel host bus adapters (HBAs) are underutilized. Therefore, you probably do not need to worry about the HBAs.

The network interfaces situation could be different. Dual Gigabit Ethernet interfaces configured in an Etherchannel would be a good start for your

combined TSM and NIM servers. The disk space must be calculated during planning. Although NIM environments vary widely, Table 2-2 on page 27 provides guidelines for planning disk space for your NIM master.

2.3.5 Designing for availability

Due to the nature of their operation, NIM masters and resource servers are generally not considered a single point of failure for critical business operations. In most cases, the business can continue to run while the NIM master and resource servers are being recovered, provided that they can be recovered before the next system backup cycle or so.

For TSM, however, our experience is different. We implemented high availability (HA) clustered TSM servers using IBM HACMP product for good business reasons. Combining the NIM master and the TSM server on the same system could make a stronger business case to implement a high availability NIM master and TSM server.

A reasonable degree of high availability can be implemented within a single NIM master instance by implementing the following:

- ▶ Multiple (two or more) Ethernet interfaces configured in an Etherchannel. This will not only provide a seamless recovery from a network interface failure, but also will multiply the bandwidth available.
- ▶ Multiple Fibre Channel HBAs (an even number of HBAs is recommended).
- ▶ Implement a RAID5 configuration at the disk storage level, or use AIX mirroring.
- ▶ Use extra care if your NIM master uses virtual SCSI disks. (In case of a disaster, the Virtual I/O Server may need to be recovered before you can recover your NIM master—but you might want to recover the virtual I/O Server using the NIM server.)

Note: To minimize the impact of such a situation, we recommend that you allocate, in the VIOS, one entire disk (LUN) to the rootvg of the NIM master. (If you have the NIM repository in a different VG, you may also want to allocate an entire LUN for that, as well.)

In this way, you will be able to change the profile of the LPAR hosting the NIM server to include the physical storage (FC or SCSI) adapter that has access to the disk (LUN) defined for the NIM server, and boot the NIM server without virtual SCSI resources.



Basic configuration of a Network Installation Manager environment

This chapter explains how to set up a basic Network Installation Manager (NIM) environment. It presents the following topics:

- ▶ Setting up a basic NIM environment
 - name resolution order
 - bootp file format
 - NIM environment variables
 - NIM server options
 - NIM database
 - NIM operational log files
- ▶ Using SMIT step-by-step to set up a NIM master and install a client
- ▶ Using Web-Based System Manager to set up a NIM master and install a client
- ▶ Using EZNIM scripts to set up a NIM master and install a client
- ▶ Using the OS_install command (wrapper) to install a client

For more detailed information about planning the NIM environment, refer to 2.3, “Planning for your NIM environment” on page 45. For more detailed information

about how to use NIM to maintain and manage your AIX/Linux software environment, refer to Chapter 4, “Network Installation Manager scenarios” on page 123. For more detailed information about configuring NIM, refer to *AIX 5L Version 5.3 Installation and Migration*, SC23-4887.

3.1 Setting up a basic NIM environment

Setting up a NIM master and bringing it to use is very simple and easy. We recommend following these steps:

1. Plan the NIM environment.
2. Set up the NIM environment by implementing the plan.
3. Maintain the installed environment.

We begin here by explaining how to set up a *basic* NIM environment using the command line interface (CLI). Next, we show the same steps through more user-friendly interfaces, by using the `nim_master_setup` command, EZNIM, and Web-Based System Management (WSM).

If you just want to install both AIX and Linux clients, you can also use the `OS_insta11` command introduced with AIX 5L V5.3 Technology Level 5 (TL5).

3.1.1 Planning the NIM environment

In this section we describe a simple design for a basic NIM environment, in which the NIM master also serves as a resource server for all resources.

Purpose

The purpose of the basic NIM environment is to be able to install the operating system on System p logical partitions (LPARs) and physical machines using one of the following install methods:

- ▶ Fileset-based installation (Run-Time Environment - `bos rte install`)
- ▶ System backup-based installation, by restoring a system image created using the AIX backup procedure (`mksysb`).

System resources

The first step in setting up a new NIM environment is to obtain the appropriate computer resources. You will also need a NIM server (master) and a network environment (physical connectivity, TCP/IP configuration).

The NIM master in a LPAR environment can be a small LPAR (using dedicated or shared resources, depending on requirements and the available System p architecture). Network and disk resources can be made available to the NIM server via a virtual I/O (VIO) server.

The same NIM master can serve NIM clients residing outside the physical machine (System p) where it is allocated by using a VIO server virtual network interface, as well as NIM clients within the same physical machine using a hypervisor virtual LAN (VLAN).

The NIM server (as described in Chapter 2, “Network Installation Manager definitions and concepts” on page 7) needs at least one network interface and, depending on the planned storage repository, plenty of storage space. The amount of storage space, even for a basic NIM environment, depends on how many versions of base AIX filesets you need to copy from AIX CDs/DVDs, and the number of downloaded Technology Levels (TLs), Service Packs (SPs), Concluding Service Packs (CSPs) and additional Program Temporary Fixes (PTFs).

Note: In the basic NIM environment described here, we do not take into account additional storage space for other installable application software (such as DB2®, WebSphere Application Server, MQ, and so forth), as well as storage space that would be needed for NIM client system backups using NIM mksysb operation.

File system hierarchy

For our basic NIM environment, the storage utilization will benefit from a structured file system hierarchy. It is up to you to decide which structure you want. In 2.3.3, “Defining a consistent naming convention” on page 47 and throughout the book, we present several ways to name and structure different parts of the NIM environment.

Note: There is no “golden rule” for naming your directory structure and resources, but the purpose of the file structure is the same: to make it easier to find, use, manage, and minimize storage redundancy in the file system storage used for the NIM environment.

Also, keep in mind that certain directory names should be kept as default (/tftpboot, for example). However, we recommend that you use a naming convention that is relevant and easy to understand in your environment.

For the basic NIM environment, you can use the following file system hierarchy:

/tftpboot	This is used for storing NIM master boot images (kernels) and info files for the NIM clients.
/export/lpp_source	This is used for storing versions of AIX base level filesets in specific directories; a NIM lpp_source resource represents a directory in which software installation images are stored (in BFF or RPM format). Our basic NIM environment used a minimum of one base level and one base level with applied TL and CSP for the “Maximum Stability” maintenance model (see 4.10.4, “Maintenance models” on page 332).

- /export/spot** This is used for storing non-/usr Shared Product Object Three (SPOT) in individual directories (one per SPOT version). A SPOT is required to install or initialize all types of machine configurations, as well as to generate a specific kernel image used for network booting a client system. Everything that a client machine requires in a /usr file system, such as the AIX kernel, executable commands, libraries, and applications, should be included in the SPOT.
- /export/images** This is used for storing system backup images. These images can be created by using the NIM mkysyb operation (“pulling” a mkysyb image from a NIM client), or by copying a system backup as a file from a previously created backup file, tape, or DVD. To create subdirectories during NIM mkysyb creation, you must export the NIM_MKSYB_SUBDIRS=yes variables before using the `nim -o define -t mkysyb` command. See 4.11, “Backing up clients with NIM” on page 348, for more detailed information about this topic.

Plan to use a relevant naming convention to keep track of all NIM resources. In our example, we use a straightforward short coded UNIX-style variant. (For examples of other naming conventions, refer to 2.3.3, “Defining a consistent naming convention” on page 47 and “Directory structure setup” on page 293.)

Note: The /export/nim/scripts directory is used for the nim_script resource that is managed by NIM, and should not be used to store other files or scripts.

Basic naming convention for the NIM lpp_source objects

The NIM lpp_source objects can be named in the same way for both the directory and the NIM lpp_source object.

If an lpp_source only contains update filesets, then the directory name is prefixed to reflect the type of update. If the lpp_source directory contains all the filesets needed to perform basic operating system (rte) installation (the lpp_source’s simage attribute is set to yes), then the directory name is prefixed with lpp (Licensed Program Product). The following list presents the naming convention method we used in our test:

lpp<OS#>00	General Availability (GA) level for AIX version <OS#>
lpp<OS#><TL#>	GA base <OS#> with Technology Level <TL#>
lpp<OS#><TL#><SP#>	GA base <OS#> with Technology Level <TL#> and Service Pack <SP#>

lpp<OS#><TL#>CSP	GA base <OS#> with Technology Level <TL#> and its Concluding Service Pack
TL<OS#><TL#>	Technology Level <TL#> for <OS#>
SP<OS#><SP#>	Service Pack <SP#> for <OS#>
CSP<OS#><CSP#>	Concluding Service Pack <CSP#> for <OS#>

Note: The AIX level is shown by the `oslevel` command as four digits; for example, AIX 5.3 GA base level are shown as 5300. The two trailing digits are always zero (0) and can be omitted. The two leading digits represent the <OS#> in this naming scheme. However, to make the GA base level name stand out, you can keep all four digits. For example, you could suffix the name with two zeroes (00), thus `lpp53` and `spot53` would then show as `lpp5300`, and `spot5300`, respectively.

For each AIX version you must create one directory in `/export/lpp_source`, for example `/export/lpp_source/lpp53` or `/export/lpp_source/lpp5300` for the base level of AIX 5.3.

Basic naming convention for the NIM spot objects

The NIM spot objects can be named in a similar fashion, and based on the numbering for the corresponding NIM `lpp_source`, for both the directory and the NIM spot object.

spot<OS#>00	General Availability (GA) level for AIX version <OS#>
spot<OS#><TL#>	GA base <OS#> with Technology Level <TL#>
spot<OS#><TL#><SP#>	GA base <OS#> with Technology Level <TL#> and Service Pack <SP#>
spot<OS#><TL#>CSP	GA base <OS#> with Technology Level <TL#> and its Concluding Service Pack

For each AIX version plan to create one directory in `/export/spot`, such as `/export/spot/spot53` or `/export/spot/spot5300` for the base level of AIX 5.3, which is created from the corresponding NIM `lpp_source`, in this case the `/export/lpp_source/lpp53` or `/export/lpp_source/lpp5300`.

Note: We recommend that you pair the `lpp_source` and the SPOT versions and levels. For installing a new system, or for upgrading/migrating, you can also use SPOT resources at a lower level than the `lpp_source`.

However, you should check always the software levels, and *never* use an `lpp_source` at a lower level than the SPOT.

Basic naming convention for the NIM mksysb objects

For *generic* NIM mksysb images, with general pre-customization, the NIM mksysb objects and image filenames can be named in the same way as the NIM lpp_source and NIM spot previously described:

mksysb<OS#>00	General Availability (GA) level for AIX version <OS#>
mksysb<OS#><TL#>	GA base <OS#> with Technology Level <TL#>
mksysb<OS#><TL#><SP#>	GA base <OS#> with Technology Level <TL#> and Service Pack <SP#>
mksysb<OS#><TL#>CSP	GA base <OS#> with Technology Level <TL#> and its Concluding Service Pack

For *particular* LPARs or physical machines, mksysb image files can be named in a similar way (when you plan to use these images only on the same system they were created from), using the hostname and the date when the image are created either as a prefix/suffix. The corresponding NIM object name could consist of the hostname simply suffixed or prefixed with the word mksysb or mk.

If the specific NIM mksysb objects are created only for certain maintenance tasks (when needed, and then removed), it is not necessary to include time stamp information, such as the current date. However, this can be helpful, as shown in the following examples.

```
mk5305_lpar55_060618 => /export/images/lpar55/mk5305_lpar55_060618
```

```
mksysb_lpar55 => /export/images/lpar55/lpar55_5305_18JUN06
```

In this case, as shown in Example 3-1, the environment variable NIM_MKSYSB_SUBDIRS is used on the NIM master for storing system backups. When this variable is set to yes, then subdirectories are used to separate NIM mksysb image files created from client machines using the nim command. The subdirectories are transparent to the user, but they provide separate locations for NFS exporting. The subdirectories are named after the NIM machines object for which they are created (the NIM name used for the source attribute).

Example 3-1 Using the NIM_MKSYSB_SUBDIRS environment variable

```
root@master:/: export NIM_MKSYSB_SUBDIRS=yes
root@master:/: nim -o define -t mksysb -a server=master -a source=LPAR55
-a mk_image=yes -a location=/export/images/lpar55_5305_18JUN06 mksysb_lpar55
```

The **nim** command will create the mksysb image file lpar55_5305_18JUN06 in the /export/images/LPAR55 directory, and not directly in the /export/images directory.

Note: For additional information on mkysyb image creation and usage, see 4.11, “Backing up clients with NIM” on page 348.

Basic naming convention for the NIM network objects

In order to perform certain NIM operations, the NIM master must be able to supply information necessary to configure client network interfaces. The NIM master must also be able to verify that client machines can access all the resources required to support operations. To avoid the overhead of repeatedly specifying network information for each individual client, NIM networks are used to represent the networks in a NIM environment.

The NIM network objects are named by default as net#, where # is a number starting from 1. This might be sufficient for most installations which only utilize one IP network. But when one NIM master is used to support several networks, then the NIM network objects can be named so that the IP network is included in the name, to easier identify different networks in the environment:

net_<IP#NET> Network with the IP network address included in the name
 in decimal form with underscore (_) replacing dots (.)
 since dots are not allowed to use in NIM object names.

If the network has a 24-bit mask (FF.FF.FF.0, C-class network), the IP network address would be the three first octets, such as 10.1.1. The NIM networks name could then be net_10_1_1, or net_10_1_1_0. The last 0 is used to indicate the lowest number on the IP network, which can be useful if the NIM master will serve several IP networks. Table 3-1 shows how this could be achieved by using the lowest number on the IP network.

Table 3-1 NIM networks names for IP networks using different netmasks

Netmask (decimal dot notation)	NIM networks name
255.255.255.0	net_10_1_1_0
255.255.255.128	net_10_1_1_0, net_10_1_1_128
255.255.255.192	net_10_1_1_0, net_10_1_1_64, net_10_1_1_128, . . .
255.255.255.224	net_10_1_1_0, net_10_1_1_32, net_10_1_1_64, . . .
255.255.255.240	net_10_1_1_0, net_10_1_1_16, net_10_1_1_32, . . .
255.255.255.248	net_10_1_1_0, net_10_1_1_8, net_10_1_1_16, . . .

Netmask (decimal dot notation)	NIM networks name
255.255.255.252	net_10_1_1_0, net_10_1_1_4, net_10_1_1_8, . . .

To set up a NIM network object, the essential information is the IP network address (net_addr) and the mask (snm). Example 3-2 shows a NIM network object.

Example 3-2 Using lsnim to display NIM network objects

```

root@master:/: lsnim -l -c networks
net_10_1_1:
  class      = networks
  type       = ent
  Nstate     = ready for use
  prev_state = information is missing from this object's definition
  net_addr   = 10.1.1.0
  snm        = 255.255.255.0

```

The prev_state (Previous State) message shown here can be ignored because this is a newly created definition.

3.1.2 Setting up the NIM environment

The setup of a NIM environment consists of two major steps:

- ▶ Setting up the NIM master itself and basic master customization
- ▶ Setting up the resources and object definitions for at least one lpp_source and one spot resource

Basic setup of the NIM master

Install and configure the designated system for the NIM master (LPAR or physical machine) with the latest AIX version and Technology Level (TL) with appropriate Service Packs (SPs); see 4.10.7, “IBM AIX Service Strategy” on page 347.

Important: The NIM master should always have the highest AIX version of all the machines defined (NIM clients).

Install the bos.sysmgt.nim.master fileset

After initial BOS installation, install the NIM master software from the bos.sysmgt.nim.master fileset.

Create the file systems used as repository for the NIM master

Create the file systems for the NIM master as Enhanced Journaled File System (JFS2). You need to calculate the sizes (see Example 3-3) based on your own NIM environment requirements.

Example 3-3 Creating basic NIM environment master file systems

```
root@master:/: crfs -v jfs2 -g rootvg -a size=64M -m /tftpboot -A yes -p rw -a logname=INLINE
root@master:/: crfs -v jfs2 -g rootvg -a size=4G -m /export/lpp_source -A yes -p rw -a
logname=INLINE
root@master:/: crfs -v jfs2 -g rootvg -a size=1G -m /export/spot -A yes -p rw -a logname=INLINE
root@master:/: crfs -v jfs2 -g rootvg -a size=6G -m /export/images -A yes -p rw -a
logname=INLINE
```

After creating the file systems, mount them and set the appropriate permissions, such as 600 (which means that only the owner has read and write permission).

Initialize the NIM master

Now it is time to initialize the NIM master. Note the naming of the netname attribute. Here we will use **nimconfig** command, but you can also perform this step with the SMIT **nimconfig** fast path.

Configuring the NIM master using the nimconfig command

Configuring the NIM master using the **nimconfig** command creates the master, boot, the first network object, **nim_script** with the **/export/nim** directory; the master (**nimesis**) daemon is also started.

As shown in Example 3-4, we do not allow NIM clients to register themselves with the NIM master. The netname attribute value is selected using the IP network address; refer to “Basic naming convention for the NIM lpp_source objects” on page 55 for more information about this topic.

Example 3-4 NIM master initialization

```
root@master:/: nimconfig -a netname=net_10_1_1 -a pif_name=en0 -a netboot_kernel=mp -a
cable_type=tp -a client_reg=no
```

```
0513-071 The nimesis Subsystem has been added.
```

```
0513-071 The nimd Subsystem has been added.
```

```
0513-059 The nimesis Subsystem has been started. Subsystem PID is 491636.
```

If you plan to configure a high availability NIM environment (multiple NIM servers), use **master_net** as netname. This is automatically set by the **niminit** command when the attribute **is_alternate** is set to **yes**, see 4.1, “High Availability Network Installation Manager” on page 124.

Figure 3-1 shows the SMIT nimconfig fast path panel.

```

Configure Network Installation Manager Master Fileset

Type or select values in entry fields.
Press Enter AFTER making all desired changes.

                                     [Entry Fields]
* Network Name                       []
* Primary Network Install Interface   []          +

Allow Machines to Register Themselves as Clients? [yes]          +
Alternate Port Numbers for Network Communications
(reserved values will be used if left blank)
Client Registration                     []          #
Client Communications                   []          #

Esc+1=Help      Esc+2=Refresh      Esc+3=Cancel    Esc+4=List
Esc+5=Reset     Esc+6=Command      Esc+7=Edit     Esc+8=Image
Esc+9=Shell    Esc+0=Exit          Enter=Do

```

Figure 3-1 SMIT nimconfig fast path

Figure 3-2 shows the same SMIT panel after values are entered.

```

Configure Network Installation Manager Master Fileset

Type or select values in entry fields.
Press Enter AFTER making all desired changes.

                                     [Entry Fields]
* Network Name                       [net_10_1_1]
* Primary Network Install Interface   [en0]          +

Allow Machines to Register Themselves as Clients? [no]          +
Alternate Port Numbers for Network Communications
(reserved values will be used if left blank)
Client Registration                     []          #
Client Communications                   []          #

Esc+1=Help      Esc+2=Refresh      Esc+3=Cancel    Esc+4=List
Esc+5=Reset     Esc+6=Command      Esc+7=Edit     Esc+8=Image
Esc+9=Shell    Esc+0=Exit          Enter=Do

```

Figure 3-2 SMIT nimconfig fast path with input

After the initial setup is performed, you can use the `lsnim` command to view the newly created NIM objects, as shown in Example 3-5.

Example 3-5 The basic NIM master objects

```

root@master:/: lsnim
master          machines          master

```

boot	resources	boot
nim_script	resources	nim_script
net_10_1_1	networks	ent

The first object of the machine type is the “master” itself. The boot resource points to the /tftpboot directory and the nim_script resource points to the /export/nim/scripts directory, as shown in Example 3-6. The networks resource contains the IP information network interface on the NIM master, as shown in Example 3-2 on page 59.

Example 3-6 The basic NIM master objects

```

root@master:/: lsnim -l boot
boot:
  class      = resources
  type       = boot
  comments   = represents the network boot resource
  Rstate     = ready for use
  location   = /tftpboot
  alloc_count = 0
  server     = master
  reserved   = yes
root@master:/: lsnim -l nim_script
nim_script:
  class      = resources
  type       = nim_script
  comments   = directory for customization scripts created by NIM
  Rstate     = ready for use
  location   = /export/nim/scripts
  alloc_count = 0
  server     = master
  reserved   = yes

```

The NIM master configuration is stored in Object Data Manager (ODM) classes in /etc/objrepos, the nim_attr, nim_patr and nim_object files. When a machine is added to a NIM environment (both masters and client are machines), the /etc/niminfo file is created. Example 3-7 shows the contents on the NIM master.

Example 3-7 a NIM masters /etc/niminfo file

```

root@master:/: cat /etc/niminfo
export NIM_NAME=master
export NIM_CONFIGURATION=master
export NIM_MASTER_PORT=1058
export NIM_REGISTRATION_PORT=1059
export NIM_MASTER_HOSTNAME=master

```

The value of the NIM_CONFIGURATION variable shows that this is a NIM master. For standard clients, the value will be standalone. The value of the NIM_MASTER_PORT variable represents the TCP port on which the nimesis daemon listens. The NIM_REGISTRATION_PORT (TCP port) will be used for NIM client registration, if this is enabled.

In Example 3-8, you can note the difference between a NIM master's /etc/niminfo file and a NIM client's /etc/niminfo file. The information in the file is primarily used during NIM BOS installation. The main fields that are used for `nimclient` calls are NIM_MASTER_HOSTNAME, NIM_MASTER_PORT, and NIM_REGISTRATION_PORT. The client's NIM name in this example is LPAR55 and its hostname is lpar55 (IP address 10.1.1.55). The NIM master's hostname is master and its IP address is 10.1.1.2.

Example 3-8 NIM client /etc/niminfo file

```
#----- Network Install Manager -----
# warning - this file contains NIM configuration information
#       and should only be updated by NIM
export NIM_NAME=LPAR55
export NIM_HOSTNAME=lpar55
export NIM_CONFIGURATION=standalone
export NIM_MASTER_HOSTNAME=master
export NIM_MASTER_PORT=1058
export NIM_REGISTRATION_PORT=1059
export NIM_SHELL="shell"
export NIM_LICENSE_ACCEPT=yes
export RC_CONFIG=rc.bos_inst
export NIM_BOSINST_RECOVER="/../SPOT/usr/lpp/bos.sysmgmt/nim/methods/c_bosinst_env -a
hostname=lpar55"
export SPOT=master:/export/lpp_source/spot504/usr
export NIM_CUSTOM="/../SPOT/usr/lpp/bos.sysmgmt/nim/methods/c_script -a
location=master:/export/nim/scripts/LPAR55.script"
export NIM_BOS_IMAGE=/SPOT/usr/sys/inst.images/installp/ppc/bos
export NIM_BOS_FORMAT=rte
export NIM_HOSTS=" 10.1.1.55:lpar55 10.1.1.2:master "
export NIM_MOUNTS=" master:/export/lpp_source/spot504:/SPOT/usr/sys/inst.images:dir "
```

Rebuilding and recovering a corrupt /etc/niminfo file

To rebuild the NIM master /etc/niminfo file, use the `nimconfig` command on the master with the `-r` flag:

```
nimconfig -r
```

To rebuild and recover a NIM client /etc/niminfo file, use the `niminit` command on the client:

```
niminit -a master=<MASTER_HOSTNAME> -a name=<CLIENT_NIM_NAME>
```

Specify the NIM master's hostname or IP address, and the NIM client's NIM name (*not* the NIM client's hostname or IP address). As shown in Example 3-9, the NIM master is master and the NIM client is lpar6.

Example 3-9 Initializing the NIM master

```
root@lpar6:/: nimit -v -a master=master -a name=lpar6
```

```
nimit  
Testing if we can access the Master @ master  
Establishing contact with NIM master  
Writing request to master  
Building ninfo file  
Granting master rhost permission  
giving master rhost permissions  
Adding routes from ninfo file  
Adding entry to inittab
```

Tip: To convert an old NIM master into a client:

- ▶ Create a client definition on the NIM master.
- ▶ Remove the /etc/ninfo file (this will remove also the `nim` command from the system).
- ▶ Uninstall the bos.sysmgmt.nim.master fileset.
- ▶ Check whether the bos.sysmgmt.nim.client fileset is installed.
- ▶ Use the `nimit` command to register with the new NIM master (client registration must be enabled for this procedure to work).

In Example 3-10, the NIM master's IP address is specified correctly, but the NIM client's name is spelled differently from what is stored in the NIM database.

Example 3-10 Error message when recreating the NIM client /etc/ninfo file

```
root@lpar55:/: nimit -a master=10.1.1.2 -a name=LpAr5500  
0042-008 NIMkid: Request denied -  
The specified NIM master is not currently configured to  
define machines on your subnet. The machine must be defined  
from the master OR a network corresponding to your subnet must  
be defined on the master before you can add yourself as a client  
to this NIM environment.
```

Tip: The `/etc/NIM.level` file only contains the version of the `bos.sysmgmt.nim.master` fileset, and can be recreated using the `ls1pp` command:

```
ls1pp -L bos.sysmgmt.nim.master | awk '/master/{print $2}'
```

Setting up IP name resolution

Host names (IP labels) used to identify the NIM clients are symbolic names and need to be resolved into IP addresses. This is done by the NIM master using a resolver subroutine (`gethostbyname()`). The method used by the set of resolver subroutines to resolve names depends on the local host configuration. In addition, the organization of the network determines how a resolver subroutine communicates with remote name server hosts (the hosts that resolve names for other hosts).

When creating a NIM machine object, the NIM object name is associated with a hostname. If the NIM master uses Domain Name Server (DNS) to resolve the host name to IP address mapping, the host name will be a Fully Qualified Domain Name (FQDN). Other name resolution methods include flat files (`/etc/hosts`) and Network Information Services (NIS).

Tip: We recommend using local name resolution (`/etc/hosts`), because this will avoid having NIM operation be affected by DNS or NIS service availability.

You can use several methods to ensure that the NIM masters `/etc/hosts` file is used before any DNS, if the `/etc/resolv.conf` file exists. You can include the `NSORDER` variable in the `/etc/environment` file, or you can include a specification line in either the `/etc/irs.conf` file or the `/etc/netsvc.conf` file.

Note: The settings in the `/etc/netsvc.conf` configuration file override the settings in the `/etc/irs.conf` file. The `NSORDER` environment variable overrides the settings in the `/etc/irs.conf` and the `/etc/netsvc.conf` files.

In Example 3-11 on page 66, Example 3-12 on page 66, and Example 3-13 on page 66, the resolver subroutine (`gethostbyname()`) cannot find the host name in the `/etc/hosts` file and continues to search for the host name in DNS.

Add the `NSORDER` variable declaration shown in Example 3-11 on page 66 to the `/etc/environment` to be effective after the next system reboot. All system software that starts at initial program load (IPL) will have the `/etc/environment` variables set at that time.

Example 3-11 NSORDER configuration

```
NSORDER=local,bind
```

The `/etc/netsvc.conf` and `/etc/irs.conf` files are used by the resolver routines as soon as the files exist; see Example 3-12.

Example 3-12 /etc/netsvc.conf configuration

```
hosts=local,bind
```

Notice the syntactical difference between the `/etc/netsvc.conf` and `/etc/irs.conf` files; see Example 3-13.

Example 3-13 /etc/irs.conf configuration

```
hosts local continue
hosts dns
```

Verify auxiliary services (*inetd*, *bootpd* and *tftpd*)

The NIM master uses the **bootpd** (BOOT Protocol) and **tftpd** (Trivial File Transfer Protocol) daemons (services). Both services are normally started by the **inetd** daemon (InterNET master daemon).

Note: For more detailed information about troubleshooting, refer to Chapter 7, “Basic NIM problem determination and tuning” on page 565.

Verify whether the **inetd** daemon is running by using the **lssrc** command, as shown in Example 3-14. Adding the **-ls** flags to the **lssrc** command also shows the services controlled by **inetd** and their status (in our case, we are looking for **bootpd** and **tftpd**).

Example 3-14 Checking the inetd daemon with the lssrc command

```
root@msater:/: lssrc -ls inetd
Subsystem      Group          PID           Status
inetd          tcpip         176238       active

Debug          Inactive

Signal         Purpose
SIGALRM       Establishes socket connections for failed services
SIGHUP        Rereads configuration database and reconfigures services

SIGCHLD       Restarts service in case the service dies abnormally

Service       Command          Arguments          Status
```

tftp	/usr/sbin/tftpd	tftpd -n	active
bootps	/usr/sbin/bootpd	bootpd /etc/bootptab	active
xmquery	/usr/bin/xmtopas	xmtopas -p3	active
time	internal		active
daytime	internal		active
time	internal		active
daytime	internal		active
ntalk	/usr/sbin/talkd	talkd	active
exec	/usr/sbin/rexecd	rexecd	active
login	/usr/sbin/rlogind	rlogind	active
shell	/usr/sbin/rshd	rshd	active
telnet	/usr/sbin/telnetd	telnetd -a	active
ftp	/usr/sbin/ftpd	ftpd	active

The bootpd daemon

Verify that the `/etc/inetd.conf` file contains the line shown in Example 3-15 for the **bootpd** daemon.

Example 3-15 Example of /etc/inetd.conf configuration for bootpd

```
bootps dgram udp wait root /usr/sbin/bootpd bootpd /etc/bootptab
```

The corresponding line in the `/etc/services` file is for the service name to IP port mapping, as shown in Example 3-16.

Example 3-16 Example of /etc/services configuration for bootpd

```
bootps 67/tcp # Bootstrap Protocol Server
```

The **bootpd** daemon will also use the `/etc/bootptab` file when a NIM client is configured to be booted from the NIM master, as shown in Example 3-17.

Example 3-17 /etc/bootptab configured for network boot of a NIM client

```
lpar55:bf=/tftpboot/lpar55:ip=10.1.1.55:ht=ethernet:sa=10.1.1.2:sm=255.255.255.0:
```

The fields in the `/etc/bootptab` file are separated by a colon (`:`) and the attributes are separated from the assigned value by an equal sign (`=`). In Example 3-17, the attributes used by NIM are:

the first field	Hostname or full domain name (for the NIM client)
bf	Boot file name (in the NIM boot resource directory)
ip	Host IP address (for the NIM client)
ht	Hardware type
sa	TFTP server IP address for the boot file
sm	Subnet mask (for the NIM client)

Additional fields that can be used for NIM clients are:

gw	Gateway IP address (for the NIM client)
ha	Hardware address (MAC for the NIM client)

When the **inetd** daemon receives BOOTP requests, it will start the **bootpd** daemon. The **bootpd** daemon reads the `/etc/bootptab` configuration file, and if the request matches one of the entries, the daemon passes the boot file information to the client. The **bootpd** daemon will stay alive (in case other BOOTP requests arrive) for a while (15 minutes is the default).

Each request will be logged to the SYSLOG subsystem, depending on the verbosity/debug level set with one or more **-d** flags in the `/etc/inetd.conf` for the `bootps` services. By default, only a line indicating that the **bootpd daemon** has started will be logged. To activate `info` level SYSLOG messages, append **-d** to the `bootpd` service entry in `/etc/inetd.conf` and refresh **inetd**:

```
refresh -s inetd
```

Example 3-18 Using the -d verbosity level for bootpd

```
bootpd: reading "/etc/bootptab"
bootpd: read 1 entries from "/etc/bootptab"
bootpd: dumped 1 entries to "/etc/bootpd.dump".
bootpd: bootptab mtime is Fri Jun 16 11:38:47 2006
bootpd: Received boot request.
bootpd: request from IP addr 10.1.1.55
bootpd: found 10.1.1.55 lpar55
bootpd: bootfile = /tftpboot/lpar55
bootpd: vendor magic field is 99.130.83.99
bootpd: RFC1048 vendor data ( bp_vend[64] )
bootpd: sending RFC1048-style reply
bootpd: The following addresses are included in the bootp reply
bootpd: Client IP address (bp->bp_ciaddr) = 10.1.1.55
bootpd: Server IP address (bp->bp_siaddr) = 10.1.1.2
bootpd: Gateway IP address (bp->bp_giaddr) = 10.1.1.2
bootpd: Finished processing boot request.
```

In Example 3-18, you can see the request line, followed by a matching NIM created boot file (kernel). The reply to the client is sent including the Server and Gateway IP addresses. Sending the Client IP address might seem unnecessary, but it is also possible to only use the MAC address, without the client knowing about its IP address the first time it is activated for installation.

The tftpd daemon

Verify that the `/etc/inetd.conf` file contains the `tftpd` line, as shown in Example 3-19 on page 69.

Example 3-19 tftpd configuration in /etc/inetd.conf

```
tftp dgram udp6 SRC nobody /usr/sbin/tftpd tftpd -n
```

Also check the `/etc/services` file for the service name and the UDP port, as shown in Example 3-20.

Example 3-20 tftpd definition in /etc/services

```
tftp 69/udp # Trivial File Transfer
```

The **tftpd** daemon uses the `/etc/tftpaccess.ctl` file to determine which directory hierarchy is allowed to share.

Because the TFTP does not specify any authentication, it is mandatory to restrict the **tftpd** daemons file system access to the `/tftpboot` directory for NIM usage. The `/etc/tftpaccess.ctl` file should only contain the following line if you only use **tftpd** for NIM purposes, as shown in Example 3-21.

Example 3-21 Sample /etc/tftpaccess.ctl

```
# NIM access for network boot  
allow:/tftpboot
```

When the **inetd** daemon receives TFTP requests, it will start the **tftpd** daemon to service it, and start the transfer of the boot image file from the `/tftpboot` directory.

To check that the **tftpd** daemon is working, you can use the **tftp** command on the NIM master. Example 3-22 shows how to check the status of the **tftpd** daemon.

Example 3-22 Checking tftpd connection

```
root@master:/: echo "status"|tftp 0  
tftp> Connected to 0.  
Mode: netascii Verbose: off Tracing: off  
Max-timeout: 25 seconds  
tftp>root@master:/:
```

Example 3-23 shows how to display the contents of the `/tftpboot` directory.

Example 3-23 Displaying the contents of the /tftpboot directory

```
root@master:/: tftp -r - 0 /tftpboot
```

```
./../lost+found/spot5305.chrp./LPAR55.infoLPAR55Received 96 Bytes in 0.0  
Seconds
```

Example 3-24 shows how to display the contents of the /tftpboot/LPAR55.info file.

Example 3-24 Displaying the contents of a file using tftp

```
root@master:/: tftp -o - 0 /tftpboot/LPAR55.info  
#----- Network Install Manager -----  
# warning - this file contains NIM configuration information  
#         and should only be updated by NIM  
export NIM_NAME=LPAR55  
.  
.  
.  
Received 1096 Bytes in 0.0 Seconds
```

If the **-v** flag is set in the /etc/inetd.conf file for the tftpd service, for each request **tftpd** will send info level SYSLOG messages. However, the default behavior is *not* to send messages.

The **-v** flag brings detailed information, such as IP addresses, and file transfer information. Example 3-25 shows the messages logged when the **-vi** flags are used for the tftp service entry in /etc/inetd.conf.

Example 3-25 syslogd output, using -vi verbosity level for tftpd

```
tftpd: 10.1.1.55 RRQ <file=Received, mode=/tftpboot/lpar55, recognized options: octet>  
tftpd: Status Read request for 10.1.1.55: /tftpboot/lpar55  
tftpd: Status Transaction completed successfully
```

In Example 3-25, you can see the request line (RRQ), followed by a match for the request with the NIM created boot file. The file is transferred in binary/octet mode to the client.

Examining the NIM log files

The /var/adm/ras directory contains the NIM master log files. To examine these files, you can use the **alog** command, as shown in Example 3-26. The /usr/adm/ras/nimlog file contains information about failed NIM operations. For more detailed information about NIM-related log files, refer to Chapter 7, “Basic NIM problem determination and tuning” on page 565.

Example 3-26 Using the alog command to view the nimlog file

```
root@master:/: alog -f /usr/adm/ras/nimlog -o
```

Basic setup of the NIM master resources

Here we discuss the basic installation resources you will need:

- ▶ The basic NIM installation resources consist of one NIM lpp_source and one spot' these are needed to perform a NIM rte installation.
- ▶ For NIM mksysb installation, the basic installation resources are one NIM mksysb and one spot.

Create a base level (GA) NIM lpp_source

To create a NIM lpp_source object, you need the GA base level AIX filesets. You can copy the AIX CD/DVD filesets to the local disk of the NIM master (or NIM resources server) in several ways.

The current standard for installation fileset directory structures requires images to be organized into subdirectories according to package type and architecture. For example, Backup File Format (BFF) fileset images reside in the install/ppc directory. The **bfcreate** command is copying from a source containing this structure; the destination is required to conform to the same convention. Both the IBM AIX 5L installation CD/DVD and NIM lpp_source directories conform to this standard.

Copying AIX CD/DVD filesets can be done when creating the NIM lpp_source object using the source attribute pointing to the AIX base level installation CD/DVD, as shown in Example 3-27.

Example 3-27 Define lpp_source and copy filesets from CD

```
root@master:/: nim -o define -t lpp_source -a server=master
-a location=/export/lpp_source/lpp5300 -a source=/dev/cd0 lpp5300

Preparing to copy install images (this will take several minutes)...
/export/lpp_source/lpp5300/sysmgtlib.libraries.apps.5.3.0.40.U
. . .
Now checking for missing install images...
All required install images have been found. This lpp_source is now ready.
```

Copying can also be done by using the **bfcreate** command or the SMIT **bfcreate** fast path, and saving the BFF filesets, to the intended NIM lpp_source directory.

The **bfcreate** command can be issued from the command line as follows:

```
bfcreate -d /dev/cd0 -t /export/lpp_source/lpp5300 all
```

Figure 3-3 on page 72 shows the corresponding SMIT **bfcreate** fast path panel after accepting /dev/cd0 as the INPUT device.

```

Copy Software to Hard Disk for Future Installation

Type or select values in entry fields.
Press Enter AFTER making all desired changes.

                                     [Entry Fields]
* INPUT device / directory for software      /dev/cd0
* SOFTWARE package to copy                   [all]           +
* DIRECTORY for storing software package     [/export/lpp_source/lpp5300]
  DIRECTORY for temporary storage during copying [/tmp]
  EXTEND file systems if space needed?       yes             +
  Process multiple volumes?                  yes             +

Esc+1=Help      Esc+2=Refresh      Esc+3=Cancel    Esc+4=List
Esc+5=Reset     Esc+6=Command    Esc+7=Edit      Esc+8=Image
Esc+9=Shell     Esc+0=Exit       Enter=Do

```

Figure 3-3 SMIT nimconfig fast path with input

But it is also possible to mount the CD/DVD and then copy the files manually using a copy program such as **pax** command. The **cdmount** command in Example 3-28 requires that the **cdromd** daemon (controlled by SRC) is running and that the CD is available in the CD-ROM drive.

Example 3-28 Mounting the AIX CD and copying the files using pax

```

root@master:/: cdmount
root@master:/: pax -rw /<CD-ROM mountpoint>/installp/ppc
/export/lpp_source/lpp5300/installp/ppc

```

Make sure that the **simages** attribute for the NIM **lpp_source** is set to **yes**, as shown in Example 3-29. The **prev_state** (Previous State) of **unavailable for use** can be ignored as this point, because this resource is freshly created.

Example 3-29 Attributes of a newly created lpp_source

```

root@master:/: lsnim -l lpp5300
lpp53:
  class      = resources
  type       = lpp_source
  arch       = power
  Rstate     = ready for use
  prev_state = unavailable for use
  location   = /export/lpp_source/lpp5300
  simages    = yes
  alloc_count = 0
  server     = master

```

If you copy the AIX fileset images manually with **bfcreate** or **pax**, you can create the NIM `lpp_source` object directly, as shown in Example 3-30.

Example 3-30 Creating a NIM `lpp_source` from a directory with all AIX filesets

```
root@master:/: nim -o define -t lpp_source -a server=master
-a location=/export/lpp_source/lpp5300 lpp5300
```

Preparing to copy install images (this will take several minutes)...

Now checking for missing install images...

All required install images have been found. This `lpp_source` is now ready.

Removing a NIM `lpp_source`

To remove a NIM `lpp_source`, the object definitions will be removed but the directory and filesets will remain. The following command removes the `lpp5300` NIM object:

```
nim -o remove lpp5300
```

Check a NIM `lpp_source`

After adding or removing software, you must run the NIM check operation on the NIM `lpp_source`. The check operation rebuilds the table of contents (`.toc`) file in the `lpp_source` directory. It also determines whether all filesets are included in the resources to qualify the `lpp_source` for the `simages` attribute, which indicates whether the `lpp_source` contains the images necessary to install the Base Operating System images on a machine; see Example 3-31.

Example 3-31 Check of a NIM `lpp_source`

```
root@master:/: nim -Fo check lpp5304
```

Valid NIM operations on a NIM `lpp_source`

Use the option **-O** (upper case letter O) on the `nim` command to display operations that can be performed on a NIM `lpp_source`, as shown in Example 3-32.

Example 3-32 Check valid NIM operations for a NIM `lpp_source`

```
root@master:/: lsnim -O lpp5300
lpp5300:
  define = define an object
  change = change an object's attributes
  remove = remove an object
  showres = show contents of a resource
  lslpp = list LPP information about an object
  check = check the status of a NIM object
```

lppmgr = eliminate unnecessary software images in an lpp_source
update = add or remove software to or from an lpp_source

Creating a NIM spot object

A Shared Product Object Tree (SPOT) is created through an **installp** process, using a install source which can be either the install CD/DVD or an existing lpp_source. The SPOT is a NIM hierarchy of a /usr file system used during different NIM operations (such as installation) on a NIM client.

To reduce the overall time needed to create an SPOT resource, we recommend to use an existing lpp_source for this purpose. You can either create a “non-/usr” SPOT, or to reduce the SPOT creation time even further, you can create a “/usr” SPOT.

Even though using a /usr SPOT is a quick solution, this means that you can only have the highest AIX level in the environment for all clients. So, if you need to maintain multiple AIX levels, you need individual non-/usr SPOT resources for every AIX level.

Note: You only need to specify the top directory for the SPOT creation; the **nim** command will create a directory with the same name as the NIM spot object name.

Using a NIM lpp_source to create a non-/usr SPOT is recommended if the SPOT is to be used for NIM client installations and maintenance.

Example 3-33 Creating a non-/usr SPOT from a NIM lpp_source

```
root@master:/: nim -o define -t spot -a server=master -a location=/export/spot -a
source=lpp5300 -a installp_flags=-aQg spot5300
```

```
Creating SPOT in "/export/spot" on machine "master" from "lpp5300" ...
```

```
Restoring files from BOS image. This may take several minutes ...
```

```
Installing filesets ...
```

```
Be sure to check the output from the SPOT installation
to verify that all the expected software was successfully
installed. You can use the NIM "showlog" operation to
view the installation log file for the SPOT.
```

```
+-----+
          Pre-installation Verification...
+-----+
```

```
Verifying selections...done
```

Verifying requisites...done
Results...

FAILURES

Filesets listed in this section failed pre-installation verification
and will not be installed.

. . .

WARNINGS

Problems described in this section are not likely to be the source of any
immediate or serious failures, but further actions may be necessary or
desired.

. . .

SUCSESSES

Filesets listed in this section passed pre-installation verification
and will be installed.

Selected Filesets

. . .

bos.mp 5.3.0.0 # Base Operating System Multip...

. . .

Requisites

(being installed automatically; required by filesets listed above)

. . .

bos.rte.boot 5.3.0.0 # Boot Commands

. . .

<< End of Success Section >>

FILESET STATISTICS

464 Selected to be installed, of which:
462 Passed pre-installation verification
2 FAILED pre-installation verification
30 Additional requisites to be automatically installed

492 Total to be installed

+-----+
Installing Software...
+-----+

installp: APPLYING software for:
bos.rte 5.3.0.0

```

. . .
+-----+
                        Summaries:
+-----+

Installation Summary
-----
Name                      Level      Part      Event      Result
-----
. . .
bos.rte                   5.3.0.0   USR       APPLY      SUCCESS
. . .

Checking filesets and network boot images for SPOT "spot5300".
This may take several minutes ...

```

In Example 3-33 on page 74, we have excluded most of the several thousand output lines of the installation process. The remainder are mostly the headers to illustrate the SPOT creation flow.

Note: The creation of an SPOT, by default, produces a large amount of output. We recommend that you visually scan the output to look for non-fatal errors and warnings, in order to analyze and evaluate their impact.

For more information about creating an SPOT, see “Step 7: Defining basic resources” on page 31. For more information about creating a non-/usr SPOT from a mkysyb image, see 5.4.6, “SPOT creation from an existing mkysyb” on page 456.

Note: With AIX 5300-03 ML, creating SPOT resources for AIX 4.3.3.0 and subsequent Maintenance Levels requires the environment variable INST_DEBUG to be set (export INST_DEBUG=yes).

Recreating the NIM spot definition

If the NIM spot definition has been lost (usually when the NIM database has been deleted or corrupted), but the SPOT directory hierarchy is left intact, you can use the command shown in Example 3-34 on page 77 to recreate the definition.

This can also be used to define the NIM spot definition if you have copied a working SPOT to create a new one, such as when using the **pax** command with the hardlink recursive write option (**pax -lrw <source> <destination>**).

Example 3-34 Recreating the NIM spot definition

```
root@master:/: /usr/lpp/bos.sysmgmt/nim/methods/m_mkspot -o -a server=master -a
location=/export/spot -a source=no spot5300
```

Removing the NIM spot

To remove the NIM spot, the object definitions will be removed, and the SPOT directory hierarchy as well. The following command removes the spot5300 NIM object:

```
# nim -o remove spot5300
```

Tip: If you want to remove the NIM spot resource but you want to keep the directory structure, if the SPOT has been defined in a separate file system, simply unmount the file system and then use the preceding command.

Resetting the NIM spot

Use the **reset** operation to change the state of an SPOT, so NIM operations can be performed with it. A reset may be required on an SPOT if an operation was stopped before it completed successfully. The reset operation updates the resource state (Rstate) of the SPOT. After the reset operation is performed, the SPOT's Rstate is set to ready, and you can use the SPOT in subsequent NIM operations:

```
# nim -Fo reset spot5300
```

Checking the SPOT

Use the **check** operation to verify the usability of the SPOT in the NIM environment. The check operation rebuilds the SPOT's network boot images, if necessary:

```
# nim -o check spot5300
```

Checking the contents of the SPOT

Use the **lppchk** operation to verify that software was installed successfully on a SPOT resource, as shown in Example 3-35.

Example 3-35 Checking the LPPs in a NIM spot

```
root@master:/: nim -o lppchk -a show_progress=yes spot5300
```

```
+-----+
|                                     |
|               Performing "lppchk" Operation               |
|-----+-----+
| Performing lppchk operation on machine 1 of 1: master ... |
|-----+-----+
+-----+
```

"lppchk" Operation Summary

Target	Result
-----	-----
master	SUCCESS

Valid NIM operations on a SPOT

Use the option **-O** (upper case letter O) on the **nim** command to display operations can be performed on an SPOT; see Example 3-36.

Example 3-36 Check valid NIM operations for an SPOT

```
root@master:/: lsnim -O spot5300
spot5300:
  reset      = reset an object's NIM state
  define     = define an object
  change     = change an object's attributes
  remove     = remove an object
  cust       = perform software customization
  sync_roots = synchronize roots for all clients using specified SPOT
  showres    = show contents of a resource
  maint      = perform software maintenance
  lslpp      = list LPP information about an object
  fix_query  = perform queries on installed fixes
  showlog    = display a log in the NIM environment
  check      = check the status of a NIM object
  lppchk     = verify installed filesets
```

Remove a NIM master configuration

To remove and redefine a NIM master's configuration, we recommend that you back up your NIM database first, using the following command:

```
/usr/lpp/bos.sysmgt/nim/methods/m_backup_db
```

Example 3-37 Backing up a NIM master configuration

```
root@master:/: /usr/lpp/bos.sysmgt/nim/methods/m_backup_db /tmp/nimdb_backup
a ./etc/objrepos/nim_attr 8 blocks
a ./etc/objrepos/nim_attr.vc 8 blocks
a ./etc/objrepos/nim_object 8 blocks
a ./etc/objrepos/nim_object.vc 8 blocks
a ./etc/NIM.level 1 blocks
a ./etc/niminfo 1 blocks
```

In Example 3-37, the backup data is stored in `/tmp/nimdb_backup`. Unconfigure the NIM master with the **nim** command as shown in Example 3-38 on page 79.

Example 3-38 Unconfigure the NIM master

```
root@master:/: nim -o unconfig master
0513-044 The nimesis Subsystem was requested to stop.
0513-004 The Subsystem or Group, nimd, is currently inoperative.
0513-083 Subsystem has been Deleted.
0513-083 Subsystem has been Deleted.
4 objects deleted
31 objects deleted
```

Defining NIM clients

Before any NIM operation can be performed on a NIM client, it must be defined as a NIM object (machines). The types of NIM client machines that can be managed in the NIM environment are standalone, diskless, and dataless clients.

The term “standalone” in the NIM environment means that clients are not dependent on any NIM resources for functioning. In contrast, diskless or dataless clients need certain resources; refer to 4.8, “Common Operating System Image (COSI) management” on page 298 for more information about this topic.

To create a *standalone* NIM client, you need the hostname and IP address associated with it. The IP address, preferably, should be on a defined NIM network (if it is not, then the network can be created when the client is defined).

In Example 3-39, the hostname is `lpar55` and the NIM machine name is `LPAR55` for readability and debug purposes. Only the interface (`if`) attribute is used in this example; other values are taken from the NIM master definition, such as `platform` and `netboot_kernel`.

Example 3-39 Create a standalone NIM client

```
root@master:/: nim -o define -t standalone -a if1="net_10_1_1 lpar55 0 ent0" LPAR55
root@master:/: lsnim -l LPAR55
LPAR55:
  class           = machines
  type            = standalone
  connect         = shell
  platform        = chrp
  netboot_kernel = mp
  if1             = net_10_1_1 lpar55 0 ent0
  cable_type1    = N/A
  Cstate         = ready for a NIM operation
  prev_state     = ready for a NIM operation
  Mstate         = not running
```

The `if` attribute stores network interface information for a NIM client, and requires a sequence number when specified, in order to distinguish between

multiple network interfaces (`if1`, in Example 3-39 on page 79). Because machines can have multiple network interfaces, NIM allows more than one `if` attribute per machine.

The value for this attribute consists of three required values and a fourth, optional, value (see Example 3-40):

- | | |
|-------------------------------------|---|
| Value 1 [<code>net_10_1_1</code>] | This specifies the name of the NIM network to which this interface connects. If the name of the NIM network is unknown, then the <code>find_net</code> keyword can be used to match the client's IP address to a defined NIM network. If the <code>find_net</code> keyword is used, but NIM does not find a matching network, the optional <code>net_definition</code> attribute should be used to define the network, as well. |
| Value 2 [<code>lpar55</code>] | This specifies the hostname associated with this interface. This hostname is resolved into an IP address on the NIM master, and will be used to set the IP address on the NIM client's interface. |
| Value 3 [<code>0</code>] | This specifies the network adapter hardware MAC address of this interface. If you do not set the MAC address, you can use a value of zero (<code>0</code>), unless broadcasting is used for network boot of the client. |
| Value 4 [<code>ent0</code>] | This specifies the logical device name of the network adapter used for this interface. If this value is not specified, NIM uses a default based on the type of network interface defined. This field is required when the client is defined on a heterogeneous network. |

Example 3-40 does not have the fourth parameter of the `if` attribute.

Example 3-40 Create a standalone NIM client

```
root@master:/: nim -o define -t standalone -a if1="net_10_1_1 lpar55 0" LPAR55
root@master:/: lsnim -l LPAR55
LPAR55:
  class           = machines
  type            = standalone
  connect         = shell
  platform        = chrp
  netboot_kernel = mp
  if1             = net_10_1_1 lpar55 0
  cable_type1     = N/A
  Cstate          = ready for a NIM operation
  prev_state      = ready for a NIM operation
  Mstate          = not running
```

Example 3-41 shows additional machine attributes.

Example 3-41 Create a standalone NIM client

```
root@master:/: nim -o define -t standalone -a platform=chrp -a if1="net_10_1_1 lpar55 0 ent0"
-a cable_type1=tp -a netboot_kernel=mp LPAR55
root@master:/: lsnim -l LPAR55
LPAR55:
class          = machines
type           = standalone
connect        = shell
platform       = chrp
netboot_kernel = mp
if1            = net_10_1_1 lpar55 0 ent0
cable_type1    = tp
Cstate         = ready for a NIM operation
prev_state     = ready for a NIM operation
Mstate         = not running
```

Using SMIT to define NIM machines

Figure 3-4 shows the first step of the SMIT `nim_mkmac` fast path, if you prefer to use this method instead to create a NIM client.

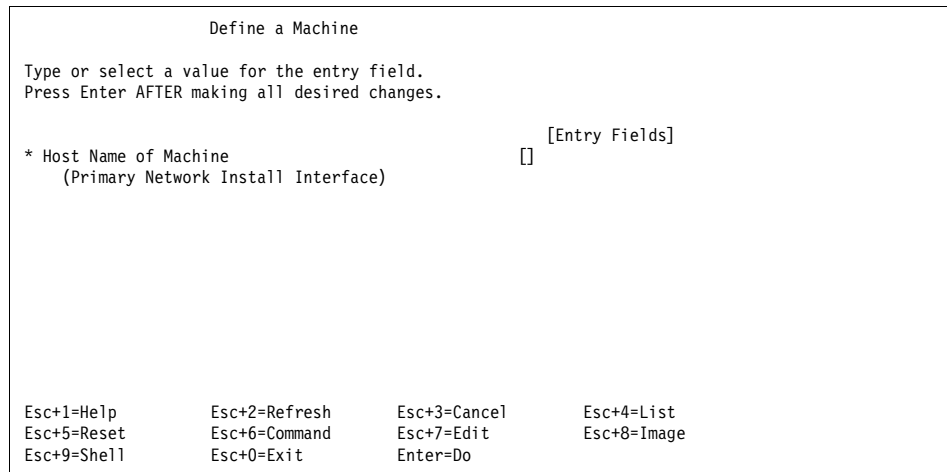

Figure 3-4 SMIT `nim_mkmac` fast path

After typing the NIM client's hostname, you will be presented with the SMIT panel shown in Figure 3-5 on page 82. You can change values here or just accept the default values. In our case we have changed the value in NIM Machine Name from the default `lpar55` to `LPAR55`, and changed the value in Cable type from the default `bnc` to `tp`.

```

Define a Machine

Type or select values in entry fields.
Press Enter AFTER making all desired changes.

                                     [Entry Fields]
* NIM Machine Name                    [LPAR55]
* Machine Type                        [standalone]      +
* Hardware Platform Type              [chrp]           +
Kernel to use for Network Boot        [mp]             +
Communication Protocol used by client  []               +
Primary Network Install Interface
* Cable Type                          tp                +
Network Speed Setting                 []               +
Network Duplex Setting                []               +
* NIM Network                         net_10_1_1
* Host Name                           lpar55
Network Adapter Hardware Address      [0]
Network Adapter Logical Device Name   []
IPL ROM Emulation Device              []               +/
CPU Id                                []
Machine Group                         []               +
Comments                              []

Esc+1=Help      Esc+2=Refresh      Esc+3=Cancel    Esc+4=List
Esc+5=Reset     Esc+6=Command    Esc+7=Edit     Esc+8=Image
Esc+9=Shell     Esc+0=Exit      Enter=Do

```

Figure 3-5 SMIT nim_mkmac fast path

Removing a NIM client definition

To remove a NIM client, first the `nim` command removes the information from the NIM master, then it tries to remove the `/etc/niminfo` file from the NIM client itself; see Example 3-42.

Example 3-42 Removing a NIM client definition from the NIM master

```

root@master:/: nim -o remove LPAR55
warning: 0042-140 m_rmmac: unable to remove the /etc/niminfo file on
"LPAR55"

```

The message after the command is normal when the NIM client is not reachable from the NIM master (such as when it is powered down or otherwise offline).

Installing NIM clients

You can install a NIM client by using several methods:

- ▶ Base Operating System (BOS rte) installation
- ▶ System clone installation (NIM mksysb)
- ▶ Automated customization after a generic BOS install (refer to 5.8.1, “Install time customization” on page 505 for more information about this topic)

Here we demonstrate the simple way: performing a BOS rte installation.

To perform a BOS install with NIM, you need to allocate a NIM lpp_source and a NIM spot to a NIM client, and then start the NIM rte installation. We performed these steps:

1. We used a NIM lpp_source named lpp5304 and a NIM spot named spot5304 to install a NIM client named LPAR55.

```
nim -o allocate -a spot=spot5304 -a lpp_source=lpp5304 LPAR55
```

2. We initiated the install (if the client is already running NIM, it will also set the bootlist to network boot on the client and then reboot the client).

```
nim -o bos_inst -a source=rte -a installp_flags=agX -a  
accept_licenses=yes LPAR55
```

The source is rte for BOS install from the NIM lpp_source. Therefore, the installp_flags attribute is also used, with the Apply (**a**), Prereqs (**g**) and Expand (**X**) file system flags. The accept_licenses attribute must be set to yes; otherwise, the installation will fail.

If the installation is unsuccessful, you need to re-allocate the resources. However, first you will need to reset and deallocate NIM resources (in this case, with the force option):

```
nim -Fo reset LPAR55  
nim -Fo deallocate -a subclass=all LPAR55
```

To view the progress during installation and first boot, you can use the **showlog** operation to the **nim** command:

```
nim -o showlog -a log_type=boot LPAR55
```

Note: Other showlog log_type values are bosinst, devinst, nimerr, boot, niminst, script, lppchk, and alt_disk_install.

Basic SMS menu steps

If the NIM client is not up and running before starting the installation, you need to manually condition (that is, initiate network boot) the client machine.

Reboot the client and access the SMS menus. Set the NIM client's IP address, netmask, gateway (if any), and the IP address of the NIM master. Verify network settings by performing a PING test from the SMS menus. If this is successful, select **Network** from the Select Install/Boot Device menu.

Exit the SMS, and the network installation will start. This starts with the client looking for boot information (BOOTP), loading the kernel and the install programs (TFTP), and then NFS mounting the allocated SPOT. After the SPOT is mounted, the install process follows the same steps as a CD/DVD install.

For a more detailed description, see “SMS and console flow during NIM client installation” on page 84.

Using SMIT to install a standalone client

Here we list the steps you have to perform, starting from the SMIT `nim_bosinst` fast path panel, to install the BOS on a NIM client:

```
root@master:/: smitty nim_bosinst
  Select a TARGET for the operation
    Select the installation TYPE
      Select the LPP_SOURCE to use for the installation
        Select the SPOT to use for the installation
```

Next, you will reach the SMIT panel depicted in Figure 3-6:

```
Install the Base Operating System on Standalone Clients

Type or select values in entry fields.
Press Enter AFTER making all desired changes.

[TOP]                                     [Entry Fields]
* Installation Target                     1par55
* Installation Type                       rte
* SPOT                                    530spot_res
LPP_SOURCE                                [530lpp_res]          +
MKSYSB

BOSINST_DATA to use during installation   []                   +
IMAGE_DATA to use during installation     []                   +
RESOLV_CONF to use for network configuration []                 +
Customization SCRIPT to run after installation []             +
Customization FB Script to run at first reboot []             +
ACCEPT new license agreements?           [no]                 +
Remain NIM client after install?         [yes]                +
Preserve NIM definitions for resources on [yes]                +
[MORE...35]

Esc+1=Help      Esc+2=Refresh      Esc+3=Cancel      Esc+4=List
Esc+5=Reset     Esc+6=Command     Esc+7=Edit        Esc+8=Image
Esc+9=Shell     Esc+0=Exit       Enter=Do
```

Figure 3-6 SMIT `nim_bosinst` fast path

At `ACCEPT new license agreements?` type: `yes`, and then press `Enter`. The SMIT panel should end with `OK`, after which the NIM client will be installed.

SMS and console flow during NIM client installation

At the Initial Program Load (IPL) menu, press the `1` key to access SMS Menu.

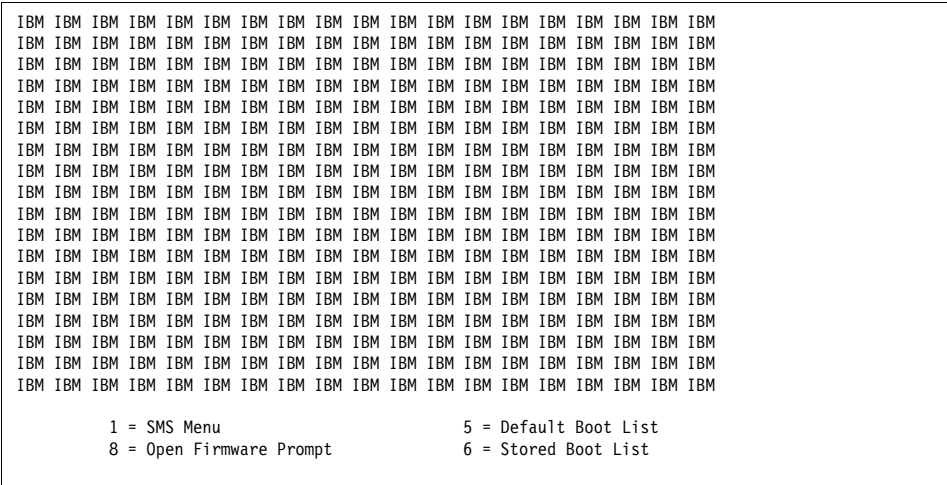

Figure 3-7 Press the 1 key to reach the SMS menu

From the Main Menu, select **2. Setup Remote IPL (Initial Program Load)**, as shown in Figure 3-8.

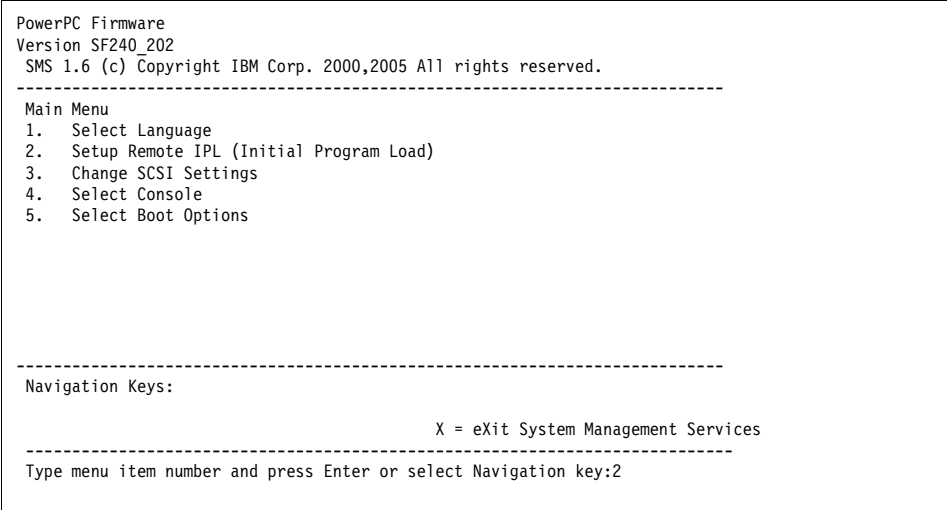

Figure 3-8 Selecting Setup Remote IPL

Select the desired adapter from the NIC Adapters list, in this case **1. Interpartition Logical LAN**, to access the Network Parameters menu as shown in Figure 3-9 on page 86.

```

PowerPC Firmware
Version SF240_202
SMS 1.6 (c) Copyright IBM Corp. 2000,2005 All rights reserved.
-----
NIC Adapters
Device                               Location Code                       Hardware
Address
1. Interpartition Logical LAN         U9131.52A.650E4DG-V4-C30-T1       1a8cf000401e
-----
Navigation keys:
M = return to Main Menu
ESC key = return to previous screen      X = eXit System Management Services
-----
Type menu item number and press Enter or select Navigation key:1

```

Figure 3-9 Interpartition logical LAN option - select 1

From the Network Parameters menu, select **1. IP Parameters** to access the IP Parameters menu, as shown in Figure 3-10.

```

PowerPC Firmware
Version SF240_202
SMS 1.6 (c) Copyright IBM Corp. 2000,2005 All rights reserved.
-----
Network Parameters
nterpartition Logical LAN: U9131.52A.650E4DG-V4-C30-T1
1. IP Parameters
2. Adapter Configuration
3. Ping Test
4. Advanced Setup: B00TP
-----
Navigation keys:
M = return to Main Menu
ESC key = return to previous screen      X = eXit System Management Services
-----
Type menu item number and press Enter or select Navigation key:1

```

Figure 3-10 Network parameters options => 1

1. From the IP Parameters menu select **1. Client IP Address**, to set the Client IP Address.
2. From the IP Parameters menu select **2. Server IP Address**, to set the Server IP Address (NIM master).
3. From the IP Parameters menu select **3. Gateway IP Address**. Leave it if the NIM master and client are on the same IP subnet. Otherwise, enter the default router/gateway for the Client IP Address to access the Server IP Address network.

- From the IP Parameters menu select **4. Subnet Mask**, to set the Subnet Mask for the IP network.
- Press **ESC** and return to the previous menu, as shown in Figure 3-11.

```
PowerPC Firmware
Version SF240_202
SMS 1.6 (c) Copyright IBM Corp. 2000,2005 All rights reserved.
-----
IP Parameters
nterpartition Logical LAN: U9131.52A.650E4DG-V4-C30-T1
1. Client IP Address           [10.1.1.55]
2. Server IP Address          [10.1.1.2]
3. Gateway IP Address         [000.000.000.000]
4. Subnet Mask                 [255.255.255.000]

-----

Navigation keys:
M = return to Main Menu
ESC key = return to previous screen      X = eXit System Management Services
-----
Type menu item number and press Enter or select Navigation key:<esc>
```

Figure 3-11 IP parameters - select 1., 2., 3., 4., and ESC

From the Network Parameters menu, select **3. Ping Test**, as shown in Figure 3-12.

```
PowerPC Firmware
Version SF240_202
SMS 1.6 (c) Copyright IBM Corp. 2000,2005 All rights reserved.
-----
Network Parameters
nterpartition Logical LAN: U9131.52A.650E4DG-V4-C30-T1
1. IP Parameters
2. Adapter Configuration
3. Ping Test
4. Advanced Setup: B00TP

-----

Navigation keys:
M = return to Main Menu
ESC key = return to previous screen      X = eXit System Management Services
-----
Type menu item number and press Enter or select Navigation key:3
```

Figure 3-12 Network parameters option - select 3

From the Network Parameters menu, select **1. Execute Ping Test**, as shown in Figure 3-13.

```
PowerPC Firmware
Version SF240_202
SMS 1.6 (c) Copyright IBM Corp. 2000,2005 All rights reserved.
-----
Ping Test
Interpartition Logical LAN: U9131.52A.650E4DG-V4-C30-T1
Speed, Duplex: auto,auto
Client IP Address: 10.1.1.55
Server IP Address: 10.1.1.2
Gateway IP Address: 000.000.000.000
Subnet Mask: 255.255.255.000
Spanning Tree Enabled: 0
Connector Type: none

1. Execute Ping Test
-----
Navigation keys:
M = return to Main Menu
ESC key = return to previous screen      X = eXit System Management Services
-----
Type menu item number and press Enter or select Navigation key:1
```

Figure 3-13 Ping Test option 1

Two screens are shown, the first one with the configuration information and the second one with the result of the ping test; see Figure 3-14.

```
$PING: args = /vdevice/l-1an@3000001e:10.1.1.2,10.1.1.55,000.000.000.000

NET: Device String - /vdevice/l-1an@3000001e
NET: Ping timeout - 10000 msec

NET: Ping string - h,10.1.1.2,10.1.1.55,000.000.000.000
PING: chosen-network-type = ethernet,auto,none,auto
PING: client IP = 10.1.1.55
PING: server IP = 10.1.1.2
PING: gateway IP = 0.0.0.0

PING: device /vdevice/l-1an@3000001e
PING: loc-code U9131.52A.650E4DG-V4-C30-T1

PING: Ready to ping:
PING: source hardware address is 1a 8c f0 0 40 1e
PING: destination hardware address is 1a 8c f0 0 30 1e
PING: source IP address is 10.1.1.55
PING: destination IP address is 10.1.1.2
```

Figure 3-14 Ping test option 2

Press any key to end the ping test, as shown in Figure 3-15 on page 89.

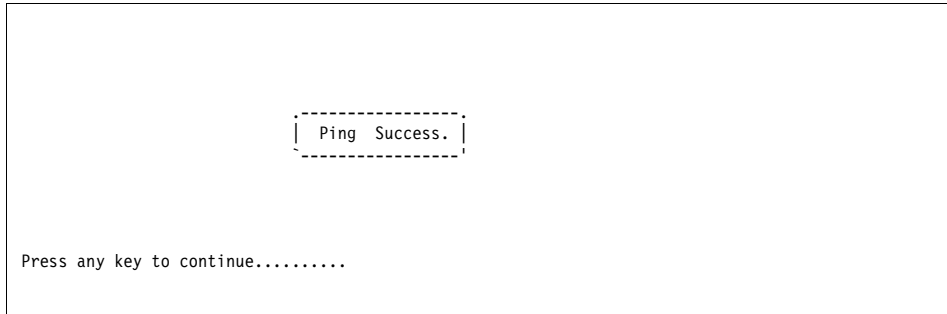

Figure 3-15 Ping test option 3

Next, press **M** from the Ping Test menu to return to the Main Menu; see Figure 3-16.

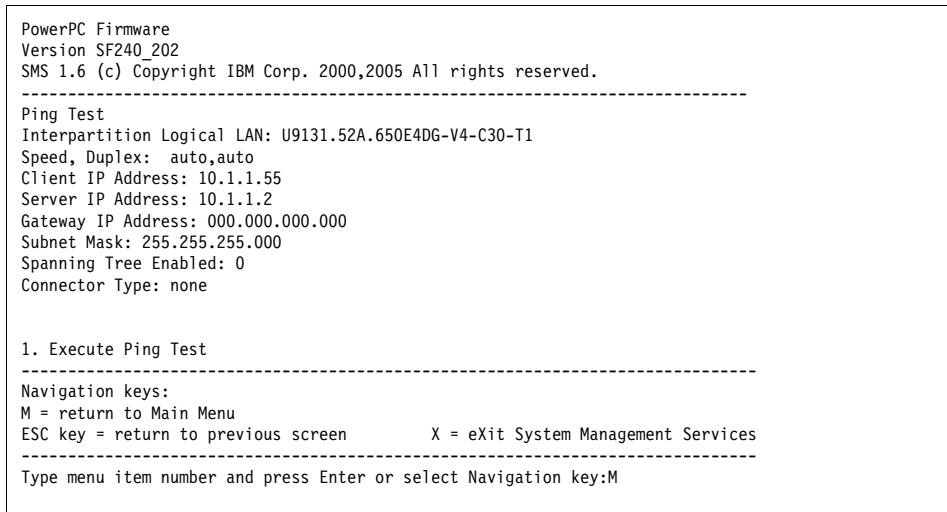

Figure 3-16 Ping test option 4 - press M

From the Main Menu, choose **5. Select Boot Options**, as shown in Figure 3-17 on page 90.

```
PowerPC Firmware
Version SF240_202
SMS 1.6 (c) Copyright IBM Corp. 2000,2005 All rights reserved.
-----
Main Menu
1.  Select Language
2.  Setup Remote IPL (Initial Program Load)
3.  Change SCSI Settings
4.  Select Console
5.  Select Boot Options

-----

Navigation Keys:
                                     X = eXit System Management Services
-----
Type menu item number and press Enter or select Navigation key:5
```

Figure 3-17 Select Boot Options - 5

From the Multiboot menu, choose **1. Select Install/Boot Device**, as shown in Figure 3-18.

```
PowerPC Firmware
Version SF240_202
SMS 1.6 (c) Copyright IBM Corp. 2000,2005 All rights reserved.
-----
Multiboot
1.  Select Install/Boot Device
2.  Configure Boot Device Order
3.  Multiboot Startup <OFF>

-----

Navigation keys:
M = return to Main Menu
ESC key = return to previous screen      X = eXit System Management Services
-----
Type menu item number and press Enter or select Navigation key:1
```

Figure 3-18 Select Install/Boot Device - 1

From the Select Device Type menu, select **6. Network** to choose a network, as shown in Figure 3-19 on page 91.

```
PowerPC Firmware
Version SF240_202
SMS 1.6 (c) Copyright IBM Corp. 2000,2005 All rights reserved.
-----
Select Device Type
1.  Diskette
2.  Tape
3.  CD/DVD
4.  IDE
5.  Hard Drive
6.  Network
7.  List all Devices

-----

Navigation keys:
M = return to Main Menu
ESC key = return to previous screen      X = eXit System Management Services
-----
Type menu item number and press Enter or select Navigation key:6
```

Figure 3-19 Network selection - 6

From the NIC Adapters list, in this case, select **1.** to access the Select Task menu, as shown in Figure 3-20.

```
PowerPC Firmware
Version SF240_202
SMS 1.6 (c) Copyright IBM Corp. 2000,2005 All rights reserved.
-----
Select Device
Device Current Device
Number Position Name
1.      -      Virtual Ethernet
              ( loc=U9131.52A.650E4DG-V4-C30-T1 )

-----

Navigation keys:
M = return to Main Menu
ESC key = return to previous screen      X = eXit System Management Services
-----
Type menu item number and press Enter or select Navigation key:1
```

Figure 3-20 Ethernet selection - 1

From the Select Task menu, select **2. Normal Mode Boot**, as shown in Figure 3-21 on page 92.

```
PowerPC Firmware
Version SF240_202
SMS 1.6 (c) Copyright IBM Corp. 2000,2005 All rights reserved.
-----
Select Task

Virtual Ethernet
( loc=U9131.52A.650E4DG-V4-C30-T1 )

1. Information
2. Normal Mode Boot
3. Service Mode Boot

-----
Navigation keys:
M = return to Main Menu
ESC key = return to previous screen      X = eXit System Management Services
-----
Type menu item number and press Enter or select Navigation key:2
```

Figure 3-21 Normal Mode Boot - 2

From the exit SMS menu select **1. Yes** to let the network installation begin, as shown in Figure 3-22.

```
PowerPC Firmware
Version SF240_202
SMS 1.6 (c) Copyright IBM Corp. 2000,2005 All rights reserved.
-----
Are you sure you want to exit System Management Services?
1. Yes
2. No

-----
Navigation Keys:

X = eXit System Management Services
-----
Type menu item number and press Enter or select Navigation key:1
```

Figure 3-22 Exit the system management services => 1

Figure 3-23 on page 93 shows the installation flow which you can expect from an AIX 5L V5.3 LPAR environment. First the network boot (IPL) is initiated for the LPAR.

```

IBM IBM IBM IBM IBM IBM IBM IBM IBM IBM IBM IBM IBM IBM IBM IBM IBM IBM IBM IBM
IBM IBM IBM IBM IBM IBM IBM IBM IBM IBM IBM IBM IBM IBM IBM IBM IBM IBM IBM IBM
IBM IBM IBM IBM IBM IBM IBM IBM IBM IBM IBM IBM IBM IBM IBM IBM IBM IBM IBM IBM
IBM IBM IBM IBM IBM IBM IBM IBM IBM IBM IBM IBM IBM IBM IBM IBM IBM IBM IBM IBM
IBM IBM IBM IBM IBM IBM IBM IBM IBM IBM IBM IBM IBM IBM IBM IBM IBM IBM IBM IBM
IBM IBM IBM IBM IBM IBM          STARTING SOFTWARE          IBM IBM IBM IBM IBM IBM
IBM IBM IBM IBM IBM IBM          PLEASE WAIT...             IBM IBM IBM IBM IBM IBM
IBM IBM IBM IBM IBM IBM          IBM IBM IBM IBM IBM IBM
IBM IBM IBM IBM IBM IBM IBM IBM IBM IBM IBM IBM IBM IBM IBM IBM IBM IBM IBM IBM
IBM IBM IBM IBM IBM IBM IBM IBM IBM IBM IBM IBM IBM IBM IBM IBM IBM IBM IBM IBM
IBM IBM IBM IBM IBM IBM IBM IBM IBM IBM IBM IBM IBM IBM IBM IBM IBM IBM IBM IBM
IBM IBM IBM IBM IBM IBM IBM IBM IBM IBM IBM IBM IBM IBM IBM IBM IBM IBM IBM IBM
IBM IBM IBM IBM IBM IBM IBM IBM IBM IBM IBM IBM IBM IBM IBM IBM IBM IBM IBM IBM
IBM IBM IBM IBM IBM IBM IBM IBM IBM IBM IBM IBM IBM IBM IBM IBM IBM IBM IBM IBM

BOOTP: chosen-network-type = ethernet,auto,none,auto
BOOTP: server IP = 10.1.1.2
BOOTP: requested filename =
BOOTP: client IP = 10.1.1.55
BOOTP: client HW addr = 1a 8c f0 0 40 1e
BOOTP: gateway IP = 0.0.0.0
BOOTP: device /vdevice/l-1an@3000001e
BOOTP: loc-code U9131.52A.650E4DG-V4-C30-T1

```

Figure 3-23 Initiating the network boot (IPL)

Next, the LPAR issues BOOTP requests to the server IP-address specified in the IP Parameters menu. It receives the BOOTP record information from /etc/bootptab on the NIM master. This record specifies the TFTP server for sending a bootable kernel. The LPAR issues TFTP requests to the server listed in the /etc/bootptab sa field from the NIM master. In Figure 3-24 we can see that the image transferred to the client is approximately 12 MB.

```

IBM IBM IBM IBM IBM IBM IBM IBM IBM IBM IBM IBM IBM IBM IBM IBM IBM IBM IBM IBM

BOOTP: chosen-network-type = ethernet,auto,none,auto
BOOTP: server IP = 10.1.1.2
BOOTP: requested filename =
BOOTP: client IP = 10.1.1.55
BOOTP: client HW addr = 1a 8c f0 0 40 1e
BOOTP: gateway IP = 0.0.0.0
BOOTP: device /vdevice/l-1an@3000001e
BOOTP: loc-code U9131.52A.650E4DG-V4-C30-T1

BOOTP R = 1 BOOTP S = 2
FILE: /tftpboot/LPAR55
FINAL Packet Count = 23852
FINAL File Size = 12211712 bytes.
load-base=0x4000
real-base=0x2000000

Elapsed time since release of system processors: 18292 mins 43 secs

-----
Welcome to AIX.
boot image timestamp: 14:57 06/13

```

Figure 3-24 Bootp request and tftp requests

Then control is passed to the transferred and loaded AIX 5L kernel, as shown in Figure 3-25.

```
BOOTP R = 1 BOOTP S = 2
FILE: /tftpboot/LPAR55
FINAL Packet Count = 23852
FINAL File Size = 12211712 bytes.
load-base=0x4000
real-base=0x2000000

Elapsed time since release of system processors: 18292 mins 43 secs

-----
                        Welcome to AIX.
                        boot image timestamp: 14:57 06/13
                        The current time and date: 07:38:53 06/14/2006
                        number of processors: 1   size of memory: 512MB
boot device: /vdevice/l-lan@3000001e:10.1.1.2,,10.1.1.55,000.000.000.00,00
                        kernel size: 11008898; 32 bit kernel
-----
```

Figure 3-25 Starting the AIX 5L kernel

In this case the installation is made using a NIM mksysb resource, as shown in Figure 3-26.

```
                        Installing Base Operating System

Please wait...

Approximate   Elapsed time
% tasks complete (in minutes)

16           1      13% of mksysb data restored.
```

Figure 3-26 Installing from a mksysb resource

After installing the software, the boot image is created as shown in Figure 3-27 on page 95.

```
Installing Base Operating System

Please wait...

Approximate      Elapsed time
% tasks complete (in minutes)

90              13      Creating boot image.
                Installing Base Operating System
```

Figure 3-27 Creating boot image

The installation is finished and the LPAR is restarted, as shown in Figure 3-28.

```
Licensed Materials - Property of IBM

5765G0300
(C) Copyright International Business Machines Corp. 1985, 2005.
(C) Copyright AT&T 1984, 1985, 1986, 1987, 1988, 1989.
(C) Copyright Regents of the University of California 1980, 1982, 1983, 1985,
1986, 1987, 1988, 1989.
(C) Copyright BULL 1993, 2005.
(C) Copyright Digi International Inc. 1988-1993.
(C) Copyright Interactive Systems Corporation 1985, 1991.
(C) Copyright ISQUARE, Inc. 1990.
(C) Copyright Mentat Inc. 1990, 1991.
(C) Copyright Open Software Foundation, Inc. 1989, 1994.
(C) Copyright Sun Microsystems, Inc. 1984, 1985, 1986, 1987, 1988, 1991.

All rights reserved.
US Government Users Restricted Rights - Use, duplication or disclosure
restricted by GSA ADP Schedule Contract with IBM Corp.
forced unmount of /var
Rebooting . . .
```

Figure 3-28 Installation is finished and LPAR restarted

The newly installed kernel is loaded and the LPAR is restarted, as shown in Figure 3-29 on page 96.

```
-----  
Welcome to AIX.  
boot image timestamp: 07:53 06/14  
The current time and date: 07:55:12 06/14/2006  
number of processors: 1 size of memory: 512MB  
boot device: /vdevice/v-scsi@30000016/disk@810000000000000:2  
kernel size: 13425263; 64 bit kernel  
-----
```

Figure 3-29 New kernel is loaded and the LPAR restarts

3.2 Web-Based System Manager

This section describes how to configure the Network Installation Manager (NIM) master, create the basic installation resources required to install NIM client machines, and manage the resources for diskless and dataless clients using Web-Based System Management (WebSM).

For this procedure you need access from a graphical interface (GUI) such as a local X11 display or a remote X11 client.

3.2.1 Configuring a NIM master through WebSM

Use the following procedure to configure the NIM master, and create the basic installation resources using Web-Based System Management:

1. Insert the AIX 5L V5.3 (or later) Volume 1 CD into the appropriate drive of the designated master machine.
2. Start the Web-Based System Management application with the `wsm` command. You will see the screen shown in Figure 3-30 on page 97.

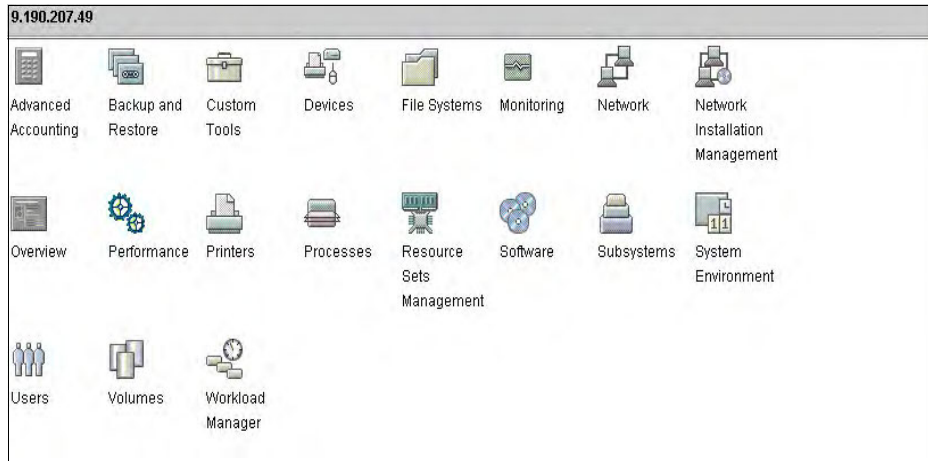

Figure 3-30 Web-Based System Management control panel

In the navigation area, shown in Figure 3-30, select the NIM container. If you are configuring your NIM master for the first time, you will see the screen shown in Figure 3-31.

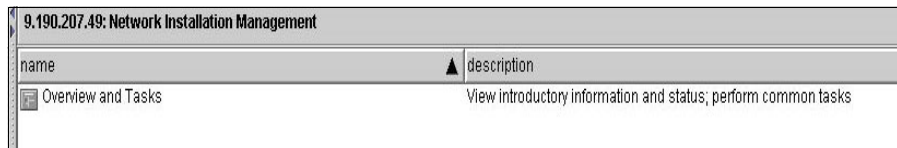
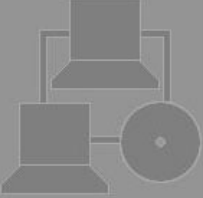

Figure 3-31 Web-Based System Management NIM panel

Select **Overview and Tasks** to open the NIM tasks control panel, which is shown in Figure 3-32 on page 98.

Network Installation Management: Overview and Tasks

Network Installation Management (NIM)



Network Installation Management (NIM) supports the installation of AIX across a network. One machine in a NIM environment must be designated as the master to control the installation of NIM clients. All clients must be defined in the master's database before software can be installed on them.

[More Information](#)

[Configure the Network Installation Management environment](#)

TASKS

STATUS		
	Network Installation Management environment:	Unconfigured
	Number of Machines defined:	0
	Number of Machines Running:	0
	Number of Machines being Processed:	0

Figure 3-32 WSM NIM tasks panel

In the NIM Tasks panel, select **Configure the Network Installation Manager environment** to start the NIM environment configuration wizard. This wizard will guide you step-by-step through the configuration of the NIM master. The first screen is shown Figure 3-33 on page 99.

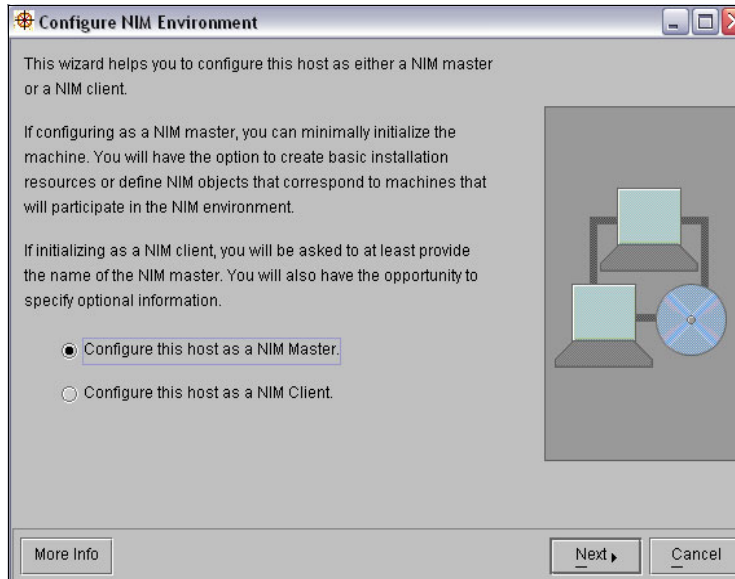

Figure 3-33 Configuring the NIM master

Because you are configuring a NIM master, select the first option **Configure this host as a name Master** and click **Next**.

If you are configuring your NIM Master for the first time and the NIM filesets are not installed, the wizard will ask you to insert the AIX media CD in the CD or DVD drive available to the machine you are configuring; in this case, the screen shown in Figure 3-34 on page 100 will appear.

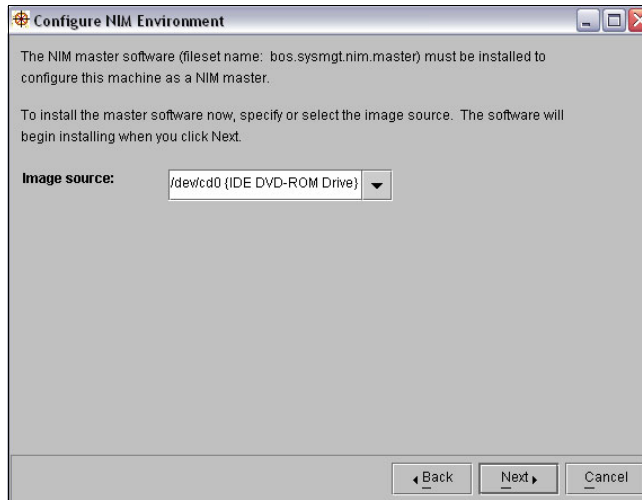

Figure 3-34 Installing the NIM filesets

The wizard will start installing the necessary NIM filesets. The results are similar to those shown in Example 3-43.

Example 3-43 Installing the NIM filesets - results

```

+-----+
          Pre-installation Verification...
+-----+
Verifying selections...done
Verifying requisites...Verifying requisites...done
Results...

WARNINGS
-----
Problems described in this section are not likely to be the source of any
immediate or serious failures, but further actions may be necessary or
desired.

FILESET STATISTICS
-----
    2 Selected to be installed, of which:
      1 Passed pre-installation verification
      1 Already installed (directly or via superseding filesets)
    ----
    1 Total to be installed
:-----+
          Summaries:
+-----+
Pre-installation Failure/Warning Summary

```

Name	Level	Pre-installation Failure/Warning
bos.sysmgmt.nim.client	5.3.0.10	Already superseded by 5.3.0.30

Installation Summary

Name	Level	Part	Event	Result
bos.sysmgmt.nim.master	5.3.0.10	USR	APPLY	SUCCESS

The next step is to configure the primary network interface of the NIM master. The screen shown in Figure 3-35 will appear, where you will define the network name. After you define the network name, press **Next**.

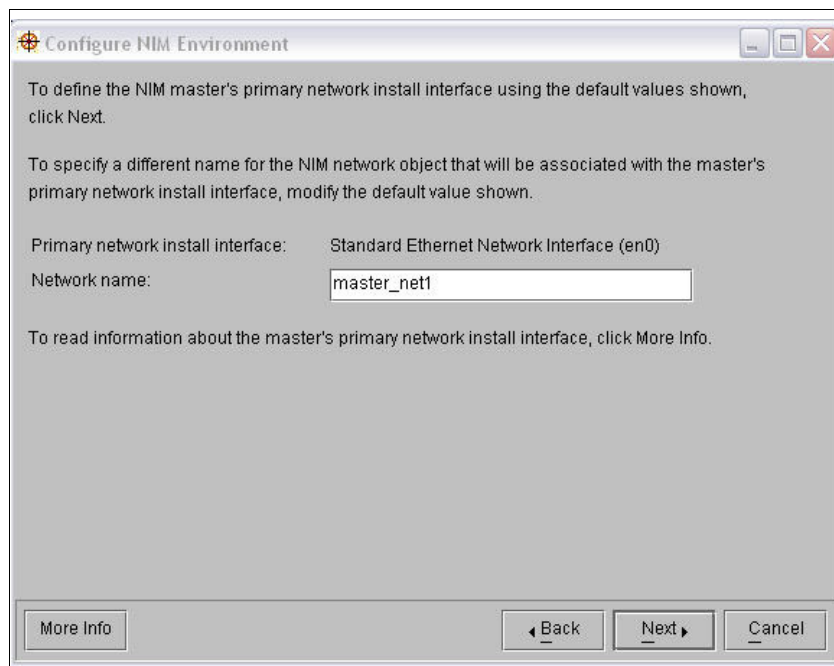

Figure 3-35 Configuring NIM network name.

After the primary NIM network interface and the NIM network name have been configured, you need to configure the NIM resources. After clicking Next (Figure 3-35), the screen shown in Figure 3-36 on page 102 allows you to choose either to configure the NIM resources automatically using the AIX defaults, or to custom configure these resources.

Figure 3-36 illustrates the selection of custom configuration (**Perform additional configuration**) of the NIM resources.

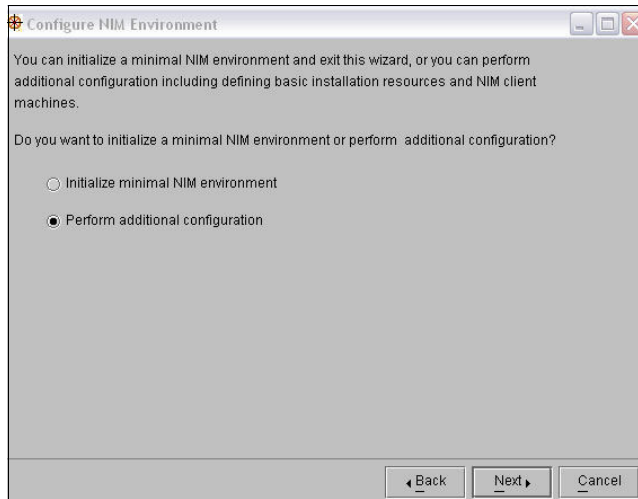

Figure 3-36 NIM master custom configuration

Press **Next** to move to the next few screens, where you can select the tasks that are expected to be performed by the NIM master, as shown in Figure 3-37 on page 103.

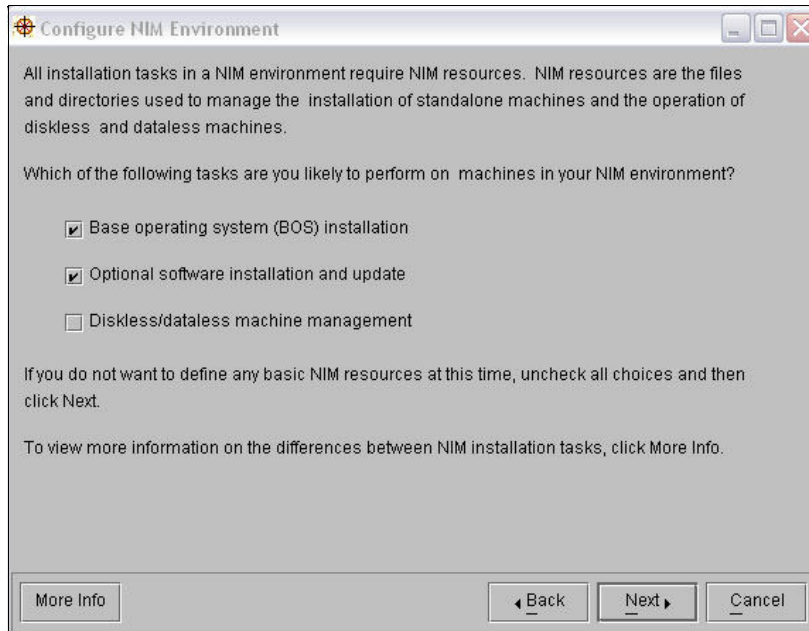

Figure 3-37 NIM master tasks

The first NIM master resource to configure is the NIM lpp_source. In Figure 3-38, you configure the location and name of the NIM lpp_source to build.

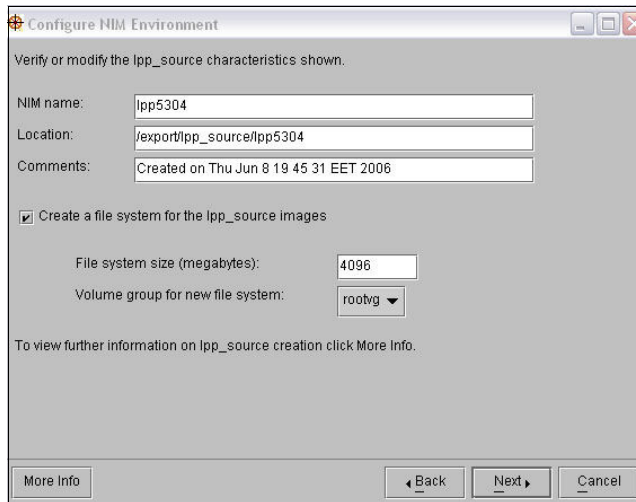
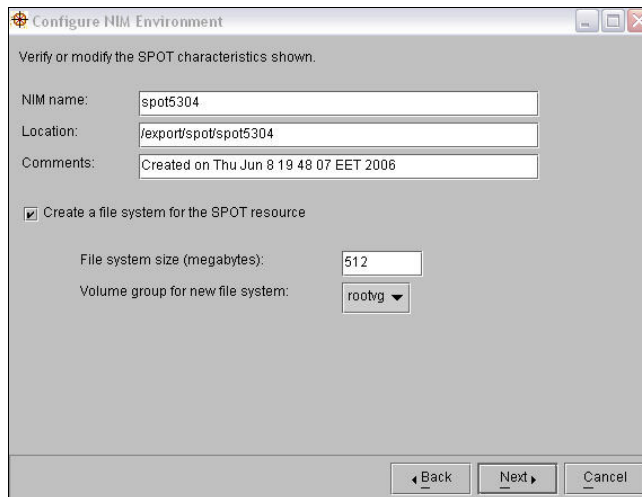

Figure 3-38 NIM master lpp_source configuration

After configuring the NIM lpp_source, the next step is to configure the SPOT. In the screen shown in Figure 3-39, you configure the NIM spot name and location.



The screenshot shows a window titled "Configure NIM Environment" with the following fields and options:

- NIM name: spot5304
- Location: /export/spot/spot5304
- Comments: Created on Thu Jun 8 19 48 07 EET 2006
- Create a file system for the SPOT resource
- File system size (megabytes): 512
- Volume group for new file system: rootvg

Buttons at the bottom: Back, Next, Cancel.

Figure 3-39 NIM master SPOT configuration

After clicking **Next**, you will receive the screen shown in Figure 3-40. Here you can choose to exit the custom configuration screens, or change the configuration parameters that you have just customized.

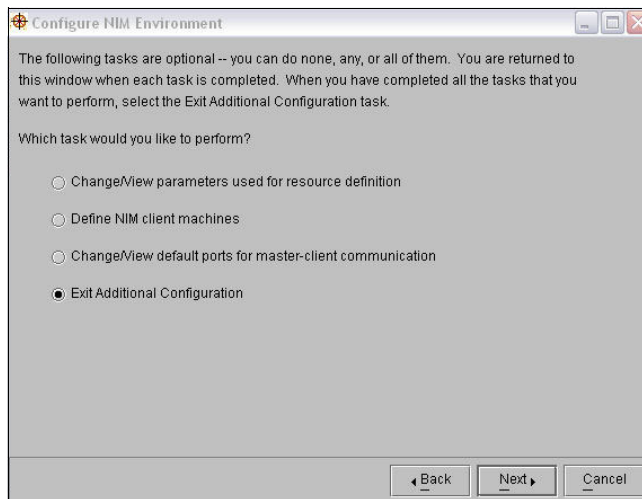

The screenshot shows a window titled "Configure NIM Environment" with the following text and options:

The following tasks are optional -- you can do none, any, or all of them. You are returned to this window when each task is completed. When you have completed all the tasks that you want to perform, select the Exit Additional Configuration task.

Which task would you like to perform?

- Change/View parameters used for resource definition
- Define NIM client machines
- Change/View default ports for master-client communication
- Exit Additional Configuration

Buttons at the bottom: Back, Next, Cancel.

Figure 3-40 Exiting the NIM configuration

In Figure 3-40, you can choose to exit the NIM resources customizing screens. Select **Exit Additional Configuration** and click **Next**.

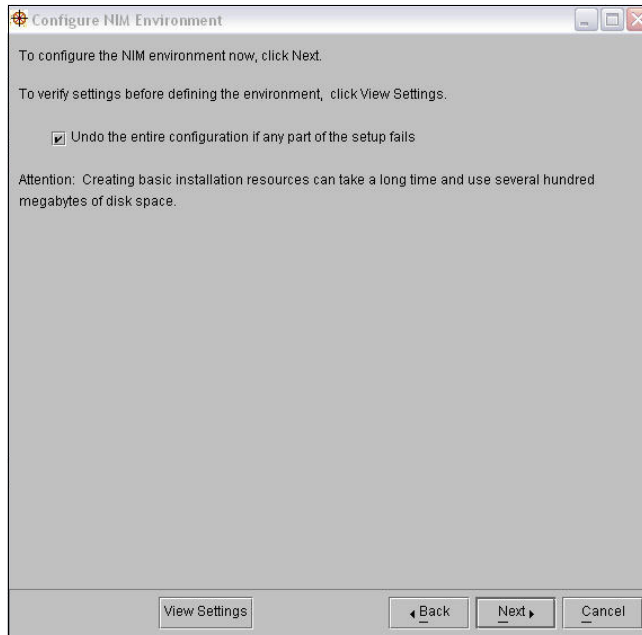

Figure 3-41 WSM NIM configuration wizard - final screen

In the final screen, shown in Figure 3-41, we recommend that you select **Undo the entire configuration if any part of the setup fails**.

In Figure 3-41, you can choose to view the settings you performed before you start executing the NIM environment setup.

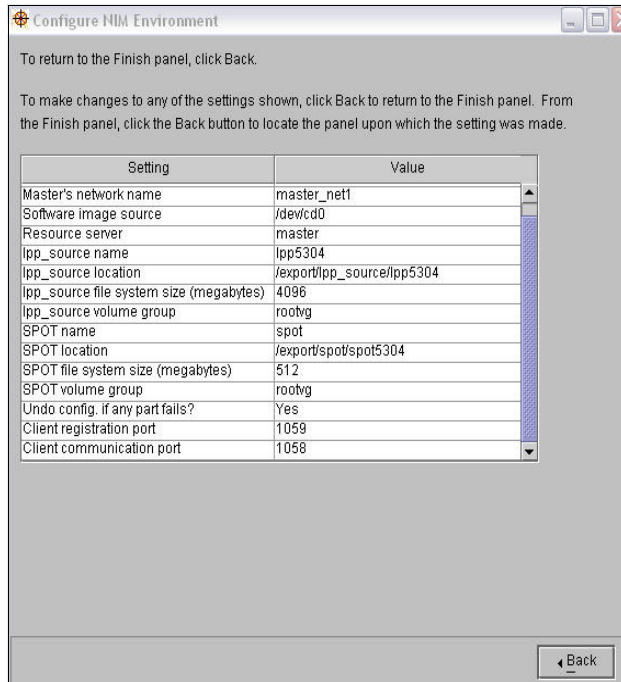

Figure 3-42 Viewing the NIM configuration parameters

In Figure 3-42, you can review the configuration parameters you have set up. After completing your review, click **Back** to return to the previous screen to start executing the setup of the NIM environment.

Note: This procedure produces a large amount of output, especially when creating the SPOT resource. Remember to scan through the output to look for nonfatal errors and warnings that may not be evident from a successful return code.

3.2.2 Configuring NIM clients using Web-Based System Management

After you complete the setup of the NIM master, the next step is to start defining the NIM clients to your NIM master.

In the Web-Based System Management main panel, click the NIM icon to open the NIM panel, then click **Overview and Tasks** to open the following screen.

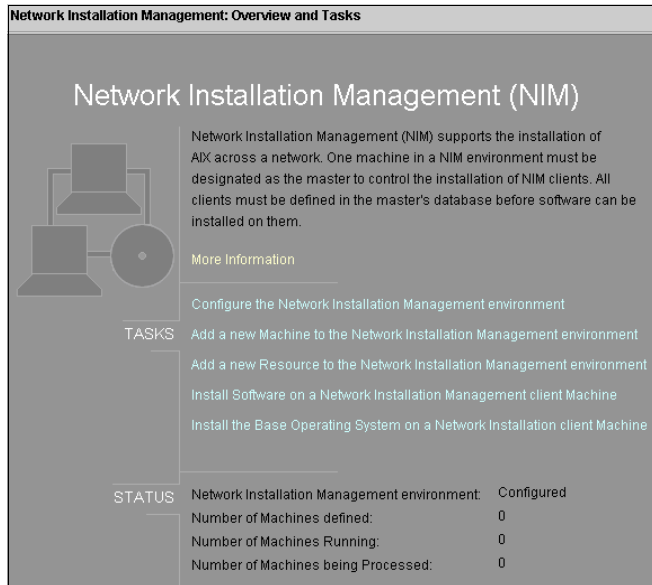

Figure 3-43 NIM tasks panel

In Figure 3-43, click **Add a new Machine to the Network Installation Manager environment**. This will open the dialog box shown in Figure 3-44, where you can enter the hostnames of the NIM clients.

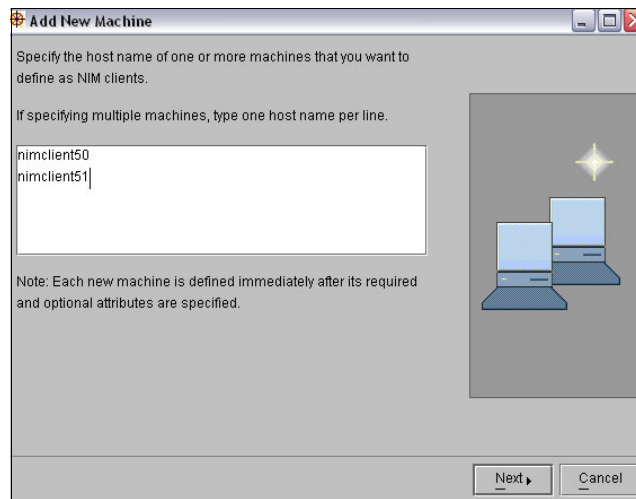

Figure 3-44 NIM client definition

In the **Add New Machine** dialog box shown in Figure 3-44 on page 107, add the hostnames of the NIM Clients you want to define, then click **Next**.

Note: The hostnames of the NIM clients you want to add must be resolvable and preferably exist in the /etc/hostname file. If these hostnames are not defined in the /etc/hostname file, you will receive an error message as shown in Figure 3-45.

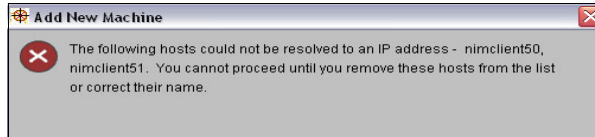

Figure 3-45 Error message when NIM client hostnames cannot be resolved

After you click Next, as in Figure 3-44 on page 107, you will receive the screen shown in Figure 3-46 for each NIM client you defined. In this screen, you are required to define the attributes of the NIM client; then click **Next**.

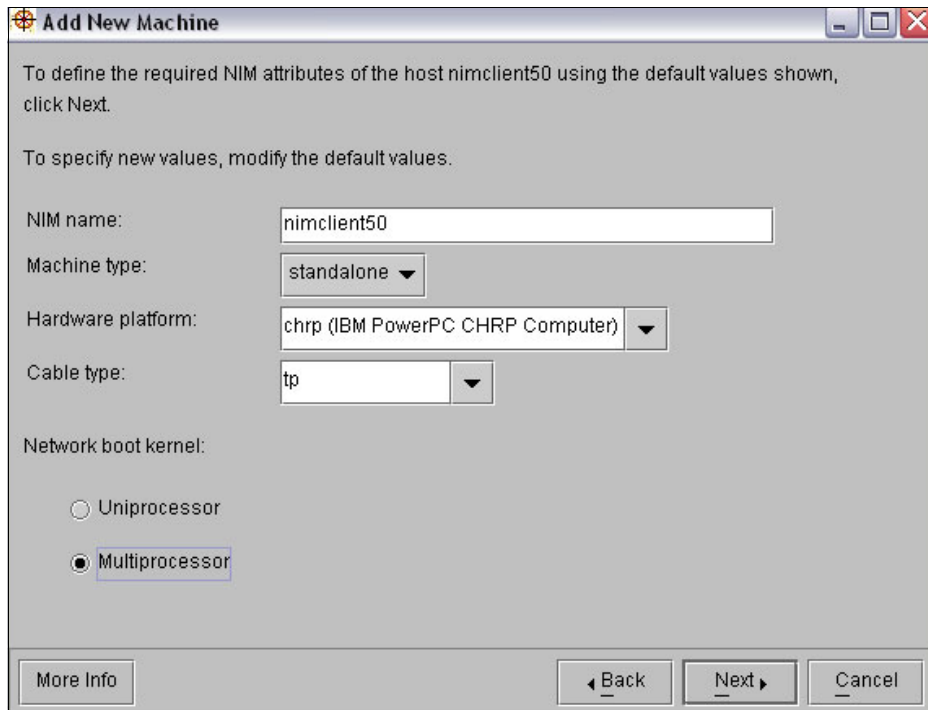
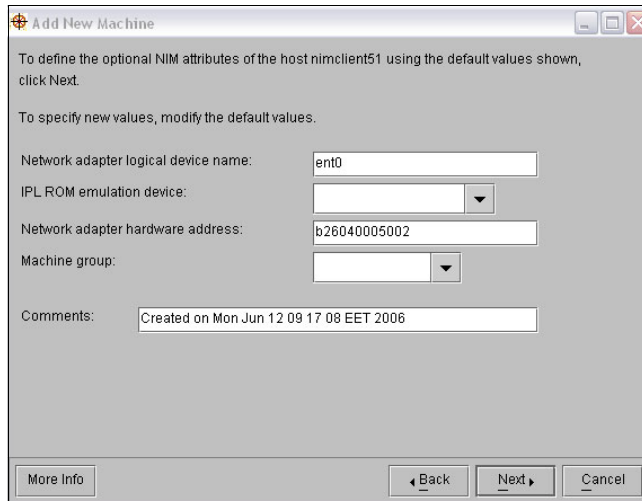

Figure 3-46 NIM client attributes definition

After clicking Next, you will see the screen in Figure 3-47. Define the network interface and its hardware address, then click **Next**.



The screenshot shows a window titled "Add New Machine" with the following content:

To define the optional NIM attributes of the host nimclient51 using the default values shown, click Next.

To specify new values, modify the default values.

Network adapter logical device name:

IPL ROM emulation device: ▼

Network adapter hardware address:

Machine group: ▼

Comments:

Buttons at the bottom: More Info, ◀ Back, Next ▶, Cancel

Figure 3-47 Define network interface and hardware address

Now you see the screen shown in Figure 3-48, informing you that you completed the configuration of the NIM clients.

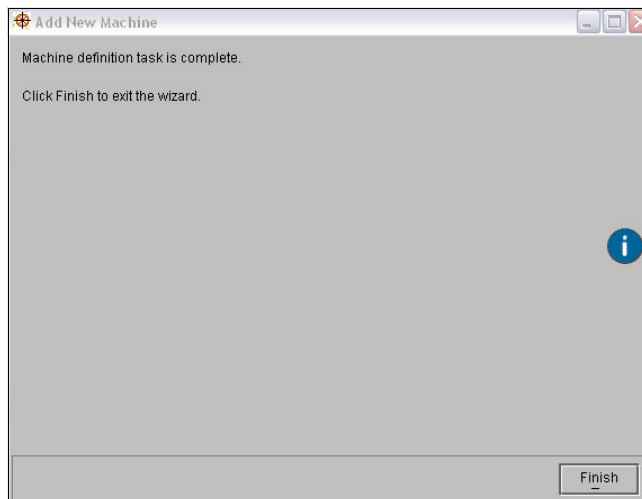

The screenshot shows a window titled "Add New Machine" with the following content:

Machine definition task is complete.

Click Finish to exit the wizard.

Information icon (i) on the right side.

Finish button at the bottom right.

Figure 3-48 Machine definition is complete

Now you need to install the BOS on these clients, as described in the next section.

3.2.3 Installing a NIM client using Web-Based System Management

After you have completed the definition of the NIM clients, you are ready to start installing them. This section illustrates the procedure of installing NIM clients using Web-Based System Management.

To install a NIM client using Web-Based System Management, click the NIM icon in the Web-Based System Management panel, then click **Overview and Tasks**. You will see the screen shown in Figure 3-49. On this screen, click **Install the Base Operating System on a Network Installation client Machine**.

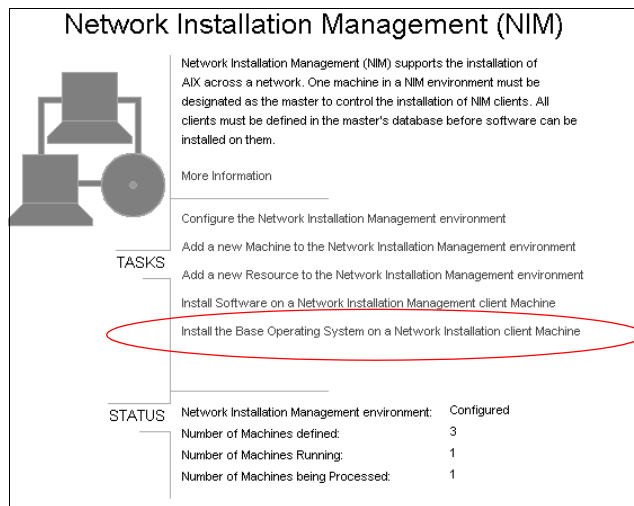

Figure 3-49 Installing the BOS on a NIM client using WebSM

You will see the screen shown in Figure 3-50 on page 111, which contains a list of NIM clients already defined. Select the NIM client you want to install and press **Next**.

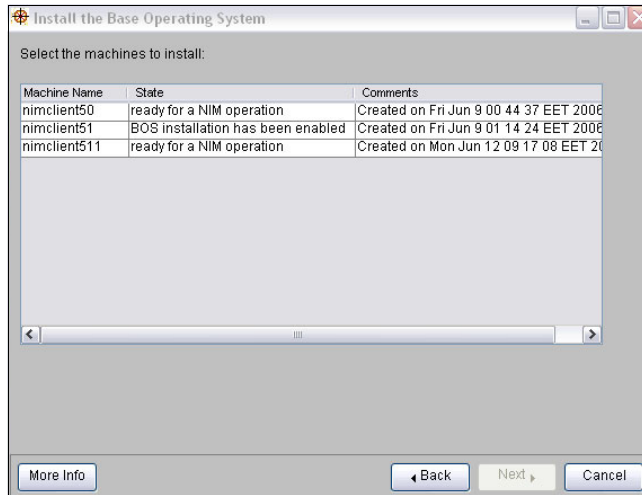

Figure 3-50 Selecting the NIM client you want to install

Now select the installation method from the screen shown in Figure 3-51, then press **Next**. In this example, we chose **Overwrite the existing system** because we are installing an LPAR for the first time.

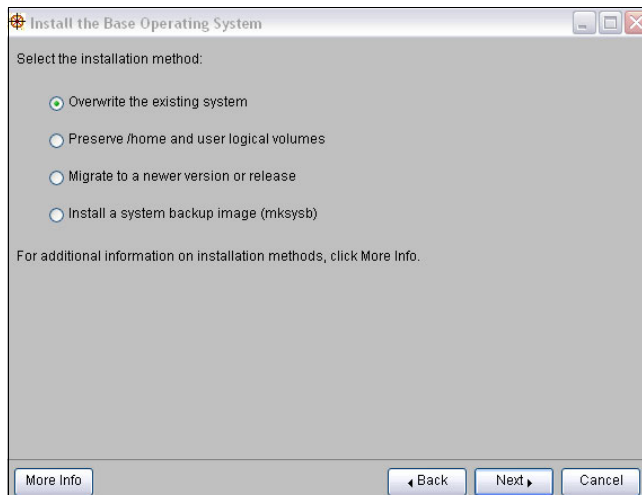

Figure 3-51 Choosing the installation method

Next, choose the SPOT resource you want to use for the installation. In our case, we defined only one SPOT resource, therefore we have only one option in the list shown in Figure 3-52 on page 112. In your case you might have multiple SPOT resources, according to the number of SPOT resources you defined.

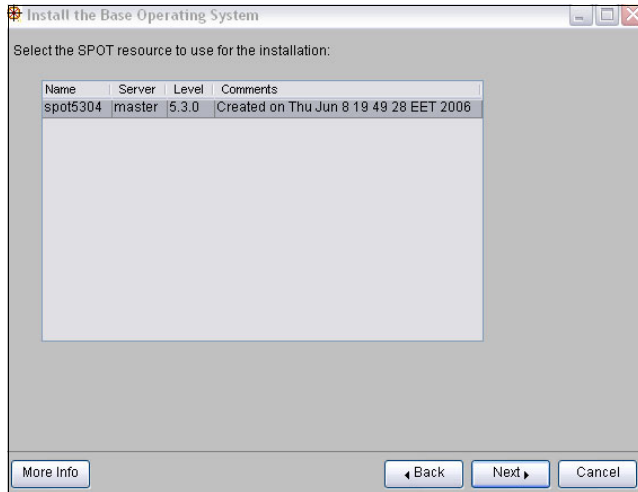

Figure 3-52 Choose SPOT resource that matches the operating system you are installing

Select your SPOT resource (we selected spot5304, as shown in Figure 3-52), then press **Next**.

The following step, shown in Figure 3-53, allows you to choose the lpp_source resource that is relevant to the operating system you are installing. Select the lpp_source resource that matches the operating system you are installing and press **Next**.

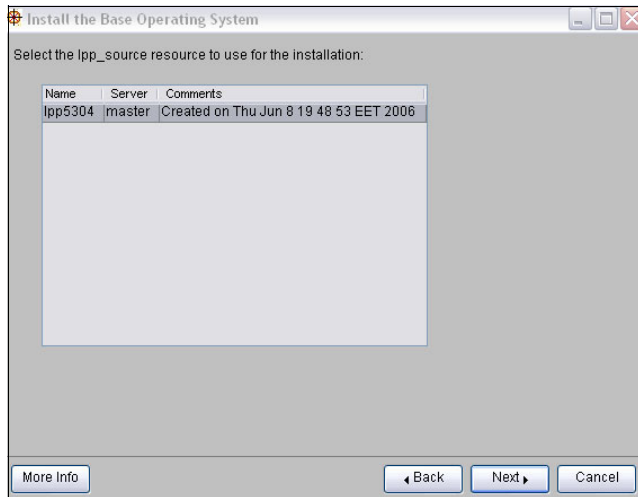

Figure 3-53 Choose the lpp_source

In Figure 3-54, you can choose to undertake a prompted or a non-prompted installation. The screen presents three options; the first and second options are for a non-prompted installation, and the third option is for a prompted installation.

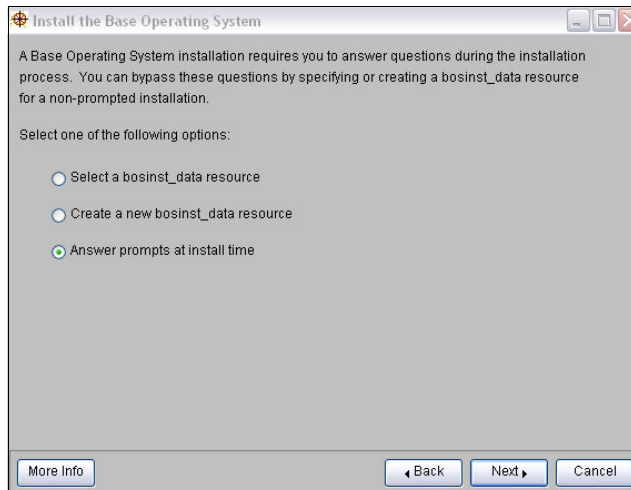

Figure 3-54 Choose between a prompted or a non-prompted installation

In Figure 3-54 you can choose:

- ▶ **Select a bosinst_data resource** if you have defined this resource earlier. We recommend that you define a bosinst_data resource for the installation scenario you need.
- ▶ **Create a new bosinst_data resource** if you did not define one earlier.
- ▶ **Answer prompts at install time** if you want to define installation options manually. Installation options include the console, target LUNs or disks, and BOS Install language.

We choose Answer prompts at install time because we wanted to go through the installation options manually. However, for large environments, we recommend that you use a standard bosinst_data resource to maintain consistency in your environment.

The next screen, Figure 3-55 on page 114, allows you to perform further customization, such as installing additional software packages and running a customization script.

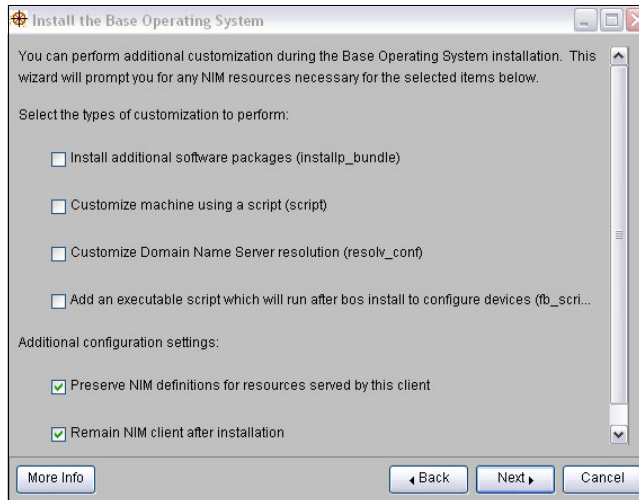

Figure 3-55 Choose the final customization of the installation process

Select the options you want and press **Next**, which will present the screen shown in Figure 3-56.

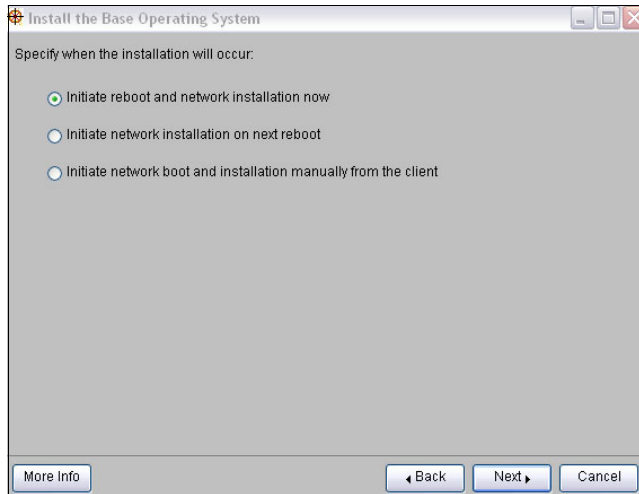

Figure 3-56 Choose the initiate reboot option

In Figure 3-56 you can choose to start the installation immediately by initiating a client reboot from the NIM master, initiate the installation at the next reboot, or initiate the reboot from the client.

We chose the option Initiate reboot and network installation now.

After you press **Next** you will reach the license agreements screen, as shown in Figure 3-57.

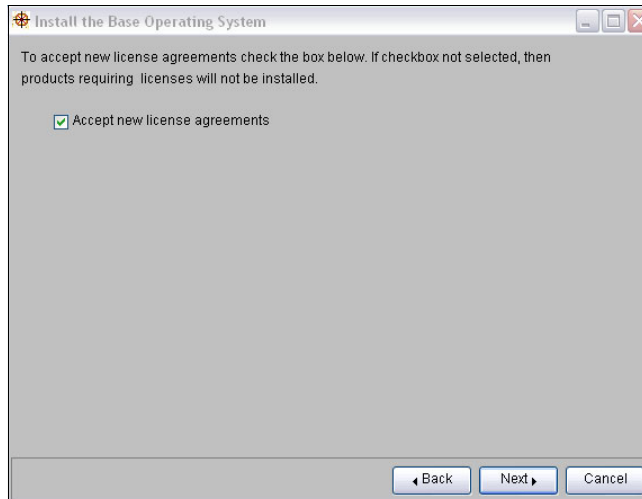

Figure 3-57 The accept new license agreements screen

After you accept the license agreements and press **Next**, the installation process will start according to the option you defined.

3.3 EZNIM

This section shows you how to use the EZNIM command scripts to configure the NIM master, create the basic installation resources required to install NIM client machines, and configure the NIM client machines. For more information about EZNIM, refer to *AIX 5L Version 5.3 Installation and Migration*, SC23-4887.

3.3.1 Configuring a NIM master using `nim_master_setup`

The `nim_master_setup` command installs the `bos.sysmgmt.nim.master` fileset (if it is not already installed), configures the NIM master, and creates the required resources for installation, including a `mksysb` system backup. You can also use the SMIT `eznim_master_panel` fast path for this task.

The default device to copy the AIX software from is `/dev/cd0`, the default volume group to create file systems in is `rootvg`, and the default file system is `/export/nim`.

The script requires that the TCP/IP must be configured using either Token ring or an Ethernet interface. There must be 8 MB free space in the /tmp file system, and the volume group needs at least 1 GB for the NIM file system (/export/nim) and 32 MB for the /tftpboot file system. If the NIM file system or /tftpboot do not exist, they are created. The script will create a basic lpp_source, a SPOT, and a generic mkysb resource.

For batch creation of NIM clients, a simple client.defs template configuration file is also created and placed in the /export/nim directory. The client.defs file can be used by the nim_clients_setup script.

Example 3-44 assumes that all the AIX software has been saved in the /usr/sys/inst.images directory, for example by using the **bfcreate** command (see “Configuring the NIM master using the nimconfig command” on page 60):

```
# bfcreate -d /dev/cd0 -t /usr/sys/inst.images all
```

Example 3-44 Configuring the NIM master using the nim_master_setup command

```
root@master:/: nim_master_setup

##### NIM master setup #####
#
# During script execution, lpp_source and spot resource creation times
# may vary. To view the install log at any time during nim_master_setup,
# run the command: tail -f /var/adm/ras/nim.setup in a separate screen.
#
#####
Creating image.data file...done

Device location is /dev/cd0
Resources will be defined on volume group rootvg
Resources will exist in filesystem /export/nim
Checking for backup software...already installed
Checking /tmp space requirement...done
Installing NIM master fileset...already installed
Defining NIM master...
0513-071 The nimesis Subsystem has been added.
0513-071 The nimd Subsystem has been added.
0513-059 The nimesis Subsystem has been started. Subsystem PID is 663582.
0042-001 nim: processing error encountered on "master":
    0042-023 m_chnet: "default " is not a valid NIM routing stanza

Located volume group rootvg.
Creating /export/nim filesystem...File system created successfully.
1474308 kilobytes total disk space.
New File System size is 2949120
done
Creating /tftpboot filesystem...File system created successfully.
```

```
32560 kilobytes total disk space.
New File System size is 65536
done
Checking /export/nim space requirement...done

Creating list of files to back up
Backing up 24085 files....
24085 of 24085 files backed up (100%)
0512-038 mksysb: Backup Completed Successfully.
Creating mksysb resource 5300-04master_sysb...done
Creating bosinst_data resource 5300-04bid_ow...done
```

```
Please insert AIX 5.2 product media in device /dev/cd0
If the location for AIX 5.2 product media differs from
device /dev/cd0, supply the absolute path BEFORE pressing the ENTER key.
=> /usr/sys/inst.images
Checking /export/nim space requirement...done
Creating lpp_source resource 5301pp_res...
Checking /export/nim space requirement...done
Checking /tftpboot space requirement...done
Creating spot resource 530spot_res...
Creating resource group basic_res_grp...done
```

```
The following resources now exist:
boot                resources        boot
nim_script          resources        nim_script
5300-04master_sysb resources        mksysb
5300-04bid_ow       resources        bosinst_data
5301pp_res          resources        lpp_source
530spot_res         resources        spot
```

NIM master setup is complete - enjoy!

If you get a message stating Error creating /export/nim filesystem - Exiting. it means that there is probably not enough space available in the volume group. In most cases, if the script fails, you can re-run it without removing the created configuration.

The default NIM environment created by the nim_master_setup script is shown in Example 3-45 (AIX 5L V5.3 TL4 on a host named nimmaster).

Example 3-45 nim_master_setup NIM environment

```
master:
  class           = machines
  type            = master
  max_nimesis_threads = 20
```

```

comments      = machine which controls the NIM environment
platform      = chrp
netboot_kernel = mp
if1           = master_net nimmaster 1ABCD000301E
cable_type1   = N/A
Cstate        = ready for a NIM operation
prev_state    =
Mstate        = currently running
serves        = 5300-04bid_ow
serves        = 5300-04master_sysb
serves        = 5301pp_res
serves        = 530spot_res
serves        = boot
serves        = nim_script
master_port   = 1058
registration_port = 1059
reserved      = yes

boot:
class         = resources
type          = boot
comments      = represents the network boot resource
Rstate        = ready for use
location      = /tftpboot
alloc_count   = 0
server        = master
reserved      = yes

master_net:
class         = networks
type          = ent
Nstate        = ready for use
prev_state    = information is missing from this object's definition
net_addr      = 10.1.1.0
snm           = 255.255.255.0

5300-04master_sysb:
class         = resources
type          = mksysb
Rstate        = ready for use
prev_state    = unavailable for use
location      = /export/nim/mksysb/generic_sysb
version       = 5
release       = 3
mod           = 0
oslevel_r     = 5300-04
alloc_count   = 0
server        = master

5300-04bid_ow:
class         = resources
type          = bosinst_data
Rstate        = ready for use

```



```

prev_state = unavailable for use
location   = /export/nim/5300-04bid_ow
alloc_count = 0
server     = master
5301pp_res:
class      = resources
type       = lpp_source
arch       = power
Rstate     = ready for use
prev_state = unavailable for use
location   = /export/nim/lpp_source/5301pp_res
simages    = yes
alloc_count = 0
server     = master
530spot_res:
class      = resources
type       = spot
plat_defined = chrp
arch       = power
Rstate     = ready for use
prev_state = verification is being performed
location   = /export/nim/spot/530spot_res/usr
version    = 5
release    = 3
mod        = 0
oslevel_r  = 5300-04
alloc_count = 0
server     = master
Rstate_result = success
mk_netboot = yes
mk_netboot = yes

```

3.3.2 Configuring NIM clients using `nim_clients_setup`

In order for the `nim_clients_setup` script to work, the `nim_master_setup` script must have completed properly and there must be a NIM `res_group` named `basic_res_grp` and a `client.defs` file containing client definitions.

The `nim_clients_setup` command is used to define NIM clients, allocate the installation resources, and initiate a NIM BOS installation on the clients. You can also use the SMIT `eznim_client_panel` fast path.

Example 3-46 Example client.defs specification file for `nim_clients_setup`

```

# set default values
default:
    machine_type = standalone
    subnet_mask  = 255.255.254.0

```

```
gateway      = 10.1.1.1
network_type = ent
cable_type   = tp
platform     = chrp
netboot_kernel = mp
```

In this scenario, we use the **nimdef** command to create the NIM machines definitions using the `client.defs` file. The **nimdef** command can also be used to display a preview or create a script with NIM commands for later use to create the NIM machines definitions, as shown in Example 3-47.

Example 3-47 Using nimdef to create NIM machines from a client.defs file

```
root@master:/export/nim: nimdef -df client.defs
```

Summary

- 1 Machine will be added to the NIM environment.
- 1 Machine group will be created with new members.
- 1 Network will be added to the NIM environment automatically.
- 1 Network will have new NIM machine interfaces added.

```
+ nim -o define -t standalone -a if1=find_net lpar55 0 ent -a cable_type1=tp
-anet_definition=ent 255.255.254.0 10.1.1.1 -a netboot_kernel=mp -a platform=chrp
v1par2
```

By adding the **-cf** flag, shown in Example 3-48, the **nimdef** command creates a Korn Shell script and displays it to the standard output.

Example 3-48 Using the nimdef command to create a script from a client.defs file

```
root@master:/export/nim: nimdef -cf client.defs
```

```
#!/bin/ksh
set -x
#####
#
# Summary
#
# 1 Machine will be added to the NIM environment.
# 1 Network will be added to the NIM environment automatically.
# 1 Network will have new NIM machine interfaces added.
#
#####

#####
#
# Commands to define new machines in the NIM environment.
```

```
#
#####
nim -o define -t standalone -a if1="find_net lpar55 0 ent" -a cable_type1=tp
-anet_definition="ent 255.255.254.0 10.1.1.1 " -a netboot_kernel=mp -a platform=chrp v1par2
```

If the `basic_res_grp` NIM resource has not been created by the `nim_master_setup` script, it can be created manually as shown in Example 3-49:

Example 3-49 Creating basic_res_grp (manually)

```
root@master:/: nim -o define -t res_group -a bosinst_data=5300-04bid_ow -a
lpp_source=530lpp_res -a spot=530spot_res -a mksysb=5300-04master_sysb basic_res_grp

root@master:/: lsnim -l basic_res_grp
basic_res_grp:
  class   = groups
  type    = res_group
  member1 = 5300-04master_sysb
  member2 = 5300-04bid_ow
  member3 = 530lpp_res
  member4 = 530spot_res
```

To allocate and initiate client installation, use the `nim_clients_setup` command. We use the `nim_clients_setup` command in this case is to allocate the installation resources, and initiate a NIM BOS installation on the clients.

To initiate a change of the NIM client's boot sequence to use network as the first boot device, and to reboot the client, the `-r` option must be used with the `nim_clients_setup` command; see Example 3-50.

Example 3-50 Using the nim_clients_setup script

```
root@master:/export/nim: nim_clients_setup -r
nim_clients_setup
NSORDER=local,bind

Generating list of client objects in NIM environment...
Locating lpar55...done

Checking for resource group basic_res_grp...done
```

The NIM setup for installing the NIM client is now completed, and the client can be restarted to initiate network boot and BOS installation.

Example 3-51 on page 122 shows the NIM client object and the `/etc/bootptab` entry.

Example 3-51 Verifying after the nim_clients_setup script

```
root@master:/export/nim: lsnim -l v1par2
v1par2:
  class      = machines
  type       = standalone
  default_res = basic_res_grp
  connect    = shell
  platform   = chrp
  netboot_kernel = mp
  if1        = master_net lpar55 0 ent
  cable_type1 = tp
  Cstate     = BOS installation has been enabled
  prev_state = ready for a NIM operation
  Mstate     = currently running
  boot       = boot
  bosinst_data = 5300-04bid_ow
  lpp_source  = 530lpp_res
  mkysyb     = 5300-04master_sysb
  nim_script  = nim_script
  spot       = 530spot_res
  cpuid      = 0000C836D700
  control    = master

root@master:/: grep lpar55 /etc/bootptab
lpar55:bf=/tftpboot/lpar55:ip=10.1.1.62:ht=ethernet:sa=10.1.1.2:sm=255.255.255.
0:
```



Network Installation Manager scenarios

This chapter discusses several scenarios and implementation for a Network Installation Manager (NIM) environment. Because NIM is a highly flexible, feature-rich set of tools, these scenarios are considered just a starting point to real NIM usability. Scenarios covered in this chapter describe:

- ▶ High Availability Network Installation Manager (HANIM)
- ▶ Using the OS_install command
- ▶ NIM environment with additional resource servers
- ▶ Using NIM to perform AIX migrations
- ▶ NIM mkysyb migration and nim_move_up POWER5 tools
- ▶ NIM alternate disk migration
- ▶ Network Installation Manager and Linux distributions
- ▶ Thin server and Common OS Image management (COSI)
- ▶ Using HACMP with HANIM
- ▶ NIM and Service Update Management Assistant (SUMA)
- ▶ Backing up clients with NIM
- ▶ How to create bundles, BFF, and RPM packages
- ▶ NIM in a micro-partition using Virtual I/O (VIO) resources
- ▶ Setting up the VIO server and configuring the NIM master in the VIO client
- ▶ Backup and restore of the VIO Server using NIM
- ▶ Using RSCT Peer Domain with HANIM

4.1 High Availability Network Installation Manager

AIX 5L V5.3 introduced High Availability NIM (HANIM) by allowing a backup NIM master on a different machine or LPAR. The backup NIM master takes over when the primary NIM master fails. When the primary NIM master recovers, a fallback operation gives control to the primary NIM master. The failover and fallback operations are initiated by the system administrator.

Unlike a common HA environment, NIM does not perform any heartbeat, and it does not provide file system takeover. HANIM only provides a method for replicating a NIM database and resources, and a failover/fallback procedure in a coordinated manner.

In order to have the latest NIM configuration when the backup NIM master takeover, the system administrator has to perform regular synchronization of the NIM configuration from the primary master to the backup master.

The synchronization process backs up the NIM database on the primary NIM master and copies it to the backup NIM master. The backup is then restored in the backup master.

Note: At the time of writing, only rsh/rshd communication is supported for NIM synchronization.

To configure HANIM, use the following SMIT sequence:

```
# smitty nim
  Perform NIM Administration Tasks
    Manage Alternate Master Environment
```

Or, you can use the `smitty nim_altmstr` SMIT fast path. Example 4-1 shows the SMIT screen on the Alternate NIM master Environment.

Example 4-1 SMIT screen on Alternate Master Environment

Manage Alternate Master Environment

Move cursor to desired item and press Enter.

```
Initialize This Machine as an Alternate Master
Define Another Machine as an Alternate Master
Synchronize an Alternate Master's NIM database
Takeover control of NIM clients from an Alternate Master
Remove an Alternate Master
```

4.1.1 Configuring the alternate (backup) NIM master

In our scenario we have a primary NIM master (lpar1), and we step through the configuration to create the alternate NIM master (in our case, lpar6). This is shown in Figure 4-1.

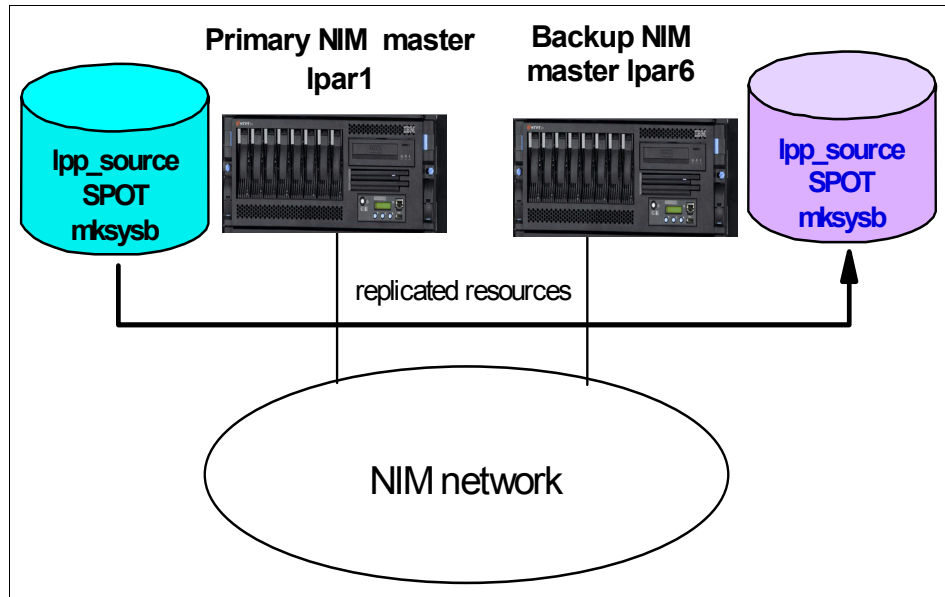

Figure 4-1 High availability NIM

The configuration of the alternate NIM master follows a process similar to the normal NIM master setup:

1. Install the NIM master fileset on the backup NIM master server, lpar6.

You need to install the following filesets:

```
bos.sysmgt.nim.master
bos.sysmgt.nim.spot
```

Note: The `bos.sysmgt.nim.spot` package is optional unless you have diskless or dataless clients.

2. Configure the backup NIM master server as the NIM master.

On the backup NIM master server (lpar6), you need to configure the NIM environment, just like in the primary NIM master server.

```
# smitty nimconfig
```

Important: Before you create lpar6 as the backup NIM master, make sure that the lpar6 is *not* already a NIM client for the primary NIM master. If it is, you need to remove the NIM client definition from the primary NIM master.

3. Copy the lpp_source to the backup NIM master.

You need to create the same file system structure for the lpp_source as in the primary NIM master server.

Copy all the lpp_source directory to the backup NIM master:

From the Primary NIM master,

```
# cd /export/lppsource/lpp-aix5304
# find . -print | backup -iqvf- |rsh lpar6 -l root "cd \
/export/lppsource/lpp-aix5304 ;restore -xqvf-"
```

Important: We recommend that you recreate the .toc file using the **inutoc** command on the /export/lppsource/lpp-aix5304/install/ppc directory. Also check that the files have read permission on the other user, **chmod 644**.

4. Create the lpp_source resource on lpar6 as shown in Example 4-2.

```
# smitty nim_mkres
```

– Select **lpp_source = source device for optional product images**.

Note: You might not need to create the resource. The NIM synchronization process creates the resource if the lpp_source is in place. However, we recommend that you create the resource manually in the backup NIM master.

Example 4-2 Defining the lpp_source resource

Define a Resource

Type or select values in entry fields.
Press Enter AFTER making all desired changes.

```

                                     [Entry Fields]
* Resource Name                       [lpp-aix5304]
* Resource Type                       [lpp_source]
* Server of Resource                   [master]
* Location of Resource                 [/export/lppsource/lpp-aix5304> /
Architecture of Resource              []
Source of Install Images               [] +/
```

Names of Option Packages	<input type="checkbox"/>
Show Progress	<input type="checkbox"/> [yes] +
Comments	<input type="checkbox"/>

You will need to repeat the lpp_source resource creation if you have more than one resource.

5. Create the SPOT resource on lpar6, as shown in Example 4-3.

```
# smitty nim_mkres
  Select "spot = Shared Product Object Tree - equivalent to /usr
  file"
```

Example 4-3 Creating the SPOT resource on lpar6

Define a Resource

Type or select values in entry fields.
Press Enter AFTER making all desired changes.

	[Entry Fields]
* Resource Name	[spot-aix5304]
* Resource Type	spot
* Server of Resource	[master] +
* Source of Install Images	[lpp-aix5304] +
* Location of Resource	[/export/spot] /
Expand file systems if space needed?	yes +
Comments	<input type="checkbox"/>
installp Flags	
COMMIT software updates?	no +
SAVE replaced files?	yes +
AUTOMATICALLY install requisite software?	yes +
OVERWRITE same or newer versions?	no +
VERIFY install and check file sizes?	no +

Note: We recommend that you create the SPOT from the previously defined lpp_source resource, instead of letting the NIM synchronization process create the SPOT. Make sure that you use the same directory as on the primary NIM master.

6. Copy the mkysyb images, bosinst.data, image.data, firstboot script, and /etc/host files. You need to copy all the images (for example, the bosinst.data, image.data first-boot script files) that belong to the NIM resources from the primary NIM master server. The NIM synchronization process creates these

resources in the backup NIM master server if the images or files exist. You also need to copy the /etc/hosts file.

4.1.2 Initialize the backup server as the alternate NIM master server

After having performed the necessary tasks in 4.1.1, “Configuring the alternate (backup) NIM master” on page 125, we can initialize the backup server as the alternate NIM master.

We initialize the alternate NIM master from the backup NIM master. This updates the NIM database on the primary NIM master and updates the backup NIM master’s /etc/niminfo file.

In our example, the backup server is lpar6. Follow the next step and refer to Example 4-4.

Start on lpar6 with the following action:

```
# smitty nim_altmstr
  Initialize This Machine as an Alternate Master
```

Example 4-4 Initializing from the backup NIM master server

Initialize This Machine as an Alternate Master

Type or select values in entry fields.
Press Enter AFTER making all desired changes.

```

                                     [EntryFields]
* This Machine Name                   [lpar6]
* Primary Network Install Interface   [en0] +
* Host Name of Master with which to Initialize [lpar1]

Hardware Platform Type                chrp
Kernel to use for Network Boot        [mp] +
Communication Protocol used to communicate with  [] +
  Alternate Master
Comments                               []

Alternate Port Numbers for Network Communications
  (reserved values will be used if left blank)
Client Registration                    [] #
Client Communications                   [] #
```

After initialization is finished, the NIM database on the primary NIM master is updated, as shown in Example 4-5 on page 129.

Example 4-5 lsnim output on primary NIM master

```
lpar1:/ > lsnim -c machines
master      machines      master
lpar7       machines      standalone
lpar6       machines      alternate_master

lpar1:/ > lsnim -l master
master:
  class          = machines
  type           = master
  max_nimesis_threads = 20
  if_defined     = chrp.mp.ent
  comments       = machine which controls the NIM environment
  platform       = chrp
  netboot_kernel = mp
  if1            = mont_net01 lpar1 0
  cable_type1    = tp
  Cstate         = ready for a NIM operation
  prev_state     = ready for a NIM operation
  Mstate         = currently running
  serves         = BOSINST-lpar7
  serves         = IMAGE-lpar7
  serves         = lpp-aix5304
  serves         = MK-lpar7
  serves         = spot-aix5304
  serves         = alt_disk_install_bnd
  serves         = boot
  serves         = nim_script
  master_port    = 1058
  registration_port = 1059
  reserved       = yes
  is_alternate   = yes
```

The `/etc/niminfo` file in the `lpar6` server is updated with the field export `NIM_ALTERNATE_MASTER=lpar1`, as shown in Example 4-6.

Example 4-6 /etc/niminfo file in lpar6 server

```
lpar6:/ > nimconfig
export NIM_NAME=master
export NIM_CONFIGURATION=master
export NIM_MASTER_PORT=1058
export NIM_REGISTRATION_PORT=1059
export NIM_MASTER_HOSTNAME=lpar6
export NIM_ALTERNATE_MASTER="lpar1"
```

Note: At this point, the NIM database in the backup server lpar6 does not update lpar1 as its alternate NIM master. This will only be updated after the NIM synchronization is executed.

4.1.3 Perform NIM synchronization

NIM synchronization must only be performed after you have completed the tasks described in 4.1.1, “Configuring the alternate (backup) NIM master” on page 125 and 4.1.2, “Initialize the backup server as the alternate NIM master server” on page 128. If any of the resource files are not copied to the backup NIM master server, the NIM synchronization process will not create the resource.

From the primary NIM master server (lpar1), follow these steps (refer to Example 4-7):

```
# smitty nim_almstr
   Synchronize an Alternate Master's NIM database
     Select the Backup NIM master server
```

Example 4-7 Synchronizing an alternate master's NIM database

Synchronize an Alternate Master's NIM database

Type or select values in entry fields.
Press Enter AFTER making all desired changes.

	[Entry Fields]
* Target Name	lpar6
Force	yes +

Note: You need to force the synchronization. If not, the operation will not be successful because it complains that lpar6 is already a NIM master.

In the future updates, the NIM synchronization will copy the respective resource files and/or directories. For example, the lpp_source directory will be copied over to the alternate NIM master. You do not need to manually copy them over as explained in 4.1.1, “Configuring the alternate (backup) NIM master” on page 125.

Example 4-8 on page 131 shows the output when the NIM synchronization is performed. Notice that the alternate_disk_install installp_bundle resource is not created because the alternate_disk_install bundle file was not copied to the backup NIM master. To fix this, copy the alternate_disk_install bundle file to the backup NIM master and perform the NIM synchronization again.

Example 4-8 NIM synchronization output

```
a ./etc/objrepos/nim_attr 16 blocks.
a ./etc/objrepos/nim_attr.vc 16 blocks.
a ./etc/objrepos/nim_object 8 blocks.
a ./etc/objrepos/nim_object.vc 8 blocks.
a ./etc/NIM.level 1 blocks.
a ./etc/niminfo 2 blocks.
The original NIM database was backed up to the
  following location prior to this operation:
    "/export/nim/backups/lpar6.18013606082006.backup"

0513-044 The nimesis Subsystem was requested to stop.
0513-004 The Subsystem or Group, nimd, is currently inoperative.
0513-083 Subsystem has been Deleted.
0513-083 Subsystem has been Deleted.
0518-307 odmdelete: 14 objects deleted.
0518-307 odmdelete: 130 objects deleted.
Restoring the NIM database from /tmp/_nim_dir_233622/mnt0
x ./etc/NIM.level, 9 bytes, 1 media blocks.

The level of the NIM master fileset on this machine is: 5.3.0.40
The level of the NIM database backup is: 5.3.0.40

Level check is successful.

x ./etc/objrepos/nim_attr, 8192 bytes, 16 media blocks.
x ./etc/objrepos/nim_attr.vc, 8192 bytes, 16 media blocks.
x ./etc/objrepos/nim_object, 4096 bytes, 8 media blocks.
x ./etc/objrepos/nim_object.vc, 4096 bytes, 8 media blocks.
x ./etc/NIM.level, 9 bytes, 1 media blocks.
x ./etc/niminfo, 162 bytes, 1 media blocks.
0513-071 The nimesis Subsystem has been added.
0513-071 The nimd Subsystem has been added.
0513-059 The nimesis Subsystem has been started. Subsystem PID is 315556.
Finished restoring the NIM database
Updating master definition in database from lpar6definition
  Updated master attribute platform to chrp
  Updated master attribute netboot_kernel to mp
  Updated master attribute if1 to mont_net01 lpar6 000255AF6C06 ent0
  Updated master attribute cable_type1 to N/A
Finished updating master definition
Resetting machines
  Reset master
  Reset lpar7
  Reset lpar6
Finished resetting machines
Removing NIM client lpar6
Finished removing lpar6
```

```

Resetting NIM resources
Finished resetting NIM resources
Checking NIM resources
  Keeping lpp-aix5304
  Keeping spot-aix5304
Removing alt_disk_install_bnd
  0518-307 odmdelete: 1 objects deleted. from nim_attr (serves attr)
  0518-307 odmdelete: 0 objects deleted. from nim_attr (group memberships)
0518-307 odmdelete: 6 objects deleted. from nim_attr (resource attributes)
  0518-307 odmdelete: 1 objects deleted. from nim_object (resource object)
Finished removing alt_disk_install_bnd
  Keeping MK-lpar7
  Keeping BOSINST-lpar7
  Keeping IMAGE-lpar7
Finished checking NIM resources
Checking NIM SPOTs
checking spot-aix5304
Finished checking SPOTs
nim_master_recover Complete

```

Note: Never perform a NIM synchronization from the backup (alternate) NIM master—NIM synchronization must *always* done at the primary NIM master. Be particularly vigilant when you perform the synchronization.

We recommend that you perform the synchronization any time there is a change in the NIM database, or you can perform regular synchronization via crontab. You can add the following NIM synchronization command into the cron jobs table on lpar1 (you can use the **crontab -e** command).

```
# nim -o sync -a force=yes lpar6
```

After the NIM synchronization is done, the NIM database of the backup NIM master is updated. The lpar1 is updated as the alternate NIM master.

Example 4-9 shows the **lsnim** output in the backup NIM master. A `master_alias` field is added in the NIM database of the lpar6.

Example 4-9 lsnim output from lpar6 server showing its alternate NIM master

```

lpar6:/ > lsrim -c machines
master          machines          master
lpar7           machines          standalone
lpar1          machines         alternate_master

lpar6:/ > lsrim -l master
master:
  class          = machines
  type           = master

```

```

max_nimesis_threads = 20
if_defined          = chrp.mp.ent
comments           = machine which controls the NIM environment
platform           = chrp
netboot_kernel     = mp
if1                 = mont_net01 lpar6 0
cable_type1        = tp
Cstate             = ready for a NIM operation
prev_state         = ready for a NIM operation
Mstate            = currently running
serves             = BOSINST-lpar7
serves             = IMAGE-lpar7
serves             = lpp-aix5304
serves             = MK-lpar7
serves             = spot-aix5304
serves             = boot
serves             = nim_script
master_port        = 1058
registration_port  = 1059
reserved           = yes
master_alias      = lpar6

```

We can also see that the `/etc/niminfo` file in the backup NIM master is again updated, as shown in Example 4-10.

Example 4-10 /etc/niminfo file in lpar6 server after NIM synchronization

```

#----- Network Install Manager -----
# warning - this file contains NIM configuration information
#         and should only be updated by NIM
# machine which controls the NIM environment
export NIM_NAME=master
export NIM_HOSTNAME=lpar6
export NIM_CONFIGURATION=master
export NIM_MASTER_HOSTNAME=lpar6
export NIM_MASTER_PORT=1058
export NIM_REGISTRATION_PORT=1059
export NIM_BOS_IMAGE=/SPOT/usr/sys/inst.images/installp/ppc/bos
export NIM_BOS_FORMAT=rte
export NIM_HOSTS=" 10.1.1.16:lpar6 "
export NIM_MOUNTS=""
export NIM_ALTERNATE_MASTER="lpar1"

```

4.1.4 NIM master takeover

If you have a problem on the primary NIM master and need to activate the alternate NIM master, you can initiate the takeover from the backup server.

Note: Remember to verify that the rsh communication between the primary and alternate master and the clients is enabled.

From the alternate (backup) server, lpar6, follow these steps (see Example 4-11):

```
# smitty nim_almstr
  Takeover control of NIM clients from an Alternate Master
  Select the Primary Server
```

Example 4-11 Takeover from the backup server

```
Takeover control of NIM clients from an Alternate Master
```

Type or select values in entry fields.
Press Enter AFTER making all desired changes.

	[Entry Fields]
* Target Name	lpar1
Force	yes +

During the takeover process, the backup server attempts to contact the NIM client to change its controlling master. The client's /etc/niminfo file will be updated.

The NIM_MASTER_HOSTNAME, NIM_MASTER_HOSTNAME_LIST and the NIM_HOSTS fields in the /etc/niminfo reflect the correct NIM master that this client reports to. Example 4-12 shows the original /etc/niminfo file.

Example 4-12 NIM client's original /etc/niminfo file

```
#----- Network Install Manager -----
# warning - this file contains NIM configuration information
# and should only be updated by NIM
export NIM_NAME=lpar7
export NIM_HOSTNAME=lpar7
export NIM_CONFIGURATION=standalone
export NIM_MASTER_HOSTNAME=lpar1
export NIM_MASTER_PORT=1058
export NIM_REGISTRATION_PORT=1059
export NIM_SHELL="shell"
export NIM_MASTER_HOSTNAME_LIST="lpar1 lpar6"
export NIM_BOS_IMAGE=/SPOT/usr/sys/inst.images/installp/ppc/bos
export NIM_BOS_FORMAT=rte
export NIM_HOSTS=" 10.1.1.74:lpar7 10.1.1.11:lpar1 "
export NIM_MOUNTS=""
```

Example 4-13 shows the updated /etc/niminfo file after the NIM takeover. The changes are shown in bold highlighted text.

Example 4-13 Updated NIM client's /etc/niminfo file after the takeover

```
#----- Network Install Manager -----
# warning - this file contains NIM configuration information
#         and should only be updated by NIM
export NIM_NAME=lpnr7
export NIM_HOSTNAME=lpnr7
export NIM_CONFIGURATION=standalone
export NIM_MASTER_HOSTNAME=lpnr6
export NIM_MASTER_PORT=1058
export NIM_REGISTRATION_PORT=1059
export NIM_SHELL="shell"
export NIM_MASTER_HOSTNAME_LIST="lpnr6 lpnr1"
export NIM_BOS_IMAGE=/SPOT/usr/sys/inst.images/installp/ppc/bos
export NIM_BOS_FORMAT=rte
export NIM_HOSTS=" 10.1.1.74:lpnr7 10.1.1.16:lpnr6 "
export NIM_MOUNTS=""
```

If the NIM client cannot be reached, the backup server updates its database with `sync_required = yes`. Example 4-14 shows the result when lpnr6 is not able to reach lpnr7 during the takeover.

Example 4-14 lsnim output with sync_required set to yes on NIM client -lpnr7

```
lpnr6:/ > lsnim -l lpnr7
lpnr7:
class           = machines
type            = standalone
connect         = shell
platform        = chrp
netboot_kernel = mp
if1             = mont_net01 lpnr7 0
net_settings1   = 100 full
cable_type1     = tp
Cstate          = ready for a NIM operation
prev_state      = not running
Mstate          = not running
Cstate_result   = reset
current_master  = lpnr6
sync_required  = yes
```

The alternate (backup) server also attempts to contact the primary server and update it. However, if the primary server is unreachable, the backup server will update its database with `sync_required =yes`. Example 4-15 on page 136 shows the result when lpnr6 is not able to reach lpnr1 during the takeover. After every

NIM client has been updated without any problem (/etc/niminfo file is updated), the backup NIM master is ready to perform NIM operations as a NIM master.

Example 4-15 Alternate NIM master lsnim output (sync_required = yes)

```
lpar6:/ > lsnim -l lpar1
lpar1:
  class      = machines
  type       = alternate_master
  connect    = shell
  platform   = chrp
  netboot_kernel = mp
  if1        = mont_net01 lpar1 0
  cable_type1 = N/A
  Cstate     = ready for a NIM operation
  prev_state = ready for a NIM operation
  Mstate     = currently running
  sync_required = yes
```

4.1.5 NIM master fallback

After the original (primary) NIM master has been restored for operation, you can fall back the NIM master control from the backup (alternate) server. Follow the same steps described in 4.1.4, “NIM master takeover” on page 133, but perform the commands from the original (primary) NIM master.

From the original primary server, lpar1 (as shown in Example 4-16), follow these steps:

```
# smitty nim_altmstr
  Takeover control of NIM clients from an Alternate Master
  Select the Backup Server
```

Example 4-16 Takeover control of NIM clients

```
Takeover control of NIM clients from an Alternate Master
```

Type or select values in entry fields.
Press Enter AFTER making all desired changes.

```

                                                    [Entry Fields]
* Target Name                                     lpar6
Force                                             yes +
```

4.2 Using the OS_install command

The `OS_install` command can be used to install both AIX clients and Linux clients. In order to install Linux clients, CSM must be installed on the installation server (NIM master).

Note: To support Linux installation using CSM, there are new NIM objects such as `linux_source` and `linux_inst`. In this initial release of Linux installation support from NIM, Linux clients will not be able to function as a NIM client in the same capacity as AIX NIM clients are able to.

Because the Linux installation mechanism depends on DHCP, a NIM standalone client that is to be installed with Linux must (in addition to what is required for AIX network installation) have specified a MAC address. In addition, the client and the master must reside in the same subnet. Also, NIM currently has no capabilities to perform additional system management or “bare-metal” installation of Linux standalone clients. After an allocation is performed, the client must be manually initiated for network installation using the boot parameters displayed after a successful allocation of a `linux_source` resource.

The supported Linux distributions for installation are Red Hat Enterprise Linux (RHEL) V3 and V4, and SUSE Linux Enterprise Server (SLES) V9. To use the `OS_install` command, you need to first install the `libxml2` RPM and then the `osinstall` RPM, as shown in Example 4-17. The RPM packages are located in the `RPMS/ppc` directory of your NIM `lpp_source`.

```
# rpm -ihv libxml2-2.6.17-3.aix5.1.ppc.rpm
# rpm -ihv osinstall-1.0-1.aix5.3.noarch.rpm
```

Example 4-17 Installed files from the osinstall RPM package

```
root@master:/: rpm -ql osinstall
/opt/osinstall/pm/OSInstall.pm
/opt/osinstall/pm/OSInstall/AIX_Resource.pm
/opt/osinstall/pm/OSInstall/Client.pm
/opt/osinstall/pm/OSInstall/Common.pm
/opt/osinstall/pm/OSInstall/Control_Host.pm
/opt/osinstall/pm/OSInstall/Linux_Resource.pm
/opt/osinstall/pm/OSInstall/OS_Resource.pm
/opt/osinstall/pm/OSInstall/Platform_Tools.pm
/opt/osinstall/pm/OSInstall/XMLHandler.pm
/opt/osinstall/schema/nim1.xsd
/usr/sbin/OS_install
/usr/sbin/nimol_bootreplyd
```

You also need to have OpenSSH and OpenSSL installed on the master to perform netboot operations.

```
rpm -i openssl-0.9.7g-2.aix5.1.ppc.rpm
installp -d openssl.base all
installp -d openssl.license all
```

With the `OS_install` command, it is also possible to use W3C XML to describe the NIM environment for the client installation. The Extensible Markup Language Schema Definition (XSD) specification can be found in the `/opt/osinstall/schema/niml.xsd` file.

The network install schema consists of four fundamental elements: `clients`, `os_resources`, `resource_servers`, and `ctrl_hosts`. In addition, there are also the general `osinstall_config` objects.

4.2.1 OS_install basics

`OS_install` lets you define a client or resource, allocate resources to clients and netboot clients. You can also use the SMIT `nim_linux_inst` fastpath to perform Linux client installations with `OS_install`.

Note: The `OS_install` command uses the `/var/osinstall` directory as the root of its file system.

To get started with `OS_install`, you can use the following procedure:

1. Define installation resources.
2. Define controlling hosts for clients.
3. Define clients.
4. List defined objects.
5. Allocate resources to clients.
6. Perform netboot operations on clients.

Figure 4-2 on page 139 shows the NIM `linux_source` input panel for the SMIT `nim_mkres` fastpath selecting `linux_source` (the resource containing the Linux installation images) as the Resource Type.

```

Define a Resource

Type or select values in entry fields.
Press Enter AFTER making all desired changes.

                                [Entry Fields]
* Resource Name                  [linux_source]
* Resource Type                  [linux_source]
* Server of Resource             [master]           +
* Location of Resource          [/export/linux_source] /
* Source of Install Images      [cd0]              +/
* Linux Distribution Name       [RedHatEL-AS]         +
* Linux Distribution Version    []
* Linux Distribution Service Level [GA]          +
Custom Configuration File Template []              /
Comments                        []

```

Figure 4-2 SMIT screen for selecting linux_source as Resource_Type

4.2.2 OS_install resource definition

Defining an **OS_install** resource is similar to creating a SPOT or COSI; refer to “Creating a NIM spot object” on page 74 and 4.8, “Common Operating System Image (COSI) management” on page 298 for details. Before starting, however, you need to have AIX BOS filesets and AIX 5L V5.3 TL5 filesets available.

In Example 4-18, we have copied the filesets to the /export/lpp_source/lpp5305 directory. Then you need to decide on how to name your resource (in our example, we name the resource B0S5305. Then you must specify the operating system type and the version (in our case AIX and 53TL5, respectively).

To create **OS_install** resource objects you use the `define_resource` operation:

```
OS_install -o define_resource -a attr=value ... <object_name>
```

Required attributes: type, version

Optional attributes: source, location, configfile

Example 4-18 OS_install define_resource operation

```

root@master:/: OS_install -o define_resource -a location=/export/lpp_source/bos5305 -a
source=/export/lpp_source/lpp5305 -a type=AIX -a version=53TL5 B0S5305

mkdir /export/lpp_source/bos5305
Mon Jun 26 14:52:28 2006 Executing: (cd /export/lpp_source/lpp5305 && /usr/bin/tar -cf - ./) |
(cd /export/lpp_source/bos5305 && /usr/bin/tar -xf -)

```

4.2.3 OS_install controlling host definition

Every OS_install client needs a controlling host. The controlling host performs netboot operations on the client. In Example 4-19, we use the Hardware Management Console (HMC) for the logical partition (LPAR) which will be the controlling host and client, respectively. The HMC hostname is hmc5 and the client hostname is lpar55.

In Example 4-19, we define the controlling host (`define_ctrl_host`) to be of the type `hmc`, and we use `ssh` as the `communications_method` (thus the need to install `ssh`), and we name the controlling host `HMC5`.

To create OS_install controlling host objects, use the `define_ctrl_host` operation:

```
OS_install -o define_ctrl_host -a attr=value ... <object_name>
```

Required attributes: `communication_method`, `hostname`, `type`

Example 4-19 OS_install define_ctrl_host operation

```
root@master:/: OS_install -o define_ctrl_host -a type=hmc -a hostname=hmc5 -a  
communication_method=ssh HMC5  
Mon Jun 26 14:20:02 2006 Writing HMC5 to repository
```

4.2.4 OS_install client definition

After the controlling host have been defined, we can define the clients. It is possible to define the clients first and then connect them to a controlling host.

Just as for standalone NIM machines, we need to know the IP-address (10.1.1.55), the MAC-address (22:33:80:00:AB:CD), and the NIM networks part with gateway (10.1.1.254) and subnet mask (255.255.255.0). In addition, we need information about the controlling host (HMC5), the LPAR name (lpar55), profile (normal) and managed system (IBM-595-65C5ABC).

To create OS_install client objects, you use the `define_client` operation as shown in Example 4-20 on page 141.

```
OS_install -o define_client -a attr=value ... <object_name>
```

Required attributes: `ip_addr`, `mac_addr`, `gateway`, `subnet_mask`

Optional attributes: `adapter_speed`, `adapter_duplex`, `lpar`, `profile`,
`managed_system`, `disk_location`, `ctrl_host`

Example 4-20 OS_install define_client operation

```
root@master:/: OS_install -o define_client -a ip_addr=10.1.1.55 -a mac_addr=22:33:80:00:AB:CD
-a gateway=10.1.1.254 -a subnet_mask=255.255.255.0 -a ctrl_host=HMC5 -a lpar=lpar55 -a
profile=normal -a managed_system=IBM-595-65C5ABC LPAR55

mkdir /var/osinstall
mkdir /var/osinstall/service_state
mkdir /var/osinstall/service_state/cfg_save
mkdir /var/osinstall/service_state/cfg_data
mkdir /var/osinstall/lock
Mon Jun 26 14:13:59 2006 OSInstall repository not found, create new
Mon Jun 26 14:13:59 2006 Writing LPAR55 to repositor
```

To list OS_install objects (list mode) you use the `-l` flag as shown in Example 4-21.

```
OS_install -l [ -v ] [ -t <object_type> | <object_name> ]
```

The `-v` option shows the XML for the object. Object types are shown in the right column in Example 4-21. Refer to 4.2.6, “OS_install XML repository” on page 143 for more detailed information about this topic.

Example 4-21 OS_install list objects

```
root@master:/: OS_install -l
HMC5          ctrl_host
LPAR55        client
```

4.2.5 OS_install resource allocation and installation

To allocate the resource to install a client using the `OS_install` command, use the allocate operation:

```
OS_install -o allocate -a os_resource=<resource_name> <client_name>
Required attributes:  resource_name, client_name
```

To install a client using `OS_install`, use the netboot operation:

```
OS_install -o netboot <client_name>
```

Note: Do not use the virtual terminal connection from the HMC to the LPAR, because this connection will be used by the netboot operation.

In Example 4-22 on page 142, we install the previously defined LPAR55 with AIX 5L using `OS_install`. We have not configured this NIM master to be able to log in to the HMC without supplying a password, so we will have to enter it at the password prompt.

Example 4-22 OS_install netboot of client

```
root@master:/: OS_install -o netboot LPAR55

Tue Jun 27 16:02:03 2006 Netbooting client LPAR55
Tue Jun 27 16:02:03 2006 Executing: /usr/bin/ssh hscroot@hmc5 'lpar_netboot -f -t ent -m
22338000ABCD -D -s auto -d auto -S 10.1.1.5 -G 10.1.1.254 -C 10.1.1.55 "lpar55" "normal"
"IBM-595-65C5ABC"'
hscroot@hmc5's password:
Tue Jun 27 16:02:10 2006 STDOUT (/usr/bin/ssh): lpar_netboot: Error : Sending Force close..
Tue Jun 27 16:02:13 2006 STDOUT (/usr/bin/ssh): /bin/stty: standard input: Invalid argument
Tue Jun 27 16:02:14 2006 STDOUT (/usr/bin/ssh): # Connecting to LPAR55
Tue Jun 27 16:02:14 2006 STDOUT (/usr/bin/ssh): # Connected
Tue Jun 27 16:02:14 2006 STDOUT (/usr/bin/ssh): # Checking for power off.
Tue Jun 27 16:02:14 2006 STDOUT (/usr/bin/ssh): # Power off the node
Tue Jun 27 16:03:48 2006 STDOUT (/usr/bin/ssh): # Wait for power off.
Tue Jun 27 16:03:48 2006 STDOUT (/usr/bin/ssh): # Power off complete.
Tue Jun 27 16:03:59 2006 STDOUT (/usr/bin/ssh): # Power on LPAR55 to Open Firmware.
Tue Jun 27 16:04:02 2006 STDOUT (/usr/bin/ssh): # Power on complete.
Tue Jun 27 16:04:02 2006 STDOUT (/usr/bin/ssh): # Client IP address is 10.1.1.55.
Tue Jun 27 16:04:20 2006 STDOUT (/usr/bin/ssh): # Server IP address is 10.1.1.2
Tue Jun 27 16:04:20 2006 STDOUT (/usr/bin/ssh): # Gateway IP address is 10.1.1.254.
Tue Jun 27 16:04:21 2006 STDOUT (/usr/bin/ssh): # /vdevice/1-lan@30000003 ping successful.
Tue Jun 27 16:04:22 2006 STDOUT (/usr/bin/ssh): # Network booting install adapter.
Tue Jun 27 16:04:37 2006 STDOUT (/usr/bin/ssh): # bootp sent over network.
Tue Jun 27 16:04:37 2006 STDOUT (/usr/bin/ssh): # Network boot proceeding, lpar_netboot is
exiting.
Tue Jun 27 16:04:37 2006 STDOUT (/usr/bin/ssh): # Finished.
Tue Jun 27 16:04:37 2006 rc for /usr/bin/ssh = 0
```

The OS_install netboot uses the HMC lpar_netboot EXPECT script to restart the LPAR through the controlling host (HMC). The script is almost the same as the bos.sysmgt.nim.master script /usr/sbin/lpar_netboot.

Note: If you define an LPAR as an OS_install client and as a NIM client, you can then manage the LPAR by using both the **nim** and the **OS_install** commands. The **OS_install** netboot operation is especially useful when performing LPAR installations or reinstallations on regular NIM clients.

To monitor the netboot installation using **OS_install** you can use the **monitor_installation** operation, as shown here:

```
OS_install -o monitor_installation <client_name> [-d]
```

If you need to remove a OS_install resource or client, you can use the **remove** operation as shown in Example 4-23 on page 143.

```
OS_install -o remove <object_name>
```

Example 4-23 OS_install remove of client

```
root@master:/: OS_install -o remove LPAR55
Tue Jun 27 14:03:24 2006 Removing object LPAR55
Tue Jun 27 14:03:24 2006 Removed LPAR55 from repository
```

4.2.6 OS_install XML repository

The OS_install information about each client or resource will be stored in the XML repository file `/var/osinstall/xml_repos`, as shown in Example 4-24.

Example 4-24 OS_install xml_repos

```
<?xml version="1.0"?>
<osinstall_config xmlns="http://www.ibm.com/nim1" nim1_version="1.0">
<ctrl_host xmlns="http://www.ibm.com/nim1" name="HMC5">
  <hostname xmlns="http://www.ibm.com/nim1">hmc5</hostname>
  <type xmlns="http://www.ibm.com/nim1">hmc</type>
  <commo_method xmlns="http://www.ibm.com/nim1">ssh</commo_method>
</ctrl_host>
<client xmlns="http://www.ibm.com/nim1" name="LPAR55">
  <ip_addr>10.1.1.55</ip_addr>
  <mac_addr>22:33:80:00:AB:CD</mac_addr>
  <gateway>10.1.1.254</gateway>
  <subnet_mask>255.255.255.0</subnet_mask>
  <adapter_speed>auto</adapter_speed>
  <adapter_duplex>auto</adapter_duplex>
  <partition_info lpar="lpar55" profile="normal" managed_system="IBM-595-65C5ABC"/>
  <ref_ctrl_host ctrl_host_name="HMC5"/>
</client>
```

Detailed messages from running the `OS_install` command are written to the `/var/osinstall/event_log` file.

4.3 NIM environment with additional resource servers

If your environment consists of multiple nodes or a complex network, you can consider configuring NIM resource servers to help offload your NIM master. As mentioned in Chapter 2, “Network Installation Manager definitions and concepts” on page 7, a NIM resource server can be any standalone client (machine) configured as a server for a particular resource (for example, `lpp_source` or `SPOT`).

Consider configuring additional resource servers in these cases:

- ▶ You have a complex environment with many nodes, and you need to offload your NIM master.
- ▶ You have a complex network with multiple LANs, routers and firewalls for simplifying network administration and security (one resource server per LAN).
- ▶ You have IBM System p5 servers with multiple partitions in each CEC, and you want to use POWER™ hypervisor-managed VLANs to offload the external (client) network. You can find specific information on NIM and VIO in 4.13, “NIM and Virtual I/O (VIO)” on page 373.

4.3.1 Configuring a resource server

In our scenario, we have an LPAR in the IBM @server p670 server configured as our NIM master, and two NIM clients (LPARs) in one IBM System p p520 server. The two NIM clients are VIO clients as well. We have a Shared Ethernet Adapter (SEA) configured in the VIO server to allow external network communication with the NIM master. Refer to Figure 4-3.

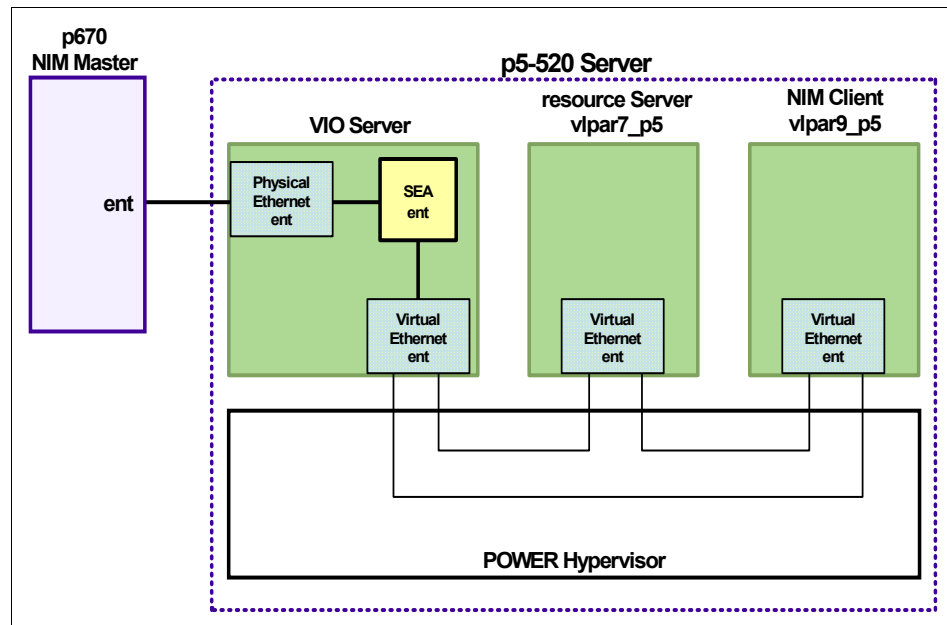

Figure 4-3 NIM master and resource server setup

We configure one of the NIM clients, `v1par7_p5`, as the resource server serving the SPOT and `mksysb` resources to the other NIM client, `v1par9_p5` (both `v1par7_p5` and `v1par9_p5` reside inside the same `p5` server).

- ▶ Defining a SPOT resource in a standalone client

Before creating the SPOT, remember to allocate the disk space for the SPOT creation in the resource server, `v1par7_p5`. We recommend that you create a file system for the SPOT (for example, `/export/spot`).

Note: Remember that the NIM master is able to communicate with the resource server either through `rsh` or `nimsh`. Also verify that NFS is enabled.

Steps through the SMIT to create the SPOT resource (see Example 4-25):

- ▶ From the NIM master, `lpar1`

```
smitty nim_mkres
  Select "spot = Shared Product Object Tree - equivalent to /usr
  file"
```

Example 4-25 Define a SPOT resource with `v1par7_p5` as the resource server

```

                                Define a Resource
Type or select values in entry fields.
Press Enter AFTER making all desired changes.

* Resource Name                    [Entry Fields]
* Resource Type                    [SPOT-AIX53-Clust01]
* Server of Resource              [v1par7_p5] +
* Source of Install Images         [LPPSRC-AIX53] +
* Location of Resource             [/export/spot] /
Expand file systems if space needed? yes +
Comments                           []

installp Flags
COMMIT software updates?          no +
SAVE replaced files?              yes +
AUTOMATICALLY install requisite software? yes +
OVERWRITE same or newer versions? no +
VERIFY install and check file sizes? no +

```

In Example 4-25, notice that `v1par7_p5` is chosen as the Server of Resource.

In the SPOT creation process, the NIM master exports its lpp_source directory and the standalone client (resource server) NFS mounts the NIM master's lpp_source directory.

See Example 4-26.

Example 4-26 lpp_source directory is exported and nfs mounted on resource server

```
From NIM master, lpar1,
lpar1:/ > exportfs
/export/lppsource/lppsrc-aix53 -ro,root=v1par7_p5:,access=v1par7_p5:
```

```
From the Resource server, v1par7_p5,
v1par7_p5:/ > df
Filesystem      512-blocks  Free   %Used   Iused   %Iused   Mounted on
/dev/hd4         98304      21760   78%     1774    40%     /
/dev/hd2        1507328    134120   92%     9965    54%     /usr
/dev/hd9var      32768      16032   52%      373    17%     /var
/dev/hd3         65536      62808   5%        4      1%     /tmp
/dev/hd1         32768      32064   3%        5      1%     /home
/proc            -           -         -         -       -       /proc
/dev/hd10opt     98304      23032   77%      682    20%     /opt
/dev/spotlv     4194304    2971352  30%     16403   5%     /export/spot
/dev/imageslv   4194304    1044904 76%      10      1%     /export/images
lpar1:/export/lppsource/lppsrc-aix53 24379392 3982728 84% 3061 1%
/tmp/_nim_dir_327780/mnt0
```

After the SPOT resource is defined on the NIM master and created on the resource server, you can see that this resource defined into the NIM master's database using `lsnim -l <SPOT_name>`.

Also notice the resource pointing to the resource server, as highlighted in bold font in Example 4-27.

Example 4-27 lsnim output showing SPOT resource pointing to the resource server

```
lpar1:/ > lsnim -c resources
boot             resources        boot
nim_scri         resources        nim_script
LPPSRC-AIX53     resources        lpp_source
SPOT-AIX53       resources        spot
SPOT-AIX53-Clust01  resourc        spot
```

```
lpar1:/ > lsnim -l SPOT-AIX53-Clust01
SPOT-AIX53-Clust01:
class            = resources
type             = spot
plat_defined     = chrp
arch             = power
```

```
bos_license = yes
Rstate     = ready for use
prev_state = verification is being performed
location   = /export/spot/SP0T-AIX53-Clust01/usr
version    = 5
release    = 3
mod        = 0
oslevel_r  = 5300-04
alloc_count = 0
server    = v1par7_p5
if_supported = chrp.mp ent
Rstate_result = success
```

► Defining a mksysb resource on a standalone client

In our example, we initiated the mksysb of the NIM client (v1par9_p5) from the NIM master. Before you perform this action, make sure you have allocated disk space for the resource server. We recommend you create another file system (for example, /export/images).

Note: Remember to have the following prerequisites in place:

- Communication between the NIM master and the resource server, as well as communication between the NIM master and the NIM client. You can use either **rsh** or **nimsh**.
- Verify that the NFS between the resource server and the NIM client is enabled.
- The ulimit is set to unlimited on both the resource server and the NIM client (for root user).
- The file system exported by the resource server is either large file enabled (JFS) or JFS2.

Steps through the SMIT to create the mksysb resource as shown in Example 4-28.

- From the NIM master, lpar1

```
lpar1:/ > smitty nim_mkres
```

 - Select “mksysb = a mksysb image”

Example 4-28 Define a mksysb resource with v1par7_p5 as the resource server

Define a Resource
Type or select values in entry fields.
Press Enter AFTER making all desired changes.

[TOP]

[Entry Fields]

```

* Resource Name                [MK-VLPAR9_P5]
* Resource Type                mksysb
* Server of Resource           [v1par7_p5] +
* Location of Resource         [/export/images/v1par9_p5.mksysb> /
Comments                       []

Source for Replication         [] +
-OR-
System Backup Image Creation Options:
CREATE system backup image?      yes +
NIM CLIENT to backup             [v1par9_p5] +
PREVIEW only?                 no +
IGNORE space requireme        no +

```

In the mksysb resource creation process, the v1par7-p5 server's /export/images directory is exported to the v1par9_p5 server to perform the mksysb; see Example 4-29.

Example 4-29 /export/images directory NFS exported

```

From Resource server, v1par7_p5,
v1par7_p5:/ > exportfs
/export/images -root=v1par9_p5:.,access=v1par9_p5:

```

```

From NIM client, v1par9_p5,
v1par9_p5:/ > df
Filesystem  512-blocks    Free %Used   Iused  %Iused   Mounted on
/dev/hd4      49152      15864   68%   1656    46%     /
/dev/hd2     1490944     144224   91%   19527   51%     /usr
/dev/hd9var   32768      15312   54%    363    17%     /var
/dev/hd3      65536      59272   10%    48     1%     /tmp
/dev/hd1      32768      32064    3%     5     1%     /home
/proc         -           -        -      -       -       /proc
/dev/hd10opt  81920      25792   69%    621   17%     /opt
v1par7_p5:/export/images  4194304  2031472  52%    9    1%
/tmp/4056320

```

After the mksysb resource has been defined on the NIM master and created on the resource server, you can see this resource by running (on the NIM master) `lsnim -l <mksysb_name>`.

Note that the resource is pointing to the resource server; see the fields that are highlighted in bold font in Example 4-30.

Example 4-30 lsnim output showing mksysb resource pointing to resource server

```

lpar1:/ > lsnim -c resources
boot                resources          boot
nim_script          resources          nim_script
LPPSRC-AIX53        resources          lpp_source

```

SPOT-AIX53	resources	spot
SPOT-AIX53-Clust01	resources	spot
MK-VLPAR9_P5	resources	mksysb

```
lpar1:/ > lsnim -l MK-VLPAR9_P5
MK-VLPAR9_P5:
  class      = resources
  type       = mksysb
  arch       = power
  Rstate     = ready for use
  prev_state = unavailable for use
  location   = /export/images/vlpar9_p5.mksysb
  version    = 5
  release    = 3
  mod        = 0
  oslevel_r  = 5300-03
  alloc_count = 0
  server     = vlpar7_p5
```

4.3.2 Performing a BOS installation

Performing a BOS installation (rte or mksysb), for example, having the resources on the resource server, is similar to a BOS installation with all the resources on the NIM master. You just have to allocate the correct resources to perform this task. However, there are prerequisite items that need to be in place first:

- ▶ Communication between the NIM master and resource server (**rsh** or **nimsh**).
- ▶ Communication between the NIM master and the NIM client, if you need to perform a push operation (**rsh** or **nimsh**).
- ▶ NFS must be enabled between the NIM master and the NIM client—or between the resource server and the NIM client—depending on where the resource is located.
- ▶ If you have a resource server serving the SPOT resource for the NIM client, and you perform a pull BOS installation, note that the database for the bootp server in the `/etc/bootptab` file is in the *resource server*, instead of in the NIM master.

Also, when you specify the server's IP address in the SMS menu, ensure that you specify the *resource server's IP* instead of the NIM master IP.

Here we provide an example to demonstrate what happens when we perform a pull BOS installation with the resource server serving the mksysb and the SPOT resources for the NIM client:

1. Allocate the SPOT and the mksysb resources to the NIM client (v1par9_p5).

From the NIM master (lpar1), follow these steps through the SMIT menus:

```
lpar1:/ > smitty nim_mac_res
Allocate Network Install Resources
```

Then select v1par9_p5 as the target machine and MK-VLPAR9_P5 and SPOT-AIX53-Clust01 as resources.

After the SPOT and mksysb are allocated, the image and the SPOT directories are exported from the v1par7_p5 to v1par9_p5 (see Example 4-31).

Example 4-31 image and SPOT exported in v1par7_p5

```
v1par7_p5:/ > exportfs
/export/spot/SPOT-AIX53-Clust01/usr -ro,root=v1par9_p5:.,access=v1par9_p5:
/export/images/v1par9_p5.mksysb -ro,root=v1par9_p5:.,access=v1par9_p5:
```

2. Initialize the BOS installation on the NIM client (v1par9_p5), as shown in Example 4-32.

From the NIM master, follow these steps through the SMIT menu:

```
lpar1:/ > smitty nim_mac_op
```

Select v1par9_p5 as the target machine and bos_inst = perform a BOS installation.

Example 4-32 BOS installation - mksysb (pull operation)

Perform a Network Install

Type or select values in entry fields.
Press Enter AFTER making all desired changes.

Target Name	[Entry Fields]	
Source for BOS Runtime Files	v1par9_p5	
installp Flags	mksysb +	
Fileset Names		[-agX]
Remain NIM client after install?	[]	
Initiate Boot Operation on Client?	yes +	
Set Boot List if Boot not Initiated on Client?	no +	
Force Unattended Installation Enablement?	no +	
ACCEPT new license agreements?	[yes] +	

After the BOS installation is initialized, the /etc/bootptab file in the v1par7_p5 server is updated (not in the NIM master server). Observe that the server's IP

address is pointing to the v1par7_p5's IP address instead of the NIM master's IP address, as shown in Example 4-33.

Example 4-33 /etc/boottab file in v1par7_p5

```
# T178 -- (xstation only) -- enable XDMCP
# T179 -- (xstation only) -- XDMCP host
# T180 -- (xstation only) -- enable virtual screen
v1par9_p5:bf=/tftpboot/v1par9_p5:ip=10.1.1.74:ht=ethernet:sa=10.1.1.72:sm=255.255.255.0:
```

Also, the NIM script is exported from the v1par7_p5 to v1par9_p5; see Example 4-34.

Example 4-34 nim script exported from v1par7_p5

```
v1par7_p5:/ > exportfs
/export/spot/SPOT-AIX53-Clust01/usr -ro,root=v1par9_p5:,access=v1par9_p5:
/export/images/v1par9.mkysyb -ro,root=v1par9_p5:,access=v1par9_p5:
/export/nim/scripts/VLPAR9_P5.script -ro,root=v1par9_p5:,access=v1par9_p5:
```

3. Boot the LPAR in SMS mode

Boot the LPAR in SMS mode to specify the v1par7_p5 IP address as the server's IP address instead of the NIM master's IP address. Refer to "SMS and console flow during NIM client installation" on page 84 for more detailed information about SMS menus.

4.4 Using NIM to perform AIX migrations of NIM master and clients

In the following section we discuss using NIM to perform AIX migration of the master and the clients. In particular, we will focus on migration to AIX 5L V5.3. The main topics we cover are:

- ▶ Migrating a NIM master to AIX 5L V5.3
- ▶ Migrating a NIM client to AIX 5L V5.3

We cover the conventional method of AIX migration via NIM. Other methods of NIM migration such as using the `nimadm` tool are covered in 4.5, "NIM mkysyb migration and `nim_move_up` POWER5 tools" on page 205. There are two new methods for AIX migration via NIM: `mkysyb` migration and `nim_move_up`, which are discussed in later sections of this book as well.

Planning to migrate an AIX system (with or without NIM) requires careful planning and testing. Here we provide tips for planning a migration, including pre/post migration steps, NIM master and client requirements, disk space requirements, migration testing with NIM clones and more.

4.4.1 Migrating a NIM master to AIX 5L V5.3

In this section, we discuss the migration of a NIM master to AIX 5L V5.3. Although the migration of a NIM master is not performed via a NIM migration procedure, we cover the specific tasks required when upgrading a NIM master, including tips on pre-migration and post-migration tasks which will ensure a successful, functioning NIM environment.

We do not cover in detail how to perform an AIX migration via CD. This type of migration is documented in AIX 5L V5.3 Installation and Migration, SC23-4887, and there are no specific differences for a NIM master. The topics we cover here include:

- ▶ Prerequisites
- ▶ Pre-migration tasks
- ▶ Migration via CD
- ▶ Post-migration tasks
- ▶ Cleanup tasks
- ▶ Alternative migration option

Note: In a NIM environment, the NIM master must be running at the highest level of AIX. Therefore, it must be migrated to AIX 5L V5.3 *before* any of its clients. After it is migrated, the master will be able to serve AIX 5L V5.3 clients as well clients running earlier versions of AIX (for example, AIX V4.3, AIX V5.1 and AIX 5L V5.2).

Before migrating a NIM master, check the following:

- ▶ Obtain the latest AIX base install media plus the latest Technology Level (TL), Service Packs (SP), and Concluding Service Packs (CSP).
- ▶ Read the AIX 5L V5.3 release notes. These contain important information that you should know before starting a migration.
- ▶ Check that your client hardware supports AIX 5L V5.3. More information can be found in the release notes for AIX 5L V5.3. Release notes for AIX 5L V5.3 for example, mention that some older hardware is no longer supported (such as MCA).
- ▶ Always perform at least one test migration of the system before performing the real migration. This will verify that the AIX migration works as expected,

and will highlight any issues before they occur during a live production upgrade. Make sure you test the backout plan as well.

- ▶ Ensure that you have all the latest software levels for disk and other storage devices such as SDD, SDDPCM, and so on. Verify that you have the correct version for AIX 5L V5.3 (for example,) if you are running SDD, you will need SDD for AIX 5L V5.3. After a migration to AIX 5L V5.3 you would need to remove the old version and install the correct version of SDD for AIX 5L V5.3.
- ▶ It is always a best practice to upgrade your system and adapter firmware to the latest level of microcode before performing an AIX migration. Some systems or adapters may not be supported or will not function with AIX 5L V5.3 if their microcode is not up-to-date.

In particular, check the levels of your fibre channel (if using SAN-attached storage) and network adapters (especially when using NIM). Check the IBM support Web site for the latest levels of system and adapter microcode and apply them before upgrading:

<http://www14.software.ibm.com/webapp/set2/firmware/gjsn>

- ▶ Check the code level on your Hardware Management Console (HMC) (if applicable). Often there will be corresponding code levels when you upgrade the managed system microcode which may contain important fixes to support AIX 5L V5.3 and the latest Technology Level.
- ▶ Document the NIM master's current configuration (for example, hardware, AIX and NIM information). You can use the **snap** and **lsnim** commands to document the NIM master's configuration. You could also use a custom script to collect information about your system and store it in a text file. This file can be used later if you need to look back at how the system was configured before the migration.
- ▶ Back up the NIM database. You can use SMIT to back up the NIM database, or use a custom script. Back up the database before performing a **mksysb**; in this way, the NIM database backup will be included in the **mksysb**.
- ▶ Perform a **mksysb** of the NIM master before the migration. You can back up to tape or DVD media. If your NIM resources are kept in a separate volume group (for example, **nimvg**), then you should also perform a volume group backup (**savevg**) to tape or DVD, or use the backup tool that exists within your environment (for example, Tivoli Storage Manager).

Notes:

- ▶ Migration by media (CD) is the only supported way to migrate a NIM master. The NIM master will be unavailable for the duration of the migration.
- ▶ Starting with AIX 5L V5.3, there is a new NIM feature known as High Availability NIM (HANIM). HANIM will allow you to manually switch your primary master to an alternate. If downtime is an issue for your NIM master (for example, for disaster recovery purposes), then you can perform your migration without impacting your NIM clients.

After your NIM master has been migrated to AIX 5L V5.3, you will be able to take advantage of this feature for any future AIX migration (for example, AIX 5L V5.3 to AIX 5L V5.4) on the NIM master. For details, see 4.1, “High Availability Network Installation Manager” on page 124.

In the following section, we look at upgrading your NIM master from AIX 5L V5.2 to AIX 5L V5.3 via CD.

Prior to migration, make sure that the following prerequisites are met:

- ▶ Ensure you have all the AIX 5L V5.3 media (CDs).
- ▶ Check that you have enough disk space to create file systems for the new AIX 5L V5.3 lpp_source and SPOT that will be created after the migration of the master.
- ▶ Check the following documentation:
 - AIX 5L Version 5.3 release notes
http://publib.boulder.ibm.com/infocenter/pseries/v5r3/topic/com.ibm.aix.resources/RELNOTES/5304_base_relnotes.pdf
 - AIX 5L Version 5.3 Bonus Pack and Expansion Pack Release Notes
http://publib.boulder.ibm.com/infocenter/pseries/v5r3/topic/com.ibm.aix.resources/RELNOTES/5304_exp_relnotes.pdf
- ▶ Check if the hardware is supported. Only Common Hardware Reference Platform (CHRP) machines are supported under AIX 5L V5.3. Verify that the server is a CHRP machine:

```
# bootinfo -p  
chrp
```
- ▶ Check file system space and free PPs in rootvg. Consult the AIX 5L V5.3 release notes for more information about space requirements.

- ▶ Run the AIX 5L V5.3 `pre_migration` script and review the results. The `pre_migration` script will verify whether your system is ready for migration. The `pre_migration` script can be found on the AIX 5L V5.3 base install media.
- ▶ Back up the files `/etc/motd` and `/etc/sendmail.cf`. These files are replaced during a migration. Keep copies of the originals on hand so you can merge the old configuration into the newer files manually.
- ▶ Back up the NIM database beforehand.
- ▶ Verify that you have a CD and/or tape drive on the NIM master, because a CD drive will be required for the migration. If using DLPAR, you need to assign one CD/DVD drive dynamically for use during the migration.
- ▶ Document AIX and NIM master configuration before and after. Use the `lsnim` and `snap` commands to generate and capture critical configuration information about your NIM master. This information will be useful if you encounter problems after the migration that require you to rebuild or reconfigure the system.
- ▶ We cloned the NIM master (with “Remain NIM client set to *no*”) to another test system and performed a test migration to AIX 5L V5.3. We did not test the NIM environment as we only wanted to test and observe the AIX migration process. However, you could clone the master and configure so that it was a fully functional NIM master that could serve clients. You may even consider this as an alternate way of migrating your NIM master. For more information on cloning a system with NIM refer to 5.4, “Cloning NIM clients using `mksysb`” on page 451 and 5.10, “Backing up and reinstalling a NIM master” on page 537.

Steps to migrate the NIM master to AIX 5L V5.3

The following steps will migrate a NIM master running AIX 5L V5.2 on p670 LPAR to AIX 5L V5.3. We employ the use of an alternate disk install to provide a quick backout if the migration should fail for any reason.

After the migration is complete, we then verify the NIM master environment is usable and verify that we can still use NIM to perform a BOS install of the various versions of AIX that our environment supports (for example, AIX 4.3, AIX 5L V5.1, AIX 5L V5.2, and now AIX 5L V5.3). These are steps to follow:

1. Check for clients that have active NFS mounts from the NIM master before you start the migration.

There have been situations where clients will hang when the NIM master is shut down and the clients’ NFS mount “disappears”. It can be difficult to force unmount the NFS cross-mount on the client (it is not impossible, but it is difficult) and this may require a reboot of the client if the NIM master is unavailable for a long time.

If you are using CSM, you can use the **dsh** command to check all your systems at once for any current NFS mounts from the clients to the NIM master. In the following example, client lpar4 has NFS-mounted nimmast's /export/images file system. This should be unmounted prior to migrating the NIM master.

```
{nimmast}:/ # dsh -v mount | grep -i nfs
lpar4: nimmast /export/images /mnt nfs3 Jun 14 15:56
```

2. Document the AIX and NIM master configuration.

In our case, we use the **snap** and **lsnim** commands to document the system before the migration. The output from both commands would be stored on a system other than the NIM master. We need to be able to access the information whether or not the NIM master is up or down.

We also use a custom script to capture other configuration information we would like to see; refer to Appendix D, "Additional material" on page 643.

```
{nimmast}:/ # snap -ac
{nimmast}:/ # lsnim -l
{nimmast}:/ # AIXinfo -pre
```

3. Perform a NIM database backup.

In our case, we back up the NIM database via SMIT. You can also use a script if you prefer, as shown in Example 4-35. The advantage of using a script is that it can be run from root's cron every day, thus giving you several backups to choose from in case of a problem.

```
{nimmast}:/ # smitty nim_backup_db
                    Backup the NIM Database
* Filename/Device for the Backup
[/etc/objrepos/nimdb.backup.14Jun2006.Prior_to_AIX53_Migration] +
```

Example 4-35 NIM database backup script

```
{nimmast}:/usr/local/bin # cat bknimdb
#!/usr/bin/ksh
#
# bknimdb - script to backup the NIM Database
#
# Description
# -----
# This script will backup the NIM database. This backup could be used
# to recover the NIM Database should it become corrupted. The backup
# file will be named nimdb.backup.Day, where Day is the day of the week.
#
# e.g. /etc/objrepos/nimdb.backup.Mon
#
# The NIM database can be restored via procedures documented in the
# "AIX 5L Version 5.3 Installing AIX" Guide (SC23-4887-02).
```

```

#
# The restore can be done via SMIT i.e.
#
#      # smitty nim_restore_db
#

PATH=/usr/bin:/usr/sbin

# Directory where the NIM database backup will be created.
nimbdir=/etc/objrepos

# We can only run this as root.
if [ "$(id -un)" != "root" ]
then
    echo "$(basename $0): must be run as user \"root\""
    exit 1
fi

#
# Backup the NIM Database
#
echo "-----"
echo "Starting NIM Database Backup on $(uname -n ) at $(date)"
echo

/usr/lpp/bos.sysmgmt/nim/methods/m_backup_db $nimbdir/nimdb.backup.$(date +%a)
if [ $? -ne 0 ]
then
    echo
    echo "$(basename $0): Error in backing up NIM Database"
    echo
fi

echo
echo "Finished NIM Database Backup on $(uname -n ) at $(date)"
echo "-----"

{nimmast}:/usr/local/bin # bknimdb
-----
Starting NIM Database Backup on nimmast at Mon Jun 19 10:12:21 DFT 2006

a ./etc/objrepos/nim_attr 72 blocks.
a ./etc/objrepos/nim_attr.vc 272 blocks.
a ./etc/objrepos/nim_object 16 blocks.
a ./etc/objrepos/nim_object.vc 32 blocks.
a ./etc/NIM.level 1 blocks.
a ./etc/niminfo 1 blocks.

Finished NIM Database Backup on nimmast at Mon Jun 19 10:12:21 DFT 2006

```

```
-----
{nimmast}:/usr/local/bin # ls -ltr /etc/objrepos/nimdb.backup.Mon
-rw-r--r-- 1 root system 215040 Jun 19 10:12
/etc/objrepos/nimdb.backup.Mon
```

4. Perform a mksysb of the NIM master and back up other volume groups.

In our case, we saved a mksysb image to tape media and then performed a savevg of the NIM volume group (nimvg) to another tape media.

```
{nimmast}:/ # mksysb -i /dev/rmt0
{nimmast}:/ # savevg -f /dev/rmt0 nimvg
```

5. Install the bos.alt_disk_install filesets.

These filesets are required so that we can use the **alt_disk_install** command to clone our rootvg before the migration; refer to Example 4-36.

Example 4-36 Installing the bos.alt_disk filesets

```
{nimmast}:/ # smit nim_task_inst
Install and Update from ALL Available Software
* Installation Target master
* LPP_SOURCE lpp_sourceaix5204
* Software to Install [bos.alt_disk_install]+
```

6. Un-mirror rootvg and clone to hdisk1 as shown in Example 4-37.

In our case, we will use this rootvg clone if our migration fails and we need to go back to AIX 5L V5.2. If rootvg is mirrored, then you can later unmirror and use the spare disk for the alternate rootvg.

If you are in a SAN environment, you can assign a LUN temporarily for the migration and use it as the alternate rootvg. The LUN could be returned some time after the migration is finished and you decide that you do not need to back out from the migration. The **-B** flag specifies that the bootlist will *not* be set to the alternate disk after the operation completes.

However, make sure that your system can boot from a SAN-attached disk (LUN).

Example 4-37 Cloning rootvg with alt_disk_install

```
{nimmast}:/ # unmirrorvg -cl rootvg hdisk1
{nimmast}:/ # chpv -c hdisk1
{nimmast}:/ # lspv -l hdisk1 ; migratepv hdisk1 hdisk0 (if required)
{nimmast}:/ # lspv -l hdisk1
{nimmast}:/ # reducevg rootvg hdisk1
{nimmast}:/ # lsvg -p rootvg
{nimmast}:/ # bosboot -a -d /dev/hdisk0
{nimmast}:/ # bootlist -m normal hdisk0
{nimmast}:/ # bootlist -m normal -o
```



```

hdisk0
{nimmast}:/ # alt_disk_install -B -C hdisk1
Calling mkszfile to create new /image.data file.
Checking disk sizes.
Creating cloned rootvg volume group and associated logical volumes.
Creating logical volume alt_hd5.
Creating logical volume alt_hd6.
Creating logical volume alt_hd8.
Creating logical volume alt_hd4.
Creating logical volume alt_hd2.
Creating logical volume alt_hd9var.
Creating logical volume alt_hd3.
Creating logical volume alt_hd1.
Creating logical volume alt_hd10opt.
Creating /alt_inst/ file system.
Creating /alt_inst/home file system.
Creating /alt_inst/opt file system.
Creating /alt_inst/tmp file system.
Creating /alt_inst/usr file system.
Creating /alt_inst/var file system.
Generating a list of files
for backup and restore into the alternate file system...
Backing-up the rootvg files and restoring them to the alternate file system...
Modifying ODM on cloned disk.
Building boot image on cloned disk.
forced unmount of /alt_inst/var
forced unmount of /alt_inst/usr
forced unmount of /alt_inst/tmp
forced unmount of /alt_inst/opt
forced unmount of /alt_inst/home
forced unmount of /alt_inst
forced unmount of /alt_inst
Changing logical volume names in volume group descriptor area.
Fixing LV control blocks...
Fixing file system superblocks...
{nimmast}:/ # lspv | grep root
hdisk0 00531d9a33ff6ab5          rootvg          active
hdisk1 00531d9a47ed2df6          altinst_rootvg active

```

7. Commit all applied software before migrating; see Example 4-38.

This will also create additional space in /usr (if there are any filesets in the applied state).

Example 4-38 Committing all applied filesets

```

{nimmast}:/ # smit commit
* SOFTWARE name                [all] +
  PREVIEW only? (commit operation will NOT occur)  no +
  COMMIT requisites?           yes +

```

EXTEND file systems if space needed?	yes +
DETAILED output?	no +

8. Ensure all users are logged off.

9. Perform migration installation of AIX 5L V5.3.

We are now ready to execute the AIX migration. At this point in our case, we must go to the NIM master's console (via the HMC) and prepare to migrate via CD.

10. Insert AIX 5L V5.3 Installation CD Volume 1 into the CD drive.

11. Follow the procedure in the AIX installation and migration guide to migrate via media to AIX 5L V5.3

12. After the migration is finished, remove the AIX 5L V5.3 Installation Volume 1 CD from the CD-ROM drive.

13. Check the system configuration, for example, oslevel, disk, network, AIX error report, and so on.

14. Clean up old AIX 5.2 filesets. It may be necessary to remove old AIX 5.2 filesets after the migration.

15. Check the NIM environment.

In our case, we perform some quick tests to verify the NIM environment after the migration. Using the `lsnim` command, we verify that the NIM database is intact. We check the state of the master and clients. We also validate some of our NIM resources.

Check the NIM database:

```
{nimmast}:/ # lsnim
```

Check the status of the NIM master:

```
{nimmast}:/ # lsnim -a Cstate -a Mstate master
```

Check the status of a NIM client:

```
{nimmast}:/ # lsnim -a Cstate -a Mstate LPAR4
```

Validate the NIM resources:

```
{nimmast}:/ # nim -o check LPP_52_ML8
```

```
{nimmast}:/ # nim -o check SPOT_52_ML8
```

16. Build an AIX 5L V5.3 `lpp_source` and `SPOT`.

You will need to insert the AIX 5L V5.3 install CD number 1 into the CD-ROM drive to build the `lpp_source`. After the `lpp_source` has been created, ensure that `simages` is set to `yes`, because this indicates whether or not it can be used for installations.

Also check for any errors, such as missing filesets when creating the SPOT. Refer to Example 4-39. For detailed information about creating an lpp_source and a SPOT, see 3.1, “Setting up a basic NIM environment” on page 53.

Example 4-39 AIX 5L V5.3 lpp_source and SPOT

```
{nimmast}:/ # lsnim -l LPP_53_ML4
LPP_53_ML4:
  class      = resources
  type       = lpp_source
  arch       = power
  Rstate     = ready for use
  prev_state = verification is being performed
  location   = /AIX53ML4/LPP_53_ML4
  simages   = yes
  alloc_count = 0
  server     = master

{nimmast}:/ # lsnim -l SPOT_53_ML4
SPOT_53_ML4:
  class      = resources
  type       = spot
  plat_defined = chrp
  arch       = power
  bos_license = yes
  Rstate     = ready for use
  prev_state = verification is being performed
  location   = /AIX53ML4/SPOT_53_ML4/usr
  version    = 5
  release    = 3
  mod        = 0
  oslevel_r  = 5300-04
  alloc_count = 1
  server     = master
  if_supported = chrp.mp ent
  Rstate_result = success
```

Validate the NIM resources:

```
{nimmast}:/ # nim -o check LPP_53_ML4
{nimmast}:/ # nim -o check SPOT_53_ML4
```

17. Using a test client (LPAR), perform a NIM BOS rte install of AIX 5L V5.3.

In our case, by performing a NIM BOS install onto our test client, we can confirm that our new AIX 5L V5.3 NIM master is functioning correctly.

18. Restore rootvg to a mirrored disk configuration.

In our case, now that our new NIM environment is functioning, we can remove the alternate rootvg disk and remirror rootvg, as shown in Example 4-40 on page 162.

Finally, reboot the system to turn off quorum for rootvg.

Example 4-40 Commands to remirror rootvg after alt_disk_install

```
{nimmast}:/ # alt_disk_install -X altinst_rootvg
{nimmast}:/ # extendvg rootvg hdisk1
{nimmast}:/ # mirrorvg rootvg hdisk1
{nimmast}:/ # bootlist -m normal hdisk0 hdisk1
{nimmast}:/ # bosboot -a -d /dev/hdisk0
{nimmast}:/ # bosboot -a -d /dev/hdisk1
{nimmast}:/ # shutdown -Fr
```

19. The NIM master is now running AIX 5L V5.3 and all NIM resources have been tested.

At this point, you are able to deploy AIX 5L V5.3 within your NIM environment.

Backout plan for NIM master

If there are issues with the NIM master migration, we can easily back out by rebooting the master from the alternate rootvg disk. The following procedure can be followed to boot from the cloned rootvg.

1. Set the bootlist to boot from original rootvg. First identify the alternate rootvg disk, as shown in Example 4-41.

Example 4-41 Identifying the alternate rootvg disk

```
{nimmast}:/ # lspv | grep altinst_rootvg
hdisk1 00531d9a47ed2df6                altinst_rootvg active
```

2. Verify that the bootlist is set to hdisk1, as shown in Example 4-42.

Example 4-42 Verifying the bootlist.

```
{nimmast}:/ # bootlist -m normal -o
hdisk1
```

3. Reboot the server; see Example 4-43.

Example 4-43 Rebooting the system.

```
{nimmast}:/ # shutdown -Fr
```

Another way to perform the back out is to restore from the mksysb backup created prior to the migration. However, this will take more time, so the alternate disk method is the preferred way.

4. Verify the NIM environment as previously shown.

Alternative NIM master migration approach

An alternative migration option for a NIM master would be to build a new NIM master (at AIX 5L V5.3) on new hardware, and then migrate the NIM clients to the new master. If you have additional (newer) hardware, you could build a new AIX 5L V5.3 NIM master on this hardware and then move your existing clients to the new master at your convenience.

One advantage of this approach is that there is no downtime for the original NIM master. This is also a useful approach if your existing NIM master's hardware does not support AIX 5L V5.3.

4.4.2 Migrating a NIM client to AIX 5L V5.3

In this section we discuss migrating a NIM client to AIX 5L V5.3. Topics include:

- ▶ Prerequisites
- ▶ Pre-migration tasks
- ▶ Migration via NIM
- ▶ Post Migration tasks
- ▶ Debugging a NIM migration

Note: In a NIM environment, as previously mentioned, the NIM master must be migrated to AIX 5L V5.3 before any of its clients. It must be running the highest operating system level. After the NIM master has been migrated, then the clients can follow.

We will discuss a conventional NIM migration which also utilizes a standard alternate disk install (that is, not **nimadm**) for backout.

The advantage of using NIM to migrate a client is that it does not require any installation media (such as a CD) to perform the migration. The migration is performed over the network. As a result, the administrator can perform and monitor the migration remotely and even automate the migration, if desired. Also, multiple migrations can occur simultaneously.

During a NIM migration, the system will be down for the duration of the upgrade. If downtime is an issue for your site, consider using the NIM alternate disk migration (**nimadm**) utility. This utility allows you to migrate on an alternate rootvg disk, and then reboot the system to restart it on the newer version of AIX,

all under the control of the NIM master. The migration can take place at your convenience and no downtime is required until the reboot is performed at an appropriate time. See 4.6, “NIM alternate disk migration” on page 261 for more detailed information about this topic.

If HACMP is used in your environment, then the downtime required can be minimized. You could execute a controlled failover of the system to a standby node first. Then you would be able to migrate the client without impacting the services that run on that system. After the migration was complete, you could execute a controlled fallback, restart your services, and then test them with AIX 5L V5.3. If there are any issues you could perform another controlled failover to the standby node (which would still be running AIX 5L V5.2). This would allow you to investigate the migration issues without impacting the applications on the system.

During the migration process, the client boots over the network from the NIM master (bootp/tftp). NFS mounts are then used to update the filesets on the client machine. The network-booted client runs in single user mode during the migration, and has only limited functionality to support the NIM migration process. As a result, client applications cannot be active during the migration.

If the migration process fails, you can either restore a mksysb backup of the client via NIM or reboot the client using the alternate rootvg disk created prior to the migration (which is our preferred method). After the restore or reboot is complete, you can try the migration again as soon as you have resolved the issues that caused the migration to fail.

We recommend that the following prerequisites be met before commencing a migration. Before migrating a client check the following:

- ▶ The NIM master must be running AIX 5L V5.3 with the latest Technology Level. See 3.1, “Setting up a basic NIM environment” on page 53 for more information.
- ▶ It is recommended (but not mandatory) that the client be running at the latest level of its current version of AIX. This way your client system will be running the latest code and will be able to take advantage of the latest features and enhancements for that version and level of AIX.
- ▶ Ensure you have enough disk space on the NIM master to back up the NIM client multiple times (for example, check space in /export/images). A mksysb backup of the NIM client will be taken before and after the migration, so there must be enough free space for the images.
- ▶ Check that your client hardware supports AIX 5L V5.3. More information about this topic can be found in the release notes for AIX 5L V5.3.

- ▶ Check that your applications are supported with AIX 5L V5.3. Use cloning if you want to test an application before performing the real migration. It may be worth putting together an application matrix for all your systems and contacting each vendor to ensure support for AIX 5L V5.3.
- ▶ Perform at least one test migration of the system before performing the real migration. This will verify that the AIX migration works as expected and will also highlight any issues before they occur during a live production upgrade. Clone the client to another test LPAR via NIM. Install the client's mksysb but do not recover its devices (this will avoid IP address conflicts on your network). After the mksysb is restored, you can migrate it to AIX 5L V5.3 and observe and document the results.

Note: Make sure that you test the backout plan, as well.

- ▶ Ensure that you have all the latest software levels for disk and other storage devices such as SDD, SDDPCM, and so on. Check that you have the correct version for AIX 5L V5.3 (for example, SDD for AIX 5L V5.3).
- ▶ It is always useful to upgrade your system and adapter firmware to the latest level of microcode before performing an AIX migration. Some systems or adapters may not be supported or will not function with AIX 5L V5.3 if their microcode is not up-to-date.

In particular, check the levels of your Fibre Channel (if using SAN disk) and Network adapters (especially when using NIM). Check the IBM support Web site for the latest levels of system and adapter microcode and apply them before upgrading.

<http://www14.software.ibm.com/webapp/set2/firmware/gjsn>

- ▶ Check the code level on your HMC (if applicable). Often there will be corresponding code levels when you upgrade the managed system microcode. There may even be important fixes to support AIX 5L V5.3 and the latest Technology Level.
- ▶ The system to be migrated must be a valid NIM client. It must be registered with the NIM database and should have a valid /etc/niminfo file. You can use **niminit** to register the client if it is not already defined. Also check the current state and resource allocation for the client. Reset the client so it is in a clean state prior to the migration; refer to “Defining NIM clients” on page 79.
- ▶ The NIM master must be able to run remote commands on the NIM client to be migrated.
- ▶ Read the AIX 5L V5.3 release notes, which contain important information that you should know before starting a migration.

- ▶ Install the `bos.alt_disk_install` filesets on the client if you plan on using `alt_disk_install` tools with the conventional NIM migration.

This is the basic process of a NIM client AIX migration:

- ▶ The client boots over the network.
- ▶ It mounts the files required for the migration from the NIM master.
- ▶ A menu will appear entitled Migration preparation menu. This confirms that you are doing a migration and not an overwrite installation.
- ▶ After the installation is underway, the BOS Installation Menu appears which displays the progress and status of the migration. At this point your old operating system is removed and replaced with the new version. Therefore, if there are any problems with the migration, a restore of some kind will be required. This is why you must take a backup (or backups) of your system *before* starting the migration.
- ▶ File system allocation and a list of filesets to be updated is displayed next. Much of this information is also recorded on the client in the `/var/adm/ras` log files such as `devinst.log`.
- ▶ When the message: `Over mounting ./` appears, it means that the migration is finished and the RAM file system is overmounted by the now-migrated root (`/`) file system. Final migration activities are performed, such as creating a new boot image and setting the client bootlist. The status of the migration can be monitored using the `lsnim -a info clientname` command.
- ▶ The NIM master is also informed of the successful migration and resets the NIM client's state (to ensure that the client does not boot from the network again by accident).
- ▶ The final step in the NIM migration process will be a reboot of the client. After the reboot is finished, your system will be up and running on AIX 5L V5.3. At this point, you should start your post-migration tasks.

Troubleshooting a NIM migration

This section describes troubleshooting steps to follow during a NIM migration, if needed.

- ▶ If the migration fails for some reason, you will probably experience a “system hang” or see an error appear in the BOS install output. You will probably need to reset the system so that you can recover.

As a result, the state of the NIM client will not be reset by the NIM master, because it never receives any indication that the migration was complete. It will be necessary to reset the NIM client in order to perform NIM operations on it in the future.

The reset of the NIM client will ensure that the state of client is cleared and that all NIM resources are deallocated. The reset can be done via SMIT or via the command line (examples are provided on the following pages).

When the client has been reset, you will be able to perform operations with it again such as retrying the migration after the reason for the failure has been resolved.

- ▶ The following log files contain useful information when troubleshooting a migration. These log files can also be view from the NIM master via the **nim showlog** operation:

```
/var/adm/ras/conslog - Console output log.  
/var/adm/ras/bootlog - System boot log.  
/var/adm/ras/bosinstlog - BOS installation log.  
/var/adm/ras/nim.script - NIM script output.  
/var/adm/ras/nim.installp - NIM filesets install log.  
/var/adm/ras/devinst.log - Software installation log.
```

```
# nim -o showlog -a log_type=bosinst LPAR4  
# nim -o showlog -a log_type=niminst LPAR4  
# nim -o showlog -a log_type=script LPAR4
```

- ▶ If you experience issues during a client network boot, you can try the following to troubleshoot the problem:
 - Verify that the client’s IP details in SMS are correct. Perform a manual ping test from the SMS menus.
 - Check that the adapter speed is correct. Depending on the type of adapter, it may be necessary to set the speed and duplex setting of the adapter (although some newer GB adapters are better set to auto). Incorrect speed and duplex settings can cause hard-to-find issues, in that the ping test will work but the NIM process will be very slow and may even stop half-way through what appears to be an otherwise successful install (usually during the restore base operating system stage).
 - As previously mentioned, also check the microcode levels of the network adapters to avoid any possible issues when booting over the network.
- ▶ If the migration hangs, check whether any of the following situations exist and also if any LED code is displayed that might correspond to the problem.
 - Are the file systems properly exported (NFS) on the NIM master?
 - Can the client access the file systems of the NIM master via NFS?

Refer to Chapter 7, “Basic NIM problem determination and tuning” on page 565, for more information about problem determination in a NIM environment.

4.4.3 NIM client AIX migration example

In this section, we provide an example of migrating a system running AIX 5L V5.2 on a System p670 to AIX 5L V5.3. Our NIM master is a System p615 running AIX 5L V5.3. Both are connected via Ethernet on the same VLAN. Our conventional NIM migration method will require the client to be down during the migration process, but it also employs an `alt_disk_install` (alternate disk install) procedure which will be used as a quick backout if the migration fails.

Although this method requires the most downtime when compared to NIM alternate disk migration, it is considered the most straightforward method, which involves the least amount of effort for the administrator (if planned and tested properly). Unlike `nimadm` migration, it also allows for TCB support (see 4.6, “NIM alternate disk migration” on page 261 for more information about `nimadm` TCB support).

Although our test environment uses SCSI disk, we also include tips for SAN disk environments, where appropriate.

Before starting the migration, check that the following prerequisites are met:

- ▶ NIM master already migrated to AIX 5L V5.3.
- ▶ System and adapter microcode already upgraded.

Planning for NIM client migration involves the following tasks:

- ▶ Reading the AIX 5L V5.3 release notes and checking that our applications are supported.
- ▶ Writing a plan of all the tasks (including command line) to be performed during the migration:
 - Ensuring that a backout plan exists.
 - Testing the backout plan on the test clone.
 - Making the backout plan usable by someone else in your team so that another person can execute the plan if you are unable to do so. This plan can be reused as a template for future migrations.
 - Asking a peer to review the document.
 - Documenting all known issues and any fixes required.
 - Briefly explaining what the process will be to migrate (for example, the basic flow of major events: upgrade AIX; post migration tasks; application testing; backout plan if required).
 - Explaining what will be upgraded (for example, AIX, HACMP, SDD, and so on) and why it will be upgraded.

- ▶ Cloning the system to be migrated onto a “test” LPAR and performing the migration.

This will allow you to review your plan and verify that the AIX migration will work. Resolve and document any issues you might encounter during the “real” migration on the production system. If required, clone the entire system (that is, rootvg, datavg, all applications, not just a mksysb restore) and perform application verification testing. Even test newer software like SDD or SDDPCM for AIX 5L V5.3. Test your backout plan on the test clone.

- ▶ Determining what other software you need to upgrade

This includes newer (or correct) version of SDD, SDDPCM, lsof, nmon, SSH, SSL, rpm, HACMP, ibm2105, device filesets, and so on. It also includes all the necessary fixes to support software on AIX 5L V5.3. For example, HACMP 5.2 requires some APARs to support AIX 5L V5.3. Ask your storage administrator to ensure that the LIC level on the storage device you are running supports AIX 5L V5.3 and the newer versions of SDD or SDDPCM.

The following pre-migration tasks also need to be completed:

- ▶ Documenting the systems configuration (for example, hardware, AIX, and so on).

Use **snap** or a custom script. This is important if you run into issues and need to recover or rebuild your system.

- ▶ Running the AIX 5L V5.3 `pre_migration` script and reviewing the output to verify that the system is ready for a migration.
- ▶ Checking that there is sufficient disk space for the file systems in rootvg plus some free PPs (500 MB) for file system expansion if required.
- ▶ Running the **b1vset** tool to check the AIX version label for all the disks in rootvg. Correct if necessary.
- ▶ Checking the status of the system.

Also look for hardware errors or other errors in the AIX error report.

Performing the migration

After the prerequisites have been met, the planning is complete and the pre-migration tasks have been executed successfully, the migration of the NIM client can be performed. The following steps can be used as a template for any migration plan required in the future:

1. Run the AIX 5L V5.3 `pre_migration` script.

The `pre_migration` script will save its output to /home file system (ensure there is sufficient space in /home). The `pre_migration` script can be found in the AIX 5L V5.3 SPOT on the NIM master (for example,

/AIX53ML4/SP0T_53_ML4/usr/lpp/bos/pre_migration or on the AIX 5L V5.3 base install media.) We will copy the script to our NIM client for execution.

We also recommend that you confirm that the AIX level for all disks in rootvg is correct prior to the migration. You can use the **blvset** command to perform this task, as shown in Example 4-44.

Example 4-44 Output from the pre_migration script and blvset tool

```
# rcp nimmast:/AIX53ML4/SP0T_53_ML4/usr/lpp/bos/pre_migration /tmp
# chfs -a size=+1 /home
# /tmp/pre_migration
```

All saved information can be found in: /home/pre_migration.060309123949

Checking size of boot logical volume (hd5).

Your rootvg has mirrored logical volumes (copies greater than 1)
Recommendation: Break existing mirrors before migrating.

Listing software that will be removed from the system.

Listing configuration files that will not be merged.

Listing configuration files that will be merged.

Saving configuration files that will be merged.

Running lppchk commands. This may take awhile.

Please check /home/pre_migration.060309123949/software_file_existence_check for possible errors.

Please check /home/pre_migration.060309123949/software_checksum_verification for possible errors.

Please check /home/pre_migration.060309123949/tcbck.output for possible errors.

All saved information can be found in: /home/pre_migration.060309123949

It is recommended that you create a bootable system backup of your system before migrating.

```
; Run the blvset command.
; e.g. /usr/lpp/bosinst/blvset -d /dev/hdisk# -glevel <--should show 5.2

# /usr/lpp/bosinst/blvset -d /dev/hdisk0 -glevel
5.2
# /usr/lpp/bosinst/blvset -d /dev/hdisk1 -glevel
```

5.2

; If you do not get 5.2 from the above then run the following command on all rootvg disks.:

```
# /usr/lpp/bosinst/blvset -d /dev/hdisk# -plevel <--enter 5.2 when prompted.
```

2. Check that there is enough disk space to meet the minimum requirements for the file systems in rootvg.

Expand file systems if required. Lack of disk space in rootvg file systems is a common cause of migration failure. The AIX 5L V5.3 release notes contain the latest information regarding requirements for disk space. Ensure you have some free physical partitions (PPs) in rootvg in case file system expansion is required during the migration; see Example 4-45.

Example 4-45 Check free disk space requirements in rootvg file systems

```
; Free space required for rootvg file systems.  
/ 16 MB  
/usr 1256MB;  
/var 128 MB;  
/tmp 128 MB;  
/opt 140 MB;  
; Use df command to check free space.  
# df -m  
;Use lsvg command to check free PP's in rootvg.  
# lsvg rootvg | grep FREE
```

3. Document the configuration of the server.

You can use the **snap** command (for example, **snap -ac**) or a custom script to collect important information about your AIX system. We use a custom script, AIXinfo, which is available in Appendix D, “Additional material” on page 643, to collect information about our system.

Regardless of the tool used, ensure that the information is stored on a system other than the system to be migrated, because it is probable that the time you need to call on this information will be the time when the client is down and you are trying to recover it. The system configuration information will not be obtainable if the system is not running.

What follows is some of the system configuration information you would collect and document before the migration.

Review `/etc/tunables/nextboot` file, as shown in Example 4-46.

Example 4-46 Review and document /etc/tunables

```
# cat /etc/tunables/nextboot  
# IBM_PROLOG_BEGIN_TAG
```

```

# This is an automatically generated prolog.
#
# bos520 src/bos/usr/sbin/perf/tune/nextboot 1.1
#
# Licensed Materials - Property of IBM
#
# (C) COPYRIGHT International Business Machines Corp. 2002
# All Rights Reserved
#
# US Government Users Restricted Rights - Use, duplication or
# disclosure restricted by GSA ADP Schedule Contract with IBM Corp.
#
# IBM_PROLOG_END_TAG

info:
    AIX_level = "5.2.0.54"
    Kernel_type = "MP64"
    Last_validation = "2005-04-18 11:31:25 EET (current, reboot)"

vmo:
    maxfree = "1536"
    minfree = "1440"

no:
    rfc1323 = "1"
    tcp_recvspace = "262144"
    tcp_sendspace = "262144"
    udp_recvspace = "65536"
    udp_sendspace = "65536"
    use_isno = "0"
    routerevalidate = "1"
    bcastping = "1"

```

Collect disk and volume group information as shown in Example 4-47.
Capture this information to a file on another system for future reference.

Example 4-47 Collect disk and volume group information

```

# lsvg
# lsvg -o
# lspv
# lsvpcfg           ; Optional. Only for SDD systems.
# lscfg -vpl hdisk0 ; Do this for each boot disk.
# bootinfo -b       ; Determine which disk we booted off.
hdisk0

```

Collect IP configuration information as shown in Example 4-48. Capture this information to a file on another system for future reference.

Example 4-48 Collecting network and IP information

```
# hostname
# host LPAR4
# ifconfig en0
# lscfg -vpl ent0 | grep Loc
# ifconfig -a
# netstat -nr
# entstat -d entX
```

Run **snap** or a script (in our case, AIXinfo) to capture information about the system as shown in Example 4-49.

Example 4-49 Using snap and a script to document the system

```
# snap -ac
# AIXinfo -pre
```

Check the AIX error report. If everything looks fine, then it is desirable to clear the error report and SMIT logs before the migration to avoid confusion; see Example 4-50.

Example 4-50 AIX error report status and SMIT log cleanup

```
# errpt
# errpt -a
# mkdir /tmp/errptlogs
# errpt > /tmp/errptlogs/errpt.out
# errpt -a >> /tmp/errptlogs/errpt.out
# errclear 0
# mkdir /tmp/smitlogs
# cd /
# cp smit.* /tmp/smitlogs/
# >smit.log
# >smit.script
# >smit.transaction
```

4. Create a mksysb backup of the system, as shown in Example 4-51 on page 174.

How you do this depends on your environment. Client mksysb backups may be initiated from the NIM master or from the client via a script. In our environment we used a script which runs on the client to create a mksysb backup on the NIM master. Refer to 4.11, “Backing up clients with NIM” on page 348 for more information.

Data in other volume groups also needs to be backed up with savevg or other backup tools such as Tivoli Storage Manager (TSM). We recommend using a script to back up just the structure of the volume group (savevg with all files excluded), and then using TSM to back up the data.

To recover the data volume group would then only require a recreation of the volume group structure (that is, restvg to recreate logical volumes and file systems), and then a complete restore of the data from TSM. We use a custom script in our example to back up the volume group structure; see the sysbtonim and skelvg scripts in Appendix D, “Additional material” on page 643.

Example 4-51 Creating a mksysb backup of the server before the migration

```
# /usr/local/bin/skelvg >> /var/log/skelvg.log 2>&1
# /usr/local/bin/sysbtonim >> /var/log/sysbtonim.log 2>&1
```

5. Install the bos.alt_disk_install filesets.

These filesets are required in order to clone the root volume group. We install the filesets on the client via NIM, as shown in Example 4-52.

Example 4-52 Installing the bos.alt filesets via NIM*

```
# smit nim_task_inst

          Install and Update from ALL Available Software

* Installation Target                LPAR4
* LPP_SOURCE                        lpp_sourceaix5204
* Software to Install                [bos.alt_disk_install]+
```

6. Disable system monitoring.

If you have any monitoring software within your environment, remember to disable it or schedule downtime for the system. Otherwise, you may receive unwanted alerts while the system is down during the migration process.

7. Backup the /etc/motd and /etc/sendmail.cf files as shown in Example 4-53.

These files are replaced during the migration and you will lose any custom configuration in these files. Back them up to another directory on the system for easy recovery and reference, and also back them up with the backup tools within your environment. For example, the /home directory is not removed during a migration, so create a directory in /home and copy the files to that location.

Example 4-53 Backing up sendmail and other configuration files

```
# mkdir /home/premig
# cp -p /etc/motd /home/premig/
# cp -p /etc/sendmail.cf /home/premig/
```

8. Stop any applications running on the system.

9. Disable cron as shown in Example 4-54, to avoid the (unlikely) possibility of a cron job running and causing issues or changing data or trying to access applications that are down just prior to migrating the system.

Example 4-54 Disabling cron before the migration

```
# chitab "cron:23456789:off:/usr/sbin/cron"
# telinit q
```

10. Commit applied software.

Remove any efixes on the system first as shown in Example 4-55.

Example 4-55 Commit applied software and check for efixes

```
# emgr -P
# emgr -r -L fixid
# smit commit
```

11. In preparation for the cloning of rootvg, we first unmirror rootvg so that we can use one of the disks for the alt_disk_install operation, as shown in Example 4-56.

Example 4-56 Unmirror rootvg

```
# bootinfo -b
hdisk0
# unmirrorvg -cl rootvg hdisk1
# chpv -c hdisk1
# lspv -l hdisk1 ; migratepv hdisk1 hdisk0 (if required).
# lspv -l hdisk1 ; disk should be empty now.
# reducevg rootvg hdisk1
# lsvg -p rootvg
rootvg:
PV_NAME          PV STATE          TOTAL PPs   FREE PPs   FREE DISTRIBUTION
hdisk0 active                521         390         104..17..61..104..104
# bosboot -a -d /dev/hdisk0
# bootlist -m normal hdisk0
# bootlist -m normal -o
hdisk0
```

12. Clone rootvg to hdisk1.

This alternate rootvg disk could be used if we need to back out our migration and go back to AIX 5L V5.2. The **-B** flag prevents the bootlist from being set after the alternate disk creation is finished, as shown in Example 4-57.

Example 4-57 Cloning rootvg with alt_disk_install

```
# alt_disk_install -B -C hdisk1
Calling mkszfile to create new /image.data file.
```

```

Checking disk sizes.
Creating cloned rootvg volume group and associated logical volumes.
Creating logical volume alt_hd5.
Creating logical volume alt_hd6.
Creating logical volume alt_hd8.
Creating logical volume alt_hd4.
Creating logical volume alt_hd2.
Creating logical volume alt_hd9var.
Creating logical volume alt_hd3.
Creating logical volume alt_hd1.
Creating logical volume alt_hd10opt.
Creating /alt_inst/ file system.
Creating /alt_inst/home file system.
Creating /alt_inst/opt file system.
Creating /alt_inst/tmp file system.
Creating /alt_inst/usr file system.
Creating /alt_inst/var file system.
Generating a list of files
for backup and restore into the alternate file system...
Backing-up the rootvg files and restoring them to the alternate file system...
Modifying ODM on cloned disk.
Building boot image on cloned disk.
forced unmount of /alt_inst/var
forced unmount of /alt_inst/usr
forced unmount of /alt_inst/tmp
forced unmount of /alt_inst/opt
forced unmount of /alt_inst/home
forced unmount of /alt_inst
forced unmount of /alt_inst
Changing logical volume names in volume group descriptor area.
Fixing LV control blocks...
Fixing file system superblocks...

```

```

# lspv | grep root
hdisk0 00531d9a33ff6ab5          rootvg          active
hdisk1 00531d9a47ed2df6          altinst_rootvg active

```

13. Ensure all users are logged off and prevent new user logon, as shown in Example 4-58.

Example 4-58 Checking for active user sessions and preventing new logon

```

# w
# touch /etc/nologin

```

14. Set up the NIM environment for the upgrade of the NIM client.

We reset the NIM client to ensure that it is in a clean state before attempting the migration. We run a custom script (see Example 4-59 on page 177) to

reset the NIM client. The script does a force reset, deallocates resources, and clears the client's CPU ID.

If a failure occurs during a NIM migration/installation with the message code: 0042-008 NIM has attempted to establish socket communications with a remote machine, and it has refused the connection, it means that the CPU ID attribute on the client's machine definition may be obsolete (for example, if the machine's system planar was recently replaced or the client definition was recently used for a NIM installation on a different system). To guarantee that this is not the case, erase the CPU ID from the machine definition.

Notes:

- ▶ The CPU ID of a NIM client is stored in the NIM database so that the master can perform verification that NIM client commands are coming from the machines that were originally registered as clients. A NIM administrator would not want this CPU ID validation to be performed in the following situations:

- When the hardware of a client machine is changed, giving the client a new CPU ID
- When a single client definition is used to install different machines, as on a preinstall assembly line

To disable client CPU ID validation, set the attribute *validate_cpuid=no* on the NIM master:

```
# nim -o change -a validate_cpuid=no master
```

- ▶ However, the value of the *validate_cpuid* attribute *should not be changed while operations are being performed on NIM clients*, because this could potentially disrupt client communications for active machines.

Example 4-59 Reset the NIM client before the migration

```
{nimmast}:/ # cat /work/nim_scripts/resetnimclient
#!/usr/bin/ksh
# Reset a NIM client.

if [[ "$1" = "" ]] ; then
    echo Please specify a NIM client to reset e.g. LPAR4.
else
    if /usr/sbin/lsmim -l $1 > /dev/null 2>&1 ; then
        /usr/sbin/nim -o reset -F $1
        /usr/sbin/nim -Fo deallocate -a subclass=all $1
        /usr/sbin/nim -Fo change -a cpuid= $1
    fi
fi
```

```

else
    echo Not a valid NIM client!
fi
fi

{nimmast}:/ # /work/nim_scripts/resetnimclient LPAR4

```

Then we enabled a BOS installation for NIM client LPAR4 using our AIX 5L V5.3 lpp_source and SPOT. We also chose not to initiate reboot of the client now; see Example 4-60.

Example 4-60 Installing the client

```

{nimmast}:/ # smitty nim_bosinst
          Install the Base Operating System on Standalone Clients

* Installation Target                LPAR4
* Installation TYPE                  rte
* SPOT                              SPOT_53_ML4
  LPP_SOURCE                         [LPP_53_ML4]

ACCEPT new license agreements?      [yes]
this target?

Initiate reboot and installation now? [no]

```

We verify that the NIM resources are now setup to migrate the NIM client. We check the status of the NIM client using `lsmim`, ensure that the AIX 5L V5.3 lpp_source and SPOT have been allocated, confirm that the client's Cstate attribute is set to: BOS installation has been enabled, review the files in /tftpboot, and check the entry in /etc/bootptab is correct. We execute a script (chknim) to show the current status of the NIM client, as shown in Example 4-61 and Example 4-62 on page 179.

Example 4-61 Verifying the NIM client is set up to migrate - current status

```

{nimmast}:/usr/local/bin # chknim LPAR4
/tftpboot files.
total 79680
-rw-r--r--  1 root    system    8162755 Jun 02 10:37
spotaix5104.chrp.mp.ent
-rw-r--r--  1 root    system    8720910 Jun 02 11:49
spotaix5204.chrp.mp.ent
-rw-r--r--  1 root    system    11688960 Jun 12 11:13 SPOT-V10.chrp.mp.ent
-rw-r--r--  1 root    system    12211712 Jun 13 13:13
SPOT_53_ML4.chrp.mp.ent
-rw-r--r--  1 root    system          934 Jun 15 12:10 lpar4.info

```

```
lrwxrwxrwx 1 root system 33 Jun 15 12:10 lpar4 ->
/tftpboot/SPOT_53_ML4.chrp.mp.ent

/etc/bootptab entries:
# bs -- boot image size
# dt -- old style boot switch
# T170 -- (xstation only) -- server port number
# T175 -- (xstation only) -- primary / secondary boot host indicator
# T176 -- (xstation only) -- enable tablet
# T177 -- (xstation only) -- xstation 130 hard file usage
# T178 -- (xstation only) -- enable XDMCP
# T179 -- (xstation only) -- XDMCP host
# T180 -- (xstation only) -- enable virtual screen
lpar4:bf=/tftpboot/lpar4:ip=10.1.1.68:ht=ethernet:sa=10.1.1.1:sm=255.255.255.0:
```

```
nim client info:
LPAR4:
  class      = machines
  type       = standalone
  connect    = shell
  platform   = chrp
  netboot_kernel = mp
  if1        = NET_EN1 lpar4 0
  cable_type1 = tp
  Cstate     = BOS installation has been enabled
  prev_state = ready for a NIM operation
  Mstate     = currently running
  boot       = boot
  lpp_source = LPP_53_ML4
  nim_script = nim_script
  spot       = SPOT_53_ML4
  cpuid      = 001A85D24C00
  control    = master
  current_master = nimmast
  sync_required = yes
```

Example 4-62 shows the `chknim` script.

Example 4-62 chknim script

```
echo "/tftpboot files."
ls -ltr /tftpboot/
echo
echo "/etc/bootptab entries:"
tail /etc/bootptab
echo
if [[ "$1" != "" ]]
then
  echo "NIM client info:"
```

```
lsnim -l $1
fi
```

15. Performing the AIX migration

At this point, we are ready to start the AIX migration for the client. We connect to our HMC and open a console window for LPAR4. We configure our client (via the SMS menus) to boot from the network.

We login as root via the console and reboot the system as shown in Example 4-63.

Note: We recommend rebooting the system and checking that it restarts successfully before the migration. This may uncover any issues that already exist on the system but would be blamed on the migration.

Example 4-63 Reboot the system

```
# shutdown -Fr
```

- ▶ Press the 1 key to enter the SMS menu, as shown in Example 4-64. Once within the SMS menu, we can configure the clients IP details via the Remote Initial Program Load (IPL) setup menu.

Example 4-64 SMS menu

```
1 = SMS Menu          5 = Default Boot List
6 = Stored Boot List  8 = Open Firmware Prompt
```

```
memory   keyboard   network   scsi     speaker
```

- ▶ Select **4. Setup Remote IPL (Initial Program Load)**; see Example 4-65).

Example 4-65 Setup Remote IPL

```
pSeries Firmware
Version RG050215_d79e02_regatta
SMS 1.3 (c) Copyright IBM Corp. 2000,2003 All rights reserved.
```

```
-----
Main Menu
1. Select Language
2. Password Utilities NOT available in LPAR mode
3. View Error Log
4. Setup Remote IPL (Initial Program Load)
5. Change SCSI Settings
6. Select Console NOT available in LPAR mode
```

7. Select Boot Options

Navigation Keys:

X = eXit System Management Services

Type the number of the menu item and press Enter or select Navigation Key:

- ▶ Select the network adapter to configure; see Example 4-66.

Example 4-66 NIC selection

pSeries Firmware

Version RG050215_d79e02_regatta

SMS 1.3 (c) Copyright IBM Corp. 2000,2003 All rights reserved.

NIC Adapters

Device	Slot	Hardware Address
1. 10/100 Mbps Ethernet PCI Adapt	2:U1.5-P2-I2/E1	000255afcdf7

Navigation keys:

M = return to Main Menu

ESC key = return to previous screen

X = eXit System Management Services

Type the number of the menu item and press Enter or select Navigation Key:

- ▶ Select **1. IP Parameters**; see Example 4-67.

Example 4-67 IP Parameters menu

pSeries Firmware

Version RG050215_d79e02_regatta

SMS 1.3 (c) Copyright IBM Corp. 2000,2003 All rights reserved.

Network Parameters

10/100 Mbps Ethernet PCI Adapter II: U1.5-P2-I2/E1

- 1. IP Parameters**
 2. Adapter Configuration
 3. Ping Test
-

Navigation keys:

M = return to Main Menu

ESC key = return to previous screen

X = eXit System Management Services

Type the number of the menu item and press Enter or select Navigation Key:

- ▶ Enter the client, server and gateway IP address and the subnet mask; see Example 4-68.

Example 4-68 Configuring IP parameters

pSeries Firmware
Version RG050215_d79e02_regatta
SMS 1.3 (c) Copyright IBM Corp. 2000,2003 All rights reserved.

IP Parameters
10/100 Mbps Ethernet PCI Adapter II: U1.5-P2-I2/E1
1. Client IP Address [10.1.1.68]
2. Server IP Address [10.1.1.1]
3. Gateway IP Address [000.000.000.000]
4. Subnet Mask [255.255.255.000]

Navigation keys:
M = return to Main Menu
ESC key = return to previous screen X = eXit System Management Services

Type the number of the menu item and press Enter or select Navigation Key:

- ▶ Execute a Ping Test to ensure that the client can communicate with the NIM master; see Example 4-69.

Example 4-69 Selecting Ping Test menu

pSeries Firmware
Version RG050215_d79e02_regatta
SMS 1.3 (c) Copyright IBM Corp. 2000,2003 All rights reserved.

Ping Test
10/100 Mbps Ethernet PCI Adapter II: U1.5-P2-I2/E1
Speed, Duplex: 100,full
Client IP Address: 10.1.1.68
Server IP Address: 10.1.1.1
Gateway IP Address: 000.000.000.000
Subnet Mask IP Address: 255.255.255.000
Protocol: Standard
Spanning Tree Enabled: No
Connector Type: rj45

1. Execute Ping Test

Navigation keys:
M = return to Main Menu
ESC key = return to previous screen X = eXit System Management Services

Type the number of the menu item and press Enter or select Navigation Key:

The Ping Test results are shown in Example 4-70 on page 183.

Example 4-70 Successful Ping Test output

```
-----  
| Attempting Ping... |  
-----
```

```
PING: chosen-network-type = ethernet,100,rj45,full  
PING: client IP = 10.1.1.68  
PING: server IP = 10.1.1.1  
PING: gateway IP = 0.0.0.0  
PING: device /pci@3fffbe09000/pci@b,2/ethernet@1  
PING: loc-code U1.5-P2-I2/E1
```

```
PING: Ready to ping:  
PING: source hardware address is 0 2 55 af cd f7  
PING: destination hardware address is 0 9 6b 2e 26 1d  
PING: source IP address is 10.1.1.68  
PING: destination IP address is 10.1.1.1
```

```
-----  
| Ping Success. |  
-----
```

Press any key to continue.....

- ▶ Exit back (use Esc) to the Main Menu; see Example 4-71.

Example 4-71 Back to SMS Main Menu

```
pSeries Firmware  
Version RG050215_d79e02_regatta  
SMS 1.3 (c) Copyright IBM Corp. 2000,2003 All rights reserved.  
-----
```

- ```
Main Menu
1. Select Language
2. Password Utilities NOT available in LPAR mode
3. View Error Log
4. Setup Remote IPL (Initial Program Load)
5. Change SCSI Settings
6. Select Console NOT available in LPAR mode
7. Select Boot Options
```

-----  
Navigation Keys:

X = eXit System Management Services

---

Type the number of the menu item and press Enter or select Navigation Key:

---

- ▶ **Select 7. Select Boot Options;** see Example 4-72.

*Example 4-72 Boot Options*

---

pSeries Firmware  
Version RG050215\_d79e02\_regatta  
SMS 1.3 (c) Copyright IBM Corp. 2000,2003 All rights reserved.

---

Main Menu

1. Select Language
  2. Password Utilities NOT available in LPAR mode
  3. View Error Log
  4. Setup Remote IPL (Initial Program Load)
  5. Change SCSI Settings
  6. Select Console NOT available in LPAR mode
  7. Select Boot Options
- 

Navigation Keys:

X = eXit System Management Services

---

Type the number of the menu item and press Enter or select Navigation Key:

---

- ▶ **Select 1. Select Install or Boot Device;** see Example 4-73.

*Example 4-73 Boot Device selection*

---

pSeries Firmware  
Version RG050215\_d79e02\_regatta  
SMS 1.3 (c) Copyright IBM Corp. 2000,2003 All rights reserved.

---

- 1. Select Install or Boot Device**
  2. Configure Boot Device Order
  3. Multiboot Startup <OFF>
- 

Navigation keys:

M = return to Main Menu

ESC key = return to previous screen

X = eXit System Management Services

---

Type the number of the menu item and press Enter or select Navigation Key:

---

- ▶ **Select 6. Network;** see Example 4-74.

*Example 4-74 Network boot selection*

---

pSeries Firmware  
Version RG050215\_d79e02\_regatta  
SMS 1.3 (c) Copyright IBM Corp. 2000,2003 All rights reserved.

---

- Select Device Type
1. Diskette
  2. Tape
  3. CD/DVD
  4. IDE
  5. Hard Drive
  - 6. Network**
  7. List all Devices

---

Navigation keys:  
M = return to Main Menu  
ESC key = return to previous screen                      X = eXit System Management Services

---

Type the number of the menu item and press Enter or select Navigation Key:

---

- ▶ Select the network adapter to boot from; see Example 4-75.

*Example 4-75 Ethernet device selection*

---

pSeries Firmware  
Version RG050215\_d79e02\_regatta  
SMS 1.3 (c) Copyright IBM Corp. 2000,2003 All rights reserved.

---

Select Device

| Device Number | Current Position | Device Name                             |
|---------------|------------------|-----------------------------------------|
| <b>1.</b>     | <b>1</b>         | <b>Ethernet ( loc=2:U1.5-P2-I2/E1 )</b> |

---

Navigation keys:  
M = return to Main Menu  
ESC key = return to previous screen                      X = eXit System Management Services

---

Type the number of the menu item and press Enter or select Navigation Key:

---

- ▶ Select **2. Normal Mode Boot**; see Example 4-76.

*Example 4-76 Selecting Boot Mode*

---

pSeries Firmware  
Version RG050215\_d79e02\_regatta  
SMS 1.3 (c) Copyright IBM Corp. 2000,2003 All rights reserved.

---

Select Task

Ethernet ( loc=2:U1.5-P2-I2/E1 )

1. Information

- 2. Normal Mode Boot
- 3. Service Mode Boot

-----  
 Navigation keys:  
 M = return to Main Menu  
 ESC key = return to previous screen                      X = eXit System Management Services  
 -----  
 Type the number of the menu item and press Enter or select Navigation Key:

► Select **1. Yes**; see Example 4-77.

*Example 4-77 Accepting boot parameters*

-----  
 pSeries Firmware  
 Version RG050215\_d79e02\_regatta  
 SMS 1.3 (c) Copyright IBM Corp. 2000,2003 All rights reserved.  
 -----

Are you sure you want to exit System Management Services?  
**1. Yes**  
 2. No

-----  
 Navigation Keys:  
  
X = eXit System Management Services  
 -----  
 Type the number of the menu item and press Enter or select Navigation Key:

► The system will now perform a network boot as shown in Example 4-78.

*Example 4-78 System network boot*

-----  
 STARTING SOFTWARE  
 PLEASE WAIT...  
  
 BOOTP: chosen-network-type = ethernet,100,rj45,full  
 BOOTP: server IP = 10.1.1.1  
 BOOTP: requested filename =  
 BOOTP: client IP = 10.1.1.14  
 BOOTP: client HW addr = 0 2 55 af cd f7  
 BOOTP: gateway IP = 0.0.0.0  
 BOOTP: device /pci@3fffbe09000/pci@b,2/ethernet@1  
 BOOTP: loc-code U1.5-P2-I2/E1  
 BOOTP: Cancel = ctl-C  
 BOOTP R = 1 BOOTP S = 1  
  
 FILE: /tftpboot/lpar4  
 Load Addr=0x4000 Max Size=0xffffc000

FINAL Packet Count = 17034 FINAL File Size = 8720910 bytes.

Elapsed time since release of system processors: 345447 mins 24 secs

```

 Welcome to AIX.
 boot image timestamp: 09:49 06/02
 The current time and date: 12:13:35 06/15/2006
 number of processors: 2 size of memory: 1024Mb
boot device:
/pci@3fffbe09000/pci@b,2/ethernet@1:speed=100,duplex=full,bootp,10.1.1.1,,10.1.
1.14,10.1.1.1
closing stdin and stdout...

```

**Tip:** You also can force the system to boot from the network during next reboot with the following command:

```
bootlist -m normal en0 bserver=10.1.1.1 gateway=10.1.1.1 \
client=10.1.1.68
shutdown -Fr
```

This will boot the system from the network via en0. If there are issues with the network boot, you will need to go into the SMS menus and perform a ping test to troubleshoot the problem.

- ▶ You will be prompted to define the system console for the migration as shown in Example 4-79. Type 1 and press Enter.

#### *Example 4-79 Defining the system console*

```
***** Please define the System Console. *****
```

Type a 1 and press Enter to use this terminal as the system console.

Pour definir ce terminal comme console systeme, appuyez sur 1 puis sur Entree.

Taste 1 und anschliessend die Eingabetaste druecken, um diese Datenstation als Systemkonsole zu verwenden.

Premere il tasto 1 ed Invio per usare questo terminal come console.

Escriba 1 y pulse Intro para utilizar esta terminal como consola del sistema.

Escriuiu 1 i premeu Intro per utilitzar aquest terminal com a consola del sistema.

Digite um 1 e pressione Enter para utilizar este terminal como console do sistema.

>>> 1 Type 1 and press Enter to have English during install.

88 Help ?

>>> Choice [1]:

- 
- ▶ The menu Welcome to Base Operation System Installation and Maintenance will appear next, as shown in Example 4-80. Select **2 Change/Show Installation Settings and Install**.

*Example 4-80 BOS install welcome menu*

---

```
 Welcome to Base Operating System
 Installation and Maintenance
```

Type the number of your choice and press Enter. Choice is indicated by >>>.

>>> 1 Start Install Now with Default Settings

2 Change/Show Installation Settings and Install

3 Start Maintenance Mode for System Recovery

88 Help ?

99 Previous Menu

>>> Choice [2]:

- 
- ▶ The installation and settings menu appears as shown in Example 4-82 on page 189. Ensure that the Method of Installation is Migration. Check that the correct disk will be used for the migration.

For systems that boot from SAN (for example, rootvg resides on SAN disk), the hdisk numbers may not reflect the numbers recorded prior to the migration. To confirm that the correct disk is being selected for migration, confirm the LUN ID of the rootvg disk is correct.

Perform this by exiting from the Migration menu and selecting the menu **New and Complete Overwrite**. Then select the disks to install onto and select **77 Display Alternative Disk Attributes**. This will give you the LUN ID, which you can then match against the lscfg output you captured earlier.

After confirming that the LUN ID to hdisk mapping is correct, re-enter the migration menu and continue with the migration; refer to Example 4-81 on page 189.

*Example 4-81 Alternative disk attributes for LUN IDs*

---

| Name  | Device | Adapter | Connection          | Location          |
|-------|--------|---------|---------------------|-------------------|
|       |        |         | or Physical         | Location Code     |
| >>> 1 | hdisk0 | ...     | -W500507630303427E- | L4018400000000000 |
| 2     | hdisk4 | ...     | -W500507630308427E- | L400E400000000000 |
| 3     | hdisk1 | ...     | -W500507630303427E- | L4007400300000000 |

---

Select **3 More Options**, as shown in Example 4-82.

*Example 4-82 BOS installation settings menu*

---

Installation and Settings

Either type 0 and press Enter to install with current settings, or type the number of the setting you want to change and press Enter.

```
1 System Settings:
 Method of Installation.....Migration
 Disk Where You Want to Install....hdisk0

2 Primary Language Environment Settings (AFTER Install):
 Cultural Convention.....English (United States)
 Language.....English (United States)
 Keyboard.....English (United States)
 Keyboard Type.....Default

3 More Options (Desktop, Security, Kernel, Software, ...)

>>> 0 Install with the settings listed above.
```

```
88 Help ? | +-----+
99 Previous Menu | | WARNING: Base Operating System Installation will
 | | destroy or impair recovery of SOME data on the
 | | destination disk hdisk0.
```

---

a. The menu shown in Example 4-83 is displayed.

*Example 4-83 Select other options for the migration*

---

|                                                     |      |
|-----------------------------------------------------|------|
| 1. Desktop .....                                    | NONE |
| 2. Enable Trusted Computing Base .....              | No   |
| 3. Import User Volume Groups .....                  | Yes  |
| 4. Enable System Backups to install any System .... | No   |
| (Install all devices and kernels)                   |      |
| 5. Remove Java 1.1.8 Software .....                 | No   |

---

b. In the Migration Installation Confirmation menu, shown in Example 4-84 on page 190, select **1**, “**Install with current settings**”.

*Example 4-84 Migration Installation Confirmation menu*

---

Migration Installation Confirmation

Disks: hdisk0  
Cultural Convention: en\_US  
Language: en\_US  
Keyboard: en\_US  
Import User Volume Groups: yes  
Enable System Backups to install any system: no  
Remove Java 1.1.8 Software: no

>>> 1 Continue with Install

```
 88 Help ? | +-----+
 99 Previous Menu | | WARNING: Base Operating System Installation will
 | | destroy or impair recovery of SOME data on the
 | | destination disk hdisk0.
```

>>> Choice [1]:

Select 1, "Install with current settings"

---

- c. Review the output from each selection on the confirmation menu (for example, 1, 2, and 3) as shown in Example 4-85. (If you want to abandon the migration for any reason you can do so at this point by selecting option 4, which will reboot the system without migrating.)

**Select 0 Continue with the migration.**

*Example 4-85 Migration Confirmation menu*

---

Migration Confirmation

Either type 0 and press Enter to continue the installation, or type the number of your choice and press Enter.

- 1 List the saved Base System configuration files which will not be merged into the system. These files are saved in /tmp/bos.
- 2 List the filesets which will be removed and not replaced.
- 3 List directories which will have all current contents removed.
- 4 Reboot without migrating.

Acceptance of license agreements is required before using system.  
You will be prompted to accept after the system reboots.

>>> 0 Continue with the migration.

88 Help ?



```
+----- WARNING:
Selected files, directories, and filesets (installable options) from the Base
System will be removed. Choose 2 or 3 for more information.
```

```
>>> Choice[0]: 1
```

```
/etc/motd
/etc/rc
/etc/tsh_profile
/sbin/rc.boot
/usr/sbin/skulker
```

```
End of list. Press Enter
```

```
>>> Choice[0]: 2
```

```
End of list. Press Enter
```

```
>>> Choice[0]: 3
```

```
/lpp/bos
/tmp
/usr/lpp/bos/bos.rte
/usr/lpp/bos/bos.rte.*
/usr/lpp/bos/deinst1
```

```
End of list. Press Enter
```

```
>>> Choice[0]: 0
```

```
Saving system configuration files in /tmp/bos...
Removing obsolete filesets, directories, and files...
```

---

Migration should now commence. Depending on your environment, the process should take from 30 to 60 minutes. The system will reboot when the migration process completes.

16. Monitor the status of the migration, as shown in Example 4-86. You can monitor the status by watching the console output via a *vterm* session on the HMC, or you can run the `lsnim -a info` command on the NIM master to view the progress of the client's migration.

*Example 4-86 Monitoring the migration status of LPAR4 (partial output)*

---

```
{nimmast}:/ # lsniminst LPAR4
LPAR4:
 info = LED 610: mount -r nimmast:/AIX53ML4/SPOT_53_ML4/usr /SPOT/usr
LPAR4:
 info = setting_console
LPAR4:
```

```

 info = verifying_data_files
LPAR4:
 info = prompting_for_data_at_console
LPAR4:
 info = BOS install 1% complete : Importing root volume group.
LPAR4:
 info = BOS install 4% complete : Copying old files
LPAR4:
info = BOS install 7% complete : Restoring base operating system.
LPAR4:
 info = BOS install 12% complete : Initializing disk environment.
LPAR4:
 info = BOS install 13% complete : Over mounting /.
LPAR4:
 info = BOS install 16% complete : Merging.
LPAR4:
 info = BOS install 19% complete : Installing additional software.
LPAR4:
 info = BOS install 96% complete : Initializing dump device.
LPAR4:
 info = BOS install 97% complete : Network Install Manager customization.
LPAR4:
 info = BOS install 98% complete : Creating boot image.
LPAR4:
 info = BOS install 100% complete

```

---

We ran the script shown in Example 4-87 on the NIM master. The script continuously displayed the progress of our LPAR's migration.

*Example 4-87 lsniminst script*

---

```

host=$1
while true
do
 lsnim -a info $host
 sleep 5
done

```

---

17. After the migration is finished and the client has rebooted, we check the NIM client state to ensure it has been reset correctly after the NIM migration. Notice that the current state (Cstate) is now showing: ready for a NIM operation as shown in Example 4-88.

*Example 4-88 Check the NIM client status after the migration*

---

```

{nimmast}:/ # lsnim -l LPAR4
LPAR4:
 class = machines
 type = standalone

```

```
connect = shell
platform = chrp
netboot_kernel = mp
if1 = NET_EN1 lpar4 0
cable_type1 = tp
Cstate = ready for a NIM operation
prev_state = not running
Mstate = currently running
cpuid = 001A85D24C00
Cstate_result = success
current_master = nimmast
sync_required = yes
```

---

18. We check the system configuration after the migration completes; see Example 4-89.

*Example 4-89 Checking the system after a migration*

---

```
oslevel -r
oslevel -s
instfix -i | grep AIX
instfix -icqk ML-LEVEL | grep “:-:”
lppchk -m3 -v
lppchk -m3 -c
lspv
lsvg
lsvg -o
lsdev -Cc disk
lsvg -l rootvg
```

---

19. We check the files in /var/adm/ras as shown in Example 4-90. These log files can also be viewed from the NIM master via the NIM showlog operation.

*Example 4-90 Console, NIM and BOS installation/migration log files*

---

```
alog -f /var/adm/ras/conslog -o
more /var/adm/ras/bootlog
more /var/adm/ras/bosinstlog
more /var/adm/ras/nim.script
more /var/adm/ras/devinst.log.

{nimmast}:/ # nim -o showlog -a log_type=bosinst LPAR4
{nimmast}:/ # nim -o showlog -a log_type=niminst LPAR4
{nimmast}:/ # nim -o showlog -a log_type=script LPAR4
```

---

20. We restore and update the /etc/motd and /etc/sendmail.cf file, as shown in Example 4-91 on page 194.

**Note:** Do not simply copy the sendmail.cf file over the new one, because the configuration file changes with each version of sendmail. Review the file and determine which information needs to be migrated to the new sendmail.cf file.

*Example 4-91 /etc/motd and /etc/sendmail.cf files after a migration*

---

```
cp -p /home/premig/motd /etc/motd
vi /etc/motd
; change AIX version info etc.
grep ^DS /home/premig/sendmail.cf
xyz-mailserver.com
vi /etc/sendmail.cf
; Change DS line xyz-mailserver.com
; Send a test email.
mail -v somebody@xyzcompany.com
mailq
tail /var/log/maillog
```

---

21. We clean up any old AIX 5L V5.2 filesets, as shown in Example 4-92.

*Example 4-92 Clean up AIX 5L V5.2 filesets if appropriate*

---

```
ls|pp -l | grep 5.2
smit deinstall

Remove Installed Software

* SOFTWARE name [bos.docsearch*]

PREVIEW only? (remove operation will NOT occur) yes
REMOVE dependent software? yes
EXTEND file systems if space needed? no
DETAILED output? no
```

---

22. We install SDD for AIX 5L V5.3 (this is optional, and is only for systems using SDD). At this stage you would install the correct version of SDD for AIX 5L V5.3. You would need to remove the previous version for AIX 5.2 first; refer to the SDD user's guide for more information.

23. We verify that the AIX (and optionally, SDD) levels are correct, as shown in Example 4-93.

*Example 4-93 Checking the AIX version and level after migration*

---

```
oslevel -s
5300-04-01
lppchk -m3 -v
instfix -i | grep AIX
```

All filesets for 5.3.0.0\_AIX\_ML were found.  
All filesets for 5300-01\_AIX\_ML were found.  
All filesets for 5300-02\_AIX\_ML were found.  
All filesets for 5300-03\_AIX\_ML were found.  
All filesets for 5300-04\_AIX\_ML were found.

```
lspp -l devices.sdd*
Fileset Level State Description

Path: /usr/lib/objrepos
devices.sdd.53.rte 1.6.0.5 COMMITTED IBM Subsystem Device Driver
 for AIX V53

Path: /etc/objrepos
devices.sdd.53.rte 1.6.0.5 COMMITTED IBM Subsystem Device Driver
 for AIX V53
```

---

24. We check and clean the error report. We check the AIX error report for any hardware or other issues after the migration. Everything looks fine, so we clear the errpt; see Example 4-94.

*Example 4-94 Checking the AIX error report after migration*

---

```
errpt
errpt -a
errclear 0
```

---

25. Optional - SDD was upgraded, then a reboot must be performed now.

26. Optional - SDD - Verify data path's and volume groups as shown in Example 4-95. SDD will configure the altinst\_rootvg volume group as a vpath device. Rectify this situation.

*Example 4-95 Check the SDD configuration after migration*

---

```
datapath query adapter
datapath query device
datapath query wwpn

lsvg
lsvg -o
lspv
vp2hd altinst_rootvg
rmdev -dl vpathX
```

---

27. We verify the IP configuration, as shown in Example 4-96.

*Example 4-96 Checking network configuration after the migration*

---

```
ifconfig -a
```

```
netstat -nr
entstat -d entX
```

---

28. We verify that the date, time, and certain environment variables (for example, LANG and TZ) are correct for the environment after the migration; see Example 4-97.

*Example 4-97 Check environment variables and date/time after migration*

---

```
date
echo $TZ
echo $LANG
```

---

29. We upgrade SSH, SSL, lsof and nmon to the correct version for AIX 5L V5.3 (only if required).

30. We enable cron as shown in Example 4-98.

*Example 4-98 Enabling cron*

---

```
chitab "cron:23456789:respawn:/usr/sbin/cron"
telinit q
```

---

## Post-migration tasks

This section describes the post-migration tasks.

1. Run the post\_migration script as shown in Example 4-99. The output is saved to the /home directory. Review the files and ensure installation verification is fine.

*Example 4-99 Running the post\_migration script*

---

```
rcp nimmast:/AIX53ML4/SPOT_53_ML4/usr/lpp/bos/post_migration /tmp
/tmp/post_migration
```

---

2. Create a mksysb backup of the client as shown in Example 4-100.

*Example 4-100 Creating a mksysb backup of the client after the migration*

---

```
/usr/local/bin/sysbtonim -s rootvg >> /var/log/sysbtonim.log 2>&1
```

---

3. Remove the pre-migration and post-migration directories in /home.
4. Start the applications and perform verification testing.
5. Restore rootvg to a mirrored disk configuration as shown in Example 4-101. Reboot the system to turn off quorum for rootvg.

*Example 4-101 Mirroring rootvg after migration*

---

```
alt_disk_install -X altinst_rootvg
```

```
extendvg rootvg hdisk1
mirrorvg rootvg hdisk1
bosboot -a -d /dev/hdisk0
bosboot -a -d /dev/hdisk1
bootlist -m normal hdisk0 hdisk1
bootlist -m normal -o
hdisk0
hdisk1
shutdown -Fr
```

---

## Backing out a failed AIX migration

Follow the procedures in this section to back out a AIX 5L V5.3 migration. Using an alternate rootvg allows rebooting on the original disk and restarting the system with the previous version of AIX.

1. Set the bootlist to boot from original rootvg, as shown in Example 4-102.

*Example 4-102 Setting the bootlist to the alternate rootvg*

---

```
lspv | grep altinst_rootvg
hdisk1
bootlist -m normal hdisk1
```

---

2. Verify that the bootlist only has hdisk1, as shown in Example 4-103.

*Example 4-103 Checking the bootlist*

---

```
bootlist -m normal -o
hdisk1
```

---

3. Reboot the server, as shown in Example 4-104.

*Example 4-104 Reboot the system*

---

```
shutdown -Fr
```

---

4. Restore the mksysb if issues with the alternate rootvg, or if it no longer exists. If required, restore rootvg to a mirrored disk configuration, as shown in Example 4-105. Reboot the system to turn off quorum for rootvg.

*Example 4-105 Mirroring rootvg after migration*

---

```
alt_disk_install -X altinst_rootvg
extendvg rootvg hdisk1
mirrorvg rootvg hdisk1
bosboot -a -d /dev/hdisk0
bosboot -a -d /dev/hdisk1
bootlist -m normal hdisk0 hdisk1
bootlist -m normal -o
```

```
hdisk0
hdisk1
shutdown -Fr
```

---

5. Reboot the server:

```
shutdown -Fr
```

6. Verify the system and start the applications.

At this point in our case, our NIM migration to AIX 5L V5.3 is now complete. Our client has been successfully upgraded from AIX 5L V5.2 to AIX 5L V5.3.

#### 4.4.4 Debugging a NIM AIX migration

Enabling BOS install debug output is very useful if you need to troubleshoot a migration or installation via NIM. With debug information turned on, all the commands and the output from the installation are displayed on the console or tty. This is can be useful, because you will be able to see the commands or operations that failed and then take corrective action. Using BOS debug output can save you time in determining the root cause of a problem, and can reduce the scope of your investigation.

You will see the **showled** command and its output within the debug output. This command displays the system's LED value at each stage of the process. This can also be useful because many known problems can be referenced by the LED value displayed when a problem occurs.

There are two methods for enabling debug output during a BOS installation or migration:

- ▶ By entering a special value at one of the installation menus (manually produce debug output).
- ▶ By using a `bosinst_data` resource to tell the installation program to display debug output (automatically produce debug output).

These methods are explained in more detail in the following sections.

##### Manually producing debug output

Use this procedure to produce debug output without using a `bosinst_data` resource. To enable debugging for the BOS installation program, start by performing all the processing you would normally do to install or migrate a client. Because you are not using a `bosinst_data` resource, you will be prompted to supply information about the installation to the BOS installation program, as described here.

1. Select your console.



2. Select your language.
3. The Welcome to Base Operating System Installation and Maintenance menu is displayed. Instead of selecting one of the options, type 911 at the prompt and press Enter.
4. Continue the normal procedure for selecting options and specifying data until the installation begins. Debug output will be sent to the client's display while the installation proceeds.

### ***Automatically producing debug output***

Use this procedure to produce debug output when using a `bosinst_data` resource.

1. To enable debugging for the BOS installation program, set the value `BOSINST_DEBUG = yes` in the `control_flow` stanza of the `bosinst.data` file that you are using for your `bosinst_data` resource.

A minimum `bosinst.data` file for debugging purposes would contain the following lines:

```
control_flow:
 BOSINST_DEBUG = yes
```

2. In addition to the processing you would normally do to install or migrate a client, include the modified `bosinst_data` resource as a resource for the operation.

After the client boots over the network, it will use the `bosinst_data` resource to obtain settings for the installation. If the only data specified in your `bosinst.data` file is `BOSINST_DEBUG = yes`, then you will be prompted for the remaining required information before the installation will continue. Debug output will be sent to the client's display while the installation continues.

In Example 4-106, we use a combination of the `script` command and the `vtmenu` tool on the HMC to capture all of the debug output to a file for further analysis.

1. We prepare our migration for the client as shown previously.
2. We run the `script` command to capture session output.  

```
{nimmast}:/ # cd /tmp ; script bosdebug.out
```
3. We connect to the HMC and run `vtmenu` to connect to the LPARs console (in our case, `lpar4` is the system to be migrated so we entered 3 to open a virtual terminal).

*Example 4-106 Using vtmenu to open a console*

---

```
{nimmast}:/tmp # ssh hscroot@hmcvico
[hscroot@hmcvico hscroot]$ vtmenu
```

Retrieving name of managed system(s) . . . vico

-----  
Partitions On Managed System: vico  
-----

|    |       |          |
|----|-------|----------|
| 1) | lpar6 | Running: |
| 2) | lpar5 | Running: |
| 3) | lpar4 | Running: |
| 4) | lpar3 | Running: |
| 5) | lpar2 | Running: |
| 6) | lpar1 | Running: |
| 7) | lpar7 | Ready:   |
| 8) | lpar8 | Ready:   |
| 9) | lpar9 | Ready:   |

Enter Number of Running Partition (q to quit): 3

Opening Virtual Terminal On Partition lpar4 . . .

NVTS hmcvico 9734 004\*7040-671\*01A85D2 1 004\*7040-671\*01A85D2 \_VT\_

AIX Version 5

(C) Copyrights by IBM and by others 1982, 2004.

Console login:

- 
4. We start the normal network boot process. When presented with the Welcome to Base Operating System menu, we enter 911. A message appeared at the bottom of the screen letting us know that debug is enabled (for example: BOSINST\_DEBUG enabled); see Example 4-107.

*Example 4-107 Enabling BOS installation debug output*

---

Welcome to Base Operating System  
Installation and Maintenance

Type the number of your choice and press Enter. Choice is indicated by >>>.

```
>>> 1 Start Install Now with Default Settings
 2 Change/Show Installation Settings and Install
 3 Start Maintenance Mode for System Recovery
 88 Help ?
 99 Previous Menu
```

```
>>> Choice [1]: 911
```

Welcome to Base Operating System  
Installation and Maintenance

Type the number of your choice and press Enter. Choice is indicated by >>>.

```
>>> 1 Start Install Now with Default Settings
 2 Change/Show Installation Settings and Install
 3 Start Maintenance Mode for System Recovery

 BOSINST_DEBUG enabled

 88 Help ?
 99 Previous Menu
```

```
>>> Choice [1]:
```

---

5. We continue with the migration as normal.

6. All debug output is displayed to the screen (tty), as shown in Example 4-108.

*Example 4-108 BOS debug partial output*

---

```
+ [[migrate = overwrite]]
+ [[migrate = erase_only]]
+ [-z]
+ Log Shrink_It
+ + ../SPOT/usr/lpp/bosinst/bidata -i -g logical_volume_policy -f SHRINK
SHR=
+ + ../SPOT/usr/lpp/bosinst/bidata -i -g image_data -f PRODUCT_TAPE
PT=yes
+ [= yes -a yes = no]
+ [= yes -a 0 = 1]
+ return 0
+ + ../SPOT/usr/lpp/bosinst/bidata -b -g control_flow -f ENABLE_64BIT_KERNEL
ENABLE_64BIT=Default
+ + ../SPOT/usr/lpp/bosinst/bidata -b -g control_flow -f CREATE_JFS2_FS
CREATE_JFS2_FS=Default
+ bootinfo -y
+ 2> /dev/null
+ [64 = 64]
+ bootinfo -a
+ 2> /dev/null
+ [3 = 3]
+ [[Default = [Yy][Ee][Ss]]]
+ [[Default = [Dd][Ee][Ff][Aa][Uu][Ll][Tt]]]
+ [[yes = [Yy][Ee][Ss]]]
```

```

+ KERNEL64ENABLE=no
+ [[Default = [Yy][Ee][Ss]]]
+ [[Default = [Dd][Ee][Ff][Aa][Uu][Ll][Tt]]]
+ [yes = yes]
+ CREATEJFS2=no
+ Log Prepare_Target_Disks
+ typeset CURR_PVID=
+ typeset NEW_PVID=
+ typeset PAGELV=
+ typeset RLV=
+ typeset FS=
+ + Get_Primary_blv
+ typeset ERROR=eval return 1
+ typeset BLV=
+ typeset TYPE=
+ + ../SPOT/usr/lpp/bosinst/bidata -i -g lv_data -f LOGICAL_VOLUME -c LABEL -v
primary_bootlv
BLV=
+ [[-z]]
+ + awk {print $1}
+ ../SPOT/usr/lpp/bosinst/bidata -i -g lv_data -f LOGICAL_VOLUME -c TYPE -v
boot
BLV=hd5
+ print hd5
+ return 0
PRIMARY_BLV=hd5

```

---

7. After the migration has completed successfully and the system has rebooted, we disconnect from the HMC (use ~. to close the vtmenu session).

The **script** command output file (bosdebug.out) in /tmp on the NIM master contains all the debug output including the **showled** command; see Example 4-109.

*Example 4-109 Partial debug output including showled command*

---

```

{nimmast}:/ # more bosdebug.out
.....
+ ../SPOT/usr/lpp/bosinst/bidata -b -g control_flow -f INSTALL_METHOD
IM=migrate
+ [migrate = overwrite]
+ + expr 5 + 1
PERCENT=6
+ Change_Status 6
+ return 0
+ + expr 6 + 1
PERCENT=7
+ Change_Status 7
+ return 0

```

```

+ [-z]
+ /usr/lib/methods/showled 0xA54
+ Log Restore_System
+ [5 -eq 5]
+ grep loc_lpp_src
+ lsvg -l rootvg
+ 1> /dev/null 2>& 1
+ rc=1
+ [1 -eq 0]
+ dspmsg ../../usr/lib/nls/msg/C/BosMenus.cat -s 10 59 Restoring base operating
system.\n
.....
+ + ../../SPOT/usr/lpp/bosinst/bidata -b -g control_flow -f CUSTOMIZATION_FILE
CF=
+ [-z]
+ + ../../SPOT/usr/lpp/bosinst/bidata -i -g post_install_data -f BOSINST_FILE
CF=
+ cd /
+ [-f ../]
+ [-f]
+ return 0
+ /usr/lib/methods/showled 0xA46
+ Finish
+ Change_Status 100
+ alog -t bosinst -q -s 16384
+ cat ../var/adm/ras/bi.log /var/adm/ras/bi.log
cat: cannot open /var/adm/ras/bi.log
+ cp ../var/adm/ras/bi.log.* /var/adm/ras
+ 2> /dev/null
+ [-z]
+ [[-s ../var/adm/ras/BosMenus.log0]]
+ cp ../var/adm/ras/BosMenus.log /var/adm/ras
+ 2> /dev/null
+ mv /bosinst.data /var/adm/ras
+ 2> /dev/null
+ mv /image.data /var/adm/ras
+ 2> /dev/null
+ cp ../Ch_Stat.log /var/adm/ras
+ 2> /dev/null
+ [= true]
+ + pwd
CWD=/
+ cd /tmp
+ ar x /usr/lpp/bos/liblpp.a
+ echo

+ cat bos.rte.copyright
Licensed Materials - Property of IBM
.....

```

```

+ ar t /usr/lpp/bos/liblpp.a
+ rm -f bos.rte.copyright bos.rte.usr.rmlist bos.rte.root.rmlist
bos.rte.cfgfiles bos.rte.post_i bos.rte.pre_i incompat.pkgs
productid bos.rte.inventory bos.rte.al bos.rte.size bos.rte.tcb
+ cd /
+ rm -f /liblpp.a /lpp_name /SPOT ../Update_Status.pn
+ [-n]
+ rm -f /var/adm/ras/bi.log
+ 1> /dev/null
+ [5 -eq 5]
+ nimclient -R success
+ nimclient -S shutdown
+ [5 -eq 3]
+ [5 -eq 3]
+ [[5 -eq 3]]
+ [[5 -eq 3]]
+ mv /SPOT.save.7242 /SPOT
+ 1> /dev/null 2>& 1
+ [migrate = migrate -a 5.2 != 3.2]
+ [-z]
+ rm -rf /dev
+ 1> /dev/null 2>& 1
+ mkdir /dev
+ chown root.system /dev
+ chmod 775 /dev
+ cd /dev
+ restore -xqf /tmp/bos/dev.disk.bff
+ 1> /dev/null 2>& 1
+ [[-L /tmp/bos/dev.disk.bff]]
+ rm -f /tmp/bos/dev.disk.bff
+ [yes = no]
+ sync
+ sync
+ sync
+ umount -f /var
+ 2> /dev/null
+ umount -f /usr
+ 2> /dev/null
+ umount -f /
+ 2> /dev/null
+ reboot -q
Rebooting . .

```

---

## 4.5 NIM mksysb migration and nim\_move\_up POWER5 tools

Two new features for Network Installation Manager (NIM) and AIX migrations were introduced with AIX 5L V5.3. These new features are:

- ▶ mksysb migration
- ▶ `nim_move_up`

Both are designed to simplify and assist with the migration of older (possibly unsupported) levels of AIX running on older IBM RS/6000 or IBM eServer pSeries hardware. Both processes assist you with migrating these earlier systems to AIX 5L V5.3 on POWER5 hardware. In this section, we describe and demonstrate the features of both utilities.

### 4.5.1 mksysb migration

A mksysb migration can be extremely valuable when you want to move a system to a new POWER5 machine running AIX 5L V5.3. For example, you may have a lower level AIX 4.3 system running on a IBM System p 6H1 eServer that you want to move to a POWER5 LPAR on a IBM System p p595.

Given that AIX 4.3 is not supported on the POWER5 platform, in the days before “mksysb migrations”, the only course of action would have been to upgrade the AIX 4.3.3 system to AIX 5L V5.3 on the existing hardware (for example, the 6H1) and then clone the system via a mksysb to the new POWER5 LPAR. This process is now simplified with the mksysb migration.

A mksysb migration allows you to move a lower level AIX system (for example, AIX 4.3.3 or AIX 5L V5.1) to POWER5 without upgrading AIX on the existing server first. Essentially you boot AIX 5L V5.3 media (in our case, we use NIM) and recover the AIX 4.3.3 or AIX 5L V5.1 mksysb image, followed by an immediate migration to AIX 5L V5.3. This was not possible with previous versions of AIX and pSeries hardware. A mksysb migration is now the recommended way of moving unsupported hardware configurations of AIX 4.3 and AIX 5L V5.1 to new supported hardware and AIX 5L V5.3.

Of course this method is only intended for configurations that will not support a traditional migration method and bypasses the previous hardware limitation by restoring a mksysb on the new hardware and then performing the migration without needing to actually run AIX 4.3 on the new platform. Systems that can be migrated with a conventional migration should do so.

The end result is that the new system will be a clone of the existing system, but will be running AIX 5L V5.3 on a POWER5 platform. The existing system remains the same (for example, running AIX 4.3). You may choose to use this method to perform a test migration of a system and certify the applications, databases, or code against AIX 5L V5.3 on the clone before executing the real mksysb migration at some later stage.

### Requirements for a mksysb migration

A customized bosinst.data file is required to perform a mksysb migration installation. Your customized bosinst.data file must meet the following requirements to be used with a mksysb migration:

- ▶ The file must be provided using the supplementary diskette method or using the client file method (NIM).
- ▶ A new variable called MKSYSB\_MIGRATION\_DEVICE must exist within the file. This variable specifies the name of the device that contains the mksysb. For a network installation, the valid value is the word *network*. Valid values are /dev/cddevice number for a mksysb image on a CD-DVD, and /dev/rmtdevice number for a mksysb image on tape.
- ▶ The following variables in the CONTROL\_FLOW stanza must be set as follows:
  - PROMPT must be set to no.
  - INSTALL\_METHOD must be set to migrate.
  - EXISTING\_SYSTEM\_OVERWRITE must be set to yes.
  - RECOVER\_DEVICES must be set to no. A mksysb migration attempts to recover the sys0 attributed for the source system as specified in the mksysb ODM, but no other device-specific data is recovered from the source system.
  - Any user-supplied values for these variables is ignored.

The file should list the disks to be installed in the TARGET\_DISK\_DATA stanza to ensure that only those disks are used. A mksysb migration is a combination of an overwrite installation and a migration installation. The overwrite portion destroys all of the data on the target disks. The TARGET\_DISK\_DATA stanza must have enough information to clearly single out a disk. If you supply an empty TARGET\_DISK\_DATA stanza, the default disk for the platform is used, if available.

Example 4-110 on page 207 shows possible values for the TARGET\_DISK\_DATA stanza.



Sample 1. Disk names only (two disks)

```
target_disk_data:
PVID =
PHYSICAL_LOCATION =
CONNECTION =
LOCATION =
SIZE_MB =
HDISKNAME = hdisk0
```

```
target_disk_data:
PVID =
PHYSICAL_LOCATION =
CONNECTION =
LOCATION =
SIZE_MB =
HDISKNAME = hdisk1
```

Sample 2. Physical location specified (1 disk)

```
target_disk_data:
PVID =
PHYSICAL_LOCATION = U0.1-P2/Z1-A8
CONNECTION =
LOCATION =
SIZE_MB =
HDISKNAME =
```

Sample 3. By physical volume ID (PVID)(2 disks)

```
target_disk_data:
PVID = 0007245fc49bfe3e
PHYSICAL_LOCATION =
CONNECTION =
LOCATION =
SIZE_MB =
HDISKNAME =
target_disk_data:
PVID = 00000000a472476f
PHYSICAL_LOCATION =
CONNECTION =
LOCATION =
SIZE_MB =
HDISKNAME =
```

```
Sample 4. By SAN disk ID (ww_name//lun_id - 2 disks)
target_disk_data:
 SAN_DISKID = 0x500507630308427e//0x4021401a00000000

target_disk_data:
 SAN_DISKID = 0x500507630303427e//0x4010400000000000
```

---

Some basic prerequisites should be met before attempting a mksysb migration. All requisite hardware, including any external devices (such as tape, CD, or DVD-ROM drives), must be physically connected.

Before you begin the installation, other users who have access to your system must be logged off. Verify that your applications run on AIX 5L V5.3. Also, verify that your applications are binary-compatible with AIX 5L V5.3. If your system is an application server, verify that there are no licensing issues. Refer to your application documentation or provider to verify on which levels of AIX your applications are supported and licensed. You can also check the AIX application availability guide at the following Web address:

<http://www.ibm.com/servers/aix/products/ibmsw/list>

Verify that your hardware microcode is up-to-date. There must be adequate disk space and memory available. AIX 5L V5.3 requires 128 MB of memory and 2.2 GB of physical disk space. For additional release information, refer to *AIX 5L V5.3 Release Notes* at the following Web address:

[http://publib.boulder.ibm.com/infocenter/pseries/v5r3/topic/com.ibm.aix.resources/RELNOTES/5304\\_base\\_relnotes.pdf](http://publib.boulder.ibm.com/infocenter/pseries/v5r3/topic/com.ibm.aix.resources/RELNOTES/5304_base_relnotes.pdf)

Make a backup copy of your system software and data. If the source system is available, run the premigration script on it. Ignore any messages that pertain to the hardware configuration of the source system, because the migration takes place on the target system. Correct any other problems as recommended by the script.

## 4.5.2 Performing a mksysb migration with NIM

The following section describes how to perform a mksysb migration with NIM. We will migrate an AIX 5L V5.1 system currently running as an LPAR on a p670 (lpar4) to a new LPAR (vlp4) running on a p520 with AIX 5L V5.3 (see Figure 4-4 on page 209 and Figure 4-5 on page 210).

```

prtconf | head
System Model: IBM,7040-671
Machine Serial Number: 01A85D2
Processor Type: PowerPC_POWER4
Number Of Processors: 2
Processor Clock Speed: 1000 MHz
CPU Type: 64-bit
Kernel Type: 32-bit
LPAR Info: 4 lpar4
Memory Size: 1024 MB

oslevel -r
5100-04

lsdev -Cc disk
hdisk0 Available 57-08-00-8,0 16 Bit LVD SCSI Disk Drive
hdisk1 Available 5M-08-00-8,0 16 Bit LVD SCSI Disk Drive

lspv
hdisk0 001a85d27c3dc850 rootvg
hdisk1 001a071f9a12dbaf None
lscfg -l hdisk0
DEVICE LOCATION DESCRIPTION
hdisk0 57-08-00-8,0 16 Bit LVD SCSI Disk Drive (18200MB)

lsdev -Cc adapter
ent0 Available 4p-08 10/100 Mbps Ethernet PCI Adapter II (1410ff01)
scsi0 Available 57-08 Wide/Ultra-3 SCSI I/O Controller
scsi1 Available 5M-08 Wide/Ultra-3 SCSI I/O Controller
sa0 Available LPAR Virtual Serial Adapter

```

*Figure 4-4 Current hardware configuration for lpar4*

These steps assume that the new LPAR has already been configured on the p520 prior to attempting the migration and that all hardware has been set up, configured and verified (for example, CPU, memory, hard disks, Ethernet, SCSI and/or fibre channel adapters). The new LPAR on the p520 is a micro-partition using VIO resources as shown in Figure 4-5 on page 210.

```

prtconf | head
System Model: IBM,9131-52A
Machine Serial Number: 650E4DG
Processor Type: PowerPC_POWER5
Number Of Processors: 1
Processor Clock Speed: 1499 MHz
CPU Type: 64-bit
Kernel Type: 32-bit
LPAR Info: 6 v1par4
Memory Size: 512 MB

System configuration:
type=Shared
mode=Capped
smt=0n
lcpu=2
mem=512
psize=2
ent=0.10

lsdev -Cc disk
hdisk0 Available Virtual SCSI Disk Drive

lspv
hdisk0 0000c836a465153e rootvg active

lscfg -l hdisk0
hdisk0 U9131.52A.650E4DG-V6-C24-T1-L810000000000 Virtual SCSI Disk Drive

lspv hdisk0 | grep TOTAL
TOTAL PPs: 319 (10208 megabytes) VG DESCRIPTORS: 2

lsdev -Cc adapter
ent0 Available Virtual I/O Ethernet Adapter (1-lan)
vsa0 Available LPAR Virtual Serial Adapter
vscsi0 Available Virtual SCSI Client Adapter

```

*Figure 4-5 Hardware configuration for v1par4.*

#### 1. Preparing the system for a mksysb migration

Verify which hard disks will be used for the mksysb migration on the target system. In our test environment, we only had internal SCSI disks so we only needed to include hdisk0 and/or hdisk1 in our custom bosinst.data file. However, if you are working in a SAN disk environment it may be necessary to try and determine which disks (for example, ww\_name and lun\_id) will be used for rootvg in advance of the migration.

One way to do this is to NIM-install AIX 5L V5.3 onto the new system's rootvg disks and run the commands (shown in Example 4-111) to obtain the lun\_id and ww\_name for each rootvg disk. This information is used to complete the SAN\_DISKID tag in the custom bosinst.data.

*Example 4-111 Commands to obtain the lun\_id and ww\_name*

---

```
lsattr -EH -l hdisk6 | egrep 'lun_id|ww_name'
lun_id 0x4021401a00000000 Logical Unit Number ID True
ww_name 0x500507630308427e FC World Wide Name False

lsattr -EH -l hdisk7 | egrep 'lun_id|ww_name'
lun_id 0x4010400000000000 Logical Unit Number ID True
ww_name 0x500507630303427e FC World Wide Name False
```

---

Prepare the custom bosinst.data file for the mksysb migration. Edit the bosinst.data file and change the options in the bosinst.data file (as shown in Example 4-112). This file was located on our NIM master (/other\_res/bid.np.hd0.mkmig). We then checked the contents of our file by using the **bi check** command to ensure there were no obvious errors.

*Example 4-112 Changing the bosinst.data file*

---

```
{nimmast}:/ # vi /other_res/bid.np.hd0.mkmig

INSTALL_METHOD = migrate
PROMPT = no
EXISTING_SYSTEM_OVERWRITE = yes
RECOVER_DEVICES = no
MKSYSB_MIGRATION_DEVICE = network

target_disk_data:
PVID =
PHYSICAL_LOCATION =
CONNECTION =
LOCATION =
SIZE_MB =
HDISKNAME = hdisk0

{nimmast}:/ # /usr/lpp/bosinst/bicheck /other_res/bid.np.hd0.mkmig
{nimmast}:/ # echo $?
0
```

---

**Note:** If you are in a SAN disk environment for rootvg, the stanza would look similar to the following:

```
target_disk_data:
SAN_DISKID = 0x500507630308427e//0x4021401a00000000

target_disk_data:
SAN_DISKID = 0x500507630303427e//0x4010400000000000
```

2. Define the custom bosinst.data file.

Example 4-113 shows how we defined the custom bosinst.data file as a NIM resource.

*Example 4-113 Defining the bosinst.data file as a NIM resource*

---

```
{nimmast}:/ # smit nim_mkres
bosinst_data = config file used during base system installation
* Resource Name [BID_NP_HDO_MKMIG]
* Resource Type bosinst_data
* Server of Resource [master]
* Location of Resource [/other_res/bid.np.hd0.mkmig]
```

---

3. Define the source clients AIX 5L V5.1 mksysb as a NIM mksysb resource.

We already had an existing mksysb for the client, which we then defined as a mksysb resource for use with the mksysb migration, as shown in Example 4-114.

*Example 4-114 Defining the mksysb as a resource for NIM*

---

```
{nimmast}:/ # smit nim_mkres
mksysb = a mksysb image
* Resource Name [lpar4-mksysb-mig]
* Resource Type mksysb
* Server of Resource [master]
* Location of Resource [/export/images/lpar4-mksysb.5104]
```

---

4. Allocate the NIM mksysb resource to the client, VLPAR4.

In Example 4-115, we allocated the mksysb resource to the target NIM client called VLPAR4.

*Example 4-115 Allocating the NIM mksysb resource to the client*

---

```
{nimmast}:/ # smit nim
Perform NIM Administration Tasks
Manage Machines
Manage Network Install Resource Allocation
```

```
Allocate Network Install Resources
VLPAR4 machines standalone
lpar4-mksysb-mig mksysb
```

---

5. Prepare for the AIX migration on the target NIM client, VLPAR4.

We selected an `rte` install, the AIX 5L V5.3 `lppsource` and `SPOT` resources, our custom `bosinst_data` (`BID_NP_HDO_MKMIG`), and to accept the license agreements. We selected no to Initiate a reboot and installation now?, as shown in Example 4-116.

*Example 4-116 Preparing the client VLPAR4 for migration*

---

```
{nimmast}:/ # smit nim_bosinst
VLPAR4 machines standalone
rte - Install from installation images
LPP_53_ML4 resources lpp_source
SPOT_53_ML4 resources spot
```

Install the Base Operating System on Standalone Clients

```
* Installation Target VLPAR4
* Installation TYPE rte
* SPOT SPOT_53_ML4
LPP_SOURCE [LPP_53_ML4]
BOSINST_DATA to use during installation [BID_NP_HDO_MKMIG]
ACCEPT new license agreements? [yes]
Initiate reboot and installation now? [no]
```

---

6. We then checked that our target client was ready for the NIM `mksysb` migration process.

Example 4-117 shows the status of the NIM client, in particular the allocated `bosinst_data`, `lpp_source`, `spot` and `mksysb` resources.

*Example 4-117 Status of the NIM client*

---

```
{nimmast}:/ # lsnim -l VLPAR4
VLPAR4:
class = machines
type = standalone
platform = chrp
netboot_kernel = up
if1 = network1 LPAR4 0
cable_type1 = tp
Cstate = BOS installation has been enabled
prev_state = ready for a NIM operation
Mstate = not running
boot = boot
bosinst_data = BID_NP_HDO_MKMIG
lpp_source = LPP_53_ML4
```

```
mksysb = lpar4-mksysb-mig
nim_script = nim_script
spot = SPOT_53_ML4
cpuid = 00C69B9E4C00
control = master
```

---

7. Next, we initiated a standard (manual) network boot of the target LPAR.

The mksysb migration then proceeded as an unattended installation; that is, non-prompted. After the Installing Base Operating System screen appears, the installation continues. The progress is displayed and the percentage complete field and elapsed time is incremented to indicate the overall status of the installation.

The mksysb from the source client is restored first. After this is finished the actual migration to AIX 5L V5.3 is performed (this includes such tasks as merging configuration data, installing the base run-time environment and installing additional software).

Example 4-118 and Example 4-119 on page 215 show the output that we observed during the mksysb migration.

**Note:** Much of the output was removed to save space. Note that the BOS menus are disabled during the upgrade, thus the non-prompted migration. If an error occurs, the installation displays a message stating that the migration cannot continue, and 088 will be shown on the service display.

We monitored the mksysb migration status by watching the output on the console in one window (via vtmenu on the HMC; see Example 4-118) and observing the NIM installation information in another terminal, as shown in Example 4-119 on page 215 (using our custom `lsmniminst` script that we introduced in Example 4-87 on page 192).

*Example 4-118 Output of the mksysb migration*

---

```
{nimmast}:/ # ssh hscroot@hmc520
Last login: Tue May 30 15:56:55 2006 from 10.1.1.1
hscroot@hmc520:~> vtmenu
```

```
Retrieving name of managed system(s) . . . YLI894-2-650E4DG
```

```

Partitions On Managed System: YLI894-2-650E4DG
0S/400 Partitions not listed

```

```
1) VI01 Running
2) vlpar1 Running
3) vlpar2 Running
```



```

4) v1par3 Running
5) v1par5 Not Activated
6) LPAR4_1par Running
7) v1par4 Running
8) v1par6 Running

```

Enter Number of Running Partition (q to quit): 7

Opening Virtual Terminal On Partition v1par4 . . .

Open in progress..

```

Mksysb\Migration Enabled

```

```

Running: Init_Target_Disks...
Running: Other_Initialization...
Running: Fill_Target_Stanzas...
Running: Check_Other_Stanzas...

```

Installing Base Operating System

Please wait...

| Approximate<br>% tasks complete | Elapsed time<br>(in minutes) |
|---------------------------------|------------------------------|
| 0                               | 0                            |

---

*Example 4-119 Migration output*

---

```

{nimmast}:/ # lsniminst VLPAR4
info = extract_diskette_data
info = BOS install 2% complete : Running: MnM_Restore_NIM_Required_Files...
info = BOS install 3% complete : Making paging logical volumes.
info = BOS install 3% complete : Running: MnM_Create_Rootvg_LVS...
info = BOS install 6% complete : Making file systems.
info = BOS install 6% complete : Making file systems.
info = BOS install 6% complete : Running: MnM_Restore_NIM_Mksysb...
info = BOS install 6% complete : Running: MnM_Restore_NIM_Mksysb...
info = BOS install 6% complete : 4% of mksysb data restored.
info = BOS install 6% complete : 4% of mksysb data restored.
info = BOS install 6% complete : 4% of mksysb data restored.

```

```
info = BOS install 6% complete : 4% of mksysb data restored.
info = BOS install 6% complete : 7% of mksysb data restored.
info = BOS install 6% complete : 51% of mksysb data restored.
info = BOS install 6% complete : 51% of mksysb data restored.
info = BOS install 6% complete : 98% of mksysb data restored.
info = BOS install 6% complete : Unmounting file systems...
info = BOS install 8% complete : Preserving old data.
info = BOS install 9% complete : Copying old files
info = BOS install 12% complete : Restoring base operating system.
info = BOS install 18% complete : Over mounting /.
info = BOS install 21% complete : Merging.
info = installing additional software
info = BOS install 98% complete : Installing additional software.
info = BOS install 98% complete : Installing additional
info = BOS install 100% complete : Network Install Manager customization.
info = BOS install 100% complete : Creating boot image.
info = BOS install 100% complete : Creating boot image.
info = BOS install 100% complete
```

---

After the migration completes, the system will reboot. The target LPAR on the p520 will now be a clone of the AIX 5L V5.1 source system, but running AIX 5L V5.3. At this point, you can run the post-migration script to review the migration and perform any post-migration steps that are necessary.

As mentioned earlier, device specific configuration from the source system is not recovered from the mksysb restore (RECOVER\_DEVICES was set to no in our custom bosinst.data file). Therefore, you may need to perform some configuration tasks for devices such as network adapters or volume groups (although we encourage you to automate this via a NIM first boot customization script that runs after the system reboots post-installation).

After you are satisfied that the migration has been successful, you can begin taking any action required to test your applications with AIX 5L V5.3, such as copying data across to the new system for testing.

### 4.5.3 Migrating a NIM client to a POWER5 logical partition using `nim_move_up`

The `nim_move_up` tool allows you to easily migrate a back-level AIX system onto a logical partition (LPAR) residing on a POWER5 (or newer) server. It automates much of the manual processes associated with migrating lower level systems to a current level. It is designed to simplify and assist with the migration of older (possibly unsupported) levels of AIX running on older IBM RS/6000 and IBM @server pSeries hardware. In this section, we describe and demonstrate the features of this tool.

The basic flow of a `nim_move_up` operation is as follows:

- ▶ A system backup (`mksysb`) of the original machine's rootvg is taken.
- ▶ An LPAR is created with equivalent hardware resources on the POWER5 machine.
- ▶ The original `mksysb` backup is migrated to AIX 5.3.
- ▶ The migrated backup is installed onto the new LPAR on the POWER5 machine.

Before you can run the `nim_move_up` tool, however, the NIM master must meet the following prerequisites:

- ▶ A configured NIM master running AIX 5L V5.3 with 5300-03 or above.
- ▶ Perl 5.6 or above.
- ▶ OpenSSH (obtainable from the Linux Toolbox CD).
- ▶ At least one standalone NIM client running AIX 4.3.3.75 or above. It must be a registered NIM client and have a valid `/etc/niminfo` file.
- ▶ AIX product media version AIX 5L with 5200-04 or higher, or AIX 5L product media version 5.3 or higher, or equivalent `lpp_source` and SPOT NIM resources.

You must also have the following hardware resources in your environment:

- ▶ A POWER5 server with sufficient hardware resources to support the target clients' equivalent POWER5 configuration.
- ▶ If virtual resources will be used to migrate the clients, an installed and configured Virtual I/O Server is required.
- ▶ An HMC controlling the POWER5 server, along with sufficient privileges to start, stop, and create LPARs.

**Note:** You will also require root user authority to run the `nim_move_up` command.

This `nim_move_up` process requires no downtime on the part of the original client. In addition, `nim_move_up` is capable of migrating a client onto virtualized hardware, such as virtual disks, using the Virtual I/O capabilities of the POWER5 server.

This migration process can be completed by the `nim_move_up` application in phases to allow more control over the process, or it can be completed all at once without any user interaction required. It is possible to migrate either a single

system (a NIM client) or a group of systems (a NIM machine group) at the same time.

After a successful `nim_move_up` migration, the final configuration (in terms of the NIM master, source and target clients) will be similar to the following:

- ▶ The original NIM master.
- ▶ The original (source) NIM client unchanged.
- ▶ A new (target) LPAR(s) on the POWER5 server that corresponds to the original (source) NIM client(s) and are controlled by the NIM master.
- ▶ An HMC to control the LPARs on the POWER5 servers.

### **The different phases of `nim_move_up`**

The `nim_move_up` migration process is completed in ten phases. To allow some control over the process, each phase can be executed individually or all at once. This phased approach allows for more control (if required) over how and when the migration executes.

**Phase 1.** The *Setup NIM resources* phase creates the needed NIM resources to perform the migration steps if they do not already exist or are not provided beforehand.

**Phase 2.** The *Pre-migration Software Assessment* phase performs an assessment on each target client to determine what software is installed and can be migrated. Any software that is missing from the `lpp_source` will be added from the source of installation images that should be provided to `nim_move_up`.

**Phase 3.** The *Client Hardware and Utilization Data Gathering* phase gathers data about each target client's hardware resources and attempts to assess how much of those resources are utilized on average over a given amount of time.

**Phase 4.** The *p5 Resource Availability Data Gathering and Client Resource Data Translation* phase searches the given managed system for available hardware resources. It uses the data gathered in the previous phase to create an equivalent LPAR configuration that utilizes the managed system's available resources. It creates the client LPARs with virtual I/O resources instead of physical I/O resources if `nim_move_up` was provided a Virtual I/O Server LPAR to work with. It also creates the appropriate adapters and configuration on the Virtual I/O Server as they are needed.

**Phase 5.** The *Create System Backups* phase creates an installable image of each target client and its resources using the `mksysb` command.

**Phase 6.** The *Migrate Each System Backup* phase uses the `nimadm` command to migrate the newly-created installable images to the new level of AIX 5L.

**Phase 7.** The *Configure NIM Definitions of Client LPARs* phase uses the network information provided to the `nim_move_up` tool to create NIM standalone client objects for the new LPARs created in the *p5 Resource Availability Data Gathering and Client Resource Data Translation* phase. It allocates the appropriate NIM resources and runs a `bos_inst` pull operation (for example, NIM will not attempt to boot the client) on each NIM client.

**Phase 8.** The *Initiate LPAR Network Installations* phase reboots each LPAR via the service console (HMC) and initiates the installation.

**Note:** Phase 8. ends when the installation begins. The actual progress of the installation is not monitored.

**Phase 9.** The *Post-migration Software Assessment* phase assesses the overall success of the migration after each installation, and reports on any software migration issues. It may be necessary to manually correct the errors reported for filesets that fail to migrate.

**Phase 10.** The optional *Post-installation Customization* phase performs a NIM customization operation on each client with the values provided if an alternate `lpp_source`, fileset list, or customization script was provided to the `nim_move_up` application. This allows for the optional installation of additional software applications, or for any additional customization that may be needed.

### ***nim\_move\_up and the mig2p5 tools.***

The LPAR sizing and creation process is performed by a set of scripts known as the `mig2p5` tools. These tools have been developed to work with `nim_move_up` and also for standalone use. Refer to Appendix A, “General LPAR sizing and creation with `mig2p5` tools” on page 615 for more information.

**Note:** The tools described in the following list can be retrieved from the Additional materials accompanying this book.

The `nim_move_up` and `mig2p5` tools (available from Additional materials) work together in the following way (refer to Figure 4-6 on page 220):

1. Collect the source LPARs hardware configuration and CPU/memory utilization. This is performed by the `mig2p5` tools `getSrcCfg` and `getSrcUtil`.
2. Capture the target POWER5 system’s hardware configuration. The `mig2p5` tool `getTgtRsrc` performs this task.
3. Generate the target LPAR’s required configuration, based on the hardware requirements and CPU/memory utilization collected in step one. The `mig2p5` tool `genTgtCfg` executes this task.

4. Create the target LPAR on the POWER5 system via the `mig2p5` tool **createTgtLPAR**.
5. A mksysb of the source system is created by `nim_move_up`.
6. The mksysb is migrated to AIX 5L V5.3 and installed to the new POWER5 LPAR via `nim_move_up`.

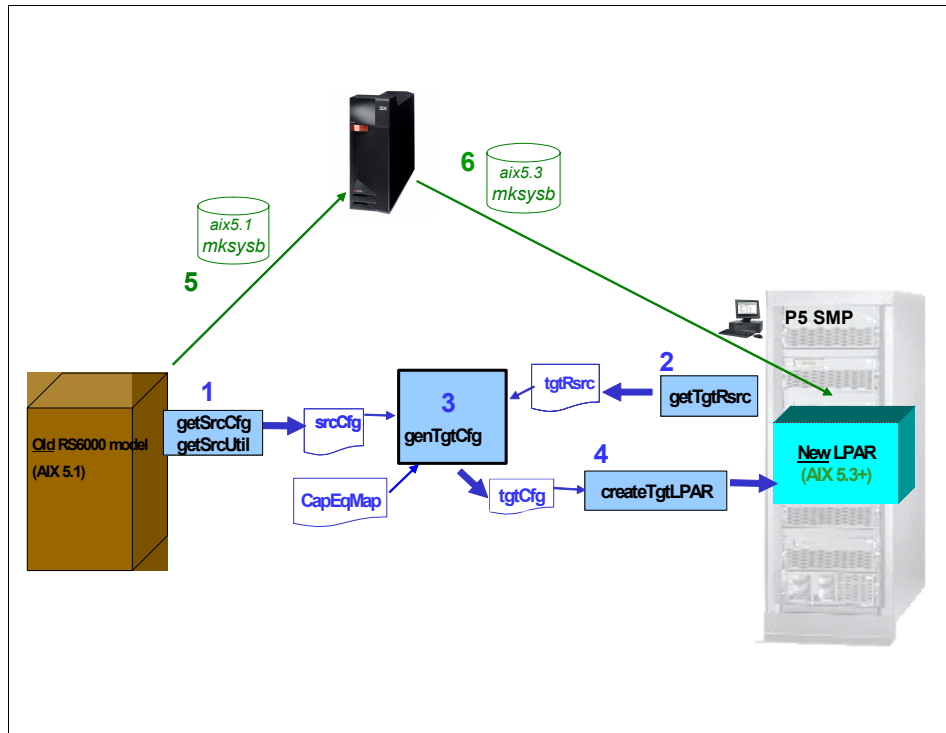

Figure 4-6 The `nim_move_up` and `mig2p5` tools operation

#### 4.5.4 Example `nim_move_up` operation

In the following section, we describe how we used the `nim_move_up` tool to migrate a NIM client to AIX 5L V5.3. Our test environment consisted of an AIX 5L V5.1 LPAR (lpar4) on a p670, which was then migrated to an AIX 5L V5.3 LPAR on a p520.

In our environment we used virtual I/O (VIO) resources for the new POWER5 LPAR. A working VIO server had already been configured on the IBM System p p520.

**Tip:** For more information about configuring a VIO server, visit the following Web site:

<http://publib.boulder.ibm.com/infocenter/eserver/v1r3s/topic/iphbl/iphblkickoff.htm>

In our example, we chose to execute each phase of the “move up” operation individually instead of executing them all at once. This decision was made so that we could discuss each phase in some detail.

The end result is somewhat similar to the mksysb migration. For example, the original client will be unchanged and the new LPAR will be a clone of the original, only now it is running AIX 5L V5.3 on a POWER5 server.

The big difference between the two methods is that `nim_move_up` automates the entire process, taking care of the creation of the client mksysb, creating the necessary NIM resources if they do not exist already, creating the LPAR definition (either with or without VIO resources), performing the AIX migration via `nimadm`, and finally initiating the mksysb installation to the new POWER5 LPAR.

Before commencing the `nim_move_up` operation, we performed several preliminary checks to confirm that our test environment met all the necessary requirements and was ready to support the migration.

1. We verified that the following software was installed at the correct levels on our NIM master.

Confirm the version of Perl is 5.6 or later:

```
{nimmast}:/ # lsllpp -l perl.rte
perl.rte 5.8.2.30 COMMITTED Perl Version 5 Runtime
```

Confirm that OpenSSH has been installed:

```
{nimmast}:/ # lsllpp -l openssh*
openssh.base.client 4.1.0.5301 COMMITTED Open Secure Shell Commands
openssh.base.server 4.1.0.5301 COMMITTED Open Secure Shell Server
openssh.license 4.1.0.5301 COMMITTED Open Secure Shell License
openssh.man.en_US 4.1.0.5301 COMMITTED Open Secure Shell
```

Check what version and maintenance/Technology Level of AIX is running on the NIM master. It must be at least AIX 5L V5.3 ML3:

```
{nimmast}:/ # oslevel -r
5300-04
```

2. Confirm that the source client is running AIX 4.3 .3.75 or later:

```
{nimmast}:/ # rsh lpar4 oslevel -r
5100-04
```

3. Review the available CPU, memory, network and storage adapter resources on the target POWER5 system.

Ensure that there will be enough spare capacity to meet the needs of the client. This can be done via your HMC and viewing the properties of the managed system. Click on each tab (Processor, Memory, and so on) and review the current available resources. If you intended to use VIO resources, ensure that there is already a VIO server configured and running. Logon to the VIO server and review the storage availability.

4. When satisfied that the environment meets all the requirements, we start the **nim\_move\_up** configuration process.

We display and configure the **nim\_move\_up** input values. We run the **nim\_move\_up** command with the **-S** flag to display the current status of the operation, as shown in Example 4-120.

*Example 4-120 nim\_move\_up -S command*

---

```
{nimmast}:/ # nim_move_up -S
```

```
nim_move_up Status:
```

```
=====
```

```
Tue Jun 6 10:24:24 2006
```

```
Next phase to execute: 1 - Setup NIM Resources
```

---

We enter the **nim\_move\_up** configuration information (see Example 4-121 on page 224) based on the following information:

- ▶ Our existing NIM client is named LPAR4. If you want to migrate more than one client at a time, you need to specify a NIM machine group. For example, NIM\_MAC\_GRP\_1.
- ▶ The new POWER5 LPAR address will be 10.1.1.65. If you have specified to migrate a NIM machine group, you must supply a sufficient range of IP addresses to cover the number of clients you intend to migrate, for example, 10.1.1.65-10.1.1.75. The `/etc/hosts` file should be updated with this information also.

**Note:** Before starting a **nim\_move\_up** operation, you need to allocate a new IP address for each target client involved in the operation.

- ▶ Our POWER5 HMC hostname is `hmcp520`.
- ▶ Our managed system name is `YLI894-2-650E4DG`.
- ▶ The source install images are located in `/moveup/AIX5304`. We recommend that you set the source to something like a product DVD with all the required



software. In this way, if your lpp\_source is missing any filesets that the client will attempt to migrate, it can be added to the lpp\_source in phase 2. In our test environment, /moveup/AIX5304 contained a copy of the AIX 5L V5.3 install CDs.

- ▶ The location of the new NIM resources will be located in the file system /moveup. This is a file system that we created which will be used to contain any new NIM resources that **nim\_move\_up** must create. Our file system was 6G in size, but the size will depend on the number of and size of the client mksysb images and whether or not any new lppsource or SPOT resources need to be created.
- ▶ The Virtual I/O Server LPAR name will be VIO1, because we will be using VIO resources for the new POWER5 LPAR.

**Important:** Ensure that your VIO server hostname and LPAR name match in terms of upper case and lower case. During our tests we encountered the following error:

```
Tue Jun 6 11:24:55 2006 OUTPUT
(/usr/lpp/bos.sysmgmt/nim/methods/getTgtRsrc): ssh hscroot@hmcp520
viosvr cmd -m YLI894-2-650E4DG -p vio1 -c "\"lsvg\"|
Tue Jun 6 11:24:56 2006 OUTPUT
(/usr/lpp/bos.sysmgmt/nim/methods/getTgtRsrc): Invalid volume group
HSCL8012 The partition named vio1 was not found. Please check your
entry and retry the command.
```

Upon further investigation we found that the LPAR name for the VIO server was in upper case (for example, VIO1). However, in the **nim\_move\_up** configuration, the name had been entered in lower case. After the correct case was used, the command completed successfully:

```
hscroot@hmcp520:~> viosvr cmd -m YLI894-2-650E4DG -p VIO1 -c
 "\"lsvg\"|
rootvg
rootvg_clients
```

- ▶ The LPP\_SOURCE name will be LPP\_53\_ML4 and the SPOT name will be SPOT\_53\_ML4.
- ▶ We have not specified the bosinst\_data resource, exclude\_files resource or the Temporary Volume Group for NIMADM information. This is acceptable because **nim\_move\_up** will create the resources as required, and it will use the rootvg as the temporary volume group for the **nimadm** cache file systems.

**Important:** Ensure that you have enough space in rootvg on the NIM master for the extraction of the client mksysb plus at least 500 MB of free space for the migration tasks. For optimum performance, it is recommended that you use a different volume group that is separate from the volume group that contains the other NIM resources.

To reduce the size of the mksysb image, you can exclude files from the mksysb via an EXCLUDE\_FILES resource which can be specified in the `nim_move_up` configuration.

*Example 4-121 smit nim\_move\_up configuration parameters*

---

```
{nimmast}:/ # smit nim_move_up

Configure nim_move_up Input Values

* Existing NIM Client or Machine Group [LPAR4]
* New LPAR IP Address [10.1.1.65]
* New LPAR Subnet Mask [255.255.255.0]
* New LPAR Default Gateway [10.1.1.1]
* Hostname of HMC [hmcp520]
* Managed System Name [YLI894-2-650E4DG]
* Source of Install Images [/moveup/AIX5304]
* Location of New NIM Resources [/moveup]
Virtual I/O Server LPAR Name [VI01]
Force the Use of Physical Network Adapter? [no]
Force the Use of Physical Storage Controller? [no]
Accept All New License Agreements? [yes]

LPP_SOURCE Name [LPP_53_ML4]
SPOT Name [SPOT_53_ML4]
BOSINST_DATA []
EXCLUDE_FILES resource []
Customization SCRIPT resource []
INSTALLP BUNDLE containing packages to add []
FIX_BUNDLE to install []
Temporary Volume Group for NIMADM []
Number of Loops to Run on Client []#
Seconds for Each Loop []#
```

---

In Example 4-122 we check the current status of the `nim_move_up` operation, which also shows us the configuration information we just entered.

*Example 4-122 Status of the nim\_move\_up operation*

---

```
{nimmast}:/ # nim_move_up -S
```

```
nim_move_up Status:
=====
Tue Jun 6 10:41:12 2006
```

Next phase to execute: 1 - Setup NIM Resources

```
Saved parameters:
 accept_licenses = yes
 images = /moveup/AIX5304
 hmc = hmcp520
 location = /moveup
 gateway = 10.1.1.1
 managed_sys = YLI894-2-650E4DG
 subnet_mask = 255.255.255.0
 spot = SPOT_53_ML4
 lpp_source = LPP_53_ML4
 vioserver = VI01
 target_client = LPAR4
 min_ip = 10.1.1.65
```

---

We are now ready to execute phase 1 of the **nim\_move\_up** process.

Before moving onto the first phase, it is worth mentioning a few details regarding the **nim\_move\_up** configuration database and log files. All **nim\_move\_up** operations are logged to the directory `/var/mig2p5`.

This directory serves several purposes, as shown in Table 4-1 on page 226. It records state information so that the **nim\_move\_up** operation can remember what phases have been executed. The directory is created by the **nim\_move\_up** command and its contents are removed after **nim\_move\_up** is unconfigured. It also contains several log files which can be very helpful in troubleshooting.

With the exception of the log files and the contents of the `client_data` directory, the files in `/var/mig2p5` can be read and modified so that **nim\_move\_up** can perform tasks that it would not do through its command line and SMIT interfaces.

Users are encouraged to manipulate the `mig2p5` environment to meet any specific needs and to aid in the troubleshooting of any problems that might arise during the **nim\_move\_up** process.

However, modifying the `mig2p5` environment is an advanced task and users must ensure they fully understand the changes being performed and their effect on the **nim\_move\_up** tool.

Table 4-1 Description and purpose of the files/directories in /var/mig2p5

| File/Directory                  | Purpose                                                                                                                                                                                                                                                                                                                                                                                                                                                                                                                                                                                                                                             |
|---------------------------------|-----------------------------------------------------------------------------------------------------------------------------------------------------------------------------------------------------------------------------------------------------------------------------------------------------------------------------------------------------------------------------------------------------------------------------------------------------------------------------------------------------------------------------------------------------------------------------------------------------------------------------------------------------|
| config_db - file                | Contains all of the saved configuration options passed to nim_move_up.                                                                                                                                                                                                                                                                                                                                                                                                                                                                                                                                                                              |
| current_phase - file            | Contains the number of the phase that will execute next.                                                                                                                                                                                                                                                                                                                                                                                                                                                                                                                                                                                            |
| global_log - file               | Contains the output of all the phases that have been run since the last time the mig2p5 directory was initialized. This log is very helpful in troubleshooting a <b>nim_move_up</b> failure.                                                                                                                                                                                                                                                                                                                                                                                                                                                        |
| client_data/ - directory        | <p>Contains files that are generated by nim_move_up during phases 3 and 4, in which each of the original clients' system resources and utilization are monitored and quantified into configuration files. The available resources in the POWER5 server are also quantified into corresponding text files. All the data in these files will be taken into account when determining the hardware profile of the newly derived LPARs on the POWER5-based server.</p> <p><b>Note:</b> These files are intended to be machine-readable data files for the nim_move_up command's internal use. Do <i>not</i> manually modify or create them yourself.</p> |
| phase#/ - directory<br>phase1-9 | Contain data specific to the corresponding phase denoted by the number in its name (for example, phase4/). Every phase has a directory (for example, phase1, phase2, and so on).                                                                                                                                                                                                                                                                                                                                                                                                                                                                    |
| phase#/log - file               | A log file that contains all the output displayed during a phase's execution. If a phase is executed multiple times (such as after an error has been corrected), all new output is appended to the log file. This log file is helpful in investigating failures related to this phase after they have occurred.                                                                                                                                                                                                                                                                                                                                     |
| phase#/status - file            | <p>Indicates whether a phase has been successful or not. This file is used by <b>nim_move_up</b> to determine whether a subsequent phase can be run.</p> <p>A phase can only run if all previous phases' status files contain the string: success.</p> <p>If a phase encounters an error that causes it to fail, the status file will contain the string: failure.</p>                                                                                                                                                                                                                                                                              |

| File/Directory | Purpose                                                                                                                                                                                                                                                                                                                    |
|----------------|----------------------------------------------------------------------------------------------------------------------------------------------------------------------------------------------------------------------------------------------------------------------------------------------------------------------------|
| pid - file     | Contains the <b>nim_move_up</b> process ID number when <b>nim_move_up</b> is running in the background. This file is cleaned up when the process finishes.<br>As long as this file exists and contains a process ID, <b>nim_move_up</b> cannot run phases because concurrent runs of <b>nim_move_up</b> are not supported. |

Example 4-123 shows the directory listing of /var/mig2p5 from our test system.

*Example 4-123 Migration directory sample*

---

```
{nimmast}:/var/mig2p5 $ ls -ltr
total 8
drwxr-xr-x 2 root system 256 Jun 06 16:17 phase9
drwxr-xr-x 2 root system 256 Jun 06 16:17 phase8
drwxr-xr-x 2 root system 256 Jun 06 16:17 phase7
drwxr-xr-x 2 root system 256 Jun 06 16:17 phase6
drwxr-xr-x 2 root system 256 Jun 06 16:17 phase5
drwxr-xr-x 2 root system 256 Jun 06 16:17 phase4
drwxr-xr-x 2 root system 256 Jun 06 16:17 phase3
drwxr-xr-x 2 root system 256 Jun 06 16:17 phase2
drwxr-xr-x 2 root system 256 Jun 06 16:17 phase10
drwxr-xr-x 2 root system 256 Jun 06 16:17 phase1
-rw-r--r-- 1 root system 2 Jun 06 16:17 current_phase
drwxr-xr-x 2 root system 256 Jun 06 16:17 client_data
-rw-r--r-- 1 root system 236 Jun 06 16:20 config_db
```

---

At this stage, the config\_db file contains our configuration information; see Example 4-124.

*Example 4-124 Sample config\_db file*

---

```
{nimmast}:/var/mig2p5 # cat config_db
min_ip:10.1.1.65
subnet_mask:255.255.255.0
gateway:10.1.1.1
hmc:hmcp520
vioserver:VI01
managed_sys:YLI894-2-650E4DG
target_client:LPAR4
location:/moveup
images:/moveup/AIX5304
accept_licenses:yes
lpp_source:LPP_53_ML4
spot:SPOT_53_ML4
```

---

5. Configure the SSH keys on the target HMC.

SSH keys needed to be configured on our HMC to allow for unattended remote execution of the commands from the NIM master. We executed the commands shown in Example 4-125 to configure the SSH keys for the root user on the NIM master and append the public key to the `authorized_keys2` file for the `hscroot` user on the HMC. This allows the root user on the NIM master to run commands remotely on the HMC without entering a password. After configuring our SSH keys, we checked that we could run a command on the HMC without being prompted for a password.

*Example 4-125 Configuring the SSH keys*

---

```
{nimmast}:/ # nim_move_up -K
Connecting to host hmcp520...
hscroot@hmcp520's password:
id_rsa.pub
100% 222 0.2KB/s 00:00
{nimmast}:/ # ssh hscroot@hmcp520 date
Tue May 30 15:56:59 CEST 2006
```

---

6. Execute **Phase 1** - Set up NIM resources.

In Example 4-126, we executed the `nim_move_up` command with the `-n` flag, which instructs `nim_move_up` to execute the next phase in the operation.

*Example 4-126 Executing the nim\_move\_up -n command*

---

```
{nimmast}:/ # nim_move_up -n
Tue Jun 6 10:43:40 2006 Starting Phase 1 : Setup NIM Resources...
Tue Jun 6 10:43:40 2006 Creating bosinst_data resource.
Tue Jun 6 10:43:40 2006 Executing: /usr/sbin/nim -o define -t bosinst_data -a
server=master -a location=/moveup/bosinst.data nim_move_up_bid
Tue Jun 6 10:43:41 2006 rc for /usr/sbin/nim = 0
Tue Jun 6 10:43:41 2006 Creating exclude_files resource.
Tue Jun 6 10:43:41 2006 Executing: /usr/sbin/nim -o define -t exclude_files -a
server=master -a location=/moveup/exclude_files nim_move_up_exclude
Tue Jun 6 10:43:41 2006 rc for /usr/sbin/nim = 0
Tue Jun 6 10:43:41 2006 STATUS for phase 1: success
```

---

The `bosinst_data` and `exclude_files` NIM resources were created in this phase. Example 4-127 shows details of both NIM resources, the contents of the files used to create the NIM resources, and the directory structure. These resources are *not* removed after a `nim_move_up` operation.

*Example 4-127 Details of the NIM resources*

---

```
{nimmast}:/ # lsrim -l nim_move_up_bid nim_move_up_exclude
nim_move_up_bid:
class = resources
```

```

type = bosinst_data
Rstate = ready for use
prev_state = unavailable for use
location = /moveup/bosinst.data
alloc_count = 0
server = master
nim_move_up_exclude:
class = resources
type = exclude_files
Rstate = ready for use
prev_state = unavailable for use
location = /moveup/exclude_files
alloc_count = 0
server = master

{nimmast}:/ # cd /moveup
{nimmast}:/moveup # ls -ltr
total 8
drwxr-xr-x 2 root system 256 Jun 06 10:33 lost+found
-rw-r--r-- 1 root system 914 Jun 06 10:43 bosinst.data
-rw-r--r-- 1 root system 0 Jun 06 10:43 exclude_files

{nimmast}:/moveup # cat bosinst.data
CONSOLE = Default
INSTALL_METHOD = overwrite
PROMPT = no
EXISTING_SYSTEM_OVERWRITE = yes
INSTALL_X_IF_ADAPTER = yes
RUN_STARTUP = no
RM_INST_ROOTS = no
ERROR_EXIT =
CUSTOMIZATION_FILE =
TCB = no
INSTALL_TYPE =
BUNDLES =
RECOVER_DEVICES = Default
BOSINST_DEBUG = no
ACCEPT_LICENSES = yes
DESKTOP = CDE
INSTALL_DEVICES_AND_UPDATES = yes
IMPORT_USER_VGS =
ENABLE_64BIT_KERNEL = Default
CREATE_JFS2_FS = Default
ALL_DEVICES_KERNELS = yes
GRAPHICS_BUNDLE = yes
MOZILLA_BUNDLE = no
KERBEROS_5_BUNDLE = no
SERVER_BUNDLE = no
REMOVE_JAVA_118 = no

```

```
HARDWARE_DUMP = yes
ADD_CDE = no
ADD_GNOME = no
ADD_KDE = no
ERASE_ITERATIONS = 0
ERASE_PATTERNS =

target_disk_data:
LOCATION =
SIZE_MB =
HDISKNAME =

locale:
BOSINST_LANG =
CULTURAL_CONVENTION =
MESSAGES =
KEYBOARD =
```

---

**Phase 2** will run next. We check the status before we execute the next step and we are informed that some pre-migration tasks will be performed, as shown in Example 4-128.

*Example 4-128 Pre-migration tasks*

---

```
{nimmast}:/ # nim_move_up -S
nim_move_up Status:
=====
Tue Jun 6 10:44:29 2006
```

Next phase to execute: 2 - Pre-Migration

```
Saved parameters:
accept_licenses = yes
images = /moveup/AIX5304
hmc = hmcp520
location = /moveup
gateway = 10.1.1.1
managed_sys = YLI894-2-650E4DG
subnet_mask = 255.255.255.0
spot = SPOT_53_ML4
lpp_source = LPP_53_ML4
vioserver = VI01
target_client = LPAR4
min_ip = 10.1.1.65
```

---

7. Run **Phase 2** - Pre-migration.

The `pre_migration` script is run on the source client. Commands such as **lppchk** are run to assess what software is installed and which software cannot



be migrated. The `pre_migration` script saves its output to `/home` and should be reviewed prior to migrating. Any software that is missing from the `lpp_source` is then copied from the source installation images (in our case, `/moveup/AIX5304`) to the `lpp_source` directory (in our case, `/AIX53ML4/LPP_53_ML4`); see Example 4-129.

*Example 4-129 Pre-migration checks*

---

```
{nimmast}:/ # nim_move_up -n
Tue Jun 6 10:44:53 2006 Starting Phase 2 : Pre-Migration...
Tue Jun 6 10:44:53 2006 Running command /usr/lpp/bos.sysmgmt/nim/methods/c_rsh
lpar4 /usr/lpp/bos/pre_migration
Tue Jun 6 10:44:53 2006 OUTPUT:
All saved information can be found in: /home/pre_migration.060606104453
```

Checking size of boot logical volume (hd5).

Listing software that will be removed from the system.

Listing configuration files that will not be merged.

Listing configuration files that will be merged.

Saving configuration files that will be merged.

Running `lppchk` commands. This may take awhile.

Please check `/home/pre_migration.060606104834/software_consistency` for possible errors.

Please check `/home/pre_migration.060606104834/tcbck.output` for possible errors.

All saved information can be found in: `/home/pre_migration.060606104834`

It is recommended that you create a bootable system backup of your system before migrating.

```
Tue Jun 6 10:48:34 2006 Obtaining list of installed software on client LPAR4
Tue Jun 6 10:48:34 2006 Attempting to update lpp_source LPP_53_ML4 with
software installed on clients.
Tue Jun 6 10:48:34 2006 Executing: /usr/sbin/gencopy -bqv -X -d /moveup/AIX5304
-t /AIX53ML4/LPP_53_ML4 -f /tmp/gcpyargs.553090
/AIX53ML4/LPP_53_ML4/installp/ppc/printers.rte.5.3.0.30.I
/AIX53ML4/LPP_53_ML4/installp/ppc/bos.diag.util.5.3.0.10.U
/AIX53ML4/LPP_53_ML4/installp/ppc/bos.diag.rte.5.3.0.10.U
/AIX53ML4/LPP_53_ML4/installp/ppc/bos.diag.com.5.3.0.10.U
/AIX53ML4/LPP_53_ML4/installp/ppc/bos.diag.util.5.3.0.10.U
/AIX53ML4/LPP_53_ML4/installp/ppc/bos.diag.rte.5.3.0.10.U
/AIX53ML4/LPP_53_ML4/installp/ppc/bos.diag.com.5.3.0.10.U
```

```
/AIX53ML4/LPP_53_ML4/installp/ppc/bos.diag.util.5.3.0.40.U
/AIX53ML4/LPP_53_ML4/installp/ppc/bos.diag.rte.5.3.0.40.U
/AIX53ML4/LPP_53_ML4/installp/ppc/bos.diag.com.5.3.0.40.U
/AIX53ML4/LPP_53_ML4/installp/ppc/bos.diag.5.3.0.30.I
/AIX53ML4/LPP_53_ML4/installp/ppc/X11.apps.config.5.3.0.40.U
/AIX53ML4/LPP_53_ML4/installp/ppc/X11.apps.5.3.0.30.I
Tue Jun 6 10:54:52 2006 STATUS for phase 2: success
```

---

Example 4-130 shows the collection information on the client's hardware and system usage.

*Example 4-130 Client's hardware and system usage information collection*

---

```
{nimmast}:/ # nim_move_up -S
nim_move_up Status:
=====
Tue Jun 6 10:45:13 2006
```

Next phase to execute: 3 - Client Hardware and Utilization Data Gathering

```
Saved parameters:
 accept_licenses = yes
 images = /moveup/AIX5304
 hmc = hmcp520
 location = /moveup
 gateway = 10.1.1.1
 managed_sys = YLI894-2-650E4DG
 subnet_mask = 255.255.255.0
 spot = SPOT_53_ML4
 lpp_source = LPP_53_ML4
 vioserver = VI01
 target_client = LPAR4
 min_ip = 10.1.1.65
```

---

**8. Phase 3 - Client hardware and utilization and data gathering.**

This phase collects information about each client's current hardware resources and also attempts to assess the average use of those resources (in terms of CPU and memory) over a given amount of time.

To collect usage statistics, the **vmstat** command is run on the client for a period of time based on the values we entered for "Number of Loops to Run on Client" and "Seconds for Each Loop" during the configuration stage. Changing these values will allow you to gather more data over a greater space of time, which may provide a better picture of the overall utilization of the system and can result in a better final configuration for the target LPAR on the POWER5 system.

In Example 4-131, the number of loops and seconds for each loop in the initial **nim\_move\_up** configuration were changed to 30 loops and 3 seconds. This means that the **vmstat** command will run on the client 30 times every 3 seconds.

*Example 4-131 Number of loops parameter change*

---

|                                  |       |
|----------------------------------|-------|
| Number of Loops to Run on Client | [30]# |
| Seconds for Each Loop            | [3]#  |

---

Example 4-132 shows the output the from phase 3.

*Example 4-132 Output of phase 3*

---

```
{nimmast}:/ # nim_move_up -n
Tue Jun 6 10:45:33 2006 Starting Phase 3 : Client Hardware and Utilization
Data Gathering...
Tue Jun 6 10:45:33 2006 Running getSrcUtil on client LPAR4
Tue Jun 6 10:45:33 2006 Executing: /usr/lpp/bos.sysmgt/nim/methods/getSrcUtil
-s lpar4 -o /var/mig2p5/client_data/srcUtil_LPAR4
Tue Jun 6 10:45:42 2006 OUTPUT (/usr/lpp/bos.sysmgt/nim/methods/getSrcUtil):
Tue Jun 6 10:45:42 2006 OUTPUT (/usr/lpp/bos.sysmgt/nim/methods/getSrcUtil):
The number of vmstat loops :10
Tue Jun 6 10:45:42 2006 OUTPUT (/usr/lpp/bos.sysmgt/nim/methods/getSrcUtil):
The Average of Active virtual pages: 127 MB
Tue Jun 6 10:45:42 2006 OUTPUT (/usr/lpp/bos.sysmgt/nim/methods/getSrcUtil):
The Average of Size of the free list: 582 MB
Tue Jun 6 10:45:42 2006 OUTPUT (/usr/lpp/bos.sysmgt/nim/methods/getSrcUtil):
The sum of the CPU %idle: 990
Tue Jun 6 10:45:42 2006 OUTPUT (/usr/lpp/bos.sysmgt/nim/methods/getSrcUtil):
The Average of CPU idle: 99.00
Tue Jun 6 10:45:42 2006 OUTPUT (/usr/lpp/bos.sysmgt/nim/methods/getSrcUtil):
The Average of CPU utilization: 1.00
Tue Jun 6 10:45:42 2006 rc for /usr/lpp/bos.sysmgt/nim/methods/getSrcUtil = 0
Tue Jun 6 10:45:42 2006 Running getSrcCfg on client LPAR4
Tue Jun 6 10:45:42 2006 Executing: /usr/lpp/bos.sysmgt/nim/methods/getSrcCfg
-s lpar4 -o /var/mig2p5/client_data/srcCfg_LPAR4 -util
/var/mig2p5/client_data/srcUtil_LPAR4
Tue Jun 6 10:45:42 2006 OUTPUT (/usr/lpp/bos.sysmgt/nim/methods/getSrcCfg):
INPUT:
Tue Jun 6 10:45:42 2006 OUTPUT (/usr/lpp/bos.sysmgt/nim/methods/getSrcCfg):
Source Hostname = lpar4
Tue Jun 6 10:45:42 2006 OUTPUT (/usr/lpp/bos.sysmgt/nim/methods/getSrcCfg):
File name for source configuration= /var/mig2p5/client_data/srcCfg_LPAR4
Tue Jun 6 10:45:42 2006 OUTPUT (/usr/lpp/bos.sysmgt/nim/methods/getSrcCfg):
File containing utilization data = /var/mig2p5/client_data/srcUtil_LPAR4
Tue Jun 6 10:45:42 2006 OUTPUT (/usr/lpp/bos.sysmgt/nim/methods/getSrcCfg):

```

```

Tue Jun 6 10:45:42 2006 OUTPUT (/usr/lpp/bos.sysmgmt/nim/methods/getSrcCfg):
Getting the type & model of the given source machine.....
Tue Jun 6 10:45:42 2006 OUTPUT (/usr/lpp/bos.sysmgmt/nim/methods/getSrcCfg):

Tue Jun 6 10:45:42 2006 OUTPUT (/usr/lpp/bos.sysmgmt/nim/methods/getSrcCfg):
Getting the info about CPUs and Memory in the source machine.....
Tue Jun 6 10:45:44 2006 OUTPUT (/usr/lpp/bos.sysmgmt/nim/methods/getSrcCfg):

Tue Jun 6 10:45:44 2006 OUTPUT (/usr/lpp/bos.sysmgmt/nim/methods/getSrcCfg):
Adding utilization info from the /var/mig2p5/client_data/srcUtil_LPAR4
File.....
Tue Jun 6 10:45:44 2006 OUTPUT (/usr/lpp/bos.sysmgmt/nim/methods/getSrcCfg):

Tue Jun 6 10:45:44 2006 OUTPUT (/usr/lpp/bos.sysmgmt/nim/methods/getSrcCfg):
Getting the info about volume groups in the source machine.....
Tue Jun 6 10:45:45 2006 OUTPUT (/usr/lpp/bos.sysmgmt/nim/methods/getSrcCfg):

Tue Jun 6 10:45:45 2006 OUTPUT (/usr/lpp/bos.sysmgmt/nim/methods/getSrcCfg):
Getting the info about network adapters in the source machine....
Tue Jun 6 10:45:45 2006 rc for /usr/lpp/bos.sysmgmt/nim/methods/getSrcCfg = 0
Tue Jun 6 10:45:45 2006 STATUS for phase 3: success

```

---

The scripts in Example 4-133 are used to collect hardware information and system usage data on the source client system.

*Example 4-133 Scripts used to collect hardware and system usage information*

```

/usr/lpp/bos.sysmgmt/nim/methods/getSrcCfg
/usr/lpp/bos.sysmgmt/nim/methods/getSrcUtil

```

---

Upon successful completion of this phase, we found the following files had been created in the /var/mig2p5/client\_data directory, as shown in Example 4-134.

*Example 4-134 New files created in the /var/mig2p5/client\_data*

```

{nimmast}:/var/mig2p5/client_data # ls -l
total 16
-rw-r--r-- 1 root system 62 Jun 06 10:45 srcUtil_LPAR4
-rw-r--r-- 1 root system 253 Jun 06 10:45 srcCfg_LPAR4

{nimmast}:/var/mig2p5/client_data # cat srcUtil_LPAR4
CPU UTILIZATION in % = 1
MEMORY UTILIZATION in MBs = 442

{nimmast}:/var/mig2p5/client_data # cat srcCfg_LPAR4
MACHINE = 7040-671
CPUS = PowerPC_POWER4, 1000 MHz, 2
MEMORY = 1024 MB

```

```
CPU UTILIZATION in % = 1
MEMORY UTILIZATION in MBs = 442
VG = <vg name>,<size in MB>
VG = rootvg,17344
NETWORK = <description>
NETWORK = 10/100 Mbps Ethernet PCI Adapter II
```

---

The files in Example 4-134 on page 234 contain the CPU and memory utilization statistics for the LPAR, and the current hardware configuration of the system. The **nim\_move\_up** operation will use these files to determine what the system configuration will need to look like on the new POWER5 LPAR.

Now, we move into the POWER5 resource availability and LPAR creation stage, as shown in Example 4-135.

*Example 4-135 LPAR creation stage*

---

```
{nimast}:/ # nim_move_up -S
nim_move_up Status:
=====
Tue Jun 6 10:46:08 2006
```

Next phase to execute: 4 - p5 Resource Availability Data Gathering and LPAR Creation

```
Saved parameters:
 accept_licenses = yes
 images = /moveup/AIX5304
 hmc = hmcp520
 location = /moveup
 gateway = 10.1.1.1
 managed_sys = YLI894-2-650E4DG
 subnet_mask = 255.255.255.0
 spot = SPOT_53_ML4
 lpp_source = LPP_53_ML4
 vioserver = VI01
 target_client = LPAR4
 min_ip = 10.1.1.65
```

---

## 9. Phase 4 - POWER5 resource availability data gathering and LPAR creation.

In this phase, **nim\_move\_up** will examine the POWER5 system for available hardware resources. The data gathered in the previous phase is used to derive an equivalent LPAR configuration on the POWER5 system. We specified a VIO server so our target LPAR will be configured using VIO resources instead of physical I/O resources. The creation of the necessary VIO adapters, storage devices and other configuration on the VIO server is managed by the **nim\_move\_up** operation.

We execute this phase and note that there is significant amount of output, as shown in Example 4-136. This output is very useful for helping us to understand what is accomplished in this phase.

*Example 4-136 Output of phase 4*

---

```
{nimmast}:/ # nim_move_up -n
Tue Jun 6 11:30:54 2006 Starting Phase 4 : p5 Resource Availability Data
Gathering and LPAR Creation...
Tue Jun 6 11:30:54 2006 Obtaining available resources on p5 server
YLI894-2-650E4DG
Tue Jun 6 11:30:54 2006 Executing: /usr/lpp/bos.sysmgmt/nim/methods/getTgtRsrc
-hmc hmcp520 -u hscroot -m "YLI894-2-650E4DG" -o
"/var/mig2p5/client_data/tgtRsrc_YLI894-2-650E4DG" -viosDisk "VI01" -viosEth
"VI01"
Tue Jun 6 11:30:54 2006 OUTPUT (/usr/lpp/bos.sysmgmt/nim/methods/getTgtRsrc):
INPUT:
Tue Jun 6 11:30:54 2006 OUTPUT (/usr/lpp/bos.sysmgmt/nim/methods/getTgtRsrc):
HMC Host = hmcp520
Tue Jun 6 11:30:54 2006 OUTPUT (/usr/lpp/bos.sysmgmt/nim/methods/getTgtRsrc):
HMC Username = hscroot
Tue Jun 6 11:30:54 2006 OUTPUT (/usr/lpp/bos.sysmgmt/nim/methods/getTgtRsrc):
Managed System name = YLI894-2-650E4DG
Tue Jun 6 11:30:54 2006 OUTPUT (/usr/lpp/bos.sysmgmt/nim/methods/getTgtRsrc):
Ethernet VIO Server(s) = VI01
Tue Jun 6 11:30:54 2006 OUTPUT (/usr/lpp/bos.sysmgmt/nim/methods/getTgtRsrc):
Disk VIO Server(s) = VI01
Tue Jun 6 11:30:54 2006 OUTPUT (/usr/lpp/bos.sysmgmt/nim/methods/getTgtRsrc):
Output file =
/var/mig2p5/client_data/tgtRsrc_YLI894-2-650E4DG
Tue Jun 6 11:30:54 2006 OUTPUT (/usr/lpp/bos.sysmgmt/nim/methods/getTgtRsrc):

Tue Jun 6 11:30:54 2006 OUTPUT (/usr/lpp/bos.sysmgmt/nim/methods/getTgtRsrc):
Getting the type & model of the given P5 machine.....
Tue Jun 6 11:30:54 2006 OUTPUT (/usr/lpp/bos.sysmgmt/nim/methods/getTgtRsrc):
cmd = ssh hscroot@hmcp520 lssyscfg -m YLI894-2-650E4DG -r sys -Ftype_model
Tue Jun 6 11:30:54 2006 OUTPUT (/usr/lpp/bos.sysmgmt/nim/methods/getTgtRsrc):
Type-Model = 9131-52A
Tue Jun 6 11:30:54 2006 OUTPUT (/usr/lpp/bos.sysmgmt/nim/methods/getTgtRsrc):

Tue Jun 6 11:30:54 2006 OUTPUT (/usr/lpp/bos.sysmgmt/nim/methods/getTgtRsrc):
Getting the number of processing units in the given P5 machine.....
Tue Jun 6 11:30:54 2006 OUTPUT (/usr/lpp/bos.sysmgmt/nim/methods/getTgtRsrc):
cmd = ssh hscroot@hmcp520 lshwres -m YLI894-2-650E4DG -r proc --level sys
-Fconfigurable_sys_proc_units
Tue Jun 6 11:30:54 2006 OUTPUT (/usr/lpp/bos.sysmgmt/nim/methods/getTgtRsrc):
available_proc_units = 4.0
Tue Jun 6 11:30:54 2006 OUTPUT (/usr/lpp/bos.sysmgmt/nim/methods/getTgtRsrc):

```

```

Tue Jun 6 11:30:54 2006 OUTPUT (/usr/lpp/bos.sysmgmt/nim/methods/getTgtRsrc):
Getting the amount of memory in MBs in the given P5 machine.....
Tue Jun 6 11:30:55 2006 OUTPUT (/usr/lpp/bos.sysmgmt/nim/methods/getTgtRsrc):
Configurable Memory = 8192
Tue Jun 6 11:30:55 2006 OUTPUT (/usr/lpp/bos.sysmgmt/nim/methods/getTgtRsrc):
Available memory = 1248
Tue Jun 6 11:30:55 2006 OUTPUT (/usr/lpp/bos.sysmgmt/nim/methods/getTgtRsrc):
LMB Size = 32
Tue Jun 6 11:30:55 2006 OUTPUT (/usr/lpp/bos.sysmgmt/nim/methods/getTgtRsrc):

Tue Jun 6 11:30:55 2006 OUTPUT (/usr/lpp/bos.sysmgmt/nim/methods/getTgtRsrc):
Getting the available physical I/O slots.....
Tue Jun 6 11:30:55 2006 OUTPUT (/usr/lpp/bos.sysmgmt/nim/methods/getTgtRsrc):

Tue Jun 6 11:30:55 2006 OUTPUT (/usr/lpp/bos.sysmgmt/nim/methods/getTgtRsrc):
Getting the volume groups info in the VIO Disk server(s).....
Tue Jun 6 11:30:55 2006 OUTPUT (/usr/lpp/bos.sysmgmt/nim/methods/getTgtRsrc):
Command:
Tue Jun 6 11:30:55 2006 OUTPUT (/usr/lpp/bos.sysmgmt/nim/methods/getTgtRsrc):
ssh hscroot@hmcp520 viosvr cmd -m YLI894-2-650E4DG -p VIO1 -c "\lsvg\"|
Tue Jun 6 11:30:56 2006 OUTPUT (/usr/lpp/bos.sysmgmt/nim/methods/getTgtRsrc):
Command:
Tue Jun 6 11:30:56 2006 OUTPUT (/usr/lpp/bos.sysmgmt/nim/methods/getTgtRsrc):
ssh hscroot@hmcp520 viosvr cmd -m YLI894-2-650E4DG -p VIO1 -c "\lsvg rootvg\"|
Tue Jun 6 11:30:57 2006 OUTPUT (/usr/lpp/bos.sysmgmt/nim/methods/getTgtRsrc):
Command:
Tue Jun 6 11:30:57 2006 OUTPUT (/usr/lpp/bos.sysmgmt/nim/methods/getTgtRsrc):
ssh hscroot@hmcp520 viosvr cmd -m YLI894-2-650E4DG -p VIO1 -c "\lsvg
rootvg_clients\"|
Tue Jun 6 11:30:58 2006 OUTPUT (/usr/lpp/bos.sysmgmt/nim/methods/getTgtRsrc):
VIO Server = VIO1; VG = rootvg; Size = 53120MB
Tue Jun 6 11:30:58 2006 OUTPUT (/usr/lpp/bos.sysmgmt/nim/methods/getTgtRsrc):
VIO Server = VIO1; VG = rootvg_clients; Size = 98816MB
Tue Jun 6 11:30:58 2006 OUTPUT (/usr/lpp/bos.sysmgmt/nim/methods/getTgtRsrc):

Tue Jun 6 11:30:58 2006 OUTPUT (/usr/lpp/bos.sysmgmt/nim/methods/getTgtRsrc):
Getting the available VLANs info in the VIO server(s).....
Tue Jun 6 11:30:58 2006 OUTPUT (/usr/lpp/bos.sysmgmt/nim/methods/getTgtRsrc):
Command:
Tue Jun 6 11:30:58 2006 OUTPUT (/usr/lpp/bos.sysmgmt/nim/methods/getTgtRsrc):
ssh hscroot@hmcp520 lshwres -m YLI894-2-650E4DG -r virtualio --subtype eth
--level lpar --filter "lpar_names=VIO1"
-Flpar_name:slot_num:port_vlan_id:is_trunk
Tue Jun 6 11:30:59 2006 OUTPUT (/usr/lpp/bos.sysmgmt/nim/methods/getTgtRsrc):
VIO Server = VIO1; VLAN Id = 1; Slot number = 30
Tue Jun 6 11:30:59 2006 rc for /usr/lpp/bos.sysmgmt/nim/methods/getTgtRsrc = 0
Tue Jun 6 11:30:59 2006 Creating p5 configuration for client LPAR4

```

```

Tue Jun 6 11:30:59 2006 Executing: /usr/lpp/bos.sysmgt/nim/methods/genTgtCfg
-s /var/mig2p5/client_data/srcCfg_LPAR4 -m
"/var/mig2p5/client_data/tgtRsrc_YLI894-2-650E4DG" -e
/usr/lpp/bos.sysmgt/nim/methods/capEqMaps -lpar "LPAR4_lpar" -prof
"LPAR4_profile" -o /var/mig2p5/client_data/tgtCfg_LPAR4
Tue Jun 6 11:30:59 2006 OUTPUT (/usr/lpp/bos.sysmgt/nim/methods/genTgtCfg):
INPUT:
Tue Jun 6 11:30:59 2006 OUTPUT (/usr/lpp/bos.sysmgt/nim/methods/genTgtCfg):
Source Configuration file : /var/mig2p5/client_data/srcCfg_LPAR4
Tue Jun 6 11:30:59 2006 OUTPUT (/usr/lpp/bos.sysmgt/nim/methods/genTgtCfg):
Target Machine information file :
/var/mig2p5/client_data/tgtRsrc_YLI894-2-650E4DG
Tue Jun 6 11:30:59 2006 OUTPUT (/usr/lpp/bos.sysmgt/nim/methods/genTgtCfg):
Capacity equivalence maps file :
/usr/lpp/bos.sysmgt/nim/methods/capEqMaps
Tue Jun 6 11:30:59 2006 OUTPUT (/usr/lpp/bos.sysmgt/nim/methods/genTgtCfg):
Target LPAR name : LPAR4_lpar
Tue Jun 6 11:30:59 2006 OUTPUT (/usr/lpp/bos.sysmgt/nim/methods/genTgtCfg):
Name of the profile to be created in LPAR: LPAR4_profile
Tue Jun 6 11:30:59 2006 OUTPUT (/usr/lpp/bos.sysmgt/nim/methods/genTgtCfg):
Target LPAR file : /var/mig2p5/client_data/tgtCfg_LPAR4
Tue Jun 6 11:30:59 2006 OUTPUT (/usr/lpp/bos.sysmgt/nim/methods/genTgtCfg):
Use dedicated CPUs? : No
Tue Jun 6 11:30:59 2006 OUTPUT (/usr/lpp/bos.sysmgt/nim/methods/genTgtCfg):
Use dedicated Ethernet adapters? : No
Tue Jun 6 11:30:59 2006 OUTPUT (/usr/lpp/bos.sysmgt/nim/methods/genTgtCfg):
Use dedicated Hard disks? : No
Tue Jun 6 11:30:59 2006 OUTPUT (/usr/lpp/bos.sysmgt/nim/methods/genTgtCfg):

Tue Jun 6 11:30:59 2006 OUTPUT (/usr/lpp/bos.sysmgt/nim/methods/genTgtCfg):
Reading the Source Configure from the given file.....
Tue Jun 6 11:30:59 2006 OUTPUT (/usr/lpp/bos.sysmgt/nim/methods/genTgtCfg):
Tue Jun 6 11:30:59 2006 OUTPUT (/usr/lpp/bos.sysmgt/nim/methods/genTgtCfg):
Tue Jun 6 11:30:59 2006 OUTPUT (/usr/lpp/bos.sysmgt/nim/methods/genTgtCfg):
10002
Tue Jun 6 11:30:59 2006 OUTPUT (/usr/lpp/bos.sysmgt/nim/methods/genTgtCfg):
src_mem_util = 43
Tue Jun 6 11:30:59 2006 OUTPUT (/usr/lpp/bos.sysmgt/nim/methods/genTgtCfg):
Tue Jun 6 11:30:59 2006 OUTPUT (/usr/lpp/bos.sysmgt/nim/methods/genTgtCfg):
Machine Type-model of the source machine = 7040-671
Tue Jun 6 11:30:59 2006 OUTPUT (/usr/lpp/bos.sysmgt/nim/methods/genTgtCfg):
Number of CPUs in the source machine = 2
Tue Jun 6 11:30:59 2006 OUTPUT (/usr/lpp/bos.sysmgt/nim/methods/genTgtCfg):
Amount of memory in the source machine = 1024
Tue Jun 6 11:30:59 2006 OUTPUT (/usr/lpp/bos.sysmgt/nim/methods/genTgtCfg):
Tue Jun 6 11:30:59 2006 OUTPUT (/usr/lpp/bos.sysmgt/nim/methods/genTgtCfg):
Network slots in source machine = 10/100 Mbps Ethernet PCI Adapter II
Tue Jun 6 11:30:59 2006 OUTPUT (/usr/lpp/bos.sysmgt/nim/methods/genTgtCfg):

```



```

Tue Jun 6 11:30:59 2006 OUTPUT (/usr/lpp/bos.sysmgmt/nim/methods/genTgtCfg):
Reading the target P5 managed system configuration.....
Tue Jun 6 11:30:59 2006 OUTPUT (/usr/lpp/bos.sysmgmt/nim/methods/genTgtCfg):
Tue Jun 6 11:30:59 2006 OUTPUT (/usr/lpp/bos.sysmgmt/nim/methods/genTgtCfg):
Available processing units = 4.0
Tue Jun 6 11:30:59 2006 OUTPUT (/usr/lpp/bos.sysmgmt/nim/methods/genTgtCfg):
Available memory = 1248
Tue Jun 6 11:30:59 2006 OUTPUT (/usr/lpp/bos.sysmgmt/nim/methods/genTgtCfg):
Tue Jun 6 11:30:59 2006 OUTPUT (/usr/lpp/bos.sysmgmt/nim/methods/genTgtCfg): 10
slots = 21010002/none/Fibre Channel Serial Bus:21030003/none/PCI 1Gbps
Ethernet Fiber 2-port:21040003/none/Storage controller:21050003/none/PCI 1Gbps
Ethernet Fiber 2-port:21010004/none/Universal Serial Bus UHC
Spec:21030004/none/Fibre Channel Serial Bus
Tue Jun 6 11:30:59 2006 OUTPUT (/usr/lpp/bos.sysmgmt/nim/methods/genTgtCfg):
Tue Jun 6 11:30:59 2006 OUTPUT (/usr/lpp/bos.sysmgmt/nim/methods/genTgtCfg):
Storage IO slots = 21040003/none/Storage controller
Tue Jun 6 11:30:59 2006 OUTPUT (/usr/lpp/bos.sysmgmt/nim/methods/genTgtCfg):
Tue Jun 6 11:30:59 2006 OUTPUT (/usr/lpp/bos.sysmgmt/nim/methods/genTgtCfg):
Network IO slots = 21030003/none/PCI 1Gbps Ethernet Fiber
2-port:21050003/none/PCI 1Gbps Ethernet Fiber 2-port
Tue Jun 6 11:30:59 2006 OUTPUT (/usr/lpp/bos.sysmgmt/nim/methods/genTgtCfg):
Tue Jun 6 11:30:59 2006 OUTPUT (/usr/lpp/bos.sysmgmt/nim/methods/genTgtCfg):
VIO Volume groups = rootvg,VI01,53120
Tue Jun 6 11:30:59 2006 OUTPUT (/usr/lpp/bos.sysmgmt/nim/methods/genTgtCfg):
rootvg_clients,VI01,98816
Tue Jun 6 11:30:59 2006 OUTPUT (/usr/lpp/bos.sysmgmt/nim/methods/genTgtCfg):
Tue Jun 6 11:30:59 2006 OUTPUT (/usr/lpp/bos.sysmgmt/nim/methods/genTgtCfg):
VIO Hard disks =
Tue Jun 6 11:30:59 2006 OUTPUT (/usr/lpp/bos.sysmgmt/nim/methods/genTgtCfg):
Tue Jun 6 11:30:59 2006 OUTPUT (/usr/lpp/bos.sysmgmt/nim/methods/genTgtCfg):
VIO VLANs = 1,VI01,30
Tue Jun 6 11:30:59 2006 OUTPUT (/usr/lpp/bos.sysmgmt/nim/methods/genTgtCfg):
src_freq = 1000, tgt_freq = 1500
Tue Jun 6 11:30:59 2006 OUTPUT (/usr/lpp/bos.sysmgmt/nim/methods/genTgtCfg):

Tue Jun 6 11:30:59 2006 OUTPUT (/usr/lpp/bos.sysmgmt/nim/methods/genTgtCfg):
Calculating the resource requirements of target LPAR.....
Tue Jun 6 11:30:59 2006 OUTPUT (/usr/lpp/bos.sysmgmt/nim/methods/genTgtCfg):
Tue Jun 6 11:30:59 2006 OUTPUT (/usr/lpp/bos.sysmgmt/nim/methods/genTgtCfg):
des_procs = 0.1
Tue Jun 6 11:30:59 2006 OUTPUT (/usr/lpp/bos.sysmgmt/nim/methods/genTgtCfg):
des_memory = 448
Tue Jun 6 11:30:59 2006 OUTPUT (/usr/lpp/bos.sysmgmt/nim/methods/genTgtCfg):
New Physical io slots =
Tue Jun 6 11:30:59 2006 OUTPUT (/usr/lpp/bos.sysmgmt/nim/methods/genTgtCfg):

Tue Jun 6 11:30:59 2006 OUTPUT (/usr/lpp/bos.sysmgmt/nim/methods/genTgtCfg):
Creating the target LPAR configuration file.....
Tue Jun 6 11:30:59 2006 rc for /usr/lpp/bos.sysmgmt/nim/methods/genTgtCfg = 0

```

```

Tue Jun 6 11:30:59 2006 Executing:
/usr/lpp/bos.sysmgmt/nim/methods/createTgtLPAR -m
"/var/mig2p5/client_data/tgtRsrc_YLI894-2-650E4DG" -t
/var/mig2p5/client_data/tgtCfg_LPAR4
Tue Jun 6 11:30:59 2006 OUTPUT
(/usr/lpp/bos.sysmgmt/nim/methods/createTgtLPAR): INPUT:
Tue Jun 6 11:30:59 2006 OUTPUT
(/usr/lpp/bos.sysmgmt/nim/methods/createTgtLPAR): Target Machine configuration
file = /var/mig2p5/client_data/tgtRsrc_YLI894-2-650E4DG
Tue Jun 6 11:30:59 2006 OUTPUT
(/usr/lpp/bos.sysmgmt/nim/methods/createTgtLPAR): Target LPAR configuration file
= /var/mig2p5/client_data/tgtCfg_LPAR4
Tue Jun 6 11:30:59 2006 OUTPUT
(/usr/lpp/bos.sysmgmt/nim/methods/createTgtLPAR): Managed system =
YLI894-2-650E4DG
Tue Jun 6 11:30:59 2006 OUTPUT
(/usr/lpp/bos.sysmgmt/nim/methods/createTgtLPAR): HMC Hostname = hmc520
Tue Jun 6 11:30:59 2006 OUTPUT
(/usr/lpp/bos.sysmgmt/nim/methods/createTgtLPAR): User configured for remote ssh
to HMC = hscroot
Tue Jun 6 11:30:59 2006 OUTPUT
(/usr/lpp/bos.sysmgmt/nim/methods/createTgtLPAR): LPAR name: LPAR4_lpar
Tue Jun 6 11:30:59 2006 OUTPUT
(/usr/lpp/bos.sysmgmt/nim/methods/createTgtLPAR): Profile name: LPAR4_profile
Tue Jun 6 11:30:59 2006 OUTPUT
(/usr/lpp/bos.sysmgmt/nim/methods/createTgtLPAR): Proc units: Min=0.1,
Desired=0.1, Max=0.2
Tue Jun 6 11:30:59 2006 OUTPUT
(/usr/lpp/bos.sysmgmt/nim/methods/createTgtLPAR): CPUs: Min=1, Desired=1, Max=1
Tue Jun 6 11:30:59 2006 OUTPUT
(/usr/lpp/bos.sysmgmt/nim/methods/createTgtLPAR): Memory: Min=256, Desired=448,
Max=896
Tue Jun 6 11:30:59 2006 OUTPUT
(/usr/lpp/bos.sysmgmt/nim/methods/createTgtLPAR): Virtual IO VGs:
Tue Jun 6 11:30:59 2006 OUTPUT
(/usr/lpp/bos.sysmgmt/nim/methods/createTgtLPAR): rootvg,17344,rootvg,VI01
Tue Jun 6 11:30:59 2006 OUTPUT
(/usr/lpp/bos.sysmgmt/nim/methods/createTgtLPAR):
Tue Jun 6 11:30:59 2006 OUTPUT
(/usr/lpp/bos.sysmgmt/nim/methods/createTgtLPAR): Virtual IO VLANs:
Tue Jun 6 11:30:59 2006 OUTPUT
(/usr/lpp/bos.sysmgmt/nim/methods/createTgtLPAR): 1,VI01,30
Tue Jun 6 11:30:59 2006 OUTPUT
(/usr/lpp/bos.sysmgmt/nim/methods/createTgtLPAR):
Tue Jun 6 11:30:59 2006 OUTPUT
(/usr/lpp/bos.sysmgmt/nim/methods/createTgtLPAR):

```

```

Tue Jun 6 11:30:59 2006 OUTPUT
(/usr/lpp/bos.sysmgmt/nim/methods/createTgtLPAR): Creating the target LPAR
profile with proc units and memory.....
Tue Jun 6 11:30:59 2006 OUTPUT
(/usr/lpp/bos.sysmgmt/nim/methods/createTgtLPAR): Command:
Tue Jun 6 11:30:59 2006 OUTPUT
(/usr/lpp/bos.sysmgmt/nim/methods/createTgtLPAR): ssh hscroot@hmcp520 mksyscfg
-r lpar -m YLI894-2-650E4DG -i
name=LPAR4_lpar,profile_name=LPAR4_profile,lpar_env=aixlinux,proc_mode=shared,s
haring_mode=cap,min_proc_units=0.1,desired_proc_units=0.1,max_proc_units=0.2,m
n_procs=1,desired_procs=1,max_procs=1,min_mem=256,desired_mem=448,max_mem=896,b
oot_mode=norm
Tue Jun 6 11:31:07 2006 OUTPUT
(/usr/lpp/bos.sysmgmt/nim/methods/createTgtLPAR):

Tue Jun 6 11:31:07 2006 OUTPUT
(/usr/lpp/bos.sysmgmt/nim/methods/createTgtLPAR): Discovering the LPAR id
assigned to the above LPAR.....
Tue Jun 6 11:31:07 2006 OUTPUT
(/usr/lpp/bos.sysmgmt/nim/methods/createTgtLPAR): Command:
Tue Jun 6 11:31:07 2006 OUTPUT
(/usr/lpp/bos.sysmgmt/nim/methods/createTgtLPAR): ssh hscroot@hmcp520 lssyscfg
-r lpar -m YLI894-2-650E4DG --filter lpar_names=LPAR4_lpar -flpar_id
Tue Jun 6 11:31:08 2006 OUTPUT
(/usr/lpp/bos.sysmgmt/nim/methods/createTgtLPAR): LPAR ID = 1
Tue Jun 6 11:31:08 2006 OUTPUT
(/usr/lpp/bos.sysmgmt/nim/methods/createTgtLPAR):

Tue Jun 6 11:31:08 2006 OUTPUT
(/usr/lpp/bos.sysmgmt/nim/methods/createTgtLPAR): Adding Physical I/O slots to
the LPAR profile.....
Tue Jun 6 11:31:08 2006 OUTPUT
(/usr/lpp/bos.sysmgmt/nim/methods/createTgtLPAR):No physical I/O slots to
add to the LPAR profile.
Tue Jun 6 11:31:08 2006 OUTPUT
(/usr/lpp/bos.sysmgmt/nim/methods/createTgtLPAR):

Tue Jun 6 11:31:08 2006 OUTPUT
(/usr/lpp/bos.sysmgmt/nim/methods/createTgtLPAR): Adding Virtual I/O to the LPAR
profile.....
Tue Jun 6 11:31:08 2006 OUTPUT
(/usr/lpp/bos.sysmgmt/nim/methods/createTgtLPAR):

Tue Jun 6 11:31:08 2006 OUTPUT
(/usr/lpp/bos.sysmgmt/nim/methods/createTgtLPAR): Getting the list of existing
vscsi devices in the VIO server.....
Tue Jun 6 11:31:08 2006 OUTPUT
(/usr/lpp/bos.sysmgmt/nim/methods/createTgtLPAR): Command:

```

```

Tue Jun 6 11:31:08 2006 OUTPUT
(/usr/lpp/bos.sysmgmt/nim/methods/createTgtLPAR): ssh hscroot@hmcp520 viosvr cmd
-m YLI894-2-650E4DG -p VI01 -c "\lsdev -virtual\"
Tue Jun 6 11:31:08 2006 OUTPUT
(/usr/lpp/bos.sysmgmt/nim/methods/createTgtLPAR):

Tue Jun 6 11:31:08 2006 OUTPUT
(/usr/lpp/bos.sysmgmt/nim/methods/createTgtLPAR): Determining the free virtual
slot number in the VIO server.....
Tue Jun 6 11:31:08 2006 OUTPUT
(/usr/lpp/bos.sysmgmt/nim/methods/createTgtLPAR): Command:
Tue Jun 6 11:31:08 2006 OUTPUT
(/usr/lpp/bos.sysmgmt/nim/methods/createTgtLPAR): ssh hscroot@hmcp520 lshwres
-r virtualio --rsubtype slot -m YLI894-2-650E4DG --level slot --filter
"lpar_names=VI01" -Fslot_num
Tue Jun 6 11:31:13 2006 OUTPUT
(/usr/lpp/bos.sysmgmt/nim/methods/createTgtLPAR):

Tue Jun 6 11:31:13 2006 OUTPUT
(/usr/lpp/bos.sysmgmt/nim/methods/createTgtLPAR): Creating virtual scsi adapter
in the VIO server.....
Tue Jun 6 11:31:13 2006 OUTPUT
(/usr/lpp/bos.sysmgmt/nim/methods/createTgtLPAR): Adding the vscsi adapter to
the VIO server using DR operation.
Tue Jun 6 11:31:13 2006 OUTPUT
(/usr/lpp/bos.sysmgmt/nim/methods/createTgtLPAR): Command = ssh hscroot@hmcp520
chhwres -r virtualio --rsubtype scsi -m YLI894-2-650E4DG -o a -p VI01 -s 31 -a
"adapter_type=server,remote_slot_num=2,remote_lpar_name=LPAR4_lpar"
Tue Jun 6 11:31:15 2006 OUTPUT
(/usr/lpp/bos.sysmgmt/nim/methods/createTgtLPAR):

Tue Jun 6 11:31:15 2006 OUTPUT
(/usr/lpp/bos.sysmgmt/nim/methods/createTgtLPAR): Getting the default and
current profile names of VIO server...
Tue Jun 6 11:31:15 2006 OUTPUT
(/usr/lpp/bos.sysmgmt/nim/methods/createTgtLPAR): Command:
Tue Jun 6 11:31:15 2006 OUTPUT
(/usr/lpp/bos.sysmgmt/nim/methods/createTgtLPAR): ssh hscroot@hmcp520 lssyscfg
-r lpar -m YLI894-2-650E4DG --filter "lpar_names=VI01"
-Fdefault_profile:curr_profile
Tue Jun 6 11:31:15 2006 OUTPUT
(/usr/lpp/bos.sysmgmt/nim/methods/createTgtLPAR):

Tue Jun 6 11:31:15 2006 OUTPUT
(/usr/lpp/bos.sysmgmt/nim/methods/createTgtLPAR): Adding the vscsi adapter to
the default profile of VIO server....
Tue Jun 6 11:31:15 2006 OUTPUT
(/usr/lpp/bos.sysmgmt/nim/methods/createTgtLPAR): Command:

```

```

Tue Jun 6 11:31:15 2006 OUTPUT
(/usr/lpp/bos.sysmgmt/nim/methods/createTgtLPAR): ssh hscroot@hmcp520 chsyscfg
-r prof -m YLI894-2-650E4DG -i
"name=normal,lpar_name=VI01,virtual_scsi_adapters+=31/server/1/LPAR4_lpar/2/1"
Tue Jun 6 11:31:21 2006 OUTPUT
(/usr/lpp/bos.sysmgmt/nim/methods/createTgtLPAR):

Tue Jun 6 11:31:21 2006 OUTPUT
(/usr/lpp/bos.sysmgmt/nim/methods/createTgtLPAR): Configuring the virtual scsi
adapter in the VIO server.....
Tue Jun 6 11:31:21 2006 OUTPUT
(/usr/lpp/bos.sysmgmt/nim/methods/createTgtLPAR): Command:
Tue Jun 6 11:31:21 2006 OUTPUT
(/usr/lpp/bos.sysmgmt/nim/methods/createTgtLPAR): ssh hscroot@hmcp520 viosvr cmd
-m YLI894-2-650E4DG -p VI01 -c "\"cfgdev\""
Tue Jun 6 11:31:22 2006 OUTPUT
(/usr/lpp/bos.sysmgmt/nim/methods/createTgtLPAR):
:-----
Tue Jun 6 11:31:22 2006 OUTPUT
(/usr/lpp/bos.sysmgmt/nim/methods/createTgtLPAR): Determining the OS-generated
vscsi device name for the new adapter....
Tue Jun 6 11:31:22 2006 OUTPUT
(/usr/lpp/bos.sysmgmt/nim/methods/createTgtLPAR): Command:
Tue Jun 6 11:31:22 2006 OUTPUT
(/usr/lpp/bos.sysmgmt/nim/methods/createTgtLPAR): ssh hscroot@hmcp520 viosvr cmd
-m YLI894-2-650E4DG -p VI01 -c "\"lsdev -virtual\""
Tue Jun 6 11:31:23 2006 OUTPUT
(/usr/lpp/bos.sysmgmt/nim/methods/createTgtLPAR):

Tue Jun 6 11:31:23 2006 OUTPUT
(/usr/lpp/bos.sysmgmt/nim/methods/createTgtLPAR): Creating a logical volume in
the VIO server.....
Tue Jun 6 11:31:23 2006 OUTPUT
(/usr/lpp/bos.sysmgmt/nim/methods/createTgtLPAR): Command:
Tue Jun 6 11:31:23 2006 OUTPUT
(/usr/lpp/bos.sysmgmt/nim/methods/createTgtLPAR): ssh hscroot@hmcp520 viosvr cmd
-m YLI894-2-650E4DG -p VI01 -c "\"mklv -lv rootvg_1 rootvg 17G\""
Tue Jun 6 11:31:24 2006 OUTPUT
(/usr/lpp/bos.sysmgmt/nim/methods/createTgtLPAR): rootvg_1
Tue Jun 6 11:31:24 2006 OUTPUT
(/usr/lpp/bos.sysmgmt/nim/methods/createTgtLPAR):

Tue Jun 6 11:31:24 2006 OUTPUT
(/usr/lpp/bos.sysmgmt/nim/methods/createTgtLPAR): Attaching the above LV to the
vscsi device created earlier.....
Tue Jun 6 11:31:24 2006 OUTPUT
(/usr/lpp/bos.sysmgmt/nim/methods/createTgtLPAR): Command:
Tue Jun 6 11:31:24 2006 OUTPUT
(/usr/lpp/bos.sysmgmt/nim/methods/createTgtLPAR): ssh hscroot@hmcp520 viosvr cmd

```

```

-m YLI894-2-650E4DG -p VI01 -c "\"mkvdev -vdev rootvg_1 -vadapter vhost4 -dev
vtscsi4\""
Tue Jun 6 11:31:26 2006 OUTPUT
(/usr/lpp/bos.sysmgmt/nim/methods/createTgtLPAR): vtscsi4 Available
Tue Jun 6 11:31:26 2006 OUTPUT
(/usr/lpp/bos.sysmgmt/nim/methods/createTgtLPAR):

Tue Jun 6 11:31:26 2006 OUTPUT
(/usr/lpp/bos.sysmgmt/nim/methods/createTgtLPAR): Creating the virtual scsi
adapter for client LPAR.....
Tue Jun 6 11:31:26 2006 OUTPUT
(/usr/lpp/bos.sysmgmt/nim/methods/createTgtLPAR): Command:
Tue Jun 6 11:31:26 2006 OUTPUT
(/usr/lpp/bos.sysmgmt/nim/methods/createTgtLPAR): ssh hscroot@hmcp520 chsyscfg
-r prof -m YLI894-2-650E4DG -i
name=LPAR4_profile,lpar_name=LPAR4_lpar,virtual_scsi_adapters+=2/client//VI01/3
1/1
Tue Jun 6 11:31:29 2006 OUTPUT
(/usr/lpp/bos.sysmgmt/nim/methods/createTgtLPAR):

Tue Jun 6 11:31:29 2006 OUTPUT
(/usr/lpp/bos.sysmgmt/nim/methods/createTgtLPAR): Creating the virtual ethernet
adapters for client LPAR.....
Tue Jun 6 11:31:29 2006 OUTPUT
(/usr/lpp/bos.sysmgmt/nim/methods/createTgtLPAR): Command:
Tue Jun 6 11:31:29 2006 OUTPUT
(/usr/lpp/bos.sysmgmt/nim/methods/createTgtLPAR): ssh hscroot@hmcp520 chsyscfg
-r prof -m YLI894-2-650E4DG -i
name=LPAR4_profile,lpar_name=LPAR4_lpar,virtual_eth_adapters+=3/0/1//0/1
Tue Jun 6 11:31:32 2006 rc for /usr/lpp/bos.sysmgmt/nim/methods/createTgtLPAR =
0
Tue Jun 6 11:31:32 2006 STATUS for phase 4: success

```

In summary, **Phase 4** performed the following:

- ▶ Obtained information regarding the POWER5 target system; that is, type and model, available processing units, available memory, available physical I/O slots, VIO volume group information, and VIO VLAN information.
- ▶ Created the new LPAR on the POWER5 machine such as LPAR name, name of the LPAR profile, whether or not dedicated or shared CPU was needed, whether or not physical adapters were required (that is, Ethernet, Fibre Channel, SCSI or VSCSI), LPAR profile configuration (min/desired/max for CPU and memory), virtual I/O resources on the VIO server for virtual SCSI disk, virtual Ethernet, virtual SCSI adapters and so on. Example 4-137 on page 245 shows the virtual SCSI adapter and disk resources that were created on the VIO server for the client.

**Note:** If the overall creation process of the new LPAR fails but the VIO resources were created successfully, or if you wish to restart the `nim_move_up` process from the beginning, you may need to remove the virtual SCSI adapter and disk resources on the VIO server.

Before you can try phase 4 again, however, remove the vhost adapter (for example, `vhost4`) and then the client logical volume (`rootvg_1`). The `nim_move_up` program is currently unable to undo changes made to the POWER5 server (LPAR creation) and a VIO server. These changes must be done manually even if the `nim_move_up -r` command has been run to unconfigure the operation.

*Example 4-137 Virtual SCSI and disk resources created for the client*

```
$ lsmmap -vadapter vhost4
SVSA Physloc Client Partition ID

vhost4 U9131.52A.650E4DG-V2-C31 0x00000001

VTD vtscsi4
LUN 0x8100000000000000
Backing device rootvg_1
Physloc

$ lsvg -lv rootvg
rootvg:
LV NAME TYPE LPs PPs PVs LV STATE MOUNT POINT
hd5 boot 1 1 1 closed/syncd N/A
hd6 paging 4 4 1 open/syncd N/A
paging00 paging 8 8 1 open/syncd N/A
hd8 jfs2log 1 1 1 open/syncd N/A
hd4 jfs2 2 2 1 open/syncd /
hd2 jfs2 10 10 1 open/syncd /usr
hd9var jfs2 5 5 1 open/syncd /var
hd3 jfs2 11 11 1 open/syncd /tmp
hd1 jfs2 80 80 1 open/syncd /home
hd10opt jfs2 1 1 1 open/syncd /opt
lg_dump1v sysdump 8 8 1 open/syncd N/A
rootvg_1 jfs 136 136 1 open/syncd N/A
```

On completion of **Phase 4**, a new LPAR is created on the p520. The LPAR is called LPAR4\_lpar.

The following file was used by `nim_move_up` to automatically create the new POWER5 LPAR, as shown in Example 4-138 on page 246.

*Example 4-138 File used to create the POWER 5 LPAR*

---

```
{nimmast}:/var/mig2p5/client_data # cat tgtCfg_LPAR4
LPAR_NAME = LPAR4_lpar
PROFILE_NAME = LPAR4_profile
PROC_UNITS = <min> <desired> <max>
PROC_UNITS = 0.1 0.1 0.2
MEMORY = <min MB> <desired MB> <max MB>
MEMORY = 256 448 896
VIO_VG_INFO = <vgname_src>,<size in MB>,<vgname_vio>,<lpar_name>
Where <vgname_src> is the VG name in source machine, and
<vgname_vio> is the VG name in VIO server LPAR
VIO_VG_INFO = rootvg,17344,rootvg,VI01
VIO_VLAN_INFO = <vlan id>,<lpar name>,<slot number>
VIO_VLAN_INFO = 1,VI01,30
```

---

The file in Example 4-139 is used to determine what resources are available on the POWER5 system.

*Example 4-139 Determining the resources available on the POWER5 system*

---

```
{nimmast}:/var/mig2p5/client_data # cat tgtRsrc_YLI894-2-650E4DG
MACHINE = 9131-52A
MANAGED SYSTEM = YLI894-2-650E4DG
HMC = hmcp520
HMC_SSH_USER = hscroot
AVAILABLE PROC UNITS = 4.0
CONFIGURABLE MEMORY = 8192MB
AVAILABLE MEMORY = 1248MB
LMB SIZE = 32MB
IOSLOT = <drc_index>/<slot_pool_id>/<description>
IOSLOT = 21010002/none/Fibre Channel Serial Bus
IOSLOT = 21030003/none/PCI 1Gbps Ethernet Fiber 2-port
IOSLOT = 21040003/none/Storage controller
IOSLOT = 21050003/none/PCI 1Gbps Ethernet Fiber 2-port
IOSLOT = 21010004/none/Universal Serial Bus UHC Spec
IOSLOT = 21030004/none/Fibre Channel Serial Bus
VIO VG = <vg name>,<lpar name>,<size in MB>
VIO VG = rootvg,VI01,53120
VIO VG = rootvg_clients,VI01,98816
VIO VLAN = <vlan id>,<lpar name>,<slot number>
VIO VLAN = 1,VI01,30
```

---

## 10.Phase 5 - Create system backups.

The next step, shown in Example 4-140 on page 247, creates a mksysb backup of the source client.



**Note:** Ensure that the file size limit (ulimit) for the root user on the client and the master is set to unlimited for mksysb images larger than 2 GB; for example:

```
chuser fsize=-1 root
lsuser -a fsize root
root fsize=-1
```

#### *Example 4-140 Creation of the mksysb backup*

---

```
{nimmast}:/ # nim_move_up -S
nim_move_up Status:
=====
Tue Jun 6 11:32:04 2006
```

Next phase to execute: 5 - Create System Backups

```
Saved parameters:
accept_licenses = yes
images = /moveup/AIX5304
hmc = hmcp520
location = /moveup
gateway = 10.1.1.1
managed_sys = YLI894-2-650E4DG
subnet_mask = 255.255.255.0
spot = SPOT_53_ML4
lpp_source = LPP_53_ML4
vioserver = VI01
target_client = LPAR4
min_ip = 10.1.1.65
```

---

Phase 5 execution has begun. After the mksysb for the client is finished, a new mksysb resource definition is created (in our case, LPAR4\_phys\_mksysb); see Example 4-141.

#### *Example 4-141 New mksysb resource definition*

---

```
{nimmast}:/ # nim_move_up -n
Tue Jun 6 11:39:20 2006 Starting Phase 5 : Create System Backups...
Tue Jun 6 11:39:20 2006 Creating mksysb for client LPAR4
Tue Jun 6 11:39:20 2006 Executing: /usr/sbin/nim -o define -t mksysb -a
server=master -a source=LPAR4 -a location=/moveup/mksysb/LPAR4/LPAR4_mksysb -a
mk_image=yes LPAR4_phys_mksysb
Tue Jun 6 11:39:22 2006 OUTPUT (/usr/sbin/nim):
Tue Jun 6 11:39:22 2006 OUTPUT (/usr/sbin/nim):
+-----+
Tue Jun 6 11:39:22 2006 OUTPUT (/usr/sbin/nim): System Backup
Image Space Information
```

```

Tue Jun 6 11:39:22 2006 OUTPUT (/usr/sbin/nim): (Sizes are
displayed in 1024-byte blocks.)
Tue Jun 6 11:39:22 2006 OUTPUT (/usr/sbin/nim):
+-----+
Tue Jun 6 11:39:22 2006 OUTPUT (/usr/sbin/nim):
Tue Jun 6 11:39:22 2006 OUTPUT (/usr/sbin/nim): Required = 327520 (328 MB)
Available = 8452488 (8452 MB)
Tue Jun 6 11:39:22 2006 OUTPUT (/usr/sbin/nim):
Tue Jun 6 11:39:22 2006 OUTPUT (/usr/sbin/nim): Data compression will be used
by the system backup utilities which
Tue Jun 6 11:39:22 2006 OUTPUT (/usr/sbin/nim): create the system backup
image. This may reduce the required space
Tue Jun 6 11:39:22 2006 OUTPUT (/usr/sbin/nim): by up to 50 percent.
Tue Jun 6 11:39:22 2006 OUTPUT (/usr/sbin/nim):
Tue Jun 6 11:39:24 2006 OUTPUT (/usr/sbin/nim):
Tue Jun 6 11:39:33 2006 OUTPUT (/usr/sbin/nim): Creating information file
(/image.data) for rootvg.
Tue Jun 6 11:39:33 2006 OUTPUT (/usr/sbin/nim):
Tue Jun 6 11:39:34 2006 OUTPUT (/usr/sbin/nim): Creating list of files to back
up.
Tue Jun 6 11:39:55 2006 OUTPUT (/usr/sbin/nim): Backing up 12723 files..
Tue Jun 6 11:39:55 2006 OUTPUT (/usr/sbin/nim): 12723 of 12723 files (100%)
Tue Jun 6 11:39:55 2006 OUTPUT (/usr/sbin/nim): 0512-038 savevg: Backup
Completed Successfully.
Tue Jun 6 11:40:05 2006 rc for /usr/sbin/nim = 0
Tue Jun 6 11:40:05 2006 STATUS for phase 5: success

```

---

## 11. Phase 6 - Migrate the system backup.

In this phase, the `nimadm` command is executed to perform an AIX 5L V5.3 migration of each clients' mksysb image, as shown in Example 4-142.

### *Example 4-142 Migration the system backups*

---

```

{nimmast}:/ # nim_move_up -S
nim_move_up Status:
=====
Tue Jun 6 11:41:19 2006

```

Next phase to execute: 6 - Migrate Each System Backup

```

Saved parameters:
 accept_licenses = yes
 images = /moveup/AIX5304
 hmc = hmcp520
 location = /moveup
 gateway = 10.1.1.1
 managed_sys = YLI894-2-650E4DG
 subnet_mask = 255.255.255.0
 spot = SPOT_53_ML4

```

```
lpp_source = LPP_53_ML4
vioserver = VI01
target_client = LPAR4
min_ip = 10.1.1.65
```

---

Now we begin the execution of **Phase 6** and monitor the output. Note that the output has been reduced to save space, as shown in Example 4-143.

*Example 4-143 Execution and monitoring of phase 6*

---

```
{nimmast}:/ # nim_move_up -n
Tue Jun 6 11:41:32 2006 Starting Phase 6 : Migrate Each System Backup...
Tue Jun 6 11:41:32 2006 Executing: /usr/sbin/nimadm -HM -s SPOT_53_ML4 -1
LPP_53_ML4
Tue Jun 6 11:41:32 2006 OUTPUT (/usr/sbin/nimadm):
+-----+
Tue Jun 6 11:41:32 2006 OUTPUT (/usr/sbin/nimadm): Gathering System
Information
Tue Jun 6 11:41:32 2006 OUTPUT (/usr/sbin/nimadm):
+-----+
Tue Jun 6 11:41:32 2006 OUTPUT (/usr/sbin/nimadm): Determining level of the
"bos.alt_disk_install.rte" fileset for "rootvg" ...
Tue Jun 6 11:41:33 2006 OUTPUT (/usr/sbin/nimadm): Determining level of the
"bos.alt_disk_install.rte" fileset for SPOT NIM
Tue Jun 6 11:41:33 2006 OUTPUT (/usr/sbin/nimadm): resource "SPOT_53_ML4" ...
Tue Jun 6 11:41:36 2006 OUTPUT (/usr/sbin/nimadm): Determining level of the
"bos.alt_disk_install.rte" fileset for lpp_source NIM
Tue Jun 6 11:41:36 2006 OUTPUT (/usr/sbin/nimadm): resource "LPP_53_ML4" ...
Tue Jun 6 11:41:37 2006 OUTPUT (/usr/sbin/nimadm):
Tue Jun 6 11:41:37 2006 OUTPUT (/usr/sbin/nimadm):
+-----+
Tue Jun 6 11:41:37 2006 OUTPUT (/usr/sbin/nimadm): Checking Software
Synchronization
Tue Jun 6 11:41:37 2006 OUTPUT (/usr/sbin/nimadm):
+-----+
Tue Jun 6 11:41:37 2006 OUTPUT (/usr/sbin/nimadm): The
bos.alt_disk_install.rte fileset level for "rootvg" is 5.3.0.40
Tue Jun 6 11:41:37 2006 OUTPUT (/usr/sbin/nimadm): The
bos.alt_disk_install.rte fileset level for "SPOT_53_ML4" is 5.3.0.40
Tue Jun 6 11:41:37 2006 OUTPUT (/usr/sbin/nimadm): The
bos.alt_disk_install.rte fileset level for "LPP_53_ML4" is 5.3.0.40
Tue Jun 6 11:41:37 2006 OUTPUT (/usr/sbin/nimadm):
Tue Jun 6 11:41:37 2006 OUTPUT (/usr/sbin/nimadm): Software is currently
synchronized.
Tue Jun 6 11:41:37 2006 OUTPUT (/usr/sbin/nimadm):
Tue Jun 6 11:41:37 2006 OUTPUT (/usr/sbin/nimadm): Log file is:
/var/adm/ras/nimadm.log
Tue Jun 6 11:41:37 2006 rc for /usr/sbin/nimadm = 0
Tue Jun 6 11:41:37 2006 Migrating mksysb for client LPAR4
```

```

Tue Jun 6 11:41:37 2006 Executing: /usr/sbin/nimadm -s SPOT_53_ML4 -l
LPP_53_ML4 -T LPAR4_phys_mksysb -O /moveup/mksysb/LPAR4p5/LPAR4_mksysb -j
rootvg -N LPAR4_p5_mksysb -Y
Tue Jun 6 11:41:38 2006 OUTPUT (/usr/sbin/nimadm): Initializing the NIM
master.
Tue Jun 6 11:41:42 2006 OUTPUT (/usr/sbin/nimadm): Verifying
alt_disk_migration eligibility.
Tue Jun 6 11:41:42 2006 OUTPUT (/usr/sbin/nimadm): Initializing log:
/var/adm/ras/alt_mig/LPAR4_phys_mksysb_alt_mig.log
Tue Jun 6 11:41:42 2006 OUTPUT (/usr/sbin/nimadm): Starting Alternate Disk
Migration.
Tue Jun 6 11:41:42 2006 OUTPUT (/usr/sbin/nimadm):
Tue Jun 6 11:41:42 2006 OUTPUT (/usr/sbin/nimadm):
+-----+
Tue Jun 6 11:41:42 2006 OUTPUT (/usr/sbin/nimadm): Executing nimadm phase 1.
Tue Jun 6 11:41:42 2006 OUTPUT (/usr/sbin/nimadm):
+-----+
Tue Jun 6 11:41:42 2006 OUTPUT (/usr/sbin/nimadm): Processing target mksysb
resource "LPAR4_phys_mksysb".
Tue Jun 6 11:41:42 2006 OUTPUT (/usr/sbin/nimadm): Restoring /image.data from
mksysb image.
Tue Jun 6 11:41:42 2006 OUTPUT (/usr/sbin/nimadm):
Tue Jun 6 11:41:42 2006 OUTPUT (/usr/sbin/nimadm):
+-----+
Tue Jun 6 11:41:42 2006 OUTPUT (/usr/sbin/nimadm): Executing nimadm phase 2.
Tue Jun 6 11:41:42 2006 OUTPUT (/usr/sbin/nimadm):
+-----+
Tue Jun 6 11:41:42 2006 OUTPUT (/usr/sbin/nimadm): Creating nimadm cache file
systems on volume group rootvg.
Tue Jun 6 11:41:42 2006 OUTPUT (/usr/sbin/nimadm): Checking for initial
required migration space.
Tue Jun 6 11:41:42 2006 OUTPUT (/usr/sbin/nimadm): Creating cache file system
/LPAR4_phys_mksysb_mm_alt/alt_inst
Tue Jun 6 11:41:45 2006 OUTPUT (/usr/sbin/nimadm): Creating cache file system
/LPAR4_phys_mksysb_mm_alt/alt_inst/usr
Tue Jun 6 11:41:48 2006 OUTPUT (/usr/sbin/nimadm): Creating cache file system
/LPAR4_phys_mksysb_mm_alt/alt_inst/var
Tue Jun 6 11:41:50 2006 OUTPUT (/usr/sbin/nimadm): Creating cache file system
/LPAR4_phys_mksysb_mm_alt/alt_inst/tmp
Tue Jun 6 11:41:52 2006 OUTPUT (/usr/sbin/nimadm): Creating cache file system
/LPAR4_phys_mksysb_mm_alt/alt_inst/home
Tue Jun 6 11:41:54 2006 OUTPUT (/usr/sbin/nimadm): Creating cache file system
/LPAR4_phys_mksysb_mm_alt/alt_inst/opt
Tue Jun 6 11:41:56 2006 OUTPUT (/usr/sbin/nimadm):
Tue Jun 6 11:41:56 2006 OUTPUT (/usr/sbin/nimadm):
+-----+
Tue Jun 6 11:41:56 2006 OUTPUT (/usr/sbin/nimadm): Executing nimadm phase 3.
Tue Jun 6 11:41:56 2006 OUTPUT (/usr/sbin/nimadm):
+-----+

```

```

Tue Jun 6 11:41:56 2006 OUTPUT (/usr/sbin/nimadm): Syncing mksysb data to
cache ...
Tue Jun 6 11:47:05 2006 OUTPUT (/usr/sbin/nimadm):
Tue Jun 6 11:47:06 2006 OUTPUT (/usr/sbin/nimadm):
+-----+
Tue Jun 6 11:47:06 2006 OUTPUT (/usr/sbin/nimadm): Executing nimadm phase 4.
Tue Jun 6 11:47:06 2006 OUTPUT (/usr/sbin/nimadm):
+-----+
Tue Jun 6 11:47:06 2006 OUTPUT (/usr/sbin/nimadm): nimadm: There is no user
customization script specified for this phase.
Tue Jun 6 11:47:06 2006 OUTPUT (/usr/sbin/nimadm):
Tue Jun 6 11:47:06 2006 OUTPUT (/usr/sbin/nimadm):
+-----+
Tue Jun 6 11:47:06 2006 OUTPUT (/usr/sbin/nimadm): Executing nimadm phase 5.
Tue Jun 6 11:47:06 2006 OUTPUT (/usr/sbin/nimadm):
+-----+
Tue Jun 6 11:47:06 2006 OUTPUT (/usr/sbin/nimadm): Saving system configuration
files.
Tue Jun 6 11:47:41 2006 OUTPUT (/usr/sbin/nimadm): Checking for initial
required migration space.
Tue Jun 6 11:47:41 2006 OUTPUT (/usr/sbin/nimadm): Expanding
/LPAR4_phys_mksysb_mm_alt/alt_inst/usr local filesystem.
Tue Jun 6 11:47:52 2006 OUTPUT (/usr/sbin/nimadm): Filesystem size changed to
786432
Tue Jun 6 11:47:52 2006 OUTPUT (/usr/sbin/nimadm): Setting up for base
operating system restore.
Tue Jun 6 11:47:52 2006 OUTPUT (/usr/sbin/nimadm): Restoring base operating
system.
Tue Jun 6 11:48:19 2006 OUTPUT (/usr/sbin/nimadm): Merging system
configuration files.
Tue Jun 6 11:48:19 2006 OUTPUT (/usr/sbin/nimadm): Rebuilding inventory
database.
Tue Jun 6 11:48:27 2006 OUTPUT (/usr/sbin/nimadm): Running migration merge
method: ODM_merge Config_Rules.
Tue Jun 6 11:48:27 2006 OUTPUT (/usr/sbin/nimadm): Running migration merge
method: ODM_merge SRCextmeth.
Tue Jun 6 11:48:27 2006 OUTPUT (/usr/sbin/nimadm): Running migration merge
method: ODM_merge SRCsubsys.
Tue Jun 6 11:48:28 2006 OUTPUT (/usr/sbin/nimadm): Running migration merge
method: ODM_merge SWservAt.
Tue Jun 6 11:48:28 2006 OUTPUT (/usr/sbin/nimadm): Running migration merge
method: ODM_merge pse.conf.
Tue Jun 6 11:48:29 2006 OUTPUT (/usr/sbin/nimadm): Running migration merge
method: ODM_merge xtiso.conf.
Tue Jun 6 11:48:30 2006 OUTPUT (/usr/sbin/nimadm): Running migration merge
method: ODM_merge PdDv.
Tue Jun 6 11:48:30 2006 OUTPUT (/usr/sbin/nimadm): Running migration merge
method: convert_errnotify.

```

```

Tue Jun 6 11:48:30 2006 OUTPUT (/usr/sbin/nimadm): Running migration merge
method: passwd_mig.
Tue Jun 6 11:48:30 2006 OUTPUT (/usr/sbin/nimadm): Running migration merge
method: login_mig.
Tue Jun 6 11:48:30 2006 OUTPUT (/usr/sbin/nimadm): Running migration merge
method: user_mrg.
Tue Jun 6 11:48:30 2006 OUTPUT (/usr/sbin/nimadm): Running migration merge
method: secur_mig.
Tue Jun 6 11:48:31 2006 OUTPUT (/usr/sbin/nimadm): Running migration merge
method: mkusr_mig.
Tue Jun 6 11:48:31 2006 OUTPUT (/usr/sbin/nimadm): Running migration merge
method: group_mig.
Tue Jun 6 11:48:31 2006 OUTPUT (/usr/sbin/nimadm): Running migration merge
method: ldapcfg_mig.
Tue Jun 6 11:48:31 2006 OUTPUT (/usr/sbin/nimadm): Running migration merge
method: convert_errlog.
Tue Jun 6 11:48:31 2006 OUTPUT (/usr/sbin/nimadm): Running migration merge
method: ODM_merge GAI.
Tue Jun 6 11:48:31 2006 OUTPUT (/usr/sbin/nimadm): Running migration merge
method: ODM_merge PdAt.
Tue Jun 6 11:48:32 2006 OUTPUT (/usr/sbin/nimadm): Running migration merge
method: merge_smit_db.
Tue Jun 6 11:48:32 2006 OUTPUT (/usr/sbin/nimadm): Running migration merge
method: ODM_merge fix.
Tue Jun 6 11:48:33 2006 OUTPUT (/usr/sbin/nimadm): Running migration merge
method: merge_swvpsds.
Tue Jun 6 11:48:38 2006 OUTPUT (/usr/sbin/nimadm): Running migration merge
method: SysckMerge.
Tue Jun 6 11:48:42 2006 OUTPUT (/usr/sbin/nimadm):
Tue Jun 6 11:48:42 2006 OUTPUT (/usr/sbin/nimadm):
+-----+
Tue Jun 6 11:48:42 2006 OUTPUT (/usr/sbin/nimadm): Executing nimadm phase 6.
Tue Jun 6 11:48:42 2006 OUTPUT (/usr/sbin/nimadm):
+-----+
Tue Jun 6 11:48:42 2006 OUTPUT (/usr/sbin/nimadm): Installing and migrating
software.
Tue Jun 6 11:48:47 2006 OUTPUT (/usr/sbin/nimadm): Updating install utilities.
Tue Jun 6 11:48:47 2006 OUTPUT (/usr/sbin/nimadm):
+-----+
+-----+
Tue Jun 6 12:23:07 2006 OUTPUT (/usr/sbin/nimadm): Executing nimadm phase 11.
Tue Jun 6 12:23:07 2006 OUTPUT (/usr/sbin/nimadm):
+-----+
Tue Jun 6 12:23:07 2006 OUTPUT (/usr/sbin/nimadm): Defining NIM mksysb
resource ...
Tue Jun 6 12:23:08 2006 OUTPUT (/usr/sbin/nimadm): New NIM mksysb resource
name is "LPAR4_p5_mksysb"
Tue Jun 6 12:23:08 2006 OUTPUT (/usr/sbin/nimadm):

```

```

Tue Jun 6 12:23:08 2006 OUTPUT (/usr/sbin/nimadm):
+-----+
Tue Jun 6 12:23:08 2006 OUTPUT (/usr/sbin/nimadm): Executing nimadm phase 12.
Tue Jun 6 12:23:08 2006 OUTPUT (/usr/sbin/nimadm):
+-----+
Tue Jun 6 12:23:08 2006 OUTPUT (/usr/sbin/nimadm): Cleaning up
alt_disk_migration on the NIM master.
Tue Jun 6 12:23:08 2006 rc for /usr/sbin/nimadm = 0
Tue Jun 6 12:23:08 2006 STATUS for phase 6: success

```

---

This phase migrates the client mksysb images to AIX 5L V5.3 using the `nimadm` utility.

**Note:** The `nimadm` log files are located in `/var/adm/ras/nimadm.log` and the `/var/adm/ras/alt_mig/` directory.

## 12. Phase 7 - Configure NIM definitions for client LPARs.

We run the `nim_move_up -S` command again to review what the next phase will be; see Example 4-144. In phase 7, new NIM objects are created for each LPAR. The necessary NIM resources are allocated and a `bos_inst` pull operation is run on each client.

### Example 4-144 Configuring NIM definitions for clients

---

```

{nimmast}:/ # nim_move_up -S
nim_move_up Status:
=====
Tue Jun 6 13:11:03 2006

```

Next phase to execute: 7 - Configure NIM Definitions of Client LPARs

```

Saved parameters:
 accept_licenses = yes
 images = /moveup/AIX5304
 hmc = hmcp520
 location = /moveup
 gateway = 10.1.1.1
 managed_sys = YLI894-2-650E4DG
 subnet_mask = 255.255.255.0
 spot = SPOT_53_ML4
 lpp_source = LPP_53_ML4
 vioserver = VI01
 target_client = LPAR4
 min_ip = 10.1.1.65

```

---

Phase 7 executes and creates NIM client definitions for the target system. A new NIM client was created named LPAR4\_p5, as shown in Example 4-145 on page 254.

*Example 4-145 Phase 7 execution and creation of NIM client definitions*

---

```
{nimmast}:/ # nim_move_up -n
Tue Jun 6 13:12:10 2006 Starting Phase 7 : Configure NIM Definitions of Client
LPARs...
Tue Jun 6 13:12:10 2006 Adding the following entry into /etc/hosts: LPAR4_p5
10.1.1.65
Tue Jun 6 13:12:10 2006 Executing: /usr/sbin/nim -o define -t standalone -a
if1="find_net LPAR4_p5 0" LPAR4_p5
Tue Jun 6 13:12:20 2006 rc for /usr/sbin/nim = 0
Tue Jun 6 13:12:20 2006 Executing: /usr/sbin/nim -o bos_inst -a source=mksysb
-a mksysb=LPAR4_p5_mksysb -a spot=SPOT_53_ML4 -a bosinst_data=nim_move_up_bid
-a boot_client=no LPAR4_p5
Tue Jun 6 13:12:23 2006 rc for /usr/sbin/nim = 0
Tue Jun 6 13:12:23 2006 STATUS for phase 7: success
```

---

**Note:** If you do not update your /etc/hosts file with the new system's hostname and IP address, nim\_move\_up will do this for you; see Figure 4-7.



```

#####
##
PARTITIONS VICO
##
#####

10.1.1.11 lpar1
10.1.1.12 lpar2
10.1.1.13 lpar3
10.1.1.14 lpar4
10.1.1.15 lpar5
10.1.1.16 lpar6
10.1.1.17 lpar7
10.1.1.18 lpar8
10.1.1.50 hmcp520
10.1.1.51 VI01
10.1.1.61 vlpar1
10.1.1.62 vlpar2
10.1.1.63 vlpar3
10.1.1.64 vlpar4

9.212.133.42 alp3bfs

9.212.133.57 nimmstbfs nimmast
10.1.1.65 LPAR4_p5

```

Figure 4-7 *nim\_move\_up* has updated our */etc/hosts*

### 13. Phase 8 - Initiate LPAR network installation.

Now it is time for us to install the new POWER5 LPARs, as shown in Example 4-146.

#### Example 4-146 *Initiating LPAR network installations*

```

{nimmast}:/ # nim_move_up -S
nim_move_up Status:
=====
Tue Jun 6 13:12:45 2006

```

Next phase to execute: 8 - Initiate LPAR Network Installations

```

Saved parameters:
accept_licenses = yes
images = /moveup/AIX5304
hmc = hmcp520
location = /moveup
gateway = 10.1.1.1

```

```
managed_sys = YLI894-2-650E4DG
subnet_mask = 255.255.255.0
spot = SPOT_53_ML4
lpp_source = LPP_53_ML4
vioserver = VI01
target_client = LPAR4
min_ip = 10.1.1.65
```

---

Example 4-147 shows the status of our new NIM client. You can see from its current state that it is now ready for a BOS installation via a mksysb (named LPAR4\_p5\_mksysb).

*Example 4-147 Showing the status of our new NIM client*

---

```
{nimmast}:/ # lsrim -l LPAR4_p5
LPAR4_p5:
 class = machines
 type = standalone
 connect = shell
 platform = chrp
 netboot_kernel = mp
 if1 = NET_EN1 LPAR4_p5 0
 cable_type1 = N/A
 Cstate = BOS installation has been enabled
 prev_state = ready for a NIM operation
 Mstate = not running
 boot = boot
 bosinst_data = nim_move_up_bid
 mksysb = LPAR4_p5_mksysb
 nim_script = nim_script
 spot = SPOT_53_ML4
 control = master
```

---

The LPAR network installation is initiated (via the `/usr/hmcrcbin/lpar_netboot` command on the HMC) as shown in Example 4-148. After the installation has begun, this phase is complete.

Note that the installation is not monitored by `nim_move_up`. We monitored the installation (by observing the output on the LPARs console and using the `lsrim` command) to ensure that the installation completed successfully.

*Example 4-148 LPAR network installation initiated*

---

```
{nimmast}:/ # nim_move_up -n
Tue Jun 6 13:23:50 2006 Starting Phase 8 : Initiate LPAR Network
Installations...
Tue Jun 6 13:23:50 2006 Executing: /usr/bin/ssh -l hscroot hmcp520
"lpar_netboot -A -D -t ent -s auto -d auto -S 10.1.1.1 -C 10.1.1.65 -G 10.1.1.1
\"LPAR4_lpar\" \"LPAR4_profile\" \"YLI894-2-650E4DG\""
```

```

Tue Jun 6 13:23:54 2006 OUTPUT (/usr/bin/ssh): # Connecting to LPAR4_lpar
Tue Jun 6 13:23:54 2006 OUTPUT (/usr/bin/ssh): # Connected
Tue Jun 6 13:23:54 2006 OUTPUT (/usr/bin/ssh): # Checking for power off.
Tue Jun 6 13:23:55 2006 OUTPUT (/usr/bin/ssh): # Power off complete.
Tue Jun 6 13:23:55 2006 OUTPUT (/usr/bin/ssh): # Power on LPAR4_lpar to Open
Firmware.
Tue Jun 6 13:25:59 2006 OUTPUT (/usr/bin/ssh): # Power on complete.
Tue Jun 6 13:26:01 2006 OUTPUT (/usr/bin/ssh): # Client IP address is
10.1.1.65.
Tue Jun 6 13:26:01 2006 OUTPUT (/usr/bin/ssh): # Server IP address is
10.1.1.1.
Tue Jun 6 13:26:01 2006 OUTPUT (/usr/bin/ssh): # Gateway IP address is
10.1.1.1.
Tue Jun 6 13:27:16 2006 OUTPUT (/usr/bin/ssh): # /vdevice/l-lan@30000003 ping
successful.
Tue Jun 6 13:27:17 2006 OUTPUT (/usr/bin/ssh): # Network booting install
adapter.
Tue Jun 6 13:27:19 2006 OUTPUT (/usr/bin/ssh): # bootp sent over network.
Tue Jun 6 13:31:47 2006 OUTPUT (/usr/bin/ssh): # Network boot proceeding,
lpar_netboot is exiting.
Tue Jun 6 13:31:47 2006 OUTPUT (/usr/bin/ssh): # Finished.
Tue Jun 6 13:31:47 2006 rc for /usr/bin/ssh = 0
Tue Jun 6 13:31:47 2006 STATUS for phase 8: success

```

---

#### 14. Phase 9 - Post-migration.

Before executing Phase 9, make sure that the installation that was initiated in Phase 8 has completed successfully. If you try to execute the next phase before the installation is complete, you will receive an error message stating that the NIM client has not finished installing, as shown in Example 4-149. Use the `lsnim` command to check the client status. When the installation is finished, its Cstate will show: ready for a NIM operation.

##### *Example 4-149 Error message if phase 8 has not completed*

```

{nimmast}:/ # nim_move_up -n
Tue Jun 6 13:34:08 2006 Starting Phase 9 : post-migration...
Tue Jun 6 13:34:08 2006 ERROR: The NIM client LPAR4_p5 has not finished
installing. Try again later.
Tue Jun 6 13:34:08 2006 STATUS for phase 9: failure

```

---

Now that our LPAR has been successfully installed, we are ready to move into Phase 9; refer to Example 4-150.

##### *Example 4-150 Executing phase 9*

```

{nimmast}:/ # nim_move_up -S
nim_move_up Status:
=====

```

Tue Jun 6 13:32:36 2006

Next phase to execute: 9 - post-migration

Saved parameters:

```
accept_licenses = yes
images = /moveup/AIX5304
hmc = hmcp520
location = /moveup
gateway = 10.1.1.1
managed_sys = YLI894-2-650E4DG
subnet_mask = 255.255.255.0
spot = SPOT_53_ML4
lpp_source = LPP_53_ML4
vioserver = VI01
target_client = LPAR4
min_ip = 10.1.1.65
```

---

The `post_migration` script is run on LPAR4\_p5 as shown in Example 4-151. This script runs a commands such as **lppchk** to verify the installed filesets. The output from the `post_migration` script is saved to `/home` and should be reviewed after the migration completes.

*Example 4-151 Post migration script execution*

---

```
{nimmast}:/ # nim_move_up -n
Tue Jun 6 14:04:33 2006 Starting Phase 9 : post-migration...
Tue Jun 6 14:04:33 2006 Running post_migration on client LPAR4_p5
Tue Jun 6 14:04:33 2006 Executing: /usr/lpp/bos.sysmgt/nim/methods/c_rsh
LPAR4_p5 /usr/lpp/bos/post_migration
Tue Jun 6 14:04:33 2006 OUTPUT (/usr/lpp/bos.sysmgt/nim/methods/c_rsh):
Tue Jun 6 14:04:33 2006 OUTPUT (/usr/lpp/bos.sysmgt/nim/methods/c_rsh):
Running lppchk commands. This may take awhile.
Tue Jun 6 14:11:20 2006 OUTPUT (/usr/lpp/bos.sysmgt/nim/methods/c_rsh):
Tue Jun 6 14:11:20 2006 OUTPUT (/usr/lpp/bos.sysmgt/nim/methods/c_rsh): All
saved information can be found in: /home/post_migration.060606140432
Tue Jun 6 14:11:20 2006 OUTPUT (/usr/lpp/bos.sysmgt/nim/methods/c_rsh):
Tue Jun 6 14:11:20 2006 rc for /usr/lpp/bos.sysmgt/nim/methods/c_rsh = 0
Tue Jun 6 14:11:20 2006 STATUS for phase 9: success
```

---

## 15. Phase 10 - Post-installation customization.

This phase is optional. It allows for the installation of additional software (LPPs/filesets) or for any additional customization (using a script) that may be needed. We did not perform any customization on the client; refer to Example 4-152 on page 259.

*Example 4-152 Post-installation and customization phase (optional)*

---

```
{nimmast}:/ # nim_move_up -n
Tue Jun 6 14:16:05 2006 Starting Phase 10 : Post-Installation Customization
(Optional)...
Tue Jun 6 14:16:05 2006 No customization resources provided- skipping
customization.
Tue Jun 6 14:16:05 2006 STATUS for phase 10: success
```

---

All phases have now been executed. Our **nim\_move\_up** operation has completed each phase successfully. All that is left to do is unconfigure the environment in preparation for any future operations we may need to execute. This step is shown in Example 4-153.

*Example 4-153 Unconfiguring and saving the environment parameters*

---

```
{nimmast}:/ # nim_move_up -S
nim_move_up Status:
=====
Tue Jun 6 14:16:25 2006
All phases have executed.

Saved parameters:
 accept_licenses = yes
 images = /moveup/AIX5304
 hmc = hmcp520
 location = /moveup
 gateway = 10.1.1.1
 managed_sys = YLI894-2-650E4DG
 subnet_mask = 255.255.255.0
 spot = SPOT_53_ML4
 lpp_source = LPP_53_ML4
 vioserver = VI01
 target_client = LPAR4
 min_ip = 10.1.1.65
```

```
{nimmast}:/ # nim_move_up -n
```

All phases have been executed. Run **nim\_move\_up -r** to clear **nim\_move\_up** data.

```
{nimmast}:/ # nim_move_up -r
Reset of nim_move_up environment completed successfully.
```

---

Our goal has been achieved. We have migrated our AIX 5L V5.1 p670 LPAR to an AIX 5L V5.3 p520 LPAR (see Figure 4-8 on page 260). Although we invested a significant amount of time reviewing each phase of the **nim\_move\_up** operation, the actual time and labor required was minimal when compared to previous platform migration methods.

```

prtconf | head
System Model: IBM,7040-671
Machine Serial Number: 01A85D2
Processor Type: PowerPC_POWER4
Number Of Processors: 2
Processor Clock Speed: 1000 MHz
CPU Type: 64-bit
Kernel Type: 32-bit
LPAR Info: 4 lpar4
Memory Size: 1024 MB
Good Memory Size: 1024 MB

oslevel -r
5100-04

prtconf | head
System Model: IBM,9131-52A
Machine Serial Number: 650E4DG
Processor Type: PowerPC_POWER5
Number Of Processors: 1
Processor Clock Speed: 1499 MHz
CPU Type: 64-bit
Kernel Type: 64-bit
LPAR Info: 1 LPAR4_lpar
Memory Size: 448 MB
Good Memory Size: 448 MB

oslevel -r
5300-04

```

Figure 4-8 Hardware configuration after `nim_move_up` operation

## 4.5.5 POWER5-to-POWER5 `nim_move_up`

It is possible to use the `nim_move_up` tool to move an existing POWER5 LPAR running AIX 5L V5.3 to another POWER5 system. At the time of writing, we needed to move AIX 5L V5.3 LPARs from one POWER5 system to another. We were able to use `nim_move_up` for this task by making some minor changes to phase 6.

Because our clients were already running AIX 5L V5.3, it was not necessary to migrate to AIX 5L V5.3 with `nim_move_up` (the migration is performed in phase 6). For example, we moved an LPAR (VLPAR1) from one p520 to another p520. In order for us to move our LPARs without performing phase 6, however, we needed to make the following changes immediately after phase 5:

1. We ensured that the string within the phase6/status file was set to: success.

2. We changed the phase number in the `current_phase` file to: 7.
3. We copied the `mksysb` image `VLPAR1_mksysb` to `VLPAR1_p5_mksysb` (which is the name of the `mksysb` image that `nim_move_up` would have created after the migration and is required for phase 7).

Executing these changes allowed us to skip phase 6, continue with the remaining phases (for example, 7, 8, 9 and 10), and move VLPAR1 to our new p520 to a new LPAR named `VLPAR1_p5`.

## 4.6 NIM alternate disk migration

In this section, we describe the Network Installation Manager (NIM) alternate disk migration (`nimadm`) tool and show an example of how to use it to perform an AIX migration to AIX 5L V5.3.

The NIM alternate disk migration (`nimadm`) utility offers several advantages for migrating to a later level of AIX, over a conventional migration. For example, a system administrator can use `nimadm` to create a copy of a client's rootvg to a spare disk on the client (similar to a standard alternate disk install with `alt_disk_install`) and migrate the disk to a newer version or release of AIX. All of this can be done without disruption to the client (for example, there are no outages required to perform the upgrade). After the upgrade is finished, the only downtime required will be a scheduled reboot of the system.

There are several benefits to using `nimadm` over a standard NIM migration, such as:

- ▶ Reduced downtime for the client. The migration is executed while the system is up and running as normal. There is no disruption to any of the applications or services running on the client; therefore, the upgrade can be done at a time convenient to the administrator. At a later stage, a reboot can be scheduled in order to restart the system at the later level of AIX.
- ▶ The `nimadm` process is very flexible and it can be customized using some of the optional NIM customization resources such `image_data`, `bosinst_data`, `pre/post_migration` scripts, `exclude_files`, and so on.
- ▶ Quick recovery from migration failures. All changes are performed on the rootvg copy (`altinst_rootvg`). If there are any serious problems with the migration, the original rootvg is still available and the system has not been impacted. If a migration fails or terminates at any stage, `nimadm` is able to quickly recover from the event and clean up afterwards. There is little for the administrator to do except determine why the migration failed, rectify the situation, and attempt the `nimadm` process again. If the migration process completed but issues were discovered after the system was restarted on the

later level of AIX, then the administrator can back out easily by booting from the original rootvg disk.

The following requirements must be met before attempting to use `nimadm`:

1. You must have a NIM master running AIX 5L V5.1 or higher with the latest recommended AIX 5L maintenance/Technology Level or higher.
2. The NIM master must have the `bos.alt_disk_install.rte` fileset installed in its own rootvg and in the SPOT which will be used for the migration. Both need to be at the same level.

**Note:** It is not necessary to install the alternate disk utilities on the client.

3. The `lpp_source` and SPOT NIM resources that have been selected for the migration MUST match the AIX level to which you are migrating.
4. The NIM master (as always) should be at the same or higher AIX level than the level you are migrating to on the client.
5. The client system to be migrated must be at AIX 4.3.3 or higher.
6. The client must have disks large enough to clone the existing rootvg, plus an additional 500 MB of free space for the migration. This amount will depend on the client system configuration.
7. The target client must be registered with the NIM master as a standalone NIM client.
8. The NIM master must be able to execute remote commands (`rsh`) on the client using the `rshd` protocol.
9. The NIM master and client must have a minimum of 128 MB of RAM.
10. A reliable network connection between the master and client is required. A large amount of NFS and `rsh` traffic will occur, because the master and client will perform NFS mounts and read/write operations during the migration.
11. The client's hardware and software should support the AIX level that is being migrated to and meet the requirements of a conventional migration.

Some limitations apply when using the `nimadm` utility:

1. If the client's rootvg has TCB turned on, you will need to either disable it (permanently) or perform a conventional migration (for example, using CD or NIM; refer to 4.4, "Using NIM to perform AIX migrations of NIM master and clients" on page 151 for more information about this topic. This limitation exists because TCB needs to access file metadata that is not visible over NFS.
2. All NIM resources used by `nimadm` must be local to the NIM master.



3. The client may experience a minor performance decrease due to the increase in disk I/O and NFS activity, accompanied by some additional CPU usage from the `alt_disk_install` cloning.
4. NFS tuning may be required to optimize `nimadm` performance, especially on slow networks.
5. If configuration changes are made to the system after `rootvg` has been cloned, then you will need to either redo the `alt_disk_install` phase of the `nimadm` operation, or implement them manually or via a customization script after the migration.

For example, if new users are created or system tuning options are changed after the `alt_disk_install` is run, then you will need to ensure that these changes are performed after the migration is complete, such as user-related (`/etc/passwd`, `/etc/group`, `/etc/security/passwd`, and so on), and system tuning-related (such as `/etc/tunables/nextboot`).

### 4.6.1 Local disk caching versus NFS

Before we look at an example of using `nimadm`, there is one last feature we should point out. As already mentioned, `nimadm` uses NFS for many of the tasks during the migration. This can be a problem on slower networks because NFS writes can be very expensive. To avoid using NFS, a Local Disk Caching option exists which may provide some performance advantages.

Local disk caching allows the NIM master to avoid having to use NFS to write to the client. This can be useful if the `nimadm` operation is not performing well due to an NFS write bottleneck. If the Local Disk Caching function is invoked, then `nimadm` will create the client file systems in a volume group on the NIM master. It will then use streams (via `rshd`) to cache all of the data from the client to the file systems on the NIM master.

Advantages of local disk caching include the following:

1. Improved performance for `nimadm` operations on relatively slow networks.
2. Improved performance for `nimadm` operations that are bottlenecked in NFS writes.
3. Decreased CPU usage on the client.
4. Client file systems not exported.

Disadvantages of local disk caching include the following:

1. Cache file systems take up space on the NIM master. You must have enough disk space in a volume group on the NIM master to host the client's `rootvg` file systems, plus some space for the migration of each client.
2. Increased CPU usage on the master.

3. Increased I/O on the master. For best performance, use a volume group on the NIM master that does not contain the NIM resources being used for the AIX migration.

In our case, we deploy Local Disk Caching in our `nimadm` test environment, as described in the following sections.

## 4.6.2 The 12 phases of `nimadm` migration

The `nimadm` command performs a migration in 12 phases. It is useful to have a good understanding of the `nimadm` process before performing a migration. Each phase can be executed individually using the `-P` flag. This can be useful if you are trying to pinpoint a problem with the process (for example, you can run each phase and analyze the result before moving onto the next step).

The `nimadm` phases are as follows:

- ▶ **Phase 1.** The master issues the `alt_disk_install` command to the client, which makes a copy of the rootvg to the target disks (this is Phase 1 of the `alt_disk_install` process). In this phase, `altinst_rootvg` (alternate rootvg) is created. If a target `mksysb` has been specified, the `mksysb` is used to create a rootvg using local disk caching on the NIM master.
- ▶ **Phase 2.** The master runs remote client commands to export all of the `/alt_inst` file systems to the master. The file systems are exported as read/write with root access to the master.
- ▶ **Phase 3.** The master NFS mounts the file systems exported in Phase 2. If a target `mksysb` has been specified, the `mksysb` archive is restored into the cache file systems created in Phase 2.
- ▶ **Phase 4.** If a premigration script resource has been specified, it is executed at this time.
- ▶ **Phase 5.** System configuration files are saved. Initial migration space is calculated and appropriate file system expansions are made. The `bos` image is restored and the device database is merged (similar to a conventional migration). All of the migration merge methods are executed, and some miscellaneous processing takes place.
- ▶ **Phase 6.** All system filesets are migrated using `installp`. Any required RPM images are also installed during this phase.
- ▶ **Phase 7.** If a post-migration script resource has been specified, it is executed at this time.
- ▶ **Phase 8.** The `bosboot` command is run to create a client boot image, which is written to the client's alternate boot logical volume (`alt_hd5`).
- ▶ **Phase 9.** All mounts made on the master in phase 3 are removed<sup>1</sup>.

- ▶ **Phase 10.** All client exports created in phase 2 are removed<sup>2</sup>.
- ▶ **Phase 11.** The `alt_disk_install` command is called again (phase 3 of `alt_disk_install`) to make final adjustments and put `altinst_rootvg` to sleep. The `bootlist` is set to the target disk (unless the `-B` flag is used). If an output `mksysb` has been specified, the cache is archived into a `mksysb` file, and a NIM `mksysb` resource created.
- ▶ **Phase 12.** Cleanup is executed to end the migration. The client is rebooted, if the `-r` flag is specified.

If you are unable to meet the requirements for phases 1 to 10, then you will need to perform a conventional migration; refer to 4.4, “Using NIM to perform AIX migrations of NIM master and clients” on page 151 for more information.

**Tip:** The `nimadm` command supports migrating several clients at the same time.

### 4.6.3 Example `nimadm` migration

Example 4-154 demonstrates a typical NIM alternate disk migration. We will migrate a system from AIX 5L V5.2 to AIX 5L V5.3. This environment consists of a NIM master running AIX 5L V5.3 on a p615, and a NIM client running AIX 5L V5.2 as an LPAR on a p670. Our NIM client name is LPAR4 and the NIM master hostname is `nimmast`.

First, we check that our NIM master and client are ready to take part in a `nimadm` operation.

NIM master checklist:

- ▶ Ensure that the `bos.alt_disk_install.rte` fileset is installed on the NIM master, and also in the SPOT that will be used for this migration.

#### *Example 4-154 Alternate disk migration example*

```
{nimmast}:/ # lsllpp -l bos.alt_disk_install.rte
 Fileset Level State Description

```

<sup>1</sup> When using the Local Disk Caching option with `nimadm`, the following phases are modified (all other phases remain the same):

Phase 2 - The NIM master creates local cache file systems in the specified target volume group (on the NIM master).

Phase 3 - The NIM master populates the cache file systems with the client's `rootvg` data.

Phase 9 - The NIM master writes all the migrated data to the client's alternate `rootvg`.

Phase 10 - The NIM master cleans up and removes the local cache file systems.

<sup>2</sup> See footnote1.

```
bos.alt_disk_install.rte 5.3.0.40 COMMITTED Alternate Disk Installation
Runtime
```

```
{nimmast}:/ # nim -o lspp -a filesets='bos.alt_disk_install.rte' SPOT_53_ML4
Fileset Level State Description

Path: /usr/lib/objrepos
bos.alt_disk_install.rte 5.3.0.30 COMMITTED Alternate Disk Installation
Runtime
 5.3.0.40 APPLIED Alternate Disk Installation
Runtime
```

---

Example 4-155 shows you how to install the bos.alt\* filesets into the SPOT.

*Example 4-155 Installing bos.alt\_disk\_install filesets into the SPOT*

---

```
{nimmast}:/ # smit nim_task_inst
Install and Update from ALL Available Software
SPOT_53_ML4 resources spot
LPP_53_ML4 resources lpp_source
Install and Update from ALL Available Software

* Installation Target SPOT_53_ML4
* LPP_SOURCE LPP_53_ML4
* Software to Install [bos.alt_disk_install+

Customization SCRIPT to run after installation [] +
(not applicable to SPOTs)

Force no +

installp Flags
PREVIEW only? [no] +
COMMIT software updates? [yes] +
SAVE replaced files? [no] +
AUTOMATICALLY install requisite software? [yes] +
EXTEND filesystems if space needed? [yes] +
OVERWRITE same or newer versions? [no] +

COMMAND STATUS

Command: OK stdout: yes stderr: no

Before command completion, additional instructions may appear below.

[TOP]
```

Installing filesets ...

Be sure to check the output from the SPOT installation to verify that all the expected software was successfully installed. You can use the NIM "showlog" operation to view the installation log file for the SPOT.

```
+-----+
 Pre-installation Verification...
+-----+
Verifying selections...done
Verifying requisites...done
Results...

SUCSESSES

Filesets listed in this section passed pre-installation verification
and will be installed.

Selected Filesets

bos.alt_disk_install.boot_images 5.2.0.40 # Alternate Disk Installation ...
bos.alt_disk_install.rte 5.2.0.40 # Alternate Disk Installation ...

<< End of Success Section >>

FILESET STATISTICS

 2 Selected to be installed, of which:
 2 Passed pre-installation verification

[MORE...39]
```

---

### ***NIM client check list***

- ▶ Is the client at AIX 4.3.3 or higher?
- ▶ Does the client have a disk large enough to clone the existing rootvg plus ~500MB of free space for the migration?

If your rootvg is mirrored, consider breaking the mirror and using one of the disks for the alternate rootvg. In a SAN environment, consider allocating a LUN temporarily for the nimadm operation and removing it afterwards.

```
lspv
hdisk0 001a85d27c3dc850 rootvg active
hdisk1 001a071f9a12dbaf None
```

- ▶ There is no need to install the `alt_disk_install` filesets on the client because the `alt_disk_install` command, which will be run on the client, will be executed from the SPOT that is mounted from the NIM master.
- ▶ Is the client already registered with the NIM master as a valid NIM client? If not, the `niminit` command can be used to configure it from the client side.
- ▶ Can the master execute commands on the client? In our case, yes.

```
{nimmast}:/ # rsh lpar4 oslevel -r
5200-04
```

The `~/.rhosts` file must exist on the client so that it allows the NIM master remote root access. The correct ownership and permissions must also be set; for example:

```
{nimmast}:/ # rsh lpar4 cat /.rhosts
nimmast root
{nimmast}:/ # rsh lpar4 ls -l /.rhosts
-rw----- 1 root system 13 Jun 05 14:56 /.rhosts
```

Is the client TCB enabled? If it is enabled, then you have two choices:

- You can perform a conventional migration, which supports systems with TCB enabled.
- You can disable TCB *permanently*.

**Important:** Be aware that if you try to enable TCB again after the migration, you may encounter problems with files being deactivated, which may raise havoc with your running system.

Disabling TCB can be accomplished following the procedure shown in Example 4-156:

*Example 4-156 Disabling TCB permanently*

---

```
odmget -q attribute=TCB_STATE PdAt > /tmp/odmout
cd /tmp
cat odmout
PdAt:
 uniquetype = ""
 attribute = "TCB_STATE"
 deflt = "tcb_enabled"
 values = ""
 width = ""
 type = ""
 generic = ""
 rep = ""
 nls_index = 0
```

```

vi odmout
PdAt:
 uniquetype = ""
 attribute = "TCB_STATE"
 deflt = "tcb_disabled"
 values = ""
 width = ""
 type = ""
 generic = ""
 rep = ""
 nls_index = 0

odmdelete -o PdAt -q attribute=TCB_STATE
0518-307 odmdelete: 1 objects deleted.

odmget -q attribute=TCB_STATE PdAt
odmadd /tmp/odmout
odmget -q attribute=TCB_STATE PdAt

PdAt:
 uniquetype = ""
 attribute = "TCB_STATE"
 deflt = "tcb_disabled"
 values = ""
 width = ""
 type = ""
 generic = ""
 rep = ""
 nls_index = 0

```

---

**Note:** If you do not disable TCB, the `nimadm` process will terminate and will not perform the migration as shown in Example 4-157.

---

*Example 4-157 Message if TCB is not disabled*

```

{nimmast}:/ # nimadm -j nimvg -c LPAR4 -s SPOT_53_ML4 -l LPP_53_ML4 -d "hdisk1"
-Y
Initializing the NIM master.
Initializing NIM client lpar4.
Verifying alt_disk_migration eligibility.
0505-193 nimadm: The client, lpar4, is TCB enabled.
You must either disable TCB or perform a conventional migration.
Cleaning up alt_disk_migration on the NIM master.

```

---

In our test environment, we attempted the procedure, and then re-enabled TCB after a migration as a test only. The results are shown in Example 4-158

on page 270. It appears obvious that attempting to enable TCB again after a migration will damage your system.

**Note:** As mentioned, there is an option to perform a conventional migration, which supports systems with TCB enabled.

*Example 4-158 tcbck after a migration*

---

```
; Check all the files in the TCB database.
tcbck -y ALL
; Check is OK.
; Migrate to AIX 5.3
; After migration attempt to enable TCB.
odmget -q attribute=TCB_STATE PdAt > /tmp/odmout
cd /tmp
cat odmout
PdAt:
 uniquetype = ""
 attribute = "TCB_STATE"
 deflt = "tcb_disabled"
 values = ""
 width = ""
 type = ""
 generic = ""
 rep = ""
 nls_index = 0

vi odmout
PdAt:
 uniquetype = ""
 attribute = "TCB_STATE"
 deflt = "tcb_enabled"
 values = ""
 width = ""
 type = ""
 generic = ""
 rep = ""
 nls_index = 0

odmdelete -o PdAt -q attribute=TCB_STATE
0518-307 odmdelete: 1 objects deleted.

odmget -q attribute=TCB_STATE PdAt
odmadd /tmp/odmout
odmget -q attribute=TCB_STATE PdAt

PdAt:
 uniquetype = ""
```



```

attribute = "TCB_STATE"
deflt = "tcb_enabled"
values = ""
width = ""
type = ""
generic = ""
rep = ""
nls_index = 0

; Check all the files in the TCB database.
tcbck -y ALL
3001-023 The file /usr/sbin/mirscan has the wrong file mode.
3001-028 The file /usr/sbin/mirscan has the wrong checksum value.
3001-049 The file /usr/sbin/mirscan has the wrong file size.
3001-023 The file /usr/sbin/mklvcopy has the wrong file mode.
3001-028 The file /usr/sbin/mklvcopy has the wrong checksum value.
3001-049 The file /usr/sbin/mklvcopy has the wrong file size.
.....
; Lot's of tcbck errors are reported.
; Now a lot of system commands no longer function.
lspv
ksh: lspv: 0403-006 Execute permission denied.
; Permissions on lot's of files/commands have changed. For example:
----- 1 root system 26538 Aug 25 2005 varyonvg
----- 1 root system 27744 Aug 25 2005 lspv
----- 1 root system 10216 Aug 25 2005 lchangelv
----- 1 root system 13506 Aug 25 2005 lresynclv
----- 1 root system 19070 Aug 25 2005 lchangevg
----- 1 root system 38796 Aug 28 2005 mklv
----- 1 root system 14418 Sep 01 2005 lscons
----- 1 root system 113686 Sep 01 2005 restbyname
----- 1 root system 15720 Sep 01 2005 swcons
; A mksysb restore may be required to resolve this situation.

```

---

We are now ready to migrate our client from AIX 5L V5.2 ML4 to AIX 5L V5.3 TL4. Our **nimadm** operation will be performed as shown in Example 4-159.

*Example 4-159 nimadm operation*

---

```

{nimmast}:/ # smit nimadm
Perform NIM Alternate Disk Migration

* Target NIM Client [LPAR4] +
* NIM LPP_SOURCE resource [LPP_53_ML4] +
* NIM SPOT resource [SPOT_53_ML4] +
* Target Disk(s) to install [hdisk1]
 DISK CACHE volume group name [nimvg] +

NIM IMAGE_DATA resource [] +

```

|                                        |                            |
|----------------------------------------|----------------------------|
| NIM BOSINST_DATA resource              | <input type="checkbox"/> + |
| NIM EXCLUDE_FILES resource             | <input type="checkbox"/> + |
| NIM INSTALLP_BUNDLE resource           | <input type="checkbox"/> + |
| NIM PRE-MIGRATION SCRIPT resource      | <input type="checkbox"/> + |
| NIM POST-MIGRATION SCRIPT resource     | <input type="checkbox"/> + |
| Phase to execute                       | [all] +                    |
| NFS mounting options                   | <input type="checkbox"/>   |
| Set Client bootlist to alternate disk? | yes +                      |
| Reboot NIM Client when complete?       | no +                       |
| Verbose output?                        | no +                       |
| Debug output?                          | no +                       |
| ACCEPT new license agreements?         | yes +                      |

---

As mentioned, we chose to use the Local Disk Caching option for this migration. The options/flags we supplied to the `nimadm` command are explained in Table 3-1.

**Note:** You may want to consider using at least a custom BOSINST\_DATA resource with `nimadm`. This will give you greater control over the migration process.

For example, you can change ALL\_DEVICES\_KERNELS from the default of `yes` to `no`, which will only install the devices and kernel type for your system configuration, thus reducing the number of filesets installed and the time taken to perform the migration.

To execute the operation from the command line:

```
{nimmast}:/ # nimadm -j nimvg -c LPAR4 -s SPOT_53_ML4 -l LPP_53_ML4 -d "hdisk1"
-Y
```

Table 4-2 The `nimadm` flags used in our example

| Flag | Purpose                                                                                                                                                                                                                                                                         |
|------|---------------------------------------------------------------------------------------------------------------------------------------------------------------------------------------------------------------------------------------------------------------------------------|
| -j   | This flag, followed by a volume group name, will instruct the <code>nimadm</code> operation to create file systems on the specified volume group (on the NIM master). Then <code>nimadm</code> will use streams to cache all of the data from the client to these file systems. |
| -c   | The name of the NIM client which will be the target of the migration operation.                                                                                                                                                                                                 |
| -s   | The SPOT resource to be used for the migration.                                                                                                                                                                                                                                 |
| -l   | The name of the <code>lpp_source</code> to be used for the migration.                                                                                                                                                                                                           |

| Flag | Purpose                                                                                                                                                                                                                                                                    |
|------|----------------------------------------------------------------------------------------------------------------------------------------------------------------------------------------------------------------------------------------------------------------------------|
| -d   | Specifies the target disks on the client which will be used to create the <code>altinst_rootvg</code> volume group. This volume group will be the target of the migration.                                                                                                 |
| -Y   | Specifies that any software license agreements will be accepted. Before starting a <code>nimadm</code> migration you will be required to accept all software license agreements for the software to be installed. This flag will automatically answer yes to all licenses. |

**Note:** When `nimadm` is run via SMIT, you will notice that an undocumented flag (`-H`) appears in the command line (press F6).

```
/usr/sbin/nimadm -H -cLPAR4 -lLPP_53_ML4 -sSPOT_53_ML4 -dhdisk1 -jnimgv -Y
```

This `-H` flag is used internally (passed between the SMIT scripts to `nimadm`) so that `nimadm` knows it is called via SMIT. This will then change the way some messages appear. For example, a message such as: Choose this menu option would be shown as: use this flag for SMIT versus the command line.

There are two other options which should also be considered carefully:

- The first option is whether or not you would like the bootlist on the NIM client set to the alternate disk after the migration is complete. The default action is to set the bootlist. This may be desirable if you are planning on rebooting the client soon after the upgrade.

However, if it is not possible to reboot a short time after (for example, within the next day or so), then you may prefer not to use this approach. It is possible that if the bootlist is set and the system is left running for several days or even weeks after the migration, you may encounter a undesirable situation (for example, if the system suffers from an unscheduled outage due to a power failure or a system crash and the system comes up on the alternate disk).

If there are any issues as a result of the AIX migration, this may cause further unscheduled downtime for the system. Most administrators would prefer to deal with these situations during a scheduled outage.

To prevent the boot list from being set/alterd after a `nimadm` migration, specify the `-B` flag.

- The second option to consider is whether or not you want the NIM client rebooted after the migration completes. The default is set to `no`. Depending on your environment, however, this may not be appropriate. In our example, we chose not to reboot immediately after the migration because we had

applications running on the system that would have been impacted by a reboot of the system.

If you wish to reboot the client after **nimadm** migration, specify the **-r** flag.

However, it may be more appropriate for your production environment to schedule an outage at an agreed time and then to stop all applications on the server, manually set the bootlist, and reboot the client.

After the **nimadm** operation commences, the status of each phase will be displayed on the screen. We will pause at each phase and comment on what is happening behind the scenes.

It is possible to execute **nimadm** one phase at a time. You may want to do this in order to perform some troubleshooting if the process is failing. Generally speaking, however, this will not be required and you will execute all phases at once. When the process is underway, there should be no need for the administrator to intervene.

**Note:** All output from the **nimadm** operation is logged to the file `/var/adm/ras/alt_mig/nim_client_name_alt_mig.log`, where `nim_client_name` is the name of the NIM client being migrated. In our case, the name of this file was `/var/adm/ras/alt_mig/LPAR4_alt_mig.log`.

In Example 4-160, Phase 1 has commenced. During this phase, an alternate disk copy of the clients rootvg was created via the **alt\_disk\_install** utility.

*Example 4-160 Phase 1 starts*

```
{nimmast}:/ # nimadm -j nimvg -c LPAR4 -s SPOT_53_ML4 -l LPP_53_ML4 -d "hdisk1"
-Y
Initializing the NIM master.
Initializing NIM client lpar4.
Verifying alt_disk_migration eligibility.
Initializing log: /var/adm/ras/alt_mig/LPAR4_alt_mig.log
Starting Alternate Disk Migration.

+-----+
Executing nimadm phase 1.
+-----+
Cloning altinst_rootvg on client, Phase 1.
Client alt_disk_install command: alt_disk_copy -j -M 5.3 -P1 -d "hdisk1"
Calling mkszfile to create new /image.data file.
Checking disk sizes.
Creating cloned rootvg volume group and associated logical volumes.
Creating logical volume alt_hd5
Creating logical volume alt_hd6
Creating logical volume alt_hd8
```

```
Creating logical volume alt_hd4
Creating logical volume alt_hd2
Creating logical volume alt_hd9var
Creating logical volume alt_hd3
Creating logical volume alt_hd1
Creating logical volume alt_hd10opt
Creating /alt_inst/ file system.
Creating /alt_inst/home file system.
Creating /alt_inst/opt file system.
Creating /alt_inst/tmp file system.
Creating /alt_inst/usr file system.
Creating /alt_inst/var file system.
Generating a list of files
for backup and restore into the alternate file system...
Phase 1 complete.
```

---

In Phase 2, the NIM master creates the cache file systems in the nimvg volume group. Some initial checks for required migration disk space were also performed; see Example 4-161.

*Example 4-161 Executing nimadm phase 2*

---

```
+-----+
Executing nimadm phase 2.
+-----+
Creating nimadm cache file systems on volume group nimvg.
Checking for initial required migration space.
Creating cache file system /LPAR4_alt/alt_inst
Creating cache file system /LPAR4_alt/alt_inst/usr
Creating cache file system /LPAR4_alt/alt_inst/var
Creating cache file system /LPAR4_alt/alt_inst/tmp
Creating cache file system /LPAR4_alt/alt_inst/home
Creating cache file system /LPAR4_alt/alt_inst/opt
Creating /alt_inst/var file system.
```

---

In Phase 3, as shown in Example 4-162, the NIM master copies the NIM client's data to the cache file systems in nimvg. We are using the Local Disk Cache option, so this data copy is done via rsh instead of using NFS mounts of the client's file systems to the master.

*Example 4-162 Executing nimadm phase 3*

---

```
+-----+
Executing nimadm phase 3.
+-----+
Syncing client data to cache ...
```

---

Viewing the status of the NIM client from the NIM master shows that an alternate disk migration is being performed; see Example 4-163.

*Example 4-163 Checking the status of the NIM client*

---

```
{nimmast}:/ # lsnm -l LPAR4
LPAR4:
 class = machines
 type = standalone
 locked = 397474
 connect = shell
 platform = chrp
 netboot_kernel = mp
 if1 = NET_EN1 lpar4 0
 cable_type1 = tp
 Cstate = alt_disk_mig operation is being performed
 prev_state = ready for a NIM operation
 Mstate = currently running
 lpp_source = LPP_53_ML4
 spot = SPOT_53_ML4
 cpuid = 001A85D24C00
 control = master
 Cstate_result = success
```

---

In Example 4-164, we can see the cache file systems that nimadm has created to support the migration operation. Each of the /LPAR4\_alt/alt\_inst\* file systems corresponds to the real file systems on the client's alternate disk copy.

On the client, the file systems are also mounted with a /alt\_inst prefix. The /alt\_inst prefix gives these file systems a unique name, which prevents any conflict between the real and the alternate. For example, you cannot have two file systems called /usr, so the alternate is called /alt\_inst/usr.

*Example 4-164 Cache file system created by nimadm*

---

```
{nimmast}:/ # lsvg -l nimvg
nimvg:
LV NAME TYPE LPs PPp PVs LV STATE MOUNT POINT
lppsrclv jfs2 97 97 1 open/syncd /export/lpp_source
loglv00 jfs2log 1 1 1 open/syncd N/A
spotlv jfs2 11 11 1 open/syncd /export/spot
imageslv jfs2 113 113 1 open/syncd /export/images
loglv01 jfslog 1 1 1 open/syncd N/A
lv00 jfs 1 1 1 open/syncd /LPAR4_alt/alt_inst
lv01 jfs 17 17 1 open/syncd /LPAR4_alt/alt_inst/usr
lv02 jfs 1 1 1 open/syncd /LPAR4_alt/alt_inst/var
lv03 jfs 1 1 1 open/syncd /LPAR4_alt/alt_inst/tmp
lv04 jfs 1 1 1 open/syncd /LPAR4_alt/alt_inst/home
lv05 jfs 1 1 1 open/syncd /LPAR4_alt/alt_inst/opt
```

```
lsvg -l altinst_rootvg
altinst_rootvg:
LV_NAME TYPE LPs PPs PVs LV STATE MOUNT POINT
alt_hd5 boot 1 1 1 closed/syncd N/A
alt_hd6 paging 8 8 1 closed/syncd N/A
alt_hd8 jfslog 1 1 1 open/syncd N/A
alt_hd4 jfs 1 1 1 open/syncd /alt_inst
alt_hd2 jfs 6 6 1 open/syncd /alt_inst/usr
alt_hd9var jfs 1 1 1 open/syncd /alt_inst/var
alt_hd3 jfs 1 1 1 open/syncd /alt_inst/tmp
alt_hd1 jfs 1 1 1 open/syncd /alt_inst/home
alt_hd10opt jfs 1 1 1 open/syncd /alt_inst/opt
```

---

On the client you can see that hdisk1 now belongs to the altinst\_rootvg volume group:

```
{lpar4}:/ # lspv
hdisk0 001a85d27c3dc850 rootvg active
hdisk1 001a071f9a12dbaf altinst_rootvg active
```

In Phase 4, if a premigration script was specified to run on the client, it would be executed now. We did not execute any premigration script in our test environment; see Example 4-165.

*Example 4-165 Phase 4 pre-migration scripts execution*

---

```
+-----+
Executing nimadm phase 4.
+-----+
nimadm: There is no user customization script specified for this phase.
```

---

Phase 5 will save system configuration files and then perform an initial check for disk space required for the migration, as shown in Example 4-166. If required, then file systems will be expanded at this point. The BOS run-time environment is restored and the device database (ODM) is merged (similar to a conventional migration).

*Example 4-166 Execution of nimadm phase 5*

---

```
+-----+
Executing nimadm phase 5.
+-----+
Saving system configuration files.
Checking for initial required migration space.
Setting up for base operating system restore.
Restoring base operating system.
Merging system configuration files.
```

```

Rebuilding inventory database.
Running migration merge method: ODM_merge Config_Rules.
Running migration merge method: ODM_merge SRCextmeth.
Running migration merge method: ODM_merge SRCsubsys.
Running migration merge method: ODM_merge SWservAt.
Running migration merge method: ODM_merge pse.conf.
Running migration merge method: ODM_merge xtiso.conf.
Running migration merge method: ODM_merge PdDv.
Running migration merge method: convert_errnotify.
Running migration merge method: passwd_mig.
Running migration merge method: login_mig.
Running migration merge method: user_mrg.
Running migration merge method: secur_mig.
Running migration merge method: mkusr_mig.
Running migration merge method: group_mig.
Running migration merge method: ldapcfg_mig.
Running migration merge method: convert_errlog.
Running migration merge method: ODM_merge GAI.
Running migration merge method: ODM_merge PdAt.
Running migration merge method: merge_smit_db.
Running migration merge method: ODM_merge fix.
Running migration merge method: merge_swvpds.
Running migration merge method: SysckMerge.

```

---

The migration to AIX 5L V5.3 commences in Phase 6. All the client's filesets on the local cache file systems will be migrated via installp. At this point all the activity is taking place on the NIM master, and not on the client. Output has been removed to save space in Example 4-167.

*Example 4-167 Executing nimadm phase 6 - migration commences*

---

```

+-----+
Executing nimadm phase 6.
+-----+
Installing and migrating software.
Updating install utilities.
+-----+
 Pre-installation Verification...
+-----+
Verifying selections...done
Verifying requisites...done
Results...
....
....
Checking space requirements for installp install.
Expanding /LPAR4_alt/alt_inst/usr local filesystem.
Filesystem size changed to 2097152
Installing software with the installp installer.

```



```

+-----+
 Pre-installation Verification...
+-----+
Verifying selections...done
Verifying requisites...done
Results...
.....
FILESET STATISTICS

 709 Selected to be installed, of which:
 611 Passed pre-installation verification
 60 Replaced by superseding updates
 36 Already installed (directly or via superseding filesets)
 1 Additional requisites to be automatically installed

 612 Total to be installed
.....
install_all_updates: Checking for recommended Maintenance Level 5300-04.
install_all_updates: Executing /usr/bin/oslevel -rf, Result = 5300-04
install_all_updates: Verification completed.
install_all_updates: Log file is /var/adm/ras/install_all_updates.log
install_all_updates: Result = SUCCESS
Restoring device ODM database.

```

If a post-migration script was specified for the NIM client, then it will be executed in Phase 7. We did not execute any post-migration script in our example; see Example 4-168.

*Example 4-168 Executing post-migration scripts if any - phase 7*

```

+-----+
Executing nimadm phase 7.
+-----+
nimadm: There is no user customization script specified for this phase.

```

The **bosboot** command is run to create a new boot image, which is written to the clients alternate boot logical volume `alt_hd5`, as shown in Example 4-169.

*Example 4-169 Running the bosboot command during phase 8*

```

+-----+
Executing nimadm phase 8.
+-----+
Creating client boot image.
bosboot: Boot image is 25216 512 byte blocks.
Writing boot image to client's alternate boot disk hdisk1.

```

On the client (lpar4), we could see the alternate boot image being created by observing the current processes on the system, as shown in Example 4-170.

*Example 4-170 Alternate boot image is created*

---

```
{lpar4}:/ #ps -ef | grep alt_hd5
 root 188456 258226 1 10:42:37 - 0:00 /usr/bin/dd
if=/alt_inst/usr/lpp/bos.alt_disk_install/boot_images/alt_mig.client.boot
of=/dev/alt_hd5 seek=2
 root 258226 303174 0 10:42:37 - 0:00 ksh -c /usr/bin/dd
if=/alt_inst/usr/lpp/bos.alt_disk_install/boot_images/alt_mig.client.boot
of=/dev/alt_hd5 seek=2 2>&1 && echo rmc_cmd_RET0 || echo rmc_cmd_RET1
 root 274464 188456 1 10:42:37 - 0:00 /usr/bin/dd
if=/alt_inst/usr/lpp/bos.alt_disk_install/boot_images/alt_mig.client.boot
of=/dev/alt_hd5 seek=2
```

---

All the migrated data is now copied from the NIM master's local cache file to the client's alternate rootvg via **rsh**, as shown in Example 4-171.

*Example 4-171 Migrated data is now copied during nimadm phase 9*

---

```
+-----+
Executing nimadm phase 9.
+-----+
Adjusting client file system sizes ...
Adjusting size for /
Adjusting size for /usr
Expanding /alt_inst/usr client filesystem.
Filesystem size changed to 2490368
Adjusting size for /var
Adjusting size for /tmp
Adjusting size for /home
Adjusting size for /opt
Syncing cache data to client ...
```

---

Observing the process table on the client and the master (**ps -ef** command) revealed the processes involved in the master-to-client data synchronization, as shown in Example 4-172.

**Note:** The `/alt_inst/alt_disk_mig_rfail` log file, which captures status information regarding the syncing of the cache data to the client, can be useful for troubleshooting.

*Example 4-172 Data synchronization*

---

```
{lpar4}:/ # ps -ef | grep restore
```

```
root 188482 303202 0 10:46:05 - 0:00 ksh -c cd /alt_inst/usr &&
/usr/sbin/restore -xqf- > /dev/null || > /alt_inst/alt_disk_mig_rfail.397474
```

```
{nimmast}:/ # ps -ef | grep restore
root 545008 397474 0 10:46:02 pts/3 0:00 /usr/bin/rsh lpar4 cd
/alt_inst/usr && /usr/sbin/restore -xqf- > /dev/null || >
/alt_inst/alt_disk_mig_rfail.397474
 root 548984 545008 0 10:46:02 pts/3 0:01 /usr/bin/rsh lpar4 cd
/alt_inst/usr && /usr/sbin/restore -xqf- > /dev/null || >
/alt_inst/alt_disk_mig_rfail.397474
```

---

The NIM master cleans up and removes the local cache file systems in Phase 10 because they are no longer required, as shown in Example 4-173.

*Example 4-173 Cleaning up by the NIM master - nimadm phase 10*

---

```
+-----+
Executing nimadm phase 10.
+-----+
Unmounting client mounts on the NIM master.
forced unmount of /LPAR4_alt/alt_inst/var
forced unmount of /LPAR4_alt/alt_inst/usr
forced unmount of /LPAR4_alt/alt_inst/tmp
forced unmount of /LPAR4_alt/alt_inst/opt
forced unmount of /LPAR4_alt/alt_inst/home
forced unmount of /LPAR4_alt/alt_inst
Removing nimadm cache file systems.
Removing cache file system /LPAR4_alt/alt_inst
Removing cache file system /LPAR4_alt/alt_inst/usr
Removing cache file system /LPAR4_alt/alt_inst/var
Removing cache file system /LPAR4_alt/alt_inst/tmp
Removing cache file system /LPAR4_alt/alt_inst/home
Removing cache file system /LPAR4_alt/alt_inst/opt
```

---

The `alt_disk_install` command is called again, as it was in Phase 3, to verify the `altinst_rootvg` and to put the volume group to sleep (for example, unmounting the `/alt_inst` file systems, as shown in Example 4-174). The bootlist is set to the alternate disk unless the `-B` flag is specified (we did not specify this flag).

*Example 4-174 Verifying the alternate rootvg installation*

---

```
+-----+
Executing nimadm phase 11.
+-----+
Cloning altinst_rootvg on client, Phase 3.
Client alt_disk_install command: alt_disk_copy -j -M 5.3 -P3 -d "hdisk1"
Phase 3
Verifying altinst_rootvg...
```

```

Modifying ODM on cloned disk.
forced unmount of /alt_inst/var
forced unmount of /alt_inst/usr
forced unmount of /alt_inst/tmp
forced unmount of /alt_inst/opt
forced unmount of /alt_inst/home
forced unmount of /alt_inst
forced unmount of /alt_inst
Changing logical volume names in volume group descriptor area.
Fixing LV control blocks...
Fixing file system superblocks...
Bootlist is set to the boot disk: hdisk1

```

---

In Phase 12, several cleanup tasks are performed on the NIM master and client. If the **-r** flag was specified with **nimadm**, then the NIM client would be rebooted now. We chose not to reboot, which is the default action as shown in Example 4-175.

*Example 4-175 Cleaning continues on phase 12*

```

+-----+
Executing nimadm phase 12.
+-----+
Cleaning up alt_disk_migration on the NIM master.
Cleaning up alt_disk_migration on client LPAR4.

```

---

Now that all **nimadm** phases have been completed successfully, we are ready to reboot our client.

After a system outage time window has been agreed upon and scheduled, all that would be required to “migrate” our system to AIX 5L V5.3 would be a reboot. The following tasks would be performed to reboot from our alternate disk:

1. After all applications have been stopped and all users logged off, confirm that the client’s bootlist is set to the alternate rootvg and reboot the system:

```

{lp4}:/ # bootlist -m normal -o
hdisk1
{lp4}:/ # lspv
hdisk0 001a85d27c3dc850 rootvg active
hdisk1 001a071f9a12dbaf altinst_rootvg
{lp4}:/ # shutdown -Fr

```

2. After the reboot, confirm that the correct AIX 5L is shown (for example, AIX 5L V5.3). At this point you would perform verification testing to ensure that the system is functioning as expected; for example:
3. {lp4}:/ # oslevel -r
4. 5300-04

- If required, the administrator can easily back out the upgrade by booting from the original rootvg disk as shown:

```
{lpar4}:/ # bootlist -m normal hdisk0
{lpar4}:/ # lspv
hdisk0 001a85d27c3dc850 old_rootvg
hdisk1 001a071f9a12dbaf rootvg active
bootlist -m normal -o
hdisk0 blv=hd5
{lpar4}:/ # shutdown -Fr
```

- After the reboot, confirm that the correct version of AIX is running (for example, the version prior to the migration to AIX 5L V5.3 which was AIX 5L V5.2). Use the following command:

```
{lpar4}:/ # oslevel -r
5200-04
```

- If required, rootvg should be remirrored after the migration. Then reboot the system to turn off quorum for rootvg.

#### 4.6.4 Cleaning up after a failed nimadm operation

If a **nimadm** operation fails during a migration, the **nimadm** utility can take care of cleaning up the systems without user intervention. However, in some cases it may be necessary to ask **nimadm** to rerun the cleanup process. This can be done by running the **nimadm** command with the **-C** (clean up) flag, the **-F** (unlock NIM client) flag, or via SMIT, as shown in Example 4-176.

*Example 4-176 Cleaning after a failed nimadm operation*

---

```
{nimmast}:/ # smit nimadm
 Clean up NIM Alternate Disk Migration

* Target NIM Client [LPAR4]+
* NIM SPOT resource [SPOT_53_ML4]+
 Debug output? no+
 FORCE cleanup to reset all locks? yes+
```

COMMAND STATUS

```
Command: OK stdout: yes stderr: no
```

Before command completion, additional instructions may appear below.

```
Initializing the NIM master.
Initializing NIM client lpar4.
Cleaning up alt_disk_migration on the NIM master.
Cleaning up alt_disk_migration on client LPAR4.
Client alt_disk_install command: alt_disk_install -M all -X
```

Bootlist is set to the boot disk: hdisk0

---

It may also be necessary to perform other manual tasks in the event of a `nimadm` failure:

- ▶ Unmounting all `/alt_*` file systems.
- ▶ Removing the `/alt_*` file systems.
- ▶ Varying off the `altinst_rootvg` volume group.
- ▶ Removing the `altinst_rootvg` volume group with the `alt_disk_install -x altinst_rootvg` command.

**Important:** We recommend that you do not use `exportvg` on an alternate rootvg. Always use the `-x` option to `alt_disk_install`. Using `exportvg` may result in some required entries in `/etc/filesystems` being removed. Our tests have shown that this can and does happen.

After you are satisfied that the failed `nimadm` process has been successfully cleaned up, attempt the migration operation again.

## 4.7 Network Installation Manager and Linux distributions

IBM System p machines traditionally use BOOTP protocol for booting over the network. Intel®-based computers (Windows/Linux) typically use DHCP and PXE protocol.

In order to be able to serve both AIX and Linux client network installations from one network install server, DHCP must be used for both types, because BOOTP and DHCP cannot be active on the same server at the same time. This is not a problem because DHCP on AIX 5L V5.3 supports handling of BOOTP requests as well as DHCP requests. But a conversion has to be made for all existing NIM clients to use DHCP configuration files and syntax.

As with AIX 5L V5.3, RFC 2349 is implemented in the AIX 5L tftp subsystem, making it possible to use an AIX 5L server as a complete network install server for multiple platforms.

Intel clients typically use DHCP and PXE (Pre-boot eXecution Environment) for booting over the network. And because x86-based clients cannot load more than 512 kB of code in the first boot stage, we need a special kernel known as Linux PXE kernel for the initial load when installing Linux these platforms. This kernel is responsible for transferring the network install kernel (and optionally a ramdisk) via TFTP and starting the installation.

For an IBM System p using BOOTP, there is only one file to load because IBM System p hardware does not have the 512 KB limitation.

## 4.7.1 Configuring DHCP

Before starting to configure the DHCP server, make sure that the `bos.net.tcp.server` fileset is installed. The DHCP server configuration file is located in `/etc/dhcpd.conf`. This configuration example is for a netboot DHCP server only, and should not be used to serve other DHCP clients.

By default, almost all parameters in `/etc/dhcpd.conf` are commented out. Example 4-177 shows which parameters have to be activated to set up DHCP as a netboot server. In order for the DHCP server to start, there has to be at least one network and one subnet defined. To solve this we define a dummy network and a dummy subnet.

One of the most important parameters is `supportBOOTP`, because this will enable the DHCP server to answer BOOTP requests, and thus support installation of IBM System p servers.

*Example 4-177 Example dhcpd.conf*

---

```
numLogFiles 4
logFileSize 100
logFileName /var/log/dhcpd.log
logItem ACTION
logItem INFO

leaseTimeDefault -1
supportBOOTP yes

For DHCP to start, at least one network and one subnet is required
Dummy network
network 172.16.0.0 255.255.255.253

Dummy subnet
subnet 172.16.0.0 172.16.0.1-172.16.0.2
```

---

Do not start the DHCP server daemon yet, because BOOTP must be disabled and any existing NIM clients must be converted to use DHCP syntax.

### Disabling BOOTP

The `bootp` service is started (default) by the `inetd` subsystem. To list the services `inetd` is handling, run:

```
lssrc -ls inetd
```

If BOOTP is enabled, you should see a line starting with bootps. If you do, edit /etc/inetd.conf, and comment out the following line:

```
bootps dgram udp wait root /usr/sbin/bootpd bootpd /etc/bootptab
```

Make the **inetd** daemon be aware of the change by issuing:

```
refresh -s inetd
```

Run **lssrc -ls inetd** again, you should not see bootps in the list anymore.

## Converting to DHCP

To enable the DHCP server to handle the existing NIM clients' BOOTP requests, their definitions must be converted to use DHCP instead of BOOTP. Before this is done, however, verify that the MAC (hardware) address is in the NIM definition for all clients because this is required for DHCP; see Example 4-178.

### *Example 4-178 Checking the NIM definition of lpar5304*

---

```
root@master:/: lsnim -l lpar5304
Lpar5304:
 class = machines
 type = standalone
 connect = shell
 platform = chrp
 netboot_kernel = mp
 if1 = eth_nim lpar5304 0006298426AD
 cable_type1 = tp
 Cstate = ready for a NIM operation
 prev_state = ready for a NIM operation
 Mstate = currently running
```

---

The MAC address shown in Example 4-178 is 0006298426AD.

If the MAC address is not present, the client has to be updated with this information before the conversion is made. To get the MAC address of an AIX 5L client, issue the **lscfg** command (assuming ent0 is the network install interface) as shown in Example 4-179.

### *Example 4-179 Getting the MAC address of an AIX 5L client*

---

```
root@master:/: lscfg -v | ent0
ent0 P1/E1 IBM 10/100 Mbps Ethernet PCI Adapter (23100020)

Network Address.....0006298426AD
Displayable Message.....PCI Ethernet Adapter (23100020)
Device Specific.(YL)....P1/E1
```

---



To update the client with the MAC address information, enter:

```
nim -o change -a "if1=eth_nim lpar5304 0006298426AD" lpar5304
```

Alternatively, use SMIT to update this information (although this can be time-consuming if many clients have to be updated); see Example 4-180.

*Example 4-180 SMIT Change/Show characteristics of a machine*

---

```
Change/Show Characteristics of a Machine
Type or select values in entry fields.
Press Enter AFTER making all desired changes.

 [Entry Fields]
Machine Name [lpar5304]
* Hardware Platform Type [chrp] +
* Kernel to use for Network Boot [mp] +
Machine Type standalone
Network Install Machine State currently running
Network Install Control State ready for a NIM operation
Primary Network Install Interface
 Network Name eth_nim
 Host Name [lpar5304]
 Network Adapter Hardware Address [0006298426AD]
 Network Adapter Logical Device Name [ent]
 Cable Type tp +
 Network Speed Setting [] +
 Network Duplex Setting [] +
IPL ROM Emulation Device [] +/
CPU Id []
Communication Protocol used by client [shell] +
Comments []

Force no +

F1=Help F2=Refresh F3=Cancel F4=List
F5=Reset F6=Command F7=Edit F8=Image
F9=Shell F10=Exit Enter=Do
```

---

After all NIM clients have their MAC addresses entered into their definitions, some kind of net\_boot must be activated to make NIM update the /etc/bootptab file with the information we will later convert. For our example, we will enable a DIAG boot on all NIM clients. For one client issue the following command:

```
nim -o diag_boot -a spot=spot5304 <client>
```

If there are many clients, a simple **awk** script will work:

```
for i in $(lsnim -t standalone|awk '{print $1}'); do
```

```
nim -o diag_boot -a spot=spotxxx $i
done
```

This may not work if some of the clients are currently in a state preventing operations on them. In this case, reset the clients by issuing this command:

```
nim -Fo reset <client>
```

To reset all clients defined, use the following:

```
for i in $(lsnim -t standalone|awk '{print $1}'); do
 nim -Fo reset $i
done
```

Then rerun the previous command to enable DIAG boot on all clients:

```
nim -o diag_boot -a spot=spot5304 <client>
```

After all the NIM clients are allocated for network boot, use the AIX command **bootptodhcp** (which is part of `bos.net.tcp.server` fileset) to convert the `/etc/bootptab` file to DHCP format. See the man page of **bootptodhcp** for a detailed description of parameters. For our example, we use the `-d` flag to dump the output to a file other than `/etc/dhcpsd.cnf`; for example:

```
bootptodhcp -d /tmp/my_nim_clients.dhcp
```

The file `/tmp/my_nim_clients.dhcp` looks similar to the one in Example 4-181 on page 289.

You should see a list of all your NIM clients in a similar way. The file pointed to by option `bf/tftpboot/lpar5304` does not need to exist, because NIM will create this as a symbolic link when performing an install, diag, or maintenance operation.

Now we have all our NIM clients BOOTP definitions converted to DHCP and saved in this file, which we will use in the next section.

Before we continue, however, we reset the state of the NIM clients and deallocate the resources that were allocated during our DIAG command:

Reset a single client:

```
nim -Fo reset <client>
```

Reset all NIM clients defined:

```
for i in $(lsnim -t standalone|awk '{print $1}'); do
 nim -Fo reset $i
done
```

Deallocate all resources from a single client:

```
nim -o deallocate -a subclass=all <client>
```

Deallocate all resources from all NIM clients defined:

```
for i in $(lsnim -t standalone|awk '{print $1}'); do
 nim -o deallocate -a subclass=all $i
done
```

After the resources are deallocated, no entries should exist in the `/etc/bootptab` file other than the default comments.

Note that if new NIM clients are defined, they are *not* automatically added to `dhcpsd.cnf`. Instead, this action has to be done manually or automated with scripts.

## Merging files

The next step is to merge the client definitions (`/tmp/my_nim_clients.dhcp`) with the `dhcpsd` configuration file. Append this file to `/etc/dhcpsd.cnf`, as shown:

```
cat /tmp/my_nim_clients.dhcp >> /etc/dhcpsd.cnf
```

**Note:** Use `>>`. Otherwise, your configuration file will be overwritten.

The configuration file looks like Example 4-181.

### Example 4-181 Example `dhcpsd.cnf`

---

```
numLogFiles 4
logFileSize 100
logFileName /var/log/dhcpsd.log
logItem ACTION
logItem INFO

leaseTimeDefault -1
#leaseExpireInterval 3 minutes
supportBOOTP yes

For DHCP to start, at least one network and one subnet is required
Dummy network
network 172.16.0.0 255.255.255.253

Dummy subnet
subnet 172.16.0.0 172.16.0.1-172.16.0.2

BOOTP CLIENT: lpar5304
client 1 0006298426AD 192.168.234.19
{
 option 1 255.255.255.0
 option sa 192.168.234.10
 option bf "/tftpboot/lpar5304"
```

```
}
```

---

## Enabling DHCP

Now that BOOTP is disabled, we can safely enable the DHCP server. Because we already configured `dhcpcd.conf`, all we have to do is start the server. Note that `dhcpcd` is controlled by `srcmstr`; its configuration is shown in Example 4-182.

### Example 4-182 Checking the `dhcpcd` configuration

---

```
root@master:/: lssrc -s dhcpcd
Subsystem Group PID Status
dhcpcd tcpip 327750 inoperative
```

---

Start the DHCP server, as shown in Example 4-183.

### Example 4-183 `startsrc -s dhcpcd`

---

```
root@master:/: startsrc -s dhcpcd
0513-059 The dhcpcd Subsystem has been started. Subsystem PID is 327750.
```

---

Check if the server started, as shown in Example 4-184.

### Example 4-184 `lssrc -s dhcpcd`

---

```
root@master:/: lssrc -s dhcpcd
Subsystem Group PID Status
dhcpcd tcpip 327750 active
```

---

Check if the clients are active for DHCP netboot, as shown in Example 4-185.

### Example 4-185 `lssrc -ls dhcpcd`

---

```
root@master:/: lssrc -ls dhcpcd
Log File: /var/log/dhcpcd.log
Log Level: 0x8c0
Client Expire Interval: 3600
Reserve Expire Interval: 900
Bad Addr Reclaim Interval: 4294967295
Database Save Interval: 3600
```

| IP Address     | Status | Duration | Time Stamp | Client ID |
|----------------|--------|----------|------------|-----------|
| -----          | -----  | -----    | -----      | -----     |
| 172.16.0.1     | Free   |          |            |           |
| 172.16.0.2     | Free   |          |            |           |
| 192.168.234.19 | Free   |          |            |           |

---

We can see here that our client (192.168.234.19) is activated for netboot via DHCP.

To enable the DHCP server to start at boot time, edit /etc/rc.tcpip and uncomment the line starting with: #start /usr/sbin/dhcpd "\$src\_running".

NIM does not handle DHCP, so all clients will still be able to boot from DHCP (BOOTP) as long as they are defined in /etc/dhcpd.cnf and the **dhcpd** daemon is running. This is not normally a problem with IBM System p systems, because the bootlist can be altered from the SMS menu, remotely from the service processor, or by using the **bootlist** command (in AIX).

Intel systems, on the other hand, do not have the same flexibility, and the boot order is often fixed with the netboot device before disk in the bootlist. This can cause a problem when the system boots and finds a DHCP server responding.

To get around this problem, the dhcpd.cnf configuration file has to be altered to prevent the client from getting a response from the server. This can be done manually by editing the configuration file, or it can be automated with scripts.

Another solution would be to stop the dhcpd server, but this would make installations for other clients impossible as well.

## Enabling tftp

Trivial File Transfer Protocol (TFTP) is used to fetch the actual netboot kernel from a server after the boot has completed. This is done by BOOTP (IBM System p, DHCP (pxeboot, Linux), or AIX 5L).

IBM System p can fetch the entire kernel at once, but for Intel-based systems, the size is limited to 512 KB and we need a special PXE kernel to handle the rest. Anyway, tftp has to be enabled. This is also a service provided by the **inted** daemon.

Check whether **tftpd** is active by running the command shown in Example 4-186; look for a line starting with:

```
tftp /usr/sbin/tftpd tftpd -n active
```

*Example 4-186 Checking whether tftpd is active (in this case, it is not active)*

---

```
root@master:/: lssrsc -ls inetd
Subsystem Group PID Status
inetd tcpip 147528 active

Debug Not active

Signal Purpose
SIGALRM Establishes socket connections for failed services.
```

SIGHUP Rereads the configuration database and reconfigures services.

SIGCHLD Restarts the service in case the service ends abnormally.

| Service   | Command                  | Description      | Status |
|-----------|--------------------------|------------------|--------|
| xmquery   | /usr/bin/xmtopas         | xmtopas -p3      | active |
| wmsserver | /usr/websm/bin/wmsserver | wmsserver -start | active |
| time      | internal                 |                  | active |
| daytime   | internal                 |                  | active |
| time      | internal                 |                  | active |
| daytime   | internal                 |                  | active |
| ntalk     | /usr/sbin/talkd          | talkd            | active |
| exec      | /usr/sbin/rexecd         | rexecd           | active |
| login     | /usr/sbin/rlogind        | rlogind          | active |
| shell     | /usr/sbin/rshd           | rshd             | active |
| telnet    | /usr/sbin/telnetd        | telnetd -a       | active |
| ftp       | /usr/sbin/ftpd           | ftpd             | active |

If you do not find such a line, edit /etc/inetd.conf and uncomment the line starting with #tftpd, then refresh inetd:

```
refresh -s inetd
```

Run **lssrc -ls inetd** again to verify that inetd has started; see Example 4-187.

*Example 4-187 Checking for tftp service (here, it is active)*

```
root@master:/: lssrc -ls inetd
```

| Subsystem | Group | PID    | Status |
|-----------|-------|--------|--------|
| inetd     | tcpip | 147528 | active |

Debug Not active

Signal Purpose

SIGALRM Establishes socket connections for failed services.

SIGHUP Rereads the configuration database and reconfigures services.

SIGCHLD Restarts the service in case the service ends abnormally.

| Service     | Command                  | Description      | Status        |
|-------------|--------------------------|------------------|---------------|
| xmquery     | /usr/bin/xmtopas         | xmtopas -p3      | active        |
| wmsserver   | /usr/websm/bin/wmsserver | wmsserver -start | active        |
| time        | internal                 |                  | active        |
| daytime     | internal                 |                  | active        |
| time        | internal                 |                  | active        |
| daytime     | internal                 |                  | active        |
| ntalk       | /usr/sbin/talkd          | talkd            | active        |
| <b>tftp</b> | <b>/usr/sbin/tftpd</b>   | <b>tftpd -n</b>  | <b>active</b> |
| exec        | /usr/sbin/rexecd         | rexecd           | active        |

|        |                   |            |        |
|--------|-------------------|------------|--------|
| login  | /usr/sbin/rlogind | rlogind    | active |
| shell  | /usr/sbin/rshd    | rshd       | active |
| telnet | /usr/sbin/telnetd | telnetd -a | active |
| ftp    | /usr/sbin/ftpd    | ftpd       | active |

---

## Directory structure setup

In this section, we are going to concentrate on installing Fedora5 Linux on an Intel PC and on an IBM System p system. The way to do it should not differ much from other Linux distributions.

Figure 4-9 shows the directory structure that was used for the installation.

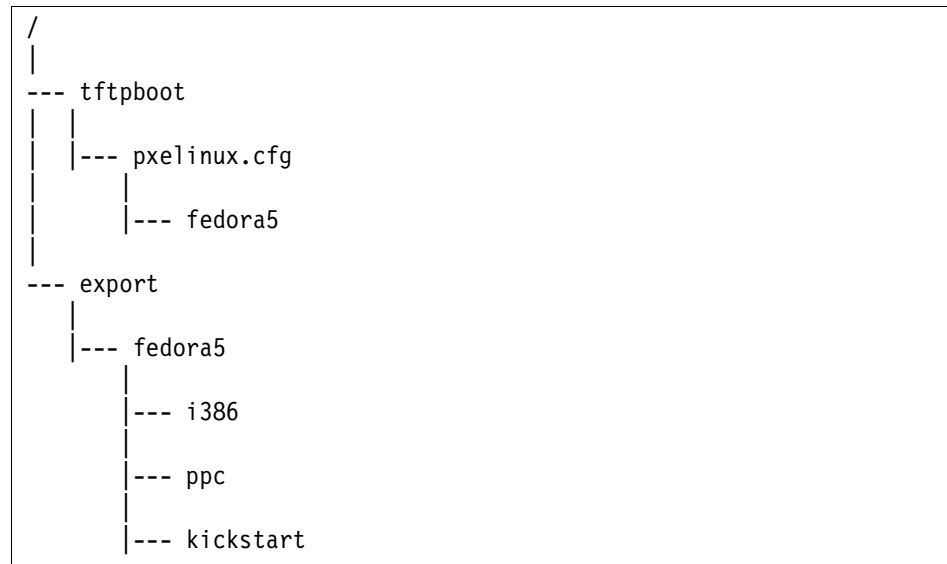

Figure 4-9 Directory structure

We recommend that each Linux distribution have its own file system for the install sources, about 3 GB to 5 GB in size, depending on the distribution.

To create one file system for Fedora5/i386™ and one for Fedora5/ppc on volume group vgnim, enter:

```

crfs -v jfs2 -g vgnim -m /export/fedora5/i386 -A yes -a size=5G
crfs -v jfs2 -g vgnim -m /export/fedora5/ppc -A yes -a size=5G
mount /export/fedora5/i386
mount /export/fedora5/ppc

```

## Get the PXE Linux kernel

The Linux PXE kernel can be obtained from:

```
http://www.kernel.org/pub/linux/utils/boot/syslinux
```

The actual file you need (pxelinux.0) is included in a package called syslinux. Be sure to get a stable release of syslinux; for our examples, we used version 2.00 because it seems to work well.

```
http://www.kernel.org/pub/linux/utils/boot/syslinux/01d/syslinux-2.00.tar.gz
```

Unpack the needed pxeboot.0 file using the **gunzip** utility found on the AIX 5L Toolbox for Linux Applications.

```
gunzip -c syslinux-2.00.tar.gz|tar -xf - syslinux-2.00/pxelinux.0
```

Copy the pxelinux.0 file to the /tftpboot/pxelinux.0.200 and create a symbolic link to the pxelinux.0, as shown in Example 4-188.

### *Example 4-188* Creating link to copied pxelinux.0 file

---

```
root@master:/: cp syslinux-2.00/pxelinux.0 /tftpboot/pxelinux.0.200
root@master:/: cd /tftpboot
root@master:/: ln -s pxelinux.0.200 pxelinux.0
ls -l
total 24
drwxr-xr-x 2 root system 256 Jun 12 13:50 fedora5
lrwxrwxrwx 1 root system 14 Jun 26 10:15 pxelinux.0 -> pxelinux.0.200
-rw-r--r-- 1 root system 10820 Jun 12 12:00 pxelinux.0.200
drwxr-xr-x 2 root system 256 Jun 12 12:00 pxelinux.cfg
```

---

## Linux install source creation

Next, copy the installation files to the NIM server. Copy the whole directory structure from the installation CDs to the file system we created earlier.

For each CD (or DVD) in the distribution, assuming /cdrom is the CD mount point, execute these commands:

For Fedora5/i386:

```
mount /cdrom
cp -Rhp /cdrom/* /export/fedora5/i386
umount /cdrom
```

For Fedora5/ppc:

```
mount /cdrom
cp -Rhp /cdrom/* /export/fedora5/ppc
umount /cdrom
```



For Fedora5/i386, the netboot kernel (installer) and ramdisk are located in directory `images/pxeboot` on the installation CD/DVD. Because we copied the entire contents of the CDs/DVD, they are now in `/export/fedora5/i386/images/pxeboot`.

These files need to be copied to the `/tftpboot/fedora5` directory, preferably to a name that reflects the distribution and version.

Ownership, group, and permissions should also be checked. These files will be loaded by the Linux PXE kernel, when the initial boot stage is completed; see Example 4-189.

*Example 4-189 Copying the Linux distribution files*

---

```
cp /export/fedora5/i386/images/pxeboot/vmlinuz /tftpboot/fedora5/vmlinuz.fc5.i386
cp /export/fedora5/i386/images/pxeboot/initrd.img /tftpboot/fedora5/initrd.fc5.i386.img
chown root.system /tftpboot/fedora5/vmlinuz.fc5.i386
chown root.system /tftpboot/fedora5/initrd.fc5.i386.img
chmod 444 /tftpboot/fedora5/vmlinuz.fc5.i386
chmod 444 /tftpboot/fedora5/initrd.fc5.i386.img
```

---

For Fedora/ppc clients using BOOTP, only one kernel file has to be loaded during netboot, and the name of the file is the client hostname just as with NIM. The netboot kernel file, after we copied the installation CDs/DVD, is located in `/export/fedora5/ppc/images/netboot`.

There are two files in this directory, `ppc32.img` and `ppc64.img` to be used for a 32-bit kernel and 64-bit kernel, respectively. One of these files (or both) needs to be copied to the `/tftpboot` directory, preferably to a name that reflects the distribution, version and kernel.

Also check ownership, group, and permission on the file. A symbolic link must be created from this file to the client hostname when a network installation is going to be performed; refer to Example 4-190.

*Example 4-190 Copying Linux distribution files and changing ownership permissions*

---

```
cp /export/fedora5/ppc/images/netboot/ppc32.img /tftpboot/ppc32.fc5.img
cp /export/fedora5/ppc/images/pxeboot/ppc64.img /tftpboot/ppc64.fc5.img
chown root.system /tftpboot/ppc32.fc5.img
chown root.system /tftpboot/ppc64.fc5.img
chmod 444 /tftpboot/ppc32.fc5.img
chmod 444 /tftpboot/ppc64.fc5.img
```

---

In order for clients to access the installation source over NFS, you need to export the corresponding directory; add the following lines to the `/etc/exports` file:

```
/export/fedora5/i386 -sec=sys,ro
```

```
/export/fedora5/ppc -sec=sys,ro
```

Or execute these commands:

```
mknfsexp -d /export/fedora5/i386 -B -S sys -t ro
mknfsexp -d /export/fedora5/ppc -B -S sys -t ro
```

## 4.7.2 Intel PXE configuration

When booting an Intel client with the Linux PXE kernel, a configuration file is needed on the installation server to tell the small Linux PXE kernel where to find the actual netboot kernel and ramdisk image.

**Note:** This configuration file *must* be located in directory /tftpboot/pxelinux.cfg.

The name of the configuration file is the client's IP-address translated to upper case hexadecimal format. For example, if our client's IP-address is 192.168.234.19, then the configuration filename would be C0A8EA13 as shown in Table 4-3.

Table 4-3 Example decimal-to-hex conversion

| Decimal | Hexadecimal |
|---------|-------------|
| 192     | C0          |
| 168     | A8          |
| 234     | EA          |
| 19      | 13          |

Newer versions of the Linux PXE kernel will first look for a filename of the client's ARP type code and hardware address in lower case hexadecimal with dash (-) separators. For example, with an Ethernet (ARP type 1) adapter with address 88:99:AA:BB:CC:DD, the Linux PXE kernel will search for a filename like 01-88-99-aa-bb-cc-dd.

Refer to the documentation included with the Linux PXE kernel for more details.

We recommend that you make the configuration files a symbolic link to a filename that is easier to remember (for example `fedora5.manual` or `fedora5.auto`).

```
cd /tftpboot/pxelinux.cfg
ln -s C0A8EA13 fedora5.manual
```

The format of the configuration file for Fedora5/i386 is shown in Example 4-191.

*Example 4-191 /tftpboot/pxelinux.cfg/fedora5.manual*

---

```
Install
SERIAL 0 9600
DEFAULT fedora5
LABEL fedora5
KERNEL fedora5/vmlinuz.fc5.i386
APPEND root=/dev/ram console=/dev/tty1 initrd=fedora5/initrd.fc5.i386.img
```

---

This is a basic configuration file that simply loads the netboot kernel and the ramdisk image. The installation on the client will be manual just as if installed with a CD/DVD. Table 4-4 shows the configuration line entry and its description.

*Table 4-4 Basic configuration file line entry and its description*

| <b>Line entry</b>               | <b>Description</b>                          |
|---------------------------------|---------------------------------------------|
| # Install                       | Comment                                     |
| SERIAL 0 9600                   | Enables serial port to act as a console     |
| DEFAULT fedora5                 | Sets the default command line               |
| LABEL fedora5                   | A label of the kernel to boot               |
| KERNEL fedora5/vmlinuz.fc5.i386 | Kernel image to boot                        |
| APPEND root=/dev/ram cons...    | Options appended to the kernel command line |

It is possible to specify a more options on the APPEND line; for example, to use a kickstart installation for a completely unattended installation. Detailed information about kickstart installation is beyond the scope of this book, but a sample configuration file using kickstart is provided in Example 4-192.

*Example 4-192 /tftpboot/pxelinux.cfg/fedora5.auto*

---

```
Install
SERIAL 0 9600
DEFAULT fedora5
LABEL fedora5
KERNEL fedora5/vmlinuz.fc5.i386
APPEND root=/dev/ram console=/dev/tty1 initrd=fedora5/initrd.fc5.i386.img
ks=nfs:192.168.234.10:/export/fedora5/kickstart/kickstart.i386.fedora5 ksdevice=eth0
PROMPT 0
```

---

This requires a kickstart configuration file; for information on Anaconda, the Fedora Linux installer, and Kickstart, see:

<http://www.fedora.redhat.com>

## PPC configuration

Because Fedora/ppc uses BOOTP for booting over the network, there are no configuration files to edit. When the system boots, a manual installation can be performed just as when booting with a CD/DVD.

As an alternative, kickstart can be used to automate the installation on ppc systems, but since it is currently not possible to append any command line parameters to the netboot kernel, they have to be specified at the firmware prompt. The Open Firmware prompt as shown in Example 4-193 can be accessed by pressing F8 at boot time.

*Example 4-193 Open firmware prompt*

---

```
1 = SMS Menu 5 = Default Boot List
6 = Stored Boot List 8 = Open Firmware Prompt

memory keyboard network scsi speaker ok

0>boot net ks=nfs:/192.168.234.10:/export/fedora5/kickstart/kickstart.i386.fedora5
```

---

The installation proceeds in kickstart mode just as with the automated PXE configuration.

## 4.8 Common Operating System Image (COSI) management

With the emergence of IBM Virtualization Engine™, the desire to create partitions using shared processors, virtual network interfaces, virtual disks and using NIM as the focal point for system management is becoming significantly more important.

Also, the appeals to maximize hardware and software resource utilization have prompted the reuse of NIM diskless and dataless clients as a more cost-effective solution to representing the logical partition carved up from the managed system.

Diskless clients are machines without disks; dataless clients are machines that have disks, but lack the necessary information to operate independently. Neither of these types of machines have the capability to boot by themselves, and they must rely on a common boot image, along with a NIM SPOT and other file system resources that reside on some server on the network, to operate correctly. The same resources can be used among different clients.

The original concept of diskless and dataless clients for use as graphical workstations has changed. For this reason, the term “thin server” is being used to describe these types of machines because of their limited and remote resource requirement. The term “common image” is used to describe the SPOT resource used by the thin servers.

In the following section, we define this terminology in more detail.

### 4.8.1 Thin server, diskless, dataless, and Common Operating System Image

#### ***Thin server***

As mentioned, a *thin server* is a machine that lacks the physical hardware or software to allow it to operate independently. This machine must rely on remote resources such as a Common OS Image (COSI) to operate correctly. The thin server will encompass both a diskless and a dataless machine.

#### ***Diskless machine***

As mentioned, a *diskless machine* is a machine that lacks a physical disk and must rely on a SPOT resource, a root resource, a dump resource, and a paging resource to run. Other, optional resources that a diskless machine uses are tmp, home, and shared\_home.

#### ***Dataless machine***

A *dataless machine* has a physical disk, but the disk holds no local operating system. This machine must rely on a spot resource for its operating system. It also requires a root resource and a dump resource. The paging resource is not required because the local disk can be used for paging. Other, optional resources that a dataless machine uses are tmp, home, and shared\_home.

#### **Thin server resources**

The following resources are provided by a NIM master or NIM resource server for the thin server clients to function, in either diskless or dataless mode:

**root** This is defined as a directory that will be NFS-mounted by thin server clients for storing a client's / (root) directories. When a client is initialized, the root resource will be populated with a client's configuration files. These configuration files are copied from the SPOT/COSI resource used by a client to boot, and as its operating system.

|                    |                                                                                                                                                                                                                                      |
|--------------------|--------------------------------------------------------------------------------------------------------------------------------------------------------------------------------------------------------------------------------------|
| <b>dump</b>        | This is defined as a directory that will be NFS-mounted by thin server clients for use as a dump device by the client for storing a client's dump files.                                                                             |
| <b>paging</b>      | This is defined as a directory that will be NFS-mounted by thin server clients for use as a paging device by the client.                                                                                                             |
| <b>home</b>        | This is defined as a directory that will be NFS-mounted by thin server clients for storing a client's specific /home directories.                                                                                                    |
| <b>shared_home</b> | This is defined as a /home directory shared by all clients. All thin server clients that use a shared_home resource will mount the same directory as the /home file system.                                                          |
| <b>tmp</b>         | This is defined as a directory that will be NFS-mounted by thin server clients for use as a /tmp file system on the clients.                                                                                                         |
| <b>cosi</b>        | A Common OS Image (COSI) is a repository that contains all the necessary software to bring thin server clients up to a functional state. For AIX systems, it is a Single Product Object Tree (SPOT) and provides a /usr file system. |

**Note:** The term COSI replaces the term SPOT for the tasks of managing thin servers and common images without requiring users to understand NIM.

## Thin server commands

With AIX 5L V5.3 TL5, the following new commands to manage Common OS Images and thin servers are introduced:

|               |                                                                         |
|---------------|-------------------------------------------------------------------------|
| <b>mkcosi</b> | Makes a Common Operating System Image (COSI) for use with thin servers. |
| <b>lscosi</b> | List information related to a Common Operating System Image (COSI).     |
| <b>chcosi</b> | Change a Common Operating System Image (COSI).                          |
| <b>cpcosi</b> | Clone a Common Operating System Image (COSI).                           |
| <b>rmcosi</b> | Remove a Common Operating System Image (COSI).                          |
| <b>mkts</b>   | Make a thin server.                                                     |
| <b>swts</b>   | Switch a thin server to a different COSI.                               |
| <b>lstts</b>  | List information related to a thin server.                              |
| <b>rmts</b>   | Remove a thin server.                                                   |
| <b>dbts</b>   | Debug a thin server.                                                    |

The COSI and thin server management can also be accessed through the SMIT `tscosi_client` fast path.

**Note:** The thin server commands use the NIM master database and the **nim command** can be used to manipulate the thin server NIM environments, just as if they were diskless or dataless NIM clients.

You can also use the **nim** command directly for several thin server operations such as to reboot a thin server named LPAR55 in NIM:

```
nim -o reboot LPAR55
```

On a NIM COSI object, these are the operations you can perform using the **nim** command directly:

|            |                                                          |
|------------|----------------------------------------------------------|
| reset      | Reset the COSI's NIM state                               |
| define     | Define a COSI                                            |
| change     | Change a COSI's attributes                               |
| remove     | Remove a COSI                                            |
| cust       | Perform software customization                           |
| sync_roots | Synchronize roots for all clients using a specified COSI |
| showres    | Show contents of a COSI                                  |
| maint      | Perform software maintenance                             |
| lslpp      | List LPP information about the COSI                      |
| fix_query  | Perform queries on installed fixes                       |
| showlog    | Display a log in the NIM environment                     |
| check      | Check the status of the COSI                             |
| lppchk     | Verify installed filesets in the COSI                    |

On a NIM thin server object, these are the operations you can perform using the **nim** command directly, depending on whether it is diskless or dataless:

|            |                                                 |
|------------|-------------------------------------------------|
| define     | Define a diskless or dataless thin server       |
| change     | Change a thin server's attributes               |
| remove     | Remove an thin server                           |
| allocate   | Allocate a resource for use by a thin server    |
| deallocate | Deallocate a resource                           |
| dkls_init  | Initialize a diskless thin server environment   |
| dtls_init  | Initialize a dataless thin server environment   |
| diag       | Enable a thin server to boot a diagnostic image |
| reset      | Reset a thin server's NIM state                 |
| check      | Check the status of a thin server               |
| reboot     | Reboot specified thin server                    |
| showlog    | Display a log in the NIM environment            |
| dbts       | Perform a dbts operation on a thin server       |
| swts       | Perform a swts operation on a thin server       |

## 4.8.2 Creating a Common OS Image

Assuming we have stored all necessary filesets for AIX 5L V5.3 with TL5 in tge /usr/sys/inst.images directory, we use the **mkcosi** command to create a COSI, as shown in Example 4-194.

### *Example 4-194 Creating a Common Operating System Image (COSI) resource*

---

```
root@master:/: mkcosi -s /usr/sys/inst.images -l /export/cosi cosi5305

Defining cosi5305_106646_lpp object...Preparing to copy install images (this will take several
minutes)...

/export/cosi/cosi5305_106646_lpp/RPMS/ppc/cdrecord-1.9-7.aix5.2.ppc.rpm
/export/cosi/cosi5305_106646_lpp/RPMS/ppc/mkisofs-1.13-4.aix4.3.ppc.rpm
/export/cosi/cosi5305_106646_lpp/installp/ppc/x1C.aix50.8.0.0.I
. . .
Now checking for missing install images...
All required install images have been found. This lpp_source is now ready.
done
Defining cosi5305 object...
Creating SPOT in "/export/cosi" on machine "master" from "cosi5305_106646_lpp" ...

Restoring files from BOS image. This may take several minutes ...

Installing filesets ...

Be sure to check the output from the SPOT installation
to verify that all the expected software was successfully
installed. You can use the NIM "showlog" operation to
view the installation log file for the SPOT.
. . .
done
Removing cosi5305_106646_lpp object definition...done
```

---

When the **mkcosi** command starts, it creates a temporary NIM lpp\_source, so we must ensure that the location file system has enough space to accommodate this requirement. Example 4-195 shows the temporary NIM lpp\_source created in Example 4-194.

### *Example 4-195 Displaying information on temporary lpp\_source for COSI creation*

---

```
cosi5305_106646_lpp:
 class = resources
 type = lpp_source
 locked = 258218
 Rstate = unavailable for use
 prev_state =
 location = /export/cosi/cosi5305_106646_lpp
```



```
alloc_count = 0
server = master
```

---

To display information about a COSI, we use the `lscosi` command. It has both a debugging verbose flag `-v`, and a detail verbose level flag `-l`, with levels **1**, **2** and **3**, to provide the user with detailed information. The `lscosi` command, with level one, is equivalent to the `lsnim` command with the `-l` flag; see Example 4-196.

*Example 4-196 Using the lscosi command*

---

```
root@master:/: lscosi -l1 cosi5305
cosi5305:
 class = resources
 type = spot
 plat_defined = chrp
 arch = power
 Rstate = ready for use
 prev_state = verification is being performed
 location = /export/cosi/cosi5305/usr
 version = 5
 release = 3
 mod = 0
 oslevel_r = 5300-05
 alloc_count = 1
 server = master
 if_supported = chrp.mp ent
 Rstate_result = success
```

---

To remove a COSI, use the `rmcosi` command:

```
root@master:/: rmcosi cosi5305
```

### 4.8.3 Creating a thin server

Use the `mkts` command to create resources to bring up a thin server, except the COSI, which has to be already available. The `mkts` command will initialize the thin server and create the dump, tmp, root, paging, home and shared\_home NIM resources, if the resources do not exist and their respective flags were specified.

The `mkts` command uses the `/export/nim` directory to create the necessary resources for the client, and the equivalent of a dataless machine. To create a diskless thin server, use the `-l` option, as shown in Example 4-197.

*Example 4-197 Using mkts to define a thin server definition*

---

```
root@master:/: mkts -i 10.1.1.55 -m 255.255.255.0 -g 10.1.1.1 -c cosi5305 -l LPAR55
```

Checking /export/nim space requirement...Defining LPAR55 object...done

Installing software in the root directories of any diskless or dataless clients served by this SPOT. This may take several minutes ...

---

If you get a message similar to the following one, create a /export/nim file system with enough space for the NIM resources that **mkts** is going to create:

```
dspmsg: Invalid argument index in message. May need more arguments on the
command line.
Checking define_ts[31]: 9.27 >
blocks^J143.70^J71.14^J21.98^J32.63^J13.13^J-^J1
7.72^J39.52^J2821.70^J1579.36 : syntax error
```

To display information about a thin server, use the **lstts** command as shown in Example 4-198. It has both a debugging flag (verbose **-v**), and a detail verbose level flag (**-l**), with levels **1**, **2** and **3**, to provide the user with detailed information. The **lstts** command, with level one, is equivalent to the **lsnim** command with the **-l** flag.

*Example 4-198 Using lstts to display thin server definition*

---

```
root@master:/: lstts -l1 LPAR55
LPAR55:
class = machines
type = dataless
comments = dataless client defined with mkts
platform = chrp
netboot_kernel = mp
if1 = net_10_1_1 lpar55 0
cable_type1 = N/A
Cstate = dataless install has been enabled
prev_state =
Mstate = currently running
boot = boot
dump = dump
root = root
spot = cosi5305
control = master
```

---

For our thin server, the /usr-COSI (formerly known as SPOT) together with the root, dump and paging file systems have been exported (/etc/exports), and can be viewed using the **exportfs** command as follows:

```
/export/cosi/cosi5305/usr -ro,root=lpar55:,access=lpar55:
/export/nim/root/LPAR55 -root=lpar55:,access=lpar55:
/export/nim/dump/LPAR55 -root=lpar55:,access=lpar55:
/export/nim/paging/LPAR55 -root=lpar55:,access=lpar55:
```

And in the /etc/bootptab file, there is a created network boot entry as follows:

```
lpar55:bf=/tftpboot/lpar55:ip=10.1.1.55:ht=ethernet:sa=10.1.1.2:sm=255.255.255.0:
```

```
BOOTP R = 1 BOOTP S = 2
FILE: /tftpboot/lpar55
FINAL Packet Count = 24729
FINAL File Size = 12660736 bytes.
load-base=0x4000
real-base=0x2000000
. . .

***** Please define the System Console. *****

. . .
Saving Base Customize Data to boot disk
Starting the sync daemon
Starting the error daemon
System initialization completed.
Starting Multi-user Initialization
 Performing auto-varyon of Volume Groups
 Activating all paging spaces
 Performing all automatic mounts
```

Figure 4-10 Booting a thin server

Now the thin server should be up and running using the NIM resource server for each of its needed resources, as shown in Figure 4-10.

Example 4-199 shows sample commands to illustrate the file system environment in the thin server. This particular thin server is created as a diskless thin server, but it has one disk allocated even though it is not currently used.

*Example 4-199 Commands on the thin server*

```
root@master:/: rsh lpar55

* *
* *
* Welcome to AIX Version 5.3! *
* *
* *
* Please see the README file in /usr/lpp/bos for information pertinent to *
* this release of the AIX Operating System. *
* *
* *

```

```

mount
node mounted mounted over vfs date options

master /export/nim/root/LPAR55 / nfs3 Jun 27 16:04 rw,hard,intr,llock,acl
master /export/cosi/cosi5305/usr /usr nfs3 Jun 27 16:04 ro,hard,intr,llock,acl

lsps -a
Page Space Physical Volume Volume Group Size %Used Active Auto Type
swapnfs0 --- --- 64MB 2 yes yes nfs

ipl_varyon -i
PVNAME BOOT DEVICE PVID VOLUME GROUP ID
hdisk0 NO 00cc544ecd1145720000000000000000 00cc544e00004c00

lspv
hdisk0 00cc544ecd114572 None

lsvg
0516-318 lsvg: No volume groups found.

```

---

To modify the / (root) file system for the thin server shown in Example 4-199 on page 305, edit files in /export/nim/root/LPAR55 directory, and for the thin server /usr file system, edit files in the /export/cosi/cosi5305/usr directory.

#### 4.8.4 Remove a thin server

To remove a thin server definition, use the `rmts` command. In Example 4-200, we first try to remove the LPAR55 thin server. Because it is not online in the first example, the command fails and we rerun it with the force flag `-f`.

*Example 4-200 Using rmts to remove a thin server definition*

---

```

root@master:/: rmts LPAR55
Removing LPAR55 object definition...failed
rmts: Unable to remove LPAR55.
Try using the force flag.

root@master:/: rmts -f LPAR55
Uninitializing LPAR55.
Removing LPAR55 object definition...done

```

---

Using the `nim` command operation `deallocate` in the following example will cause all remotely mounted resources to be removed from use by the thin server(in this case, LPAR55):

```
nim -Fo deallocate -a subclass=all LPAR55
```

This will cause all I/O to be blocked because the NFS file systems will no longer be available.

## 4.9 Using HACMP with HANIM

Starting with AIX 5L V5.3, Network Installation Manager (NIM) provides an integrated high availability feature called HANIM, which is presented in 4.1, “High Availability Network Installation Manager” on page 124.

However, when using HANIM, the NIM master and the alternate NIM master are not aware of each other’s state (because there is no keep alive information between primary and alternate NIM masters). The takeover of the role as acting NIM master is based on whether or not NIM clients want to use a specific system as their NIM master. The NIM master for a NIM client is specified in the clients’ `/etc/niminfo` file.

In this section, we show how IBM High Availability Cluster Multi-Processing (HACMP) can be used to automate HANIM takeover operations. The HACMP configuration shown is minimal, and the purpose is to automate the start and stop of the `nimesis` daemon under the control of SRC, and issue the appropriate `nim` commands to perform a takeover of NIM clients.

**Note:** Because HANIM does not make use of shared storage, HACMP is not involved in any disk takeover operation.

In this section, we use the following three POWER5 logical partitions as shown in Figure 4-11 on page 308:

|        |                                                                                                            |
|--------|------------------------------------------------------------------------------------------------------------|
| lpar55 | This is the first and original NIM master (HACMP cluster node one).                                        |
| lpar56 | This is the first and alternate NIM master (HACMP cluster node two).                                       |
| lpar6  | This is the first and only NIM client (already running as a NIM client to another NIM master environment). |

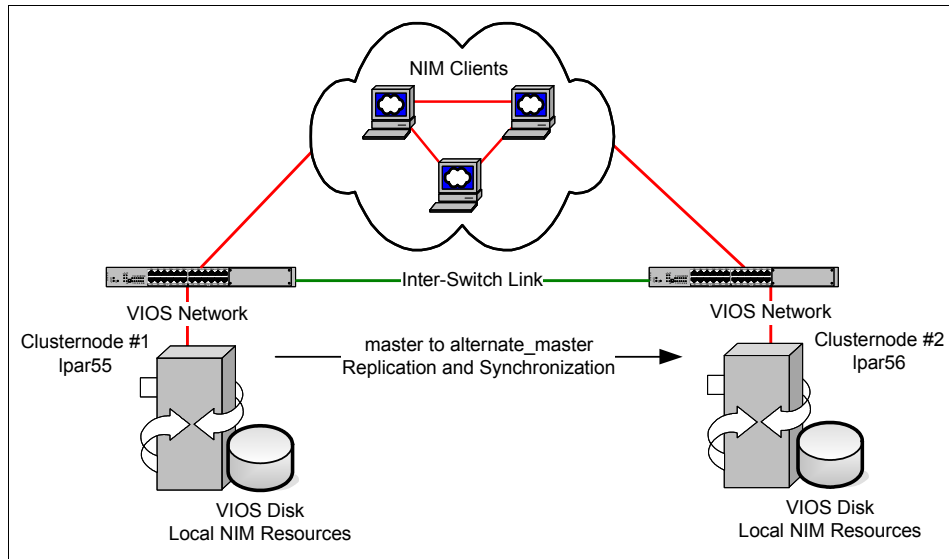

Figure 4-11 Graphic layout of our HACMP cluster setup for HANIM

All LPARs are configured using a VIO server for disk and network resources, and CPU micro-partitioning, as shown in Example 4-201.

*Example 4-201 Basic LPAR config for HACMP HANIM examples*

---

```

root@lpar56:/: lscfg -vl hdisk0
 hdisk0 U9111.520.65C544E-V6-C2-T1-L810000000000 Virtual SCSI Disk Drive

root@lpar56:/: lscfg -vl ent0
 ent0 U9111.520.65C544E-V6-C3-T1 Virtual I/O Ethernet Adapter (1-lan)

 Network Address.....223380006003
 Displayable Message.....Virtual I/O Ethernet Adapter (1-lan)
 Device Specific.(YL).....U9111.520.65C544E-V6-C3-T1

root@lpar56:/: lparstat -h
System configuration: type=Shared mode=Capped smt=0n lcpu=2 mem=512 psize=2 ent=0.10
. . .

```

---

The HACMP configuration will only use the ent0 network virtual network adapter on the cluster nodes, and all NIM database and resource file systems will be local to each of the two cluster nodes. HANIM functionality will be used to keep the database synchronized and resources replicated.

**Note:** In this scenario, we assume that one NIM master has all server resources that are needed to service the network (there are no additional resource servers).

The HACMP configuration is made using these assumptions and requirements regarding availability:

- ▶ The systems management personnel shall not have to restore and reconfigure the NIM server in case of hardware failure.
- ▶ The longest downtime for the NIM server shall be two hours.
- ▶ Hardware failures might occur during the NIM servers lifetime, but it is unlikely.
- ▶ Planned downtime will occur during the NIM servers' lifetime to install new firmware or system updates.
- ▶ In case of network failure, the NIM master can fail over to the alternate master.
- ▶ There will not be any service IP address, because HANIM will manage the NIM environment.
- ▶ In case of disk failure, the NIM master can fail over to the alternate master.

Based on the assumptions and requirements, we used the following software levels: AIX 5L V5.3 TL5, RSCT 2.4.5, and HACMP 5.4 (use SUMA to download updates to AIX 5L, RSCT and HACMP, respectively).

After the NIM master completes the BOS rte install of the LPARs used in this section, they are customized with the `nim` commands in Example 4-202 (becoming HACMP nodes).

The NIM client name, as shown in Example 4-202, is LPAR55. First, it is defined in the acting NIM master (hostname master), then an AIX 5L V5.3 TL5 SPOT (cosi5305) and NIM lpp\_source (lpp5305) are allocated, and finally the `bos_inst` operation is performed to reinstall the NIM client. After these steps, some additional bos filesets are installed together with the `bos.sysmgt.nim.master` fileset for NIM master functionality itself. Then the `rsct.basic.hacmp` and `rsct.basic.rte` and `cluster.es.server` filesets for HACMP are installed. The same steps are done for LPAR56.

*Example 4-202 NIM master additional software updates of HACMP nodes*

---

```
root@master:/: nim -o define -t standalone -a if1="net_10_1_1 lpar55 0" LPAR55
root@master:/: nim -o allocate -a spot=cosi5305 -a lpp_source=lpp5305 LPAR55
root@master:/: nim -o bos_inst -a source=rte LPAR55
```

```
root@master:/: nim -o cust -a lpp_source=lpp5305 -a installp_flags=agXY -a
filesets="bos.adt.libm bos.adt.syscalls bos.sysmgt.nim.master" LPAR55
root@master:/: nim -o cust -a lpp_source=hacmp54 -a installp_flags=agXY -a
filesets="rsct.basic.hacmp rsct.basic.rte cluster.es.server" LPAR55
```

---

Now we configure HACMP, and synchronize the HACMP nodes (lpar55 and lpar56), and bring up the cluster. First we make sure that `/etc/hosts` on each node contain the IP-address of both HACMP cluster nodes and of the client, lpar6. For our purposes, we use the following IP-addresses:

```
10.1.1.55 lpar55
10.1.1.56 lpar56
10.1.1.6 lpar6
```

We also add the `NSORDER` variable to `/etc/environment` to ensure that we use the local systems `/etc/hosts` file to resolve hostnames to IP-addresses (we could also use the `/etc/netsvc.conf` or `/etc/irs.conf` files for the same purpose, see “Setting up IP name resolution” on page 65):

```
NSORDER=local,bind
```

Because we use `rsh` to communicate between the HACMP cluster nodes, we update the `/.rhosts` and `/usr/sbin/cluster/etc/rhosts` file on each node. We include the IP-address of the other nodes IP-address in each file.

The `/.rhosts` looks like this in HACMP node lpar55:

```
10.1.1.56 root
```

And `/usr/sbin/cluster/etc/rhosts` on lpar55 looks like this:

```
10.1.1.56
```

The `.rhosts` on lpar56 looks like this:

```
10.1.1.55 root
```

And `/usr/sbin/cluster/etc/rhosts` on lpar56 looks like this:

```
10.1.1.55
```

We update the `/usr/sbin/cluster/netmon.cf` file and put IP addresses of known hosts to `PING` (because we only use a single network interface on each HACMP cluster node, and this will let our local node determine if it has a working network, when it cannot communicate with the other cluster node). In our case, we use the default gateway only:

```
10.1.1.254
```



**Note:** The HACMP cluster commands to create a HACMP cluster are in the `/usr/es/sbin/cluster/utilities/` directory. Include this in your path, or prefix each `cl` command shown here with the full path, or it will not work.

## HACMP configuration

Now we are ready to issue the first HACMP cluster command to initiate the HACMP cluster itself. Call it NIMESIS.

```
claddclstr -n NIMESIS
```

We continue by adding our two nodes, the NIM master (lpar55) and alternate NIM master (lpar56), picking up the communications interface (-p) from `/etc/hosts`:

```
clnodename -a lpar55 -p lpar55
clnodename -a lpar56 -p lpar56
```

We let HACMP collect information about disks on the nodes (but we will not use this information further):

```
clharvest_vg -w
```

Now we can create the default network and allow IP-address takeover to be performed via IP aliases (even if we will not use any specific service IP-address in the cluster):

```
clmodnetwork -a -n master_net -i ether -s 255.255.255.0 -l yes
```

We add the boot IP-addresses for each node to the HACMP master\_net Ethernet network:

```
claddnode -a lpar55:ether:master_net::boot: -n lpar55
claddnode -a lpar56:ether:master_net::boot: -n lpar56
```

To create the HACMP resource group, for the NIM master functionality, we first create the resource group itself:

```
claddgrp -g NIMESIS -n "lpar55 lpar56" -S "OHN" -O "FNPN" -B "NFB"
```

We create the HACMP application server for automating the HANIM takeover functionality (see "HACMP start and stop scripts for HANIM" on page 317 for more details about the scripts):

```
claddserv -s"NIMESIS" -b /local/rg/start.nimesis -e /local/rg/stop.nimesis
```

We add the HACMP application server (NIMESIS) to the HACMP resource group (NIMESIS):

```
claddress -g NIMESIS APPLICATIONS=NIMESIS
```

The additional configuration is to add the HACMP application server scripts on both nodes to be kept in sync by HACMP. This can easily be done by creating a file collection and adding the script files to this collection:

```
clfilecollection -o coll -a start_stop 'application start and stop scripts'
yes yes
clfilecollection -o file -a start_stop /local/rg/start.nimesis
clfilecollection -o file -a start_stop /local/rg/stop.nimesis
```

Now the cluster is configured. We just need to verify and synchronize with the peer node (lpar56) correcting minor errors if there are any; see Example 4-203.

```
cldare -rt -i -b -C yes
```

*Example 4-203 Partial output from cldare -rt -i -b -C yes*

---

The following file collections will be processed:

start\_stop

Starting file propagation to remote node lpar56.

Successfully propagated file /local/rg/start.nimesis to node lpar56.

Successfully propagated file /local/rg/stop.nimesis to node lpar56.

Total number of files propagated to node lpar56: 2

Verification to be performed on the following:

Cluster Topology

Cluster Resources

Verification will automatically correct verification errors.

Reading Cluster Topology Configuration...

Retrieving data from available cluster nodes. This could take a few minutes....

VERIFICATION NAME: base.ver\_determine\_active\_cluster

Thu Jun 29 16:49:13 2006

Determine if one or more nodes in the cluster are active.

. . .

Committing any changes, as required, to all available nodes...

Verification has completed normally.

---

## Checking the HACMP cluster configuration

Now we have a HACMP cluster with two nodes, one Ethernet interface each, nothing shared, and with one resource group. Example 4-204 shows our configuration displayed with the **cltopinfo** and **cllsres** commands.

*Example 4-204 HACMP cluster displayed with cltopinfo -i and cllsres*

---

```
root@lpar55:/: cltopinfo -i
```

| IP Label | Network    | Type  | Node   | Address   | If   | Netmask       |
|----------|------------|-------|--------|-----------|------|---------------|
| =====    | =====      | ====  | ====   | =====     | ==== | =====         |
| lpar55   | master_net | ether | lpar55 | 10.1.1.55 | en0  | 255.255.255.0 |
| lpar56   | master_net | ether | lpar56 | 10.1.1.56 | en0  | 255.255.255.0 |

```
root@lpar55:/: cllsres
APPLICATIONS="NIMESIS"
FILESYSTEM=""
FORCED_VARYON="false"
FSCHECK_TOOL="fsck"
FS_BEFORE_IPADDR="false"
RECOVERY_METHOD="sequential"
SSA_DISK_FENCING="false"
VG_AUTO_IMPORT="false"
```

---

## HANIM takeover operation

If a NIM client's /etc/niminfo file looks like the first example (lpar6, in this case), after the takeover operation is performed (from lpar55, in this case), it will be changed to look like the second example; see Example 4-205.

*Example 4-205 Changes to a NIM clients /etc/niminfo file by nim -o takeover*

---

```
{lpar6}:/ # cat /etc/niminfo
#----- Network Install Manager -----
warning - this file contains NIM configuration information
and should only be updated by NIM
export NIM_NAME=lpar6
export NIM_HOSTNAME=lpar6
export NIM_CONFIGURATION=standalone
export NIM_MASTER_HOSTNAME=lpar56
export NIM_MASTER_PORT=1058
export NIM_REGISTRATION_PORT=1059
export NIM_SHELL="shell"
export NIM_MASTER_HOSTNAME_LIST="lpar56 lpar55"
export NIM_BOS_IMAGE=/SPOT/usr/sys/inst.images/installp/ppc/bos
export NIM_BOS_FORMAT=rte
export NIM_HOSTS=" 10.1.1.6:lpar6 10.1.1.56:lpar56 "
export NIM_MOUNTS=""
```

```
root@lpar55:/: nim -o takeover lpar56
```

```
{lpar6}:/ # cat /etc/niminfo
#----- Network Install Manager -----
warning - this file contains NIM configuration information
and should only be updated by NIM
export NIM_NAME=lpar6
export NIM_HOSTNAME=lpar6
export NIM_CONFIGURATION=standalone
export NIM_MASTER_HOSTNAME=lpar55
export NIM_MASTER_PORT=1058
export NIM_REGISTRATION_PORT=1059
export NIM_SHELL="shell"
export NIM_MASTER_HOSTNAME_LIST="lpar55 lpar56"
```

```
export NIM_BOS_IMAGE=/SPOT/usr/sys/inst.images/installp/ppc/bos
export NIM_BOS_FORMAT=rte
export NIM_HOSTS=" 10.1.1.6:lpar6 10.1.1.55:lpar55 "
export NIM_MOUNTS=""
```

---

The **nim** command with the takeover operation are the core of what we use in our HACMP application start script.

### Starting the HACMP HANIM cluster

To start the HACMP HANIM cluster, you can use the SMIT `clstart` fast path as shown in Figure 4-12. Select the node you want to start the cluster manager on, in this case `lpar55` (we prefer to start the cluster managers sequentially and one at a time, at least until the primary node is up).

Start Cluster Services

Type or select values in entry fields.  
Press Enter AFTER making all desired changes.

|                                                          | [Entry Fields] |   |
|----------------------------------------------------------|----------------|---|
| * Start now, on system restart or both                   | now            | + |
| Start Cluster Services on these nodes                    | [lpar55]       | + |
| * Manage Resource Groups                                 | Automatically  | + |
| BROADCAST message at startup?                            | false          | + |
| Startup Cluster Information Daemon?                      | true           | + |
| Ignore verification errors?                              | false          | + |
| Automatically correct errors found during cluster start? | Interactively  | + |

*Figure 4-12 Starting HACMP cluster node*

After the same `clstart` has been performed for the second HACMP node (`lpar56`), we check the status of our NIMESIS resource group with the `clRGinfo` or `clfindres` commands as shown in Example 4-206.

#### *Example 4-206 Using clRGinfo*

```
root@lpar55:/: clRGinfo

Group Name Group State Node

NIMESIS ONLINE lpar55
 OFFLINE lpar56

```

We stop the NIMESIS resource group with the `clRGmove` command on `lpar55`, as shown in Example 4-207 on page 315.

*Example 4-207 Using c1RGmove to stop the HANIM resource group*

---

```
root@lpar55:/: c1RGmove -g NIMESIS -n lpar55 -d
Attempting to bring group NIMESIS offline on node lpar55.
```

Waiting for the cluster to process the resource group movement request....

Waiting for the cluster to stabilize.....

```
Resource group movement successful.
Resource group NIMESIS is offline on node lpar55.
```

---

We start the NIMESIS resource group with the **c1RGmove** command on lpar56, as shown in Example 4-208.

*Example 4-208 Using c1RGmove to start the HANIM resource group*

---

```
root@lpar55:/: c1RGmove -g NIMESIS -n lpar56 -u
Attempting to bring group NIMESIS online on node lpar56.
```

Waiting for the cluster to process the resource group movement request....

Waiting for the cluster to stabilize.....

```
Resource group movement successful.
Resource group NIMESIS is online on node lpar56.
```

---

We move the NIMESIS resource group with the **c1RGmove** command from lpar56 to lpar55, as shown in Example 4-209.

*Example 4-209 Using c1RGmove to move the HANIM resource group*

---

```
root@lpar55:/: c1RGmove -g NIMESIS -n lpar55 -m
Attempting to move resource group NIMESIS to node lpar55.
```

Waiting for the cluster to process the resource group movement request....

Waiting for the cluster to stabilize.....

```
Resource group movement successful.
Resource group NIMESIS is online on node lpar55.
```

---

Checking the movement with **c1findres** shows the process during the movement as shown in Example 4-210.

*Example 4-210 Checking HANIM resource group transfer between nodes*

---

```
root@lpar55:/: c1findres

```

```

Group Name Group State Node

NIMESIS OFFLINE 1par55
 OFFLINE 1par56
root@1par55:/: c1findres

Group Name Group State Node

NIMESIS ACQUIRING 1par55
 OFFLINE 1par56

root@1par55:/: c1findres

Group Name Group State Node

NIMESIS ONLINE 1par55
 OFFLINE 1par56

```

To examine how the HACMP cluster is performing, you can check the logfiles. For example, to check the `/tmp/hacmp.out` file on each cluster node, you can use the different `c1` commands, the `1ssrc` command, or the `1srsrc` command; Example 4-211 shows a few samples.

*Example 4-211 Examining the topology services daemon with `1ssrc -ls topsvcs`*

```

root@1par55:/: 1ssrc -ls topsvcs
Subsystem Group PID Status
topsvcs topsvcs 696454 active
Network Name Indx Defd Mbrs St Adapter ID Group ID
master_net_0 [0] 2 2 S 10.1.1.55 10.1.1.56
master_net_0 [0] en0 0x44a3eff8 0x44a3f07b
HB Interval = 1.000 secs. Sensitivity = 10 missed beats
Missed HBs: Total: 0 Current group: 0
. . .
Fast Failure Detection available but off.
 Dead Man Switch Enabled:
 reset interval = 1 seconds
 trip interval = 20 seconds
 Configuration Instance = 20
. . .
User time 0 sec. System time 0 sec.
Number of page faults: 0. Process swapped out 0 times.
Number of nodes up: 2. Number of nodes down: 0.

```

Using the `1ssrc` command to display information about the HACMP cluster manager shows the Dynamic Node Priority values (DNP) for node `1par55` and

lpar56 (in our simplified example, we do not use these features); see Example 4-212.

*Example 4-212 Examining the HACMP cluster manager with lssrc -ls clstrmgrES*

---

```
root@lpar55:/: lssrc -ls clstrmgrES
Current state: ST_STABLE
sccsid = "@(#)36 1.135.1.60 src/43haes/usr/sbin/cluster/hacmprd/main.C, hacm
p.pe, 52haes_r540, r5400622c 5/30/06 17:21:27"
i_local_nodeid 0, i_local_siteid -1, my_handle 1
ml_idx[1]=0 ml_idx[2]=1
There are 0 events on the Ibcst queue
There are 0 events on the RM Ibcst queue
CLversion: 9
local node vrmf is 5400
cluster fix level is "0"
The following timer(s) are currently active:
Current DNP values
DNP Values for NodeId - 1 NodeName - lpar55
 PgSpFree = 129807 PvpctBusy = 0 PctTotalTimeIdle = 99.708770
DNP Values for NodeId - 2 NodeName - lpar56
 PgSpFree = 130348 PvpctBusy = 0 PctTotalTimeIdle = 99.248557
```

---

## **HACMP start and stop scripts for HANIM**

Now we look at our HACMP scripts, as shown in Figure 4-13 on page 318. We use one script to start our services, and one script to stop our services. Because we use HANIM, the stop part is only to stop the nimesis SRC demon (the NIM master daemon).

The start script will make sure that the nimesis SRC daemon is started and will collect some information regarding the running cluster before it issues a `nim` command ordering takeover from the alternate NIM master (just in case it was the acting master for the NIM clients).

We have created the `/local` file system on each node, and a directory called `rg` in this file system. We place the scripts in the `/local/rg` directory and make sure they are synchronized between the cluster nodes.

```

#!/bin/ksh
start.nemesis
Synopsis.....%M%
Author.....User01
Created.....2006
Version.....%Z% %M% %I% (%E% %U%) %Q%
Description....N/A
Input.....N/A
Output.....Change the /etc/niminfo on all clients:
NIM_MASTER_HOSTNAME, NIM_MASTER_HOSTNAME_LIST and
NIM_HOSTS variables.
Algorithm.....Check if nimesis are running, start it if not,
perform takeover regardless.
#
#-----
trap 'exit 0' EXIT

export PATH=/usr/bin:/usr/sbin:/usr/es/sbin/cluster/utilities

NIMESISPID=$(lssrc -s nimesis|awk '!/PID/{if (/active/) print $3}')

if [[-z "$NIMESISPID"]] ;then
 printf "The \"nimesis\" SRC will be started.\n"
 startsrc -s nimesis
 sleep 6
else
 printf "The nimesis SRC is already running \"$NIMESISPID\".\n"
fi

ALTERNATE_MASTER=$(lsnim -Z -t alternate_master|awk -F: '!/^#{print $1;exit}')

printf "The NIM alternate_master is \"$ALTERNATE_MASTER\".\n"

[[-z "$ALTERNATE_MASTER"]] || nim -o takeover $ALTERNATE_MASTER

```

Figure 4-13 HACMP start.nemesis script

In both scripts, we always end with a trap to ensure we return zero (0) as the exit value. A non-zero return value from a HACMP application server will cause the HACMP resource group to fail and require recovery from script failure. We do not want that to occur, regardless of the outcome of our scripts.

The stop script will make sure that the nimesis SRC daemon is stopped as shown in Figure 4-14 on page 319.



```

#!/bin/ksh
stop.nemesis
Synopsis.....%M%
Author.....User01
Created.....2006
Version.....%Z% %M% %I% (%E% %U%) %Q%
Description....N/A
Input.....N/A
Output.....N/A
Algorithm.....Try to stop the nimesis SRC normally, if that does
not work, try to force it down.
#
#-----
trap 'exit 0' EXIT

export PATH=/usr/bin:/usr/sbin:/usr/es/sbin/cluster/utilities

NIMESISPID=$(lssrc -s nimesis|awk '!/PID/{if (/active/) print $3}')

if [[! -z "$NIMESISPID"]] ;then
 printf "The \"nimesis\" SRC will be stopped.\n"
 stopsrc -s nimesis >/dev/null 2>&1
 sleep 3
else
 printf "The \"nimesis\" SRC is already stopped.\n"
 exit
fi

NIMESISPID=$(lssrc -s nimesis|awk '!/PID/{if (/active/) print $3}')

if [[! -z "$NIMESISPID"]] ;then
 printf "The \"nimesis\" SRC will be terminated.\n"
 stopsrc -s nimesis -c >/dev/null 2>&1
fi

```

Figure 4-14 HACMP stop.nimesis script

## 4.10 NIM and Service Update Management Assistant

The Service Update Management Assistant (SUMA) allows system administrators to set up the capability of automating the download of maintenance fixes on a system and supports a comprehensive set of features:

- ▶ Automated task-based retrieval of multiple fix types (APAR, PTF, Critical, Security, Latest, Fileset, Maintenance Level, Technology Level).
- ▶ Three task actions allow for download preview, actual download of updates, or combining the download with a fix repository cleanup (utilizing **lppmgr**).

- ▶ Scheduling using **cron** allows policies to be run at various intervals in order to conform to necessary maintenance windows.
- ▶ There is e-mail notification of update availability and task completion.
- ▶ There is support for HTTP, HTTPS, and FTP transfer protocols and proxy servers.
- ▶ Filtering options allow comparisons against an installed software inventory or a Maintenance Level.

**Important:** SUMA is a complement to the UNIX servers product family portion of the IBM Support Fix Central Web site located at:

<http://www.ibm.com/eserver/support/fixes/>

You can use either the **suma** command or the **smit suma** fast path. The **suma** command can be found in `/usr/sbin` and the SUMA Perl libraries are in the `/usr/suma/lib/SUMA` directory. Configuration changes are saved in indexed files in the `/var/suma/data` directory. The SUMA log files can be found under the `/var/adm/ras` directory, and the basic log file is `suma.log`.

SUMA is installed as part of the base operating system of AIX 5L V5.3. Systems at AIX 5L V5.2 or AIX 5L V5.1 may need to install additional filesets in order to enable SUMA.

**Note:** You can find more information about the **suma** command at the following IBM Web sites:

<http://publib.boulder.ibm.com/infocenter/pseries/v5r3/index.jsp?topic=/com.ibm.aix.doc/cmds/aixcmds5/suma.htm>

<http://www14.software.ibm.com/webapp/set2/sas/f/suma/home.html>

<http://www.ibm.com/servers/aix/whitepapers/suma.html>

### **SUMA for AIX 5L V5.2 and AIX 5L V5.1**

For AIX 5L V5.2, you have to install either the 5200-05 Maintenance Level or the fixes and prerequisites shown in Table 4-5 on page 321. For AIX 5L V5.1, you have to install the fixes and prerequisites shown in Table 4-5 on page 321.

Table 4-5 SUMA for AIX 5L V5.2 and AIX 5L V5.1

| Description                                | Fileset                       | AIX 5L V5.2 | AIX 5L V5.1 |
|--------------------------------------------|-------------------------------|-------------|-------------|
| Service Update Management Assistant (SUMA) | bos.suma (install package)    | 5.2.0.0     | 5.1.0.0     |
| Service Update Management Assistant (SUMA) | bos.suma (update package)     | 5.2.0.1     | 5.1.0.1     |
| Perl Library Extensions                    | perl.libext (install package) | 2.0.58.0    | 2.0.56.0    |
| Perl Version 5 Runtime Environment         | perl.rte (update package)     | 5.8.0.10    | 5.6.0.10    |

## SUMA network connection

Remember that the system, in this case the NIM master, must have access to the Internet and use Internet Domain Name Service (DNS). SUMA needs to resolve the ibm.com domain and uses by default FTP (ports 20 & 21) and HTTP (port 80).

**Important:** Check that your system can resolve the names into IP addresses for the IBM support fix servers, and that you can reach them from your NIM or fix download servers.

First, use the classic ping test to the IBM support fix server; for example, with one PING only:

```
ping -c 1 www14.software.ibm.com
```

The output should look similar to Example 4-213 with: 0% packet loss.

### Example 4-213 Ping test to www14.software.ibm.com

---

```
root@master:/: ping -c 1 www14.software.ibm.com
PING dispsd-42-www14.boulder.ibm.com: (9.17.252.42): 56 data bytes
64 bytes from 9.17.252.42: icmp_seq=0 ttl=241 time=184 ms
```

```
----dispsd-42-www14.boulder.ibm.com PING Statistics----
1 packets transmitted, 1 packets received, 0% packet loss
round-trip min/avg/max = 184/184/184 ms
```

---

If the test is not successful, even after increasing the number of PINGs (-c 3), then check the system's /etc/resolv.conf file. If it exists, it indicates the DNS servers used by the system (ls /etc/resolv.conf or nameslv -s).

If this file is empty or does not have a valid DNS name listed, add a nameserver entry with a valid DNS IP address to the `/etc/resolv.conf` file by the `vi` editor, the SMIT `mknamerslv` fast path, or the `namerslv -a -i #.#.#.#` command (the `#.#.#.#` should be your IP address for your DNS server with Internet resolution of hostnames).

**Note:** If this computer has a `resolv.conf` that does not allow Internet resolution of hostnames or IP addresses, contact your network administrator responsible for the network and request Internet DNS and FTP/HTTP access for the system.

The following examples show how to use the `dig`, `host` and `nslookup` commands to resolve the SUMA default `FIXSERVER_URL`; see Example 4-219 on page 326. The `dig` command shown in Example 4-214 requests the DNS A record.

*Example 4-214 Checking DNS name resolution*

---

```
root@master:/: dig www14.software.ibm.com A

; <<> DiG 9.2.0 <<> www14.software.ibm.com A
;; global options: printcmd
;; Got answer:
;; ->HEADER<<- opcode: QUERY, status: NOERROR, id: 42846
;; flags: qr rd ra; QUERY: 1, ANSWER: 2, AUTHORITY: 0, ADDITIONAL: 0

;; QUESTION SECTION:
;www14.software.ibm.com. IN A

;; ANSWER SECTION:
www14.software.ibm.com. 138 IN CNAME dispd-42-www14.boulder.ibm.com.
dispd-42-www14.boulder.ibm.com. 45 IN A 10.1.252.42

;; Query time: 3 msec
;; SERVER: 10.1.0.14#53(10.1.0.14)
;; WHEN: Tue Jun 6 12:07:01 2006
;; MSG SIZE rcvd: 94

root@master:/: host www14.software.ibm.com
dispd-42-www14.boulder.ibm.com is 10.1.252.42, Aliases: www14.software.ibm.com

root@master:/: nslookup www14.software.ibm.com
Server: linux0.sapidi.mop.ibm.com
Address: 10.1.0.14

Non-authoritative answer:
```

Name: dispd-42-www14.boulder.ibm.com  
Address: 10.1.252.42  
Aliases: www14.software.ibm.com

---

Example 4-215 shows the `nslookup` command. There is an error message indicating that `nslookup` is not supported by the DNS, so use the `dig` or `host` commands instead.

*Example 4-215 Error message using nslookup with some DNS servers*

---

```
root@master:/: nslookup www14.software.ibm.com
*** Can't find server name for address 10.1.0.14:Non-existent host/domain
*** Can't find server name for address 10.2.0.14:Non-existent host/domain
*** Default servers are not available
```

---

## 4.10.1 Using SUMA

Before starting to use SUMA, you should know:

- ▶ *Which* systems you want to update
- ▶ *Why* you want to update these systems
- ▶ *What* software you want to update
- ▶ *When* you want to update which systems

Using SUMA should make it easier to keep system software updates current. However, it is not a recommended best practice to constantly be on the latest level of the operating system, unless it is absolutely necessary.

To understand what to download with SUMA, or from the IBM support fix central Web site, as well as the meaning of the new IBM service terminology for AIX 5L (TL, ML, CSP or SP), refer to 4.10.7, “IBM AIX Service Strategy” on page 347.

Performing software maintenance with SUMA allows you to automate download directly to the NIM master. However, it will *not* automatically create new (or update) either `lpp_source` or `SPOT`; this has still to be done manually.

For those to want to delay their adoption of a new Technology Level (TL) by a period of six to eight months, but take advantage of the latest tested group of PTFs available in a Concluding Service Pack (CSP), the Maximum Stability maintenance model for AIX may be appropriate. For more information on the practical handling of the model with SUMA, see “Maximum Stability maintenance model” on page 333.

The appropriate usage is to download updates using SUMA and then update the appropriate NIM `lpp_source` from the updates in the SUMA directory. The

manually newly updated lpp\_source can then be used to update the associated spot.

**Important:** Do not use basic SUMA to download directly to a NIM lpp\_source directory. The SUMA FilterDir parameter assists in not having to download into the lpp\_source directly. The `niminv` command with the `fixget` option has the same risk of downloading directly to the NIM lpp\_source directory. Refer to “The niminv command” on page 342 for more detailed information.

To obtain the latest fixes, you can use the `niminv` command for NIM machines or NIM lpp\_source objects, or the `compare_report` command for non-NIM systems.

For more detailed comparisons of the installed software (that is, what is available from your own NIM server lpp\_source, and what is available from the IBM Support Fix Central Web site), refer to 4.10.6, “Checking whether a system has all available updates installed” on page 341.

## 4.10.2 Settings for SUMA

You can view and configure the global configuration settings for SUMA with either the `suma` command and the `-D` flag, or through the SMIT `suma_config` fastpath. Example 4-216 shows the default display.

*Example 4-216 View the SUMA global configuration settings*

---

```
root@master:/: suma -D
 DisplayName=
 Action=Download
 RqType=Security
 RqName=
 RqLevel=
 PreCoreqs=y
 Ifreqs=y
 Supersedes=n
 ResolvePE=IfAvailable
 Repeats=y
 DLTarget=/usr/sys/inst.images
 NotifyEmail=root
 FilterDir=/usr/sys/inst.images
 FilterML=
 FilterSysFile=localhost
 MaxDLSize=-1
 Extend=y
```

In the following examples, we assume that the /export/lpp\_suma file system has been created<sup>3</sup>, and that different downloads are kept in separate directories under this file system mountpoint, such as the directory /export/lpp\_suma/5304 used for AIX 5L V5.3 TL04.

We want this to be reflected in the SUMA configuration, and we use the **suma** command with the **-D** flag and **-a attribute=value** to change specific attribute values, as shown in Example 4-218.

Example 4-217 shows the attribute `FilterSysFile` is set to `/dev/null` as the new default value. The `/dev/null` will prevent SUMA from filtering against the software inventory of the system that you are running on. The default download directory (`DLTarget`) and the default filter directory (`FilterDir`) are both set to `/export/lpp_suma`. In our scenario, this file system will only contain update level-specific directories, but by setting the defaults in this way, it saves on typing when using SMIT to create or execute SUMA tasks.

*Example 4-217 Update the SUMA global configuration settings*

---

```
root@master:/: suma -D -a DLTarget='/export/lpp_suma' -a FilterDir='/export/lpp_suma' -a
FilterSysFile='/dev/null'
```

---

Example 4-217 can also be done through the SMIT `suma_config_base` fastpath. To set the value to `/export/lpp_suma/5304` in SMIT, the path is already prepended and we only have to type: `5304`. By using `FilterDir`, we can perform downloads to the same directory and if the update is already there, it will not be downloaded again.

*Example 4-218 View the SUMA global configuration settings, after change*

---

```
root@master:/: suma -D
 DisplayName=
 Action=Download
 RqType=Security
 RqName=
 RqLevel=
 PreCoreqs=y
 Ifreqs=y
 Supersedes=n
 ResolvePE=IfAvailable
 Repeats=y
 DLTarget=/export/lpp_suma
 NotifyEmail=root
```

---

<sup>3</sup> `crfs -v jfs2 -g rootvg -a size=1G -m /export/lpp_suma -A yes -p rw -a agblksize=4096 -a logname=INLINE && mount /export/lpp_suma`

```
FilterDir=/export/lpp_suma
FilterML=
FilterSysFile=/dev/null
MaxDLSize=-1
Extend=y
MaxFSSize=-1
```

---

You can view and configure the general task settings for SUMA with either the **suma** command and the **-c** flag, or through the SMIT `suma_task_defaults` fastpath. Example 4-219 shows the default display.

*Example 4-219 View the SUMA general task settings*

---

```
root@master:/: suma -c
FIXSERVER_PROTOCOL=http
DOWNLOAD_PROTOCOL=ftp
DL_TIMEOUT_SEC=180
DL_RETRY=1
MAX_CONCURRENT_DOWNLOADS=5
HTTP_PROXY=
HTTPS_PROXY=
FTP_PROXY=
SCREEN_VERBOSE=LVL_INFO
NOTIFY_VERBOSE=LVL_INFO
LOGFILE_VERBOSE=LVL_VERBOSE
MAXLOGSIZE_MB=1
REMOVE_CONFLICTING_UPDATES=yes
REMOVE_DUP_BASE_LEVELS=yes
REMOVE_SUPERSEDE=yes
TMPDIR=/var/suma/tmp
FIXSERVER_URL=www14.software.ibm.com/webapp/set2/fixget
```

---

To change the general task configuration, we can use the **suma** command with the **-c** and **-a attribute=value** flags to change specific attribute values.

To change the download protocol from FTP to HTTP, issue the following **suma** command shown in Example 4-220.

*Example 4-220 Update the SUMA general task settings*

---

```
root@master:/: suma -c -a DOWNLOAD_PROTOCOL='http'
```

---

This setting can be helpful if you are constrained behind a firewall that only permits outgoing and returning HTTP traffic.



### 4.10.3 SUMA tasks

Example 4-221 shows how to create and execute a SUMA task to download all updates from 5300-00 to the latest. It downloads into the /export/lpp\_suma/5304 directory and only downloads filesets that are not already there. First, we create the 5304 directory in the /export/lpp\_suma file system.

*Example 4-221 Creating a SUMA task for downloading a TL*

---

```
root@master:/: mkdir /export/lpp_suma/5304
root@master:/: suma -wx -a DisplayName='5304' -a FilterML='5300-00'
-a DLTarget='/export/lpp_suma/5304' -a FilterDir='/export/lpp_suma/5304'
```

---

**Note:** In Example 4-221, in order to download the Technology Level (TL) requested, the RqType needs to be set to TL, and set RqName=5300-04. If the FilterDir parameter is left blank, it defaults to the same value as the DLTarget.

Example 4-221 can also be done through the SMIT suma\_task\_new fastpath. First, we create directory 5304 in the /export/lpp\_suma file system, if it has not been created already.

**Important:** The directory used for any SUMA task must exist *prior* to scheduling or executing the task. Otherwise, the task will not be accepted and you will get an error message similar to the following:

```
/export/lpp_suma/5304 must be an existing absolute path.
0500-049 The task is not valid.
```

To view all saved SUMA tasks, use the -l flag to the **suma** command as shown in Example 4-222 with one task defined.

*Example 4-222 View defined SUMA tasks*

---

```
root@master:/: suma -l
1:
 DisplayName=5304
 Action=Download
 RqType=Security
 RqName=
 RqLevel=
 PreCoreqs=y
 Ifreqs=y
 Supersedes=n
 ResolvePE=IfAvailable
 Repeats=y
 DLTarget=/export/lpp_suma/5304
```

```
NotifyEmail=root
FilterDir=/export/lpp_suma/5304
FilterML=5300-00
FilterSysFile=/dev/null
MaxDLSize=-1
Extend=y
MaxFSSize=-1
```

---

Example 4-222 on page 327 can also be done through the SMIT `suma_task` fastpath and then **View All SUMA Tasks**.

To execute a saved SUMA tasks, use the `-x` flag to the `suma` command as shown in Example 4-223, which starts the first task from Example 4-222 on page 327.

*Example 4-223 View execute a saved SUMA task*

---

```
root@master:/: suma -x 1
```

---

Example 4-223 can also be done through SMIT using the fastpath `smit suma_task_edit` -> **Execute Now (Do Not Save Changes)**.

From `cron`, to unschedule a saved SUMA task, add the `-u` flag to the `suma` command as shown in Example 4-224, which removes the first task from Example 4-222 on page 327.

*Example 4-224 Uncheduling a SUMA task*

---

```
root@master:/: suma -u 1
```

---

Example 4-224 can also be done using the SMIT `suma_task_delete` fastpath and setting Retain task data for future use to yes.

To delete a saved SUMA task, add the `-d` flag to the `suma` command as shown in Example 4-225, which removes the first task from Example 4-222 on page 327.

*Example 4-225 View a saved SUMA task*

---

```
root@master:/: suma -d 1
```

---

Example 4-225 can also be done using the SMIT `suma_task_delete` fast path and setting Retain task data for future use? to no.

## Checking for a new Technology Level monthly

This task checks monthly for a new specified Technology Level (TL). Because a TL is released approximately every six months, a monthly check may be

appropriate. For more information about the IBM Service Strategy, see 4.10.7, “IBM AIX Service Strategy” on page 347.

**Note:** Currently SUMA uses the previous terminology of ML (Maintenance Level) instead of TL (Technology Level). See 4.10.7, “IBM AIX Service Strategy” on page 347.

You may schedule a SUMA task with a command similar to the one shown Example 4-226 to check monthly (for example, on the first of every month at 00:30) whether a new TL has been released. The scheduling information (-s) is in crontab format (Minute Hour Day\_of\_month Month Weekday) for the root user.

The Repeats field should be set to y in order for the system to make monthly checks for the SP. After the SP is found, the task is deleted. If Repeats is set to n, then only a single check would occur before deleting the task. An e-mail notification will be sent with the results of the check, in this case to the root user at the localhost system. A TL or ML must be in the form xxxx-xx; for example 5300-05, as shown in Example 4-226.

*Example 4-226 Creating and scheduling a task that checks monthly for a new TL*

---

```
root@master:/: mkdir /export/lpp_suma/5305
root@master:/: suma -s "30 0 1 * *" -a Action=Preview -a RqType=ML -a RqName=5300-05 -a
FilterML=5300-04 -a Repeats=y -a DLTarget='/export/lpp_suma/5305' -a
NotifyEmail="root@localhost"
```

---

This command performs a preview (no download will occur) to check whether TL 5300-05 has been released. The FilterML setting specifies that the client already has filesets in the 5300-04 level. If 5300-05 has been released, the notification e-mail contains the list of filesets in the TL 5300-05 that was (or would be) downloaded.

If you only want to execute the query right away, and do not want to save or schedule it, use the -s flag. If 5300-05 is not yet available, the e-mail notification will contain a message similar to: Invalid requested ML level:V530005, as shown in Example 4-227.

*Example 4-227 Executing a task that downloads a specific new TL*

---

```
root@master:/: suma -x -a RqType=ML -a RqName=5300-05
-a FilterML=5300-04 -a DLTarget='/export/lpp_suma/5305'
```

```
0500-018 An internet request failed.
0500-014 The fix server responded with the following error condition:
 204|Invalid requested ML level:V530005.
```

---

**Note:** In Example 4-226, and in Example 4-227, the flag RqType=TL could be used because the TL is supported on 5300-05 and 5200-09.

You may also elect to automatically download the filesets in this TL by setting Action equal to Download instead of Preview as in the Example 4-226 on page 329. In this case, the filesets will only be downloaded, but no installation will occur.

### Checking and downloading a new Concluding Service Pack

This task checks weekly for a new specified Concluding Service Pack (CSP). CSPs are available shortly after a new TL is released. They contain all fixes for highly pervasive, critical, or security-related issues for the previous TL, but may also contain fixes from the newly released TL that fall into these categories. Therefore, a CSP will contain a very small subset of service that was just released as a part of a new TL.

A CSP must be in the form xxxx-xx-CSP (for example, 5300-04-CSP). Example 4-228 shows a scheduled SUMA task check monthly (for example, on the first of every month at 00:30) to see whether a new TL has been released. The scheduling information (-s) is in crontab format (Minute Hour Day\_of\_month Month Weekday) for the root user.

The Repeats field should be set to y in order for the system to make monthly checks for the SP. After the SP is found, the task is deleted. If Repeats is set to n, then only a single check would occur before deleting the task. An e-mail notification will be sent with the results of the check, in this case to the root user at the localhost system. The FilterML setting specifies that the client already has filesets in the 5300-04 level.

#### *Example 4-228 Task that checks monthly for a new CSP*

---

```
root@master:/: mkdir /export/lpp_suma/530004
root@master:/: suma -s "30 0 1 * *" -a Action=Preview -a RqType=SP
-a RqName=5300-04-CSP -a FilterML=5300-04 -a Repeats=y
-a DLTarget='/export/lpp_suma/530004' -a NotifyEmail="root@localhost"
```

```
0500-018 An internet request failed.
0500-014 The fix server responded with the following error condition:
 204|Invalid requested ML level:5300-04-CSP.
```

---

If 5300-04-CSP is not yet available, the e-mail notification will contain a message similar to: Invalid requested ML level:V5300-04-CSP, as shown in Example 4-228 on page 330.

## Checking and downloading a new Service Pack

This task checks weekly for a new specified Service Pack (SP), because SPs are expected to be released approximately every 4 to 6 weeks between TLs, which are released twice a year. An SP must be in the form xxxx-xx-xx (for example, 5300-04-03 as shown in Example 4-229). The `FilterML` setting specifies that the client already has filesets in the 5300-04 level. Remember that a Service Pack is just a tested group of PTFs; refer to 4.10.7, “IBM AIX Service Strategy” on page 347 for more detailed information about this topic.

**Note:** Example 4-229 shows a one-time execution to check and download a new service pack.

### *Example 4-229 Executing a task that downloads a specific new SP*

---

```
root@master:/: mkdir /export/lpp_suma/5304
root@master:/: suma -x -a RqType=SP -a RqName=5300-04-03
-a FilterML=5300-04 -a DLTarget='/export/lpp_suma/5304'
-a FilterDir='/export/lpp_suma/5304'

Performing preview download.

Download SKIPPED: bos.64bit.5.3.0.41.bff
Download SKIPPED: bos.adt.include.5.3.0.42.bff
Download SKIPPED: bos.adt.prof.5.3.0.43.bff
Download SKIPPED: bos.mp.5.3.0.43.bff
Download SKIPPED: bos.mp64.5.3.0.43.bff
...
Download SUCCEEDED: /export/lpp_suma/5304/installp/ppc/bos.rte.aio.5.3.0.41.bff
...
Summary:
 61 downloaded
 0 failed
 9 skipped
```

---

## Downloading the latest security fixes monthly

This task creates and schedules the download of the latest security fixes monthly, starting from ML 5300-00 (`FilterML`) using the `/export/lpp_suma/security` directory. The scheduling information (`-s`) is in crontab format (Minute Hour Day\_of\_month Month Weekday) for the root user. In Example 4-230, it is scheduled for the first of every month at 00:30, just after midnight, and the request type (`RqType`) is `Security`.

*Example 4-230 Task that downloads the latest security fixes monthly*

---

```
root@master:/: mkdir /export/lpp_suma/security
root@master:/: suma -s "30 0 1 * *" -a RqType=Security -a DisplayName="Monthly Security Fixes"
-a DLTarget='/export/lpp_suma/security' -a FilterML='5300-00'
-a FilterDir='/export/lpp_suma/security'
```

---

### **Checking and downloading a specific APAR once a week**

To create and schedule a task that checks for a specific APAR once a week, and then when it is available, to download it and e-mail that it has done so, you can refer to Example 4-231. The Repeats field should be set to y in order for the system to make weekly checks for an APAR. After the APAR is found, the task is deleted. If Repeats is set to n, only a single check would occur before deleting the task. An e-mail notification will be sent with the results of the check, in this case to the root user at the localhost system.

*Example 4-231 Task that checks and downloads a specific APAR*

---

```
root@master:/: mkdir /export/lpp_suma/apar
root@master:/: suma -s "0 3 * * 4" -a RqType=APAR -a RqName=IY12345 -a
NotifyEmail="root@localhost" -a Repeats=y -a DLTarget='/export/lpp_suma/apar'
-a FilterDir='/export/lpp_suma/apar'
```

---

If you only want to execute the query right away, and not save it or schedule it, replace the -s flag with the -x flag. If the APAR is not found, the 0500-035 message will be displayed; see Example 4-232.

*Example 4-232 Executing a task that checks and downloads a specific APAR*

---

```
root@master:/: suma -x -a RqType=APAR -a RqName=IY12345
-a DLTarget='/export/lpp_suma/apar' -a FilterDir='/export/lpp_suma/apar'
```

0500-035 No fixes match your query.

---

## **4.10.4 Maintenance models**

The three maintenance models (Maximum Stability, Yearly Update, and Latest Level) are recommendations based on the new IBM AIX 5L Service Strategy. For more information about this topic, see 4.10.7, “IBM AIX Service Strategy” on page 347.

In the following sections, we explain these maintenance models in greater detail.

## Maximum Stability maintenance model

The Maximum Stability maintenance model should monitor when a Concluding Service Pack (CSP) is released; refer to 4.10.7, “IBM AIX Service Strategy” on page 347. When the CSP comes out, it should be downloaded together with the previous Technology Level (TL).

With the Maximum Stability model, you are not moving to the latest TL when it is released, and you do not have to regularly check for the release of a TL or Concluding Service Pack (CSP). It is sufficient to check monthly for a new CSP; that is, because a CSP is released approximately every six months, a monthly check may be appropriate.

We recommend that you perform the following tasks for handling the Maximum Stability maintenance model:

1. Create a specific file system or directory for the CSP with corresponding TL.
2. Download the TL and then the CSP to the new file system or directory.
3. Create a new NIM lpp\_source based on the base level and adding the TL/CSP filesets.
4. Check the new NIM lpp\_source for duplicates with the **lppmgr** nim operation or standalone command; refer to “Removing duplicate filesets from a NIM lpp\_source directory” on page 339.
5. Create a NIM spot based on the new NIM lpp\_source.

Steps 1, 3, and 5 are covered in more detail in 3.1, “Setting up a basic NIM environment” on page 53). Step 4 is shown in 4.10.5, “Removing duplicate filesets from a NIM lpp\_source directory” on page 339.

### ***Downloading the TL and the CSP***

To check monthly whether a new CSP has been released for the next highest TL, you can schedule a SUMA task with a command similar to the one in Example 4-233 (for example, on the 15th of every month after midnight 00:01). When it is successful, an e-mail notification will be sent to the e-mail address specified in for the NotifyEmail attribute (in this case root@localhost), with the results of the check.

---

#### *Example 4-233 SUMA task to check for a coming CSP*

```
root@master:/: suma -s "1 0 15 * *" -a Action=Preview -a RqType=SP -a RqName=5300-04-CSP -a
FilterML=5300-04 -a Repeats=y -a NotifyEmail="root@localhost" -a
DLTarget=/export/lpp_suma/530004
```

Task ID 5 created.

---

The `suma` command used in Example 4-233 on page 333 returns a SUMA task ID (in this case, #5) which can be used to perform the actual download of the task. We perform this step after we have downloaded the corresponding TL, which is shown in Example 4-234.

*Example 4-234 SUMA task to download a TL for a newly released CSP*

---

```
root@master:/: suma -x -a RqType=ML -a RqName=5300-04 -a FilterML=5300-03 -a
DLTarget=/export/lpp_suma/530004
Extending the /export/lpp_suma filesystem by 194690 blocks.
Download SUCCEEDED: /export/lpp_suma/530004/installp/ppc/bos.suma.5.3.0.40.bff
. . .
Summary:
 225 downloaded
 0 failed
 32 skipped
```

---

The command in Example 4-234 downloads only TL 5300-04, but it contains all updates because the base level since each TL is cumulative. The first output line shows that the file system size was automatically increased (Extending).

After the TL is downloaded, it is time to download the CSP itself. The command in Example 4-235 could be used to download the previously scheduled task #5 for the 5300-04-CSP that had the Preview action defined to check for its release. Note that the Preview will have to be overridden with Download; otherwise, it will simply perform another preview.

*Example 4-235 SUMA task to download newly released CSP*

---

```
root@master:/: suma -x -a Action=Download 5
Download SUCCEEDED: /export/lpp_suma/530004/installp/ppc/bos.mp.5.3.0.43.bff
. . .
Summary:
 76 downloaded
 0 failed
 0 skipped
```

---

**Note:** With the default setting for SCREEN\_VERBOSE, the messages will be the same for Download and Preview actions, but the download will only be performed when Download is specified.

At this point, we are ready to create a NIM lpp\_source from the TL+CSP to use for updates or rte installation.



### ***Creating a NIM lpp\_source object with the base+TL+CSP***

To use a NIM lpp\_source based on GA level AIX 5L, updated with the Technology Level (TL) and its corresponding Concluding Service Pack (CSP), create a new NIM lpp\_source from a GA base level NIM lpp\_source.

Example 4-236, Example 4-237, and Example 4-238 show how the source attribute is set either to the NIM lpp\_source name of a GA base level NIM lpp\_source, or to a directory containing the Backup File Format (BFF) filesets. Example 4-236 shows how to use the NIM lpp\_source name of a GA base level as a source. In this case, the source NIM lpp\_source name is lpp5300.

#### *Example 4-236 Replicating a base level lpp\_source*

---

```
root@master:/: nim -o define -t lpp_source -a server=master -a source=lpp5300
-a location=/export/lpp_source/lpp5304 lpp5304
```

---

Example 4-237 shows how to use the GA base level BFF fileset directory as a source; in this case, the /export/lpp\_source/lpp5300/installp/ppc directory.

#### *Example 4-237 Replicating a base level lpp\_source from a directory*

---

```
root@master:/: nim -o define -t lpp_source -a server=master
-a location=/export/lpp_source/lpp5304
-a source=/export/lpp_source/lpp5300/installp/ppc lpp5304
```

---

We have downloaded AIX 5L V5.3 Technology Level (TL) 04 from IBM support fix central as shown in “Downloading the TL and the CSP” on page 333. To add this directory to the NIM master environment as a NIM lpp\_source resource, we do not have to declare the source because it is in the install format; see “File system hierarchy” on page 54.

#### *Example 4-238 Creating a NIM lpp\_source for a Technology Level (TL) update only*

---

```
root@master:/: nim -o define -t lpp_source -a server=master
-a location=/export/lpp_suma/530004 TL5304
```

Preparing to copy install images (this will take several minutes)...

Now checking for missing install images...

```
warning: 0042-267 c_mk_lpp_source: The defined lpp_source does not have the
"simages" attribute because one or more of the following
packages are missing:
 bos
 bos.net
 bos.diag
 bos.sysmgmt
 bos.terminfo
 bos.terminfo.all.data
```

```
devices.graphics
devices.scsi
devices.tty
x1C.rte
bos.mp
devices.common
bos.64bit
```

---

The 0042-267 message shown in Example 4-238 on page 335 warns us that the `simages` attribute was not set during creation, and therefore this NIM `lpp_source` cannot be used for NIM `rte` installation. However, it can be used for other operations such as an update, which is what we want to accomplish. Before using the new TL+CSP NIM `lpp_source`, we check and remove duplicate filesets with the `nim` command and `lppmgr` operation, as shown in Example 4-239. See also 4.10.5, “Removing duplicate filesets from a NIM `lpp_source` directory” on page 339.

---

*Example 4-239 Checking and removing duplicate filesets after updating with TL+CSP*

---

```
root@master:/: nim -o lppmgr TL5304
lppmgr: Source table of contents location is /export/lpp_suma/TL530004/installp/ppc/.toc
```

```
lppmgr: Building table of contents in /export/lpp_suma/TL530004/installp/ppc ..
lppmgr: Building table of contents completed.
lppmgr: Generating duplicate list..
lppmgr: Generating base level duplicate list..
```

Results:

```
===== start list =====
bos.64bit.5.3.0.40.U
bos.adt.include.5.3.0.41.U
bos.adt.prof.5.3.0.41.U
bos.adt.prof.5.3.0.42.U
bos.diag.com.5.3.0.10.U
bos.diag.rte.5.3.0.10.U
bos.diag.util.5.3.0.10.U
bos.mp.5.3.0.41.U
bos.mp.5.3.0.42.U
bos.mp64.5.3.0.41.U
bos.mp64.5.3.0.42.U
. . .
===== end list =====
```

```
lppmgr: Building table of contents in /export/lpp_source/lpp5304/installp/ppc .
lppmgr: Building table of contents completed.
rm: removing /export/lpp_source/lpp5304/installp/ppc/bos.64bit.5.3.0.40.U
rm: removing /export/lpp_source/lpp5304/installp/ppc/bos.adt.include.5.3.0.41.U
rm: removing /export/lpp_source/lpp5304/installp/ppc/bos.adt.prof.5.3.0.41.U
```

```
rm: removing /export/lpp_source/lpp5304/installp/ppc/bos.adt.prof.5.3.0.42.U
rm: removing /export/lpp_source/lpp5304/installp/ppc/bos.diag.com.5.3.0.10.U
rm: removing /export/lpp_source/lpp5304/installp/ppc/bos.diag.rte.5.3.0.10.U
rm: removing /export/lpp_source/lpp5304/installp/ppc/bos.diag.util.5.3.0.10.U
rm: removing /export/lpp_source/lpp5304/installp/ppc/bos.mp.5.3.0.41.U
rm: removing /export/lpp_source/lpp5304/installp/ppc/bos.mp.5.3.0.42.U
rm: removing /export/lpp_source/lpp5304/installp/ppc/bos.mp64.5.3.0.41.U
rm: removing /export/lpp_source/lpp5304/installp/ppc/bos.mp64.5.3.0.42.U
. . .
```

---

In Example 4-239 on page 336, some filesets were found to be duplicated. By default, the **nim** command **lppmgr** operation removes duplicate filesets.

Our new GA base level NIM **lpp\_source** can now be updated with the TL+CSP filesets. In Example 4-240, we use the NIM **lpp\_source** fileset directory of the TL+CSP as the source.

*Example 4-240 Updating base level lpp\_source from a TL directory*

---

```
root@master:/: nim -o update -a show_progress=yes -a packages=all -a source=TL5304 lpp5304

/export/lpp_source/lpp5304/installp/ppc/sysmgtlib.libraries.apps.5.3.0.40.U
/export/lpp_source/lpp5304/installp/ppc/sysmgtlib.framework.core.5.3.0.40.U
/export/lpp_source/lpp5304/installp/ppc/sysmgt.websm.apps.5.3.0.40.U
/export/lpp_source/lpp5304/installp/ppc/sysmgt.websm.rte.5.3.0.40.U
/export/lpp_source/lpp5304/installp/ppc/sysmgt.websm.icons.5.3.0.40.U
Filesystem size changed to 11993088
Inlinelog size changed to 23 MB.
. . .
```

---

In Example 4-240, you can see that both the filesystem and inline log sizes were changed during the NIM **lpp\_source** update. After updating, it is also a good idea to check for duplicate filesets with the **nim** command and **lppmgr** operation; see 4.10.5, “Removing duplicate filesets from a NIM **lpp\_source** directory” on page 339.

*Example 4-241 Removing duplicates with nim lppmgr operation*

---

```
root@master:/: nim -o lppmgr TL5304
lppmgr: Source table of contents location is /export/lpp_suma/530004/installp/ppc/.toc

lppmgr: Building table of contents in /export/lpp_suma/530004/installp/ppc ..
lppmgr: Building table of contents completed.
lppmgr: Generating duplicate list..
lppmgr: Generating base level duplicate list..
```

Results:

No filesets were found to be duplicated. The NIM lpp\_source is now ready to be used for installing and updating NIM clients using the Maximum Stability maintenance model.

### **Yearly Update maintenance model**

The Yearly Update model designed is for systems that are stable and that are planned to be only updated annually. This model shows an annual move to a new TL, and thereby skips the direct move to one of the two TLs that are released during the year (instead picking up this function when the next TL is installed, because TLs are cumulative).

In between TLs, you can use SPs, individual PTFs, and interim fixes (to address security and other issues) to maintain service on a TL for up to one year.

When moving to a new TL annually, we recommend that you install a first-half TL (for example, TL4, TL6, and so on), because it has the advantage of being a smaller release. A first-half TL (for example, TL6) will contain all the new AIX 5L software enhancements that were released with the previous TL (for example, TL5); however, TL5 will have already been in the field for six to eight months, thus allowing it to become more stable.

For examples of how to download TLs, see “Checking for a new Technology Level monthly” on page 328. For examples of how to download SPs, see “Checking and downloading a new Service Pack” on page 331.

### **Latest Level maintenance model**

The Latest Level model is for new systems or hardware-upgraded systems that require a new TL, or that want to utilize new hardware or software features being introduced in a TL. This maintenance model would typically entail a move to a new TL shortly after its release.

The annual first-half TL (for example, TL4, TL6, and so on) is a smaller TL release because it is restricted to hardware features and enablement, and software service. The annual second-half TL (for example, TL5) also includes new software features, and thus will be a larger release.

In between Technology Levels (TLs), you can utilize both Service Packs (SPs) and interim fixes (to address security and other issues) in support of the current Technology Level.

For examples of how to download TLs, see “Checking for a new Technology Level monthly” on page 328. For examples of how to download SPs, see “Checking and downloading a new Service Pack” on page 331.

## 4.10.5 Removing duplicate filesets from a NIM lpp\_source directory

Sometimes you will end up with duplicate filesets in the same directory. This can cause problems when installing and updating SPOTs or clients. These duplicates are just a waste of space, and they should be removed. This can be done when downloading filesets using SUMA to a specific directory, but if you move around filesets you need to take care of this manually. Before AIX 5L V5.3, this had to be done using customized scripts, but now it can be done with the **lppmgr** command or **lppmgr** operation with the **nim** command.

The SUMA global settings `REMOVE_CONFLICTING_UPDATES` and `REMOVE_DUP_BASE_LEVELS` will by default remove duplicate updates and base levels when downloading updates. See Example 4-219 on page 326.

To make sure that there are no duplicate filesets use the **lppmgr** command/operation to cleanup. This can be done either with the standalone command `/usr/lib/inst1/lppmgr`, that can be used to check any directory containing installable filesets or using the **nim** command and **lppmgr** operation.

In Example 4-242 and Example 4-243 on page 340, we have an `lpp_source` named `lpp5304` which contain the AIX 5L V5.3 TL04. We have after this release downloaded updates to AIX 5L V5.3 to the directory `/exports/lpp_suma/5304U`.

In the following **lppmgr** command in Example 4-242, the directory `/exports/lpp_suma/5304U` will be checked and all duplicate updates (-u) and base levels (-b) will be removed (-r).

```
/usr/lib/inst1/lppmgr -d /exports/lpp_suma/5304U -rub
```

The same applies for the NIM `lpp_source` object `lpp5304` using the **nim** command and **lppmgr** operation:

```
nim -o lppmgr -a lppmgr_flags=rub lpp5304
```

**Note:** The **lppmgr** command uses the path to the directory where the filesets are located, and the location attribute of the NIM `lpp_source` object is only part of this path.

Example 4-242 shows the usage of the **lppmgr** command to remove duplicate filesets from a directory. Example 4-243 on page 340 shows the same operation on the same directory, but using the **nim** command and the NIM object name for the `lpp_source`.

*Example 4-242 Using lppmgr command to clean up and remove duplicate filesets*

```
root@master:/: /usr/lib/inst1/lppmgr -d /export/lpp_source/lpp5304/installp/ppc -rub
```

```
lppmgr: Source table of contents location is /export/lpp_source/lpp5304/installp/ppc/.toc
```

```
lppmgr: Building table of contents in /export/lpp_source/lpp5304/installp/ppc ..
lppmgr: Building table of contents completed.
lppmgr: Generating duplicate list..
lppmgr: Generating base level duplicate list..
```

Results:

```
===== start list =====
bos.acct.5.3.0.30.bff
bos.adt.syscalls.5.3.0.40.bff
bos.clvm.enh.5.3.0.30.bff
bos.net.ewlm.rte.5.3.0.30.bff
bos.net.mobip6.rte.5.3.0.10.bff
bos.net.nfs.adt.5.3.0.30.bff
bos.net.nfs.cachefs.5.3.0.30.bff
bos.net.nfs.server.5.3.0.10.bff
bos.net.tcp.server.5.3.0.30.bff
bos.perf.diag_tool.5.3.0.40.bff
===== end list =====
rm: removing /export/lpp_source/lpp5304/installp/ppc/bos.acct.5.3.0.30.bff
rm: removing /export/lpp_source/lpp5304/installp/ppc/bos.adt.syscalls.5.3.0.40.bff
rm: removing /export/lpp_source/lpp5304/installp/ppc/bos.clvm.enh.5.3.0.30.bff
rm: removing /export/lpp_source/lpp5304/installp/ppc/bos.net.ewlm.rte.5.3.0.30.bff
rm: removing /export/lpp_source/lpp5304/installp/ppc/bos.net.mobip6.rte.5.3.0.10.bff
rm: removing /export/lpp_source/lpp5304/installp/ppc/bos.net.nfs.adt.5.3.0.30.bff
rm: removing /export/lpp_source/lpp5304/installp/ppc/bos.net.nfs.cachefs.5.3.0.30.bff
rm: removing /export/lpp_source/lpp5304/installp/ppc/bos.net.nfs.server.5.3.0.10.bff
rm: removing /export/lpp_source/lpp5304/installp/ppc/bos.net.tcp.server.5.3.0.30.bff
rm: removing /export/lpp_source/lpp5304/installp/ppc/bos.perf.diag_tool.5.3.0.40.bff
lppmgr: Building table of contents in /export/lpp_source/lpp5304/installp/ppc ..
lppmgr: Building table of contents completed.
```

---

In the output, you can see the two steps of the **lppmgr** command. The first step is to find and filter. The second step is the action on the filtered filesets (in this case, remove). Example 4-243 illustrates what the report should look when all the filesets are unique in the NIM lpp\_source, and there are no duplicates.

*Example 4-243 Cleaning up and removing duplicate filesets*

---

```
{nimmast}:/ # nim -o lppmgr -a lppmgr_flags=rub lpp5304
lppmgr: Source table of contents location is /export/lpp_source/lpp5304/installp/ppc/.toc
lppmgr: Building table of contents in /export/lpp_source/lpp5304/installp/ppc ..
lppmgr: Building table of contents completed.
lppmgr: Generating duplicate list..
lppmgr: Generating base level duplicate list..
```

Results:

```
No filesets found that can be removed.
```

---

## 4.10.6 Checking whether a system has all available updates installed

To determine whether a particular system needs a Technology Level (TL), a Concluding Service Pack (CSP), or a Service Pack (SP), refer to 4.10.7, “IBM AIX Service Strategy” on page 347. You will obtain the most detailed information by using the new **nminv** command (AIX 5L V5.3 TL5) for NIM machines, or NIM **lpp\_source** objects, and the **compare\_report** command for installed systems.

Start with the simplest steps to check a system's software levels by using the **lslpp** command, the **oslevel** command, and even the **instfix** command, as shown in Example 4-244.

You can start by using the **oslevel** command either with the **-s** flag or the **-r** flag, depending on your current system level. The **-r** option shows the recommended ML/TL, but the **-s** flag also shows the SP information.

*Example 4-244 Examples of using the lslpp, oslevel, and uname commands*

---

```
root@master:/: lslpp -qLc bos.rte | cut -f2-3 -d:
bos.rte:5.3.0.40

root@master:/: oslevel -r
5300-04

root@master:/: oslevel -s
5300-04-03

root@master:/: oslevel -g 5.3.0.0
Fileset Actual Level Maintenance Level

bos.rte 5.3.0.40 5.3.0.0

root@master:/: uname -s -v -r
AIX 3 5
```

---

In the **oslevel** command output, there are discrepancies between Actual Level and what the **oslevel** reports is the current level.

To obtain details about what is missing for a higher **oslevel** report, use the **instfix** command to check for the installed AIX levels, as shown in Example 4-245.

*Example 4-245 Using instfix to find current software level*

---

```
root@master:/: instfix -i|grep AIX
All filesets for 5300-02_AIX_ML were found.
All filesets for 5.3.0.0_AIX_ML were found.
All filesets for 5300-01_AIX_ML were found.
```

All filesets for 5300-03\_AIX\_ML were found.  
All filesets for 5300-04\_AIX\_ML were found.  
Not all filesets for 5300-05\_AIX\_ML were found.

---

It shows that 5300-05 is missing some filesets, because it reports: Not all filesets for 5300-05\_AIX\_ML were found. Thus, we use this as our next search argument with the **instfix** command to find out what is missing; see Example 4-246.

*Example 4-246 Using instfix to find missing software level*

---

```
root@master:/: instfix -icqk 5300-05_AIX_ML|grep ":-:"
5300-05_AIX_ML:sysmgplib.framework.core:5.3.0.50:5.3.0.40:-:AIX 5300-05 Update
5300-05_AIX_ML:sysmgplib.libraries.apps:5.3.0.50:5.3.0.40:-:AIX 5300-05 Update
```

---

This shows that two filesets were on a lower level, so we can either remove these filesets if they are unused, or update them.

### The **niminv** command

With AIX 5L V5.3 TL5, the new **niminv** command is introduced. The **niminv** command can gather, conglomerate, compare, and download fixes based on the installation inventory of NIM objects.

The **niminv** command extends the functionality of the **compare\_report** command to operate on several NIM objects such as machines and **lpp\_sources** at the same time. The **niminv** command uses the **suma** command to download fixes from the IBM Support Fix Central, and the **geninv** command to collect software inventory information from other systems.

**Note:** “Conglomerate” means that the inventories are put together without repeats of any filesets; the default action removes any higher versions of the fileset, so only the lowest version of each fileset appears in the conglomerated list.

The **geninv** command can also be used manually to collect software inventory information from other systems using IP addresses or resolvable hostnames.

You can also use the SMIT **nim\_inventory** fast path to perform **niminv** operations.

Example 4-247 on page 343 with the **niminv** command uses the **invget** operation and will collect an output file (**1s1pp -L** format) in the **/export/inventory** directory with the current software levels of the NIM master.



*Example 4-247 Using niminv to gather software inventory information*

---

```
root@master:/: niminv -o invget -a targets=master -a location=/export/inventory
Installation Inventory for master saved to /export/inventory/inventory.master.060620140643.
```

```
Return Status = SUCCESS
```

---

Example 4-248 also uses the **invget** operation, but collects software levels from a group of NIM clients, called `nim_clients`, but currently only containing one NIM client (`lpar55`).

*Example 4-248 Software inventory information for a NIM group of clients*

---

```
root@master:/: niminv -o invget -a targets=nim_clients -a location=/export/inventory
Installation Inventory for lpar55 saved to /export/inventory/inventory.lpar55.060620140605.
```

```
Return Status = SUCCESS
```

---

The **niminv** command with the **invcon** operation (conglomerate) compares the levels between different systems; see Example 4-249.

*Example 4-249 Software inventory information between different NIM clients*

---

```
root@master:/: niminv -o invcon -a targets=master,nim_clients -a base=highest
-a location=/export/inventory
Conglomerate of lpar55:master save to
/export/inventory/conglomerate.1.lpar55:master.060620140607.
```

```
Return Status = SUCCESS
```

---

To display the fixes that can be downloaded based on the lowest installations in a conglomerate of the `nim_clients` group and the NIM master, use the **fixget** operation as shown in Example 4-250. The text `Performing preview download` indicates that the following `Download SUCCEEDED` did not take place.

*Example 4-250 Using niminv to display available fixes*

---

```
root@master:/: niminv -o fixget -a targets=master,nim_clients

Performing preview download.

Download SUCCEEDED: /export/lpp_suma/installp/ppc/Java14.debug.1.4.1.0.bff
Download SUCCEEDED: /export/lpp_suma/installp/ppc/Java14.debug.1.4.1.7.bff
. . .
Summary:
 271 downloaded
 0 failed
 0 skipped
```

Return Status = SUCCESS

---

Example 4-251 shows the download of the latest fixes for the NIM master to a new `lpp_source`. The actual download will be performed with the `suma` command.

*Example 4-251 Using niminv to download available fixes*

---

```
root@master:/: niminv -o fixget -a targets=master -a download=yes -a
location=/export/lpp_source/lpp5304B -a newlppname=lpp5304B
```

```
Download SUCCEEDED: /export/lpp_source/lpp5304B/installp/ppc/
```

```
. . .
```

```
Summary:
```

```
 271 downloaded
 0 failed
 0 skipped
```

Return Status = SUCCESS

---

The `niminv` command will create both the `location` and the `newlppname` if they do not exist. If the `niminv` command is interrupted, it will perform a cleanup and remove all that was created, including the `location` and `newlppname`, giving you the following messages:

```
niminv: Signal received. Cleaning up.
Return Status: FAILURE
```

To download the latest fixes to an existing `lpp_source` while filtering from the same `lpp_source`, see Example 4-252.

*Example 4-252 Using niminv to download available fixes*

---

```
root@master:/: niminv -o fixget -a targets=master -a download=yes -a lpp_source=lpp5305
```

```
Extending the /AIX5305 filesystem by 979890 blocks.
Filesystem size changed to 5242880
Inlinelog size changed to 10 MB.
```

```
Download SUCCEEDED: /AIX5305/installp/ppc/Java14.msg.ko_KR.1.4.2.0.bff
```

```
. . .
```

```
Summary:
```

```
 271 downloaded
 0 failed
 0 skipped
```

Return Status = SUCCESS

---

The **niminv** command first extends the NIM lpp\_source objects file system, and then starts the download of new filesets.

**Note:** Any filesets already contained in the destination directory will not be downloaded again.

## The **compare\_report** command

The **compare\_report** command provides an easy way to check whether a specific system is at the latest level or latest Maintenance Level (ML). To determine the fixes that must be downloaded, run a comparison between the filesets installed on a standalone system and the contents of an image repository or a list of fixes available from the IBM Support Fix Central Web site.

The **compare\_report** command provides the following functions:

- ▶ Compares the filesets installed on a system to a list of fixes available from the IBM Support Web site or a fix repository, such as a NIM lpp\_source.
- ▶ Generates reports detailing which fixes are required for a system to be at the latest level or latest Maintenance Level.
- ▶ Reports can be uploaded to the “Compare report” page (select based on your desired operating system level) on the IBM Support Fix Central Web site:

<http://www.ibm.com/eserver/support/fixes/FixReleaseInfo.jsp?system=2&release=5.3>

The fixes can then be downloaded utilizing normal Web site interfaces or using SUMA; see 4.10.2, “Settings for SUMA” on page 324. (You need to change the value for the release attribute in order to change the AIX release.)

The **compare\_report** command can be used on systems that do not have access to the Internet. This prevents systems from using SUMA, which requires at least one system to have Internet access.

You can also use the SMIT `compare_report` fast path to perform **compare\_report** operations.

After you download the LatestFixData file from the eSupport Web site, you can send this file to a system to perform an offline comparison to determine which software updates are needed to bring the system or NIM lpp\_source to the latest level or latest ML/TL. The reports produced by **compare\_report** can be uploaded to the IBM Support Fix Central Web site to request the updates to be downloaded.

To check whether a specific system is backlevel compared to what is available from the IBM Support Fix Central Web site, manually download the fileset list from:

<http://www-912.ibm.com>

In our case, we downloaded by using the Open Source **wget** command, as shown in Example 4-253. The file (in our example, LatestFixData53) contains a list of fixes that are in the latest maintenance package, as well as the latest available fixes that have been released after the latest maintenance package. The file can also be found using a browser on the IBM Support Fix Central Web site by selecting pSeries (**Server**), AIX OS (**Product or fix type**), Fix release information (**Option**), and an operating system level.

*Example 4-253 Downloading LatestFixData53 from www-912.ibm.com*

---

```
root@master:/: cd /tmp
root@master:/tmp: wget
http://www-912.ibm.com/eserver/support/fixinfo/download?file=LatestFixData53
--17:27:01-- http://www-912.ibm.com/eserver/support/fixinfo/download?file=LatestFixData53
=> `download?file=LatestFixData53.1'
Resolving www-912.ibm.com... 129.42.160.32
Connecting to www-912.ibm.com[129.42.160.32]:80... connected.
HTTP request sent, awaiting response... 200 OK
Length: unspecified [application/x-servicereport]

[<=>] 46,118 86.11K/s

17:27:02 (85.98 KB/s) - `download?file=LatestFixData53.1' saved [46118]
```

---

Compare the downloaded file from IBM with your locally installed software using the **compare\_report** command or the SMIT `instolist_compare` fast path, as shown in Example 4-254.

*Example 4-254 compare\_report with LatestFixData53 and local system*

---

```
root@master:/tmp: compare_report -s -r LatestFixData53 -l -h
#(lowerthanlatest1.rpt)
#Installed Software that is at a LOWER level
#PTF:Fileset_Name:Installed_Level:Available_Level
U487072:Java14.sdk:1.4.2.20:1.4.2.75
. . .
#(higherthanmaint.rpt)
#Installed Software that is at a HIGHER level than
the latest Maintenance Level
#Fileset_Name:Installed_Level:Available_Level
bos.64bit:5.3.0.41:5.3.0.40
. . .
```

---

The files `lowerthanlatest1.rpt` and `higherthanmaint.rpt` are saved in a `/tmp` directory by default (this can be changed with the `-t <directory>` flag). They each contain a list of filesets and PTFs that are either lower than or higher than the latest ML/TL.

The Fix release information section of IBM Support Fix Central Web site allows you to upload a file that has been generated by the `compare_report` command.

The PTF numbers contained in the comparison report file will be used to provide the requested fixes. After uploading the file, you can download the requested fixes (PTFs) through the normal Fix Central interfaces by using the `suma` command or a file transfer tool such as `wget`.

### ***The wget Open Source tool***

If you do not have the `wget` command, you can use another tool or download it using a Web browser. Alternatively, you can install the WGET RPM package that is available from the IBM Open Source site (as shown in Example 4-255):

```
ftp.software.ibm.com
```

For more information about how to use the `rpm` command or the IBM Open Source FTP site, refer to *Linux Applications on pSeries*, SG24-6033, located at:

<http://www.redbooks.ibm.com/abstracts/sg246033.html>

#### ***Example 4-255 Installing Open Source wget from ftp.software.ibm.com***

---

```
root@master:/: rpm -iv
ftp://ftp.software.ibm.com/aix/freeSoftware/aixtoolbox/RPMS/ppc/wget/wget-1.9.1-1.aix5.1.ppc.rpm
Retrieving
ftp://ftp.software.ibm.com/aix/freeSoftware/aixtoolbox/RPMS/ppc/wget/wget-1.9.1-1.aix5.1.ppc.rpm
wget-1.9.1-1

root@master:/: wget
wget: missing URL
Usage: wget [OPTION]... [URL]...

Try `wget --help' for more options.
```

---

## **4.10.7 IBM AIX Service Strategy**

For detailed information about this topic, refer to the following IBM Web sites:

<http://www14.software.ibm.com/webapp/set2/sas/f/best/AIX5Lrel-svc-strat-chngs2007.pdf>

[http://www14.software.ibm.com/webapp/set2/sas/f/best/aix\\_service\\_strategy.pdf](http://www14.software.ibm.com/webapp/set2/sas/f/best/aix_service_strategy.pdf)

## 4.10.8 IBM Support Fix Central Web site

Figure 4-15 on page 348 displays a subset of a screen from the IBM Support Fix Central Web site:

<http://www.ibm.com/eserver/support/fixes/>

From this site you can download TLs, SPs, CSPs, PTFs, APARs and interim fixes from this site. However, sometimes you must make a service call to IBM support to obtain specific interim fixes of PTFs.

Use the `oslevel -s` command to determine the current operating system level. **Note:** "-s" is a new and not available on all machines.

| Technology Levels and Service Packs |                             |                |            |                                                      |
|-------------------------------------|-----------------------------|----------------|------------|------------------------------------------------------|
| Type                                | Name                        | Date           | Prereqs    | Description                                          |
| SP                                  | <a href="#">5300-04-03</a>  | May, 2006      | TL 5300-04 | SW fixes                                             |
| SP                                  | <a href="#">5300-04-02</a>  | April, 2006    | TL 5300-04 | SW fixes                                             |
| CSP                                 | <a href="#">5300-03-CSP</a> | March, 2006    | ML 5300-03 | SW fixes                                             |
| SP                                  | <a href="#">5300-04-01</a>  | March, 2006    | TL 5300-04 | SW fixes                                             |
| TL                                  | <a href="#">5300-04</a>     | February, 2006 |            | Preventive Maintenance and support for new hardware. |

Use the `oslevel -r` command to determine the current operating system level.

| Maintenance Level packages (legacy) |                         |                 |         |                                   |
|-------------------------------------|-------------------------|-----------------|---------|-----------------------------------|
| Type                                | Name                    | Date            | Prereqs | Description                       |
| ML                                  | <a href="#">5300-03</a> | September, 2005 |         | HW & SW enhancements and SW fixes |
| ML                                  | <a href="#">5300-02</a> | May, 2005       |         | HW & SW enhancements and SW fixes |

Figure 4-15 IBM Support Fix Central Web site screen

## 4.11 Backing up clients with NIM

Backing up a system can be performed in all the same ways as any AIX/Linux server. But for a system that is also a NIM client, you can also back up by using

NIM to create a mksysb image. However, using NIM to create a mksysb image file must be executed from the NIM master itself (a “pull” operation). Otherwise, you will receive the following message:

```
0042-012 nim: this command may only be executed on a NIM master
```

Example 4-256 shows how the `nim` command is used for creating a mksysb image file named `mksysb.lpar5` in the `/export/images` directory on the NIM master, first creating the `/image.data` file.

*Example 4-256 Creating a mksysb from a NIM client*

---

```
root@master:/: nim -o define -t mksysb -a server=master -a source=LPAR5
-a mk_image=yes -a location=/export/images/mksysb.lpar5 mksysb_lpar5
```

```
+-----+
 System Backup Image Space Information
 (Sizes are displayed in 1024-byte blocks.)
+-----+
```

```
Required = 868732 (848 MB) Available = 2398052 (2342 MB)
```

```
Data compression will be used by the system backup utilities which
create the system backup image. This may reduce the required space
by up to 50 percent.
```

```
Creating information file (/image.data) for rootvg..
```

```
Creating list of files to back up.
Backing up 26669 files.....
26669 of 26669 files (100%)
0512-038 savevg: Backup Completed Successfully.
```

---

The command executed in Example 4-256 on page 349 completed successfully, and both the specified `mksysb.lpar5` image file and the `mksysb_lpar5` NIM object are created.

**Note:** For naming NIM objects, using a dot (.) is unsupported. Therefore, we use an underscore ( \_ ) to enhance the readability of the name. For an AIX filename, it *is* supported to use one or more dots or underscore signs, and we could have used the NIM object name as file system name as well.

Here we use separate signs to differentiate the name for the NIM mksysb object and the mksysb image filename. For additional naming examples, see 3.1.1, “Planning the NIM environment” on page 53.

The command breakdown for the example shown in Example 4-256 on page 349 is as follows:

|                                         |                                                                                                 |
|-----------------------------------------|-------------------------------------------------------------------------------------------------|
| -o define                               | Specifies the operation (defining the object).                                                  |
| -t mksysb                               | Specifies that the object type is mksysb.                                                       |
| -a server=master                        | Specifies that the server to hold this object (the mksysb image file) is the NIM master itself. |
| -a source=LPAR5                         | Specifies the NIM client to be used as the source the mksysb image, in this case, LPAR5.        |
| -a mk_image=yes                         | Specifies that the mksysb image file should be created.                                         |
| -a location=/export/images/mksysb.lpar5 | Specifies the path and filename for the mksysb image file.                                      |
| mksysb_lpar5                            | Specifies the NIM object name for this mksysb image.                                            |

Other attributes that can be used are (use `nim -q define -t mksysb` for the latest command option):

|               |                                                                                                                                                                                                        |
|---------------|--------------------------------------------------------------------------------------------------------------------------------------------------------------------------------------------------------|
| mksysb_flags  | Used to specify flags for the creation of the mksysb image file; see the <b>mksysb</b> command options.                                                                                                |
| exclude_files | Can be used to specify the NIM object pointing to a file containing a list of file systems to exclude from the mksysb image file, like <code>exclude.rootvg</code> file for the <b>mksysb</b> command. |
| size_preview  | Used to determine the size requirement for the target mksysb image file.                                                                                                                               |
| comments      | Used to specify a description of the NIM mksysb object.                                                                                                                                                |
| verbose       | Used to increase the message verbosity throughout the operation progress.                                                                                                                              |
| group         | Used to specify a NIM group to create the mksysb resource in.                                                                                                                                          |



**Note:** The `nim -o define -t mksysb` command may not end immediately after the message: 0512-038 savevg: Backup Completed Successfully. because it has not finished processing yet. To view detailed progress, use the verbose attribute with a value higher than zero (0). For example `-a verbose=2`.

### 4.11.1 Space requirements

One essential element to consider when handling mksysb images from one or several servers is the space requirement. If there is *not* enough space available to store the mksysb image file in the directory specified by the `location` attribute (`-a location`), the `nim` command will terminate and display a message similar to the output shown in Example 4-257.

*Example 4-257 Creating a mksysb from a NIM client with insufficient storage space*

---

```
0042-001 nim: processing error encountered on "master":
 0042-001 m_mkbsi: processing error encountered on "LPAR5":
 0042-210 c_mkbsi: The maximum space required for the backup is greater than
the amount of free space in the target filesystem. To ignore space requirements
use the "-F" flag when defining the mksysb resource.
```

---

There are several ways to calculate how much space the mksysb image file will take. One way is to let NIM calculate it by adding the `-a size_preview=yes` attribute for the mksysb image file and object creation command.

Example 4-258 shows what to expect if there is not enough space available, in which case you need to manually increase the size of the file system, or else free up some space to meet the requirements of the mksysb image file.

*Example 4-258 Determining backup image storage space requirement*

---

```
root@master:/: nim -o define -t mksysb -a server=master -a source=LPAR5
-a size_preview=yes -a mk_image=yes -a mksysb_flags=-i
-a location=/export/images/mksysb.lpar5 mksysb_lpar5
```

```
+-----+
 System Backup Image Space Information
 (Sizes are displayed in 1024-byte blocks.)
+-----+
```

```
Required = 1132200 (1106 MB) Available = 785232 (767 MB)
```

Data compression will be used by the system backup utilities which create the system backup image. This may reduce the required space

by up to 50 percent.

---

The command shown in Example 4-258 reveals that there is only 767 MB of free space available at the designated location (`/export/images`), but the NIM required size for the `mksysb` image file is 1106 MB.

**Note:** The sizes calculated by the `nim` command are usually large because data compression is used by the system backup (which creates the system backup image). Thus, the final required space could be 50% less than the estimation.

### 4.11.2 NFS export during mksysb image file creation

During the allocation of NIM `mksysb` image files, only the file is exported to the NFS client. However, during `mksysb` creation, the parent directory is also exported. If you use that file system to create a `mksysb` image of a system while another system is restoring a `mksysb` image from that file system, you will get NFS errors.

To avoid this problem, use the `NIM_MKSYSB_SUBDIRS` environment variable on the NIM master, as shown in Example 4-259 on page 352.

When this variable is set to `yes`, then subdirectories are used to separate `mksysb` image files. The subdirectories are transparent to the user, but they provide separate locations for NFS exporting. The subdirectories are named after the NIM object for which they are created.

*Example 4-259 Using NIM\_MKSYSB\_SUBDIRS environment variable*

---

```
root@master:/: export NIM_MKSYSB_SUBDIRS=yes
root@master:/: nim -o define -t mksysb -a server=master -a source=LPAR5
-a mk_image=yes -a location=/export/images/mksysb.lpar5 mksysb_lpar5
```

---

The command shown in Example 4-259 will create the `mksysb` image file in the `/export/images/LPAR5` directory and not in the `/export/images` directory.

### 4.11.3 Exclude file for mksysb image creation

Just as with the system `mksysb` command, an exclude file can be used to prevent certain file systems or directories from being included in the `mksysb` image file creation.

First, you need to create the exclude file. The lines in this file are input to the pattern-matching conventions of the `grep` command to determine which files will

be excluded from the backup. For example, to exclude all the contents of the directory called `temp`, edit the exclude file to read as follows:

```
/temp/
```

To exclude the contents of the directory called `/tmp`, and avoid excluding any other directories which have `/tmp` in the pathname, edit the exclude file to read as follows:

```
^./tmp/
```

All files are backed up relative to the current working directory (CWD). To exclude any file or directory for which it is important to have the search match the string at the beginning of the line, use a caret (^) as the first character in the search string, followed by a dot (.), followed by the filename or directory to be excluded.

If the filename or directory being excluded is a substring of another filename or directory, use `^.` (a caret followed by a dot) to indicate that the search should begin at the beginning of the line and/or use the dollar (\$) sign to indicate that the search should end at the end of the line.

**Tip:** You can use the vi editor. If you are uncomfortable with this editor, you can create the first line in a new file with the echo command:

```
echo "FILESYSTEMPATTERN" > excludefilename
```

To add additional lines to the one above, use the `echo` command again as many times as required (note the double greater-than signs):

```
echo "FILESYSTEMPATTERN" >> excludefilename
```

After the exclude file is created, a NIM object of the `exclude_files` type has to be created, as shown in Example 4-260.

*Example 4-260 Creating the exclude\_files type NIM object*

---

```
root@master:/: nim -o define -a verbose=2 -t exclude_files -a server=master
-a location=/export/scripts/exclude.lpar5 exclude_lpar5
```

```
m_mkres: define the exclude_lpar5 resource
 ok_to_mk_obj: server=master; location=/export/scripts/exclude.lpar5
 set_Mstate: name=master
 checking for location collisions
 stat_file: server=master; location=/export/scripts/exclude.lpar5;
 file must have: st_mode = 04000453330; st_vfstype = "0 3"
 stat-ing the file "/export/scripts/exclude.lpar5"
```

---

To use the exclude file (from the NIM object exclude\_lpar5) to create a mksysb image file, use the exclude\_files attribute as shown in Example 4-261.

*Example 4-261 Using exclude\_files when creating mksysb image files*

---

```
root@master:/: nim -o define -t mksysb -a server=master -a source=LPAR5
-a mk_image=yes -a location=/export/images/mksysb.lpar5
-a exclude_files=exclude_lpar5 mksysb_lpar5
```

```
+-----+
 System Backup Image Space Information
 (Sizes are displayed in 1024-byte blocks.)
+-----+
```

```
Required = 869048 (849 MB) Available = 1332332 (1301 MB)
```

Data compression will be used by the system backup utilities which create the system backup image. This may reduce the required space by up to 50 percent.

Creating information file (/image.data) for rootvg..

```
Creating list of files to back up.
Backing up 26665 files.....
26665 of 26665 files (100%)
0512-038 savevg: Backup Completed Successfully.
```

---

## 4.12 Creating bundles, BFF, and RPM packages

Starting with AIX 5L 5.1, you can install Red Hat Package Manager (RPM)-formatted and InstallShield MutliPlatform (ISMP)-formatted packages in addition to the native AIX installation Backup File Format (BFF - installp-formatted packages).

In this section, we show how to create your own BFF and RPM packages, and how to use bundles to install these onto NIM clients.

**Note:** The procedures can also be used for standalone systems (that is, systems not belonging to a NIM environment).

The AIX product media (CD/DVD) contains BFF and RPM packages that are installed during the base operating system (BOS) installation. The BFF packages

are located by default in the following relative path under AIX installation media or NIM lpp\_source resource directories:

```
installp/ppc
```

The RPM packages are located in the following path:

```
RPMS/ppc
```

If you have media that contains ISMP packages, the packages are located in the following path:

```
ISMP/ppc
```

If you are using the **geninstall** command to install RPM or ISMP packages, use the prefix type to indicate to the **geninstall** command the type of package that you are installing. The package prefix types are the following:

|          |                    |
|----------|--------------------|
| <b>I</b> | BFF format         |
| <b>R</b> | RPM format         |
| <b>J</b> | ISMP format        |
| <b>E</b> | Interim Fix format |

For example, to install the openssl RPM package and the bos.perf BFF/installp package, type the following:

```
geninstall -d /dev/cd0 R:openssl I:bos.perf
```

The **geninstall** command detects that the openssl package is an RPM package type and runs the **rpm** command to install the openssl package. The **geninstall** command then detects that bos.perf is an BFF/installp package type and runs the **installp** command to install the bos.perf package. The process for uninstallation is similar to the installation process.

### 4.12.1 BFF (native installp packages)

The native AIX installation Backup File Format (BFF) is sometimes referred to as the “installp” format. The **mkinstallp** command allows you to create your own software packages for AIX in the BFF/installp format, and can be installed or removed with the **installp** command.

The **mkinstallp** command requires files that will be packaged to be in a directory structure such that the location of the file relative to the root build directory is the same as the destination of the file after installation.

After the contents of a package are located in the correct directory structure, the **mkinstallp** command prompts for basic package data. This data includes the package name, requisites, descriptions of files to be packaged, and more. The **mkinstallp** command will then generate a template file based on responses

given by the user. To prevent command-line prompting, template files can be created and edited directly by the user and passed to the `mkinstallp` command with the `-T` flag.

To create a BFF/installp package, you can use the following procedure:

1. Create the build structure.
2. Populate the build structure with programs and files.
3. Create the packaging template file, for use by the `mkinstallp` program.
4. Create the package file with the `mkinstallp` program.

In the following sections, we describe each step in more detail.

## Creating the build structure

We need to create the packaging buildroot directory. For our examples to create installation packages, we use the `/build` file system (directory) as the top level for our packages. We choose to use a separate file system for this purpose, and we create it as an Enhanced Journaled File System (`jfs2`):

```
crfs -v jfs2 -g rootvg -a size=120M -m /build -A yes -p rw -a
logname=INLINE
```

We mount the file system:

```
mount /build
```

We limit the access to this file system mountpoint to restrict everyone except the root user (removing read-write-execute permissions for group and others):

```
chmod go-rwx /build
```

We create a directory structure for the BFF package, with the root packaging directory of `/build/nodectust`, which will be the root (`/`) file system at install time. We will create a NIM client customization package, thus the `nodectust` name.

In the `/build` file system, we create our packages buildroot directories. In this example, we create the `nodectust` package buildroot directory:

```
mkdir -p /build/nodectust
```

Then we create subdirectories where our files will be stored. Our intention is that during the installation, specific files will be updated or replaced.

We replace the `/etc/motd` file if it already exists, and for this we create the `/etc` directory under `/build/nodectust`:

```
mkdir -p /build/nodectust/etc
```

## Populating the build structure

All installed files should be put in their respective directories under the buildroot. In our example, we create an motd file under the /build/nodectust/etc directory:

```
banner hello world >/build/nodectust/etc/motd
```

We set the file permissions on our new version of motd file to the same as the original (read-read-read only for owner-group-others):

```
chmod 444 /build/nodectust/etc/motd
```

## Creating the packaging template file

The `mkinstallp` template file contains specifications for the installation package. The template file can be included in the <buildroot> but not as part of the BFF package; refer to Figure 4-16 on page 357.

In our example, we choose to store our template file in the buildroot directory, the /build/nodectust directory (also referred to as <buildroot> in the following examples). The template file for this small package contains the following specification entries. We named the template file `nodectust.template` in the <buildroot> directory.

```
Package Name: NODECUST
Package VRMF: 1.0.0.0
Update: N
Fileset
 Fileset Name: NODECUST.rte
 Fileset VRMF: 1.0.0.0
 Fileset Description: NODECUST
 Bosboot required: N
 License agreement acceptance required: N
 Include license files in this package: N
Requisites:
ROOT Part: Y
ROOTFiles
 /etc
 /etc/motd
EOROOTFiles
EOFFileset
```

Figure 4-16 Example `mkinstallp` template file

We first declare the name of the package (Package Name). This will be used for creating the package file. The Fileset Name is the name is managed by the

**installp** command. It shows up in the software inventory, and it is seen by the **lspp** command.

### **Template file keywords**

Keywords with an asterisk (\*) are required. It will cause **mkinstallp** to fail if left blank or omitted in the template file. This is a list of the template file keywords:

|                                        |                                                                |
|----------------------------------------|----------------------------------------------------------------|
| Package Name*                          | Name of the package                                            |
| Package VRMF*                          | Version, Release, Modification, and Fix level of the package   |
| Update*                                | Is this an update package?                                     |
| Fileset*                               | Start of a new Fileset                                         |
| Fileset Name*                          | Name of the fileset                                            |
| Fileset VRMF*                          | VRMF of the fileset                                            |
| Fileset Description                    | Description of the fileset                                     |
| Bosboot required*                      | Is a <b>bosboot</b> required when installing this fileset?     |
| License agreement acceptance required* | Is license agreement acceptance required for this fileset?     |
| Name of license agreement              | Name of the license agreement (see <b>Note 1</b> )             |
| Include license files in this package  | Are the license files included in this package?                |
| License file path                      | Path of the license file(s) (see <b>Note 2</b> )               |
| Requisites                             | co/if/inst/pre-requisites for the fileset (see <b>Note 3</b> ) |
| USRFiles*                              | Start of the USR part files section                            |
| /path/to/file                          | File path (see <b>Note 4</b> )                                 |
| EUSRFiles*                             | End of the USR part files section                              |
| ROOT Part: [Y N]*                      | Is there a ROOT part included in this fileset?                 |
| /path/to/file                          | File path (see <b>Note 4</b> )                                 |
| EOROOTFiles*                           | End of the ROOT part files section                             |
| E0Fileset*                             | End of the Fileset                                             |

**Note 1:** The Name of license agreement is defined as LAR/path/to/license/agreement. License Agreement Requisite® (LAR).

The %L tag can be used in place of a hardcoded path to represent the locale of the machine that the package will be installed on. For example, if the package is installed in the en\_US locale, then %L will be converted to en\_US.



**Note 2:** A License file path is defined as LAF/path/to/license/file. License Agreement File (LAF). A conditional License file path is defined as LAF<lc\_LC>/path/to/license/file, where lc\_LC is the locale which is associated with the license file. An example conditional License file path is LAF<en\_US>/usr/swlag/en\_US/prod.la. Either type of path may be specified or both types. Multiple license file paths are separated by semicolons (;).

**Note 3:** Requisites are defined as \*Type Name VRMF;. Type may be coreq, ifreq, in streq, or prereq. Multiple requisites are separated by semicolons (;). Requisites may also be an absolute pathname of a file specifying multiple or complex requisites.

**Note 4:** The full path name for each file in the fileset must be listed in the files section. Any custom directories should also be listed in this section. For example, to package /etc/motd, list both /etc and /etc/motd in the files section. Each entity in the final package will have the same attributes (owner/group/permissions) that it had at build time, so you must ensure that file attributes in the build root are correct prior to running **mkinstallp**.

## Creating the BFF package file

When the packaging buildroot directory structure, and after all package files are in their right places and the template file is created, you can run the **mkinstallp** command to generate the package. In our example, we specify the build directory (-d) and our template file (-T) with the **mkinstallp** command as shown in Example 4-262:

```
mkinstallp -d /build/nodectust -T /build/nodectust/nodectust.template
```

### *Example 4-262 Creating a BFF/installp package file with mkinstallp*

---

```
root@master:/: mkinstallp -T /build/nodectust/nodectust.template -d /build/nodectust
Using /build/nodectust as the base package directory.
Cannot find /build/nodectust/.info. Attempting to create.
Using /build/nodectust/.info to store package control files.
Cleaning intermediate files from /build/nodectust/.info.
```

```
Using nodectust.template as the template file.
0503-880 mkinstallp: Warning: /etc/motd exists in another fileset on the system.
processing NODECUST 1.0.0.0 I package
processing NODECUST.rte 1.0.0.0 fileset
creating ./usr/lpp/NODECUST/liblpp.a
```

creating ./tmp/NODECUST.1.0.0.0.bff

---

The **mkinstallp** command creates additional directory structure under our buildroot, BFF support files, and the BFF package file itself.

The package file is created under the <buildroot>/tmp directory with the package name (VRMF) and suffixed with .bff. The VRMF consist of four digits representing the Version, Release, Maintenance/Modification and Fix numbering. In our example, the path to the BFF file is:

```
/build/nodecust/tmp/NODECUST.1.0.0.0.bff
```

Some of the support files are found in the <buildroot>/info directory, the <buildroot>/lpp\_name package information file, the <buildroot>/usr directory for the <buildroot>/usr/lpp/NODECUST/liblpp.a archive file and the <buildroot>/usr/lpp/NODECUST/inst\_root directory.

For additional information about the **mkinstallp** command and BFF package file format, refer to *AIX 5L Version 5.3 Commands Reference, Volume 3, SC23-4890*. Also refer to *General Programming Concepts: Writing and Debugging Programs, SC23-4896*, section “Packaging Software for Installation”.

## Examining the BFF package file

We can examine the BFF package file with the **restore** command. In Example 4-263, we use the quiet flag (-q) which prevents user input prompting, list (-T), verbose (-v) and device file (-f), and we specify the package filename.

*Example 4-263 Examining the content of mkinstallp BFF/installp package*

---

```
root@master:/build/nodecust/tmp: restore -qTvf NODECUST.1.0.0.0.bff
New volume on NODECUST.1.0.0.0.bff:
Cluster 51200 bytes (100 blocks).
 Volume number 1
 Date of backup: Mon Jul 3 11:13:46 2006
 Files backed up by name
 User root
 0 ./
 166 ./lpp_name
 0 ./usr
 0 ./usr/lpp
 0 ./usr/lpp/NODECUST
 1146 ./usr/lpp/NODECUST/liblpp.a
 0 ./usr/lpp/NODECUST/inst_root
 1004 ./usr/lpp/NODECUST/inst_root/liblpp.a
 0 ./usr/lpp/NODECUST/inst_root/etc
 480 ./usr/lpp/NODECUST/inst_root/etc/motd
 0 ./etc
```





Create a NIM lpp\_source resource with the **nim** command and **define** operation, as shown in Example 4-266.

*Example 4-266 The nim command and define operation for mkinstallp packages*

---

```
root@master:/: nim -o define -t lpp_source -a server=master -a location=/export/pkgs pkgs
```

Preparing to copy install images (this will take several minutes)...

Now checking for missing install images...

warning: 0042-267 c\_mk\_lpp\_source: The defined lpp\_source does not have the "simages" attribute because one or more of the following packages are missing:

- bos
- bos.net
- bos.diag
- bos.sysmgt
- bos.terminfo
- bos.terminfo.all.data
- devices.graphics
- devices.scsi
- devices.tty
- x1C.rte
- bos.mp
- devices.common
- bos.64bit

---

The warning message (0042-267) can be disregarded because we will not use this NIM lpp\_source to perform BOS (base operating system) installations. We will only use it for additional software installations and updates to already-installed systems. We verify the BFF packages and the NIM lpp\_source as shown in Example 4-267.

*Example 4-267 The lsnim command to display the BFF pkgs NIM lpp\_source*

---

```
root@master:/: lsnim -l pkgs
pkgs:
 class = resources
 type = lpp_source
 arch = power
 Rstate = ready for use
 prev_state = verification is being performed
 location = /export/pkgs
 alloc_count = 0
```

```
server = master
```

---

Verify that the intended installation packages are accessible with the `nim` command using the `lspp` operation for a list of the directory TOC as shown in Example 4-268.

*Example 4-268 The nim command and lspp operation for mkinstallp packages*

---

```
root@master:/: nim -o lspp pkgs
NODECUST
 NODECUST.rte
```

---

Now the `pkgs NIM lpp_source` can be allocated to NIM clients and be used to install the `NODECUST.rte` fileset.

## 4.12.2 RPM

The RPM Package Manager (RPM) is another popular package-based installation tool, used in many Linux distributions and also introduced in AIX for installing in AIX Toolbox for Linux packages. These packages are usually files with file names suffixed with `.rpm` and installed by the `rpm` command.

<http://www.rpm.org>

On AIX 5L V5.3, the `rpm.rte` fileset is version 3. You will have to use the `rpm` command with the `-ba` flags to build RPM packages.

With Linux systems using version 4 of RPM, you must use the `rpmbuild` command instead.

To create an RPM package, you can use the following procedure:

1. Creating the build structure
2. Populating the build structure with programs and files
3. Creating the packaging SPEC file, for use by the `rpm` program
4. Creating the package file with the `rpm` program

We describe these steps in more detail in the following sections.

### Creating the build structure

By default, the AIX RPM environment uses the `/opt/freeware/src/packages` directory as the top level for creating and building RPM packages. It is possible to change it to another top level, but for simplicity we choose to show the default method.

Under the `/opt/freeware/src/packages` directory, the subdirectories are used during different stages: during the build or the install of RPM packages:

|          |                                                             |
|----------|-------------------------------------------------------------|
| BUILD    | Source code hierarchy                                       |
| SPECS    | rpm SPEC specification file                                 |
| SOURCES  | gzip compressed tar archive created from the SPEC hierarchy |
| SRPMS    | Source RPM package                                          |
| RPMS/ppc | Binary RPM package for ppc architecture                     |

We create a NIM client customization package, named `NODECUST`. The package will only replace the `/etc/motd` file.

### Populating the build structure

All files that will be installed should be put in their respective directories under `<builddroot>`. In our example, we create an `motd` file under the `/opt/freeware/src/packages/BUILD/etc` directory:

```
banner hello world >/opt/freeware/src/packages/BUILD/etc/motd
```

We set the file permissions on our new version of `motd` file to the same as the original (read-read-read only for owner-group-others):

```
chmod 444 /opt/freeware/src/packages/BUILD/etc/motd
```

From the `BUILD` hierarchy, we create a source file, the `NODECUST-1.0-1.tar.gz` file that is simply created by piping the `tar` archive output to `gzip`, and redirecting the output to the source file (as shown in Example 4-269), named according to the naming convention mentioned.

#### *Example 4-269 Creating a compressed archive of BUILD directory*

---

```
root@master:/: cd /opt/freeware/src/packages/BUILD
root@master:/: tar cf - . | gzip -c > /opt/freeware/src/packages/SOURCES/NODECUST-1.0-1.tar.gz
```

---

The source and RPM package use the following basic naming convention, and expect the source file to be found in the `/opt/freeware/src/packages/SOURCES` directory:

```
<name>-<version>-<release>.<arch>.rpm
```

Where:

|         |                                                                                                               |
|---------|---------------------------------------------------------------------------------------------------------------|
| name    | The package name                                                                                              |
| version | The software version                                                                                          |
| release | The package Release (the number of times the package has been rebuilt using the same version of the software) |

arch                      The architecture the package was built under, such as  
i686, or ppc

## Creating the packaging SPEC specification file

The rpm SPEC specification file contains specifications for the installation package. The RPMs build and installation process is controlled by the SPEC file, which is the core of every RPM and SRPM (Source RPM).

By default, AIX **rpm** command uses the SPEC files in the `/opt/freeware/src/packages/SPECS` directory. For our examples, we use the SPEC file named `/opt/freeware/src/packages/SPECS/NODECUST.spec` as shown in Example 4-270.

### *Example 4-270 Sample RPM SPEC (.spec) file*

---

```
Name: NODECUST
Summary: NODECUST perform local customization
Version: 1.0
Release: 1
Group: System Environment/Base
License: INTERNAL USE ONLY
Source: NODECUST-1.0-1.tar.gz
%description
NODECUST perform local customization
%build
%install
%files
%_builddir/etc/motd
%post
cp %_builddir/etc/motd /etc/motd
```

---

We declare our motd file using a macro, the `%_builddir`, so the file is handled and installed by the **rpm** command to the `%_builddir/etc` directory (which translates to the `/opt/freeware/src/packages/BUILD/etc` directory).

**Note:** For information on available macros on AIX, look in the `/usr/opt/freeware/lib/rpm/macros` file.

We declare the Source to be the `NODECUST-1.0-1.tar.gz` file created from our BUILD hierarchy. The motd file will be extracted from the `tar.gz` file into the `/opt/freeware/src/packages/BUILD/etc` directory.

To put our version of the motd file in the `/etc` directory, we use a `%post` stanza. We use the **cp** command to copy from the `%_builddir` path to the file `/etc/motd`.



The next step is to actually build the binary and source packages by issuing the **rpm** command as shown in Example 4-271:

```
rpm -ba <SPEC file name>
```

#### *Example 4-271 Creating an RPM*

---

```
root@master:/: rpm -ba /opt/freeware/src/packages/SPECS/NODECUST.spec
Executing(%build): /bin/sh -e /var/opt/freeware/tmp/rpm-tmp.26112
+ umask 022
+ cd /opt/freeware/src/packages/BUILD
+ exit 0
Executing(%install): /bin/sh -e /var/opt/freeware/tmp/rpm-tmp.26112
+ umask 022
+ cd /opt/freeware/src/packages/BUILD
+ exit 0
Processing files: NODECUST-1.0-1
Finding Provides: (using /opt/freeware/lib/rpm/find-provides)...
Finding Requires: (using /opt/freeware/lib/rpm/find-requires)...
PreReq: /bin/sh
Wrote: /opt/freeware/src/packages/SRPMS/NODECUST-1.0-1.src.rpm
Wrote: /opt/freeware/src/packages/RPMS/ppc/NODECUST-1.0-1.aix5.3.ppc.rpm
```

---

This **rpm -ba** command generates the following RPMs:

```
/opt/freeware/src/packages/SRPMS/NODECUST-1.0-1.src.rpm
/opt/freeware/src/packages/RPMS/ppc/NODECUST-1.0-1.aix5.3.ppc.rpm
```

### **Installing the package with RPM**

The RPM package can now be installed with the **-i**, **-U**, or **-F** flags of the **rpm** command. In Example 4-272, we install the RPM package with the **-ivvv** options of the **rpm** command (install and three times verbose). The **-i** flag with **rpm** will only work if the RPM is not already installed on the system. If the RPM packages are already installed, use the **-U** or **-F** flags. To uninstall the RPM, check the proper package name with **rpm -qa**, and then use this name with **rpm -e**.

#### *Example 4-272 Installing RPM with rpm*

---

```
root@master:/: rpm -ivvv /opt/freeware/src/packages/RPMS/ppc/NODECUST-1.0-1.aix5.3.ppc.rpm
D: counting packages to install
D: found 1 packages
D: looking for packages to download
D: retrieved 0 packages
D: New Header signature
D: Signature size: 68
D: Signature pad : 4
D: sigsize : 72
D: Header + Archive: 1274
D: expected size : 1274
```

```
D: opening database mode 0x102 in /var/opt/freeware/lib/rpm
D: found 0 source and 1 binary packages
D: requires: /bin/sh satisfied by db provides.
D: installing binary packages
D: New Header signature
D: Signature size: 68
D: Signature pad : 4
D: sigsize : 72
D: Header + Archive: 1274
D: expected size : 1274
D: package: NODECUST-1.0-1 files test = 0
D: file: /opt/freeware/src/packages/BUILD/etc/motd action: create
D: running preinstall script (if any)
NODECUST-1.0-1
GZDIO: 7 reads, 516 total bytes in 0.000 secs
D: running postinstall scripts (if any)
+ cp /opt/freeware/src/packages/BUILD/etc/motd /etc/motd
```

---

In the output of Example 4-272, you see the creation of the `/opt/freeware/src/packages/BUILD/etc/motd` file, and the execution of our postinstall script that copies it to `/etc/motd`.

## Installing the RPM package with NIM

To use the `rpm` created package (or several such packages) with NIM, it needs to be available from a NIM `lpp_source` resource, just as any other RPM package. If you have several packages, create a separate NIM `lpp_source` for these specifically.

In the following examples, we assume that all packages are AIX VRMF (Version, Release, Maintenance/Modification and Fix)-independent.

Create the NIM `lpp_source` RPM directory:

```
mkdir -p /export/pkgs/RPMS/ppc
```

Copy all `rpm` created packages from the default `<builddroot>` directory:

```
cp /opt/freeware/src/packages/RPMS/ppc/*.rpm /export/pkgs/RPMS/ppc
```

Create a NIM `lpp_source` resource with the `nim` command and `define` operation as shown in Example 4-273.

*Example 4-273 The `nim` command and `define` operation for RPM packages*

---

```
root@master:/: nim -o define -t lpp_source -a server=master -a location=/export/pkgs pkgs
```

Preparing to copy install images (this will take several minutes)...

Now checking for missing install images...

warning: 0042-267 c\_mk\_lpp\_source: The defined lpp\_source does not have the "simages" attribute because one or more of the following packages are missing:

```
bos
bos.net
bos.diag
bos.sysmgt
bos.terminfo
bos.terminfo.all.data
devices.graphics
devices.scsi
devices.tty
xlC.rte
bos.mp
devices.common
bos.64bit
```

---

The warning message (0042-267) can be disregarded because we will not use this NIM lpp\_source to perform BOS (base operating system) installations. We only use it for additional software installations and updates. Verify and display the RPM packages and the NIM lpp\_source, as shown in Example 4-274.

*Example 4-274 The lsnim command to display the RPM pkgs NIM lpp\_source*

---

```
root@master:/: lsnim -l pkgs
pkgs:
 class = resources
 type = lpp_source
 arch = power
 Rstate = ready for use
 prev_state = verification is being performed
 location = /export/pkgs
 alloc_count = 0
 server = master
```

---

Verify that the intended installation packages are accessible with the `nim` command using the `lslpp` operation for a list of the directory TOC as shown in Example 4-275.

*Example 4-275 The nim command and lslpp operation for mkinstallp packages*

---

```
root@master:/: nim -o lslpp pkgs
NODECUST-1.0
```

Now, the pkgs NIM lpp\_source can be allocated to NIM clients and used to install the NODECUST-1.0 RPM fileset.

If we use both the installp/ppc and RPMS/ppc directory, the `nim` command with `lspp` operation will show the packages from both packaging formats as shown in Example 4-276.

*Example 4-276 The nim command and lspp operation for mkinstallp and rpm packages*

---

```
root@master:/: nim -o lspp pkgs
NODECUST
 NODECUST.rte
NODECUST-1.0
 NODECUST-1.0
```

---

## Bundles

A NIM `installp_bundle` resource represents a file that contains the names of filesets that should be managed by NIM.

During an installation or maintenance operation, NIM mounts the `installp_bundle` file on the client machine, and make it usable for the clients local `installp` command. NIM automatically unmounts the resource from the client when the operation has completed.

Use any editor to create bundle files, we recommend the `vi` editor, which can contain comments and fileset names. Lines beginning with the pound (`#`) sign are recognized as comments and are ignored by the installation process.

The following are examples of predefined bundles:

|               |                                                                                                                                                                                              |
|---------------|----------------------------------------------------------------------------------------------------------------------------------------------------------------------------------------------|
| BOS.autoi     | Bundle file that BOS Auto Install product options will be installed by bos install as part of base operating system installation on all systems.                                             |
| Server.bnd    | Bundle file that contains filesets/packages that are likely to be required by Server systems.                                                                                                |
| Graphics.bnd  | Bundle file that contains basic X11 software packages that provides support of graphical environments. Additional packages for graphical user interfaces are CDE.bnd, GNOME.bnd and KDE.bnd. |
| PerfTools.bnd | Bundle file that contains additional performance tools packages.                                                                                                                             |

The system bundles are located in the `/usr/sys/inst.data/sys_bundles` directory. To list the system bundles, type the following:

```
ls /usr/sys/inst.data/sys_bundles/*.bnd
```

## Using bundles with NIM

To create a bundle to be used as a NIM resource, create a file containing the filesets and packages to be installed. In this case we use the `/export/scripts` directory on the NIM master and call the file `nodecust.bundle`.

The file contains the package prefix type and then the package and fileset. The first line is the `NODECUST.rte` fileset we created in “Creating the BFF package file” on page 359 and the second line is the `NODECUST-1.0` RPM package we created in “Creating the packaging SPEC specification file” on page 366; see Example 4-277.

*Example 4-277 NIM installp\_bundle file*

---

```
I:NODECUST.rte
R:NODECUST-1.0
```

---

Next, we create the NIM `installp_bundle` resource pointing to the bundle file with the `nim -o define` command, and with the `installp_bundle` type. In this case, we call our NIM resource `bundle_nodecust` as shown in Example 4-278.

```
nim -o define -a server=master -t installp_bundle -a
location=/export/scripts/nodecust.bundle bundle_nodecust
```

We can examine the NIM `installp_bundle` resource with the `lsnim` command.

*Example 4-278 The installp\_bundle NIM resource*

---

```
bundle_nodecust:
 class = resources
 type = installp_bundle
 Rstate = ready for use
 prev_state = unavailable for use
 location = /export/scripts/nodecust.bundle
 alloc_count = 0
 server = master
```

---

## Installing NIM bundle (installp\_bundle)

To install the software specified in the bundle file, you can run the `nim` command and `cust` operation. In Example 4-279, we install the NIM `bundle_nodecust` on the NIM client `LPAR55`. Note that the installation process by default starts with the RPM packages.

*Example 4-279 nstallp\_bundle containing both BFF/installp and RPM packages*

---

```
root@master:/: nim -o cust -a lpp_source=pkgs -a installp_flags=agXY -a
installp_bundle=bundle_nodecust LPAR55
```

Validating RPM package selections ...

```
NODECUST #####
```

```
+-----+
```

Pre-installation Verification...

```
+-----+
```

Verifying selections...done

Verifying requisites...done

Results...

SUCSESSES

-----

Filesets listed in this section passed pre-installation verification  
and will be installed.

Selected Filesets

-----

NODECUST.rte 1.0.0.0

# NODECUST

<< End of Success Section >>

FILESET STATISTICS

-----

1 Selected to be installed, of which:  
1 Passed pre-installation verification

----

1 Total to be installed

```
+-----+
```

Installing Software...

```
+-----+
```

installp: APPLYING software for:

NODECUST.rte 1.0.0.0

Finished processing all filesets. (Total time: 1 secs).

```
+-----+
```

Summaries:

```
+-----+
```

Installation Summary

| Name         | Level   | Part | Event | Result  |
|--------------|---------|------|-------|---------|
| NODECUST.rte | 1.0.0.0 | USR  | APPLY | SUCCESS |
| NODECUST.rte | 1.0.0.0 | ROOT | APPLY | SUCCESS |

## 4.13 NIM and Virtual I/O (VIO)

If your environment has an IBM System p5 running in AIX 5L V5.3, and is connected to a Hardware Management Console (HMC), you can set up a VIO server. The VIO server provides Virtual SCSI that allows you to create more partitions (VIO clients) than the number available physical storage and network adapters in the IBM System p5 Central Electronic Complex (CEC). It also enables you to share I/O resources between partitions.

Furthermore, the VIO server provides shared Ethernet capabilities to allow multiple partitions to share Ethernet adapters if those partitions need to access the external network.

If you have an environment where most of your partitions are within a POWER5 server, you can configure the NIM master in one of the VIO clients. With this, you can configure the NIM network to allow high speed interpartition communication within the same server through the POWER Hypervisor VLAN.

### 4.13.1 Virtual SCSI

When you need to create multiple partitions but do not have enough SCSI/FC adapters, you can set up a VIO server to share the storage resources.

Virtual SCSI is based on a client/server model. The VIO server acts as a server owning the physical resources, and the partition is a client accessing the Virtual SCSI resources provided by the server.

For every VIO client, you need to create a dedicated virtual SCSI adapter. After it is created, you can use a VIO server's physically-attached disks in two ways: assigning LV(s) from a VG to the VIO client; or assigning one entire LUN (hdisk) to the VIO client.

For a brief description of the Virtual SCSI server and client adapter in the Hardware Management Console (HMC), as well as the LV and disk configuration and how they are mapped to the virtual SCSI server adapter, refer to 4.13.4, "Setting up the VIO server and configuring the NIM master in the VIO client" on page 374.

In Virtual I/O server version 1.2, virtual optical devices such as DVD-ROM or DVD-RAM are also supported. You can create a virtual optical device from the physical optical device. With this virtual optical device, partitions are able to share the physical optical device in the VIO server.

### **4.13.2 Virtual Shared Ethernet**

Virtual Ethernet allows interpartition communication without any physical network adapter. But if your partitions need to communicate with the external network, you need to configure a Shared Ethernet Adapter (SEA) in the VIO server. The Shared Ethernet Adapter provides the connection between the physical network with the virtual network. It enables multiple partitions to share the same physical network adapter.

### **4.13.3 Considerations when using a VIO server**

We recommend that you allocate sufficient CPU resources to the VIO server or even use two VIO servers: one performing the Virtual SCSI, and the other performing the Virtual Ethernet. It is also a good idea to have VIO server redundancy so that you can perform any VIO server maintenance, should you need to bring down the VIO server during maintenance.

Refer to Chapter 5, *Advanced POWER Virtualization on IBM System p5*, SG24-7940, for more detailed information about VIO redundancy.

### **4.13.4 Setting up the VIO server and configuring the NIM master in the VIO client**

This section describes the steps to set up the Virtual SCSI and Virtual Ethernet on a VIO server. We assume you already know how to create profiles in the Hardware Management Console (HMC) and set up the VIO server. The emphasis here is on Virtual SCSI and the Virtual Ethernet. Refer to *Advanced POWER Virtualization on IBM System p5*, SG24-7940, for more detailed information.

Figure 4-17 shows the disk setup of the VIO server with two VIO clients. One of the clients is configured as the NIM master.



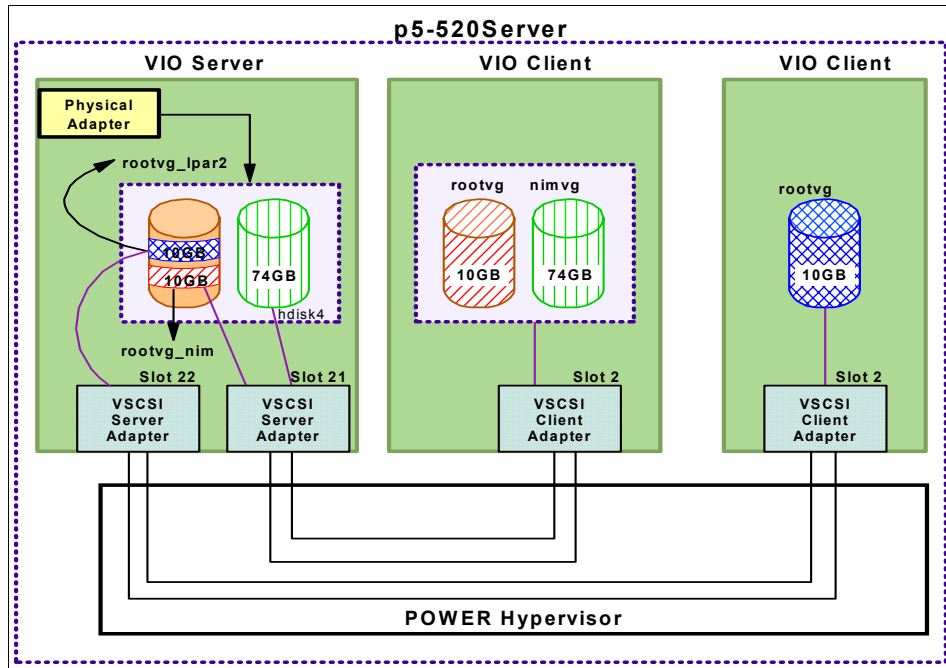

Figure 4-17 Virtual SCSI setup

Figure 4-18 shows the VLAN configuration for the same environment (one VIO server with two VIO clients).

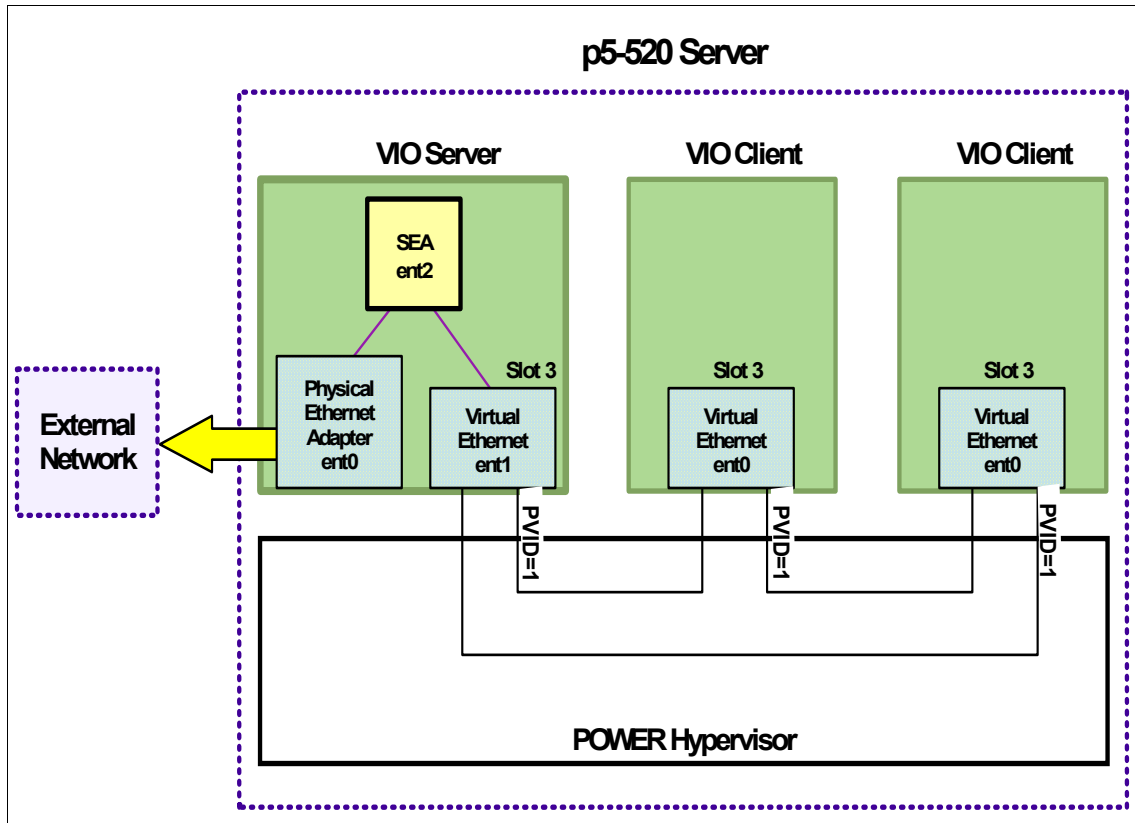

Figure 4-18 Virtual Ethernet setup

## Setting up the VIO server profile and client profile

Here we demonstrate setting up the Virtual SCSI and the Virtual Ethernet.

1. Open the VIO server's profile. Perform the Virtual SCSI and Ethernet creation as shown in Figure 4-19 on page 376.

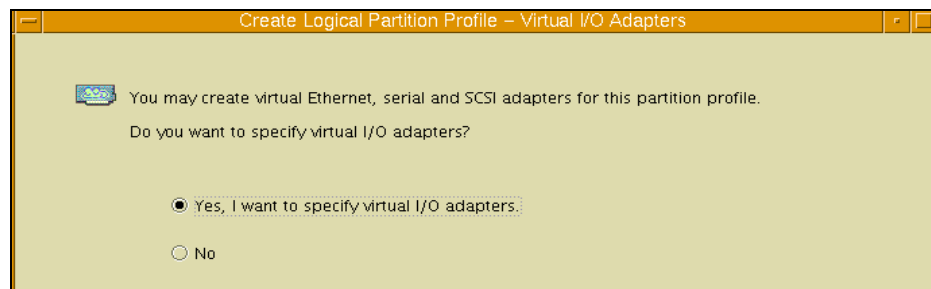

Figure 4-19 Create Virtual SCSI and Ethernet

2. Create the Virtual SCSI in the VIO server's profile. Click **Create server adapter...** as shown in Figure 4-20.

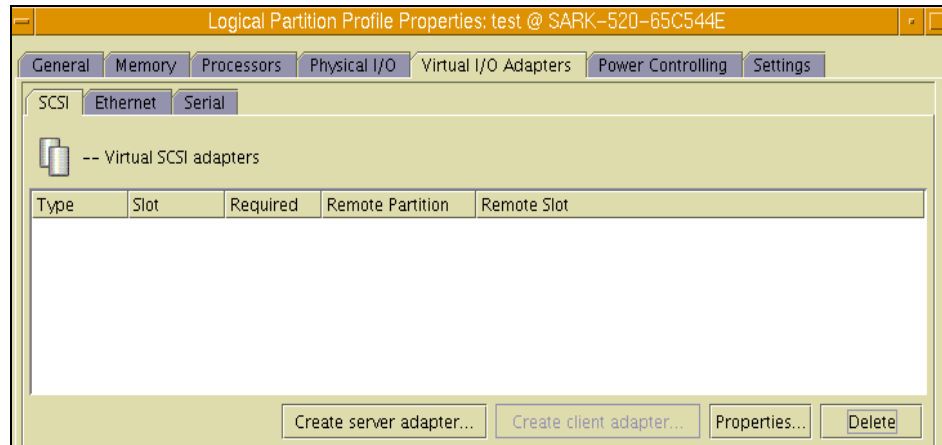

Figure 4-20 Click *Create server adapter...*

3. Specify the server's SCSI slot ID. If you have already created an LPAR, you can enter the client partition name and its slot ID.

If not, select the setting *Any client partition can connect*. (Remember to come back to select the correct Client partition after the client partition is created.) See Figure 4-21 on page 377.

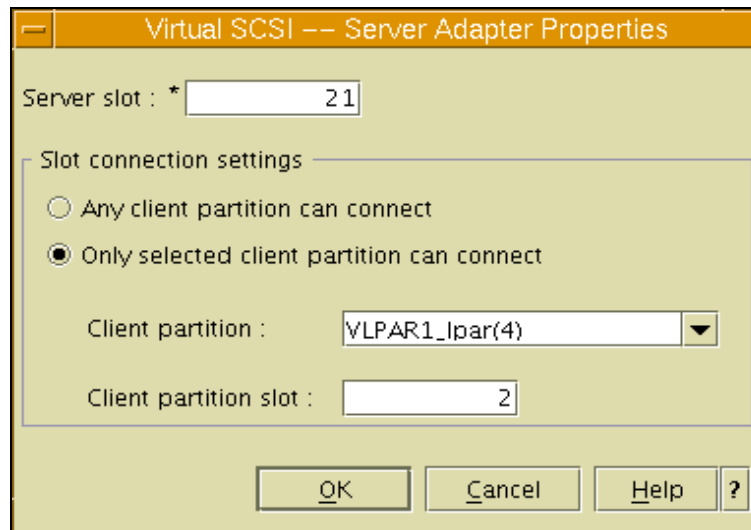

Figure 4-21 Key in the server and client virtual SCSI ID

4. Create the Virtual Ethernet on the VIO server. Click the **Ethernet** tab, then click **Create adapter...** as shown in Figure 4-22.

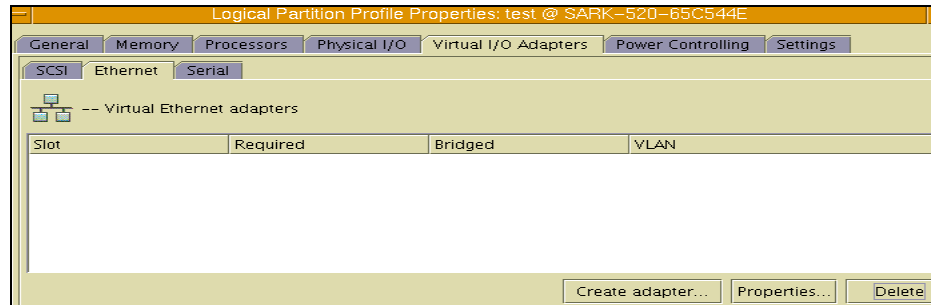

Figure 4-22 Create Virtual Ethernet on VIO server

5. Enter the Virtual SCSI slot ID and the VLAN ID.  
If you need to create a Shared Ethernet adapter to allow the partition to access the external network, select **Access external network**; see Figure 4-23 on page 378.

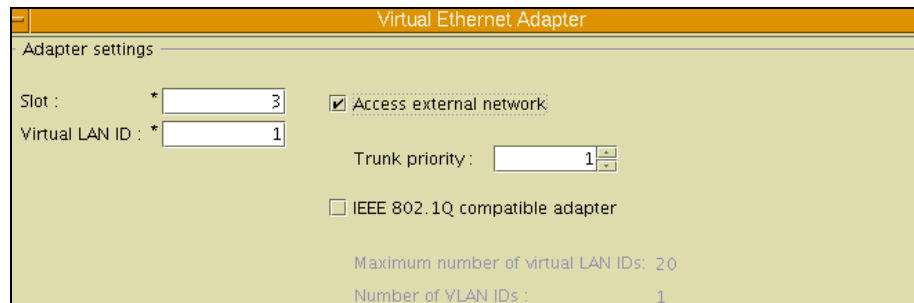

Figure 4-23 Enter the Virtual Ethernet Slot ID and VLAN ID

6. After completing the VIO server profile, proceed to the VIO client profile. The steps involved are very similar. Select **Create client adapter...**; Figure 4-24 illustrates the Virtual SCSI on the client.

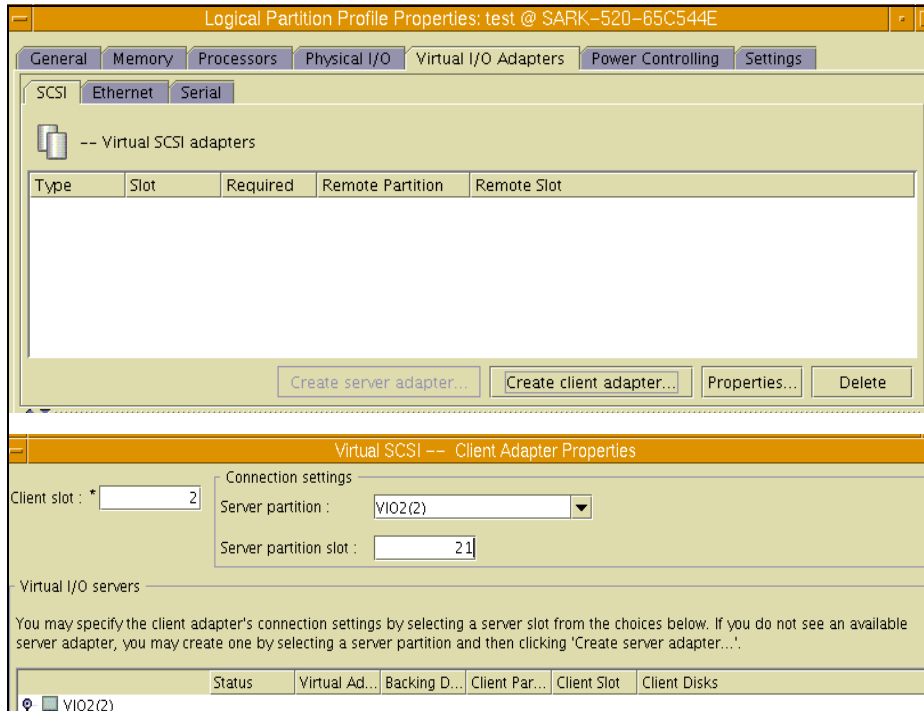

Figure 4-24 Create Virtual SCSI on VIO client

- When configuring the Virtual Ethernet on the VIO client, enter the Slot ID and the VLAN ID.

You do *not* need to select Access external network; see Figure 4-25 on page 379.

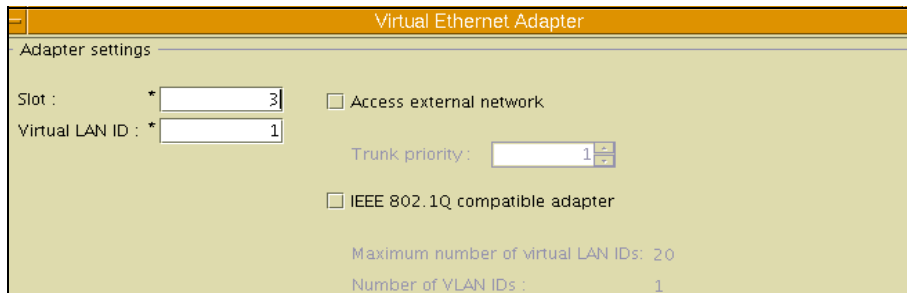

Figure 4-25 Enter Virtual Ethernet slot ID and VLAN ID

## Defining the Volume Group and Logical Volumes

After defining the virtual SCSI and virtual Ethernet in the Hardware Management Console (HMC) profile, create the Volume Group (VG) and Logical Volumes (LVs) for client usage in the VIO server.

Because the NIM master requires a considerable amount of disk space, we assigned an entire hdisk and created a LV to the VIO client, which we used for our NIM master. We followed this procedure:

1. Create a VG to be partitioned into LVs for the usage of the VIO clients' rootvg. For example:

```
$ mkvg -f -vg rootvg_clients hdisk2
```

If you need to extend the rootvg\_clients VG, use the following command:

```
$ extendvg -f rootvg_clients hdisk3
```

2. Create LVs for usage by the VIO clients.

We created a LV on the rootvg\_client VG for NIM master named rootvg\_nim, and another LV for a NIM client named rootvg\_lpar2; for example:

```
$ mklv -lv rootvg_nim rootvg_clients 10G hdisk2
$ mklv -lv rootvg_lpar2 rootvg_clients 10G hdisk2
```

Example 4-280 shows the details of the Volume Group configuration.

### Example 4-280 The Volume Group information

---

```
$ lspv
NAME PVID VG STATUS
hdisk0 0000c83603e569ef rootvg active
hdisk1 none None
hdisk2 0000c836a42eeeb1 rootvg_clients active
hdisk3 0000c836a42f5b75 rootvg_clients active
hdisk4 0000c836cc576c89 None
```

---

## Configuring the virtual SCSI device

Before we can create the Virtual target device, we need to identify the virtual host devices, vhosts, on the VIO server. These vhosts are the virtual SCSI server adapters. They are configured after you have defined all the virtual SCSI in the VIO server's profile. You need to run the **cfgdev** command in the VIO server to configure these vhosts, as follows:

1. Verify the virtual host devices.

Example 4-281 shows the command listing all the vhosts. You can see the slot ID that is assigned when you specify it in the VIO server's profile; for example, vhost0 has the Virtual SCSI slot ID of 21.

*Example 4-281 List the vhosts info*

---

```
$ lsdev -virtual
name status description
vhost0 Available Virtual SCSI Server Adapter
vhost1 Available Virtual SCSI Server Adapter

$ lsdev -vpd |grep vhost
vhost1 U9131.52A.650E4DG-V2-C22 Virtual SCSI Server Adapter
vhost0 U9131.52A.650E4DG-V2-C21 Virtual SCSI Server Adapter
```

---

2. Create Virtual Target Device mapping (VTD). See the mapping in Example 4-282.

After the hdisks, LV, and the vhosts are in place, we can create the Virtual Target devices.

For the NIM master partition using vhost0, enter:

```
$ mkvdev -vdev rootvg_nim -vadapter vhost0 -dev vrootvg_nim
$ mkvdev -vdev hdisk4 -vadapter vhost0 -dev vnimvg_nim
```

For the NIM client lpar2 using vhost1, enter:

```
$ mkvdev -vdev rootvg_lpar2 -vadapter vhost1 -dev vrootvg_lpar2
```

*Example 4-282 Virtual target device mapping*

---

```
$ lsmap -all
SVSA Physloc Client Partition ID
vhost0 U9131.52A.650E4DG-V2-C21 0x00000003
VTD vrootvg_nim
LUN 0x8100000000000000
Backing device rootvg_nim
Physloc

VTD vnimvg_lpar1
LUN 0x8200000000000000
Backing device hdisk4
Physloc U787F.001.DPMOD1L-P1-T11-L5-L0

SVSA Physloc Client Partition ID
vhost1 U9131.52A.650E4DG-V2-C22 0x00000004

VTD vrootvg_lpar2
LUN 0x8100000000000000
Backing device rootvg_lpar2
Physloc
```

---

## Configuring the virtual optical device

Configuring the optical device as a virtual SCSI device is similar to configuring the LV or disk as a virtual SCSI device. First, check that the physical optical device is configured in the VIO server, as shown in Example 4-283.

*Example 4-283 List physical optical device*

---

```
$ lsdev -vpd |grep cd
cd0U787F.001.DPMOD1L-P4-D2IDE DVD-RAM Drive
```

---

After the physical device is available, create the virtual optical SCSI target device. In Example 4-284, the virtual optical device is assigned to the vhost0.

```
$ mkvdev -vdev cd0 -vadapter vhost0
```

*Example 4-284 List virtual optical SCSI target device*

---

```
$ lsmap -vadapter vhost0
SVSA Physloc Client Partition ID
vhost0 U9131.52A.650E4DG-V2-C21 0x00000003
VTD vrootvg_nim
LUN 0x8100000000000000
Backing device rootvg_nim
Physloc

VTD vnimvg_lpar1
LUN 0x8200000000000000
Backing device hdisk4
Physloc U787F.001.DPMOD1L-P1-T11-L5-L0

VTD vtopt0
LUN 0x8300000000000000
Backing device cd0
Physloc U787F.001.DPMOD1L-P4-D2

$ lsdev -vpd |grep vtopt
vtopt0 U9131.52A.650E4DG-V2-C21-L3 Virtual Target Device - Optical
Media
```

---

**Note:** Only one virtual target device can be created for a particular physical optical device.



Follow these steps if you need to assign the optical device to another partition.

1. Remove the existing virtual optical device on the client partition that is having the virtual optical device.

From the VIO client, enter:

```
rmdev -d1 cd0
```

2. Remove the virtual optical SCSI target device on the VIO server.

From the VIO server, enter:

```
$ rmvdev -vdev cd0
```

3. Create the virtual optical SCSI target device with the desired client's vhost adapter.

From the VIO server, enter:

```
$ mkvdev -vdev cd0 -vadapter vhost1
```

4. Execute the **cfgmgr** command on the new client to configure the cd0 device.

## Configuring the Shared Virtual Ethernet

If the partitions in the IBM p5 need to access the external network, you must configure the Shared Ethernet Adapter (SEA). Follow these steps to configure the SEA adapter.

1. Check the existing network adapter.

Example 4-285 shows that we have a physical network adapter ent0 and the Virtual Ethernet ent1 defined, and ent1 has slot ID 3 (C3), which is defined in the VIO server's profile.

*Example 4-285 List network adapter*

---

```
$ lsdev -type adapter
```

```
name status description
ent0 Available 10/100/1000 Base-TX PCI-X
Adapter(14106902)
ent1 Available Virtual I/O Ethernet Adapter (1-lan)
```

```
$ lsdev -vpd |grep ent
```

```
Model Implementation: Multiple Processor, PCI bus
ent1 U9131.52A.650E4DG-V2-C3-T1 Virtual I/O Ethernet Adapter (1-lan)

ent0 U787F.001.DPMOD1L-P1-T5 10/100/1000 Base-TX PCI-X
Adapter(14106902)
```

---

## 2. Create the Shared Ethernet Adapter.

Now we can create the Shared Ethernet Adapter using the physical Ethernet adapter ent0 and the Virtual Ethernet ent1; see Example 4-286.

```
$ mkvdev -sea ent0 -vadapter ent1 -default ent1 -default 1
```

*Example 4-286 List the Shared Ethernet Adapter*

---

```
$ lsdev -virtual |grep ent
ent1 Available Virtual I/O Ethernet Adapter (1-lan)
ent2 Available Shared Ethernet Adapter

$ lsmap -all -net
SVEA Physloc

ent1 U9131.52A.650E4DG-V2-C3-T1

SEA ent2
Backing device ent0
Physloc U787F.001.DPMOD1L-P1-T5
```

---

## 3. Configure the IP address of the Shared Ethernet adapter.

We configure the IP address on the Shared Ethernet adapter ent2:

```
$ mktcpip -hostname vio1 inetaddr 10.1.1.51 -interface en2 -start \
-netmask 255.255.255.0
```

## Installing AIX in the VIO client partition

After assigning the disk and optical device like DVD-ROM to the client partition, bring up the partition and install the AIX operating system (OS).

After the AIX operating system installation is completed, configure the NIM master as explained in Chapter 3, “Basic configuration of a Network Installation Manager environment” on page 51. After the NIM master and NIM client is set up, install the NIM client through the NIM master.

Example 4-287 shows the Virtual devices in the client partition; in this case, the NIM master.

*Example 4-287 List virtual SCSI disk, optical and Ethernet devices in VIO client*

---

```
Virtual SCSI disk Information
lscfg -vl vscsi0
vscsi0 U9131.52A.650E4DG-V3-C2-T1 Virtual SCSI Client Adapter

Device Specific.(YL).....U9131.52A.650E4DG-V3-C2-T1
```

```

lspv
hdisk0 0000c836a446e179 rootvg active
hdisk1 0000c836cc576c89 nimvg active

lscfg -vl hdisk0
hdisk0 U9131.52A.650E4DG-V3-C2-T1-L810000000000 Virtual SCSI Disk Drive

lscfg -vl hdisk1
hdisk1 U9131.52A.650E4DG-V3-C2-T1-L820000000000 Virtual SCSI Disk Drive

Virtual SCSI Optical device information
lsdev -C |grep cd
cd0 Available Virtual SCSI Optical Served by VIO Server

lscfg -vl cd0
cd0 U9131.52A.650E4DG-V3-C2-T1-L820000000000 Virtual SCSI Optical Served
by VIO Server

Virtual Ethernet Information
lsdev -C |grep ent0
ent0 Available Virtual I/O Ethernet Adapter (1-lan)

lscfg -vl ent0
ent0 U9131.52A.650E4DG-V5-C3-T1 Virtual I/O Ethernet Adapter (1)

Network Address.....1A8CF000501E
Displayable Message.....Virtual I/O Ethernet Adapter (1-lan)
Device Specific.(YL).....U9131.52A.650E4DG-V5-C3-T1

```

---

## 4.14 Backup and restore of the VIO Server using NIM

There are several ways to perform backup and restore of VIO server. You can perform this task by tape, DVD-RAM or file system. In this section, we explain how to perform the backup and restore through the NIM server.

**Note:** At the time of writing, the `installios` command on AIX only supports using VIO base media. It is not yet supported on VIO backup images.

### 4.14.1 Backup of VIO server

We export the NIM master server's `mksysb` directory to the VIO server, and then perform a NFS mount of the directory, as shown in Example 4-288.

On the VIO server:

1. Create a temporary NFS mount point.

```
$ mkdir viobackup
```

2. Mount the NIM master, v1par1, in the server's mksysb directory.

```
$ mount v1par1:/export/images /home/padmin/viobackup
```

*Example 4-288 List nfs mount directory on VIO server*

---

```
$ mount
```

| node                  | mounted                | mounted over | vfs    | date         | options         |
|-----------------------|------------------------|--------------|--------|--------------|-----------------|
| /dev/hd4              | /                      |              | jfs2   | Jun 13 09:42 | rw,log=/dev/hd8 |
| /dev/hd2              | /usr                   |              | jfs2   | Jun 13 09:42 | rw,log=/dev/hd8 |
| /dev/hd9var           | /var                   |              | jfs2   | Jun 13 09:43 | rw,log=/dev/hd8 |
| /dev/hd3              | /tmp                   |              | jfs2   | Jun 13 09:43 | rw,log=/dev/hd8 |
| /dev/hd1              | /home                  |              | jfs2   | Jun 13 09:43 | rw,log=/dev/hd8 |
| /proc                 | /proc                  |              | procfs | Jun 13 09:43 | rw              |
| /dev/hd10opt          | /opt                   |              | jfs2   | Jun 13 09:43 | rw,log=/dev/hd8 |
| v1par1 /export/images | /home/padmin/viobackup |              | nfs3   | Jun 19 17:04 |                 |

---

3. Perform the VIO backup using the **backupios** command as shown in Example 4-289. The VIO.mksysb is the mksysb filename.

```
$ backupios -file /home/padmin/viobackup/VIO.mksysb -mksysb
```

*Example 4-289 Backup VIO mksysb using backupios command*

---

```
$ backupios -file /home/padmin/viobackup/VIO.mksysb -mksysb
```

Backup in progress. This command can take a considerable amount of time to complete, please be patient...

Creating information file (/image.data) for rootvg....

Creating list of files to back up.

Backing up 29181 files.....

26047 of 29181 files (89%)

29181 of 29181 files (100%)

0512-038 savevg: Backup Completed Successfully.

---

**Note:** You need to specify the **-mksysb** option in the **backupios** command. This creates the mksysb image for the use of the NIM master server.

Use the **backupios** command without the **-mksysb** option only when you want install the VIO through the HMC.

We recommend that you back up the following VIO configuration information. You can use this information to restore the VIO if the mksysb restore does not perform successfully.

The information to backup is the following:

- ▶ All physical volume groups and logical volumes devices  
Commands: `lsvg ; lsvg -lv <VGname>; lspv; lspv -lv hdisk#`
- ▶ All physical disk and virtual Logical Volumes  
Command: `lsdev -type disk`
- ▶ All physical and virtual adapters  
Command: `lsdev -type adapter`
- ▶ Mapping between physical devices / logical volume and virtual devices  
Commands: `lsmmap -all ; lsmmap -vadapter vhost# ; lsmmap -all -net`
- ▶ Network information  
Commands: `netstat -state ; netstat -num -state ;  
netstat -routinfo`

## 4.14.2 Restoring the VIO server

You can restore the VIO server using steps that are similar to restoring an AIX NIM client. Create a NIM mksysb resource from the image created by the **backupios** command, as described in 4.14.1, “Backup of VIO server” on page 385. Next, create the SPOT using this mksysb resource. After the mksysb and the SPOT resource are in place, you can carry out the pull BOS installation to restore the VIO server.

Follow these steps to restore the VIO server:

1. Define a mksysb resource.

Define the mksysb resource from the `/export/images/VIO.mksysb` image as shown in Example 4-290 on page 387.

```
smitty nim_mkres
Select “mksysb = a mksysb image”
```

*Example 4-290 Define a mksysb resource*

---

Define a Resource  
Type or select values in entry fields.  
Press Enter AFTER making all desired changes.

[TOP]

[Entry Fields]

```

* Resource Name [MK-VIO]
* Resource Type mksysb
* Server of Resource [master] +
* Location of Resource [/export/images/VIO.mksysb> /
Comments []

Source for Replication [] +
-OR-
System Backup Image Creation Options:
CREATE system backup image? no +
NIM CLIENT to backup [] +
PREVIEW only? no +
IGNORE space requirements? no +
[MORE...10]

```

---

## 2. Define a SPOT resource.

Define the SPOT from the mksysb resource defined in the previous step. See Example 4-291.

```

smitty nim_mkres
 Select " spot = Shared Product Object Tree - equivalent to /usr file"

```

### *Example 4-291 Define SPOT resource using mksysb resource*

---

```

Define a Resource
Type or select values in entry fields.
Press Enter AFTER making all desired changes.

[Entry Fields]
* Resource Name [SPOT-VIO]
* Resource Type spot
* Server of Resource [master] +
* Source of Install Images
[MK-VIO] +
* Location of Resource [/export/spot] /
Expand file systems if space needed? yes +
Comments []

installp Flags
COMMIT software updates? no +
SAVE replaced files? yes +
AUTOMATICALLY install requisite software? yes +
OVERWRITE same or newer versions? no +
VERIFY install and check file sizes? no +

```

---

## 3. Perform the BOS installation (pull mode).

After the SPOT and the mksysb resources are in place, you can allocate both resources and perform a BOS installation through the NIM pull installation.

Refer to 3.1, “Setting up a basic NIM environment” on page 53 for information about how to create SPOT and mkysyb resources and perform BOS installation.

You will receive a warning message stating that the SPOT level is older than the mkysyb level, as shown in Example 4-292, which you can ignore. You are still able to use this SPOT to perform the BOS installation.

*Example 4-292 Warning message when perform BOS installation*

---

```
warning: 0042-360 m_bos_inst: The SPOT level is older than the mkysyb level.
Therefore,
 the BOS installation may encounter problems.
 Update the SPOT to match the mkysyb level or create a
 new SPOT that has the same level.
```

---

4. Reset the NIM BOS installation operation.

After the restoration is completed, you have to reset the NIM BOS installation operation in the NIM master as shown in Example 4-293. Follow these steps when using the SMIT menus:

```
smitty nim
 Perform NIM Administration Tasks
 Manage Machines
 Perform Operations on Machines
 Select the Target Machine
 Select “reset = reset an object's NIM state”
```

Or, using SMIT Fast Path, execute **smitty nim\_mac\_op**

*Example 4-293 Reset NIM client BOS installation Operation*

---

Reset the NIM State of a Machine

Type or select values in entry fields.  
Press Enter AFTER making all desired changes.

|                                                          |               |
|----------------------------------------------------------|---------------|
| Target Name                                              | [EntryFields] |
| Deallocate All Resources?                                | VI02          |
| (removes all root data for<br>diskless/dataless clients) | yes +         |
| Force                                                    | yes+          |

---

In the VIO server, you need to import all the other Volume Groups. The `bosinst.data` of the VIO mkysyb image, the `IMPORT_USER_VGS` is set to `no`. You need to create the `bosinst_data` resource if you want to import the user VG after the NIM restoration.

Next, check the VIO configuration:

- ▶ All physical and Logical volumes created for the VIO clients are in open/syncd:

```
lsvg -lv <VGname>
```

- ▶ All the virtual devices:

```
lsmap -all
```

- ▶ All the network configuration:

```
lsmap -all -net
netstat -state ; netstat -num -state ; netstat -routinfo
```

After everything is in place, you can activate each VIO client.

## 4.15 Using RSCT PeerDomain with HANIM

When using HANIM (see 4.1, “High Availability Network Installation Manager” on page 124), the NIM master and the alternate NIM master are not aware of each other’s state. The takeover of the role as acting NIM master is based on whether or not NIM clients want to use a specific system as their NIM master. The NIM master for a NIM client is specified in the client’s `/etc/niminfo` file.

Here we show how RSCT PeerDomain (RPD) can be used to automate HANIM takeover operations. The purpose is only to execute the appropriate `nim` command to perform a takeover of NIM clients (change their `/etc/niminfo` file); refer to Figure 4-26 on page 391.



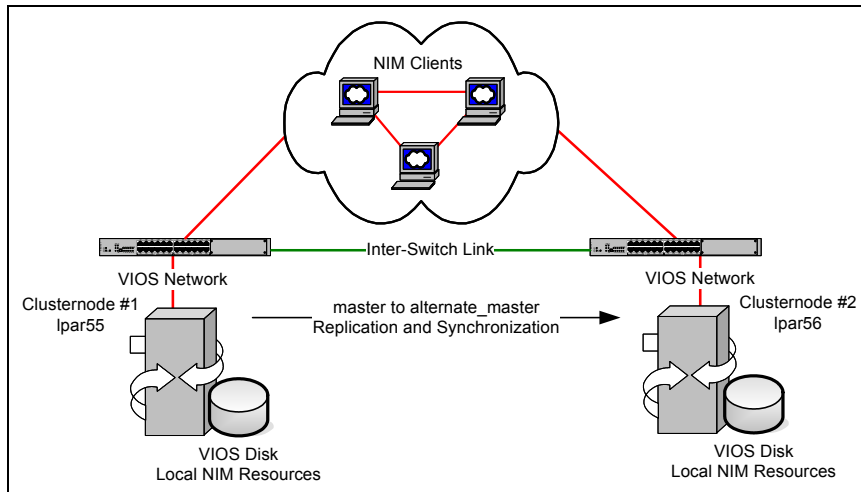

Figure 4-26 Graphic layout of our RSCT PeerDomain cluster setup for HANIM

An *RSCT peer domain* is a cluster of nodes configured for high availability, and it uses the following:

- ▶ RSCT core cluster security services for authentication
- ▶ RSCT core Topology Services subsystem for node/network failure detection
- ▶ RSCT core Group Services subsystem for cross node/process coordination
- ▶ Resource Monitoring and Control (RMC) subsystem for coordination between the various RSCT subsystems

We use the following POWER5 logical partitions:

- lpar55** This will be the first and original NIM master (RPD node one).
- lpar56** This will be the first and alternate NIM master (RPD node two).
- lpar6** This will be the first and only NIM client (already running as a NIM client to another NIM master environment).

All the LPARs are configured in the same way, using VIO servers for disk and network resources, and CPU micropartitioning, as shown in Example 4-294.

*Example 4-294 Basic LPAR config for RSCT PeerDomain HANIM examples*

```
root@lpar56:/: lscfg -v1 hdisk0
 hdisk0 U9111.520.65C544E-V6-C2-T1-L810000000000 Virtual SCSI Disk Drive

root@lpar56:/: lscfg -v1 ent0
 ent0 U9111.520.65C544E-V6-C3-T1 Virtual I/O Ethernet Adapter (1-lan)
```

```
Network Address.....223380006003
Displayable Message.....Virtual I/O Ethernet Adapter (1-lan)
Device Specific.(YL).....U9111.520.65C544E-V6-C3-T1
```

```
root@lpar56:/: lparstat -h
System configuration: type=Shared mode=Capped smt=0n lcpu=2 mem=512 psize=2 ent=0.10
. . .
```

---

The node configuration will only use the ent0 network virtual network adapter on the cluster nodes, and all NIM database and resource file systems will be local to each of the two cluster nodes. HANIM functionality will be used to keep the database synchronized and resources replicated.

**Note:** In this scenario, we assume that one NIM master contain all server resources that are needed to service the network.

The RSCT PeerDomain (RPD) configuration is made using these assumptions and requirements regarding availability:

- ▶ The systems management personnel shall not have to restore and reconfigure the NIM server in case of hardware failure.
- ▶ The longest downtime for the NIM server shall be two hours.
- ▶ Hardware failures might occur during the NIM server's lifetime, but is unlikely.
- ▶ Planned downtime will occur during the NIM server's lifetime to install new firmware or system updates.
- ▶ In case of system failure of the acting NIM master, the RSCT peer will perform takeover of the NIM clients.

Based on these assumptions and requirements, we used AIX 5L V5.3 TL5 and RSCT V2.4.5 (use SUMA to download updates to AIX and RSCT respectively, see 4.10, "NIM and Service Update Management Assistant" on page 319).

After the NIM master has performed the BOS rte install of the LPARs, they are customized with the following NIM commands for the NIM clients. The NIM client name in the following examples is LPAR55 as shown in Example 4-295 on page 393. First it is defined in the current NIM master (hostname master), then an AIX 5.3 TL5 SPOT (cosi5305) and NIM lpp\_source (lpp5305) are allocated. Finally, the bos\_inst operation is performed to reinstall the NIM client.

After this, additional bos filesets are installed: updates to the rsct.core, together with the bos.sysmgt.nim.master fileset for NIM master functionality itself. However, first we want to have two RPM packages installed: openssl and openssh.

**Note:** RPM packages should be in the NIM `lpp_source/RPMS/ppc` directory (in this example, the full path to this directory on the NIM master is `/export/lpp_source/lpp5305/RPMS/ppc`).

The same is done for the NIM client LPAR56.

*Example 4-295 NIM master additional software updates of RSCT PeerDomain nodes*

---

```
root@master:/: nim -o define -t standalone -a if1="net_10_1_1 lpar55 0" LPAR55
root@master:/: nim -o allocate -a spot=cosi5305 -a lpp_source=lpp5305 LPAR55
root@master:/: nim -o bos_inst -a source=rte LPAR55
root@master:/: nim -o cust -a lpp_source=lpp5305 -a installp_flags=agXY -a
filesets="openssl-0.9.7d-2 openssh.base bos.adt.libm bos.adt.syscalls rsct.core
bos.sysmgt.nim.master" LPAR55
```

---

Now we are ready to configure the RSCT PeerDomain, and activate it. First we make sure that `/etc/hosts` on each node contain the IP-address of both peer nodes and of the client, `lpar6`. For our purposes, we use the following IP-addresses:

```
10.1.1.55 lpar55
10.1.1.56 lpar56
10.1.1.6 lpar6
```

We also add the `NSORDER` variable to `/etc/environment` to ensure that we use the local systems `/etc/hosts` file to resolve hostnames to IP-addresses, and log in again (we could also use the `/etc/netsvc.conf` or `/etc/irs.conf` files for the same purpose; see “Setting up IP name resolution” on page 65):

```
NSORDER=local,bind
```

## RSCT PeerDomain configuration

Run the `preprnode` command on both nodes. In Example 4-296 we use the `-V` flag only with the `preprnode` command. To get more detailed output use the `-T` flag also.

*Example 4-296 Using preprnode for the RSCT PeerDomain*

---

```
root@lpar55:/: preprnode -V lpar55 lpar56
Beginning to prepare nodes to add to the peer domain.
Completed preparing nodes to add to the peer domain.

root@lpar56:/: preprnode -V lpar55 lpar56
Beginning to prepare nodes to add to the peer domain.
Completed preparing nodes to add to the peer domain.
```

---

Now, we create the actual RSCT PeerDomain Cluster with the **mkrpdomain** command as shown in Example 4-297. The peer domain name is NIMESIS and consisting of two nodes: lpar55 and lpar56.

*Example 4-297 Create the RSCT PeerDomain with mkrpdomain*

---

```
root@lpar55:/: mkrpdomain -V NIMESIS lpar55 lpar56
Making the peer domain "NIMESIS".
Completed making the peer domain "NIMESIS".
```

---

We check the status of the NIMESIS cluster with the **lsrpdomain** command as shown in Example 4-298.

*Example 4-298 Checking status of RSCT PeerDomain after mkrpdomain command*

---

```
root@lpar55:/: lsrpdomain
Name OpState RSCTActiveVersion MixedVersions TSPort GSPort
NIMESIS Offline 2.4.5.2 No 12347 12348
```

---

Example 4-298 shows that the NIMESIS cluster is **Offline**, so we start it with the **startrpdomain** command as shown in Example 4-299.

*Example 4-299 Starting the RSCT PeerDomain after mkrpdomain command*

---

```
root@lpar55:/: startrpdomain -V NIMESIS
Starting the peer domain "NIMESIS".
Completed starting the peer domain "NIMESIS".
```

---

We again check the status of the NIMESIS cluster with the **lsrpdomain** command as shown in Example 4-300.

*Example 4-300 Checking status of RSCT PeerDomain after startrpdomain command*

---

```
root@lpar55:/: lsrpdomain
Name OpState RSCTActiveVersion MixedVersions TSPort GSPort
NIMESIS Pending online 2.4.5.2 No 12347 12348
```

```
root@lpar55:/: lsrpdomain
Name OpState RSCTActiveVersion MixedVersions TSPort GSPort
NIMESIS Online 2.4.5.2 No 12347 12348
```

---

Example 4-300 shows that the NIMESIS cluster is **Pending online**. When we run the **lsrpdomain** command a second time, it has become **Online** and is ready for use. After starting the RSCT PeerDomain, it will take about a minute before it is online.

If you get the following error message when using `lsrpdomain` command, simply wait a moment and try again:

```
/usr/sbin/rsct/bin/lsrsrc-api: 2612-022 A session could not be established
with the RMC daemon on "local_node".
```

Next, we use the `lsrpnode` command to check the individual status of our NIMESIS RSCT PeerDomain cluster nodes as shown in Example 4-301.

*Example 4-301 Checking status of RSCT PeerNodes after startrpdomain command*

---

```
root@lpar55:/: lsrpnode
Name OpState RSCTVersion
lpar55 Online 2.4.5.2
lpar56 Online 2.4.5.2
```

---

Both are `Online` as expected, with the `rsct.core` fileset level of 2.4.5.2. You can verify this by executing the following `lslpp` command on each node:

```
lslpp -L rsct.core.rmc
```

**Summary:** To create an RSCT PeerDomain cluster with two nodes, run the following commands:

- ▶ `preprnode node1 node2` # on node1
- ▶ `preprnode node1 node2` # on node2
- ▶ `mkrpdomain RPD node2 node2`
- ▶ `startrpdomain RPD`

## Checking the RSCT PeerDomain configuration

To check the RSCT PeerDomain configuration, we use the `lsrsrc` command to access specific RSCT resource managers (RM).

A *resource manager* is a daemon process that provides the interface between Resource Monitoring and Control subsystem (RMC) and actual physical or logical entities. Although RMC provides the basic abstractions (resource classes, resources, and attributes) for representing physical or logical entities, it does not itself represent any actual entities. A resource manager maps actual entities to RMCs abstractions. The RSCT RMC subsystem (`ctrmc`) can be monitored with the `lssrc` command. Example 4-302 shows the registered resource managers.

*Example 4-302 Listing dynamic information from the ctrmc with the lssrc (not lsrsrc)*

---

```
root@lpar55:/: lssrc -ls ctrmc
. . .
Resource Manager Information
 Name ClassKey ID FD SHMID
IBM.WLMRM 1 0 -1 -1
```

|                |   |    |    |         |
|----------------|---|----|----|---------|
| IBM.DRM        | 1 | 1  | 26 | 3145730 |
| IBM.ConfigRM   | 1 | 2  | 23 | -1      |
| IBM.ERRM       | 1 | 3  | 24 | -1      |
| IBM.AuditRM    | 1 | 4  | 20 | -1      |
| IBM.FSRM       | 1 | 5  | -1 | -1      |
| IBM.HostRM     | 1 | 6  | 19 | 3145731 |
| IBM.SensorRM   | 1 | 7  | -1 | -1      |
| IBM.LPRM       | 1 | 8  | 29 | -1      |
| IBM.ServiceRM  | 1 | 9  | 27 | 3145729 |
| IBM.CSMAgentRM | 1 | 10 | 21 | -1      |
| IBM.HacmpRgRm  | 1 | 11 | -1 | -1      |
| . . .          |   |    |    |         |

---

Each resource manager represents a specific set of administrative tasks or system features. The resource manager identifies the key physical or logical entity types related to that set of administrative tasks or system features, and defines resource classes to represent those entity types.

Example 4-303 shows the current registered resource managers on one of our cluster nodes, and in the following examples we will examine the `IBM.PeerDomain` and `IBM.PeerNode`, resource managers in more detail.

*Example 4-303 Listing resource managers with `lsrsrc` (not `lssrc`)*

---

```
root@lpar55:/: lsrsrc | pr -t -2
class_name "IBM.PeerNode"
"IBM.Association" "IBM.RSCTParameters"
"IBM.ATMDevice" "IBM.NetworkInterface"
"IBM.AuditLog" "IBM.CommunicationGroup"
"IBM.AuditLogTemplate" "IBM.HostPublic"
"IBM.Condition" "IBM.DRM"
"IBM.EthernetDevice" "IBM.WLM"
"IBM.EventResponse" "IBM.TieBreaker"
"IBM.FDDIDevice" "IBM.LPAR"
"IBM.Host" "IBM.LPCommands"
"IBM.FileSystem" "IBM.HacmpEquivalency"
"IBM.PagingDevice" "IBM.HacmpManagedRelationship"
"IBM.PhysicalVolume" "IBM.HacmpManagedResource"
"IBM.Processor" "IBM.HacmpResourceGroup"
"IBM.Program" "IBM.HacmpCluster"
"IBM.TokenRingDevice" "IBM.HacmpNode"
"IBM.Sensor" "IBM.HacmpNetwork"
"IBM.Sfp" "IBM.HacmpServiceIP"
"IBM.ServiceEvent" "IBM.HacmpApplication"
"IBM.ManagementServer" "IBM.HacmpAppMonitor"
"IBM.PeerDomain" "IBM.HacmpManagedStorage"
```

---

Using the `lsrsrc` command, we can examine both the persistent and dynamic attributes of the RMs.

The `IBM.PeerDomain` RM in Example 4-304 shows the persistent Name and its `ActivePeerDomain` called NIMESIS.

*Example 4-304 IBM.PeerDomain persistent attributes*

---

```
root@lpar55:/: lsrsrc IBM.PeerDomain
Resource Persistent Attributes for IBM.PeerDomain
resource 1:
 Name = "NIMESIS"
 RSCTActiveVersion = "2.4.5.2"
 MixedVersions = 0
 TSPort = 12347
 GSPort = 12348
 RMCPort = 657
 ResourceClasses = {}
 QuorumType = 0
 ActivePeerDomain = "NIMESIS"
```

---

Example 4-305 shows that the `IBM.PeerDomain` dynamic `OpState` is 1, and 1 is desirable because it means that the peer domain is online (2 means offline).

*Example 4-305 IBM.PeerDomain dynamic attributes*

---

```
root@lpar55:/: lsrsrc -A d IBM.PeerDomain
Resource Dynamic Attributes for IBM.PeerDomain
resource 1:
 OpState = 1
 ConfigChanged = 0
 OpQuorumState = 0
```

---

The `IBM.PeerNode` RM in Example 4-306 shows the known nodes, and also shows that they belong to the `ActivePeerDomain` NIMESIS. The `NodeList` number is the sequence number for the node in the domain, and it is the same sequence on all nodes.

*Example 4-306 IBM.PeerNode persistent attributes*

---

```
root@lpar55:/: lsrsrc IBM.PeerNode
Resource Persistent Attributes for IBM.PeerNode
resource 1:
 Name = "lpar55"
 NodeList = {1}
 RSCTVersion = "2.4.5.2"
 ClassVersions = {}
 CritRsrcProtMethod = 0
 ActivePeerDomain = "NIMESIS"
```

```

 NodeNameList = {"1par55"}
resource 2:
 Name = "1par56"
 NodeList = {2}
 RSCTVersion = "2.4.5.2"
 ClassVersions = {}
 CritRsrcProtMethod = 0
 ActivePeerDomain = "NIMESIS"
 NodeNameList = {"Unknown_Node_Name"}

```

```

root@1par56:/: lsrsrc IBM.PeerNode
Resource Persistent Attributes for IBM.PeerNode

```

```

resource 1:
 Name = "1par55"
 NodeList = {1}
 RSCTVersion = "2.4.5.2"
 ClassVersions = {}
 CritRsrcProtMethod = 0
 ActivePeerDomain = "NIMESIS"
 NodeNameList = {"Unknown_Node_Name"}
resource 2:
 Name = "1par56"
 NodeList = {2}
 RSCTVersion = "2.4.5.2"
 ClassVersions = {}
 CritRsrcProtMethod = 0
 ActivePeerDomain = "NIMESIS"
 NodeNameList = {"1par56"}

```

---

Example 4-307 shows that the IBM.PeerNode dynamic OpState is 1, and 1 is desirable because it means that the peer domain is online (2 means offline).

*Example 4-307 IBM.PeerNode dynamic attributes*

---

```

root@1par55:/: lsrsrc -Ad IBM.PeerNode
Resource Dynamic Attributes for IBM.PeerNode
resource 1:
 OpState = 1
 ConfigChanged = 0
 CritRsrcActive = 0
resource 2:
 OpState = 1
 ConfigChanged = 0
 CritRsrcActive = 0

```

---

Communication groups control how RSCT core topology services “heartbeats” are performed between the communication resources within the peer domain. Each communication group corresponds to a RSCT core topology services



heartbeat ring, and identifies the attributes that control the checks between the nodes. Now we use the environment variable `CT_MANAGEMENT_SCOPE` set to 2, which will enable RSCT PeerDomain display when using the `lsrsrc` command as shown in Example 4-308. If it is unset, it will only show the local node information.

*Example 4-308 Using CT\_MANAGEMENT\_SCOPE=2 variable*

---

```
root@lpar55:/: CT_MANAGEMENT_SCOPE=2 lsrsrc -Ad IBM.PeerNode
Resource Dynamic Attributes for IBM.PeerNode
resource 1:
 OpState = 1
 ConfigChanged = 0
 CritRsrcActive = 0
resource 2:
 OpState = 1
 ConfigChanged = 0
 CritRsrcActive = 0
```

---

To examine the communication groups in our RSCT PeerDomain, we use the `lscmg` command. In Example 4-309, there is only one communication group, CG1.

*Example 4-309 Checking the communication groups with lscmg*

---

```
root@lpar55:/: lscmg
Name Sensitivity Period Priority Broadcast SourceRouting NIMPathName NIMParameters
CG1 4 1 1 Yes Yes
```

---

To find out the interfaces used to communicate in this communication group, use the `-i` flag and specify the communication group with the `lscmg` command. In Example 4-310, the CG1 communication group has two members: `lpar55` and `lpar56`.

*Example 4-310 Checking the interfaces in a communication group*

---

```
root@lpar55:/: lscmg -i CG1
Name NodeName IPAddress Subnet SubnetMask
en0 lpar56 10.1.1.56 10.1.1.0 255.255.255.0
en0 lpar55 10.1.1.55 10.1.1.0 255.255.255.0
```

---

We can examine the communications interfaces on our cluster nodes by using the `lsrsrc` command with the `IBM.NetworkInterface` and setting the environment variable `CT_MANAGEMENT_SCOPE` to 2. This will enable RSCT PeerDomain display when using the command. If it is unset, it will only show the local node information. The attribute `OpState` should be 1, which is online; see Example 4-311 on page 400.

*Example 4-311 Listing interfaces in a peer domain*

---

```
root@lpar55:/: CT_MANAGEMENT_SCOPE=2 lsrsrc -A d IBM.NetworkInterface
Resource Dynamic Attributes for IBM.NetworkInterface
resource 1:
 OpState = 1
 ConfigChanged = 0
resource 2:
 OpState = 1
 ConfigChanged = 0
```

---

The RSCT core topology services subsystem (cthats) can be monitored with the **lssrc** command, and controlled with the **cthatctrl**, **cthatstune**, and **cthactrl** commands (in the /usr/sbin/rsct/bin directory).

In Example 4-312 you can see the communications group CG1 has two members (Mbrs) and the status (St) is stable (S). The connection is between 10.1.1.55 and 10.1.1.56, and it uses the local en0 TCP/IP interface for communication.

*Example 4-312 Checking cthats (topology services)*

---

```
root@lpar55:/: lssrc -ls cthats
Subsystem Group PID Status
cthats cthats 286832 active
Network Name Indx Defd Mbrs St Adapter ID Group ID
CG1 [0] 2 2 S 10.1.1.55 10.1.1.56
CG1 [0] en0 0x44a4d38b 0x44a4d397
HB Interval = 1.000 secs. Sensitivity = 4 missed beats
Missed HBs: Total: 0 Current group: 0
Packets sent : 83 ICMP 0 Errors: 0 No mbuf: 0
Packets received: 130 ICMP 0 Dropped: 0
NIM's PID: 671826
 2 locally connected Clients with PIDs:
 rmcd(565364) hagsd(544840)
 Fast Failure Detection available but off.
 Configuration Instance = 1151652855
 Daemon employs no security
 Segments pinned: Text Data.
 Text segment size: 785 KB. Static data segment size: 1526 KB.
 Dynamic data segment size: 3009. Number of outstanding malloc: 100
 User time 0 sec. System time 0 sec.
 Number of page faults: 0. Process swapped out 0 times.
Daemon is in a refresh grace period.
 Number of nodes up: 2. Number of nodes down: 0.
```

---

The RSCT core group services subsystem (cthags) can be monitored with the **lssrc** command, and controlled with the **cthagsctrl**, **cthagstune**, and **cthactrl**

commands (in the /usr/sbin/rsct/bin directory). In Example 4-313, you can see that the rmc\_peers group is registered.

*Example 4-313 Checking cthags (group services)*

---

```
root@lpar55:/: lssrc -ls cthags
Subsystem Group PID Status
 cthags cthags 544840 active
2 locally-connected clients. Their PIDs:
225376(IBM.ConfigRMd) 565364(rmcd)
HA Group Services domain information:
Domain established by node 1
Number of groups known locally: 2
Group name Number of Number of local
 providers providers/subscribers
rmc_peers 2 1 0
IBM.ConfigRM 2 1 0
```

---

To check the authentication and trusted host list created with the **preprnode** command, you can use the **ctsth1** command. Example 4-314 shows our two peer nodes, lpar55 and lpar56, along with their respective IP-addresses.

*Example 4-314 Verifying ctcas trusted host list keys with ctsth1*

---

```
root@lpar55:/: ctsth1 -l
ctsth1: Contents of trusted host list file:

Host Identity: 10.1.1.56
Identifier Generation Method: rsa512
Identifier Value:
120200d004f8e71a20d92484dda354a8ddc76986768fa82ff74000cf42e694f516a75c9dba14564b
0d9b8ec50e05b21460128bb9f05a9f461267fbb7212d7e2dde0430103

Host Identity: lpar56
Identifier Generation Method: rsa512
Identifier Value:
120200d004f8e71a20d92484dda354a8ddc76986768fa82ff74000cf42e694f516a75c9dba14564b
0d9b8ec50e05b21460128bb9f05a9f461267fbb7212d7e2dde0430103

Host Identity: 10.1.1.55
Identifier Generation Method: rsa512
Identifier Value:
120200cd29169553c272c4e02dc042ba33b80430cfb761eb4034ec70f8f4f1461a42c425c37e7a81
2b1ad9e9e930d2ef659d060ee263007906ddccc0f8e8678d94f3eb0103

Host Identity: lpar55
Identifier Generation Method: rsa512
Identifier Value:
120200cd29169553c272c4e02dc042ba33b80430cfb761eb4034ec70f8f4f1461a42c425c37e7a81
```

. . .

Much of the RSCT dynamic configuration is stored under the /var/ct directory. The /var/ct/cfg/ctrmc.acls file contains the access control lists (ACL) also added by the **preprnode** command, as shown in Example 4-315.

*Example 4-315 RPD ctrmc.acls file (configured by preprnode command)*

---

```

none:root * rw // give root on any node access to all
IBM.PeerDomain // Peer Domain class
root@10.1.1.55 * rw // cluster node
root@10.1.1.56 * rw // cluster node
root@lpar55 * rw // cluster node
root@lpar56 * rw // cluster node
none:any_root * rw // root on any node of any cluster that this node is defined to
none:root * rw // root on any node of active cluster

```

---

## HANIM takeover operation

If a NIM client /etc/niminfo file looks like Example 4-316 (first part lpar6), then after the takeover operation is performed (from lpar55), it changes to look like Example 4-316 (second part lpar55).

*Example 4-316 Changes to a NIM clients /etc/niminfo file by nim -o takeover*

---

```

{lpar6}:/ # cat /etc/niminfo
#----- Network Install Manager -----
warning - this file contains NIM configuration information
and should only be updated by NIM
export NIM_NAME=lpar6
export NIM_HOSTNAME=lpar6
export NIM_CONFIGURATION=standalone
export NIM_MASTER_HOSTNAME=lpar56
export NIM_MASTER_PORT=1058
export NIM_REGISTRATION_PORT=1059
export NIM_SHELL="shell"
export NIM_MASTER_HOSTNAME_LIST="lpar56 lpar55"
export NIM_BOS_IMAGE=/SPOT/usr/sys/inst.images/installp/ppc/bos
export NIM_BOS_FORMAT=rte
export NIM_HOSTS=" 10.1.1.6:lpar6 10.1.1.56:lpar56 "
export NIM_MOUNTS=""

root@lpar55:/: nim -o takeover lpar56

{lpar6}:/ # cat /etc/niminfo
#----- Network Install Manager -----
warning - this file contains NIM configuration information
and should only be updated by NIM

```

```
export NIM_NAME=1par6
export NIM_HOSTNAME=1par6
export NIM_CONFIGURATION=standalone
export NIM_MASTER_HOSTNAME=1par55
export NIM_MASTER_PORT=1058
export NIM_REGISTRATION_PORT=1059
export NIM_SHELL="shell"
export NIM_MASTER_HOSTNAME_LIST="1par55 1par56"
export NIM_BOS_IMAGE=/SPOT/usr/sys/inst.images/installp/ppc/bos
export NIM_BOS_FORMAT=rte
export NIM_HOSTS=" 10.1.1.6:1par6 10.1.1.55:1par55 "
export NIM_MOUNTS=""
```

---

The **nim** command with the **takeover** operation is the core of what we use in our takeover script shown in Figure 4-27 on page 408.

## Creating a RSCT PeerDomain event detection method

Now that we have a working RSCT PeerDomain, and we know how to handle the NIM takeover operation, we can perform the steps to allow RSCT RMC event handling to perform the action for us. It involves the following steps and commands:

1. Create a program to perform actions when the intended conditions are met.
2. **mkresponse** - Define a program to execute.
3. **mkcondition** - Define a condition to monitor.
4. **mkcondresp** - Connect the condition with the response program.
5. **startcondresp** - Start monitoring the metrics in the condition.

**Important:** The type of condition and response we are using in this scenario with RSCT is a one-sided condition-response, and all commands must be performed on both peer nodes. However, the **mkcondition** command will be different between the nodes (as explained in Example 4-317).

First we create a script, `/local/rg/takeover.nimesis`, that will execute the **nim** command with the takeover operation; see Figure 4-27 on page 408. We recommend using the **vi** editor, both for script creation and for command line editing.

Then we define the response with the `/local/rg/takover.nimesis` script, naming the response `START_NIMESIS`, and the action `TAKEOVER`. Additional actions can be added to the response with the **chresponse** command, but for our purposes we do not need to use this feature.

### *Example 4-317 Creating a response with mkresponse*

---

```
root@1par55:/: mkresponse -n TAKEOVER -s /local/rg/takeover.nimesis START_NIMESIS
```

```
root@lpar55:/: lsresponse START_NIMESIS
Displaying response information:
```

```
ResponseName = "START_NIMESIS"
Node = "lpar55"
Action = "TAKEOVER"
DaysOfWeek = "1-7"
TimeOfDay = "0000-2400"
ActionScript = "/local/rg/takover.nimesis"
ReturnCode = 0
CheckReturnCode = "n"
EventType = "a"
StandardOut = "n"
EnvironmentVars = ""
UndefRes = "n"
```

---

Now we create the condition to evaluate. This part is where you have to find the appropriate attribute (metric) from the appropriate resource managers resource class. Use the `lsrsrc` command to find what you need.

When you know what you want to monitor, you just specify the expression to the `mkcondition` command, with the `-e` flag and the rearm expression with the `-E` flag. In our case we will monitor the `OpState` attribute in the `IBM.PeerNode` resource class for the remote peer. When it is set to 1, the peer is online, and when it is *not* set to 1, it is *not* online; that is, it can be unconfigured, pending or in some error state. However, it has to be online and nothing but online.

When we run the `mkcondition` command on our peer node `lpar55`, we use `-n lpar56`. But when we run the command on node `lpar56`, we use `-n lpar55`.

The `-n` flag specifies where the condition will be monitored, as shown in Example 4-318.

#### *Example 4-318 Creating a condition with `mkcondition`*

---

```
root@lpar55:/: mkcondition -mp -Sc -n "lpar56" -r IBM.PeerNode -e 'OpState <> 1'
-E 'OpState == 1' PEER_DOWN
```

```
root@lpar55:/: lscondition PEER_DOWN
Displaying condition information:
```

```
condition 1:
Name = "PEER_DOWN"
Node = "lpar55"
MonitorStatus = "Not monitored"
ResourceClass = "IBM.PeerNode"
EventExpression = "OpState <> 1"
EventDescription = ""
```

```
RearmExpression = "OpState == 1"
RearmDescription = ""
SelectionString = ""
Severity = "c"
NodeNames = {"lpar56"}
MgtScope = "p"
```

---

Now we have a response and we have a condition. To get the response to be performed when the condition becomes true, we need to create an association between the response and condition. This is done with the **mkcondresp** command. However, the condition will not be monitored just by creating an association, as shown Example 4-319.

*Example 4-319 Associating a condition with a response*

---

```
root@lpar55:/: mkcondresp PEER_DOWN START_NIMESIS

root@lpar55:/: lscondresp PEER_DOWN
Displaying condition with response information:
Condition Response Node State
"PEER_DOWN" "START_NIMESIS" "lpar55" "Not active"
```

---

In order for the condition to be monitored, we start it with the **startcondresp** command as shown in Example 4-320. Now when the condition becomes true, the associated response is activated.

*Example 4-320 Starting monitoring a condition with startcondresp*

---

```
root@lpar55:/: startcondresp PEER_DOWN

root@lpar55:/: lscondresp PEER_DOWN
Displaying condition with response information:

condition-response link 1:
 Condition = "PEER_DOWN"
 Response = "START_NIMESIS"
 Node = "lpar55"
 State = "Active"

root@lpar55:/: lsrsrc -Ad IBM.PeerNode
Resource Dynamic Attributes for IBM.PeerNode
resource 1:
 OpState = 1
 ConfigChanged = 0
 CritRsrcActive = 0
resource 2:
 OpState = 1
 ConfigChanged = 0
```

```
CritRsrcActive = 0
```

---

Now we have a metric that is being monitored, and when our condition is met and evaluates to true, our response is activated. This is our `takover.nimesis` script, as shown in Figure 4-27 on page 408.

To verify it, we can use the **stoprnode** command to bring the remote node offline from our RSCT domain as shown in Example 4-321.

This will cause the `OpState` attribute in `IBM.PeerNode`, to change from online (1), to offline (2).

*Example 4-321 Stopping a RSCT PeerDomain node with stoprnode*

---

```
root@lpar55:/: stoprnode -V lpar56
Stopping the node(s).
Stopping these node(s) in the peer domain. lpar56
Completed stopping the node(s).
```

---

Now we check the status with the **lsrsrc** command as shown in Example 4-322. The first time `OpState` has changed from one (1) to six (6), then shortly after it has changed to two (2) and are offline.

We can verify that it is offline with the **lsrnode** command, but our `PeerDomain` should still be active, which is seen from the output of the **lsrpdomain** command.

*Example 4-322 Checking the progress of stoprnode of the peer node*

---

```
root@lpar55:/: lsrsrc -Ad IBM.PeerNode
Resource Dynamic Attributes for IBM.PeerNode
resource 1:
 OpState = 6
 ConfigChanged = 0
 CritRsrcActive = 0
resource 2:
 OpState = 1
 ConfigChanged = 0
 CritRsrcActive = 0

root@lpar55:/: lsrsrc -Ad IBM.PeerNode
Resource Dynamic Attributes for IBM.PeerNode
resource 1:
 OpState = 1
 ConfigChanged = 0
 CritRsrcActive = 0
resource 2:
 OpState = 2
 ConfigChanged = 0
```



```
CritRsrcActive = 0
```

```
root@lpar55:/: lsrpnode
Name OpState RSCTVersion
lpar55 Online 2.4.5.2
lpar56 Offline 2.4.5.2
```

```
root@lpar55:/: lsrpdomain
Name OpState RSCTActiveVersion MixedVersions TSPort GSPort
NIMESIS Online 2.4.5.2 No 12347 12348
```

---

When we restart the peer node, the condition will be rearmed, and ready to go again.

```
startrpnode lpar56
```

## Takeover script for HANIM

Now we can examine our RPD script. We use one script to start the NIM services, or rather to change the `/etc/nimnfo` file on the NIM clients defined in the NIM database.

The takeover script will ensure that the nimesis SRC daemon is started and will collect some information regarding the running cluster, before it will issue a `nim` command ordering takeover from the alternate NIM master (just in case it was the current master for the NIM clients).

We have created the `/local` file system on each node, and a directory called `rg` in this file system. We place the scripts in the `/local/rg` directory and make sure they are synchronized between the cluster nodes.

When activated by the Event Response Resource Manager (ERRM), the script will be supplied with several environment variables, with names starting with `ERRM_`.

We are mostly interested in the following: the `ERRM_RSRC_CLASS_NAME`, `ERRM_COND_NAME` and `ERRM_ER_NAME` to identify the RSRC RM class set by the condition, the condition name, and the event name. These variables can be used to identify in the program what condition activated it, in case the same program are used to handle several conditions.

In our case, the variables will have the following values when the script is activated as shown in Example 4-323.

*Example 4-323 ERRM environment variables*

---

```
ERRM_RSRC_CLASS_NAME=PeerNode
ERRM_COND_NAME=PEER_DOWN
```

```
ERRM_ER_NAME=START_NIMESIS
ERRM_EXPR=OpState <> 1
ERRM_VALUE=6
```

---

The `ERRM_EXPR` variable contains the condition expression that became true and activated the response event to start our program. The actual value of the `OpState` variable, at the time of setting of the trigger, is supplied in the `ERRM_VALUE` variable, and in our case the 6 means a transitory state from online to offline.

```
#!/bin/ksh
takeover.nemesis
Synopsis.....%M%
Author.....User01
Created.....2006
Version.....%Z% %M% %I% (%E% %U%) %Q%
Description....N/A
Input.....N/A
Output.....Change the /etc/niminfo on all clients:
NIM_MASTER_HOSTNAME, NIM_MASTER_HOSTNAME_LIST and
NIM_HOSTS variables.
Algorithm.....Check if nimesis are running, start it if not,
perform takeover regardless.
#
#-----
trap 'exit 0' EXIT

export PATH=/usr/bin:/usr/sbin:/usr/es/sbin/cluster/utilities

NIMESISPID=$(lssrc -s nimesis|awk '!/PID/{if (/active/) print $3}')

if [[-z "$NIMESISPID"]] ;then
 printf "The \"nimesis\" SRC will be started.\n"
 startsrc -s nimesis
 sleep 6
else
 printf "The nimesis SRC is already running \"$NIMESISPID\".\n"
fi

ALTERNATE_MASTER=$(lsnim -Z -t alternate_master|awk -F: '!/^#{print $1;exit}')

printf "The NIM alternate_master is \"$ALTERNATE_MASTER\".\n"

[[-z "$ALTERNATE_MASTER"]] || nim -o takeover $ALTERNATE_MASTER
```

Figure 4-27 RSCD PeerDomain takeover.nemesis script

In the script, we end with a trap to ensure we return zero (0) as exit value.



# Network Installation Manager best practices

This chapter provides examples of how to configure and use Network Installation Manager. The examples are based on best practices and on the experiences of this book's authors and contributors:

- ▶ Updating the NIM environment (lpp\_source, SPOT)
- ▶ Secondary adapter
- ▶ NIMSH, OpenSSL and firewall considerations
- ▶ Cloning NIM clients using mksysb
- ▶ Using NIM to migrate systems to new hardware
- ▶ Using SAN zoning for cloning LPARs
- ▶ System maintenance for NIM clients
- ▶ Automatic scripts
- ▶ Implementing a standard operating environment for AIX 5L V5.3 systems with NIM
- ▶ How to back up and reinstall a NIM master

## 5.1 Updating the NIM environment (lpp\_source, SPOT)

Whenever there is a need to update the Technology Level (TL) or Service Pack (SP) in any NIM client, the first thing you need to do is to update your NIM master server. After the NIM master server is updated, you will need to update the lpp\_source follow by the SPOT.

**Note:** The NIM server must be at the same or higher level than the NIM clients. You need to upgrade your NIM server before upgrading your NIM client.

If your NIM environment has a mixture of TL levels, then in order to have some NIM clients at the original level, you need to keep a copy of the original lpp\_source and SPOT level. These clients will still need the original level of lpp\_source and SPOT.

In the next section, we describe the steps to perform the lpp\_source update. In this example, we have an original lpp\_source and SPOT level at TL04, and we are creating a new TL05 lpp\_source and SPOT.

1. Create a new AIX 5L V5.3 TL05's lpp\_source directory, for example, /export/lppsource/lpp-aix5305, and copy the AIX 5L V5.3 TL04's lpp\_source directory into it.

```
cp -rp /export/lppsource/lpp-aix5304/* \
/export/lppsource/lpp-aix5305
```

**Important:** Ensure that the files in /export/lppsource/lpp-aix5304/installp/ppc have Read permission for everybody. If they do not, use the **chmod 644 \*** command inside the lpp\_source directory.

Also ensure that the ownership of the files is root:system.

2. Create an AIX 5L V5.3 TL05 lpp\_source resource from the AIX 5L V5.3 TL05 lpp\_source directory, as shown in Example 5-1 on page 411. The following steps are followed when using the SMIT menus:

```
smitty nim
 Perform NIM Administration Tasks
 Manage Resources
 Define a Resource
 Select "lpp_source = source device for optional product
images"
```

Or, by using SMIT Fast Path: **smitty nim\_mkres**

### Example 5-1 Creating an AIX 5L V5.3 TL05 lpp\_source

---

Define a Resource

Type or select values in entry fields.  
Press Enter AFTER making all desired changes.

|                          |                                  |
|--------------------------|----------------------------------|
|                          | [EntryFields]                    |
| * Resource Name          | [LPP-AIX5305]                    |
| * Resource Type          | lpp_source                       |
| * Server of Resource     | [master] +                       |
| * Location of Resource   | [/export/lppsource/lpp-aix5305 / |
| Architecture of Resource | <input type="checkbox"/> +       |
| Source of Install Images | <input type="checkbox"/> +/      |
| Names of Option Packages | <input type="checkbox"/>         |
| Show Progress            | [yes] +                          |
| Comments                 | <input type="checkbox"/>         |

---

You can also use the command line as follows:

```
nim -o define -t lpp_source -a server=master -l \
/export/lppsource/lpp-aix5305 LPP-AIX5305
```

**Note:** NIM updates the .toc file in <lppsource>/installp/ppc automatically. Make sure the .toc file in /export/lppsource/lpp-aix5305/installp/ppc is updated.

3. Update the TL05 to the LPP-AIX5305 resource as shown in Example 5-2. You use the NIM update operation to perform the task. This operation allows you to update or remove any packages from the lppsource resource. The next steps are followed when using the SMIT menus:

```
smitty nim
Perform NIM Administration Tasks
 Manage Resources
 Perform Operations on Resources
 Select LPP-AIX5305
 Select "update = add or remove software to or from an
 lpp_source"
 Select "Add" and enter the Software media source
```

Or, by using SMIT Fast Path: **smitty nim\_update**

### Example 5-2 Adding software to an lpp\_source

---

Add Software to an lpp\_source

Type or select values in entry fields.  
Press Enter AFTER making all desired changes.

[EntryFields]

```

TARGET lpp_source LPP-AIX5305
SOURCE of Software to Add cd0
SOFTWARE Packages to Add [all]+
-OR-
INSTALLP BUNDLE containing packages to add [] +

gencopy Flags
 DIRECTORY for temporary storage during copying [/tmp]
 EXTEND filesystems if space needed? yes +
 Process multiple volumes? no +

```

---

You can also use the command line as follows:

```
nim -o update -a packages=all -a source=/dev/cd0 LPP-AIX5305
```

After you have updated the TL05 lpp\_source, there might be some duplicate updates. You can perform the NIM **lppmgr** operation to remove them. This operation enables you remove any duplicate software, superseded updates, unnecessary languages, and non-simage software.

We recommend that you remove the duplicate software and any superseded updates, but that you do not remove any language software and non-simage filesets unless you are sure that they are not needed for future use. We also recommend that you perform a preview to check what software will be removed before the actual removal.

4. Remove any duplicate updates in lpp\_source resource, as shown in Example 5-3.

The following steps are followed when using the SMIT menus:

```

smitty nim
 Perform NIM Administration Tasks
 Manage Resources
 Perform Operations on Resources
 Select LPP_AIX5305
 Select "lppmgr = eliminate unnecessary software images
 in an lpp_source"

```

Or, by using SMIT Fast Path: **smitty nim\_lppmgr**

*Example 5-3 Removing duplicate updates in the lpp\_source*

---

Eliminate Unnecessary Software Images in an lpp\_source

Type or select values in entry fields.  
Press Enter AFTER making all desired changes.

[EntryFields]

|                                     |             |
|-------------------------------------|-------------|
| TARGET lpp_source                   | LPP-AIX5305 |
| PREVIEW only?                       | no +        |
| REMOVE DUPLICATE software           | yes +       |
| REMOVE SUPERSEDED updates           | yes +       |
| REMOVE LANGUAGE software            | no +        |
| PRESERVE language                   | [en_US]     |
| REMOVE NON-SIMAGES software         | no +        |
| SAVE removed files                  | no +        |
| DIRECTORY for storing saved files   | []          |
| EXTEND filesystems if space needed? | yes +       |

---

You can also use the command line as follows:

```
nim -o lppmgr -a lppmgr_flags="-bu -x -r -e" LPP-AIX5305
```

**Note:** Run `lsnim -l LPP-AIX5305` to check the Rstate and simages. Rstate should show Ready for use and simages = yes.

Next, we need to create the AIX 5L V5.3 TL05 SPOT. We will create the SPOT using the latest LPP-AIX5305 lpp\_source.

5. Create the AIX 5L V5.3 TL05's SPOT as shown in Example 5-4. The following steps are followed when using the SMIT menus:

```
smitty nim_mkres
 Select "spot = Shared Product Object Tree - equivalent to /usr
 file"
```

#### Example 5-4 Creating a SPOT

---

##### Define a Resource

Type or select values in entry fields.  
Press Enter AFTER making all desired changes.

|                                           |                                  |
|-------------------------------------------|----------------------------------|
| * Resource Name                           | [Entry Fields]<br>[SPOT-AIX5305] |
| * Resource Type                           | spot                             |
| * Server of Resource                      | [master] +                       |
| * Source of Install Images                | [LPP-AIX5305] +                  |
| * Location of Resource                    | [/export/spot]/                  |
| EXPAND file systems if space needed?      | yes +                            |
| Comments                                  | []                               |
| installp Flags                            |                                  |
| COMMIT software updates?                  | no +                             |
| SAVE replaced files?                      | yes +                            |
| AUTOMATICALLY install requisite software? | yes +                            |
| OVERWRITE same or newer versions?         | no +                             |

VERIFY install and check file sizes? no +

---

After the updated lpp\_source and SPOT are created, you can perform a NIM check operation to check the usability of these resources. When you perform the NIM check operation on the lpp\_source resource, it rebuilds the table of contents (.toc) file in the lpp\_source directory and checks whether all the necessary filesets are in the directory to qualify the lpp\_source for the simage attribute.

6. Check the usability of the lpp\_source and SPOT as shown in Example 5-5. The following steps are followed when using the SMIT menus:

```
smitty nim_res_op
 Select SPOT-AIX5305 Or LPP-AIX5305
 Select "check = check the status of a NIM object"
```

*Example 5-5 Checking the SPOT*

---

Check the Status of a SPOT

Type or select values in entry fields.  
Press Enter AFTER making all desired changes.

|                          |               |
|--------------------------|---------------|
|                          | [EntryFields] |
| * Resource Name          | SPOT-AIX5305  |
| Build Debug Boot Images? | no +          |
| Force                    | no +          |

---

After the lppsource and SPOT resources are updated and ready for use, you can perform software maintenance on NIM clients. Refer to “Client-initiated software maintenance tasks (“pull”)” on page 496 for details.



## 5.2 Secondary adapter

The following section describes the secondary adapter support for the Network Installation Manager (NIM).

### 5.2.1 Secondary adapter support

Secondary adapter support is available for AIX 5L V5.2 or later. Prior to AIX 5L V5.2, during a NIM BOS rte installation operation, only the network adapter and interface used during BOS installation was configured. Using the NIM secondary adapter definitions, you can have additional network adapters and interfaces configured during a BOS installation or a customized installation.

The **nimadapters** command parses a secondary adapter stanza file to build the files required to add NIM secondary adapter definitions to the NIM environment as part of an `adapter_def` resource. The **nimadapters** command does not configure secondary adapters. The configuration takes place during a **nim -o bos\_inst** operation or a **nim -o cust** operation that references the `adapter_def` resource.

The secondary adapter stanza file is processed by the **nimadapters** command and turned into a file that contains one stanza for each secondary adapter or interface on the NIM client. During a BOS installation, NIM processes this information and configures the secondary adapters. If a secondary adapter is already configured in the requested manner, NIM does not reconfigure the secondary adapter.

**Note:** NIM uses the `/usr/lpp/bos.sysmgmt/nim/methods/c_cfgadptrs` client method to configure secondary adapters.

Table 5-1 on page 416 lists the flags accepted by the **nimadapters** command, and the purpose of each flag.

Table 5-1 The `nimadapters` command options

| Flag      | Purpose                                                                                                                                                                                                                                                                                                                                                                                                                                                                                                                                                                                                                                                                                          |
|-----------|--------------------------------------------------------------------------------------------------------------------------------------------------------------------------------------------------------------------------------------------------------------------------------------------------------------------------------------------------------------------------------------------------------------------------------------------------------------------------------------------------------------------------------------------------------------------------------------------------------------------------------------------------------------------------------------------------|
| <b>-a</b> | <p>Assigns the following attribute=value pairs:</p> <ul style="list-style-type: none"> <li>▶ <code>client=nim_client_name</code></li> </ul> <p>Specifies the NIM client that will have a secondary adapter definition added or removed. This option allows you to define one secondary adapter for a client. To define multiple secondary adapters, use a stanza file.</p> <ul style="list-style-type: none"> <li>▶ <code>info=AttributeList</code></li> </ul> <p>When previewing or defining a secondary adapter, the <code>info</code> attribute must be used when the <code>client</code> attribute is specified. <code>AttributeList</code> is a list of attributes separated by commas.</p> |
| <b>-d</b> | <p>Defines secondary adapters. A <code>Client.adapter</code> file is created in the <code>adapter_def</code> location for each valid secondary adapter definition. If the <b><code>nimadapters</code></b> command encounters existing secondary adapter definitions for a NIM client, the existing definitions are replaced.</p>                                                                                                                                                                                                                                                                                                                                                                 |
| <b>-f</b> | <p><code>SecondaryAdapterFileName</code>. Specifies the name of the secondary adapter file.</p>                                                                                                                                                                                                                                                                                                                                                                                                                                                                                                                                                                                                  |
| <b>-p</b> | <p>Displays a preview operation to identify any errors. This flag processes the secondary adapter file or <code>info</code> attribute, but does not add adapter definitions to the NIM environment.</p>                                                                                                                                                                                                                                                                                                                                                                                                                                                                                          |
| <b>-r</b> | <p>Removes the secondary adapter definitions of a specific client or all the clients listed in a secondary adapter stanza file. If the <code>client</code> attribute or secondary adapter stanza file is not specified, then all the secondary adapter definitions in the <code>adapter_def</code> resource will be removed.</p>                                                                                                                                                                                                                                                                                                                                                                 |

**Note:** Before using the `nimadapters` command, you must configure the NIM master.

## 5.2.2 Working with secondary adapter file rules

The format of the secondary adapter file must comply with the following rules:

- ▶ After the header stanza, the attribute lines format is: `Attribute = Value`.
- ▶ If the value of an attribute is defined multiple times within the same stanza, only the last definition is used.
- ▶ If an invalid attribute value or name is used, that attribute definition is ignored.
- ▶ Each line of the file can contain only one header or attribute definition.

- ▶ More than one stanza can exist in a definition file for each machine (host name).
- ▶ Each stanza for a machine (host name) represents a secondary adapter definition on that NIM client. No two secondary adapter definitions for the same machine host name can have the same location or interface\_name. There should be only one definition per adapter or interface on a given NIM client.
- ▶ If the stanza header entry is the default keyword, this specifies to use that stanza for the purpose of defining default values.
- ▶ A default value for any secondary adapter attribute can be specified. However, the netaddr and secondary\_hostname attributes must be unique. Also, the location and interface\_name attributes must be unique on a NIM client.
- ▶ If an attribute for a secondary adapter is not specified but default value exists, the default value is used.
- ▶ Default values at any location in the definition file can be specified and changed. After a default value is set, it applies to all definitions that follow.
- ▶ To turn off a default value for all following machine definitions, the attribute value in a default stanza must not be set.
- ▶ To turn off a default value for a single machine definition, the attribute value in the machine stanza must not be set.
- ▶ Comments in a client definition file can be included. Comments begin with the number sign (#).
- ▶ When parsing the definition file for header and attribute keywords and values, tab characters and spaces are ignored.

**Note:** During a `nim -o bos_inst` or `nim -o cust` operation, if NIM examines the configuration data on the client and determines that a secondary adapter is already configured with precisely the attributes requested in the adapter\_def resource, this secondary adapter is not reconfigured.

### 5.2.3 Secondary adapter files

This section describes secondary adapter files.

#### Using secondary adapter file keywords

The secondary adapter file uses keywords (see Table 5-2 on page 418) to specify machine attributes.

### Using required adapter attributes

Table 5-2 lists the required attributes used in configuring adapters.

Table 5-2 Required adapter attributes

| Attribute                                         | Purpose                                                                                                                                                                                                                                                                                                                                                       |
|---------------------------------------------------|---------------------------------------------------------------------------------------------------------------------------------------------------------------------------------------------------------------------------------------------------------------------------------------------------------------------------------------------------------------|
| machine_type = secondary   etherchannel   install | Specifying the machine_type attribute as secondary clearly distinguishes the nimadapters input from nimdef input. If a secondary adapter's file is mistakenly passed to the nimdef command, the error can be detected. The etherchannel option is only supported on clients running AIX 5L V5.3 or later. Stanzas with a machine_type of install are ignored. |
| netaddr                                           | Specifies the network address for the secondary adapter.                                                                                                                                                                                                                                                                                                      |
| interface_type = en   et   sn   ml   vi           | Specifies the type of network interface. The network interface can be en (Ethernet interface), et (Ethernet interface), sn (switch network interface), ml (multi-link interface), or vi (virtual interface). This attribute is only supported on clients running AIX 5L V5.3 or later, and it replaces the deprecated network_type attribute.                 |
| subnet_mask                                       | Specifies the subnet mask used by the secondary adapter.                                                                                                                                                                                                                                                                                                      |

### Using optional attributes

Table 5-3 lists the optional secondary adapter attributes.

Table 5-3 Optional adapter attributes

| Attribute            | Purpose                                                                                                                                                                                                                                                                                                                                                                  |
|----------------------|--------------------------------------------------------------------------------------------------------------------------------------------------------------------------------------------------------------------------------------------------------------------------------------------------------------------------------------------------------------------------|
| adapter_attributes   | Blank-separated list of physical adapter attributes and values; for example, Attribute1=Value1 Attribute2=Value2. To see the list of attributes that can be set for the requested adapter, run the command <b>lsattr -E -l AdapterName</b> . This attribute is only supported on clients running AIX 5L V5.3 or later.                                                   |
| interface_attributes | Blank-separated list of interface attributes and values; for example, Attribute1=Value1 Attribute2=Value2. To see the list of attributes that can be set for the requested interface, run the command <b>lsattr -E -l InterfaceName</b> . This attribute is only supported on clients running AIX 5L V5.3 or later, and it replaces the deprecated attributes attribute. |

| Attribute          | Purpose                                                                                                                                                                 |
|--------------------|-------------------------------------------------------------------------------------------------------------------------------------------------------------------------|
| cable_type         | Specifies the cable type (optional if network_type is en or et).                                                                                                        |
| comments           | Specifies a comment to include in the secondary adapter definition. Enclose the comment string in quotation marks.                                                      |
| interface_name     | Specifies the name of the network interface for the secondary adapter; for example, en1, sn0, ml0. Do not specify both location and interface_name.                     |
| location           | Specifies the physical location of the adapter corresponding to this network interface. Do not specify both the location and the interface_name attributes.             |
| multiple_physloc   | Specifies the physical adapters to associate with an interface when you use an etherchannel or VIPA stanza.                                                             |
| media_speed        | Specifies the media speed (optional if the network_type attribute's value is en or et).                                                                                 |
| secondary_hostname | Host name to save in the /etc/hosts file with the netaddr attribute. This host name is <i>not</i> set using the <b>hostname</b> command or the <b>uname -S</b> command. |

### **Working with deprecated attributes**

Table 5-4 lists attributes that were deprecated in AIX 5L V5.3, but are still available on clients running AIX 5L V5.2 or later.

**Note:** If you have a NIM secondary adapter configuration with an AIX 5L V5.2 client, then you must use network\_type and attributes because the new attributes are not supported.

Table 5-4 *Deprecated attributes*

| Attribute    | Purpose                          |
|--------------|----------------------------------|
| network_type | Replaced by interface_type.      |
| attributes   | Replaced by interface_attribute. |

**Note:** Configuring a secondary adapter sharing the same subnet with another adapter does not provide failover. Packets alternate between adapters when they are configured on the same subnet. If one of the adapters fails, the other adapter will *not* take over the failed adapter's workload, and the subnet will have connectivity problems. Commands such as **mount** might fail if this occurs.

## Sample secondary adapter file

Example 5-6 shows a sample file for the customization of a secondary adapter.

### Example 5-6 Secondary adapter file sample

---

```
Set default values.
default:
 machine_type = secondary
 subnet_mask = 255.255.240.0
 network_type = en
 media_speed = 100_Full_Duplex
Define the machine "lab1"
Take all defaults and specify 2 additional attributes.
Unlike the case of the client definitions that are input to the
nimdef command, the secondary adapter definition includes at least
one required field that cannot be defaulted.
lab1:
 netaddr = 9.53.153.233
 location = P2-I1/E1
Change the default "media_speed" attribute.
default:
 media_speed = 100_Half_Duplex
define the machine "test1"
Take all defaults and include a comment.
test1:
 comments = "This machine is a test machine."
define a machine with a VIPA interface that uses interfaces en2 and
en3.
lab2:
 machine_type = secondary
 interface_type = vi
 interface_name = vi0
 netaddr = 9.53.153.235
 subnet_mask = 255.255.255.0
 secondary_hostname = lab3
 interface_attributes = "interface_names=en2,en3"
define a machine with an etherchannel adapter that uses the adapters
at the following location codes P1-I4/E1 and P1/E1
lab4:
 machine_type = etherchannel
 interface_type = en
 interface_name = en2
 netaddr = 9.53.153.237
 subnet_mask = 255.255.255.0
 multiple_physloc = P1-I4/E1,P1/E1
define a machine with an etherchannel adapter that uses the
ent2 and ent3 adapters and uses mode 8023ad.
lab6:
 machine_type = etherchannel
```

```
interface_type = en
interface_name = en2
netaddr = 9.53.153.239
subnet_mask = 255.255.255.0
adapter_attributes = "adapter_names=ent2,ent3 mode=8023ad"
```

---

## Working with secondary adapter definitions

The following steps are used to accomplish common tasks working with secondary adapter definitions:

- ▶ To preview the secondary\_adapters.defs client definition file, type:  
`nimadapters -p -f secondary_adapters.defs adapter_def`
- ▶ To add the NIM secondary adapters described in the secondary\_adapters.defs secondary adapters definition file, type:  
`nimadapters -d -f secondary_adapters.defs adapter_def`
- ▶ To define the NIM secondary adapters for the pilsner client, type:  
`nimadapters -d \  
-a info="en,P2-I1/E1,N/A,100_Full_Duplex,9.53.53.15,255.255.254.0" \  
-a client=pilsner adapter_def`
- ▶ To remove the NIM secondary adapter definitions for a client called pilsner from the my\_adapter\_def resource, type:  
`nimadapters -r -a client=pilsner my_adapter_def`
- ▶ To remove the NIM secondary adapter definitions for clients defined in the file secondary\_adapters.defs, type:  
`nimadapters -r -f secondary_adapters.defs my_adapter_def`
- ▶ To remove all the NIM secondary adapter definitions from the my\_adapter\_def resource, type:  
`nimadapters -r my_adapter_def`

## 5.2.4 Configuring a secondary adapter

This section shows a practical example of how to configure a secondary adapter. This environment comprises two machines: machine lpar2, which is the NIM master, and v1par3, which is the client.

## Defining adapter\_def resource

The following procedure shows the steps executed for the creation of an adapter\_def resource:

- ▶ Type `smitty nim_res` in the NIM master.
- ▶ Select **Define a Resource** from the Manage Resources SMIT panel.
- ▶ Select **adapter\_def** from the list that shows up.
- ▶ Type the Resource Name (in this example, we choose `SEC_ADAPTR`).
- ▶ Type the Location of Resource (in this example, `/other_res/SEC_ADAPTR`).

### *Example 5-7 Adapter\_def resource creation*

---

|                        |                           |
|------------------------|---------------------------|
| * Resource Name        | [SEC_ADAPTR]              |
| * Resource Type        | adapter_def               |
| * Server of Resource   | [master] +                |
| * Location of Resource | [/other_res/SEC_ADAPTR] / |
| Comments               | []                        |

---

Example 5-7 shows the SMIT panel used to create the adapter\_def resource.

## Creating a secondary adapter definition file

The following procedure shows the steps executed for the creation of an adapter definition file:

- ▶ Type `smitty nim_adapt_def` in the NIM master.
- ▶ Select **Define Secondary Definition File** from the Manage Secondary Adapter Definition Files SMIT panel.
- ▶ Select the Adapter Definition Resource for the adapter.
- ▶ Select the Client Name.
- ▶ Select the Network Address.
- ▶ Select the Interface Type.
- ▶ Select the Subnet Mask.

The rest of the fields are blank for the purposes of this example.

Example 5-8 shows the SMIT panel used to create the adapter definition file.

### *Example 5-8 Adapter definition file creation*

---

|                               |                |
|-------------------------------|----------------|
| * Adapter Definition Resource | [SEC_ADAPTR] + |
| * Client Name                 | [VLPAR3] +     |
| Machine Type                  | secondary      |

---



|                         |                 |
|-------------------------|-----------------|
| * Network Address       | [10.1.1.75]     |
| * Interface Type        | [en] +          |
| * Subnet Mask           | [255.255.255.0] |
| Interface Attributes    | []              |
| Cable Type              | [] +            |
| Interface Name          | []              |
| Location                | []              |
| Media Speed             | [] +            |
| Secondary Hostname      | []              |
| Adapter Attributes      | []              |
| Multiple Location Codes | []              |
| Comments                | []              |

---

SMIT uses the **nimadapters** command to generate the NIM secondary adapter definitions to the NIM environment as part of the adapter\_def resource. This command can also be executed using the command line instead of SMIT, either giving the **nimadapters** command a secondary adapter stanza file or all the necessary options.

Example 5-9 shows the output of the command execution for the creation of the adapter definition file.

*Example 5-9 Adapter definition file creation output*

---

1 secondary adapter definition is complete. The following secondary adapter will be added to the NIM environment:

```
VLPAR3:
 hostname=VLPAR3
 machine_type=secondary
 interface_type=en
 hostaddr=10.1.1.63
 netaddr=10.1.1.75 vlpar3_en1
 subnet_mask=255.255.255.0
 adapter_attributes=secondary
```

Summary

1 Secondary adapter will be added to the NIM environment.

Summary

1 Secondary adapter will be added to the NIM environment.

---

The VLPAR3.adapters file is created in the /other\_res/SEC\_ADAPTR directory. Example 5-10 shows the content of the adapter definition file.

*Example 5-10 Adapter definition file content*

---

```
VLPAR3:
 hostname=VLPAR3
 machine_type=secondary
 interface_type=en
```

```
hostaddr=10.1.1.63
netaddr=10.1.1.75 v1par3_en1
subnet_mask=255.255.255.0
adapter_attributes=secondary
```

---

NIM customization must be performed now in order to apply these definitions. Example 5-11 shows the execution of the customization to enable the secondary adapter in the client.

*Example 5-11 Client customization*

---

```
(root@lpar2):/ # nim -o cust -a adapter_def=SEC_ADAPTR VLPAR3
nim_name = VLPAR3
machine_type = secondary
interface_type = en
network_type =
logical_name =
location =
multiple_physloc =
secondary_hostname =
netaddr = 10.1.1.75
subnet_mask = 255.255.255.0
cable_type =
media_speed =
attributes =
interface_attributes =
adapter_attributes = secondary
bos_preconfig =
cust_preconfig =
route =
Could not get the current value of "secondary" for ent1. Will
 attempt to set "secondary".

Network device busy. Changing "ent1". Will take effect on the next reboot.

en1
en1 changed
```

---

At this point, the client v1par3 is configured with two interfaces, en0 and en1. The interface en1 has been configured through NIM customization.

## 5.3 NIMSH, OpenSSL and firewall considerations

Up to the actual release, by default the Network Installation Manager (NIM) makes use of the remote shell server (rshd) when it performs remote command

execution on clients. The server provides remote execution facilities with authentication based on privileged port numbers from trusted hosts.

However, starting with AIX 5L V5.2 ML 07 and AIX 5L V5.3, a new feature called the NIM Service Handler (NIMSH) is available. This eliminates the need for classic `r` commands during NIM client communication. For environments where the standard `rsh` protocols are not considered secure enough, `nimsh` should be implemented. The NIM client daemon (NIMSH) uses reserved ports 3901 and 3902, and it installs as part of the `bos.sysmgt.nim.client` fileset.

NIMSH provides a “wrapper” for classic `r` commands. Only the commands registered with NIMSH (residing in `/usr/lpp/bos.sysmgt/nim/methods` directory) are executed as root; anything else is denied execution.

NIMSH allows you to query network machines by hostname. NIMSH processes query requests and returns NIM client configuration parameters used for defining hosts within a NIM environment. Using NIMSH, you can define NIM clients without knowing any system-specific or network-specific information.

Although NIMSH eliminates the need for `rsh`, in the default configuration it does not provide trusted authentication based on key encryption. To use cryptographic authentication with NIMSH, you can configure NIMSH to use OpenSSL in the NIM environment. When you install OpenSSL on a NIM client, SSL socket connections are established during NIMSH service authentication. Enabling OpenSSL provides SSL key generation and includes all cipher suites supported in SSL version 3.

There are two ports involved in NIMSH communication. These ports are referred to as the primary (port 3901) and secondary port (port 3902). The primary port listens for service requests. When a request is accepted, the primary port is used for `stdin(0)` and `stdout(1)`; `stderr(2)` is redirected to the secondary port.

This implementation allows the NIM master connection to stay consistent with current support of client connections through `rsh`. Using a reserved secondary port in NIMSH allows firewall administrators to write firewall rules for accepting incoming connections on privileged ports from the secondary port. This rules can have the requirement that the originating socket address (hostname : secondary port) comes from a trusted source.

NIMSH is registered with the System Resource Controller (SRC). The SRC group name is `nimclient` and the subsystem defined is NIMSH. The client daemon is started by SRC when the configuration routine is run using the `nimclient` command.

It is possible to have a heterogeneous environment of clients using the remote shell server (`rshd`) and NIM Service Handler (NIMSH). However, it is not possible

to perform operations for which information is provided using NIMSH in clients that are not using NIMSH. For example, the `nimquery` command is not able to retrieve information from clients that are not using NIMSH.

**Note:** The NIM client daemon logs data, used only for debug purposes, in the `/var/adm/ras/nimsh.log` file.

### 5.3.1 Authentication process

NIMSH handles service requests similar to the way they are handled in `rcmd()`. The NIM master builds packets with the following data for authentication:

- ▶ Host name of NIM client.
- ▶ CPUID of NIM client.
- ▶ CPUID of NIM master.
- ▶ Return port for secondary (`stderr`) connection.
- ▶ Query flag.

If the Query flag is set to 1, then the `nimsh` daemon treats the incoming request as a client discovery for information. The following data is returned:

- ▶ Default host name obtained from `inet0`.
- ▶ Default route obtained from `inet0`.
- ▶ Network address obtained from host name.
- ▶ Network interface obtained from host name.

If the query flag is not set, then a request for service (NIM operation) is pushed by the NIM master. The `nimshd` daemon validates the method request as follows:

- ▶ Verify the host name of the NIM master is the recognized master host name to the client.
- ▶ Check the client CPUID passed in the authentication data. It should match the client's machine ID.
- ▶ Check the master CPUID passed in the authentication data. It should match the master's machine ID stored in the memory. It is read into the memory from the `/etc/niminfo` file and the `mktcpip -S primary_nim_interface` command outputs.
- ▶ Verify that the operation passed in the method is a method residing in the `/usr/lpp/bos.sysmgmt/nim/methods` directory (path).
- ▶ Check for cryptographic authentication settings.

Figure 5-1 shows the connections involved in performing a NIM push operation when the client is configured to use NIMSH.

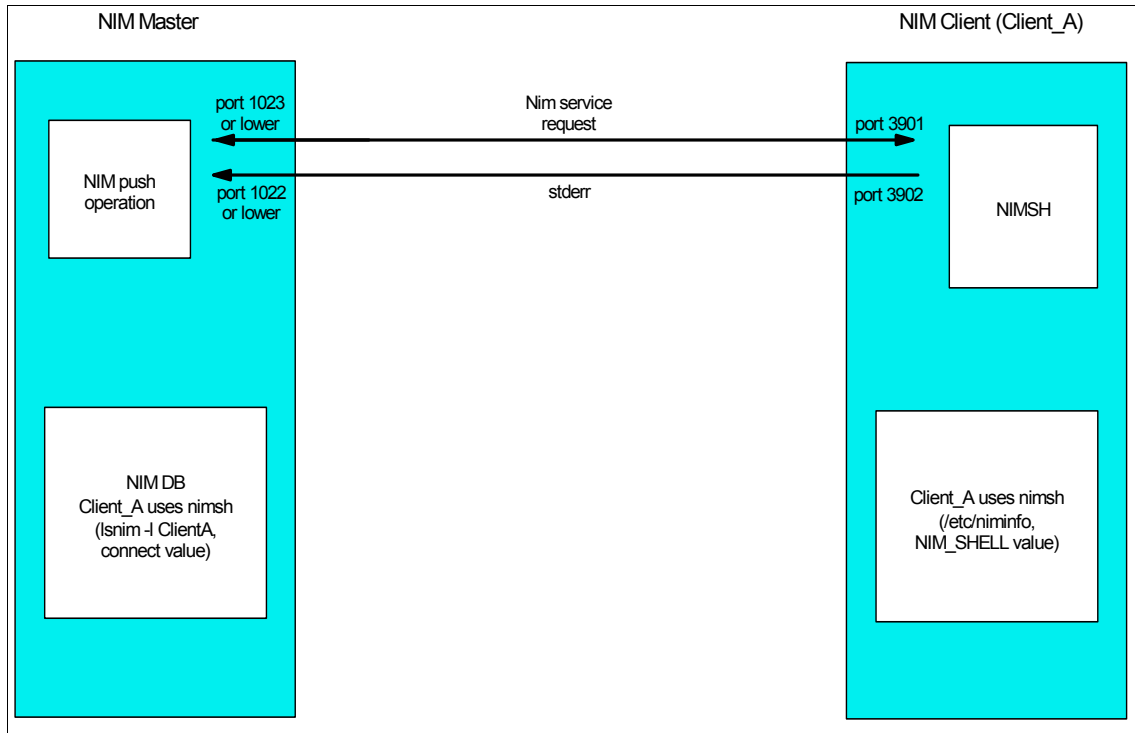

Figure 5-1 NIM operations through NIMSH

### 5.3.2 Setting up NIMSH

The following procedure should be used to configure existing standalone clients with NIMSH.

#### **Using SMIT**

Use the following SMIT menus:

```
smitty nim_config_services
 Select nimsh
```

#### **Or, from the command line**

The following step is done via the command line.

- ▶ Type the following command on the NIM client: `# nimclient -C`

**Notes:**

- ▶ In order to set up NIMSH, the NIM client must already be configured, and both client and master must have AIX 5L V5.3 or later installed.
- ▶ NIMSH must be configured only in the client.

### 5.3.3 Verifying NIMSH startup

Run this command to verify that the NIMSH daemon is enabled on the client:

```
lssrc -s nimsh
```

The output should look similar to Example 5-12.

*Example 5-12 Verifying NIMSH startup*

---

```
lssrc -s nimsh
Subsystem Group PID Status
nimsh nimclient 245944 active
```

---

**Note:** After NIMSH is configured on the client, you no longer need the entry for the NIM master on the `~/.rhosts` file on that client because NIM no longer uses classical `r` commands to perform operations in the client.

### 5.3.4 Enabling cryptographic authentication

You can configure existing standalone clients to use the NIMSH communication with SSL enabled. NIM supports OpenSSL versions 0.9.6e and higher. When OpenSSL is installed, NIMSH uses SSL-encrypted certificates for authenticating the connecting NIM master.

You can install and configure the OpenSSL cryptographic software using the NIM command options. Scripts are provided for configuring OpenSSL in the NIM environment, and you can use these without any modifications. The scripts are installed as part of the `bos.sysmgmt.nim.client` fileset and located in the `/usr/samples/nim/ssl` directory. The scripts are used to define SSL keys and certificates for NIM SSL usage.

Because NIM masters can support a large system environment, it is necessary to impose a hierarchy on SSL certificate and key storage structure. During NIM setup, the directory structure described in Table 5-5 on page 429 is created.

Table 5-5 Directory hierarchy on SSL certificate and key storage

| Directory          | Usage                                                     |
|--------------------|-----------------------------------------------------------|
| /ssl_nimsh         | SSL parent directory for NIM                              |
| /ssl_nimsh/configs | Contains scripts used to configure SSL in NIM             |
| /ssl_nimsh/certs   | Contains SSL certificates used during host authentication |
| /ssl_nims/keys     | Contains SSL keys used during SSL protocol communication  |

The NIM SSL directory structure is considered static and you should not modify it. To change SSL certificate options, you can modify the scripts described in Table 5-6.

Table 5-6 SSL authentication configuration scripts

| Script name    | Usage                                                              |
|----------------|--------------------------------------------------------------------|
| SSL_root.cnf   | Generates Certificate Authority key for signing certificates       |
| SSL_server.cnf | Generates the NIM master's certificate for distributing to clients |
| SSL_client.cnf | Generates the NIM master's local certificate for authenticating    |

## Installing OpenSSL on the NIM master

OpenSSL must be installed on the NIM master in order to be able to configure SSL authentication on the NIM master.

To install the OpenSSL on the NIM master follow these steps:

- ▶ Type the smitty nim\_task\_inst fastpath on the NIM master.
- ▶ Select **Install Software** from the SMIT panel.
- ▶ Select the name of your NIM master from the list that appears.
- ▶ Select the LPP\_SOURCE containing the install images for OpenSSL.
- ▶ Select the package **openssl-0.9.7g** on the field Software to Install.
- ▶ Select the values, for the rest of the options, which best fit your requirements.

The package version may be different. The openssl-0.9.7g package can be found on the Linux Toolbox for AIX distribution media.

Example 5-13 shows the SMIT panel used for the OpenSSL installation on the NIM master.

*Example 5-13 OpenSSL installation on the NIM master*

---

|                                                                              |                 |     |
|------------------------------------------------------------------------------|-----------------|-----|
| * Installation Target                                                        | master          |     |
| * LPP_SOURCE                                                                 | LPP_53_ML4      |     |
| * Software to Install                                                        | [openssl-0.9.7g | > + |
| Customization SCRIPT to run after installation<br>(not applicable to SPOTs)  | []              | +   |
| Force                                                                        | no              | +   |
| installp Flags                                                               |                 |     |
| PREVIEW only?                                                                | [no]            | +   |
| COMMIT software updates?                                                     | [yes]           | +   |
| SAVE replaced files?                                                         | [no]            | +   |
| AUTOMATICALLY install requisite software?                                    | [yes]           | +   |
| EXTEND filesystems if space needed?                                          | [yes]           | +   |
| OVERWRITE same or newer versions?                                            | [no]            | +   |
| VERIFY install and check file sizes?                                         | [no]            | +   |
| ACCEPT new license agreements?<br>(AIX V5 and higher machines and resources) | [yes]           | +   |
| Preview new LICENSE agreements?                                              | [no]            | +   |
| Group controls (only valid for group targets):                               |                 |     |
| Number of concurrent operations                                              | []              | #   |
| Time limit (hours)                                                           | []              | #   |
| Schedule a Job                                                               | [no]            | +   |
| YEAR                                                                         | []              | #   |
| MONTH                                                                        | []              | +#  |
| DAY (1-31)                                                                   | []              | +#  |
| HOUR (0-23)                                                                  | []              | +#  |
| MINUTES (0-59)                                                               | []              | +#  |

---

### Installing OpenSSL on the NIM client

OpenSSL must be installed on the NIM client in order to be able to configure SSL authentication on the NIM client.

Follow these steps to configure OpenSSL on the nim client:

- ▶ Type the smitty nim\_client\_inst fast path on the NIM client.
- ▶ Select **Install Software** from the SMIT menu.
- ▶ Select the LPP\_SOURCE containing the install images for OpenSSL
- ▶ Select the package **openssl-0.9.7g** on the field Software to Install.



- ▶ Select the values for the rest of the options which best fit your requirements.

Example 5-14 shows the SMIT panel used for the OpenSSL installation on the NIM master.

*Example 5-14 OpenSSL installation on the NIM client*

---

|                                                                             |                 |     |
|-----------------------------------------------------------------------------|-----------------|-----|
| * LPP_SOURCE                                                                | LPP_53_ML4      |     |
| * Software to Install                                                       | [openssl-0.9.7g | > + |
| Customization SCRIPT to run after installation<br>(not applicable to SPOTs) | []              | +   |
| installp Flags                                                              |                 |     |
| PREVIEW only?                                                               | [no]            | +   |
| Preview new LICENSE agreements?                                             | [no]            | +   |
| ACCEPT new license agreements?                                              | [yes]           | +   |
| COMMIT software updates?                                                    | [yes]           | +   |
| SAVE replaced files?                                                        | [no]            | +   |
| AUTOMATICALLY install requisite software?                                   | [yes]           | +   |
| EXTEND filesystems if space needed?                                         | [yes]           | +   |
| OVERWRITE same or newer versions?                                           | [no]            | +   |
| VERIFY install and check file sizes?                                        | [no]            | +   |

---

## SSL authentication configuration on the NIM master

The NIM master must already be configured for SSL authenticating within the NIM environment, because it is the public key server for the clients. The following procedure configures the NIM master for SSL authentication within the NIM environment.

The following sections shows how to configure SSL authentication on the NIM master using either SMIT or the command line.

### **Using SMIT**

Follow these steps to configure SSL authentication on the NIM master:

- ▶ Type the smitty nim\_ssl fast path on the NIM master.
- ▶ Set the value for Enable Cryptographic Authentication for client communication? to enable.

The output shown in Example 5-15 is obtained when enabling cryptographic authentication for client communication on the NIM master using SMIT.

*Example 5-15 SSL authentication configuration on the NIM master using smit*

---

```
x - /opt/freeware/lib/libssl.so.0
x - /opt/freeware/lib/libcrypto.so.0
```

```

Generating a 1024 bit RSA private key
.....+++++
.....+++++
writing new private key to '/ssl_nimsh/keys/rootkey.pem'

Signature ok
subject=/C=US/ST=Texas/L=Austin/O=ibm.com/CN=Root CA
Getting Private key
Generating a 1024 bit RSA private key
.....+++++
.+++++
writing new private key to '/ssl_nimsh/keys/clientkey.pem'

Signature ok
subject=/C=US/ST=Texas/L=Austin/O=ibm.com
Getting CA Private Key
Generating a 1024 bit RSA private key
.....+++++
.....+++++
writing new private key to '/ssl_nimsh/keys/serverkey.pem'

Signature ok
subject=/C=US/ST=Texas/L=Austin/O=ibm.com
Getting CA Private Key
Target "all" is up to date.

```

---

### ***From the command line***

The following command configures SSL authentication on the NIM master:

```
nimconfig -c
```

The output should look similar to Example 5-16.

#### ***Example 5-16 SSL authentication configuration on the NIM master***

---

```

nimconfig -c
NIM_MASTER_HOSTNAME=lpar2
x - /opt/freeware/lib/libssl.so.0
x - /opt/freeware/lib/libcrypto.so.0
Target "all" is up to date.
Generating a 1024 bit RSA private key
.....+++++
.....+++++
writing new private key to '/ssl_nimsh/keys/rootkey.pem'

Signature ok
subject=/C=US/ST=Texas/L=Austin/O=ibm.com/CN=Root CA
Getting Private key
Generating a 1024 bit RSA private key

```

```

....+++++
.....
.
.....+++++
writing new private key to '/ssl_nimsh/keys/clientkey.pem'

Signature ok
subject=/C=US/ST=Texas/L=Austin/O=ibm.com
Getting CA Private Key
Generating a 1024 bit RSA private key
...+++++
.....+++++
writing new private key to '/ssl_nimsh/keys/serverkey.pem'

Signature ok
subject=/C=US/ST=Texas/L=Austin/O=ibm.com
Getting CA Private Key

```

---

**Note:** When cryptographic authentication is enabled, output regarding authentication is sent to the syslogd daemon.

## Enabling cryptographic authentication on the client

The following procedure describes the steps to configure existing standalone clients to use NIMSH communication protocol with SSL enabled.

### *Using SMIT*

The following are the steps while using the SMIT menus:

- ▶ Type the `smitty nim_config_services` fast path on the NIM client.
- ▶ Select **nimsh** as the Communication Protocol used by client.
- ▶ Set the value for Enable Cryptographic Authentication? to `enable`.
- ▶ Select **yes** as the option for Installing Secure Socket Layer Software, if OpenSSL is not installed on the client.
- ▶ Specify the absolute path for the RPM package, or select the `lpp_source` resource that contains the OpenSSL RPM package.

### *From the command line*

The following are the steps while using the command line:

- ▶ If OpenSSL is installed on the NIM client, type the following command:
 

```
nimclient -c
```
- ▶ If OpenSSL is not installed on the NIM client, complete the following steps:
  - Locate the Toolbox for Linux Applications CD.

- Install OpenSSL RPM package.
- Type the following command on the NIM client after OpenSSL is installed:  

```
nimclient -c
```

Example 5-17 shows the output for the command issued to enable cryptographic authentication.

*Example 5-17 Enabling cryptographic authentication via command line*

---

```
nimclient -c
Received 2718 Bytes in 0.0 Seconds
0513-044 The nimsh Subsystem was requested to stop.
0513-059 The nimsh Subsystem has been started. Subsystem PID is 319594.
```

---

**Notes:**

- ▶ In order to enable cryptographic authentication the NIM master must already be configured for SSL authentication, and both client and master must have AIX 5L V5.3 or later installed.
- ▶ Any communication initiated from the NIM client (pull operation) reaches the NIM master on the request for services and registration ports (1058 and 1059, respectively). This communication is not encrypted.

For any communication initiated from the NIM master (push operations), the NIM master communicates with the NIM client using the NIMSH daemon. This allows an encrypted handshake dialog during authentication. However, data packets are not encrypted.

### 5.3.5 Enabling a secondary port for NIMSH communication

By default, NIMSH uses a reserved port for returning stderr output during command execution. The default setting allows administrators to specify a specific port for opening through a firewall. However, it can cause performance issues when several connections are attempted in a short amount of time.

When TCP connections are closed, the closing sockets enter TIME\_WAIT state. The length of time for this state may last up to 240 seconds, depending on system settings. The secondary port option allows you to specify any specific range of ports to cycle through during NIMSH operation.

For firewalls, administrators might want to open a specific port range through the firewall, and then for each machine on the internal network, ensure that the port range on the machine coincides with the open range through the firewall. When changing the NIMSH secondary port, choose a range of ports outside of the

range used for system services. We recommend using ports 49152 through 65535.

### Using SMIT to enable a secondary port

Complete these steps to configure existing standalone clients to use the NIMSH communication protocol with a secondary port range.

- ▶ Type the `smitty nim_config_services` fast path on the NIM client.
- ▶ Select **nimsh** as the Communication Protocol used by client.
- ▶ Specify a start value for the secondary port number.
- ▶ Specify an increment value for the secondary port range.

### Using command line to enable a secondary port

Complete these steps to configure existing standalone clients to use the NIMSH communication protocol with a secondary port range from the command line.

- ▶ Edit the `/etc/environment` file.
- ▶ Add the variable `NIM_SECONDARY_PORT=60000:5`, to use ports 60000 - 60005 within NIMSH.
- ▶ Use the desired `nimclient` command option to restart the NIMSH daemon.

**Note:** In order to enable a secondary port, the NIM client must already be configured and both master and client must have AIX 5L V5.3 or later.

## 5.3.6 Disabling push operations using NIMSH

NIM clients can prohibit the NIM master from allocating resources or initiating operations by disabling push operations. When push disablement is set, NIMSH does not process any NIM operation controlled by the NIM master.

Although master control is disabled, the client can still control the allocation of NIM resources and the initiation of NIM operations. The NIM master must have push permissions to perform push operations on the NIM clients.

To configure existing standalone clients to use NIMSH communication protocol with NIM master control disabled, use the following procedures.

### Using Web-Based System Management

This section describes how to use Web-Based System Management.

- ▶ From the main Web-Based System Management container, select the **Software** icon.

- ▶ From the Software menu, select **NIM Client** → **Permissions**.
- ▶ Select whether to grant or deny permission for the NIM master to initiate push installations.

## Using SMIT

You can use the `smit nim_perms` fast path to disable the master push permissions.

To disable the master's push permissions, enter the `smit nim_perms` fast path from the client machine and select whether to grant or deny permission for the NIM master to initiate push installations.

## Using command line

You can disable and re-enable the master push permissions from the command line.

To set control on the client to `push_off`, enter the following on the client machine:

```
nimclient -P
```

To re-enable push permission on the client, enter the following on the client machine:

```
nimclient -p
```

## 5.3.7 Disabling pull operations

You can disable pull operations (operations initiated from the NIM client) by shutting down the `nimesis` subsystem from SRC on the NIM master, as shown in Example 5-18. Disabling pull operations this way applies to all NIM clients.

If you need to disable pull operations for a particular NIM client, you can enable CPU validation on the NIM master and provide a non-matching CPU id for the CPU id on the NIM client object definition. For information regarding how to configure CPU validation, refer to 4.4, “Using NIM to perform AIX migrations of NIM master and clients” on page 151.

*Example 5-18 Shutting down the nimesis subsystem*

---

```
(root@lpar2):/ # stopsrc -s nimesis
0513-044 The nimesis Subsystem was requested to stop.
```

---

### 5.3.8 NIM communication within a firewall environment

NIM is unaware of any network security when it attempts to perform either a push operation or pull operation. If there is a firewall between the master/server and the client, it has to be configured to allow traffic for all the protocols involved in NIM operations.

When a network install is performed, there are several protocols involved. The following section describes steps to help firewall administrators to configure the firewalls to provide access for clients to the different resources.

#### Installation overview

NIM performs network installation by using a client/server model based on the bootp/tftp protocols for receiving a network boot image. After the boot image is obtained, the client requests (tftp) a configuration file (niminfo) to determine which server(s) contain the install image and other necessary install resources. The install image and resources are nfs mounted using nfsd/mountd services. After all mounts succeed, the install begins and subsequent information is sent to the NIM master via nimclient calls to the nimesis daemon (NIM).

Upon completion of install, the client sends state information to the master via nimclient calls to the nimesis daemon. The NIM master then deallocates all install resources from the client object that has completed installing. The deallocation process consists of the following tasks:

- ▶ Removing files from designated tftp directory
  - Remove niminfo file
  - Remove link to boot image
  - Remove file entry in /etc/bootptab
- ▶ Unexporting nfs resources from client
  - Remove entries from /etc/exports
  - Export remaining entries from /etc/exports
- ▶ Updating client object information in the NIM database
  - Machine state (running / not running)
  - Command result (success or failure) client state (ready for an operation)

#### Installation process

In this section, we describe the client-server communication during a NIM installation. a NIM master push is presented, along with specifics of the installation process.

#### Master-initiated installation

When a network installation is initiated from the master', the NIM master prepares resources for installation (create script files, NFS export resources,

create file entry in /etc/bootptab), and then executes an RSH command on the client to set the bootlist for install over the network interface. The client resets and attempts to boot over the network using bootp and tftp services. Figure 5-2 shows the ports and protocols involved in NIM communications.

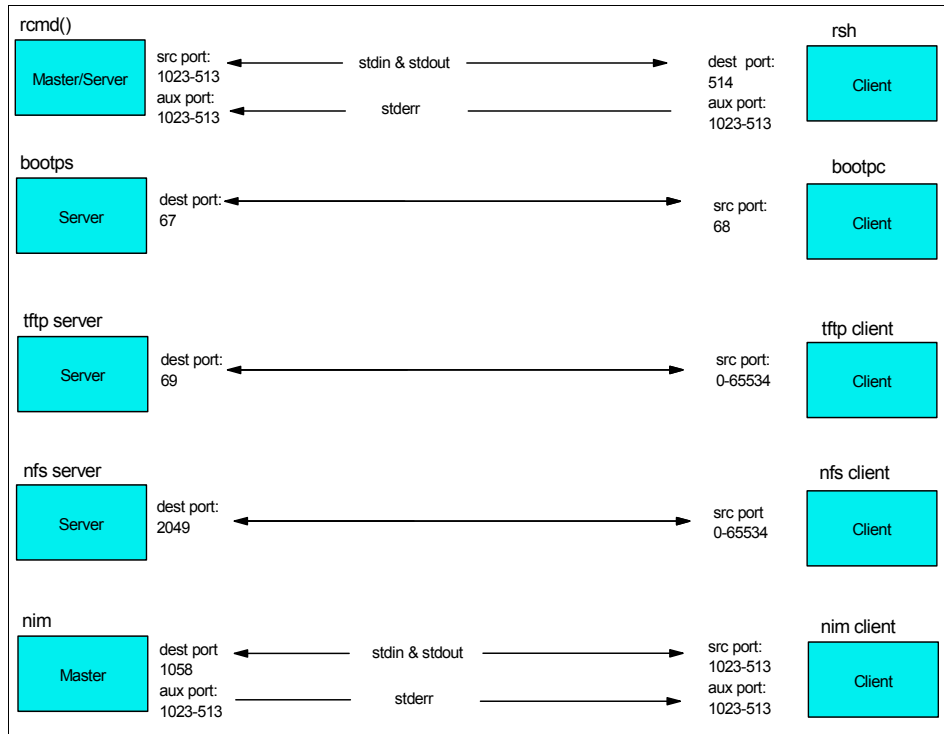

Figure 5-2 NIM protocols

**Note:** Firewall administrators must allow traffic for the protocols involved in a NIM operation.

## Protocols involved in a NIM operation

This section describes the protocols involved in a NIM operation.

### Remote shell (RSH)

Remote shell requires clients to connect using source ports obtained from the reserved port range of 1023-513. Because NIM clients do not have a client service, the clients communicate by calling `rcmd()`, which in turn, calls `reservport()` to create a TCP socket and binds a port from the privileged port range of 1023-513.



The port is determined by initializing the starting port at 1023 and attempting to bind it; if this fails, the port number is decremented and the bind to the port is reattempted. This process continues until an unused port is found or port 513 has been reached.

Upon successful binding of the source port, `rcmd()` allows the option of binding a secondary (auxiliary) port for any `stderr`. When set, `rresvport()` is called, but this time the starting port is based on the source port that was obtained in the previous step (`source - 1`). After it is initialized, the process for binding is repeated and upon success, this port keeps open for any `stderr` received from the destination service.

NIM makes use of this option and passes return code status (in addition to error messages) over the secondary port.

### ***Boot protocol (BOOTP)***

The BOOTP protocol uses two reserved port numbers: BOOTP client (68) and BOOTP server (67). The client sends requests using BOOTP server as the destination port; this is usually a broadcast. The server sends replies using BOOTP client as the destination port; depending on the kernel or driver facilities in the server, this may or may not be a broadcast. The reason two reserved ports are used is to avoid “waking up” and scheduling the BOOTP server daemons, when a boot reply must be broadcast to a client.

### ***Trivial File Transfer Protocol (TFTP)***

The TFTP protocol uses transfer identifiers (TIDs) as ports for communication; therefore they must be between 0 and 65,535. In order to create a connection, each end of the connection chooses a TID for itself, to be used for the duration of that connection.

The TIDs chosen for a connection should be randomly chosen, so that the probability that the same number is chosen twice in immediate succession is very low. Every packet has associated with it the two TIDs of the ends of the connection, the source TID and the destination TID.

These TIDs are handed to the supporting UDP (or other datagram protocol) as the source and destination ports. A requesting host chooses its source TID as previously described, and sends its initial request to the known TID 69 decimal (105 octal) on the serving host. The response to the request, under normal operation, uses a TID chosen by the server as its source TID and the TID chosen for the previous message by the requestor as its destination TID. The two chosen TIDs are then used for the remainder of the transfer.

## ***Network File System***

The Network File System (NFS) protocol currently uses the UDP port number 2049. This is not an officially assigned port, so later versions of the protocol use the port mapping facility of Remote Procedure Call (RPC). The port mapper program maps RPC program and version numbers to transport-specific port numbers. This program makes dynamic binding of remote programs possible.

This is desirable because the range of reserved port numbers is very small and the number of potential remote programs is very large. By running only the port mapper on a reserved port (111), the port numbers of other remote programs can be ascertained by querying the port mapper.

The port mapper also aids in broadcast RPC. A given RPC program will usually have different port number bindings on different machines, so there is no way to directly broadcast to all of these programs. The port mapper, however, does have a fixed port number. So, to broadcast to a given program, the client actually sends its message to the port mapper located at the broadcast address. Each port mapper that picks up the broadcast, and then calls the local service specified by the client. When the port mapper gets the reply from the local service, it sends the reply back to the client.

## ***Network Installation Manager***

Clients communicate to the Network Installation Manager (NIM) master using TCP ports 1058 (nim) and 1059 (nimreg). During the install process, the NIM clients send status information. The information contains details specific to the install progress. This information is updated in the NIM database and actions on the master's side are handled accordingly; when necessary, resources are deallocated (unexported) and boot images are removed.

The clients do not have a registered client service, so they use `rcmd()` to obtain sockets based on the rules described in "Remote shell (RSH)" on page 438. The API is passed the service port of 1058 for establishing a connection to the NIM master.

The nimesis daemon runs on the NIM master and listens on the NIM service port. When a request for service is received, the nimesis daemon accepts the connection, verifies the originator, and sends an ACK signal in a similar fashion as expected by `rcmd`. Upon a successful connection, state information is passed and commands are placed on the client using the secondary port which has a file descriptor associated with the socket.

Because NIM clients do not have access to the NIM database, all NIM commands are interpreted on the NIM master's side and subsequent operations are placed on the client for shell execution. This detail is important to understand because clients are allowed the option of requesting NIM operations. Since

clients have no knowledge of which commands must execute per NIM operation. The requests are always sent to the NIM master (1058) and the master responds by pushing (rsh) the necessary commands on the client machines.

The registration port (1059) is used when clients attempt to add themselves to a current NIM environment. The clients use `rcmd()` to obtain sockets and pass the service port 1059 for establishing a connection to the NIM master. When connected, clients pass machine configuration information to the NIM master. The NIM database is updated with the newly defined client object, and rsh permissions are given to the NIM master.

### 5.3.9 NFS reserved ports

Usage of NFS reserved ports can be enabled within a NIM environment starting with AIX 5L V5.3 TL 05 and later. Enabling usage of NFS reserved ports forces NIM clients to use reserved ports (ports below 1024) for NFS communications to the NIM server.

Enabling usage of NFS reserved ports adds the attribute `nfs_reserved_ports` to the NIM master object. The value for this attribute is set to `yes`. All installing clients configure the `nfso` option `nfs_use_reserved_ports` setting this value to 1 within the install environment.

Any clients installed this way are also be able to configure the `nfso` client option prior to NIM client operations. Clients participating in a NIM environment where `nfs_reserved_ports` is enabled are able to set the NFS client option prior to any NFS service requests.

When usage of NFS reserved ports is not enabled (which is the value by default), then NIM clients use non-reserved ports to perform NFS service requests to the NIM Server. In Example 5-19 we show the NFS traffic between a NIM client and a NIM server. It can be seen that the ports used for NFS communications are not the reserved ports. In this example our NIM server uses the IP 10.1.1.22 and the NIM client uses the IP 10.1.1.70. The `netstat` command is executed on the NIM server while the NIM client is performing a NIM operation involving NFS service requests.

*Example 5-19 Non-reserved ports usage*

---

```
(root@lpar2):/ # netstat -na | grep 10.1.1.70
tcp4 0 101040 10.1.1.22.2049 10.1.1.70.32786 ESTABLISHED
.....
```

---

The NIM clients already installed before enabling usage of NIM reserved ports should change their settings following the procedures shown in “Enabling NFS reserved ports on a NIM client already installed” on page 445.

After usage of NFS reserved ports is enabled, NIM clients use reserved ports for NFS traffic as shown in Example 5-20.

*Example 5-20 Reserved ports usage*

---

```
(root@lpar2):/ # netstat -na | grep 10.1.1.70
tcp4 0 0 10.1.1.22.2049 10.1.1.70.1021 ESTABLISHED
.....
```

---

## Enabling NFS reserved ports on the NIM master

This section describes how to enable NFS reserved ports on the NIM master.

### *Within a NIM environment*

Through this procedure you change the NIM master database to set that any client installed with this option sets the `nfs_reserved_ports` parameter to 1 and uses NFS reserved ports.

Follow these steps to configure NFS reserved ports usage within a NIM environment:

- ▶ Enter the `smitty nim_global_nfs fastpath` in the NIM master.
- ▶ Select **enable** as the value for the option `Enable/Disable Global Usage of NFS Reserved Ports?`.

Example 5-21 shows the SMIT panel used to enable usage of NFS reserved ports.

*Example 5-21 Enabling usage of NFS reserved ports*

---

Manage NFS Client Communication

Type or select values in entry fields.  
Press Enter AFTER making all desired changes.

[Entry Fields]

```
* Enable/Disable Global Usage of NFS Reserved Ports? [enable] +
* Allow NIM to enable port-checking on NIM master? [no] +
```

---

|          |            |           |          |
|----------|------------|-----------|----------|
| F1=Help  | F2=Refresh | F3=Cancel | F4=List  |
| F5=Reset | F6=Command | F7=Edit   | F8=Image |
| F9=Shell | F10=Exit   | Enter=Do  |          |

---

In Example 5-22, we see the attribute `nfs_reserved_port` set to `yes` to enable usage of NIM reserved port.

*Example 5-22 NIM master attributes*

---

```
(root@lpar2):/ # lsnim -l master
master:
 class = machines
 type = master
 max_nimesis_threads = 20
 if_defined = chrp.mp.ent
 comments = machine which controls the NIM environment
 platform = chrp
 netboot_kernel = mp
 if1 = ent-Network1 lpar2 00096B4EAD9C
 cable_type1 = N/A
 Cstate = ready for a NIM operation
 prev_state = ready for a NIM operation
 Mstate = currently running
 serves = LPP_5305
 serves = SEC_ADAPTR
 serves = SPOT_5305
 serves = boot
 serves = nim_script
 master_port = 1058
 registration_port = 1059
 reserved = yes
 ssl_support = yes
 nfs_reserved_port = yes
```

---

### For a single NIM client

Use the following steps to configure the usage of NIM reserved ports between the NIM master and a specific client:

- ▶ Enter the `smitty nim_chmac fastpath` in the NIM master.
- ▶ Select the NIM client in which you want to configure the usage of NIM reserved ports.
- ▶ Select **yes** for the option NFS Client Reserved Ports.

In Example 5-23 we see the SMIT panel used to set NFS client reserved ports values.

*Example 5-23 Setting NFS client reserved ports values*

---

|                                  |             |   |
|----------------------------------|-------------|---|
| Machine Name                     | [VLPAR3_p5] |   |
| * Hardware Platform Type         | [chrp]      | + |
| * Kernel to use for Network Boot | [mp]        | + |

|                                       |                        |    |
|---------------------------------------|------------------------|----|
| Machine Type                          | standalone             |    |
| Network Install Machine State         | currently running      |    |
| Network Install Control State         | ready for a NIM opera> |    |
| Primary Network Install Interface     |                        |    |
| Network Name                          | ent-Network2           |    |
| Host Name                             | [v1par3_p5]            |    |
| Network Adapter Hardware Address      | [0]                    |    |
| Network Adapter Logical Device Name   | [ent]                  |    |
| Cable Type                            | bnc                    | +  |
| Network Speed Setting                 | []                     | +  |
| Network Duplex Setting                | []                     | +  |
| IPL ROM Emulation Device              | []                     | +/ |
| CPU Id                                | [00CC544E4C00]         |    |
| Communication Protocol used by client | [shell]                | +  |
| <b>NFS Client Reserved Ports</b>      | <b>[yes]</b>           | +  |
| Comments                              | []                     |    |
| Force                                 | no                     | +  |

---

Use the `lsnim` command to verify that the `nfs_reserved_port` value is set to `yes` for a NIM client in the NIM master database as shown in Example 5-24.

*Example 5-24 Checking NFS reserved ports values*

---

```
(root@lpar2):/ # lsnim -l VLPAR3_p5
VLPAR3_p5:
class = machines
type = standalone
connect = shell
platform = chrp
netboot_kernel = mp
if1 = ent-Network2 v1par3_p5 0
cable_type1 = bnc
Cstate = ready for a NIM operation
prev_state = ready for a NIM operation
Mstate = currently running
cpuid = 00CC544E4C00
nfs_reserved_port = yes
```

---

**Note:** You can use various combinations for NFS reserved ports; for example:

- ▶ You can have NFS reserved ports enabled for your NIM environment, and select NIM clients using non-reserved ports.
- ▶ Also, you can have NFS reserved ports disabled for the NIM environment, and select clients using reserved ports for the NFS communication.

## Enabling NFS reserved ports on a NIM client already installed

If the NIM client is installed *prior* to setting usage of NFS reserved ports, then you must execute some changes in order to have the client start using reserved ports for NFS operations. You must recreate the `/etc/niminfo` file to reflect the changes on the NIM master regarding usage of NFS reserved ports.

You can recreate the `/etc/niminfo` file by using one of the following methods:

- ▶ You can rebuild the file from the NIM master.
- ▶ You can rebuild the file from the NIM client.

We describe each method in the following sections.

### ***Rebuilding the NIM client /etc/niminfo file from the NIM master***

To rebuild the NIM client `/etc/niminfo` file from the NIM master, follow these steps.

1. Type the `smitty nim_switch_master fastpath` on the NIM master.
2. Select the Machine Name for the NIM client in which you want to rebuild the `/etc/niminfo` file.
3. Select the **Host Name of Network Install Master** using the same host name as the actual one.

In Example 5-25 we show the SMIT panel used to rebuild the `/etc/niminfo` file on the NIM client named `VLPAR3_p5` from the NIM master `lpar2`, introducing the Host Name `lpar2` for the value of Host Name of Network Install Master.

*Example 5-25 Rebuilding the NIM client /etc/niminfo file from the NIM master*

---

|                                            |                |
|--------------------------------------------|----------------|
| Machine Name                               | [VLPAR3_p5]    |
| <b>Host Name of Network Install Master</b> | <b>[lpar2]</b> |
| Force                                      | no +           |

---

In Example 5-26, we can see that the `/etc/niminfo` file on the NIM client has been updated with the changes regarding usage of NFS reserved ports. A new variable is added to the file. The variable is called `NFS_RESERVED_PORT`, and the value for this variable is `yes`, because usage of NFS reserved ports is enabled on the NIM master.

*Example 5-26 New /etc/niminfo file*

---

```
cat /etc/niminfo
#----- Network Install Manager -----
warning - this file contains NIM configuration information
and should only be updated by NIM
export NIM_NAME=VLPAR3_p5
export NIM_HOSTNAME=v1par3_p5
export NIM_CONFIGURATION=standalone
```

```

export NIM_MASTER_HOSTNAME=1par2
export NIM_MASTER_PORT=1058
export NIM_REGISTRATION_PORT=1059
export NIM_SHELL="shell"
export NIM_BOS_IMAGE=/SPOT/usr/sys/inst.images/installp/ppc/bos
export NIM_BOS_FORMAT=rte
export NIM_HOSTS=" 10.1.1.70:v1par3_p5 10.1.1.22:1par2 "
export NIM_MOUNTS=""
export NFS_RESERVED_PORT=yes
export ROUTES=" default:0:10.1.1.1 "

```

---

### ***Rebuilding the NIM client /etc/niminfo file from the NIM client***

To rebuild the NIM client /etc/niminfo file from the NIM client proceed, as follows:

- ▶ Rename the /etc/niminfo file to another name (you also can delete it, but renaming it allows you to keep a copy if you should need it for some reason).
- ▶ Enter the `smitty nimit` fastpath on the NIM client.
- ▶ Select the **Machine Name**. This is the name of the client on the NIM master. This name is already defined on the NIM master, because this client is already registered on the NIM master.
- ▶ Select the **Primary Network Install Interface** for the NIM client.
- ▶ Select the **Host Name of Network Install Master**. This is the NIM master that you are already using.

Example 5-27 shows the SMIT panel used to rebuild the /etc/niminfo on the NIM client in the preceding scenario. The /etc/niminfo file is rebuilt on the NIM client VLPAR3\_p5, from the NIM master 1par2.

*Example 5-27 Rebuilding the NIM client /etc/niminfo file from the NIM client*

---

|                                                                                                   |                    |   |
|---------------------------------------------------------------------------------------------------|--------------------|---|
| * <b>Machine Name</b>                                                                             | <b>[VLPAR3_p5]</b> |   |
| * Primary Network Install Interface                                                               | [en0]              | + |
| * <b>Host Name of Network Install Master</b>                                                      | <b>[1par2]</b>     |   |
| Hardware Platform Type                                                                            | chrp               |   |
| Kernel to use for Network Boot                                                                    | [mp]               | + |
| Communication Protocol used by client                                                             | []                 | + |
| Ethernet Interface Options                                                                        |                    |   |
| Network Speed Setting                                                                             | []                 | + |
| Network Duplex Setting                                                                            | []                 | + |
| Comments                                                                                          | []                 |   |
| Alternate Port Numbers for Network Communications<br>(reserved values will be used if left blank) |                    |   |
| Client Registration                                                                               | []                 | # |
| Client Communications                                                                             | []                 | # |

---



**Note:** The changes performed regarding usage of NFS reserved ports, for example enabling or disabling usage of NFS reserved ports, must be reflected to the NIM client by rebuilding the `/etc/niminfo` file.

## Disabling use of NFS reserved ports

The following sections show how to disable the usage of NFS reserved ports.

### *Disabling use of NFS reserved ports for the NIM environment*

Follow these steps to disable the usage of NFS reserved ports for the entire NIM environment.

1. On the NIM master, execute the `nim` command by using the `change` operation to change the `nfs_reserved_port` attribute to `no` for the NIM machine object corresponding to the NIM master, as shown in Example 5-28. In the example, `master` is the name of the NIM machine object for the NIM master.
2. Rebuild the `/etc/niminfo` file on the NIM clients. For information about how to rebuild the `/etc/niminfo` file on the NIM client, refer to “Rebuilding the NIM client `/etc/niminfo` file from the NIM master” on page 445 or “Rebuilding the NIM client `/etc/niminfo` file from the NIM client” on page 446.

*Example 5-28 Disabling usage of NFS reserved ports on the NIM environment*

---

```
(root@lpar2):/ # nim -o change -a nfs_reserved_port=no master
(root@lpar2):/ #
```

---

### *Disabling use of NFS reserved ports for a particular NIM client*

Follow these steps to disable the use of NFS reserved ports for a particular NIM client.

1. On the NIM master, execute the `nim` command using the `change` operation to change the `nfs_reserved_port` attribute to `no` for the NIM machine object corresponding to the NIM client on which you are disabling the usage of NFS reserved ports, as shown in Example 5-29. In the example, `VLPAR3_p5` is the name of the NIM machine object for the NIM client.

2. Rebuild the `/etc/niminfo` file on the NIM clients.

For information about how to rebuild the `/etc/niminfo` file on the NIM client, refer to “Rebuilding the NIM client `/etc/niminfo` file from the NIM master” on page 445 or “Rebuilding the NIM client `/etc/niminfo` file from the NIM client” on page 446.

*Example 5-29 Disabling use of NFS reserved ports for a particular NIM client*

---

```
(root@lpar2):/ # nim -o change -a nfs_reserved_port=no VLPAR3_p5
```

```
(root@lpar2):/ #
```

---

**Note:** If the `nfso` server `portcheck` option is enabled—and after disabling the use of NFS reserved ports the `portcheck` option is no longer required in your environment—then you can disable it by using the `nfso` command as shown in “Disabling the NFS server `portcheck` option (with `nfso`)” on page 449.

### Enabling the NFS server `portcheck` option (with `nfso`)

This option provides a convenient way for users to enable the port-checking that is done by the NFS server. When the `nfso` `portcheck` option is enabled, the NFS server checks whether an NFS request has originated from a privileged port; that is, a reserved port (below 1024). The default value of 0 disables port checking by the NFS server. A value of 1 directs the NFS server to do port checking on the incoming NFS requests.

This option does not have to be configured through NIM if resources are being served from a resource server separate from the NIM master. Use the `nfso` command as shown in Example 5-30 to enable this value on the resource server if the resources are being served from a resource server separate from the NIM master.

#### *Example 5-30 Setting `portcheck` through the `nfso` command*

---

```
(root@lpar2):/ # nfso -o portcheck=1
Setting portcheck to 1
```

---

Allowing port-check enablement adds the `nfso` server option `portcheck` with a value of 1 to the NIM master. This can be checked by using the `nfso` command, as shown in Example 5-31.

#### *Example 5-31 Checking `portcheck` enablement with the `nfso` command*

---

```
(root@lpar2):/ # nfso -o portcheck
portcheck = 1
```

---

To enable the use of the `nfso` server `portcheck` option, follow these steps:

1. Enter the `smitty nim_global_nfs fastpath` in the NIM master.
2. Select **yes** as the value for the option Allow NIM to enable port-checking on NIM master?.

In Example 5-32 on page 449, we see the SMIT panel used to enable the `nfso` server `portcheck` option.

### Example 5-32 Enabling nfsd server portcheck option

#### Manage NFS Client Communication

Type or select values in entry fields.  
Press Enter AFTER making all desired changes.

```
[Entry Fields]
* Enable/Disable Global Usage of NFS Reserved Ports? [enable] +
* Allow NIM to enable port-checking on NIM master? [no] +
```

```
F1=Help F2=Refresh F3=Cancel F4=List
F5=Reset F6=Command F7=Edit F8=Image
F9=Shell F10=Exit Enter=Do
```

**Note:** If you enable the `nfsd` server `portcheck` option, then the NIM clients configured not to use NFS reserved ports fail to perform NIM operations involving NFS traffic. The error displayed is similar to the one shown in Figure 5-3.

```
Software to Install

Move cursor to desired item and press F7. Use arrow keys to scroll.
ONE OR MORE items can be selected.
Press Enter AFTER making all selections.

■ warning: 0042-175 c_showres: An unexpected result was returned by the
"/usr/sbin/mount" command:

mount: giving up on:
 lpar2:/exports/lpp
vmount: Permission denied
rc=175
0042-175 c_showres: An unexpected result was returned by the "/usr/sbi
mount: giving up on:
 lpar2:/exports/lpp
vmount: Permission denied
```

Figure 5-3 NFS operation error

### Disabling the NFS server portcheck option (with nfsd)

Use the `nfsd` command on the NIM master to disable the `portcheck` option. Example 5-33 on page 450 shows how to use the `nfsd` command to disable the `portcheck` option.

```
(root@lpar2):/ # nfsd -o portcheck=0
Setting portcheck to 0
```

---

### 5.3.10 Firewall considerations

NIM makes use of several protocols that are generally considered risky services on firewall machines. It is recommended that users who desire firewall protection within their NIM environment follow these rules:

- ▶ The NFS program usually runs at port 2049, which is outside the privileged port space. Normally, access to port mapper (port 111) is needed to find which port this service runs on, but because most installations run NFS on this port, hackers can bypass NFS and try this port directly.

NFS was designed as a LAN service and contains numerous security vulnerabilities when used over the Internet. NFS services should not be run on firewall machines; if a NIM master resides on a firewall machine, then resources should reside on another client because clients may also be used as resource servers in a NIM environment (refer to 4.3.1, “Configuring a resource server” on page 144 for more information about this topic).

- ▶ If possible, TFTP servers should not be placed on firewall machines because no authentication is needed when requesting service. The TFTP protocol does allow for denying access based on entries contained in `/etc/tftpaccess.ctl`. NIM manages access to files in `/tftpboot` only, so all other directory locations should be off limits. When managed properly, TFTP access can be viewed as acceptable in the NIM environment.
- ▶ Because rsh is the standard method of client control, clients participating in the NIM environment must allow shell service (514), enable NIMSH for client communication, or enable Kerberos in the NIM environment per client. In order to reduce the amount of open ports in the NIM environment, the following rules may be applied:
  - For every NIM communication using rsh, leave five (5) ports open starting at 1023 and decremented from there. So if a client is communicating in the NIM environment, the client should leave open ports (1023-1019) and the master should leave open ports (1023-1019). Note that this is an estimate and may not work in all environments, because other services may call `rresvport()` prior to, or during, NIM operations. When monitored, this approach should work fine in small environments because access to ports in the privileged space are restricted to super-user access only.
  - Users may also add secondary interfaces for each client participating in the NIM environment. The additional interfaces should be packet-filtered.

When NIM clients no longer participate in the NIM environment, or are temporarily removed from the NIM environment, users should disable rsh services on client machines by removing `~/rhosts` or removing `rsd` service.

## 5.4 Cloning NIM clients using `mksysb`

This section describes how to clone a client using an existing `mksysb` image and Network Installation Manager (NIM) procedures.

### 5.4.1 Using a `mksysb` image to clone NIM Client

An *mksysb image* is a backup of the operating system (that is, the root volume group). This backup can be used to reinstall a system to its original state, if needed. It also can be used to clone the machine from which the `mksysb` image has been taken to another machine.

Another usage of this image may be to customize your environment, creating an installable image of AIX 5L or AIX 4.3 containing the customizations and products that best fit your requirements and using it to install the clients. However, the target systems might not contain the same hardware devices or adapters, or require the same kernel (uniprocessor or multiprocessor).

These procedures are intended to be used to clone NIM clients. For information about how to back up and restore a NIM master, refer to 5.10, “Backing up and reinstalling a NIM master” on page 537.

Because NIM configures TCP/IP at the end of an installation, it is recommended that a `bosinst_data` resource be allocated for cloning `mksysb` installations with the `RECOVER_DEVICES` field set to `no`. This will prevent the BOS installation process from attempting to reconfigure the devices as they were on the source `mksysb` image.

**Note:** Starting in AIX 5L V5.2, devices are not recovered if the `mksysb` image that is being installed was not created on the same system.

**Important:** If the system you have cloned is using OpenGL or graPHIGS, there may be some device filesets from these LPPs that must be installed after a clone. OpenGL and graPHIGS have graphics adapter-specific filesets, so if you cloned onto a system with a different graphics adapter, you will need to create a bundle as follows:

```
echo OpenGL.OpenGL_X.dev > \
/usr/sys/inst.data/user_bundles/graphic_dev.bnd

echo PEX_PHIGS.dev >>
/usr/sys/inst.data/user_bundles/graphic_dev.bnd
```

You can allocate this bundle when you install the mksysb, and the device filesets will be installed automatically if OpenGL and graPHIGS are in your lpp\_source.

## 5.4.2 Prerequisites

In order to restore an mksysb image using NIM, the following prerequisites must be met:

- ▶ The NIM master must be configured, and SPOT and mksysb resources must be defined.
- ▶ The NIM client to be installed must already exist in the NIM environment.
- ▶ The mksysb must be available on the hard disk of the NIM master or a running NIM client, or the mksysb image is created during this procedure from either the NIM master or a running NIM client.
- ▶ The SPOT and mksysb resources should be at the same level of AIX when used for NIM BOS installations.
- ▶ Many applications, particularly databases, maintain data in sparse files. A sparse file is one with empty space, or gaps, left open for the future addition of data. If the empty spaces are filled with the ASCII null character and the spaces are large enough, the file will be sparse, and disk blocks will not be allocated to it.

This situation creates an exposure in that a large file will be created, but the disk blocks will not be allocated. As data is then added to the file, the disk blocks will be allocated, but there may not be enough free disk blocks in the file system. The file system can become full, and writes to any file in the file system will fail. It is recommended that you either have no sparse files on your system, or that you ensure you have enough free space in the file system for future allocation of the blocks.

- ▶ If you are cloning machines that have different hardware, you need to have a LPP\_SOURCE in order to be able to install the additional filesets to support the new hardware (support for the new hardware (device filesets) might not be available in the mksysb image).

### 5.4.3 mksysb image installation on a NIM Client

There are three ways to perform the tasks required to install a mksysb image on a NIM client:

- ▶ Web-Based System Management
- ▶ SMIT
- ▶ Command line

In this section, we use SMIT to perform the tasks. For information about how to perform these tasks using Web-Based System Management or the command line, refer to *AIX 5L V5.3 Installation and Migration*, SC23-4887.

At this point, we assume that the NIM master has been configured, a SPOT resource has been defined, and that the NIM client to be installed already exists in the NIM environment. For this example we use a NIM master (and resource server) named “master”, and a client named VLPAR3\_p5. The mksysb image does not exist as a resource on the NIM master; it is created when the mksysb resource is defined.

### 5.4.4 Mksysb resource creation

The first step is to create a mksysb resource. The following procedure lead us to accomplish the task:

1. Enter the `smitty nim_mkres fastpath`.
2. Select **mksysb** from the list of resource types that can be defined.
3. In the displayed dialogs, supply the values for the required fields. Use the help information and the LIST option to help you specify the correct values for defining your mksysb resource. The option **CREATE system backup image?** has been set to yes in order to create a system image.

Example 5-34 shows the input values for the creation of the mksysb resource in our environment.

#### *Example 5-34 Mksysb resource creation*

---

```
* Resource Name [MKSYSB_VLPAR5_p5]
* Resource Type mksysb
* Server of Resource [master] +
* Location of Resource [/mksysb/VLPAR5] /
```

```

Comments []
Source for Replication [] +
 -OR-
System Backup Image Creation Options:
 CREATE system backup image? yes +
 NIM CLIENT to backup [VLPAR3_p5] +
 PREVIEW only? no +
 IGNORE space requirements? no +
 EXPAND /tmp if needed? yes +
 Create MAP files? no +
 Backup extended attributes? yes +
 Number of BLOCKS to write in a single output [] #
 (leave blank to use system default)
 Use local EXCLUDE file? no +
 (specify no to include all files in backup)
 -OR-
 EXCLUDE_FILES resource [] +
 (leave blank to include all files in backup)

```

---

**Tip:** To preview the operation, select **yes** for the option PREVIEW only?.

**Note:** If the mksysb image already exists as a file on the hard disk of the NIM master or client, no additional information is needed to define your mksysb resource.

Example 5-35 shows the output for the creation of the mksysb resource. In this case, the output includes the output for the creation of the mksysb because we choose to create the mksysb at the moment of creation of the mksysb resource.

*Example 5-35 Output of the mksysb resource creation*

```

-----+
 System Backup Image Space Information
 (Sizes are displayed in 1024-byte blocks.)
+-----+

Required = 730240 (713 MB) Available = 2096504 (2047 MB)

```

Data compression will be used by the system backup utilities which create the system backup image. This may reduce the required space by up to 50 percent.



```
Creating information file (/image.data) for rootvg...
```

```
Creating list of files to back up .
Backing up 23634 files.....
16016 of 23634 files backed up (67%).....
23634 of 23634 files backed up (100%)
0512-038 savevg: Backup Completed Successfully.
```

---

## 5.4.5 Correlating mksysb and SPOT resources

A SPOT resource must be allocated to the client to restore the mksysb. Note that mksysb and SPOT resources must be at the same level. The level of the SPOT NIM resource can be checked using the `nim` command, giving the SPOT resource name to the command with the options shown in Example 5-36.

### *Example 5-36 Checking SPOT level*

---

```
{nimmast}:/etc # nim -o fix_query SPOT_53_ML4 | grep ML
All filesets for 5300-02_AIX_ML were found.
All filesets for 5.3.0.0_AIX_ML were found.
All filesets for 5300-01_AIX_ML were found.
All filesets for 5300-03_AIX_ML were found.
All filesets for 5300-04_AIX_ML were found.
```

---

The `lsnim` command can also be used to check the SPOT level as shown in Example 5-37. The `oslevel_r` attribute shows the SPOT level.

### *Example 5-37 Checking SPOT level using the lsnim command*

---

```
{nimmast}:/ # lsnim -l SPOT_53_ML4
SPOT_53_ML4:
class = resources
type = spot
plat_defined = chrp
arch = power
bos_license = yes
Rstate = ready for use
prev_state = ready for use
location = /AIX53ML4/SPOT_53_ML4/usr/SPOT_53_ML4/usr
version = 5
release = 3
mod = 0
oslevel_r = 5300-04
alloc_count = 0
server = master
if_supported = chrp.mp ent
Rstate_result = success
```

---

The level of the mksysb can be checked using the `nim` command with the options shown in Example 5-38 on the value of `oslevel_r`.

*Example 5-38 Checking the mksysb level*

---

```
{nimmast}:/etc # lsnim -l MKSYSB_VLPAR5_p5
MKSYSB_VLPAR5_p5:
 class = resources
 type = mksysb
 arch = power
 Rstate = ready for use
 prev_state = unavailable for use
 location = /mksysb/VLPAR5
 version = 5
 release = 3
 mod = 0
 oslevel_r = 5300-04
 alloc_count = 0
 server = master
 extracted_spot = SPOT_PRUEBA
```

---

## 5.4.6 SPOT creation from an existing mksysb

There are several reasons why there may be differences between an SPOT and a mksysb resource. For instance, the mksysb may have been taken from another machine which is not in the NIM environment, or the machine from which the mksysb was taken may have been updated without updating the SPOT. For such cases, you need to create an SPOT from an existing mksysb.

Follow these steps to create a SPOT starting from an existing mksysb:

1. Enter `smitty nim_mkres` on the NIM master.
2. Select **SPOT** as the Resource Type.
3. Enter the values required to define the resource. For the value Source of Install Images, select the mksysb resource that you want to use to create the SPOT.

Example 5-39 shows the `smitty` options used to create an SPOT using a mksysb NIM resource as the source for the creation.

*Example 5-39 SPOT creation from a mksysb*

---

```
* Resource Name [SPOT_VLPAR_p5]
* Resource Type spot
* Server of Resource [master] +
* Source of Install Images [MKSYSB_VLPAR5] +
* Location of Resource [/export/spot] /
```

|                                           |                          |
|-------------------------------------------|--------------------------|
| Expand file systems if space needed?      | yes +                    |
| Comments                                  | <input type="checkbox"/> |
| installp Flags                            |                          |
| COMMIT software updates?                  | no +                     |
| SAVE replaced files?                      | yes +                    |
| AUTOMATICALLY install requisite software? | yes +                    |
| OVERWRITE same or newer versions?         | no +                     |
| VERIFY install and check file sizes?      | no +                     |

---

### 5.4.7 mkysyb installation

After you create the mkysyb resource and take a mkysyb image, you can to restore the mkysyb in another machine (or in the same machine). To restore the mkysyb, follow these steps:

1. Enter the `smit nim_bosinst fast path`.
2. Select a TARGET for the operation. This is the partition where the restoring of the mkysyb takes place.
3. Select **mkysyb** as the installation TYPE.
4. Select the MKSYSB to use for the installation.
5. Select the SPOT to use for the installation.
6. In the displayed dialog fields, supply the correct values for the installation options or accept the default values. You can use the help information or the LIST option for assistance.
7. Run the SMIT dialog to install the NIM client.

If the client machine being installed is not already a running configured NIM client, NIM will not automatically reboot the machine over the network for installation. If that is the case, supply the `boot_client=no` attribute to the `bos_inst` command. If the `boot_client` attribute value is not specified, it defaults to `boot_client=yes`.

If the client was not rebooted automatically from SMIT, initiate a network boot from the client to install it. Example 5-40 shows the SMIT panel and values to restore the mkysyb.

*Example 5-40 Restoring the mkysyb*

---

|                       |                            |
|-----------------------|----------------------------|
| * Installation Target | VLPAR3_p5                  |
| * Installation TYPE   | mkysyb                     |
| * SPOT                | SPOT_53_ML4                |
| LPP_SOURCE            | <input type="checkbox"/> + |
| MKSYSB                | MKSYSB_VLPAR5_p5           |

|                                                                              |                                  |
|------------------------------------------------------------------------------|----------------------------------|
| BOSINST_DATA to use during installation                                      | <input type="checkbox"/> +       |
| IMAGE_DATA to use during installation                                        | <input type="checkbox"/> +       |
| RESOLV_CONF to use for network configuration                                 | <input type="checkbox"/> +       |
| Customization SCRIPT to run after installation                               | <input type="checkbox"/> +       |
| Customization FB Script to run at first reboot                               | <input type="checkbox"/> +       |
| ACCEPT new license agreements?                                               | <input type="checkbox"/> [no] +  |
| Remain NIM client after install?                                             | <input type="checkbox"/> [yes] + |
| PRESERVE NIM definitions for resources on<br>this target?                    | <input type="checkbox"/> [yes] + |
| <br>                                                                         |                                  |
| FORCE PUSH the installation?                                                 | <input type="checkbox"/> [no] +  |
| <br>                                                                         |                                  |
| Initiate reboot and installation now?                                        | <input type="checkbox"/> [yes] + |
| -OR-                                                                         |                                  |
| Set bootlist for installation at the<br>next reboot?                         | <input type="checkbox"/> [no] +  |
| <br>                                                                         |                                  |
| Additional BUNDLES to install                                                | <input type="checkbox"/> +       |
| -OR-                                                                         |                                  |
| Additional FILESETS to install<br>(bundles will be ignored)                  | <input type="checkbox"/> +       |
| <br>                                                                         |                                  |
| installp Flags                                                               |                                  |
| COMMIT software updates?                                                     | <input type="checkbox"/> [yes] + |
| SAVE replaced files?                                                         | <input type="checkbox"/> [no] +  |
| AUTOMATICALLY install requisite software?                                    | <input type="checkbox"/> [yes] + |
| EXTEND filesystems if space needed?                                          | <input type="checkbox"/> [yes] + |
| OVERWRITE same or newer versions?                                            | <input type="checkbox"/> [no] +  |
| VERIFY install and check file sizes?                                         | <input type="checkbox"/> [no] +  |
| ACCEPT new license agreements?<br>(AIX V5 and higher machines and resources) | <input type="checkbox"/> [no] +  |
| Preview new LICENSE agreements?                                              | <input type="checkbox"/> [no] +  |
| <br>                                                                         |                                  |
| Group controls (only valid for group targets):                               |                                  |
| Number of concurrent operations                                              | <input type="checkbox"/> #       |
| Time limit (hours)                                                           | <input type="checkbox"/> #       |
| <br>                                                                         |                                  |
| Schedule a Job                                                               | <input type="checkbox"/> [no] +  |
| YEAR                                                                         | <input type="checkbox"/> #       |
| MONTH                                                                        | <input type="checkbox"/> +#      |
| DAY (1-31)                                                                   | <input type="checkbox"/> +#      |
| HOUR (0-23)                                                                  | <input type="checkbox"/> +#      |
| MINUTES (0-59)                                                               | <input type="checkbox"/> [55] +# |

---

In our scenario, the client where we are restoring the mksysb resets and the restore begins.

**Important:** If the mksysb that you are restoring comes from a different machine than the one on which you are restoring it, there may be some additional software which needs to be installed (for example, device drivers). In that case you need to allocate a LPP\_SOURCE resource to supply the required filesets.

## 5.4.8 Monitoring the mksysb installation

You can monitor the restore process by either opening a console to the machine, or by using NIM commands used on the master. The `lsnim` command provides information about the status of the client.

Example 4-7 shows the output of the `lsnim` command used with different parameters to monitor the restore process.

### Example 5-41 Monitoring mksysb restore

---

```
{nimmast}:/ # lsnim -l VLPAR3_p5
VLPAR3_p5:
 class = machines
 type = standalone
 connect = nimsh
 platform = chrp
 netboot_kernel = mp
 if1 = NET_EN1 VLPAR3_p5 0
 cable_type1 = N/A
 Cstate = Base Operating System installation is being performed
 prev_state = BOS installation has been enabled
 Mstate = in the process of booting
 info = BOS install 16% complete : 12% of mksysb data restored.
 boot = boot
 mksysb = MKSYSB_VLPAR5_p5
 nim_script = nim_script
 spot = SPOT_53_ML4
 cpuid = 00CC544E4C00
 control = master
 Cstate_result = success
```

---

**Tip:** The `lsnim` command flag `-a` can be used to display a particular attribute. This can be used to display only the attribute `info`, as shown in Example 5-42.

Using this into a loop, you can automatically monitor the process.

#### Example 5-42 Displaying the info attribute

---

```
{nimmast}:/ # lsnim -a info VLPAR3_p5
VLPAR3_p5:
info = BOS install 16% complete : 12% of mksysb data restored.
```

---

When the restore process completes, the `lsnim` command displays output similar to Example 5-43. The value for the attribute `Cstate` must be ready for a NIM operation.

#### Example 5-43 Restore process completed

---

```
{nimmast}:/ # lsnim -l VLPAR3_p5
VLPAR3_p5:
class = machines
type = standalone
connect = nimsh
platform = chrp
netboot_kernel = mp
if1 = NET_EN1 VLPAR3_p5 0
cable_type1 = N/A
Cstate = ready for a NIM operation
prev_state = not running
Mstate = currently running
cpuid = 00CC544E4C00
Cstate_result = success
```

---

Also check that there is no link in the `/tftpboot` directory for any of the resources previously assigned to restore the mksysb, and that there is no entry in the file `/etc/bootptab` for the machine where the mksysb is restored.

## 5.5 Using NIM to migrate systems to new hardware

In this section, we briefly discuss how to use the Network Installation Manager (NIM) to move systems to new hardware whether that hardware resides in the same site or in a remote site. By “new hardware”, we mean both moving to similar hardware (for example, from POWER4 to POWER4) and also moving to a different platform (for example, POWER4 to POWER5).

We cover the following topics here:

- ▶ Migrating an LPAR to another managed system using NIM
- ▶ Relocating an LPAR to a remote location via NIM
- ▶ Migrating to new hardware utilizing custom `bosinst.data` and `image.data` files with NIM

## 5.5.1 Migrating the image of an LPAR to another system using NIM

You migrate the image of an LPAR from one managed system to another by using a `mksysb` image to clone a system (see 5.4, “Cloning NIM clients using `mksysb`” on page 451). An example of this would be if your current managed system is a System p 650 (POWER4) and you want to “move” an LPAR from this system to a different LPAR on an IBM System p 595 (POWER5). Using `mksysb` cloning makes this task fairly simple. However, you need to consider the following before proceeding:

- ▶ What version of AIX is the source system running? This is very important because not all versions of AIX will run on newer IBM System p hardware. For example, AIX 5L V5.1 systems will not run on POWER5, so the system must migrate to AIX 5L V5.3 or be migrated using the new **`mksysb migration`** procedure (see 4.5, “NIM `mksysb` migration and `nim_move_up POWER5` tools” on page 205). Verify that your AIX version and target hardware platform are compatible; you can find this information in the AIX release notes:

[http://publib.boulder.ibm.com/infocenter/pseries/v5r3/topic/com.ibm.aix.resources/RELNOTES/5304\\_base\\_relnotes.pdf](http://publib.boulder.ibm.com/infocenter/pseries/v5r3/topic/com.ibm.aix.resources/RELNOTES/5304_base_relnotes.pdf)

- ▶ If the hardware type and configuration of the source and target systems are very different, then you need to ensure that you have all the correct device support in an `lpp_source` with an updated SPOT. For example, migrating a system from a p660 (POWER3™ RS64) to a p595 (POWER5) will require additional device support for the POWER5 hardware.
- ▶ Create a new NIM client machine definition for the target LPAR. This will be used as the target of the `mksysb` cloning.
- ▶ Verify that the new hardware is ready to accept the source system. Before attempting to clone the source image to the new LPAR, first create the new LPAR definition on the target system with all the necessary disk, CPU, memory and adapters (Fibre Channel, SCSI, Ethernet, and so on). Any cabling required for network or storage (FC) connections should also be completed and verified. An IP address should also be assigned for the target LPAR (unless the source system is going to be decommissioned after the move and the target system is going to reuse its IP address).

After the new LPAR definition is ready, perform a NIM `rte` installation of AIX for this LPAR. Performing this step will allow you to verify that the LPAR configuration is valid and that all the necessary adapters, processors, memory, network/storage connectivity and other devices are valid before attempting the move of the source system.

Running `cfgmgr` at this point is also recommended so that if there are any devices that cannot be configured because of missing device filesets, `cfgmgr` will display a message outlining which filesets are required. For information

about moving LPARs via SAN zoning, refer to 5.6, “Using SAN zoning for cloning LPARs” on page 475.

- ▶ Ensure that the microcode on the target system’s adapters, managed system, and HMC are up-to-date before attempting a hardware migration. Ensure that all necessary device support is available.
- ▶ When moving an LPAR to a managed system that is connected to a different HMC, the mksysb cloning operation will recreate the RMC (part of RSCT) access control lists (ACLs, `/var/ct/cfg/ctrmc.acls`). This is done to allow the target LPAR’s HMC to identify and manage the new LPAR. For detailed information about recreating the RMC ACLs, refer to 5.6, “Using SAN zoning for cloning LPARs” on page 475.

A related topic regarding DLPAR and cloning via `alt_disk_install` may arise: after cloning, the `/etc/ct_node_id` file has the same contents as the source LPAR, so RSCT does not detect the LPAR to manage. As a workaround, run the following commands after the first boot of the new LPAR, followed by a reboot:

```
/usr/sbin/rsct/install/bin/uncfgct -n
/usr/sbin/rsct/install/bin/cfgct
```

**Note:** NIM rte installations avoid this issue by creating a unique `/etc/ct_node_id` file.

- ▶ Your NIM master must be configured with the latest level of AIX code, and must include all the necessary device filesets to support the target system. The `lpp_source` must contain the filesets and the corresponding SPOT must be updated; refer to 5.1, “Updating the NIM environment (`lpp_source`, SPOT)” on page 410 for more information about this topic.
  - For example, if you are moving an LPAR from a System p650 to a System p595, it is most likely that the adapter types will be different between the two systems. On your System p650 you may have 6228 Fibre Channel (FC) adapters, but the target system has 5716 FC adapters, requiring a different device driver.

For a smooth hardware migration, you will need to ensure that all device filesets are available in your `lpp_source` to support the 5716 adapter. Otherwise, you may find that some devices will be in an unconfigured state after the move. Or, if your system is booting from the SAN, then you may not be able to perform the cloning operation because it may not be able to detect the SAN-attached disk or it may fail when trying to access the disks.



Starting with AIX 5L V5.2, an `lpp_source` is no longer a prerequisite for a `mksysb` installation; that is, when installing AIX 5L V5.2, by default all device support files are also installed, so installing a `mksysb` from such a system would not require an `lpp_source`. However, when moving a system image to a different hardware platform, we recommend that you allocate an `lpp_source`.

- Also, if the correct disk device support is not available during the `mksysb` cloning, the install may appear to work successfully but when the client boots for the first time it, may fail with LED code 554 (554=The boot device could not be opened or read). This situation may occur when moving a system that boots from a SCSI disk to one that boots from a SAN-attached disk, and the necessary device filesets are not available (or the administrator did not allocate an `lpp_source` for the `mksysb` installation).
- Another possibility you may encounter if you do not have all the required device support in your `lpp_source` and an up-to-date SPOT is when network-booting the client. If the required device support is not on your NIM master for the target system's network adapter (from which you are trying to network-boot), then you will be unable to start the cloning operation because the client will be unable to configure the network boot adapter. You will see LED code 605 (605=Configuration of physical network boot device failed).
- ▶ When moving a system via NIM `mksysb` cloning, it is desirable to check that the source system's devices are not recovered during the cloning operation. Letting a `mksysb` restore to recreate the source system's devices could lead to duplicate IP addresses on your network. Unless the source system is on a different network, you should choose **no** to recovering devices. How you do this depends on how you are moving. For example, if you manually boot the client and enter details in the BOS installation menu, you can select **no** to Recover Devices. If booting automatically, you can use a custom `bosinst.data` file (with `RECOVER_DEVICES = no`).

**Note:** When a `mksysb` image is created, the CPU ID is saved. If you are reinstalling the same system, then the device information is recovered; for example, `RECOVER_DEVICES` is automatically set to `yes`.

If the `mksysb` image is used to install another system, device information is not recovered from the `mksysb` image; for example, `RECOVER_DEVICES = Default (no)`.

## 5.5.2 Relocating the image of an LPAR to a remote location

If you have a requirement to move a NIM client to a remote location, you can use NIM to assist in this task. Using a mksysb image of the remote client will allow you to “move” it to your local site without the need for tapes or relocating the hardware. However, in order for this approach to be successful there must be a high-speed network link between both sites. Then all that is required is to export your NIM master’s mksysb directory (for example, /export/images, with enough free space for the image).

NFS-mount the export from the client, perform a mksysb to the mount, and then install the mksysb image onto the new (target) system, as described in this example:

- ▶ We need to relocate an AIX 5L V5.2 LPAR running on a System p650 (lpar1) from Paris to Montpellier. This is our remote (source) system.
- ▶ The target system is an LPAR on a System p595 (lpar1\_p5). This is our local (target) system. The NIM master (montpnm) is also located at the local site in Montpellier.
- ▶ A high-speed network link exists between the two sites.
- ▶ First, we create a mksysb image of the remote system which will be written to our local NIM master’s mksysb directory via NFS:

```
<remote_server># mount <montpnm>:/export/images /mnt
<remote_server># mksysb -i /mnt/lpar1-mksysb.5205.14Jun2006
```

- ▶ We also perform a **savevg** of the remote system’s data volume group to the mksysb directory. Depending on the size of your data volume group this may not be possible. (For example, a 1 TB volume group backed up over a network via NFS is not the best approach.) We need to check that we have enough free space on NIM master for this backup. Our data volume group was only 5 GB in size, so we shut down all applications on the system before performing the savevg, as follows:

```
<remote_server># savevg -f /mnt/lpar1-datavg.savevg.14Jun2006 datavg
<remote_server># cd / ; umount /mnt
```

- ▶ Now we have a mksysb image and savevg images of our remote system. We can install the mksysb image onto the new p595 LPAR (lpar1\_p5). We restore with RECOVER\_DEVICES set to no. Refer to 5.4, “Cloning NIM clients using mksysb” on page 451 for details about cloning via a mksysb image.

After this step is complete, we can configure lpar1\_p5 with new IP details (gateways, DNS servers, and so on) for the local site and reconfigure devices such disk, adapters and so on. The new site also uses Tivoli Storage Manager for backup, so we install the TSM client and configure it so the new system can be backed up. We also verify that the AIX level is correct

(**oslevel**) and that all the filesets are consistent (**lppchk**). The data volume group is then restored (**restvg**) and verified.

The system is now ready for application testing, and if that is successful, the relocation is complete. Further (site-specific) customization may be required to suit the new environment (for example, mksysb/savevg scripts, hosts file, print queues, security settings, and so on).

If you need to relocate a system but a network link does not exist between the sites, you can try the following alternative (this procedure assumes there are tapes drives, of similar type, available at both sites):

- ▶ Perform a mksysb of the remote system to tape. Send the tape to the destination site.
- ▶ Using a suitable tape drive attached to your NIM master, extract the mksysb image. You will need enough free space in a file system to restore the image.

```
tctl -l /dev/rmt0 rewind
tctl -f /dev/rmt0.1 fsf 3
cd /migrate/restore
dd if=/dev/rmt0.1 of=/migrate/restore/lpar1-dd-mksysb-image-file
```

- ▶ You will now have a mksysb image that you can use with NIM to install onto the target LPAR at the local site. In the following section, we describe how to extract a mksysb from tape.

### 5.5.3 Migrating to new hardware utilizing custom bosinst.data and image.data files

In this section, we investigate a specific example of using a custom bosinst.data and image.data file when migrating to new hardware. For example, the mksysb image comes from a mirrored rootvg and the target server has only one disk allocated for rootvg—or the mksysb image is from the tape media, instead of an image file.

Here we describe how to the NIM environment to resolve these issues. First, we need access to the mksysb image, the bosinst.data, and image.data files. This section explains how to extract the mksysb image from the tape media; customize the bosinst.data and image.data file to suit the new server (target hardware); and then perform a BOS installation.

## Extracting mksysb image file from a tape media

If the mksysb image is on a tape media, we first need to extract the mksysb image from this tape media by following these steps:

1. Determine the tape blocksize.

```
tcopy /dev/rmt0
```

The output of the **tcopy** command is a list of all the files found on the media, along with byte count and the block size used, as shown by the values highlighted in bold in Example 5-44 (this command may take a while to complete).

### *Example 5-44 The tcopy command to determine the tape blocksize*

---

```
tcopy /dev/rmt0
tcopy : Tape File: 1; Records: 1 to 7179 ; size:512
tcopy : Tape File: 1; End of file after :7179 records; 3675648 bytes
tcopy : Tape File: 2; Records: 1 to 2900 ; size:512
tcopy : Tape File: 2; End of file after 2900 records, 76890 bytes
...
```

---

2. Change the blocksize of the tape drive.

```
chdev -l rmt0 -a block_size=512
```

3. Rewind the tape media (/dev/rmt0) to the beginning.

```
tctl -f /dev/rmt0 rewind
```

4. Move the tape forward to the beginning of the fourth tape marker.

```
tctl -f /dev/rmt0.1 fsf 3
```

5. Copy the mksysb image to a directory (for example, copy mksysb of node1 to /export/images directory).

```
dd if=/dev/rmt0.1 of=/export/images/Node1.mksysb ibs=1024 \
obs=1024 conv=sync
```

After the mksysb image is extracted from the tape, we can create the NIM mksysb resource (see Example 5-45).

```
smitty nim_mkres
 Select "mksysb = a mksysb image"
```

### *Example 5-45 Define a NIM mksysb resource*

---

Define a Resource

Type or select values in entry fields.  
Press Enter AFTER making all desired changes.

```

[TOP]
* Resource Name
* Resource Type
* Server of Resource
* Location of Resource
Comment
Source for Replication
-OR-
System Backup Image Creation Options:
CREATE system backup image?
NIM CLIENT to backup
PREVIEW only?
IGNORE space requirements?
[EntryFields]
[MK-NODE1]
mksysb
[master] +
[/export/images/Node1.mksysb> /
[]
[] +
[]
[] +
no +
[] +
no +
no +
no +
[MORE...10]

```

---

## The bosinst.data file

The bosinst.data file contains information for the BOS installation program. For example, the BOS installation program looks for information in the bosinst.data file to find out which target disk to install the rootvg as well as whether to install. It also updates any devices in the target server, and so on.

The BOS installation program looks for the information from the /bosinst.data in the mksysb image. If the BOS installation program cannot obtain all the information that it requires, it will prompt the user to manually specify the information through the console.

The bosinst.data file is usually used in a NIM environment when you need a no-prompt installation. This can be done by prior specification of the bosinst\_data resource. The bosinst.data file should contain all the necessary information needed by the BOS installation program.

There are many parameters in the bosinst.data file. You can find the detailed information in the /usr/lpp/bosinst/bosinst.template.README file. If you need to install a mksysb image to another server (different hardware), the following list highlights important parameters that you must specify.

### ► EXISTING\_SYSTEM\_OVERWRITE

This parameter specifies which disks can be overwritten during the BOS install. This variable is applicable only for a non-prompted overwrite installation.

If the target\_disk\_data stanza has no field values, then the EXISTING\_SYSTEM\_OVERWRITE field is used to determine which disks to install on.

If EXISTING\_SYSTEM\_OVERWRITE is set to 'any', it means that any disk can be used for the install.

If EXISTING\_SYSTEM\_OVERWRITE is set to 'no', it means that only disks that contain no volume group can be used during the install.

If EXISTING\_SYSTEM\_OVERWRITE is set to 'yes', it means that disks which contain the existing root volume group will be used first, and if additional disks are needed, those containing no volume group can be used.

► **RECOVER\_DEVICES**

If this parameter is set to Default, the install process will determine whether you are installing to the same machine or not, based on the CPU ID and LPAR nodeid.

If you are reinstalling a system backup to the same machine, then RECOVER\_DEVICES will be set to yes. Otherwise, it is set to no. This field may also set directly to yes or no.

► **INSTALL\_DEVICES\_AND\_UPDATES**

When installing a mksysb image to a system with a different hardware configuration, you boot from product media in order to obtain any missing device drivers installed, if all devices and kernels were not installed prior to creating the mksysb image. In our case, it is the lpp\_source rather than the product media. In addition, if the product media is a later level of AIX than the mksysb, software in the mksysb image will be updated.

To prevent either of these additional installs from occurring, set this field to 'no'. The default is 'yes'.

**Note:** If none of the new devices are required for disk/boot support, we recommend that you set INSTALL\_DEVICES\_AND\_UPDATES to no. Then manually update the system (after the mksysb is installed) using the correct level if CD media / lpp\_source.

However, if the new devices *are* required by disk/boot support, you need to set INSTALL\_DEVICES\_AND\_UPDATES to yes. Be aware that the devices will be updated if the lpp\_source used during the mksysb installation is of a higher level, and be prepared for that fact.

The ALL\_DEVICES\_KERNELS parameter is not required in this case. Specify ALL\_DEVICES\_KERNELS only if you are performing new system installs (overwrite, preservation, or migration); do *not* specify it for mksysb install.

► **ENABLE\_64BIT\_KERNEL and CREATE\_JFS2\_FS fields**

If the system is model IBM eServer™ p5 or BladeCenter® JS20 or later, the default for ENABLE\_64BIT\_KERNEL and for CREATE\_JFS2\_FS will be yes, otherwise, it will be no.

If either of these fields is set to a value other than Default, that value will be used. If blank, the value Default will be assumed. On any system, JFS2 file systems can be selected with either the 64-bit kernel or the 32-bit kernel.

#### ► **TARGET DISK DATA**

There can be multiple `target_disk_data` stanzas. They define which disks will contain the root volume group. Only one field (PVID, PHYSICAL\_LOCATION, SAN\_DISKID, CONNECTION, LOCATION, SIZE\_MB, HDISKNAME) must be non-null in order for BOS install to choose a disk.

The order of precedence is listed here; you can refer to the `/usr/lpp/bosinst/bosinst.template.README` for more details about the precedence information.

- PVID (Physical Volume ID), then
- PHYSICAL\_LOCATION
- SAN\_DISKID
- CONNECTION(parent attribute//connwhere attribute)
- LOCATION
- SIZE\_MB
- HDISKNAME

If the BOS installation is no-prompt and you leave the `target_disk_stanza` empty, then the BOS installation program will check on the `EXISTING_SYSTEM_OVERWRITE` field.

Now that we have a good understanding of the parameters in the `bosinst.data` file, we can edit this file to suit the target server's environment.

There are two approaches to perform this task: with source server running, or without the source server running:

- If the source server is running, you can edit the `/bosinst.data` file directly from the server. As of AIX 4.3.3 and later versions, the `mksysb` command always updates the `target_disk_data` stanzas in `/bosinst.data` to match the disks currently in the root volume group of the system where the `mksysb` is running.

We need to create a `/save_bosinst.data_file` file to avoid overwriting the edited/customized `/bosinst.data` file during the `mksysb` backup. You can just touch a file with the file name as `save_bosinst.data_file`.

**Note:** Ensure that the edited/customized `/bosinst.data` file is not updated after the `mksysb` command is run.

- If the source server is not running, we can extract the `bosinst.data` file from the `mksysb` image.

In our scenario, we do not have the source server running, only its mksysb image. We extract bosinst.data file from the mksysb image and create a NIM bosinst\_data resource, ready for our NIM operation. We follow these steps:

1. Extract the bosinst.data file from mksysb image file.

Assume we are extracting the bosinst.data file from the /export/images/Node1.mksysb and placing it in /other\_res directory in the NIM master.

```
cd /other_res
restore -xvqf /export/images/Node1.mksysb ./bosinst.data
```

In your case, you can rename this bosinst.data file to bosinst.data.Node1 to denote that this file is used for the Node1. Change the parameter fields shown in step one in the bosinst.data.Node1 file. Then create a NIM bosinst\_data resource:

```
mv bosinst.data bosinst.data.Node1
```

2. Create a NIM bosinst\_data resource; see Example 5-46.

```
smitty nim_mkres
 Select "bosinst_data = config file used during base system
 installation"
```

*Example 5-46 Define NIM bosinst\_data resource*

---

| Define a Resource                             |                                  |
|-----------------------------------------------|----------------------------------|
| Type or select values in entry fields.        |                                  |
| Press Enter AFTER making all desired changes. |                                  |
|                                               | [Entry Fields]                   |
| * Resource Name                               | [BID_NODE1]                      |
| * Resource Type                               | bosinst_data                     |
| * Server of Resource                          | [master] +                       |
| * Location of Resource                        | [/other_res/bosinst.data.Node1>/ |
| Comments                                      | []                               |
| Source for Replication                        | [] +                             |

---

### image.data file

The image.data file contains information required by the BOS installation program. This file describes how physical disks, volumes groups, logical volumes, file systems and paging space should be configured in the root volume group during installation. This file is generated whenever you run a **mksysb -i** or the **mkszfile** command.

In our scenario, we are restoring the mksysb image with a mirrored rootvg to another server that has only one disk for the rootvg. We need to edit the image.data file to change the **LV\_SOURCE\_DISK\_LIST**, **COPIES** and the **PP**



parameters in order to reflect one copy of rootvg; see Example 5-47. We change the **LV\_SOURCE\_DISK\_LIST**, **COPIES** and the **PP** parameters, as highlighted in the example with an arrow and bold font.

**Note:** Example 5-47 on page 471 shows only the changes on hd2. You need to perform the changes for all the other LVs in the rootvg.

There are two approaches to working on the image.data file: with the source server running, or without the source server running, as explained here:

- ▶ If the source server is still running, you can edit the image.data file in the server, as shown in Example 5-47. Then perform a mksysb without generating a new image.data (mksysb without the -i option). However, you must ensure that the edited/customized image.data file is not overwritten after a **mksysb** command.
- ▶ If the source server is already down and you only have its mksysb image, you can extract the image.data file from the mksysb image.

In our scenario, we do not have the source server running, only its mksysb image. Here are the steps to extract the image.data file from the mksysb image, edit the necessary parameters, and create a NIM image\_data resource that is ready for NIM operation.

1. Extract the image.data file from the mksysb image /export/images/Node1.mksysb, and edit the file.

```
cd /other_res
restore -xvqf /export/images/node1.mksysb ./image.data
```

Rename this image.data file to image.data.Node1 to denote that this file is for target Node1.

```
mv image.data image.data.Node1
```

Edit image.data.Node1 file to be able to restore with one copy of rootvg on the target server, as shown in Example 5-47.

*Example 5-47 Edit image.data.Node1 file to install one copy of rootvg*

---

```
lv_data:
 VOLUME_GROUP= rootvg
===> LV_SOURCE_DISK_LIST= hdisk0 hdisk1 <-- change this
 LV_IDENTIFIER= 00cc544e00004c000000010bec51e388.5
 LOGICAL_VOLUME= hd2
 VG_STAT= active/complete
 TYPE= jfs2
 MAX_LPS= 32512
===> COPIES= 2 <-- change this
 LPS= 70
```

```

STALE_PPs= 0
INTER_POLICY= minimum
INTRA_POLICY= center
MOUNT_POINT= /usr
MIRROR_WRITE_CONSISTENCY= on/ACTIVE
LV_SEPARATE_PV= yes
PERMISSION= read/write
LV_STATE= opened/syncd
WRITE_VERIFY= off
PP_SIZE= 8
SCHED_POLICY= parallel
====> PP= 140 <-- change this
BB_POLICY= relocatable
RELOCATABLE= yes
UPPER_BOUND= 32
LABEL= /usr
MAPFILE=
LV_MIN_LPS= 83
STRIPE_WIDTH=
STRIPE_SIZE=
SERIALIZE_IO= no
FS_TAG=

```

---

To verify the changes on the image.data.Node1 file, refer to Example 5-48.

*Example 5-48 Updated image.data.Node1 file*

---

```

lv_data:
VOLUME_GROUP= rootvg
====> LV_SOURCE_DISK_LIST= hdisk0
LV_IDENTIFIER= 00cc544e00004c000000010bec51e388.5
LOGICAL_VOLUME= hd2
VG_STAT= active/complete
TYPE= jfs2
MAX_LPS= 32512
====> COPIES= 1
LPS= 70
STALE_PPs= 0
INTER_POLICY= minimum
INTRA_POLICY= center
MOUNT_POINT= /usr
MIRROR_WRITE_CONSISTENCY= on/ACTIVE
LV_SEPARATE_PV= yes
PERMISSION= read/write
LV_STATE= opened/syncd
WRITE_VERIFY= off
PP_SIZE= 8
SCHED_POLICY= parallel
====> PP= 70

```

```

BB_POLICY= relocatable
RELOCATABLE= yes
UPPER_BOUND= 32
LABEL= /usr
MAPFILE=
LV_MIN_LPS= 83
STRIPE_WIDTH=
STRIPE_SIZE=
SERIALIZE_IO= no
FS_TAG=

```

---

## 2. Create a NIM image\_data resource.

After changing the parameters in the image.data.Node1 file, create a NIM image\_data resource as shown in Example 5-49.

```

smitty nim_mkres
 Select "image_data = config file used during base system
 installation"

```

### Example 5-49 Define NIM image\_data resource

---

```

 Define a Resource
Type or select values in entry fields.
Press Enter AFTER making all desired changes.

 [Entry Fields]
* Resource Name [ID_NODE1]
* Resource Type image_data
* Server of Resource [master] +
* Location of Resource /other_res/image.data.Node1>/
Comments []
Source for Replication [] +

```

---

## Performing BOS installation

After we have the mksysb, bosinst\_data and image\_data resources defined in our NIM master, we need to define a NIM client machine to our NIM master. With all these in place, we can start the BOS installation on the target server.

There are certain considerations to take care of when executing a “push” installation with the no-prompt option. If the target server is not already a NIM client defined to the NIM master, we need to assign the /etc/niminfo file to the target server so that this server knows who the NIM master is. Otherwise, we will need to perform a push installation with a Force option.

**Note:** In order to perform either action, the target server must be contactable through remote shell, so include the NIM master hostname in the target server's `~/.rhosts` file.

1. Assign the `/etc/niminfo` file to the target server.

After the NIM client machine has been defined in the NIM master, we assign the `/etc/niminfo` file to the target server by specifying a new master to the client machine. Follow the `smit` steps.

```
smitty nim_mac
Specify New Master for Client Machine
Select the NIM client machine
```

Or use the SMIT `smitty nim_switch_master` fast path, as shown in Example 5-50.

*Example 5-50 Specify a NIM master for a client machine*

---

Specify New Master for Client Machine

Type or select values in entry fields.

Press Enter AFTER making all desired changes.

|                                     |                |
|-------------------------------------|----------------|
|                                     | [Entry Fields] |
| Machine Name                        | [NODE1]        |
| Host Name of Network Install Master | [nimmast]      |
| Force                               | no             |

---

2. Forcing a NIM push installation.

After allocating the necessary NIM resources (`smitty nim_mac_res`), perform the SMIT steps to enable a NIM push installation with a Force option. This operation will update the `/etc/niminfo` file to the target server.

```
smitty nim_mac_op
Select the NIM client
Select "bos_inst = perform a BOS installation"
Change the "Source for BOS runtimes file" to mksysb;
"Force Unattended Installation Enablement?" to yes
"ACCEPT new license agreements?" to yes
```

See Example 5-51.

*Example 5-51 Perform NIM PUSH installation with a Force option*

---

Perform a Network Install

Type or select values in entry fields.

Press Enter AFTER making all desired changes.

|                                                  |                 |
|--------------------------------------------------|-----------------|
|                                                  | [EntryFields]   |
| Target Name                                      | NODE1           |
| <b>Source for BOS Runtime Files</b>              | <b>mksysb +</b> |
| installp Flags                                   | [-agX]          |
| Fileset Names                                    | []              |
| Remain NIM client after install?                 | yes +           |
| <b>Initiate Boot Operation on Client?</b>        | <b>yes +</b>    |
| Set Boot List if Boot not Initiated on Client?   | no +            |
| <b>Force Unattended Installation Enablement?</b> | <b>yes +</b>    |
| <b>ACCEPT new license agreements?</b>            | <b>[yes] +</b>  |

---

As an alternative, use the command **smitty nim\_bosinst** to perform the BOS installation. Select the target machine, the mksysb, and the SPOT. Set the option FORCE PUSH the installation? to yes, and set the option ACCEPT new license agreements? to yes.

## 5.6 Using SAN zoning for cloning LPARs

This procedure is useful if you want to deploy and install AIX onto LPARs in a production environment, but do not want to perform a NIM installation over the production network.

In this case, you can deploy the operating system image via NIM on LPARs in a test environment, then simply move the LUNs from the test environment to the production environment and activate the LPARs in the production environment. This can be achieved via SAN zoning and LUN masking, with minimal changes when you activate the LPARs in the production environment.

To move an LPAR from one physical machine to another, when all disks (including rootvg) are available via SAN, the supported methods are:

- ▶ Reinstall the LPAR from scratch
- ▶ Create an mksysb image from the running LPAR and reinstall it on the target LPAR.

These are also the supported procedures for LPARs running in a Virtual I/O Server (VIOS) environment (even though you can use other means, such as the **dd** command to copy virtual disks between logical volumes in the VIOS).

It is also possible to use SAN zoning to move SAN-based rootvg disks (logical units, or LUs) from one LPAR to another LPAR in another physical machine, assuming both LPARs are connected to the same SAN fabric, and that the operating system level is supported by the destination physical machine.

Both LPARs should be configured with the same type of physical machine, with the same number and type of adapters, and are not restricted to VIOS resources.

The general steps for SAN zoning of an LPAR's rootvg LUNs are:

1. Document
2. Plan
3. Verify
4. Execute

### **Document**

Document the LPAR environment, such as (but not limited to) LPAR profiles, HMCs involved, NIM servers, IP addresses, gateways, DNS servers, NTP servers, and LDAP servers.

### **Plan**

Decide when the zoning can be implemented, who needs to be involved, the exact steps to verify the SAN, LAN and AIX, and define a rollback plan.

### **Verify**

Zone a new rootvg disk to the target LPAR and perform a basic rte installation from NIM to the target LPAR, to make sure all adapters are properly allocated and working with the new IP settings.

### **Execute**

Open the SAN zone for the originating LPAR's SAN disks to the new destination LPAR. Then stop the running LPAR, start the target LPAR, change the IP settings and change the HMC and RSCT settings for the LPAR. After functional verification, remove the originating LPAR from the SAN zone.

**Note:** Depending on your particular changes after a SAN zoning (such as changes to the hostname, node id or IP addresses), consult the IBM product documentation and verify the appropriate command sequence for your specific level of AIX and HMC software. Refer to *Hardware Management Console for pSeries Installation and Operations Guide*, SA38-0590, for more information.

If you change the HMC that manages the physical machine during the SAN zoning, you need also to change the `/var/ct/cfg/ctrmc.acs` file to allow the target LPAR's HMC to manage the new LPAR. When moving an LPAR using mksysb cloning, the HMC connections are recreated.

To determine whether you have this case, use the `lsrsrc` command as shown in Example 5-52.

*Example 5-52 Correct output from the `lsrsrc IBM.ManagementServer` command*

---

```
root@lpar55:/: lsrsrc IBM.ManagementServer
Resource Persistent Attributes for IBM.ManagementServer
resource 1:
 Name = "10.1.1.100"
 Hostname = "10.1.1.100"
 ManagerType = "HMC"
 LocalHostname = "lpar5"
 ClusterTM = "9078-160"
 ClusterSNum = ""
 ActivePeerDomain = ""
 NodeNameList = {"lpar55"}
```

---

Also verify the output from the `ctsth1` command on the originating LPAR as shown in Example 5-53. In this case, verify the output from the default cluster security services trusted host list for the node (`/var/ct/cfg/ct_has.th1`).

*Example 5-53 Output from the `ctsth1` command*

---

```
root@lpar55:/: ctsth1 -l
ctsth1: Contents of trusted host list file:

Host Identity: 10.1.1.100
Identifier Generation Method: rsa512
Identifier Value:
1202009bedb21d54f57dcc2217f46f3b1352a30317e87dac7cb2d593582159e0cab3bc5a3e211b606e2fd94a0552f0c
81d36e33e346bc567810e3dbd8d8e44327ae3110103

Host Identity: loopback
Identifier Generation Method: rsa512
Identifier Value:
120200ca6e9e199d8177b0ede67ec30fb4abaaacb56779decea348bcc7a7ae904485e5f0cc284e2017e3f295a75acb8
038b6332477a8f530ff9240a0fa3f5a9e917c0b0103

Host Identity: 127.0.0.1
Identifier Generation Method: rsa512
Identifier Value:
120200ca6e9e199d8177b0ede67ec30fb4abaaacb56779decea348bcc7a7ae904485e5f0cc284e2017e3f295a75acb8
038b6332477a8f530ff9240a0fa3f5a9e917c0b0103

Host Identity: 10.1.1.55
Identifier Generation Method: rsa512
Identifier Value:
120200ca6e9e199d8177b0ede67ec30fb4abaaacb56779decea348bcc7a7ae904485e5f0cc284e2017e3f295a75acb8
038b6332477a8f530ff9240a0fa3f5a9e917c0b0103
```

```

Host Identity: lpar55
Identifier Generation Method: rsa512
Identifier Value:
120200ca6e9e199d8177b0ede67ec30fb4abaaacb56779decea348bcc7a7ae904485e5f0cc284e2017e3f295a75acb8
038b6332477a8f530ff9240a0fa3f5a9e917c0b010
```

---

After moving the LPAR, the new HMC's IP address in our examples is 10.1.2.100. On the LPAR and on the HMC, the respective node identifier is stored in the `/etc/ct_node_id` file. This identifier is used to grant access from the HMC to the LPAR, specified in the `/var/ct/cfg/ctrmc.acls` file. The `ctrmc.acls` file contains a node's resource monitoring and control (RMC) access control list (ACL).

Example 5-54 shows the `/etc/ct_node_id` file of the current HMC and the destination HMC.

*Example 5-54 ct\_node\_id from HMCs*

---

```
root@lpar55:/: ssh hscroot@10.1.1.100 head -1 /etc/ct_node_id
9b4fc2ff2c7b3fb7
```

```
root@lpar55:/: ssh hscroot@10.1.2.100 head -1 /etc/ct_node_id
c75d71c5f7b9279a
```

---

The `ctskeygen` command is used to update the RMC security files `ct_has.pkf` (public key file), `ct_has.qkf` (private key file), `ct_has.thl` (trusted host list file). Example 5-55 displays the current public key value for the local system.

*Example 5-55 Output from the ctskeygen command*

---

```
root@lpar55:/: /usr/sbin/rsct/bin/ctskeygen -d
120200b6b9979e2d01cb5d97189db870e47af464f9ebb9cbe57f1e1045ed07f83c72e51c1ebbb93a
c642d3c37d5212c8T6hfe83Dbufd3e5f600b65c12f3726ef7c03896107f9f0103
(generation method: rsa512)
```

---

## 5.7 System maintenance for NIM clients

Performing proactive system maintenance for NIM clients is important in order to keep systems stable and up-to-date. System maintenance includes installing software fixes or updates, verifying installed software, reviewing installed software and operating system levels, and performing hardware maintenance and diagnostics. You can use NIM to perform all of these maintenance activities in a very fast and efficient way. You can perform maintenance on a single system



or a group of systems, thus reducing the time and effort required to keep your systems updated.

In this section, we discuss the following topics:

- ▶ Software maintenance approach
- ▶ Creating a mksysb backup of a NIM client
- ▶ Performing software maintenance on NIM clients
- ▶ Booting a NIM client in maintenance and diagnostic mode

## 5.7.1 Software maintenance approach

Software maintenance is an important task for any AIX or NIM administrator. By “software maintenance”, we mean applying AIX PTFs, APARs, Service Packs, Concluding Service Packs (CSPs) and Technology Levels (TLs) on a NIM client. It is generally a good idea to keep your NIM environment running at the latest and most stable release of AIX code. This will ensure that your systems can exploit the latest features and enhancements for AIX. Develop a maintenance strategy that is most appropriate for your environment. IBM introduced a new service strategy for AIX 5L in early 2006. This strategy offers several maintenance models but the one that will meet the needs of most sites is the “maximum stability” model.

### ***Maximum stability maintenance model***

The maximum stability maintenance strategy is designed for sites that would like to adopt a new TL every six to eight months and take advantage of the latest group of PTFs available in a Concluding Service Pack. By this we mean that a system that is currently running TL4 would wait for TL5 and its CSP to be released before applying the software. In between TLs, the site could also install Interim Fixes (IFs) to address security and other issues that may be required before the latest TL and CSP is available. For more information, refer to *AIX 5L Service Strategy and Best Practices: AIX 5L Service Scenarios and Tools*, which is available at the following Web site:

[http://www-03.ibm.com/servers/eserver/support/unixservers/aix\\_service\\_strategy.pdf](http://www-03.ibm.com/servers/eserver/support/unixservers/aix_service_strategy.pdf)

### ***Software maintenance on the NIM master***

Before you can apply maintenance to a NIM client, you must make sure that your NIM master has been updated with the highest level of code. But you must first obtain the software in some form. The latest TLs, SPs and CSPs can be downloaded from the IBM fix central Web site:

<http://www.ibm.com/eserver/support/fixes/fcgui.jsp>

However, we recommend that you use the Service Update Management Assistant (SUMA) in conjunction with NIM to download and manage the latest fixes. Create a new file system to which SUMA can download the TL and CSP filesets. A new lpp\_source should also be created for the new TL/CSP, which initially only contains the base level code. This new lpp\_source will be updated with the fixes downloaded via SUMA (for example, Base+TL+CSP).

Create a new SPOT from the new lpp\_source and update it each time the lpp\_source is updated. Refer to 4.10, “NIM and Service Update Management Assistant” on page 319, for additional information about using NIM and SUMA. For more information about updating software in a NIM environment, refer to 5.1, “Updating the NIM environment (lpp\_source, SPOT)” on page 410.

### ***Using NIM to perform software maintenance on NIM clients***

Prior to applying the latest TL on a NIM client, it is desirable to test the code on a non-critical system. This will allow you to verify the code and refine your installation procedures before applying it to any production system.

The current level of your client can be determined with the `oslevel` command. The `-s` flag shows the current Service Pack level, and the `-r` flag displays the current Technology Level, as shown in Example 5-56.

#### *Example 5-56 Using the oslevel command*

---

```
{nimmast}:/ # rsh lpar4 oslevel -r
5300-04
{nimmast}:/ # rsh lpar4 oslevel -s
5300-04-03
```

---

Always create a mksysb backup of the client before performing any type of software maintenance task. As shown in Example 5-57, you can use NIM to back up the client from the master (or you can use a script that runs on the client to back up to the NIM master).

#### *Example 5-57 Creating a mksysb of a NIM client from the NIM master*

---

```
{nimmast}:/ # nim -o define -t mksysb -a server=master -a source=LPAR4 -a
mk_image=yes -a location=/export/images/mksysb.lpar4.5303.Fri lpa
r4-mksysb
+-----+
 System Backup Image Space Information
 (Sizes are displayed in 1024-byte blocks.)
+-----+

Required = 1072580 (1047 MB) Available = 1691148 (1652 MB)
```

Data compression will be used by the system backup utilities which create the system backup image. This may reduce the required space by up to 50 percent.

Creating information file (/image.data) for rootvg..

Creating list of files to back up.  
Backing up 26669 files.....  
26669 of 26669 files (100%)  
0512-038 savevg: Backup Completed Successfully.

```
{nimmast}:/ # lsnm -t mksysb
lpar1nim-mksysb resources mksysb
MK_LPAR6_AIX530403 resources mksysb
MKSYSB_VI012_53_ML3 resources mksysb
MK_AIX5104 resources mksysb
mksysb_lpar5c resources mksysb
mksysb_lpar5d resources mksysb
mksysb_vlpar1 resources mksysb
MK_VI01 resources mksysb
VLPAR3_phys_mksysb resources mksysb
MK_MST_53ML4 resources mksysb
VLPAR3_p5_mksysb resources mksysb
MK_MST_15JUN06 resources mksysb
MKSYSB_VLPAR5_p5 resources mksysb
lpar4-mksysb resources mksysb

{nimmast}:/ # lsnm -l lpar4-mksysb
lpar4-mksysb:
 class = resources
 type = mksysb
 arch = power
 Rstate = ready for use
 prev_state = unavailable for use
 location = /export/images/mksysb.lpar4.5300.Fri
 version = 5
 release = 3
 mod = 0
 oslevel_r = 5300-03
 alloc_count = 0
 server = master
```

---

You can perform software maintenance tasks on one or more NIM clients concurrently. If you have defined a NIM machine group, you can choose to perform an operation on the machine group and update all the group members (clients) at the same time. Depending on the size and type of your environment,

you may only need to update on a per-client basis, but the flexibility to manage multiple clients exists.

As shown in the following examples, we perform software maintenance on a NIM client via the NIM master. Our task is to apply the latest maintenance to our client. After this is completed our client, which was running AIX 5L V5.3 ML3 (5300-03), will be updated to AIX 5L V5.3 TL4 SP3 (5300-04-03).

We will perform the following tasks:

- ▶ Commit any software in an applied state. There may be software in an applied state from a previous maintenance task.
- ▶ Apply software via a NIM (cust) update\_all operation.
- ▶ LPAR4 is the NIM client.
- ▶ The lpp\_source name is LPP\_53\_ML4.
- ▶ COMMIT software updates? No.
- ▶ SAVE replaced file? Yes.
- ▶ Accept new license agreements? Yes.
- ▶ Verify that the `oslevel` and `instfix` commands display the correct TL and SP information. Verify the filesets installed from the NIM master via the NIM `lppchk` and `showlog` operation. Also perform a `fix_query` NIM operation on the NIM client.

We chose not to commit the software updates or save the replaced files. This will allow us to reject a fileset (or filesets) if there are issues after the update. This is called *applying* software updates. We can choose to *commit* the updates later, which will remove the saved files from the system.

**Important:** Try to avoid rejecting an entire Technology Level after it has been applied to an AIX 5L V5.3 system. TLs are usually quite large in terms of the number of filesets updated. It is faster and less risky to fall back to the previous level using other methods such as `alt_disk_install`, `multiboot`, or a `mksysb` restore via NIM.

As shown in Example 5-58 on page 483, and because we are applying a new TL, we perform a PREVIEW first in order to review what will actually be installed and to check for any missing prerequisites. In most cases when applying a new TL, you will be asked to update the `bos.rte.install` fileset first. All other filesets are deferred until it is updated. After it is updated, you will be able to apply the remaining filesets.

Also, ensure that you have taken a backup of any other data volume groups (non-rootvg volume groups). We recommend that all your applications be shut down and all users logged off the system before you apply any AIX operating system maintenance. Also check the AIX error report before and after to see whether there are any issues (hardware or otherwise) with the system.

It may also be worth cleaning up your old SMIT log files beforehand. This will make reviewing the logs much less confusing after the maintenance has been applied; see Example 5-58.

*Example 5-58 bos.rte.install must be updated first when applying a TL*

---

```
{nimmast}:/ # smit nim_task_maint
Commit Applied Software Updates (Remove Saved Files)
LPAR4 machines standalone

 Commit Applied Software Updates (Remove Saved Files)

* Target LPAR4
* Software Names [all] +

Force no +

PREVIEW only? [no] +
COMMIT requisites? [yes] +

nimmast}:/ # smit nim_task_inst

Update Installed Software to Latest Level (Update All)
LPAR4 machines standalone
LPP_53_ML4 resources lpp_source

Update Installed Software to Latest Level (Update All)

* Installation Target LPAR4
* LPP_SOURCE LPP_53_ML4
 Software to Install update_all

Customization SCRIPT to run after installation [] +
(not applicable to SPOTs)

Force no +

installp Flags
PREVIEW only? [yes] +
COMMIT software updates? [no] +
SAVE replaced files? [yes] +
AUTOMATICALLY install requisite software? [yes] +
EXTEND filesystems if space needed? [yes] +
```

```

OVERWRITE same or newer versions? [no] +
VERIFY install and check file sizes? [no] +
ACCEPT new license agreements? [yes] +
 (AIX V5 and higher machines and resources)
Preview new LICENSE agreements? [no] +

Group controls (only valid for group targets):
 Number of concurrent operations [] #
 Time limit (hours) [] #

Schedule a Job [no] +
YEAR [] #
MONTH [] +#
DAY (1-31) [] +#
HOUR (0-23) [] +#
MINUTES (0-59) [] +#

```

COMMAND STATUS

```

Command: OK stdout: yes stderr: no

```

Before command completion, additional instructions may appear below.

[TOP]

```

installp PREVIEW: installation will not actually occur.

```

```

+-----+
 Pre-installation Verification...
+-----+
Verifying selections...done
Verifying requisites...done
Results...

```

SUCSESSES

```

Filesets listed in this section passed pre-installation verification
and will be installed.

```

**Mandatory Fileset Updates**

```

(being installed automatically due to their importance)
bos.rte.install 5.2.0.41 # LPP Install Commands

```

<< End of Success Section >>

## FILESET STATISTICS

```

41 Selected to be installed, of which:
 1 Passed pre-installation verification
 40 Deferred (see *NOTE below)

```

```
1 Total to be installed
```

[MORE...21]

---

After `bos.rte.install` is updated, we are able to apply TL4 to our NIM client, LPAR4, as shown in Example 5-59.

### Example 5-59 Applying a TL on a NIM client

---

```
{nimmast}:/ # smit nim_task_inst
Update Installed Software to Latest Level (Update All)
LPAR4 machines standalone
LPP_53_ML4 resources lpp_source

Update Installed Software to Latest Level (Update All)

* Installation Target LPAR4
* LPP_SOURCE LPP_53_ML4
Software to Install update_all

Customization SCRIPT to run after installation [] +
 (not applicable to SPOTs)

Force no +

installp Flags
 PREVIEW only? [no] +
 COMMIT software updates? [no] +
 SAVE replaced files? [yes] +
 AUTOMATICALLY install requisite software? [yes]+
 EXTEND filesystems if space needed? [yes]+
 OVERWRITE same or newer versions? [no] +
 VERIFY install and check file sizes? [no] +
 ACCEPT new license agreements? [yes]+
 (AIX V5 and higher machines and resources)
 Preview new LICENSE agreements? [no] +

Group controls (only valid for group targets):
 Number of concurrent operations [] #
 Time limit (hours) [] #

Schedule a Job [no] +
YEAR [] #
```

```

MONTH [] +#
DAY (1-31) [] +#
HOUR (0-23) [] +#
MINUTES (0-59) [] +#

```

---

We verify the installed filesets by running an `lppchk` operation on the NIM client from the NIM master. We also review the `installp` log with the `showlog` operation; see Example 5-60.

*Example 5-60 Running an `lppchk` and `showlog` operation after the TL is applied*

```

{nimmast}:/ # nim -o lppchk -a lppchk_flags="-c -m3" LPAR4
/usr/bin/lppchk: 0504-230 8367 files have been checked.
/usr/bin/lppchk: 0504-230 13186 files have been checked.
/usr/bin/lppchk: 0504-230 14798 files have been checked.
/usr/bin/lppchk: 0504-230 561 files have been checked.
/usr/bin/lppchk: 0504-230 377 files have been checked.

{nimmast}:/ # nim -o showlog -a log_type=niminst LPAR4
BEGIN:Tue Jul 4 21:48:44 2006:070411484406
Command line is:
/usr/sbin/installp -acgXY -e /var/adm/ras/nim.installp -f \
/tmp/.genlib.installp.list.548880-d /tmp/_nim_dir_557166/mnt0
+-----+
Pre-installation Verification...
+-----+
done
.....
SUCSESSES

Filesets listed in this section passed pre-installation verification
and will be installed.

Selected Filesets

Java14.sdk 1.4.2.75 # Java SDK 32-bit
X11.adt.include 5.3.0.50 # AIXwindows Application Devel...
X11.apps.aixterm 5.3.0.50 # AIXwindows aixterm Application
X11.apps.config 5.3.0.50 # AIXwindows Configuration App...
X11.apps.xdm 5.3.0.50 # AIXwindows xdm Application
X11.base.lib 5.3.0.50 # AIXwindows Runtime Libraries
X11.base.rte 5.3.0.50 # AIXwindows Runtime Environment
.....
bos.rte.libpthread 5.3.0.50 USR COMMIT SUCCESS
bos.rte.serv_aid 5.3.0.50 USR COMMIT SUCCESS
bos.rte.serv_aid 5.3.0.50 ROOT COMMIT SUCCESS
rsct.core.utils 2.4.5.2 USR COMMIT SUCCESS
rsct.core.utils 2.4.5.2 ROOT COMMIT SUCCESS

```



|                  |         |      |        |         |
|------------------|---------|------|--------|---------|
| rsct.core.sec    | 2.4.5.1 | USR  | COMMIT | SUCCESS |
| rsct.core.sec    | 2.4.5.1 | ROOT | COMMIT | SUCCESS |
| rsct.core.rmc    | 2.4.5.2 | USR  | COMMIT | SUCCESS |
| rsct.core.rmc    | 2.4.5.2 | ROOT | COMMIT | SUCCESS |
| rsct.core.errm   | 2.4.5.1 | USR  | COMMIT | SUCCESS |
| rsct.core.errm   | 2.4.5.1 | ROOT | COMMIT | SUCCESS |
| rsct.core.hostrm | 2.4.5.1 | USR  | COMMIT | SUCCESS |
| rsct.core.hostrm | 2.4.5.1 | ROOT | COMMIT | SUCCESS |
| rsct.core.gui    | 2.4.5.1 | USR  | COMMIT | SUCCESS |

```
installp: * * * A T T E N T I O N ! ! !
```

```
Software changes processed during this session require this system
and any of its diskless/dataless clients to be rebooted in order
for the changes to be made effective.
```

```
END:Tue Jul 4 22:08:05 2006:070412080506
```

---

Using rsh from the NIM master, we run the **oslevel** and **instfix** commands on the NIM client to verify that the correct AIX level is shown and that all filesets have been updated correctly. We then run a **fix\_query** operation from the master, which is the same as running the **instfix** command on the client, as shown in Example 5-61.

*Example 5-61 oslevel, instfix commands and fix\_query operation*

---

```
{nimmast}:/ # rsh lpar4 instfix -icqk 5300-04_AIX_ML | grep ":-:"
{nimmast}:/ # rsh lpar4 instfix | grep AIX
 All filesets for 5300-02_AIX_ML were found.
 All filesets for 5.3.0.0_AIX_ML were found.
 All filesets for 5300-01_AIX_ML were found.
 All filesets for 5300-03_AIX_ML were found.
 All filesets for 5300-04_AIX_ML were found.
{nimmast}:/ # rsh lpar4 oslevel -r
5300-04
{nimmast}:/ # rsh lpar4 oslevel -s
5300-04-03
{nimmast}:/ # nim -o fix_query LPAR4 | grep AIX
 All filesets for 5300-02_AIX_ML were found.
 All filesets for 5.3.0.0_AIX_ML were found.
 All filesets for 5300-01_AIX_ML were found.
 All filesets for 5300-03_AIX_ML were found.
 All filesets for 5300-04_AIX_ML were found.
```

---

In Example 5-62 on page 488, we perform software maintenance on a NIM machine group. We install the **bos.alt\_disk\_install** filesets on all members of the group **NIM\_MAC\_GRP\_1**.

*Example 5-62 Performing software maintenance on a NIM machine group*

---

```
{nimmast}:/ # lsnim -t mac_group
LPAR123456 groups mac_group
nimgrp groups mac_group
NIM_MAC_GRP_1 groups mac_group
```

```
{nimmast}:/ # lsnim -l NIM_MAC_GRP_1
NIM_MAC_GRP_1:
 class = groups
 type = mac_group
 comments = NIM Machine Group One.
member1 = LPAR4
member2 = LPAR5
```

```
{nimmast}:/ # smit nim_task_inst
Install and Update from ALL Available Software
NIM_MAC_GRP_1 groups mac_group
LPP_53_ML4 resources lpp_source
```

Install and Update from ALL Available Software

```
* Installation Target NIM_MAC_GRP_1
* LPP_SOURCE LPP_53_ML4
* Software to Install [bos.alt_disk_install] +

Customization SCRIPT to run after installation [] +
(not applicable to SPOTs)

Force no +

installp Flags
 PREVIEW only? [no] +
 COMMIT software updates? [yes] +
 SAVE replaced files? [no] +
 AUTOMATICALLY install requisite software? [yes] +
 EXTEND filesystems if space needed? [yes] +
 OVERWRITE same or newer versions? [no] +
 VERIFY install and check file sizes? [no] +
 ACCEPT new license agreements? [no] +
 (AIX V5 and higher machines and resources)
 Preview new LICENSE agreements? [no] +

Group controls (only valid for group targets):
 Number of concurrent operations [] #
 Time limit (hours) [] #
 Schedule a Job [no] +
 YEAR [] #
 MONTH [] +#
```



The number of machines permitted in a machine group is not explicitly limited by NIM. However, the following factors limit the number for practical reasons:

- ▶ The operation being performed

Operations that are not resource-intensive (such as the **maint** or **showlog** operations) may be performed on a group containing any number of machines. Operations that *are* resource-intensive (such as **cust** or **bos\_inst**) are limited by the throughput of the network, the disk access throughput of the installation servers, and the platform type of servers.

- ▶ NFS export limitations

The maximum number of hosts to which a file or directory may be exported with root permissions is limited by NFS to 256. Also, the length of a line in an exports file has an upper limit, which could determine the maximum number of machines permitted in a group.

For information about how to increase the number of machines to which a resource can be allocated, refer to “Exporting NIM resources globally” in AIX 5L V5.3 Installation and Migration, SC23-4887.

*Example 5-63 Displaying the installation log for a NIM machine group*

---

```
{nimmast}:/ # smit nim_grp_op
NIM_MAC_GRP_1 groups mac_group
showlog = display a log in the NIM environment

 Display Installation Log

* Target Name NIM_MAC_GRP_1
 Log Type [niminst] +
 Only Show Last Entry in Log? yes +

COMMAND STATUS

Command: OK stdout: yes stderr: no

Before command completion, additional instructions may appear below.

[TOP]
+-----+
+-----+
 Performing "showlog" Operation
+-----+
+-----+
 Performing showlog operation on machine 1 of 2: LPAR4 ...

BEGIN:Fri Jun 16 15:02:48 2006:061613024806
Command line is:
/usr/sbin/installp -acNgX -e /var/adm/ras/nim.installp -f \
/tmp/.genlib.installp.list.323610-d /tmp/_nim_dir_307446/mnt0
```

```

+-----+
 Pre-installation Verification...
+-----+
done
SUCSESSES

 Filesets listed in this section passed pre-installation verification
 and will be installed.

 Selected Filesets

 bos.alt_disk_install.boot_images 5.3.0.30 # Alternate Disk Installation ...
 bos.alt_disk_install.boot_images 5.3.0.40 # Alternate Disk Installation ...
 bos.alt_disk_install.rte 5.3.0.30 # Alternate Disk Installation ...
 bos.alt_disk_install.rte 5.3.0.40 # Alternate Disk Installation ...

 << End of Success Section >>

FILESET STATISTICS

 4 Selected to be installed, of which:
 4 Passed pre-installation verification

[MORE...164]

```

If there are any issues with a software maintenance task, you will see that the Cstate and prev\_state information will reflect the status of the operations that are running or have run. In Example 5-64 we can see that the prev\_state for LPAR4 was lppchk operation being performed and the prev\_state for LPAR5 was customization is being performed. Their current state is ready for a NIM operation, so no problems were encountered in any of the previous NIM operations on these clients.

---

*Example 5-64 Displaying NIM client Cstate and prev\_state information*

---

```

{nimmast}:/ # lsnim -l LPAR4 LPAR5
LPAR4:
class = machines
type = standalone
connect = shell
platform = chrp
netboot_kernel = mp
if1 = NET_EN1 lpar4 0
cable_type1 = tp
Cstate = ready for a NIM operation
prev_state = lppchk operation is being performed
Mstate = currently running
cpuid = 001A85D24C00

```

```

Cstate_result = success
current_master = nimmast
sync_required = yes
LPAR5:
class = machines
type = standalone
connect = shell
platform = chrp
netboot_kernel = mp
if1 = NET_EN1 LPAR5 0
cable_type1 = N/A
Cstate = ready for a NIM operation
prev_state = customization is being performed
Mstate = currently running
cpuid = 00CC544E4C00
Cstate_result = success

```

---

The output from the installp process is also logged on the NIM client to /var/adm/ras/nim.installp.

You can also perform other software maintenance-related tasks with NIM (via SMIT), as shown in Example 5-65.

*Example 5-65 NIM software maintenance tasks*

---

```

{nimmast}:/ # smit nim_task_maint
 Software Maintenance and Utilities

Commit Applied Software Updates (Remove Saved Files)
Reject Applied Software Updates (Use Previous Version)
Remove Installed Software

Copy Software to Hard Disk for Future Installation
Add Software to an lpp_source
Remove Software from an lpp_source
Eliminate Unnecessary Software Images in an lpp_source

Check Software File Sizes After Installation
Verify Software Installation and Requisites

Clean Up After Failed or Interrupted Installation

```

---

For example, you can list installed software, checking for installed fixes and committing applied filesets.

*Example 5-66 NIM software listing and related tasks*

---

```

{nimmast}:/ # smit nim_task_maint

```

List Installed Software and Related Information  
List Software on Media and Related Information

---

The **nim** command can also be used from the NIM master to perform several software maintenance tasks:

- ▶ Querying installed software (**lslpp**) on a client (or clients) and a machine group:

```
{nimmast}:/ # nim -o lslpp LPAR4
{nimmast}:/ # nim -o lslpp LPAR4 LPAR5
{nimmast}:/ # nim -o lslpp NIM_MAC_GRP_1
```
- ▶ Querying installed fixes on a client:

```
{nimmast}:/ # nim -o fix_query LPAR4 | grep AIX
```
- ▶ Previewing the installation of the `bos.alt_disk_install` filesets on a NIM client:

```
{nimmast}:/ # nim -o cust -a lpp_source=LPP_53_ML4 -a \
installp_flags="-pacgXY" -a filesets=bos.alt_disk_install LPAR4
```
- ▶ Performing an installation of the `bos.alt_disk_install` filesets on a NIM client:

```
{nimmast}:/ # nim -o cust -a lpp_source=LPP_53_ML4 -a \
installp_flags="-acgXY" -a filesets=bos.alt_disk_install LPAR4
```
- ▶ Previewing the removal of the `bos.alt_disk_install` filesets on a NIM client:

```
{nimmast}:/ # nim -o cust -a lpp_source=LPP_53_ML4 -a \
installp_flags="-pug" -a filesets=bos.alt_disk_install LPAR4
```
- ▶ Performing a removal of the `bos.alt_disk_install` filesets on a NIM client:

```
{nimmast}:/ # nim -o cust -a lpp_source=LPP_53_ML4 -a \
installp_flags="-ug" -a filesets=bos.alt_disk_install LPAR4
```
- ▶ Displaying the `installp` log for a NIM client:

```
{nimmast}:/ # nim -o showlog -a log_type=niminst LPAR4
```
- ▶ Previewing an `update_all` on a NIM client:

```
{nimmast}:/ # nim -o cust -a lpp_source=LPP_53_ML4 -a \
installp_flags="-pacgXY" -a fixes=update_all LPAR4
```
- ▶ Performing an `update_all` on a NIM client (installing the `bos.rte.install` fileset first):

```
{nimmast}:/ # nim -o cust -a lpp_source=LPP_53_ML4 -a \
installp_flags="-acgXY" -a filesets=bos.rte.install LPAR4
```

```
{nimmast}:/ # nim -o cust -a lpp_source=LPP_53_ML4 -a \
fixes=update_all LPAR4
```

- ▶ Performing an `update_all` on a NIM machine group, as shown in Example 5-67:

*Example 5-67 Performing an update\_all on a NIM machine group*

---

```
{nimmast}:/ # nim -o cust -a lpp_source=LPP_53_ML4 -a fixes=update_all
NIM_MAC_GRP_1
-----+
Initiating "cust" Operation
-----+
Allocating resources ...

Initiating the cust operation on machine 1 of 2: LPAR4 ...

Initiating the cust operation on machine 2 of 2: LPAR5 ...

-----+
"cust" Operation Summary
-----+
Target Result

LPAR4 INITIATED
LPAR5 INITIATED
```

---

**Note:** Use the `lsnim` command to monitor progress of INITIATED targets by viewing their NIM database definition.

- ▶ Performing an installation of filesets and RPMs on a NIM client:  
In Example 5-68, we install the OpenSSH and OpenSSL software. Note that both software packages are located in our `lpp_source` (`/AIX53ML4/LPP_53_ML4/`). However, the RPMs (OpenSSL) are located in the `RPMS/ppc` directory.  
The `geninstall` command will find and install the RPMs from that location. The OpenSSH filesets are located in `install/ppc`.

*Example 5-68 Installing the OpenSSH and OpenSSL software*

---

```
{nimmast}:/ #nim -o cust -a lpp_source=lpp5305 -a installp_flags=agXY -a
filesets="openssl-0.9.7d-2 openssl.base" LPAR4
```

```
Validating RPM package selections ...
```



```

openssl
#####

+-----+
|
| Pre-installation Verification...
|
+-----+

Verifying selections...done
Verifying requisites...done
Results...

SUCSESSES

Filesets listed in this section passed pre-installation verification
and will be installed.

Selected Filesets

openssh.base.client 4.1.0.5301 # Open Secure Shell Commands
openssh.base.server 4.1.0.5301 # Open Secure Shell Server

<< End of Success Section >>

FILESET STATISTICS

 2 Selected to be installed, of which:
 2 Passed pre-installation verification

 2 Total to be installed

+-----+
|
| Installing Software...
|
+-----+

installp: APPLYING software for:
 openssh.base.client 4.1.0.5301
 openssh.base.server 4.1.0.5301

. . .

Installation Summary

Name Level Part Event Result

```

|                     |            |      |       |         |
|---------------------|------------|------|-------|---------|
| openssh.base.client | 4.1.0.5301 | USR  | APPLY | SUCCESS |
| openssh.base.server | 4.1.0.5301 | USR  | APPLY | SUCCESS |
| openssh.base.client | 4.1.0.5301 | ROOT | APPLY | SUCCESS |
| openssh.base.server | 4.1.0.5301 | ROOT | APPLY | SUCCESS |

**Tip:** It is possible to install RPMs using FTP via the NIM master. For example, the following command will download the openssl rpm from the NIM master and install it on lpar4.

```
{lpar4}:/ # rpm -i ftp://root@nimmast/AIX53ML4/LPP_53_ML4/RPMS/ppc/\
openssl-0.9.7g-1.aix5.1.ppc.rpm
Password for root@nimmast:
{lpar4}:/ # rpm -qa
cdrecord-1.9-4
mkisofs-1.13-4
AIX-rpm-5.2.0.50-1
openssl-0.9.7g-1
{lpar4}:/ #
```

### ***Client-initiated software maintenance tasks (“pull”)***

There are several NIM operations related to software maintenance that the client can initiate via the **nimclient** command. Note that the client can perform operations upon itself only.

- ▶ Listing all available resources for the client:

```
{lpar4}:/ # nimclient -l -L LPAR4
```

- ▶ Allocating an lpp\_source to the client:

```
{lpar4}:/ # nimclient -o allocate -a lpp_source=lpp5305
```

- ▶ Deallocate a resource from the client:

```
{lpar4}:/ # nimclient -o deallocate -a lpp_source=lpp5305
```

- ▶ Show allocated resources for the client:

```
{lpar4}:/ # nimclient -l -c resources LPAR4
lpp5305 lpp_source
```

- ▶ Starting a BOS installation from the client (lpp\_source and SPOT allocated first; accept\_licenses set to yes):

```
{lpar4}:/ # nimclient -o allocate -a lpp_source=LPP_53_ML4 -a spot=SPOT_53_ML4
{lpar4}:/ # nimclient -o bos_inst -a accept_licenses=yes
```

Broadcast message from root@lpar4 (tty) at 10:21:57 ...

```

```

```

```

```
NIM has initiated a bos installation operation on this machine.
Automatic reboot and reinstallation will follow shortly...
```

```



```

- ▶ Performing an update\_all (cust) operation from the client:

```
{lpar4}:/ # nimclient -o cust -a lpp_source=lpp5305 -a fixes=update_all
BEGIN:Mon Jun 26 10:24:38 2006:062608243806
```

```
Command line is:
```

```
/usr/sbin/installp -agQX -e /var/adm/ras/nim.installp -f \
/tmp/.genlib.installp.list.270544-d /tmp/_nim_dir_327922/mnt0
```

```
+-----+
Pre-installation Verification...
```

```
+-----+
.....Output removed.....
```

- ▶ Resetting the NIM client state:

```
{LPAR5}:/ # nimclient -Fo reset
```

- ▶ Setting the date and time to that of the NIM master:

```
{LPAR5}:/ # nimclient -d
```

## 5.7.2 Booting in maint\_boot and diag modes

This section provides information about booting a NIM client in maintenance mode. If you need to perform maintenance on a NIM client, you can enter maintenance mode directly by enabling the **maint\_boot** operation for a NIM standalone machine.

### ***Booting in maintenance mode***

Follow this procedure to initiate the maint\_boot operation from the NIM master; see Example 5-69:

*Example 5-69 Enabling maintenance boot for a NIM client*

---

```
{nimmast}:/ # smit nim_mac_op
LPAR5 machines standalone
maint_boot = enable a machine to boot in maintenance mode
```

Enable Maintenance Boot

Type or select values in entry fields.  
Press Enter AFTER making all desired changes.

|             |                          |
|-------------|--------------------------|
| Target Name | [Entry Fields]           |
| * SPOT      | LPAR5<br>[SPOT_53_ML4] + |

```

{nimmast}:/ #lsnim -l VLPAR_p5
LPAR5:
 class = machines
 type = standalone
 connect = shell
 platform = chrp
 netboot_kernel = mp
 if1 = NET_EN1 LPAR5 0
 cable_type1 = N/A
 Cstate = maintenance boot has been enabled
 prev_state = not running
 Mstate = in the process of booting
 info = setting_console
 boot = boot
 spot = SPOT_53_ML4
 cpuid = 00CC544E4C00
 control = master

```

---

1. Enter the `smit nim_mac_op` fast path.
2. Select the client's machine object.
3. Select the **maint\_boot** operation.
4. Select the SPOT to be used for the operation.
5. Press Enter to enable the client for maintenance boot.
6. Verify the NIM client state is now set to `maintenance boot has been enabled`.
7. Network-boot the client. It will boot from the SPOT in maintenance mode.
8. You are presented with a menu for performing various maintenance activities, as shown in Example 5-70.

In our scenario, we access a root volume group. This is useful if you are troubleshooting a system that does not boot normally (for example, because of file system or JFS log corruption).

9. We are presented with a maintenance shell.
10. When we are finished, we can halt the machine and restart it.
11. We reset the NIM client. Its `Cstate` (as shown in Example 5-71 on page 500) is now set to: `ready for a NIM operation`.

*Example 5-70 Accessing rootvg in maintenance boot mode*

---

Maintenance

Type the number of your choice and press Enter.

```
>>> 1 Access a Root Volume Group
 2 Copy a System Dump to Removable Media
 3 Access Advanced Maintenance Functions
 4 Erase Disks
```

```
 88 Help ?
 99 Previous Menu
```

```
>>> Choice [1]:
```

Warning:

If you choose to access a root volume group, you will NOT be able to return to the Base Operating System Installation menus without rebooting.

Type the number of your choice and press Enter.

```
0 Continue
```

```
 88 Help ?
>>> 99 Previous Menu
```

```
>>> Choice [99]:0
```

#### Access a Root Volume Group

Type the number for a volume group to display the logical volume information and press Enter.

```
1)Volume Group 00cc544e00004c000000010bcc5a1e11 contains these disks:
 hdisk0 10240 vscsi
```

```
Choice:1
```

Volume Group Information

```

Volume Group ID 00cc544e00004c000000010bcc5a1e11 includes the following
```

logical volumes:

hd5 hd6 hd8 hd4 hd2 hd9var hd3 hd1 hd10opt  
-----

Type the number of your choice and press Enter.

- 1) Access this Volume Group and start a shell
- 2) Access this Volume Group and start a shell before mounting filesystems

99) Previous Menu

Choice [99]:1

Importing Volume Group...

rootvg

Checking the / filesystem.

log redo processing for /dev/rhd4

syncpt record at 114d1ac

end of log 117924c

syncpt record at 114d1ac

syncpt address 114ba2c

number of log records = 1551

number of do blocks = 94

number of nodo blocks = 3

/dev/rhd4 (/): \*\* Unmounted cleanly - Check suppressed

Checking the /usr filesystem.

/dev/rhd2 (/usr): \*\* Unmounted cleanly - Check suppressed

Saving special files and device configuration information.

Checking and mounting the /tmp filesystem.

/dev/rhd3 (/tmp): \*\* Unmounted cleanly - Check suppressed

Checking and mounting the /var filesystem.

/dev/rhd9var (/var): \*\* Unmounted cleanly - Check suppressed

Filesystems mounted for maintenance work.

#

---

Resetting the NIM client after a maintenance boot is shown in Example 5-71.

*Example 5-71 Resetting a NIM client after a maintenance boot*

---

```
{nimmast}:/ # smit nim_mac_op
```

```
LPAR5 machines standalone
reset = reset an object's NIM state
```

## Reset the NIM State of a Machine

```
Target Name LPAR5
Deallocate All Resources? yes +
 (removes all root data for
 diskless/dataless clients)
Force yes +
```

```
{nimmast}:/ # lsnim -l LPAR5
LPAR5:
 class = machines
 type = standalone
 connect = shell
 platform = chrp
 netboot_kernel = mp
 if1 = NET_EN1 LPAR5 0
 cable_type1 = N/A
 Cstate = ready for a NIM operation
 prev_state = maintenance boot has been enabled
 Mstate = currently running
 Cstate_result = reset
```

---

It is also possible for the client to configure itself for a maintenance mode boot:

```
{LPAR5}:/ # nimclient -o maint_boot -a spot=SPOT_53_ML4
```

### ***Performing boot diagnostics on NIM clients***

This section provides information about performing hardware diagnostics on a NIM client. Hardware diagnostics can be performed on all NIM clients using a diagnostic boot image from the NIM master, rather than booting from a diagnostic tape or CD-ROM. This is useful for standalone clients because the diagnostics do not have to be installed on the local disk. Diagnostic support comes from a SPOT resource.

Follow these steps to initiate the **diag** operation from the master:

1. Enter the `smit nim_mac_op` fastpath as shown in Example 5-72 on page 502.
2. Select the machine object.
3. Select the **diag** operation from the list of operations.
4. Verify that the NIM client state is now set to: `diagnostic boot has been enabled`.
5. Network-boot the client in service mode. It will boot from the SPOT in diagnostic mode, as shown in Example 5-73 on page 502.

6. The diagnostic menu appears. Various hardware diagnostic activities can be performed.
7. When finished, halt the machine and restart it.
8. Reset the NIM client. Its Cstate is now set to: ready for a NIM operation; see Example 5-71 on page 500.

*Example 5-72 Enabling diagnostics boot for a NIM client*

---

```
{nimmast}:/ # smit nim_mac_op
LPAR5 machines standalone
diag = enable a machine to boot a diagnostic image
```

Enable Diagnostic Boot

```
Target Name LPAR5
* SPOT [SPOT_53_ML4] +
```

```
{nimmast}:/ # lsnim -l LPAR5
LPAR5:
 class = machines
 type = standalone
 connect = shell
 platform = chrp
 netboot_kernel = mp
 if1 = NET_EN1 LPAR5 0
 cable_type1 = N/A
 Cstate = diagnostic boot has been enabled
 prev_state = ready for a NIM operation
 Mstate = currently running
 boot = boot
 spot = SPOT_53_ML4
 control = master
 Cstate_result = reset
```

---

You will be prompted to define the system console when booting in diagnostic mode.

*Example 5-73 Booting the client in diag mode*

---

```
***** Please define the System Console. *****
```

Type a 1 and press Enter to use this terminal as the system console.

Pour définir ce terminal comme console système, appuyez sur 1 puis sur Entrée.

Taste 1 und anschliessend die Eingabetaste druecken, um diese Datenstation als Systemkonsole zu verwenden.



Premere il tasto 1 ed Invio per usare questo terminal  
come console.  
Escriba 1 y pulse Intro para utilizar esta terminal como  
consola del sistema.  
Escriviu 1 i premeu Intro per utilitzar aquest  
terminal com a consola del sistema.  
Digite um 1 e pressione Enter para utilizar este terminal  
como console do sistema.

Starting errdemon  
Starting Diagnostics

DIAGNOSTIC OPERATING INSTRUCTIONS VERSION 5.3.0.40

LICENSED MATERIAL and LICENSED INTERNAL CODE - PROPERTY OF IBM  
(C) COPYRIGHTS BY IBM AND BY OTHERS 1982, 2004.  
ALL RIGHTS RESERVED.

These programs contain diagnostics, service aids, and tasks for  
the system. These procedures should be used whenever problems  
with the system occur which have not been corrected by any  
software application procedures available.

In general, the procedures will run automatically. However,  
sometimes you will be required to select options, inform the  
system when to continue, and do simple tasks.

Several keys are used to control the procedures:  
- The Enter key continues the procedure or performs an action.  
- The Backspace key allows keying errors to be corrected.  
- The cursor keys are used to select an option.

To continue, press Enter.

#### FUNCTION SELECTION

- 1 Diagnostic Routines  
This selection will test the machine hardware. Wrap plugs and  
other advanced functions will not be used.
- 2 Advanced Diagnostics Routines  
This selection will test the machine hardware. Wrap plugs and  
other advanced functions will be used.
- 3 Task Selection (Diagnostics, Advanced Diagnostics, Service Aids, etc.)  
This selection will list the tasks supported by these procedures.  
Once a task is selected, a resource menu may be presented showing  
all resources supported by the task.

#### 4 Resource Selection

This selection will list the resources in the system that are supported by these procedures. Once a resource is selected, a task menu will be presented showing all tasks that can be run on the resource(s).

#### 99 Exit Diagnostics

NOTE: The terminal is not properly initialized. You will be prompted to initialize the terminal after selecting one of the above options.

To make a selection, type the number and press Enter. [1 ]

To make a selection, type the number and press Enter. [99]

#### SHUTDOWN

A system shutdown is about to occur.

Type 99 again and press <Enter> to continue the shutdown process.

--or--

Press the <Enter> key to abort the shutdown and return to Diagnostics.

99

...Halt completed....

---

It is also possible for the client to configure itself for a diagnostic boot:

```
{LPAR5}:/ # nimclient -o diag -a spot=SPOT_53_ML4
```

## 5.8 Automatic scripts

This section describes how to use automatic scripts to perform system customization after a Basic Operating System (BOS) mksysb installation.

It covers the following topics:

- ▶ Customizing using a NIM script resource
- ▶ Customizing using a NIM bosinst\_data resource
- ▶ Customizing using a NIM fb\_script resource

## 5.8.1 Install time customization

When installing an AIX LPAR or physical machine, with either a Basic Operating System (BOS) installation or a mksysb image file, there are several ways to provide installation time customization.

Customization for BOS installations (NIM bos\_inst operations using source=rte or source=spot), can be performed in one or more of the following ways:

- ▶ Using NIM script resources to provide command line and script customization - during installation and NIM cust operations
- ▶ Using NIM bosinst\_data resources to provide command line and script customization - during installation
- ▶ Using SPOT modified /usr file system files - during installation
- ▶ Using installable filesets and scripts customization - any time after the first boot
- ▶ Using automated remote commands (**rsh/ssh**) from scripts run from another system - any time after the first boot
- ▶ Using manually executed commands - any time after the first boot
- ▶ Using a NIM fb\_script resource script to be executed - at the end of the first boot

Customization of mksysb installations (NIM mksysb), in addition to the BOS installation described here, can also be performed in the following way:

- ▶ Modifying files on the source system before creating a NIM mksysb image file
- ▶ In the following sections, we explain these topics in greater detail.

## 5.8.2 Customization for BOS installations

Here we describe how to create and use:

- ▶ NIM script resources
- ▶ NIM bosinst\_data CUSTOMIZATION\_FILE attribute script
- ▶ NIM fb\_script resource

Creating installable filesets and customization scripts is described in 4.12, “Creating bundles, BFF, and RPM packages” on page 354. To run remote commands from another node, such as the NIM master, you can use commands such as **rsh** or **ssh**.

## Using NIM script resources

A NIM script resource represents a file that is an user-created shell script that can be allocated to a NIM machine, after it is defined.

The NIM script resources are always run by NIM *after* software installation are performed during `bos_inst` operations, or during `cust` operations. Multiple script resources can be allocated to be executed, but the order in which the scripts will be run is unpredictable.

Use the NIM script resources in this sequence:

1. Create a shell script.
2. Define the NIM script resource pointing to the shell script.
3. Allocate the NIM script resource for a `cust` or `bos_inst` operation to one or more NIM clients or NIM groups.
4. Execute the `cust` or `bos_inst` operation on one or more NIM clients or NIM groups.

Example 5-74 shows a simple shell script that performs some customization on a NIM client. First it acquires the `/etc/motd` file from the NIM master, then it customizes the login herald, sets the time zone, and specifies the resolve order for hostname and IP-address.

*Example 5-74 Example NIM script, node\_cust, for cust of bos\_inst operation*

---

```
#!/bin/ksh
node_cust
Synopsis.....%M%
Author.....User01
Created.....2006
Version.....%Z% %M% %I% (%E% %U%) %Q%
Description....N/A
Input.....N/A
Output.....Perform Node Customization.
Algorithm.....N/A
#-----
#
Redirect STDOUT and STDERR to a logfile
#
exec 1>/tmp/${0##*/}.log
exec 2>&1
#
Acquiring the /etc/motd file from the NIM master...
#
if [["$NIM_SHELL" = "shell"]];then
 if [["$NIM_MASTER_HOSTNAME" != ""]];then
 ping -c 1 -w 1 $NIM_MASTER_HOSTNAME >/dev/null 2>&1
 if [[$? -eq 0]];then
```

```

 cp /etc/motd /etc/motd~$(date "+%j")
 rcp $NIM_MASTER_HOSTNAME:/etc/motd /etc
 fi
fi
fi
#
Customize the login herald, for telnet login screens etc...
#
/usr/bin/chsec -f /etc/security/login.cfg -s default -a 'herald=\n\r\n\rThis computer is the
property of Our Company.\n\rUnauthorized access is prohibited. If you are not authorized \r\nto
have access to this computer, leave now.\r\nAll sessions on this computer can and may be
monitored.\n\r \r\nlogin: '
#
Timezone
Universal Time Coordinated
+ one hour during winter or
+ two hours during summertime
Changing the last sunday in March (3) and October (10)
#
/usr/bin/chtz 'UTC-1UTC-2,M3.5.0/02:00:00,M10.5.0/03:00:00'
#
Specify resolv order for hostname and IP-address...
#
if ! grep NSORDER /etc/environment; then
 echo "NSORDER=local,bind" >> /etc/environment
fi

```

---

In our case, we check the script for syntax errors by running it without execution. The script name in our examples is `node_cust`:

```
ksh -xvn node_cust
```

After this step completes successfully, run the script manually on a test system to verify that it works as desired. After verifying that the script works properly, it can be defined as a NIM script resource as shown in Example 5-75. In this case, we use the `/export/scripts` directory.

#### *Example 5-75 Creating a NIM script resource*

---

```
root@master:/: nim -o define -t script -a server=master
-a location=/export/scripts/node_cust node_cust
```

```
root@master:/: lsnim -l node_cust
node_cust:
 class = resources
 type = script
 Rstate = ready for use
 prev_state = unavailable for use
 location = /export/scripts/node_cust
```



To monitor the progress of the NIM cust operation, use the `lsnim` command:

```
lsnim -l <NIM machine name>
```

In our case, the command is:

```
lsnim -l LPAR55
```

When the installation (`bos_inst`) or customization (`cust`) is finished, the actions specified in the NIM script customization script have been performed. In the even of problems, check the output of the NIM script execution, as shown in Example 5-78.

*Example 5-78 Debug output of NIM script execution during cust operation*

---

```
+ [[shell = shell]]
+ [[nimmast !=]]
+ ping -c 1 -w 1 nimmast 1> /dev/null 2>& 1
+ [[0 -eq 0]]
+ date +%j
+ cp /etc/motd /etc/motd~172
+ rcp nimmast:/etc/motd /etc
+ /usr/bin/chsec -f /etc/security/login.cfg -s default -a herald=\n\r\n\rThis co
mputer is the property of Our Company.\n\rUnauthorized access is prohibited. If
you are not authorized \r\nto have access to this computer, leave now.\r\nAll se
ssions on this computer can and may be monitored.\n\r \r\nlogin:
+ /usr/bin/chtz UTC-1UTC-2,M3.5.0/02:00:00,M10.5.0/03:00:00
+ grep NSORDER /etc/environment
+ echo NSORDER=local,bind >> /etc/environment
```

---

**Note:** The script resources must *not* point to files that reside in the `/export/nim/scripts` directory. This directory is used for the `nim_script` resource that is managed by NIM. NFS restrictions prevent defining multiple resources in the same location.

## Using NIM `bosinst_data` resources

When using a NIM `bosinst_data` resource during a `bos_inst` operation on a NIM client, you can specify the path to a script for the `CUSTOMIZATION_FILE` attribute, in the file pointed to by the `bosinst_data` resource.

This script is started at the end of the main installation program, by the `/usr/lpp/bosinst/bi_main` program. For spot installations, it will occur after approximately 90% of the total installation process. For `rte` installations, it will occur after approximately 95% of the total installation process.

**Note:** This method has been available to use with **mksysb** since the early 1990s with AIX 3.1. With NIM, you can use the NIM script resources instead, which is usually more efficient. However, tape, DVD or similar **mksysb** media can still make use of this method.

Example 5-79 is a simple shell script that performs some customization on a NIM client. In this case, it overwrites the `/etc/motd` (message of the day) file.

*Example 5-79 Example CUSTOMIZATION\_FILE script, node\_bosinst*

---

```
#!/bin/ksh
node_bosinst
Synopsis.....%M%
Author.....User01
Created.....2006
Version.....%Z% %M% %I% (%E% %U%) %Q%
Description....N/A
Input.....N/A
Output.....Perform Node Customization during bosinst.
Algorithm.....N/A
#-----
#
Redirect STDOUT and STDERR to a logfile
#
exec 1>/usr/local/bosinst/node_bosinst.log
exec 2>&1

cat <<EOF > /etc/motd

This computer is the property of Our Company.
Unauthorized access is prohibited. If you are not authorized
to have access to this computer, leave now.
All sessions on this computer can and may be monitored.
Violations will be punished to the full extent of the LAW.

EOF
```

---

We check the script for syntax errors by running it without execution. The script name is `node_bosinst`:

```
ksh -xvn node_bosinst
```

After this step completes successfully, run the script manually on a test system to verify that it works as desired. After verifying that the script works properly, it can be copied to a directory on the SPOT that will be used during installation. In our case, we create and use the `/usr/local/bosinst` directory in the SPOT for our script, because the SPOT will be mounted over the RAM-`/usr` file system.



The full path to the customization script on our NIM master will then be `/export/spot/spot5305/usr/local/bosinst/node_bosinst`.

**Note:** The path name specified for the `CUSTOMIZATION_FILE` attribute must be the path as known to the installation process during installation.

Example 5-80 is a simple `bosinst_data` resource specification file for automated installation. It should not require any user input unless something goes wrong during the installation process.

*Example 5-80 Example bosinst\_data resource specification file*

---

```
control_flow:
 CONSOLE = Default
 INSTALL_METHOD = overwrite
 PROMPT = no
 EXISTING_SYSTEM_OVERWRITE = yes
 INSTALL_X_IF_ADAPTER = no
 RUN_STARTUP = no
 CUSTOMIZATION_FILE = /usr/local/bosinst/node_bosinst
 ACCEPT_LICENSES = yes
 DESKTOP = NONE
 INSTALL_DEVICES_AND_UPDATES = yes
 ENABLE_64BIT_KERNEL = yes
 CREATE_JFS2_FS = yes
 ALL_DEVICES_KERNELS = no
 GRAPHICS_BUNDLE = no
 MOZILLA_BUNDLE = no
 KERBEROS_5_BUNDLE = no
 SERVER_BUNDLE = no
 REMOVE_JAVA_118 = no
 HARDWARE_DUMP = yes
 ADD_CDE = no
 ADD_GNOME = no
 ADD_KDE = no

target_disk_data:
 LOCATION =
 SIZE_MB =
 HDISKNAME =

locale:
 BOSINST_LANG =
 CULTURAL_CONVENTION =
 MESSAGES =
```

To check the contents of your customized `bosinst_data` resource file, use the **bicheck** command as follows:

```
/usr/lpp/bosinst/bicheck <filename>
```

In our case:

```
/usr/lpp/bosinst/bicheck bosinst_group55
```

The **bicheck** command will verify the existence of the `control_flow`, `target_disk_data`, and `locale` stanzas, as needed.

The value for each field (if given) will be confirmed to match an allowable value, or other limitations, if they exist. If a non-prompted install is specified, the existence of values for required fields will be confirmed.

The command will not stop after the first error, but will continue as far as possible to indicate all problems with the `bosinst.data` file. If the return code is 1 (failed), an error message to standard error will name the stanzas and fields that have incorrect values.

**Note:** The **bicheck** command will not issue errors for misspelled attributes. For example, attributes such as `CONSOLE` should be in capital letters, and are *not* recognized if they are not.

When both the customization script and the specification file are working as desired, define the NIM `bosinst_data` resource as shown in Example 5-81. In this case, we use the `/export/scripts` directory for the `bosinst_data` specification file.

*Example 5-81 Creating a NIM `bosinst_data` resource*

---

```
root@master:/: nim -o define -t bosinst_data -a server=master -a
location=/export/scripts/bosinst_group55 bosinst_group55
```

---

For our purposes, we use a SPOT cloning during which our customization script will be used. In Example 5-82 on page 513, we use one NIM group with one NIM standalone machine.

*Example 5-82 Creating a NIM machine group resource*

---

```
root@master:/: nim -o define -t mac_group -a add_member=LPAR55 group55
```

---

The lpp\_source needs to be allocated in case additional device drivers are needed, as shown in Example 5-83. To prevent this from happening, set the ALL\_DEVICES\_KERNELS and INSTALL\_DEVICES\_AND\_UPDATES attributes to no in the bosinst\_data resource specification file.

*Example 5-83 Allocating SPOT, lpp\_source and bosinst\_data for SPOT cloning*

---

```
root@master:/: nim -o allocate -a spot=spot5305 -a lpp_source=lpp5305 -a bosinst_data=bosinst_group55 group55
```

---

Now we can initiate the actual installation process. In this case we specify the installation source to be the allocated SPOT resource spot5305, as shown in Example 5-84.

*Example 5-84 Activating the SPOT cloning*

---

```
root@master:/: nim -o bos_inst -a source=spot -a installp_flags=agX group55
```

```
+-----+
| |
| Initiating "bos_inst" Operation |
| |
+-----+
| Allocating resources ... |
| |
| Initiating the bos_inst operation on machine 1 of 1: LPAR55 ... |
| |
+-----+
| |
| "bos_inst" Operation Summary |
| |
+-----+
| Target | Result |
|-----|
| LPAR55 | INITIATED |
```

Note: Use the lsnim command to monitor progress of "INITIATED" targets by viewing their NIM database definition.

---

The installation process screen will show SPOT data being copied; see Figure 5-4 on page 514.

```

 Installing Base Operating System

 Please wait...

 Approximate Elapsed time
 % tasks complete (in minutes)

 18 3 19% of SPOT data copied.

```

Figure 5-4 Point-in-time screenshot of SPOT cloning

### Using the CUSTOMIZATION\_FILE with mksysb image files

Instead of updating the SPOT file tree, copy the customization file to the system to be cloned. In our example, we put it under the /usr/local/bosinst directory.

Perform cleanup and additional customization needed on the system prior to creating the mksysb image file for cloning purposes, as shown in Example 5-85. For more information about cloning using the mksysb command, see 5.4, “Cloning NIM clients using mksysb” on page 451.

*Example 5-85 Creating a mksysb with the CUSTOMIZATION\_FILE script*

```

root@master:/: nim -o define -t mksysb -a server=master -a mk_image=yes -a source=LPAR55 -a
mksysb_flags=i -a location=/export/images/mksysb_lpar55 mksysb_lpar55

```

```

+-----+
| System Backup Image Space Information |
| (Sizes are displayed in 1024-byte blocks.) |
+-----+

```

```

Required = 734753 (718 MB) Available = 811576 (793 MB)

```

```

Creating information file (/image.data) for rootvg..

```

```

Creating list of files to back up .
Backing up 20141 files.....
20141 of 20141 files backed up (100%)

```

0512-038 savevg: Backup Completed Successfully.

---

Then activate the installation of the newly created mksysb. In this case, we install it on the NIM client LPAR66, as shown in Example 5-86.

*Example 5-86 Installing allocated mksysb*

---

```
root@master:/: nim -o bos_inst -a source=mksysb LPAR66
```

```
+-----+
| |
| Initiating "bos_inst" Operation |
|-----+
| Allocating resources ... |
|
| Initiating the bos_inst operation on machine 1 of 1: LPAR66 ... |
|-----+
| |
| "bos_inst" Operation Summary |
|-----+
Target Result
LPAR66 INITIATED
```

Note: Use the `lsnim` command to monitor progress of "INITIATED" targets by viewing their NIM database definition.

---

The installation process screen will show mksysb data being restored; see Figure 5-5.

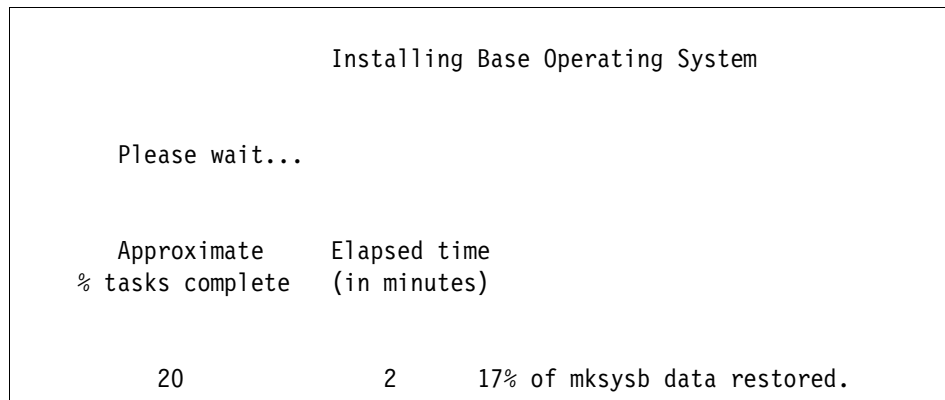

```

 Installing Base Operating System

 Please wait...

 Approximate Elapsed time
 % tasks complete (in minutes)

 20 2 17% of mksysb data restored.
```

*Figure 5-5 Point-in-time screen shot of mksysb restore*

## Using NIM fb\_script script resources

A NIM fb\_script resource represents a file that is a user-created shell script and can be allocated to a NIM machine, after it is defined. The BOS installation process creates a script in the /etc directory named firstboot, containing the content of the allocated NIM fb\_script resource.

When a client is booted, the /usr/sbin/fbcheck script command checks for the existence of the /etc/firstboot file. If it exists, it renames it to a script in the /etc directory prefixed with fb\_. This script is then executed.

The **fbcheck** command is run by **init** master process according to the entry in /etc/inittab. This allows the fb\_script to perform configuration processing on the client after all the software is installed, but before it has finished the first startup in multi-user mode.

Use NIM fb\_script resources in the following sequence:

1. Create a shell script.
2. Define the NIM fb\_script resource pointing to the shell script.
3. Allocate the NIM fb\_script resource for a bos\_inst operation, to one or more NIM clients or NIM groups.
4. Execute the bos\_inst operation on one or more NIM clients or NIM groups.

Example 5-87 is a simple shell script that performs some customization on a NIM client. It creates a few file systems.

*Example 5-87 Example NIM fb\_script, node\_firstboot, for bos\_inst operation*

---

```
#
node_firstboot
Synopsis.....%M%
Author.....User01
Created.....2006
Version.....%Z% %M% %I% (%E% %U%) %Q%
Description.....N/A
Input.....N/A
Output.....Perform First Boot Node Customization.
Algorithm.....N/A
#-----
#
Redirect STDOUT and STDERR to a logfile
#
exec 1>/tmp/${0##*/}.log
exec 2>&1
#
Create /local JFS2 filesystem with 1PP size, mount it, create a directory and
add the directory path to the root users KornShell .profile
```

```
#
crfs -v jfs2 -g rootvg -a size=1 -m /local -A yes -p rw -a logname=INLINE && mount /local &&
mkdir /local/pbin && echo 'export PATH=$PATH:/local/pbin:' >>/.profile
#
Create /usr/local JFS2 filesystem with 1PP size and mount it
#
crfs -v jfs2 -g rootvg -a size=1 -m /usr/local -A yes -p rw -a logname=INLINE && mount
/usr/local
```

---

We check the script for syntax errors by running it without execution. The script name is `node_firstboot`:

```
ksh -xvn node_firstboot
```

After this step completes successfully, run the script manually on a test system to verify that it works as desired. After it works properly, it can be defined as a NIM `fb_script` resource as shown in Example 5-88. In this case, we use the `/export/scripts` directory.

*Example 5-88 Creating a NIM `fb_script` resource*

---

```
root@master:/: nim -o define -t fb_script -a server=master
-a location=/export/scripts/node_firstboot node_firstboot
```

```
root@master:/: lsnim -l node_cust
node_firstboot:
 class = resources
 type = fb_script
 Rstate = ready for use
 prev_state = unavailable for use
 location = /export/scripts/node_firstboot
 alloc_count = 1
 server = master
```

---

Now when the NIM `fb_script` has been defined, you can use the `nim` command to view the content of the script file itself:

```
nim -o showres node_firstboot
```

The `node_firstboot` NIM `fb_script` resource is now ready for use, and can be allocated and used for `bos_inst` operations. Allocate the script to a NIM standalone machine or NIM group. In this case the NIM machine is LPAR55, as shown in Example 5-89 on page 518.

*Example 5-89 fb\_script for a standalone or a group of machines*

---

```
root@master:/: nim -o allocate -a spot=spot5305 -a lpp_source=lpp5305 -a
bosinst_data=bosinst_group55 -a fb_script=node_firstboot LPAR55
```

---

Now we can initiate the actual installation process. In this case, we specify the installation source to be the allocated NIM lpp\_source resource lpp5305, using the source attribute keyword `rte`, as shown in Example 5-90.

*Example 5-90 Activating the installation with firstboot fb\_script customization*

---

```
root@master:/: nim -o bos_inst -a source=rte -a installp_flags=agX group55
```

```
+-----+
| |
| Initiating "bos_inst" Operation |
| |
+-----+
| Allocating resources ... |
| |
| Initiating the bos_inst operation on machine 1 of 1: LPAR55 ... |
| |
+-----+
| |
| "bos_inst" Operation Summary |
| |
+-----+
| Target Result |
|-----|-----|
| LPAR55 INITIATED |
```

Note: Use the `lsnim` command to monitor progress of "INITIATED" targets by viewing their NIM database definition.

---

The installation process screen will display the message: Installing additional software. Then software installation using the `installp` command will commence, as shown in Figure 5-6 on page 519.



```
Installing Base Operating System

Please wait...

Approximate Elapsed time
% tasks complete (in minutes)

18 3 Installing additional software.
```

Figure 5-6 Point-in-time screen shot of `lpp_source rte` installation

When the installation is finished, the actions specified in the NIM `fb_script` customization script have been performed.

## 5.9 Implementing a standard operating environment for AIX 5L V5.3 systems with NIM

This section describes practices for implementing a standard operating environment (SOE) for AIX systems with NIM. It is intended as an example-based guide that explains how to install AIX systems in a repeatable and consistent way, with the objective of reducing the associated system management and administration overhead.

The practices described here may not be suitable for all environments, so use your best judgment and take only what you consider can be applied to your site in keeping with the overall recommendations. The list of recommendations is not exhaustive; instead it is a starting point for developing a standard operating environment (SOE) for AIX in a NIM environment.

We discuss the following topics:

- ▶ Do you need an SOE for your AIX systems
- ▶ What is an SOE for AIX systems
- ▶ What is the purpose of the SOE image
- ▶ Using NIM to install and manage the SOE environment

## 5.9.1 Do you need an SOE for your AIX systems

If you manage one or more AIX systems, then an SOE may be useful. If you have a NIM master and you need to manage five or more AIX system images in a consistent and standard way, an SOE can offer many advantages.

## 5.9.2 What is an SOE for AIX systems

An SOE for AIX systems is a set of best practices, procedures, documents, standards, conventions, tools, and utilities with which you install and administer an AIX server. Administration tasks within the SOE are performed via NIM. All this information would be outlined in an SOE document. This document would include (but is not limited to) the following:

1. Guidelines for installing new hardware within your data center; for example, hardware delivery, cabling for network and storage, how and where to record hardware serial numbers and model types, location of pSeries hardware environment diagrams, and so on.
2. A list of standard filesets included (or that should be included) for installation in the AIX SOE image. This includes AIX filesets, storage device drivers and software (for example, SDD, SDDPCM), and so on.
3. AIX installation and management procedures via NIM. A standard image will be used to install all new NIM clients. This image would reside in `/export/images` on the NIM master and would be named so as to identify its purpose; for example, `soe_mksysb - /export/images/AIX5304_64bit_SOE_V1-mkysb`. The latest Technology Level would be applied to this image regularly.
4. NIM standards such as naming conventions for NIM clients, SPOTs, `lpp_source` resources and standard locations for NIM resources, and so on (for more information about this topic, refer to 2.3, “Planning for your NIM environment” on page 45).

Here are some examples:

- A NIM client machine name consists of the hostname with `nim` appended to it (such as `uataix01nim`).
- NIM client `mkysb` backups are performed from the client via a script from root's crontab; such a script could be executed from root's crontab, for example, twice a week.
- NIM client `mkysb` resource names format, such as `hostname-mkysb.AIXV.Day` (where `hostname` is the name of the system, `AIXV` is the AIX version, and `Day` is the day of the week that the backup was created). For example: `uataix01nim-mkysb.530401.Mon`.
- NIM client `mkysb` images are stored in `/export/images`.

- NIM lpp\_source resource names and locations will be lpp\_sourceaixVERSION, /export/lpp\_source/lpp\_sourceaixVERSION (where VERSION is the AIX version). For example, lpp\_sourceaix5304 - /export/lpp\_source/lpp\_sourceaix5304.
  - NIM SPOT resource names and location will be spotaixVERSION and /export/spot/spotaixVERSION (where VERSION is the AIX version). For example, spotaix5304 - /export/spot/spotaix5304.
  - /ftpboot is created as a separate file system; for example, not in / (root). This prevents the root file system from filling in the event that many boot images are created.
  - Location of other software that may need to be installed on the system. For example, a separate file system is created which will hold other software (for example, DB2, Oracle®, TSM, controlm, installp bundles and RPMs, and so on.). Refer to 4.12, “Creating bundles, BFF, and RPM packages” on page 354 for use with NIM.
  - Location of SOE materials. For example, a file system (/software/soe), would contain SOE only-related software such as SOE scripts, tools, utilities, installp bundles, RPMs, and so on.
  - Location of custom/firstboot NIM scripts. For example, the /export/scripts file system would contain firstboot and customization scripts that could be used as NIM resources during an installation.
  - Location of other custom NIM resource files. For example, /export/etc would contain custom NIM resource configuration files like bosinst.data and nimclient.defs.
5. Network configuration. For example, a separate VLAN for administration exists within the data center network. This VLAN is used only for administration and backup tasks. You create a new VLAN that will be used exclusively by NIM (and CSM and TSM, or CSM or TSM) network traffic that is completely isolated from any production network. Each host has at least two network adapters, with at least one interface connected to the administration and management VLAN.
6. LPAR configuration standards such as profile names, LPAR names, recommended LPAR profile settings (CPU, memory min/des/max and adapter layout), special settings (such as Small Real Mode Address Region, Allowed Shared Processor Pool Utilization Authority, Enable Connection Monitoring, and so on). For example:
- Profile name = normal
  - The partition name will be the same as the hostname.
  - The partition minimum and desired settings will be the same.

- The partitions should be configured for Dynamic LPAR, for example CPU min=1, Des=1, Max=4.
  - Where possible, spread adapters over different I/O drawers and halves of the drawers, for redundancy.
  - All partitions have a minimum of two Ethernet adapters and two Fibre Channel adapters.
7. Hostname standards and naming conventions, such as uataix01, where u=UNIX, a=AIX, t=Test (p=Production, d=Development, and so on). aix is a three-letter label indicating the system's purpose (for example, sap, db2, ora, and so on). 01 (for example, 02, 03, 04, and so on) indicates the unique number of this type of server.
  8. Volume group, logical volume and file system naming standards or conventions For example, all VGs and LVs will have vg/lv appended, such as datavg and usrlocallv. All file systems within rootvg should be of type JFS. All file systems within non-rootvg file systems should be of type JFS2.
  9. Paging space and dump space considerations and sizing. For example, true paging space sizing will depend on application requirements. But as a starting point, set paging space to at least the same (or twice the) size of real memory (on small memory systems). A separate LV for system dump space should be created, for example, hd7. Use the **dumpcheck/sysdumpdev -e** commands to ensure it is large enough.
  10. AIX customization, such as TCB, kernel type, syslog configuration, TZ, LANG, AIX licenses, tuning recommendations, sendmail configuration, NTP settings, /etc/motd, and so on. For example:
    - TCB should be enabled.
    - 64-bit kernel should be installed.
    - LANG=en\_US.
    - AIX licenses set to 1000 (not an issue with AIX 5L V5.3).
    - sys0 attributes, for example maxuproc, iostat, cpuguard and fullcore.
    - Syslog configuration; for example:
 

```
mail.debug /var/log/maillog rotate time 7d files 4 compress
*.debug;mail.none /var/log/syslog rotate time 7d files 4 compress
```
  11. Disk configuration, such as bootlist, mirrored rootvg, SDD, SDDPCM. System boot type will also be defined: boot from SAN or boot from SCSI disk. For example, rootvg should be mirrored when using SCSI disks, or if using SDDPCM and DS8300 disk (SAN boot MPIO), then rootvg will not be mirrored.

12. Network settings. For example, hardcode speed and duplex (where appropriate), use DNS (/etc/resolv.conf, /etc/netscv.conf). The resolv.conf is contained within the image so we do not need to use a resolv\_conf NIM resource).
13. Security settings (site-specific); for example, user attributes, password attributes, disabling unnecessary users and groups, disabling unnecessary services (telnet, ftp, sendmail, and so on).
14. Standard/required users and groups. Login herald.
15. Root account settings and restrictions. For example, no direct login; only via console (*rlogin=false*); use of sudo; allow only system administrators that are part of the system group to *su* to root.
16. Common set of system services and tools on all systems; for example: *OpenSSH, OpenSSL, lsof, nmon, topas, sudo, pstree, tcsh, vim, logrotate, websm, nimsh, TSM client*, and so on.
17. Backup strategy for all AIX systems. For example, **sysbtonim** and **skelvg** scripts to perform mksysb to NIM master and backup data volume group structure; TSM client used to back up the entire system.
18. Local custom scripts for administration tasks; for example, backup, nmon data collection, and so on. These scripts would typically reside in /usr/local/bin (a separate file system, /usr/local, would be created for this purpose).
19. Standard crontab entries for root user.
20. Standard for /etc/rc.local. Any local startup scripts should be placed in rc.local and an entry created in inittab for rlocal.
21. AIX error report and SMIT log management. For example, to retain any information in the AIX error report and the SMIT logs, you could run some scripts to redirect or copy the information to a file for later reference. The following simple scripts are examples only, as shown in Example 5-91.

*Example 5-91 Sample AIX error report and SMIT log cleanup scripts*

---

```
clean_errpt.ksh:
thedata=`date +%d%b%Y`
varerr=/var/log/errpt
errnm=errpt
errpt >> $varerr/$errnm.$thedata
errpt -a >> $varerr/$errnm.$thedata
echo "Written $varerr/$errnm.$thedata"
errclear 0
echo "Cleared Error Report."
```

```
clean_smit.ksh:
thedata=`date +%d%b%Y`
```

```

varsmitt=/var/log/smit
cp -p /smit.log $varsmitt/smit.log.$thedate
cp -p /smit.script $varsmitt/smit.script.$thedate
cp -p /smit.transaction $varsmitt/smit.transaction.$thedate
echo "Written $varsmitt/smit.log.$thedate"
echo "Written $varsmitt/smit.script.$thedate"
echo "Written $varsmitt/smit.transaction.$thedate"
>/smit.log
>/smit.script
>/smit.transaction
echo "Cleared SMIT log."

/var/log/errpt/clean_errpt.ksh
Written /var/log/errpt/errpt.27Jun2006
Cleared Error Report.

/var/log/smit/clean_smit.ksh
Written /var/log/smit/smit.log.27Jun2006
Written /var/log/smit/smit.script.27Jun2006
Written /var/log/smit/smit.transaction.27Jun2006
Cleared SMIT log.

```

---

22. Setup for AIX systems within a DMZ; for example, special network tuning options required to secure AIX network connections. If the system is within a DMZ, then there may be VLAN restrictions imposed upon the system that may impact its ability to be administered via NIM. Refer to 5.3, “NIMSH, OpenSSL and firewall considerations” on page 424 for more details about this topic.

If you have a requirement to only administer a DMZ system infrequently, then you can consider using a “floating network adapter” for installs and temporary administration work. For example, assuming the system is an LPAR, you could configure and cable a network adapter on the managed system that is connected to your administration VLAN. When you need to perform a task on the DMZ LPAR, you can use DLPAR to assign the adapter, configure it and then perform the task. When the task is finished you could then unconfigure it and unassign it from the DMZ system.

Another consideration is how to create a mksysb backup of the client to the NIM master from the DMZ. One way is via scp. You can write a small script to perform a mksysb to a local file system, and then use scp (secure copy) to copy the image to the NIM master. A sample script (**sysbtofs**) is provided in Appendix D, “Additional material” on page 643.

23. Steps to verify and hand over an AIX system; for example, SOE verification and system peer review and Quality Assurance would be performed prior to application installation. Custom scripts can be used to perform this task.

24. Documenting the system configuration; for example, a system support pack would be created that outlined how the system was configured and why.
25. Administration tasks. Where possible, all systems should be administered from the NIM master. Tasks such as software maintenance can be performed with NIM quickly and efficiently (refer to 5.7, “System maintenance for NIM clients” on page 478 for more information about this topic).

Also, commands such as **dsh/dcp** (CSM tools) make administration easier because they will allow you to run commands on many systems at once. CSM is capable of much more in terms of administering your systems; for details refer to 6.1, “Overview of Cluster Systems Management” on page 560.

It is possible to install the `csm.dsh` fileset and run the **dsh/dcp** commands but it is not supported. If you do not have CSM within in your environment but would like a dsh-like command, one alternative is `pdsh` (Public Domain Korn Shell):

<http://www.llnl.gov/linux/pdsh/pdsh.html>

### The purpose of the SOE image

In order to maintain a consistent image across all your AIX systems, an SOE `mksysb` image is created. This `mksysb` image contains the following:

- ▶ A standard set of AIX filesets such as `bos.net*`, `devices.fcp*` and much more.
- ▶ A standard set of AIX tools and utilities. These may be open source tools or those provided by IBM such as `topas`, `lparstat`, `mpstat`, `nmon`, `lsf`, and others.
- ▶ Preferred kernel and device support such as 64-bit, `jfs` file systems for `rootvg`, and so on.
- ▶ Standard user accounts, for example, for system administrators.
- ▶ Scripts for system administration.
- ▶ Backup tools, for example, TSM client.

To keep the SOE image as clean and as small as possible, `rootvg` only contains AIX operating system-related software and tools. Applications, databases and other software are never installed into `rootvg`.

A separate volume group is created for any additional (non-standard) software outside of the SOE. This will keep `rootvg` and the `mksysb` small, and helps to reduce the time required to install and restore the image and manage the root volume group.

## How an SOE image is created

The SOE image is created by a base install of AIX, which is then customized and a mksysb image created. If you want to create an SOE image, first install AIX 5L V5.3 (via NIM rte install) onto a test system. When performing the installation, ensure that you have selected the desired configuration for your SOE image (that is, kernel type, TCB on or off, all kernel/device support yes or no, language, and other AIX OS filesets).

All devices on this system should be unconfigured (for example, no network settings). After AIX has been installed, then install all of the tools and utilities you would like to include in your SOE image, create any file systems you need (for example, /usr/local), and add scripts and configuration files required, and so on.

When the system is fully configured to your SOE design, perform a mksysb of the system to a local file system. For example, create a /mksysb file system within rootvg and perform a mksysb to it (`# mksysb -i /mksysb/soe_image_mksysb`). After you have a “gold” image of your SOE, you can configure IP on this system and transfer it to your NIM master’s mksysb directory (/export/images) ready for installation.

To update your SOE in the future, if you need to add, change or remove any of its components, you can use the same procedure as described. But instead of installing base AIX, you would install your SOE image onto an unconfigured test system, perform the updates, and then create a new mksysb image as before.

An alternative way to update your SOE is by assigning an LUN as your SOE disk. This disk can be assigned to an LPAR. You install the SOE onto this disk and then perform your updates. This LUN could be permanently assigned to a small micro-partition “SOE server” using virtual I/O (VIO) devices. You would install the VIO client using your SOE image and then perform the updates.

Another way of easily deploying your SOE is via `alt_disk_install`. If you have a spare disk within your pSeries environment, either an internal SCSI disk or a small LUN on your SAN disk device (for example, ESS800, DS8300) you can use this disk to update your SOE quickly. For example, you could install your SOE image onto a system that boots from SAN disk. This SOE LUN could be assigned temporarily to any test system that you will use for the SOE update. You then perform any updates required to your SOE image.

After the system is up and running, you could assign another LUN (Clone LUN) and use `alt_disk_install` to clone the disk. The LUN could be unassigned from the SOE server and then assigned to the new LPAR you are attempting to install. The new LPAR can boot from this disk and would then be running the SOE image. Refer to 5.6, “Using SAN zoning for cloning LPARs” on page 475 for more detailed information about this topic.



It is important to keep your `lpp_source` and SPOT up-to-date, and to have all the available device and kernel support within these resources. If you have several types of System p hardware (p660, p650, p690, p570, p595, and so on) within the environment where you intend to install your SOE, you need to ensure that all required device (and other) filesets be in the `lpp_source` for the SOE to be installed on many types of pSeries hardware. Refer to 5.5, “Using NIM to migrate systems to new hardware” on page 460 for further information.

## Using NIM to install and manage the SOE environment

After the SOE image is created, it can be used to install new systems with standard NIM cloning techniques (refer to 5.4, “Cloning NIM clients using `mksysb`” on page 451). However, a standard set of procedures for creating and installing the client will exist in an SOE environment. Hostnames and `mksysb` images will be named according to this standards.

In larger AIX environments that need to install multiple clients at once, the `nimdefs` command will be used to predefine all the NIM clients that need to be created. Once created, the clients are then installed at the same time via a NIM `bos_int` operation on a NIM machine group.

**Note:** An example of a `nimdef` stanza file is located in `/usr/samples/nim/client.defs`.

What follows is a short example of using the `nimdefs` command to quickly define six new NIM clients to our NIM environment. Having an SOE in place makes this process simple, because we already know what the hostnames will be and which network (VLAN) to use.

The `client.defs` file begins with some default values for our environment, such as the machine type, subnet mask, gateway, platform (`chrp`), kernel type (`mp`) and the machine group for the new clients.

The NIM client definitions follow next and contain the network type, cable type and a comment. We could have included just the comment because the network type and cable type are already defined in the default stanza. We are defining six clients, `uataix01nim` through to `uataix06nim`.

The NIM master’s `/etc/hosts` file is updated with the IP addresses of the new NIM clients:

```
10.1.1.91 uataix01nim
10.1.1.92 uataix02nim
10.1.1.93 uataix03nim
10.1.1.94 uataix04nim
10.1.1.95 uataix05nim
```

10.1.1.96      uataix06nim

We update our `/export/etc/client.defs` file with the new client definitions, as shown in Example 5-92.

*Example 5-92 Updating the `/export/etc/client.defs` file*

---

```
cat /export/etc/client.defs
set default values
default:
 machine_type = standalone
 subnet_mask = 255.255.255.0
 gateway = 10.1.1.1
 network_type = ent
 cable_type = tp
 platform = chrp
 netboot_kernel = mp
 machine_group = nimgrp1

Define uataix01, uataix02, uataix03, uataix04, uataix05, uataix06
uataix01nim:
 network_type = ent
 cable_type = tp
 comment = "Test AIX LPAR number 1"

uataix02nim:
 network_type = ent
 cable_type = tp
 comment = "Test AIX LPAR number 2"

uataix03nim:
 network_type = ent
 cable_type = tp
 comment = "Test AIX LPAR number 3"

uataix04nim:
 network_type = ent
 cable_type = tp
 comment = "Test AIX LPAR number 4"

uataix05nim:
 network_type = ent
 cable_type = tp
 comment = "Test AIX LPAR number 5"

uataix06nim:
 network_type = ent
 cable_type = tp
```

```
comment = "Test AIX LPAR number 6"
```

---

Creating the client.defs file can also be streamlined by writing a small script to generate a client.defs based on a list of new NIM client names. For example, the script in Example 5-93 will create a new client.defs file in /export/etc/client.defs based on the list of NIM client names in the file /export/etc/newclients.list.

*Example 5-93 Automating the creation of the client.defs file*

---

```
cat /export/scripts/cr_cldef
#!/usr/bin/ksh
#
Script to create a new client.def file based on newclients.list file.
#

client=$(</export/etc/newclients.list)

if ["$client" = ""] ; then
 echo "Please add new clients to /export/etc/newclients.list e.g.
 uataix01nim
 uataix02nim
 etc.....
 "
 exit 1
fi

echo '
set default values
default:
 machine_type = standalone
 subnet_mask = 255.255.255.0
 gateway = 10.1.1.1
 network_type = ent
 cable_type = tp
 platform = chrp
 netboot_kernel = mp
 machine_group = nimgrp1
' > /export/etc/client.defs

for i in $client
do
echo "
$i:
 comment = 'NIM client $i'
" >> /export/etc/client.defs
done

cat /export/etc/newclients.list
```

```

uataix07nim
uataix08nim

/export/scripts/cr_cldef

cat /export/etc/client.defs
set default values
default:
 machine_type = standalone
 subnet_mask = 255.255.255.0
 gateway = 10.1.1.1
 network_type = ent
 cable_type = tp
 platform = chrp
 netboot_kernel = mp
 machine_group = nimgrp1

uataix07nim:
 comment = 'NIM client uataix07nim'

uataix08nim:
 comment = 'NIM client uataix08nim'

```

---

Next, we run the **nimdef** command to preview the client definition file, and also to create a script that we can run to perform the actual creation of the NIM client definitions, as shown in Example 5-94.

*Example 5-94 Running the nimdef command*

---

```

nimdef -p -f client.defs > /export/scripts/mkcldef
cat /export/scripts/mkcldef
6 machine definitions are complete. The following machines will be
added to the NIM environment:

uataix01nim:
 hostname=uataix01nim
 gateway=10.1.1.1
 subnet_mask=255.255.255.0
 network_type=ent
 cable_type=tp
 machine_type=standalone
 platform=chrp
 hostaddr=10.1.1.91
 netaddr=10.1.1.0
 netboot_kernel=mp
 groupname=nimgrp1
uataix02nim:

```

```
hostname=uataix02nim
gateway=10.1.1.1
subnet_mask=255.255.255.0
network_type=ent
cable_type=tp
machine_type=standalone
platform=chrp
hostaddr=10.1.1.92
netaddr=10.1.1.0
netboot_kernel=mp
groupname=nimgrp1
uataix03nim:
hostname=uataix03nim
gateway=10.1.1.1
subnet_mask=255.255.255.0
network_type=ent
cable_type=tp
machine_type=standalone
platform=chrp
hostaddr=10.1.1.93
netaddr=10.1.1.0
netboot_kernel=mp
groupname=nimgrp1
uataix04nim:
hostname=uataix04nim
gateway=10.1.1.1
subnet_mask=255.255.255.0
network_type=ent
cable_type=tp
machine_type=standalone
platform=chrp
hostaddr=10.1.1.94
netaddr=10.1.1.0
netboot_kernel=mp
groupname=nimgrp1
uataix05nim:
hostname=uataix05nim
gateway=10.1.1.1
subnet_mask=255.255.255.0
network_type=ent
cable_type=tp
machine_type=standalone
platform=chrp
hostaddr=10.1.1.95
netaddr=10.1.1.0
netboot_kernel=mp
groupname=nimgrp1
uataix06nim:
hostname=uataix06nim
```

```
gateway=10.1.1.1
subnet_mask=255.255.255.0
network_type=ent
cable_type=tp
machine_type=standalone
platform=chrp
hostaddr=10.1.1.96
netaddr=10.1.1.0
netboot_kernel=mp
groupname=nimgrp1
```

1 machine group will be created with new members.

```
nimgrp1:
 machine_type=standalone
 member=uataix01nim
 member=uataix02nim
 member=uataix03nim
 member=uataix04nim
 member=uataix05nim
 member=uataix06nim
```

1 network in the NIM environment will have new machine interfaces added.

```
NET1:
 network_type=ent
 address=10.1.1.0
 subnet=255.255.255.0
 hostname=uataix01nim
 hostname=uataix02nim
 hostname=uataix03nim
 hostname=uataix04nim
 hostname=uataix05nim
 hostname=uataix06nim
```

#### Summary

6 Machines will be added to the NIM environment.  
1 Machine group will be created with new members.  
1 Network will have new NIM machine interfaces added.

```
#####
#
Commands to define new machines in the NIM environment.
#
#####
```

```
nim -o define -t standalone -a if1="find_net uataix01nim 0 ent" -a
cable_type1=tp -a net_definition="ent 255.255.255.0 10.1.1.1 " -a
netboot_kernel=mp -a platform=chrp uataix01nim
```

```
nim -o define -t standalone -a if1="find_net uataix02nim 0 ent" -a
cable_type1=tp -a net_definition="ent 255.255.255.0 10.1.1.1 " -a
netboot_kernel=mp -a platform=chrp uataix02nim
```

```
nim -o define -t standalone -a if1="find_net uataix03nim 0 ent" -a
cable_type1=tp -a net_definition="ent 255.255.255.0 10.1.1.1 " -a
netboot_kernel=mp -a platform=chrp uataix03nim
```

```
nim -o define -t standalone -a if1="find_net uataix04nim 0 ent" -a
cable_type1=tp -a net_definition="ent 255.255.255.0 10.1.1.1 " -a
netboot_kernel=mp -a platform=chrp uataix04nim
```

```
nim -o define -t standalone -a if1="find_net uataix05nim 0 ent" -a
cable_type1=tp -a net_definition="ent 255.255.255.0 10.1.1.1 " -a
netboot_kernel=mp -a platform=chrp uataix05nim
```

```
nim -o define -t standalone -a if1="find_net uataix06nim 0 ent" -a
cable_type1=tp -a net_definition="ent 255.255.255.0 10.1.1.1 " -a
netboot_kernel=mp -a platform=chrp uataix06nim
```

```
#####
#
Commands to define new groups and members in the NIM environment.
#
#####
nim -o define -t mac_group -a add_member=uataix01nim -a add_member=uataix02nim
-a add_member=uataix03nim -a add_member=uataix04nim -a add_member=uataix05nim
-a add_member=uataix06nim nimgrp1
```

---

We can now run the `mkcldef` script to define the clients. We remove everything except the lines that contain the commands to define the clients and machine groups, as shown in Example 5-95.

*Example 5-95 Defining the machines in the new environment*

---

```
#####
#
Commands to define new machines in the NIM environment.
#
#####
nim -o define -t standalone -a if1="find_net uataix01nim 0 ent" -a
cable_type1=tp -a net_definition="ent 255.255.255.0 10.1.1
.1 " -a netboot_kernel=mp -a platform=chrp uataix01nim
```

```

nim -o define -t standalone -a if1="find_net uataix02nim 0 ent" -a
cable_type1=tp -a net_definition="ent 255.255.255.0 10.1.1
.1 " -a netboot_kernel=mp -a platform=chrp uataix02nim

nim -o define -t standalone -a if1="find_net uataix03nim 0 ent" -a
cable_type1=tp -a net_definition="ent 255.255.255.0 10.1.1
.1 " -a netboot_kernel=mp -a platform=chrp uataix03nim

nim -o define -t standalone -a if1="find_net uataix04nim 0 ent" -a
cable_type1=tp -a net_definition="ent 255.255.255.0 10.1.1
.1 " -a netboot_kernel=mp -a platform=chrp uataix04nim

nim -o define -t standalone -a if1="find_net uataix05nim 0 ent" -a
cable_type1=tp -a net_definition="ent 255.255.255.0 10.1.1
.1 " -a netboot_kernel=mp -a platform=chrp uataix05nim

nim -o define -t standalone -a if1="find_net uataix06nim 0 ent" -a
cable_type1=tp -a net_definition="ent 255.255.255.0 10.1.1
.1 " -a netboot_kernel=mp -a platform=chrp uataix06nim

#####
#
Commands to add new members to existing groups in the NIM environment.
#
#####
nim -o change -a add_member=uataix01nim -a add_member=uataix02nim -a
add_member=uataix03nim -a add_member=uataix04nim -a add_
member=uataix05nim -a add_member=uataix06nim nimgrp1

ksh /export/scripts/mkcldef

```

---

Our six new NIM clients are now defined:

```

lsnim -t standalone
uataix01nim machines standalone
uataix02nim machines standalone
uataix03nim machines standalone
uataix04nim machines standalone
uataix05nim machines standalone
uataix06nim machines standalone

```

To automate the SOE installation process, a custom bosinst.data and first boot script resource is created to support an unattended installation and automatic customization of the system.



**Note:** A template for the bosinst.data file is located in the /usr/lpp/bosinst/bosinst.template file. For more information about the stanzas in this file, see /usr/lpp/bosinst/bosinst.template.README.

A NIM bosinst\_data resource is created for the SOE bosinst.data:

```
lsnim -t bosinst_data
soe_bosinst_data resources bosinst_data

lsnim -l soe_bosinst_data
soe_bosinst_data:
 class = resources
 type = bosinst_data
 Rstate = ready for use
 prev_state = unavailable for use
 location = /export/etc/soe.bosinst.data
 alloc_count = 1
 server = master
```

In particular, the following entries will be changed in the bosinst.data file, as shown in Example 5-96.

*Example 5-96 Example SOE bosinst.data customizations*

---

```
INSTALL_METHOD = overwrite
PROMPT = no
EXISTING_SYSTEM_OVERWRITE = yes
TCB = yes
RECOVER_DEVICES = no
ACCEPT_LICENSES = yes
ALL_DEVICES_KERNELS = no
ENABLE_64BIT_KERNEL = yes
ALT_DISK_INSTALL_BUNDLE = yes
```

```
locale:
BOSINST_LANG = en_US
CULTURAL_CONVENTION = en_US
MESSAGES = en_US
KEYBOARD = en_US
```

```
target_disk_data:
HDISKNAME = hdisk0
```

---

If you need to install the SOE image onto several different LPARs on several different managed systems, you may find it more convenient to use a single NIM client definition for the mksysb install. For example, you may create a new NIM

client definition named `uataxinst`, which is used only for installing the SOE on several LPARs.

**Note:** If you plan to use a single NIM client to install many systems, consider disabling CPU ID validation on the NIM master. Refer to 4.5, “NIM mksysb migration and `nim_move_up` POWER5 tools” on page 205 and 4.6, “NIM alternate disk migration” on page 261, for more information about Managing client CPU ID validation.

A first boot script is also used to perform any additional customization required upon the client’s first boot (for example, setting the hostname, configuring additional adapters, changing network settings, modifying `.profile/.kshrc` files, and so on). This is generally not required because the SOE is already heavily customized for all of these, but there may be circumstances where it is required when the SOE must change to meet a new requirement. Refer to 5.8, “Automatic scripts” on page 504 for more information on scripting NIM automation.

The BOS installation process adds the content of the `fb_script` resource to the `/etc/firstboot` file, which is run the first time that a client is booted (`fbcheck` from `inittab`). See Example 5-97 for a sample first boot script (`fbscript`) NIM resource.

*Example 5-97 Sample first boot script*

---

```
lsnim -l soe_fbscript
soe_fbscript:
 class = resources
 type = fb_script
 Rstate = ready for use
 prev_state = unavailable for use
 location = /export/scripts/soe_fbscript.ksh
 alloc_count = 1
 server = master
```

---

When installing the SOE onto a new LPAR, we use the following NIM resources:

- ▶ An AIX 5L V5.3 `lpp_source`: `LPP_53_ML4`.
- ▶ An AIX 5L V5.3 `SPOT` resource: `SPOT_53_ML4`.
- ▶ An SOE first boot script resource: `soe_fbscript`.
- ▶ The SOE `mksysb` image resource: `soe_mksysb`
- ▶ The SOE `bosinst_data` resource: `soe_bosinst_data`

To install the SOE image onto all clients in the `nimgrp1` machine group, we would perform the following:

```
nim -o bos_inst -a source=mksysb -a spot=SPOT_53_ML4 -a \
lpp_source=LPP_53_ML4 -a mksysb=soe_mksysb -a \
bosinst_data=soe_bosinst_data -a fb_script=soe_fbscript -a \
```

```
accept_licenses=yes -a installp_flags=-acNgX -a no_client_boot=yes \ -a
preserve_res=yes nimgrp1
```

After the SOE mksysb installation is complete, there is little left to do (in terms of AIX installation and configuration), except to verify that the install completed successfully and that the system conforms to our SOE design. At the end of the firstboot script, we ran a script on the system after the installation. This script checks the system against our predefined SOE configuration and reports on anything that may be different from what we expect to find in our SOE image.

Before installing any applications on the system, we recommend that you have the build reviewed by another technical resource to check for any oversights in the system's configuration. If everything is OK, then the system's current configuration should be documented. The new AIX system is now ready for use.

In summary, using NIM and our SOE image allows us to ensure that:

- ▶ All of our AIX installations are consistent and adhere to standards set out for our environment.
- ▶ That the time-consuming and tedious post-operating system installation tasks are reduced significantly (if not removed altogether).

NIM (and the SOE image) reduced the administration and management overhead associated with installing and then customizing an AIX system.

## 5.10 Backing up and reinstalling a NIM master

In this section, we present three methods (described in scenarios) for backing up and restoring a NIM master with as little effort and as automatically as possible.

Keeping an up-to-date image of your NIM master machine or NIM master machines is an important task that a NIM administrator should perform, for several reasons. For example, it helps to protect your NIM environment in case of a hardware or software failure, or when you are using several complex NIM environments with several NIM master machines.

For two of the three methods, we use a mksysb tape already created. For the third method, we use NIM.

**Note:** For detailed information about how to create and install system backups, refer to *AIX 5L Version 5.3: Installation Guide and Reference*, SC23-4887.

### 5.10.1 Scenario 1: Back up and restore a NIM master on the same machine using a tape

As a starting point, we assume we have a mksysb tape of our NIM master. The file `bosinst.data`, which is included into the mksysb image, must have the parameter `RECOVER_DEVICES = yes`, as shown in Example 5-98. This parameter is used to specify whether the devices will be recreated as they were on the source system. Practically, this avoids having to reconfigure the network adapter.

*Example 5-98 The `bosinst.data` file with `RECOVER_DEVICES` value*

---

```
control_flow:
 CONSOLE = /dev/lft0
 INSTALL_METHOD = overwrite
 PROMPT = no
 EXISTING_SYSTEM_OVERWRITE = yes
 SWITCH_TO_PRODUCT_TAPE =
 RECOVER_DEVICES = yes
 BOSINST_DEBUG = no
 ACCEPT_LICENSES = yes

target_disk_data:
 PVID = 00554d4ab6bb3366
 PHYSICAL_LOCATION = U0.1-P2/Z1-A8
 CONNECTION = scsi0//8,0
 LOCATION = 1S-08-00-8,0
 SIZE_MB = 17357
 HDISKNAME = hdisk0

locale:
 BOSINST_LANG = en_US
 CULTURAL_CONVENTION = en_US
 MESSAGES = en_US
 KEYBOARD = en_US
```

---

There is no particular difficulty in performing this task: to initiate mksysb restore, go into SMS mode and select the appropriate boot device (in this case, the tape).

### 5.10.2 Scenario 2: Back up and restore a NIM master on a different machine using a tape

The starting point is the same as for the Scenario 1: we assume we have a mksysb tape of our NIM master. This image contains the same `bosinst.data` file as shown in Example 5-98.

The target machine is different (hardware configuration) than the source machine, thus some additional work must be done after the installation itself:

1. Change network definition.
2. Change the hostname of the new master stored into the NIM database and the related hardware address.

**Note:** If the machine we want to reinstall does not have the same hardware as the one which served to create the mksysb image, we need to use CDs to boot properly.

There is no specific additional work compared to the restore of a standard mksysb. We need to follow the basic steps:

1. Go to SMS mode.
2. Select the right device you want to boot from (either a tape or a CD) depending on whether the target machine has the same hardware or not as the source machine.
3. Follow the menus to restore from tape.

After the machine has rebooted, two actions must be taken: change the network definition and master hostname, and save its related hardware address into the NIM database.

To perform the first step (Network definition change), run the following command:

```
/usr/sbin/mktcpip -h'cev223' -a'129.1.2.23' -m'255.255.255.0'
-i'en0' -A'no' -t'N/A'
```

where:

- ▶ cev223 is the new hostname.
- ▶ 129.1.2.23 is the new IP address.
- ▶ 255.255.255.0 is the new mask.
- ▶ en0 is the interface name.

A best practice is to check the result of the work. We suggest running the following command:

```
netstat -in
```

Example 5-99 gives the output of the **netstat** command. This output also gives the hardware address (0002554F2693, in our case) used in the second step.

*Example 5-99 Output of netstat -in command*

---

```
{cev223}:/ #netstat -in
Name Mtu Network Address Ipkts Ierrs Opkts Oerrs Coll
en0 1500 link#2 0.2.55.4f.26.93 884 0 562 0 0
```

```

en0 1500 129.1.2 129.1.2.23 884 0 562 0 0
lo0 16896 link#1 4148 0 4149 0 0
lo0 16896 127 127.0.0.1 4148 0 4149 0 0
lo0 16896 ::1 4148 0 4149 0 0
{cev223}:/ #

```

---

To perform the second step (NIM master hostname and hardware address changes), we use SMIT by running the command:

```
smitty nim
```

Select the following sub-panels in order:

- ▶ Perform NIM Administration Tasks
- ▶ Manage Machines
- ▶ Change/Show Characteristics of a Machine
- ▶ Chose master

After these choices are made, the SMIT menu shown in Example 5-100 is launched. Change the HostName value and the Network Adapter Hardware Address by the appropriate values, then press Enter for execution.

*Example 5-100 SMIT panel to change master hostname and hardware address*

---

```

Change/Show Characteristics of a Machine

Type or select values in entry fields.
Press Enter AFTER making all desired changes.

[TOP] [Entry Fields]
Machine Name [master]
* Hardware Platform Type [chrp] +
* Kernel to use for Network Boot [mp] +
Machine Type master
Network Install Machine State currently running
Network Install Control State ready for a NIM opera>
Primary Network Install Interface
Network Name NET_ENO
Host Name [cev223]
Network Adapter Hardware Address [0002554F2693]
Network Adapter Logical Device Name [ent]
Cable Type N/A +
Network Speed Setting [] +
[MORE...7]

```

---

A best practice is to check the result of the work by running the following command:

```
lslnim -l master
```

Example 5-101 gives the output of the `lslnim` command.

*Example 5-101 Output of `lslnim -l mster` command*

---

```
{cev223}:/ #lslnim -l master
master:
 class = machines
 type = master
 max_nimesis_threads = 20
 comments = machine which controls the NIM environment
 platform = chrp
 netboot_kernel = mp
 if1 = NET_ENO cev223 0002554F2693
 cable_type1 = N/A
 Cstate = ready for a NIM operation
 prev_state = ready for a NIM operation
 Mstate = currently running
 serves = BID_NP_HDO
 serves = LPP_53_ML3
 serves = SPOT_53_ML3
 serves = boot
 serves = nim_script
 master_port = 1058
 registration_port = 1059
 reserved = yes
{cev223}:/ #
```

---

### 5.10.3 Scenario 3: Back up and restore a NIM master using another NIM master

Basically, even if a `mksysb` image of one NIM master is available, when restoring it using NIM, this machine becomes a simple client. In effect, several specific and important NIM scripts are used in the network boot process. One of them is:

```
/SPOT/usr/lpp/bos.sysmgt/nim/methods/c_mk_nimclient
```

This is used if `no_nim_client=no`, or is not specified. If it is set to `yes`, then this script does not get called. This variable tells the NIM master if the currently installed machine is going to remain (or not) a NIM client to that master after install.

The script performs the following tasks:

- ▶ It will install bos.sysmgmt.nim.client and bos.net\*.client.
- ▶ It will deinstall the bos.sysmgmt.nim.master if it is present.
- ▶ It invokes mktcpip to configure the network on the installed machine.
- ▶ It populates the new /etc/hosts file with values from the \$NIM\_HOSTS from /etc/niminfo (created by \$NIM\_BOSINST-RECOVER in the previous bi\_main step).
- ▶ It adds routes as specified in \$ROUTES from /etc/niminfo.

In most cases, we want this machine be part of our NIM environment after the installation. Thus, the value of no\_nim\_client must be to no. This is done when you start an operation on the client. Example 5-102 shows the appropriate SMIT panel.

*Example 5-102 Start an operation on a NIM client*

---

Install the Base Operating System on Standalone Clients

Type or select values in entry fields.  
Press Enter AFTER making all desired changes.

|                                                |                            |   |
|------------------------------------------------|----------------------------|---|
| [MORE...1]                                     | [Entry Fields]             |   |
| * Installation TYPE                            | mksysb                     |   |
| * SPOT                                         | SPOT_53_ML4                |   |
| LPP_SOURCE                                     | <input type="checkbox"/>   | + |
| MKSYSB                                         | MK_MST_53ML4               |   |
| BOSINST_DATA to use during installation        | <input type="checkbox"/> + |   |
| IMAGE_DATA to use during installation          | <input type="checkbox"/>   | + |
| RESOLV_CONF to use for network configuration   | <input type="checkbox"/>   | + |
| Customization SCRIPT to run after installation | <input type="checkbox"/>   | + |
| Customization FB Script to run at first reboot | <input type="checkbox"/>   | + |
| ACCEPT new license agreements?                 | [no]                       | + |
| <b>Remain NIM client after install?</b>        | <b>[yes]</b>               | + |
| PRESERVE NIM definitions for resources on      | [yes]                      | + |
| [MORE...35]                                    |                            |   |

---

Thus, after the installation is finished, this machine has all the information needed to be reconfigured as a NIM master, but is not used. What are the three things that are missing to have this machine back as a NIM master?

- ▶ Installation of nim.master fileset, because this fileset has been uninstalled through the script:  
/SPOT/usr/lpp/bos.sysmgmt/nim/methods/c\_mk\_nimclient
- ▶ NIM database restoration



► Modification of the hostname and the hardware address

To revert this machine into a NIM master we use a `fb_script` resource to run the necessary commands, as shown in Example 5-103.

*Example 5-103 Script to reconfigure the machine as a NIM master*

---

```
{nimmast}:/JMB/scripts # cat nimmast.script
#!/bin/ksh
JM BERAIL June, 15th 2006
#
PHASE 1: Installation of nim.master fileset from the lpp_source
included into the mksysb image
#

/usr/lib/instl/sm_inst installp_cmd -a -Q -d '/AIX53ML4/LPP_53_ML4' -f '+
5.3.0.40 Network Install Manager - Master Tools
@@S:bos.sysmgt.nim.master 5.3.0.40' '-c' '-N' '-g' '-X' '-G'

#
PHASE 2: NIM database restoration
#
A NIM database backup has been made before the mksysb creation
and it has been included onto the mksysb image.
In our case, the NIM database backup file name is
nimdb.backup.15jun06
and it is located into the /tmp directory
#

/usr/lpp/bos.sysmgt/nim/methods/m_restore_db /tmp/nimdb.backup.15jun06

#
PHASE 3: Modification of the hostname related to the master.
Because the mksysb restoration can occur on a different
machine
than the one that has been used for the mksysb creation,
we need to be sure that the hostname of the master machine
stored
onto the NIM database is the same than the hostname of the
machine used for the restauration. To fix this problem,
we need to run the nim -o change command with the appropriate
parameters.
#

typeset -R12 MAC
```

```
MAC=$(lscfg -vl $(netstat -i | grep $(uname -n) | awk '{print $1}' | sed
-e 's/en/ent/') | grep 'Network Address')

nim -o change -a if1=NET_ENO $(uname -n) $MAC" -a platform=chrp \
-a netboot_kernel=mp master

#
PHASE 4: Reboot the machine
#

/usr/bin/sleep 30
/usr/sbin/shutdown -Fr
```

---

**Note:** The values shown in bold font in the figure (such as the `lpp_source` name directory, the backup file name of the NIM database, and the network class name) must be adapted to your environment.

## 5.10.4 Changing the NIM master hostname

In order to change the hostname for the NIM master, follow these steps. They are explained in more detail throughout the section.

1. Update the name resolution (for the NIM master and the NIM clients), keeping the old names.
2. Change the hostname on the NIM database.
3. Remove the old name from name resolution.

### Scenario

Here we use two machines, configuring one as a NIM master and the other as a NIM client. The NIM master name is changed and the change is reflected to the NIM client.

### Updating name resolution

Name resolution must be updated for the NIM master and the NIM client. The old name must be kept in order to be able to communicate to the NIM clients to update the `/etc/niminfo` files with the new name.

**Note:** If `/etc/hosts` is being used for the name resolution, the new name for the NIM master on the NIM client has to be added at the end of the corresponding entry. Using a different order may cause the update from the NIM master to fail.

In our scenario, the NIM master name is lpar2. Example 5-104 shows the output for the `lsnim` command. The value for `if1` shows that the hostname on the NIM database is lpar2.

*Example 5-104 Host name on the NIM database*

---

```
(root@lpar2):/ # lsnim -l master
master:
 class = machines
 type = master
 max_nimesis_threads = 20
 if_defined = chrp.mp.ent
 comments = machine which controls the NIM environment
 platform = chrp
 netboot_kernel = mp
 if1 = NET_EN1 lpar2 00096B4EAD9C
 cable_type1 = N/A
 Cstate = ready for a NIM operation
 prev_state = ready for a NIM operation
 Mstate = currently running
 serves = LPP_PRUEBA
 serves = SEC_ADAPTR
 serves = boot
 serves = nim_script
 master_port = 1058
 registration_port = 1059
 reserved = yes
 ssl_support = yes
```

---

The new name for the NIM master is nimmast. Example 5-105 shows how the name resolution is updated for the NIM master.

*Example 5-105 /etc/hosts on NIM master*

---

```
(root@lpar2):/ # cat /etc/hosts
.....
10.1.1.22 lpar2 nimmast
.....
```

---

Example 5-106 shows how the name resolution is updated for the NIM client.

*Example 5-106 /etc/hosts on NIM client*

---

```
more /etc/hosts
.....
10.1.1.22 lpar2 nimmast
.....
```

---

Example 5-107 shows the contents of the /etc/niminfo file for the NIM client. Check that the value for NIM\_MASTER\_HOSTNAME is lpar2.

*Example 5-107 /etc/niminfo on the NIM client*

---

```
cat /etc/niminfo
#----- Network Install Manager -----
warning - this file contains NIM configuration information
and should only be updated by NIM
export NIM_NAME=VLPAR3_p5
export NIM_HOSTNAME=v1par3_p5
export NIM_CONFIGURATION=standalone
export NIM_MASTER_HOSTNAME=lpar2
export NIM_MASTER_PORT=1058
export NIM_REGISTRATION_PORT=1059
export NIM_SHELL="shell"
export NIM_BOS_IMAGE=/SPOT/usr/sys/inst.images/installp/ppc/bos
export NIM_BOS_FORMAT=rte
export NIM_HOSTS=" 10.1.1.70:v1par3_p5 10.1.1.22:lpar2 "
export NIM_MOUNTS=""
export ROUTES=" default:0:10.1.1.1 "
```

---

## Changing the hostname in the NIM database

This task changes the hostname on the NIM database and reflects the change on the NIM client's configuration.

To perform the change, follow these steps:

1. Type the `smitty nim_ch_if1` fastpath on the NIM master.
2. Select the proper values for the SMIT panel. If there is an existing NIM network referring to the hostname that is being changed, choose it in order to reflect the changes.

Example 5-108 shows the panel and values used to change the hostname for the NIM master on the database.

*Example 5-108 Changing the hostname using smit*

---

New Host Information (Optional)

|                           |           |   |
|---------------------------|-----------|---|
| New Host Name             | [nimmast] |   |
| New Cable Type            | []        | + |
| New Network Information   |           |   |
| Existing NIM Network Name | [NET_EN1] | + |
| -OR-                      |           |   |
| New NIM Network Type      | []        | + |

|                                 |    |
|---------------------------------|----|
| New NIM Network Name            | [] |
| New NIM Network Address         | [] |
| New NIM Network Subnet Mask     | [] |
| New NIM Network Default Gateway | [] |

---

The output for the operation is shown in Example 5-109 showing that the NIM clients are updated.

*Example 5-109 Hostname change output*

---

```
Switching master on NIM clients
 changed master for v1par3_p5
Finished switching master on NIM clients
```

---

Example 5-110 shows the output for the `lsnim` command on the NIM server. This output shows that `master` is the new hostname on the NIM server, and that the new hostname is propagated to the NIM client (`v1par3_p5`).

*Example 5-110 lsnim command output*

---

```
(root@lpar2):/ # lsnim -l master
master:
 class = machines
 type = master
 max_nimesis_threads = 20
 if_defined = chrp.mp.ent
 comments = machine which controls the NIM environment
 platform = chrp
 netboot_kernel = mp
 if1 = NET_EN1 nimmast 00096B4EAD9C
 cable_type1 = N/A
 Cstate = ready for a NIM operation
 prev_state = ready for a NIM operation
 Mstate = currently running
 serves = LPP_PRUEBA
 serves = SEC_ADAPTR
 serves = boot
 serves = nim_script
 master_port = 1058
 registration_port = 1059
 reserved = yes
 ssl_support = yes
```

---

On the NIM client, the `/etc/niminfo` file is updated with the new hostname as shown in Example 5-111 on page 548.

*Example 5-111 /etc/niminfo updates*

---

```
cat /etc/niminfo
#----- Network Install Manager -----
warning - this file contains NIM configuration information
and should only be updated by NIM
export NIM_NAME=VLPAR3_p5
export NIM_HOSTNAME=v1par3_p5
export NIM_CONFIGURATION=standalone
export NIM_MASTER_HOSTNAME=nimmast
export NIM_MASTER_PORT=1058
export NIM_REGISTRATION_PORT=1059
export NIM_SHELL="shell"
export NIM_BOS_IMAGE=/SPOT/usr/sys/inst.images/installp/ppc/bos
export NIM_BOS_FORMAT=rte
export NIM_HOSTS=" 10.1.1.70:v1par3_p5 10.1.1.22:nimmast "
export NIM_MOUNTS=""
export ROUTES=" default:0:10.1.1.1 "
```

---

### Removing old names from name resolution

At this point the old names can be removed from the name resolution.

Example 5-112 shows the content of the /etc/hosts file on the NIM master after removing the old name.

*Example 5-112 /etc/hosts on the NIM master*

---

```
(root@lpar2):/ # cat /etc/hosts
.....
10.1.1.22 nimmast
.....
```

---

Example 5-113 shows the content of the /etc/hosts file on the NIM client after removing the old name.

*Example 5-113 /etc/hosts on the NIM client*

---

```
cat /etc/hosts
.....
10.1.1.22 nimmast
.....
```

---

## 5.10.5 Changing the NIM master IP address

**Important:** Perform a NIM DB backup before changing NIM master object attributes.

To change the IP address for the NIM master, follow these steps. They are explained in more detail throughout the section.

1. Change the IP address for the NIM master.
2. Update name resolution (for the NIM master and the NIM clients).
3. Update the NIM networks object.
  - a. Remove all client NIM objects.
  - b. Recover the NIM master.
  - c. Remove old NIM networks object and rename the new one.
  - d. Check for new NIM networks.
  - e. Recreate the NIM clients.

### **Scenario**

Here we are using three machines. One machine is configured one as a NIM master, and the second machine is configured as a NIM client. The third machine is configured as a gateway, routing network traffic through different network subnets.

Initially, the NIM master and the NIM client are on the same subnet. In this example we are moving the NIM master to other subnet and showing how to reconfigure the NIM environment to reflect the new environment.

Figure 5-7 on page 550 shows the initial and the final stages of the environment, when changing the IP address for the NIM master to a new IP address on a different subnet than the NIM client's subnet.

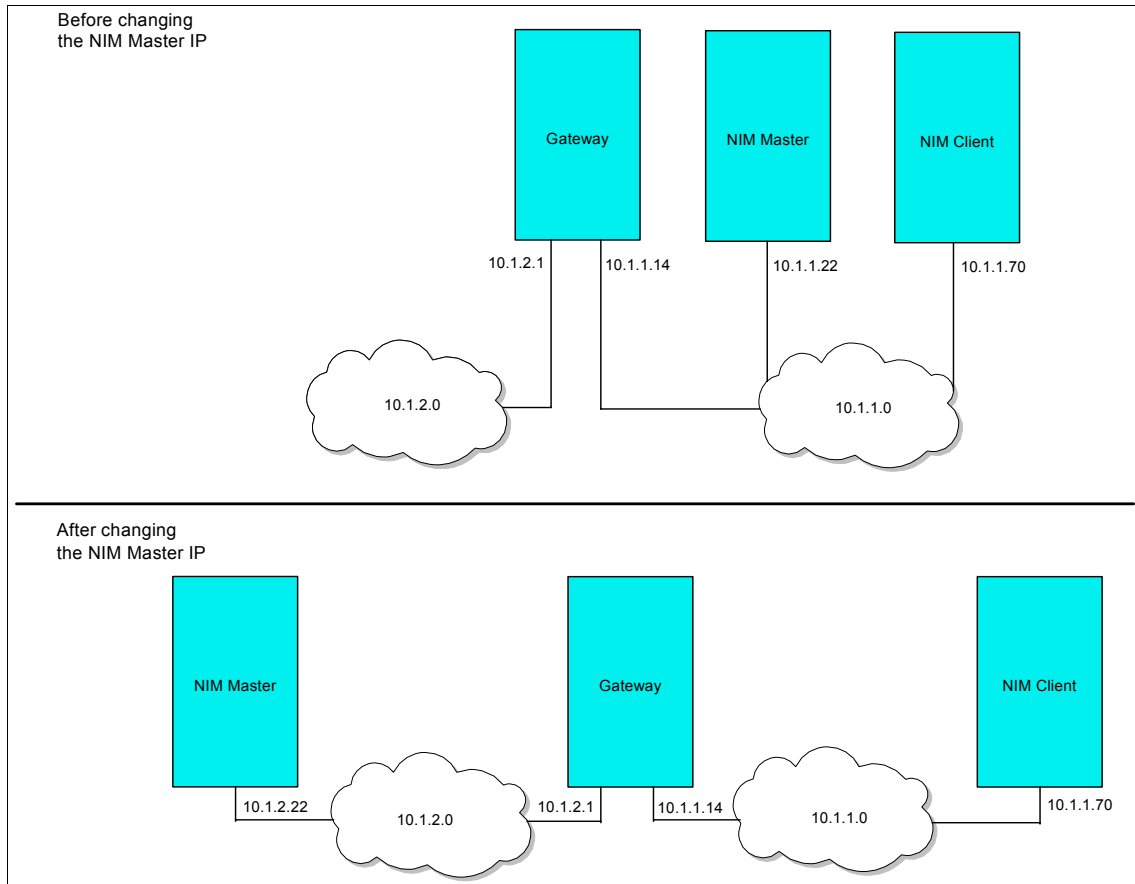

Figure 5-7 NIM master IP change scenario

## Changing the IP address for the NIM master

At this stage the NIM master IP is changed. The actual IP is 10.1.1.22 using 255.255.255.0 for the network mask. We change the IP to 10.1.2.22 for the NIM master. The NIM client remains on the 10.1.1 subnet, using the 10.1.1.70 IP address.

For more detailed information about how to change the IP address, refer to *AIX 5L Version 5.3 System Management Guide: Networks and Communications Management*, SC23-5203.

## Updating the name resolution

The name resolution must be updated for the NIM server and the NIM client. There is no need to keep the old names for this procedure.



## Updating the NIM networks object

We need to reflect the IP address change to the NIM database. To reflect the change, we need to remove all the NIM clients objects and recover the NIM master using a NIM method. This method creates a new NIM network object. The old NIM network object must be removed, and the new one is renamed to the old NIM network object.

### ***Removing all client NIM objects***

In this example we only have one client, which is named VLPAR3\_p5 as seen in Example 5-114. The master machine shown in Example 5-114 is the NIM master itself.

#### *Example 5-114 List of clients*

---

```
(root@lpar2):/ # lsrim -c machines
master machines master
VLPAR3_p5 machines standalone
```

---

Now we proceed to delete the client, as shown in Example 5-115.

#### *Example 5-115 Client removal*

---

```
(root@lpar2):/ # nim -o remove VLPAR3_p5
```

---

Example 5-116 shows that the client is removed.

#### *Example 5-116 List of NIM machines*

---

```
(root@lpar2):/ # lsrim -c machines
master machines master
```

---

In Example 5-117, we can see the NIM attributes for the master machine.

#### *Example 5-117 Master properties*

---

```
(root@lpar2):/ # lsrim -l master
master:
 class = machines
 type = master
 max_nimesis_threads = 20
 if_defined = chrp.mp.ent
 comments = machine which controls the NIM environment
 platform = chrp
 netboot_kernel = mp
 if1 = NET_EN1 lpar2 00096B4EAD9C
 cable_type1 = N/A
 Cstate = ready for a NIM operation
 prev_state = ready for a NIM operation
```

```
Mstate = currently running
serves = LPP_PRUEBA
serves = SEC_ADAPTR
serves = boot
serves = nim_script
master_port = 1058
registration_port = 1059
reserved = yes
ssl_support = yes
```

---

Example 5-118 shows the properties for the NIM network object named NET\_EN1.

*Example 5-118* NIM network object attributes

---

```
(root@lpar2):/ # lsnim -l NET_EN1
NET_EN1:
 class = networks
 type = ent
 comments = Generated during definition of lpar2
 Nstate = ready for use
 prev_state = ready for use
 net_addr = 10.1.1.0
 snm = 255.255.255.0
 routing1 = default 10.1.1.1
```

---

There is only one NIM network object for this NIM environment. The next stage is to recover the NIM master.

***Recovering the NIM master***

To recover the NIM master, we use a NIM method. NIM methods are located under /usr/lpp/bos.sysmgmt/nim/methods. The method that we use to recover the NIM master is the **nim\_master\_recover**.

The network interface is given to the method as a parameter. This method creates a new NIM network object named ent-Network1 with the new network address. Example 5-119 shows the execution of the method.

*Example 5-119* NIM master recovery

---

```
(root@lpar2):/ # /usr/lpp/bos.sysmgmt/nim/methods/nim_master_recover -i en1 -S
error retrieving nim name, defaulting to host name.
Updating master definition
 Updated master attribute platform to chrp
 Updated master attribute netboot_kernel to mp
 Updated master attribute if1 to ent-Network1 lpar2 00096B4EAD9C
 Updated master attribute cable_type1 to N/A
```

```
Updated ent-Network1 routing1 to default 10.1.2.1
Finished updating master definition
Resetting machines
 Reset master
Finished resetting machines
Resetting NIM resources
Finished resetting NIM resources
Checking NIM resources
Keeping LPP_PRUEBA
 Keeping SEC_ADAPTR
Finished checking NIM resources
nim_master_recover Complete
```

---

Example 5-120 shows that a new NIM network object named ent-Network1 is created.

*Example 5-120 NIM network objects*

---

```
(root@lpar2):/ # lsnim -c networks
ent-Network1 networks ent
NET_EN1 networks ent
```

---

Example 5-121 shows the attributes for the ent-Network1 NIM network object. Information for the new IP address is added to the ent-Network1 NIM network object.

*Example 5-121 NIM network object attributes*

---

```
(root@lpar2):/ # lsnim -l ent-Network1
ent-Network1:
 class = networks
 type = ent
 comments = Generated during definition of lpar2
 Nstate = ready for use
 prev_state = ready for use
 net_addr = 10.1.2.0
 snm = 255.255.255.0
 routing1 = default 10.1.2.1
```

---

**Note:** If the new IP address is configured on the same subnet as the old one, there is no need to create a new NIM network object. The `nim_master_recover` method does not create a new NIM network object; instead, it updates the old NIM network object.

Example 5-122 on page 554 shows the attributes for the NIM master. The `if1` attribute is changed to the NIM network object generated through the `nim_master_recover` method.

*Example 5-122 NIM master attributes*

---

```
(root@lpar2):/ # lsnim -l master
master:
 class = machines
 type = master
 max_nimesis_threads = 20
 if_defined = chrp.mp.ent
 comments = machine which controls the NIM environment
 platform = chrp
 netboot_kernel = mp
 if1 = ent-Network1 lpar2 00096B4EAD9C
 cable_type1 = N/A
 Cstate = ready for a NIM operation
 prev_state = ready for a NIM operation
 Mstate = currently running
 serves = LPP_PRUEBA
 serves = SEC_ADAPTR
 serves = boot
 serves = nim_script
 master_port = 1058
 registration_port = 1059
 reserved = yes
 ssl_support = yes
```

---

***Removing the old NIM network object and renaming the new object***

The ent-Network1 NIM network object has the information for the new IP address. The NIM network object keeping information about the old IP address must be removed, and the ent-Network1 NIM network objects must be renamed to the original NIM network object.

In our scenario, we have two NIM network objects:

- ▶ NET\_EN1, which contains information about the old IP address and network
- ▶ ent-Network1, which is generated through **nim\_master\_recover** and contains information about the new IP address and network

Example 5-123 shows the defined NIM network objects.

*Example 5-123 NIM network objects*

---

```
(root@lpar2):/ # lsnim -c networks
ent-Network1 networks ent
NET_EN1 networks ent
```

---

Example 5-124 on page 555 illustrates the removal of the NET\_EN1 NIM network object. The **nim** command is used to remove the NIM network object.

*Example 5-124 NET\_EN1 removal*

---

```
(root@lpar2):/ # nim -o remove NET_EN1
```

---

The only NIM network object defined in the NIM master is the one created through the `nim_master_recover` method, as shown in Example 5-125.

*Example 5-125 NIM network objects*

---

```
(root@lpar2):/ # lsnim -c networks
ent-Network1 networks ent
```

---

The next step is to rename, using the `nim` command, the `ent-Network1` NIM network object to the original NIM network object named `NET_EN1`. This step is shown in Example 5-126

*Example 5-126 Renaming the NIM network object*

---

```
(root@lpar2):/ # nim -o change -a new_name=NET_EN1 ent-Network1
```

---

Example 5-127 shows how the name change is reflected to the NIM master attributes. The `if1` attribute is changed to reflect the new name for the NIM network object.

*Example 5-127 NIM master attributes*

---

```
(root@lpar2):/ # lsnim -l master
master:
 class = machines
 type = master
 max_nimesis_threads = 20
 if_defined = chrp.mp.ent
 comments = machine which controls the NIM environment
 platform = chrp
 netboot_kernel = mp
 if1 = NET_EN1 lpar2 00096B4EAD9C
 cable_type1 = N/A
 Cstate = ready for a NIM operation
 prev_state = ready for a NIM operation
 Mstate = currently running
 serves = LPP_PRUEBA
 serves = SEC_ADAPTR
 serves = boot
 serves = nim_script
 master_port = 1058
 registration_port = 1059
 reserved = yes
 ssl_support = yes
```

---

## Checking for new NIM networks

The NIM master and NIM client are now in different subnets. The NIM master needs information about how to communicate to the NIM client, so we must define a new NIM network.

An additional NIM network can be defined by the NIM administrator, or it can be added automatically when defining the client.

In our scenario, we need an additional network to allow the client (which is in the 10.1.1 subnet) to communicate with the NIM server (which is in the 10.1.2 subnet). Here we illustrate two ways of creating the new NIM network object: manually, or automatically.

To create a NIM network object manually, follow these steps:

1. Type the `smitty nim_net` fastpath on the NIM server.
2. Select **Define a Network** from the SMIT menu.
3. Select the network type.
4. Complete the values required to define the NIM network.

Example 5-128 shows the SMIT panel and the values entered to define the proper network, in order to allow communication between the NIM server and the NIM client.

*Example 5-128 NIM network creation*

---

|                                  |                 |   |
|----------------------------------|-----------------|---|
| * <b>Network Name</b>            | [NET_EN2]       |   |
| * Network Type                   | ent             |   |
| * Ethernet Type                  | Standard        | + |
| * <b>Network IP Address</b>      | [10.1.1.0]      |   |
| * <b>Subnetmask</b>              | [255.255.255.0] |   |
| Default Gateway for this Network | [10.1.1.12]     |   |
| Other Network Type               |                 | + |
| Comments                         | []              |   |

---

Another option is to create the client from the master and fill the required values to automatically create the NIM network needed to communicate the NIM master with the NIM client.

To create a NIM client object and automatically the NIM network object, follow these steps:

1. Type the `smitty nim_mkmac` fastpath on the NIM master.
2. Enter the hostname for the NIM client.
3. Select the network type.

#### 4. Select the proper values for the network.

Example 5-129 shows the SMIT panel and values entered to define the NIM client, along with the NIM network object. In this example, the VLPAR3\_p5 NIM client object and the NET\_EN2 network object are created.

*Example 5-129 SMIT panel to define the NIM client and NIM network object*

---

|                                          |                        |    |
|------------------------------------------|------------------------|----|
| * NIM Machine Name                       | [VLPAR3_p5]            |    |
| * Machine Type                           | [standalone]           | +  |
| * Hardware Platform Type                 | [chrp]                 | +  |
| Kernel to use for Network Boot           | [mp]                   | +  |
| Communication Protocol used by client    | []                     | +  |
| Primary Network Install Interface        |                        |    |
| * Cable Type                             | bnc                    | +  |
| Network Speed Setting                    | []                     | +  |
| Network Duplex Setting                   | []                     | +  |
| * <b>NIM Network</b>                     | <b>[NET_EN2]</b>       |    |
| * Network Type                           | ent                    |    |
| * Ethernet Type                          | Standard               | +  |
| * <b>Subnetmask</b>                      | <b>[255.255.255.0]</b> |    |
| * <b>Default Gateway Used by Machine</b> | <b>[10.1.1.12]</b>     |    |
| * Default Gateway Used by Master         | [10.1.2.1]             |    |
| * Host Name                              | v1par3_p5              |    |
| Network Adapter Hardware Address         | [0]                    |    |
| Network Adapter Logical Device Name      | []                     |    |
| IPL ROM Emulation Device                 | []                     | +/ |
| CPU Id                                   | []                     |    |
| Machine Group                            | []                     | +  |
| Comments                                 | []                     |    |

---

#### ***Recreating the NIM clients***

The NIM clients must be recreated. For information about how to recreate the NIM clients, refer to “Defining NIM clients” on page 79.

#### ***Rebuilding the /etc/niminfo file on the NIM clients***

The /etc/niminfo file on the NIM clients must be rebuilt.







# Cluster Systems Management and Network Installation Manager

This chapter provides a general description of Cluster Systems Management (CSM). It also explains how CSM uses Network Installation Manager (NIM) to perform its node installation.

For more detailed information about CSM you can refer to CSM documentation, which is available at the following site:

<http://publib.boulder.ibm.com/infocenter/pseries/v5r3/topic/com.ibm.help.csm.doc/csm.html>

The chapter covers the following topics:

- ▶ Overview of CSM
- ▶ The management server (MS)
- ▶ NIM and CSM - how NIM operates in a CSM environment

## 6.1 Overview of Cluster Systems Management

A *cluster* is a set of two or more networked connected computers. A specific system management tool is required to manage this set of computers. This was formerly the role of Parallel Systems Support Programs (PSSP), which has been replaced by Cluster Systems Management (CSM).

As previously mentioned, NIM can perform the installation, maintenance, updating and backup tasks for the participants in the cluster. The basic challenges of CSM are to monitor, remotely access, and diagnose the problems that can arise during installation and maintenance of the operating systems on the machines in the cluster.

Figure 6-1 shows the CSM cluster environment.

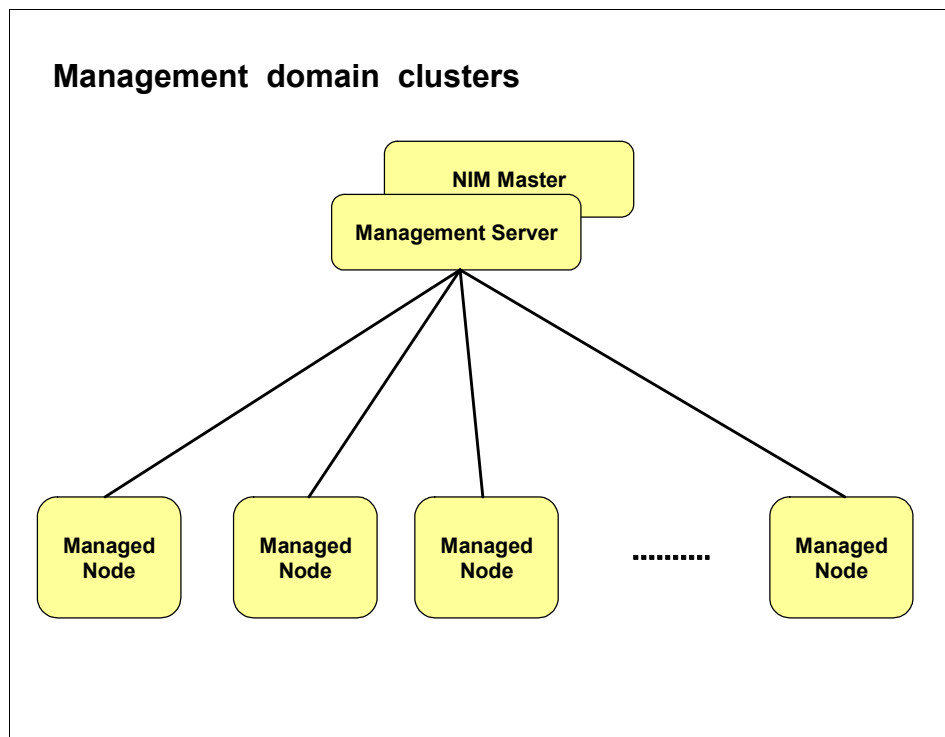

Figure 6-1 CSM cluster overview

### 6.1.1 The management server

The management server (MS) is a specific machine running AIX 5L and CSM server code. Although providing a detailed explanation about how to configure

CSM is beyond the scope of this book, the basic steps involved in how an AIX 5L machine becomes a management servers are listed here:

### ***Step 1: Choosing the MS machine***

Among the AIX running machines, choosing the one that is going to become the management server (MS) is not difficult; you must know whether this machine will also be the NIM master. If it will be the NIM master, then refer to 2.3.1, “Choosing your NIM master” on page 45 for information related to the choice of a NIM master.

### ***Step 2: Run some checks on the AIX machine***

For instance, check the level of AIX, the level of the Reliable Scalable Clustering Technology (RSCT) product, the network configuration and so forth.

### ***Step 3: Install CSM package***

Basically, the CSM client is automatically installed with AIX, thus the AIX machine is cluster-ready as a managed node. However, you will need to install the CSM server code. A license is required in order to use this product. A 60-day trial licence is included in the AIX 5L package. After this period, a license fee is required.

### ***Step 4: Configure the CSM cluster***

Using several CSM tools, information related to the nodes are gathered to populate the CSM database.

### ***Step 5: Check the CSM cluster data***

By running some CSM commands, verify whether the content of the CSM database is what has been planned.

### ***Step 6: Work with CSM***

Using the CSM tools, you can install the nodes with NIM, and control and manage the AIX 5L cluster nodes with CSM.

## **The nodes**

The *nodes* are the other managed machines in the cluster. AIX may or may not have already been installed on these nodes. If AIX has already been installed, a minimum CSM layer is necessary to join the cluster.

If AIX has not already been installed, then it first needs to be installed. Then the CSM layer has to be configured to have the node join the CSM cluster.

Note that the AIX installation (from a mksysb or from filesets) is not the responsibility of CSM: it is the role of NIM. CSM is not designed to install or maintain a machine. CSM can help NIM to fill the client definitions of the

machines objects after the NIM master configuration has been made and the resources created.

Another characteristic of a CSM cluster is that the management server is an AIX machine. However, you can have a mix of AIX 5L nodes and Linux nodes. In this case, the MS can control and monitor the Linux nodes only if Linux is already installed.

At the time of writing there are no defined procedures to use NIM to automatically install Linux on machines except for some manual operations, as detailed in 4.2, “Using the OS\_install command” on page 137.

## 6.1.2 NIM and CSM

PSSP provides the **setup\_server** tool to set up the NIM environment (from the NIM configuration to the different NIM operations, such as installation or migration of a node).

In CSM, however, there is no tool or script to perform these steps. Thus, the cluster administrator must separately build the CSM cluster and the NIM environment. For more details about how to set up a CSM cluster, refer to the CSM documentation:

<http://publib.boulder.ibm.com/infocenter/pseries/v5r3/topic/com.ibm.help.csm.doc/csm.html>

Basically, the different machines making up the cluster are seen as nodes for CSM and clients for NIM. These machines are the same, and the majority of their characteristics are similar in both the CSM and NIM databases.

To save time in building the NIM database, particularly when defining the clients, there is a tool part of the CSM package that allows system administrators to get node information from the CSM database and put the related client NIM information into the NIM database. In fact, two commands are available: one for managing individual nodes (**esm2nimnodes**) and one for machine groups (**esm2nimgrps**).

Figure 6-2 on page 563 gives an overview of the relationship between the two databases: CSM registry and NIM ODM classes.

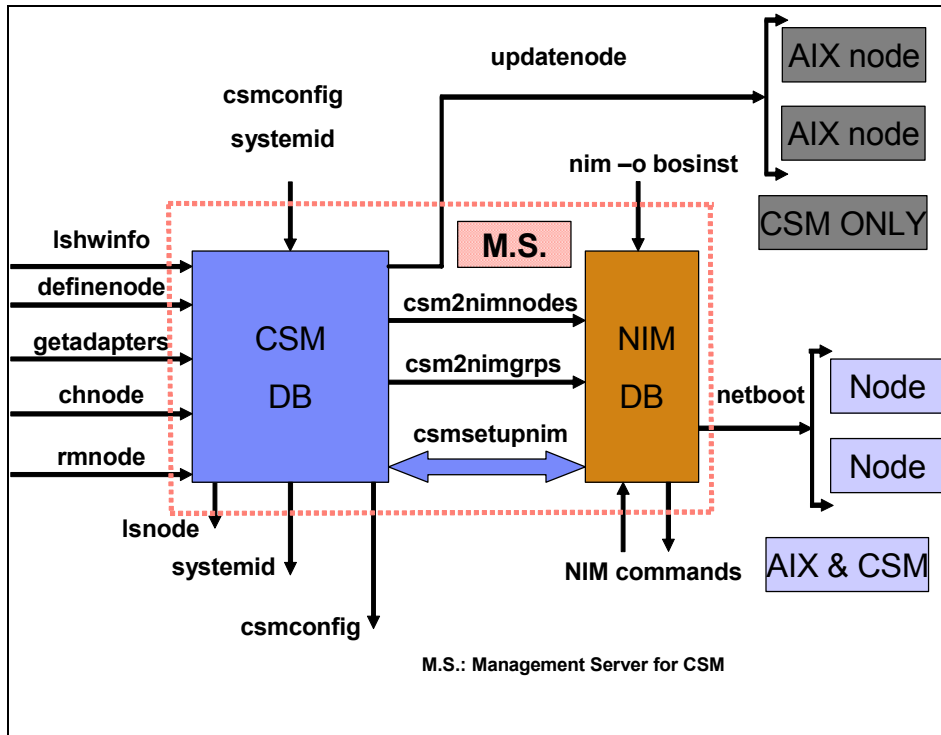

Figure 6-2 CSM and NIM coexistence

As shown in Figure 6-2, the `csm2nimnodes` and `csm2nimgrps` commands link the CSM database to the NIM database, although each program has its particular set of tools for node creation, modification, or removal.

The `csmsetupnim` command performs tasks on both databases which ensure that the node will automatically be part of the cluster, for management purposes, when the installation completes.





## Basic NIM problem determination and tuning

This chapter describes basic NIM problem determination, solutions for network boot problems, and procedures for producing debug output for NIM base operating system (BOS) installations.

It also discusses the approach that is used to identify and correct problems involved with NIM operations. It covers the following topics:

- ▶ Troubleshooting methodologies
- ▶ LEDs
- ▶ Network File System (NFS) usage
- ▶ Booting issues
- ▶ Log files
- ▶ Case study: NIM server performance
- ▶ Multi-threaded NIM nimesis daemon

## 7.1 Troubleshooting methodologies

First, we describe an approach to manage NIM troubleshooting. NIM bases its operations on two major components: the network and the operating system. Troubleshooting NIM consists of identifying the cause of the problem, and then determining whether it is a NIM-related problem, a network-related problem, or an AIX problem.

**Tip:** After you identify the component that is causing the problem, you can correct the problem by executing the appropriate action. Keep in mind, however, that with any troubleshooting methodology, often the simplest solution is all that is needed. So be sure to examine the basics before delving into the more complex reasons behind an issue.

For instance, if you cannot ping a NIM client, first verify that the network cable is connected before examining icmp packets with tcpdump. This “back to basics” approach can often speed up problem resolution.

There are several operations that are performed by NIM through all its functions. Network boot, for example, covers many of the operations performed by NIM. In the following section we describe troubleshooting a network boot problem. The troubleshooting procedure is illustrated through the flowcharts presented here.

### 7.1.1 Troubleshooting a network boot problem

In this scenario, we work with two machines. One machine is configured as a NIM master/server and the other is configured as a NIM client.

The client has been booted to the SMS menu to configure a network install boot operation in order to install the client. Remote IPL values have been entered in the client SMS configuration.

On the master side, lpp\_source and Shared Product Object Tree (SPOT) resources have been allocated to the client and a network install operation has been initiated. A problem has been detected while performing the network boot, and the client is unable to boot from the server.

We follow the flowchart illustrated in Figure 7-1 on page 567 to solve the problem presented in this scenario.



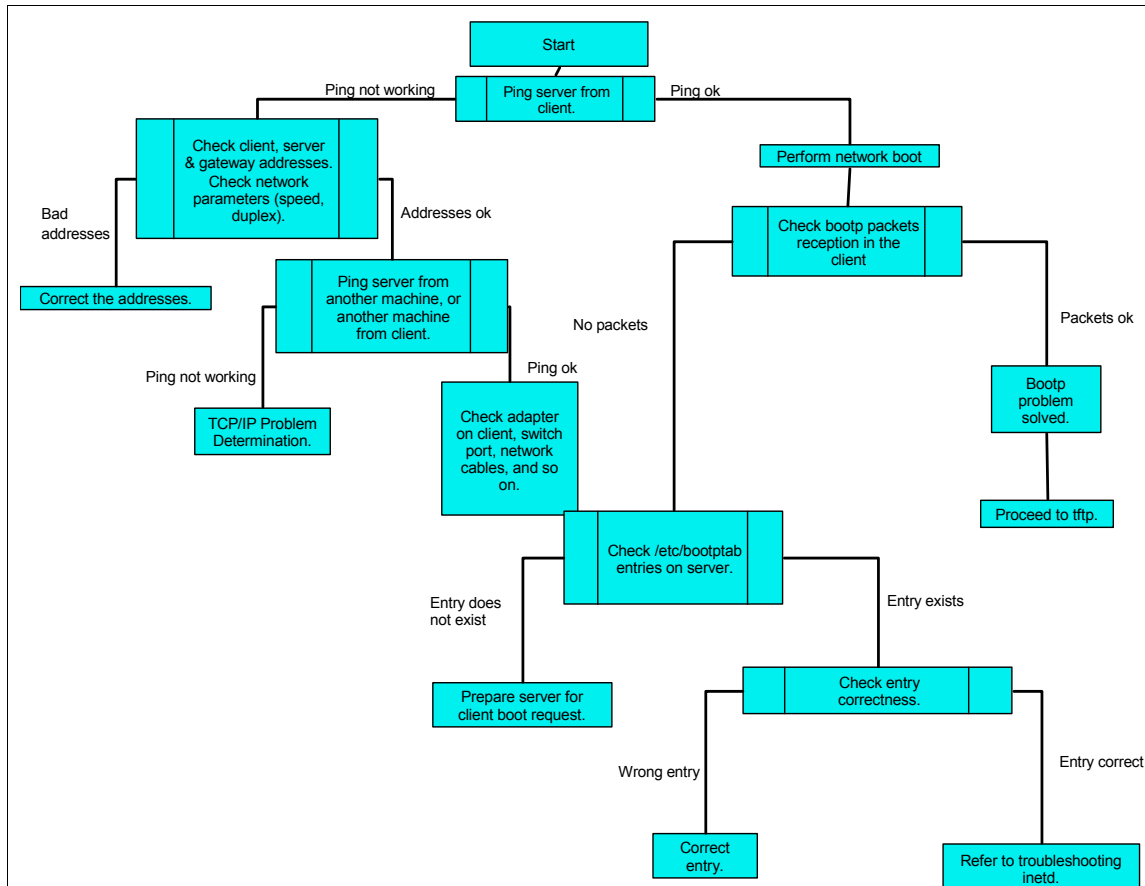

Figure 7-1 Troubleshooting a network boot problem

## Network communications

As a starting point, we try to determine whether IP communication between machines can be established (client and server). To do this, we perform a ping test from the client's SMS menu, trying to ping our NIM master as shown in Example 7-1.

### Example 7-1 SMS ping menu

Version SF240\_202

SMS 1.6 (c) Copyright IBM Corp. 2000,2005 All rights reserved.

Ping Test

Interpartition Logical LAN: U9111.520.65C544E-V8-C3-T1

Speed, Duplex: auto,auto

Client IP Address: 10.1.1.70

Server IP Address: 10.1.1.1  
Gateway IP Address: 000.000.000.000  
Subnet Mask: 255.255.255.000  
Spanning Tree Enabled: 1  
Connector Type: none

#### 1. Execute Ping Test

-----  
Navigation keys:

M = return to Main Menu

ESC key = return to previous screen

X = eXit System Management Services

-----  
Type menu item number and press Enter or select Navigation key:1

---

If the ping test fails, we verify that the client, server, gateway addresses and network mask are specified correctly. We also verify that the adapter configuration (network speed setting and duplex) are specified correctly.

If all settings are correct, we try to ping the server from another machine. We try to ping another machine from the client in an attempt to separate a network problem on the client from a network problem on the server.

If the server can be pinged from another machine, or if other machines cannot be pinged from the client, it may mean that the network adapter on the boot client is faulty, or that there is a problem with the switch port, the cables or the VLAN.

### **Obtaining the boot image from the server**

At this point we have verified the communication between the NIM master/server and the NIM client. The next stage in the network install operation is obtaining the boot image from the server. When a network boot is initiated on a client, a bootp request packet is sent from the client to the server. The server then replies with a packet to the client, specifying the image to be loaded by the client. The client machine displays the number of packets sent and received for the bootp request, as shown in Example 7-2.

*Example 7-2 BOOTP request success*

-----  
BOOTP R = 1 BOOTP S = 2  
-----

If a packet is sent from the client, but none is received, another packet will be sent. Example 7-3 on page 569 shows the output for a system that is not able to obtain a response packet from the server.

### *Example 7-3 BOOTP request failure*

---

```
BOOTP: BOOTP request fail: 0
```

```
BOOTP S = 4
```

---

If bootp packets continue to be sent but no response is received, the boot server may not be responding to the request. Verify that the correct entry exists in the `/etc/bootptab` file on the server for the selected client.

The `/etc/bootptab` file contains entries, one for each client ready to perform a network boot operation, with the following information:

- ▶ `hostname_of_client`
- ▶ `bf=boot_file`
- ▶ `ip=client_ip_address`
- ▶ `ht=network_type`
- ▶ `sa=boot_server_address`
- ▶ `sm=client_subnet_mask`
- ▶ `ha=network_adapter_hardware_address` (required only if bootp requests are sent by broadcasting)

These entries are created at the moment that NIM configures the client machine for the operation. Example 7-4 shows the content for the `/etc/bootptab` file in our environment.

### *Example 7-4 The /etc/bootptab content*

---

```
VLPAR3_p5:bf=/tftpboot/VLPAR3_p5:ip=10.1.1.70:ht=ethernet:sa=10.1.1.1:sm=255.255.255.0:
```

---

If an entry does not exist, it means that either the NIM command used to set up the current operation failed, or the machine was reset before the boot operation could occur. In this case we can rerun the NIM `bos_inst`, `diag`, or `maint_boot` operation to prepare the server for the client boot request.

If the entry exists in `/etc/bootptab`, we verify that the specified data is correct. If a field contains incorrect data, the information that was used to define the machine or network in the NIM database was probably incorrect. We can correct this problem by performing a NIM reset operation on the client machine, correcting the invalid data in the client or network definition, retrying the NIM operation, and rebooting the client.

## **Verifying inetd**

If the `/etc/bootptab` file is correct, we proceed to troubleshooting `inetd` by following the flowchart illustrated in Figure 7-2.

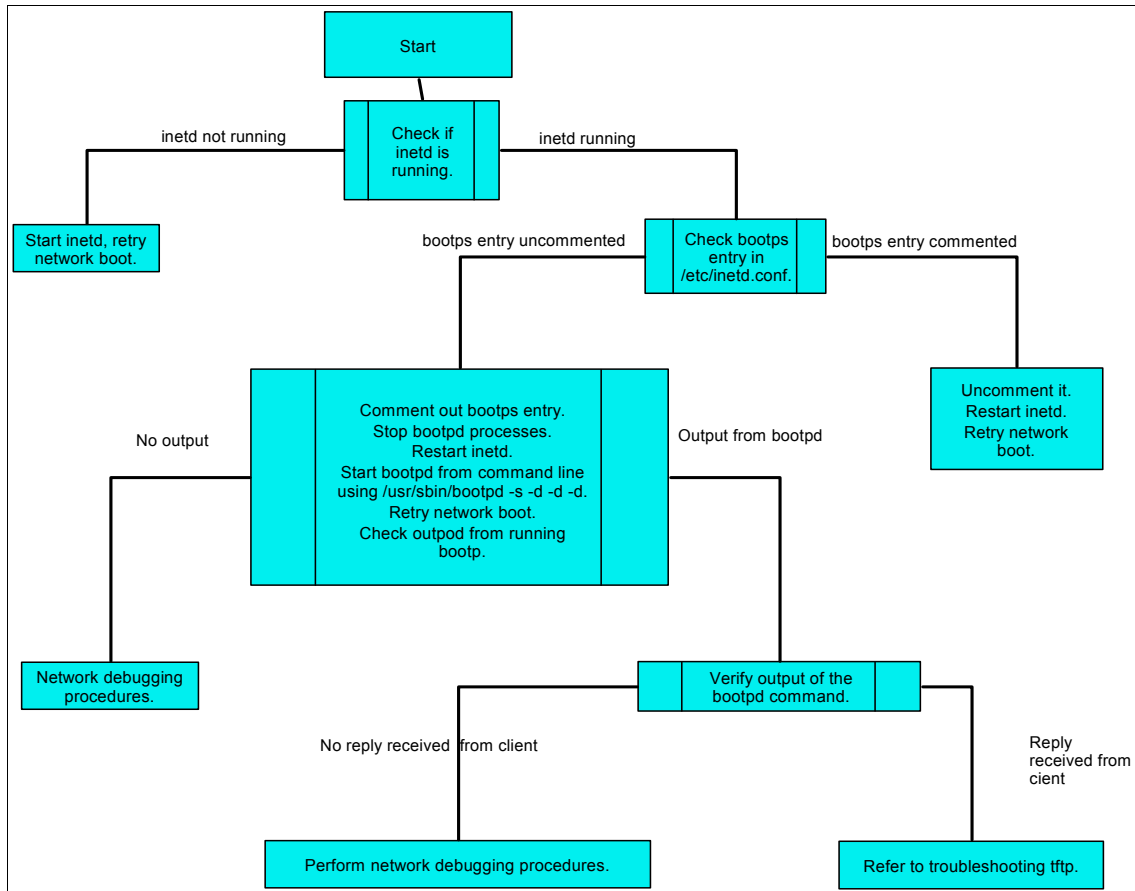

Figure 7-2 Troubleshooting inetd flowchart

We verify that the inetd daemon is running, as shown in Example 7-5. If it is not running, we start it and retry the network boot from the client. If the inetd daemon is running, it should automatically start the bootpd daemon when the bootp request is received at the server.

*Example 7-5 The inetd status verification*

---

```

{nimast}:/etc # lsrc -s inetd
Subsystem Group PID Status
inetd tcpip 102520 active

```

---

If the bootpd daemon is not started, we verify that the bootps entry in the /etc/inetd.conf file is not commented out. If it is commented out, we uncomment it

and restart `inetd` with the `refresh -s inetd` command. Then we retry the network boot from the client.

The `/etc/inetd.conf` file should contain a line similar to the one shown in Example 7-6.

*Example 7-6 The bootps entry*

---

```
cat /etc/inetd.conf
.....
bootps dgram udp wait root /usr/sbin/bootpd bootpd /etc/bootptab
.....
```

---

If a `bootp` reply is still not received at the client, we manually start the `bootpd` daemon in debug mode. To manually start the `bootpd` daemon in debug mode we follow these steps:

1. Comment out the `bootps` entry from the `/etc/inetd.conf` file on the server.
2. Stop all running `bootpd` processes.
3. Restart `inetd` using the `refresh -s inetd` command.
4. Start `bootpd` from the command line, using the following command:

```
/usr/sbin/bootpd -s -d -d -d
```

We then retry the network boot from the client. If no output is displayed from the running `bootpd` command, it means that the client `bootp` request is not reaching the server.

Example 7-7 shows the output of the `bootpd` command running on the server in debug mode at the moment of receiving a `bootpd` request.

*Example 7-7 Bootpd output*

---

```
/usr/sbin/bootpd -s -d -d -d
BOOTPD: bootptab mtime is Mon Jun 19 14:41:44 2006
BOOTPD: reading "/etc/bootptab"
BOOTPD: read 1 entries from "/etc/bootptab"
BOOTPD: dumped 1 entries to "/etc/bootpd.dump".
BOOTPD: bootptab mtime is Mon Jun 19 14:47:36 2006
BOOTPD: reading new "/etc/bootptab"
BOOTPD: read 1 entries from "/etc/bootptab"
BOOTPD: Received boot request.
BOOTPD: request from IP addr 10.1.1.70
BOOTPD: found 10.1.1.70 VLPAR3_p5
BOOTPD: bootfile = /tftpboot/VLPAR3_p5
BOOTPD: vendor magic field is 99.130.83.99
BOOTPD: RFC1048 vendor data (bp_vend[64])
```



*Example 7-9 The .info file content*

---

```
cat VLPAR3_p5.info
#----- Network Install Manager -----
warning - this file contains NIM configuration information
and should only be updated by NIM
export NIM_NAME=VLPAR3_p5
export NIM_HOSTNAME=VLPAR3_p5
export NIM_CONFIGURATION=standalone
export NIM_MASTER_HOSTNAME=nimmast
export NIM_MASTER_PORT=1058
export NIM_REGISTRATION_PORT=1059
export NIM_SHELL="nimsh"
export NIM_MASTERID=0051703A4C00
export NIM_LICENSE_ACCEPT=yes
export RC_CONFIG=rc.bos_inst
export NIM_BOSINST_ENV="./SPOT/usr/lpp/bos.sysmgt/nim/methods/c_bosinst_env"
export NIM_BOSINST_RECOVER="./SPOT/usr/lpp/bos.sysmgt/nim/methods/c_bosinst_env -a
hostname=VLPAR
3_p5"
export SPOT=nimmast:/AIX53ML4/SPOT_53_ML4/usr
export NIM_CUSTOM="./SPOT/usr/lpp/bos.sysmgt/nim/methods/c_script -a
location=nimmast:/export/nim
/scripts/VLPAR3_p5.script"
export NIM_BOS_IMAGE=/SPOT/usr/sys/inst.images/installp/ppc/bos
export NIM_BOS_FORMAT=rte
export NIM_HOSTS=" 10.1.1.70:VLPAR3_p5 10.1.1.1:nimmast "
export NIM_MOUNTS=" nimmast:/AIX53ML4/LPP_53_ML4:/SPOT/usr/sys/inst.images:dir "
```

---

Figure 7-3 on page 574 shows the flowchart used for troubleshooting tftp.

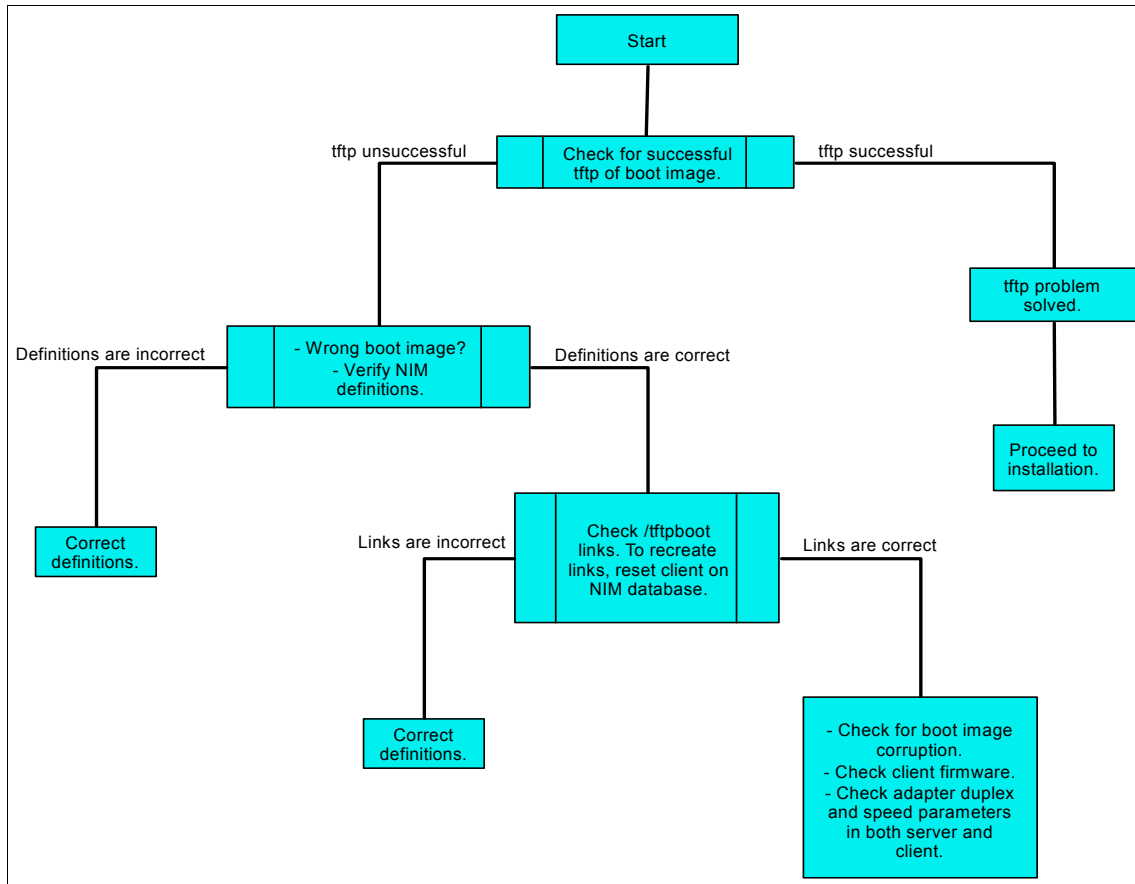

Figure 7-3 Troubleshooting tftp

The number of tftp packets transferred to the client will be displayed at the client machine as shown in Example 7-10.

*Example 7-10 The tftp packet count*

---

```

FILE: /tftpboot/VLPAR3_p5
FINAL Packet Count = 23852
FINAL File Size = 12211712 bytes.

```

---

When the LED displays 299 (or, on the machines of other platforms, when the bottom third of the screen turns gray), it means that the boot image has been successfully retrieved at the client machine.



**Note:** The final file size value shown by the tftp transfer must be the same as the size of the boot image file, as displayed in Example 7-8 on page 572 and Example 7-10 on page 574.

If the tftp of the boot image does not complete successfully, it means that the client may be trying to get the wrong boot image. We verify that the client definition in the NIM database shows the correct platform and kernel type. If the data is incorrect then we correct it, reset the client machine, rerun the NIM operation, and reboot the client over the network.

We verify that the /tftpboot directory on the boot server contains a link with the client name to the correct boot image. If the link does not exist, we reset the client machine, rerun the NIM operation, and reboot the client over the network.

The response for the tftp server and the NIM server can also be tested from another machine by using the **tftp** command. Using this command, we can retrieve information about the content of the tftpboot directory on the server, testing the response of the tftp server.

Example 7-11 shows the execution of the **tftp -g - <tftp\_server\_name> /tftpboot** command.

*Example 7-11 A tftp server test*

---

```
tftp -g - nimmast /tftpboot
...SPOT_53_ML4.chspotaix5204.chspotaix5104.chSPOT_PRUEBA.chAIX53_ML04_debSPOT-V
IO.chrp.spotaix5205.chReceived 144 Bytes in 0.0 Seconds
```

---

We get a list of the contents of the directory when we execute **echo \*** for the /tftpboot directory on the server, as shown in Example 7-12.

*Example 7-12 Directory listing on the server*

---

```
{nimmast}:/tftpboot # echo *
AIX53_ML04_debug.chrp.mp.ent SPOT-VIO.chrp.mp.ent SPOT_53_ML4.chrp.mp.ent
SPOT_PRUEBA.chrp.mp.ent spotaix5104.chrp.mp.ent spotaix5204.chrp.mp.ent
spotaix5205.chrp.mp.ent
```

---

If the link with the client name is pointing to the correct boot image but the tftp of the boot image does not complete successfully, it means that the boot image may be corrupted. We recreate the boot image by performing a NIM check operation with the force flag on the SPOT. We also verify that the client has the latest version of the firmware installed.

We also check that the duplex settings for the network adapters in the server and the client are correct, and that the switch ports where they are connected are correct. If one of the duplex settings for the adapters is incorrectly set, bootp may work but tftp may develop problems when transferring the boot image. Note that tftp may also fail due to an MTU size mismatch between the NIM master network and the NIM client network.

## 7.1.2 Debugging NIM BOS installations

Clients may fail to boot or install properly because of problems in the network or in the NIM configuration. If this happens, it may be necessary to obtain debug information to determine the cause of the problem.

For further information regarding debugging NIM BOS installations, refer to the section “Obtaining debug output for NIM BOS Installations” in *AIX 5L V5.3 Installation and Migration*, SC23-4887.

## 7.1.3 Recreating the SPOT from an existing directory

Rebuilding the NIM database during system recovery implies defining a SPOT. Defining a SPOT may be a lengthy process if you are using the install media (CD). However, if the NIM database was lost and the files for the previously-defined SPOT are valid, you can use this operation to recreate the SPOT, thus avoiding the need for a fresh build.

After redefining the NIM master, one of the NIM methods is used to recreate the SPOT. The method is `/usr/lpp/bos.sysmgt/nim/methods/m_mkspot`. The server name, the SPOT location, and the SPOT name must be given to the method.

Example 7-13 shows the recreation of the SPOT that is named `SPOT_TEST`, located in the `/SPOT_TEST` directory, in the server named `master`. Note the selected option `source=no` for the method. This option tells the method not to rebuild the files again.

### *Example 7-13 Re-creating an SPOT*

---

```
{nimmast}:/ # lsnim -l SPOT_TEST
0042-053 lsnim: there is no NIM object named "SPOT_TEST"
{nimmast}:/ # ls -l /SPOT_TEST/SPOT_TEST
total 72
-r-xr-xr-x 1 root system 5670 Jun 14 2005 bosinst.data
-r-xr-xr-x 1 root system 14262 Jun 08 2005 image.data
-r-xr-xr-x 1 root system 5173 Aug 26 2005 lpp_name
drwxr-xr-x 24 bin bin 4096 Jun 22 16:56 usr
{nimmast}:/ # /usr/lpp/bos.sysmgt/nim/methods/m_mkspot -o -a server=master -a
location=/SPOT_TEST -a source=no SPOT_TEST
```

```
{nimmast}:/ # echo $?
0
{nimmast}:/ # lsnim -l SPOT_TEST
SPOT_TEST:
 class = resources
 type = spot
 plat_defined = chrp
 Rstate = ready for use
 prev_state = verification is being performed
 location = /SPOT_TEST/SPOT_TEST/usr
 version = 5
 release = 3
 mod = 0
 oslevel_r = 5300-04
 alloc_count = 0
 server = master
 if_supported = chrp.mp ent
 Rstate_result = success
```

---

**Note:** If resources have been deleted using NIM commands, they cannot be recovered without recreating them.

As you can see in Example 7-13 on page 576, there was no SPOT in the NIM environment (shown on the first `lsnim` command execution), although the files that used to belong to an SPOT are still there (shown on the `ls` command execution). After using the method execution to recreate the SPOT, we verify that the SPOT has been created by executing the `lsnim` command.

## 7.2 LEDs

If your system has an LED display, the three-digit LED shows values during NIM operations. These values are useful to understand which stage of the operation is being performed and, if the operation fails, in which stage the failure occurred. In the following section we list the values for the three-digit LED output.

### 7.2.1 LED values during NIM operations

In the following list, the values shown at the first level of indentation are the normal values displayed during normal performance of the operations. The values shown at the second level are failure indicators.

The values are presented in the order in which they are displayed in the three-digit LED:

- ▶ 299 Boot image successfully received at the NIM client.
- ▶ 600 Starting network boot (portion of /sbin/rc.boot).
- ▶ 602 Configuring network parent devices.
  - 603 Script defsys, cfgsys, or cfgbus located in /usr/lib/methods/ failed.
- ▶ 604 Configuring physical network boot device.
  - 605 Configuration physical network boot device failed.
- ▶ 606 Running /usr/sbin/ifconfig on logical network boot devices.
  - 607 /usr/sbin/ifconfig failed.
- ▶ 608 Attempting to retrieve the client.info file with tftp from the SPOT server.
  - 609 The client.info file does not exist or could not be accessed, or it is zero length.
- ▶ 610 Attempting to mount a remote file system using NFS.
  - 611 The client is unable to mount a remote file system (NIM resource) using NFS.
- ▶ 612 Accessing remote files. Unconfiguring network boot devices.
  - 613 The route command failed.
- ▶ 614 Configuration of logical paging devices.
  - 615 Configuration of logical paging device failed.
- ▶ 616 Converting from diskless to dataless configuration.
  - 617 Diskless to dataless configuration failed.
- ▶ 618 Configuring remote (NFS) paging device.
  - 619 Configuration of remote (NFS) paging space failed.
- ▶ 620 Updating special device files and ODM in permanent file system.
- ▶ 622 Control returned to the /sbin/rc.boot program.
  - 623 The BOS installation program has encountered a fatal error.
- ▶ 624 Control passed to the BOS installation Program.
- ▶ c40 Extracting data files from media.
- ▶ c42 Extracting data files from diskette.
- ▶ c44 Initializing install data base with target disk information.
- ▶ c46 Normal install processing.
- ▶ c48 Prompting user for input.

- ▶ c50 Creating root volume group on target disks.
- ▶ c52 Changing from RAM environment to disk environment.
- ▶ c54 Installing either BOS or additional packages.
- ▶ c56 Running user-defined customization.
- ▶ c58 Displaying message to turn key.
  - c41 Could not determine boot type or device.
  - c43 Could not access boot/install tape.
  - c45 Cannot configure console.
  - c47 Could not create pvid on disk.
  - c49 Could not create or form the jfs log.
  - c51 No paging devices found.
  - c53 Not enough space in /tmp to do preservation install.
  - c55 Could not remove the specified logical volume in a preservation install.
  - c57 Failure to restore BOS.
  - c59 Could not copy either device special files, device ODM, or vg information from RAM to disk.
  - c61 Failed to create boot image. Ensure enough space in /tmp.

Using the values displayed in the three-digit LED, you can determine which operation failed and perform the proper actions to solve the problem.

Some of the most common errors encountered after the client machine has successfully received the boot image from the server are hangs with the LED displaying the values 608, 611, or 613. We examine these problems in more detail in the following sections.

### **608 - tftp retrieve of client info file failure**

If a 608 hang is encountered, we verify that the *ClientName.info* file exists in the /tftpboot directory. If it does not exist, we retry the NIM operation to create it. If it does exist, we verify that tftp access to the /tftpboot directory is not restricted in the /etc/tftpaccess.ctl file.

It is also possible that the network adapter was not configured properly in the boot environment. In this case, we use debug-enabled network boot images to look for errors in the boot environment.

## 611 - Remote mount of NFS file system failure

LED 611 hangs occur when the client machine is unable to mount a resource from the NIM master/resource server. First ensure that NFS is running on the master/resource server. We verify that the resources specified for the operation are exported properly by checking the `/etc/exports` and `/etc/xtab` files on the server. Also, we confirm that the resources have permissions set correctly for reading. Debug-enabled network boot images can also be used to determine exactly which `mount` command is failing on the client. We can also check the value of the `nfso` server `portcheck` option and usage of NFS reserved ports.

For further information about the use of NFS reserved ports and the `nfso` server `portcheck` option, refer to 5.3.9, “NFS reserved ports” on page 441.

## 613 - Failure setting up route tables

613 hangs usually occur because a route is incorrectly defined for a network in the NIM database. We verify that the correct gateways are specified between networks, and all gateways are functional. We use debug-enabled network boot images to determine which routes could not be defined.

### 7.2.2 Hang on LED 611 - NFS mount problem

In this case, during bootup, the system hangs on LED 611. This may result from a shortened domain name. To show the exported lines for the `lpp_source` and `spot`, we execute:

```
lsnim -Fl <client>
```

We ensure that every directory added to the exports list uses the fully qualified domain name (for example, `client.xyz.com`). A common problem is having just the term “client” in the fields `HOSTS` allowed root access and `HOSTS & NETGROUPS` allowed client access instead of the fully qualified domain name.

To verify if a fully qualified domain name is needed, we run:

```
host <client>
```

The output should read `<client>.xyz.com is <ip address>`. Then we run:

```
host <ip address>
```

If it returns `<client>.xyz.com is <ip address>`, then we use the fully qualified domain name. The NIM master should be configured to use DNS in this case.

## 7.2.3 NIM installation hangs on LED 613

After initiating the rte installation, we look at the client.info file in the /tftpboot directory to see if there is an incorrect default route set there. If there is, we either remove the NIM default route or add the correct default route. (If both the client and the master are on the same network, you should not need any routes.)

To modify the client's network route in NIM:

```
nim -Fo reset <client>
nim -o deallocate -a subclass=all <client>
lsrim -l <client> ==> if1 = <client_net> <client_hostname> <mac_addr>
```

Look for <client\_net> and make note of this name, for example:

```
if1 = NET2 LPAR7 22338000C003 ent
```

Then remove the route, run:

```
smitty nim_rmroute
```

Select the client\_net and select the route to remove.

To change the route, run:

```
smitty nim_chroute
```

Select the <client\_net> and change the route. After the route is changed, re-initiate the install.

## 7.3 Network File System (NFS) usage

When resources are allocated for use during NIM operations, they are NFS-exported to the client machines where the operations will be performed. If operations are performed simultaneously on many different clients, the /etc/exports and /etc/xtab files may become very large on the resource servers. This may cause size limits to be exceeded in the files, and it may also negatively affect NIM performance as the files are locked and modified for each resource allocation or deallocation.

The option to globally export the resources may be set in environments where administrators are not concerned about who has access to the NIM resources. This prevents repeated updates to the /etc/exports and /etc/xtab files. Setting global export of a NIM resource will make it readable by any machine in the network, not just those in the NIM environment. The resource will be globally exported as long as it is allocated to any client. When the resource is deallocated from all clients, it is unexported.

**Note:** Resources that are used exclusively by diskless and dataless clients may not be globally exported.

### 7.3.1 Exporting NIM resources globally

NIM resources can be exported globally using Web-Based System Manager, SMIT or the command line.

#### Using Web-Based System Manager

Follow these steps to enable global export of NIM resources using Web-Based System Manager:

- ▶ From the NIM menu, select **Advanced Configuration. Export NIM Resources Globally**.
- ▶ Use the dialog to complete the task.

#### Using SMIT

Follow these steps to enable global export of NIM resources using SMIT:

- ▶ Type the `smit nim_global_export fastpath` on the NIM Server.
- ▶ Select **enable** for the value: Enable/Disable Global Exporting of NIM Resources?

Example 7-14 shows the SMIT panel used when enabling global exports of NIM resources.

*Example 7-14 Enabling global exports of NIM resources using SMIT*

---

Export NIM Resources Globally

Type or select values in entry fields.  
Press Enter AFTER making all desired changes.

```
* Enable/Disable Global Exporting of NIM Resources? [enable] [Entry Fields] +
```

|          |            |           |          |
|----------|------------|-----------|----------|
| F1=Help  | F2=Refresh | F3=Cancel | F4=List  |
| F5=Reset | F6=Command | F7=Edit   | F8=Image |
| F9=Shell | F10=Exit   | Enter=Do  |          |

---

To disable global exports of NIM resources using SMIT, proceed as follows:

- ▶ Type the `smit nim_global_export fastpath` on the NIM Server.



- ▶ Select **disable** for the value: Enable/Disable Global Exporting of NIM Resources?

## Using the command line

To enable global exporting of NIM resources, set the attribute `global_export=yes` on the NIM master:

```
nim -o change -a global_export=yes master
```

Example 7-15 shows the output generated by the `nim` command when enabling global exports of NIM resources.

### *Example 7-15 Enabling global exports of NIM resources using the command line*

---

```
{nimmast}:/ # nim -o change -a global_export=yes master
{nimmast}:/ # lsnim -l master
master:
 class = machines
 type = master
 max_nimesis_threads = 20
 if_defined = chrp.mp.ent
 comments = machine which controls the NIM environment - code:524288
 global_export = yes
 platform = chrp
.....
```

---

To disable global exporting of NIM resources, remove the `global_export` attribute from the master by setting it to no:

```
nim -o change -a global_export=no master
```

Example 7-16 shows the output from the `nim` command when disabling global exports of NIM resources.

### *Example 7-16 Disabling global exports of NIM resources using the command line*

---

```
{nimmast}:/ # nim -o change -a global_export=no master
{nimmast}:/ # lsnim -l master | grep glob
{nimmast}:/ #
```

---

Enabling or disabling global exports while there are resources allocated to clients could lead to situations where resources are exported with incorrect permissions. In order to change the `global_export` value, all NIM operations should be completed and resources deallocated. The `nim` command fails to change the `global_exports` value if resources are currently allocated to clients.

## Checking global export of NIM resources enablement

The `lsnim` command can be used to check whether global export of NIM resources is enabled.

- ▶ The `global_export` value is set to `yes` if global export of NIM resources is enabled.
- ▶ It is not set if global export of NIM resources is disabled.

Example 7-17 shows the output for a NIM master where global export of NIM resources is enabled. Refer to Example 7-16 on page 583 to see how to check whether global export of NIM resources is disabled.

### Example 7-17 `lsnim` output

---

```
{nimmast}:/ # lsnim -l master
master:
 class = machines
 type = master
 max_nimesis_threads = 20
 if_defined = chrp.mp.ent
 comments = machine which controls the NIM environment - code:524288
 global_export = yes
 platform = chrp
 netboot_kernel = mp
.....
```

---

Network performance is conditional on several factors that are beyond the scope of this publication. For further information regarding network tuning and NFS performance refer to *AIX 5L Practical Performance Tools and Tuning Guide*, SG24-6478, and *AIX 5L Version 5.3 Performance Management Guide*, SC23-4905.

## 7.4 Booting issues

This section explains how to troubleshoot a network boot problem.

### 7.4.1 Booting

We explain all the stages of a network boot process in 7.1.1, “Troubleshooting a network boot problem” on page 566. When troubleshooting a NIM client that is having problems in some of these stages, you may need to check the packets exchange between the NIM master and NIM client. For that reason, here we take a look at the network traffic between a NIM master and a NIM client.

In this scenario we have two machines, one configured as a NIM master/server and the other configured as a NIM client. Both machines are in the same subnet. The NIM server is named lpar2, and the NIM client is named v1par3\_p5. The results for the following examples are taken on the NIM master by running the command:

```
(root@lpar2):/ # tcpdump -a 'host lpar2 and v1par3_p5'
```

The `tcpdump` command with the arguments shown here extracts the traffic between the hosts lpar2 and v1par3\_p5.

## Pinging the NIM server

In this example, we ping the NIM server from the NIM client SMS menu. The ping is successful, as shown in Example 7-18.

### *Example 7-18 Successful ping to the NIM master*

---

```
13:48:11.755361 arp who-has lpar2 tell v1par3_p5
13:48:11.755376 arp reply lpar2 is-at
13:48:11.757767 IP v1par3_p5 > lpar2: icmp 12: echo request seq 22136
13:48:11.757813 IP lpar2 > v1par3_p5: icmp 12: echo reply seq 22136
```

---

In this example the packets are reaching the NIM server and the reply is sent by the NIM server.

However, if the ping on the SMS menu of the NIM client reports the ping as unsuccessful, there may be two possible reasons for this result:

- ▶ The packages are not reaching the NIM server, in which case the `tcpdump` does not show any output.
- ▶ The replay is sent by the NIM master but does not reach the NIM client, in which case we see the reply going out of the NIM server but the NIM client SMS menu shows an unsuccessful ping.

## Bootp

Example 7-19 shows a successful exchange of packets between the NIM master and the NIM client during the bootp stage.

### *Example 7-19 Successful bootp*

---

```
14:35:52.162643 IP v1par3_p5.bootpc > lpar2.bootps: BOOTP/DHCP, Request from 22:33:80:00:80:03,
length: 300
14:35:52.174248 IP lpar2.bootps > v1par3_p5.bootpc: BOOTP/DHCP, Reply, length: 300
```

---

Example 7-20 on page 586 shows the network traffic during an unsuccessful bootp. The packets reach the NIM master, but the reply is not sent by the NIM

master to the NIM client. The problem to be resolved here is the response from the bootp. Refer to “Obtaining the boot image from the server” on page 568 for more information about resolving this problem.

*Example 7-20 Bootp failure*

---

```
13:54:21.860380 arp who-has lpar2 tell v1par3_p5
13:54:21.860390 arp reply lpar2 is-at
13:54:21.870376 IP v1par3_p5.bootpc > lpar2.bootps: BOOTP/DHCP, Request from 22:33:80:00:80:03,
length: 300
13:54:22.889784 IP v1par3_p5.bootpc > lpar2.bootps: BOOTP/DHCP, Request from 22:33:80:00:80:03,
length: 300
13:54:24.909032 IP v1par3_p5.bootpc > lpar2.bootps: BOOTP/DHCP, Request from 22:33:80:00:80:03,
length: 300
13:54:28.918683 IP v1par3_p5.bootpc > lpar2.bootps: BOOTP/DHCP, Request from 22:33:80:00:80:03,
length: 300
```

---

**tftp**

In Example 7-21, we see the packet exchange between the NIM master and the NIM client. The boot image is transferred to the NIM client. There are omitted lines. This omitted lines are the packets transferred to the NIM client containing the boot image, and their acknowledgement.

*Example 7-21 Successful tftp*

---

```
14:35:52.182347 IP v1par3_p5.4463 > lpar2.tftp: 28 RRQ "/tftpboot/v1par3_p5" octet
14:35:52.183812 IP lpar2.33444 > v1par3_p5.4463: udp 516
14:35:52.341956 IP v1par3_p5.4463 > lpar2.33444: udp 4
14:35:52.342017 IP lpar2.33444 > v1par3_p5.4463: udp 516
14:35:52.351681 IP v1par3_p5.4463 > lpar2.33444: udp 4
14:35:52.351731 IP lpar2.33444 > v1par3_p5.4463: udp 516
14:35:52.352386 IP v1par3_p5.4463 > lpar2.33444: udp 4
14:35:52.352423 IP lpar2.33444 > v1par3_p5.4463: udp 516
14:35:52.361754 IP v1par3_p5.4463 > lpar2.33444: udp 4
14:35:52.361800 IP lpar2.33444 > v1par3_p5.4463: udp 516
14:35:52.362371 IP v1par3_p5.4463 > lpar2.33444: udp 4
.....
.....
.....
14:38:04.485501 IP lpar2.33444 > v1par3_p5.4463: udp 516
14:38:04.494802 IP v1par3_p5.4463 > lpar2.33444: udp 4
14:38:04.494835 IP lpar2.33444 > v1par3_p5.4463: udp 4
14:38:04.495221 IP v1par3_p5.4463 > lpar2.33444: udp 4
14:38:04.504244 IP v1par3_p5.4463 > lpar2.33444: udp 4
14:38:04.504298 IP lpar2 > v1par3_p5: icmp 36: lpar2 udp port 33444 unreachable
14:38:26.504145 IP lpar2.1023 > v1par3_p5.shell: S 29956891:29956891(0) win 16384 <mss 1460>
14:38:27.503954 IP lpar2.1023 > v1par3_p5.shell: S 29956891:29956891(0) win 16384 <mss 1460>
14:38:30.504795 IP lpar2.1023 > v1par3_p5.shell: S 29956891:29956891(0) win 16384 <mss 1460>
```

```
14:38:35.368538 arp who-has lpar2 tell v1par3_p5
14:38:35.368551 arp reply lpar2 is-at
14:38:35.368820 IP v1par3_p5.filenet-tms > lpar2.tftp: 33 RRQ "/tftpboot/v1par3_p5.info" octet
```

---

In Example 7-22, the tftp requests are reaching the NIM master but no reply is sent by the NIM master. In this case the tftp server is not responding to the request. Refer to “Verifying tftpd” on page 572 for more information about resolving this problem.

*Example 7-22 tftp failure*

---

```
15:02:12.180427 IP v1par3_p5.appserv-https > lpar2.tftp: 28 RRQ "/tftpboot/v1par3_p5" octet
15:02:12.180486 IP lpar2 > v1par3_p5: icmp 36: lpar2 udp port tftp unreachable
15:02:12.190417 IP v1par3_p5.appserv-https > lpar2.tftp: 28 RRQ "/tftpboot/v1par3_p5" octet
15:02:12.190458 IP lpar2 > v1par3_p5: icmp 36: lpar2 udp port tftp unreachable
15:02:12.200422 IP v1par3_p5.appserv-https > lpar2.tftp: 28 RRQ "/tftpboot/v1par3_p5" octet
15:02:12.200460 IP lpar2 > v1par3_p5: icmp 36: lpar2 udp port tftp unreachable
15:02:12.210420 IP v1par3_p5.appserv-https > lpar2.tftp: 28 RRQ "/tftpboot/v1par3_p5" octet
15:02:12.210457 IP lpar2 > v1par3_p5: icmp 36: lpar2 udp port tftp unreachable
```

---

## 7.5 Log files

This section provides information about files related to NIM operations. (There are also other processes involved in NIM operations, so there are other log files that you should be checking; as mentioned in 5.3.8, “NIM communication within a firewall environment” on page 437, rsh, bootp, tftp and nfs are involved in NIM operations.)

7.5.1, “NIM-related files” on page 587, lists files from which you can gather information about NIM and related processes that may help you when troubleshooting a NIM environment.

### 7.5.1 NIM-related files

NIM creates and modifies a set of files and logs during installation and during operation. You can use these files to determine where problems are occurring for the installation that you are trying to perform. The format of the files is either text or alog.

The text file content can be displayed with your favorite text editor or command. For alog files, you must use the **alog** command (as shown in Example 7-23 on page 588) for the `/var/adm/ras/bosinstlog` file.

*Example 7-23 alog command execution*

```
alog -o -f /var/adm/ras/bosinstlog | pg
Preparing target disks.
rootvg
Making boot logical volume.
hd5
Making paging logical volumes.
hd6
Making logical volumes.
.....
```

Table 7-1 lists the files and logs created and modified by NIM.

*Table 7-1 NIM logs*

| <b>File</b>                          | <b>Content</b>                                                                                                         | <b>Text file</b> | <b>Alog file</b> |
|--------------------------------------|------------------------------------------------------------------------------------------------------------------------|------------------|------------------|
| /var/log/nimol.log                   | Installation output from the <b>nimol_install</b> command on the NIMOL server.                                         | X                |                  |
| /var/adm/ras/devinst.log             | Log information from the BOS Installation.                                                                             | X                |                  |
| /var/adm/ras/emgr.log                | Log information from the <b>emgr</b> command command execution.                                                        | X                |                  |
| /var/adm/ras/bosinstlog              | Log information from the BOS Installation.                                                                             |                  | X                |
| /var/adm/ras/nim.alt_disk_install    | Debug information from the <b>alt_disk_install</b> command execution on the client, if debug option has been selected. | X                |                  |
| /var/adm/ras/alt_disk_inst.log       | Output from the <b>alt_disk_install</b> command execution on the client, if verbose option has been selected.          | X                |                  |
| /var/adm/ras/nimsh.log               | Output from the nimsh daemon.                                                                                          | X                |                  |
| /var/adm/ras/nim.installp            | Log information from the installp operation execution.                                                                 | X                |                  |
| /var/adm/ras/install_all_updates.log | Log information from the <b>install_all_updates</b> command execution.                                                 | X                |                  |
| /var/adm/ras/nim.update              | Log information from the <b>nim_update_all</b> command execution.                                                      | X                |                  |
| /var/adm/ras/nim.setup               | Log information from <b>nim_master_setup</b> command execution.                                                        | X                |                  |

| File                    | Content                                                                                                    | Text file | Alog file |
|-------------------------|------------------------------------------------------------------------------------------------------------|-----------|-----------|
| /var/adm/ras/nim.script | Log information from a NIM script execution.                                                               | X         |           |
| /var/adm/ras/eznim.cfg  | Keeps a list of which resources are currently defined in the resource group used in the eznim environment. | X         |           |
| /var/adm/ras/nimlog     | Log for console messages printed to stderr during a NIM operation.                                         |           | X         |

## 7.5.2 RSH-related files

Table 7-2 lists the files related to rsh.

Table 7-2 rsh files

| File                        | Purpose                                                                                  |
|-----------------------------|------------------------------------------------------------------------------------------|
| \$HOME/.klogin              | Specifies remote users that can use a local user account.                                |
| /usr/lpp/ssp/rcmd/bin/rsh   | Link to AIX Secure /usr/bin/rsh that calls the SP Kerberos 4 rsh routine, if applicable. |
| /usr/lpp/ssp/rcmd/bin/remsh | Link to AIX Secure /usr/bin/rsh that calls the SP Kerberos 4 rsh routine, if applicable. |

Table 7-3 lists the files related to rshd. The rshd daemon is the server that provides the function for remote command execution.

Table 7-3 rshd files

| File             | Purpose                                                                 |
|------------------|-------------------------------------------------------------------------|
| \$HOME/.rhosts   | Specifies remote users that can use a local user account on a network.  |
| /etc/hosts.equiv | Specifies remote systems that can execute commands on the local system. |
| /etc/inetd.conf  | Defines how the inetd daemon handles Internet service requests.         |
| /etc/services    | Defines the sockets and protocols used for Internet services.           |

| File            | Purpose                                                      |
|-----------------|--------------------------------------------------------------|
| /etc/inetd.conf | Contains the configuration information for the inetd daemon. |

Information is logged also to the syslogd log file. Refer to “Enabling syslogd daemon logging” for information regarding to how to enable syslogd daemon logging.

### Enabling syslogd daemon logging

To enable the syslogd daemon logging (if it is not already enabled), follow these steps.

- ▶ Edit the /etc/syslog.conf file.
- ▶ Add a line with the message priority and destination file. Your line should look similar to the following:
 

```
*.debug /tmp/syslog.out
```
- ▶ Create the empty log file using for example the **touch** command.
- ▶ Start the syslogd daemon (if not already running), or refresh the daemon if running using src commands, as follows:
  - If syslogd daemon is already running:
 

```
refresh -s syslogd
```
  - If syslogd daemon is not running:
 

```
startsrc -s syslogd
```

Then you are able to monitor the output to find messages related to the failing component. Example 7-24 shows a line from the syslog log file related to an rsh authentication failure.

#### *Example 7-24 syslogd log content*

---

```
.....
Jun 22 10:52:05 VLPAR3_p5 daemon:warn|warning rshd[311496]: Failed rsh
authentication from nimmast for local user root via remote user root
.....
```

---

### 7.5.3 BOOTP-related files

Table 7-4 on page 591 lists the files related to bootpd. This daemon sets up the Internet Boot Protocol server. When a bootp request arrives, inetd starts the bootpd daemon. These are text files.



Table 7-4 *bootp files*

| File             | Purpose                                                       |
|------------------|---------------------------------------------------------------|
| /etc/services    | Defines the sockets and protocols used for Internet services. |
| /etc/bootptab    | Default configuration file.                                   |
| /etc/bootpd.dump | Default dump file.                                            |
| /etc/inetd.conf  | Contains the configuration information for the inetd daemon.  |

Bootpd also logs information through the syslogd daemon. See 7.5.2, “RSH-related files” on page 589 for information about how to enable syslogd logging.

## 7.5.4 TFTP-related files

Table 7-5 shows the files related to tftp and tftpd. The tftpd daemon is the server that provides the function for the Trivial File Transfer Protocol. These are text files.

Table 7-5 *tftp and tftpd files*

| File                | Purpose                                                       |
|---------------------|---------------------------------------------------------------|
| /etc/tftpaccess.ctl | Allows or denies access to files and directories.             |
| /etc/inetd.conf     | Contains the configuration information for the inetd daemon.  |
| /etc/services       | Defines the sockets and protocols used for Internet services. |

The tftpd daemon also can be given the flag `-v`. With this option, the daemon sends debugging information to the syslog daemon. See 7.5.2, “RSH-related files” on page 589 for information about how to enable syslogd logging.

Example 7-25 shows the content of the syslogd output referring to a tftp transfer.

Example 7-25 *tftpd output to syslogd*

```
.....
Jun 22 14:05:18 nimmast daemon:info tftpd[463006]: [00000102] EZZ7044I :
10.1.1.70 RRQ <file=Received , mode=/tftpboot, recognized options:
netascii>
```

```
Jun 22 14:05:18 nimmast daemon:info tftpd[463006]: [00000102] EZZ7029I : Status
Read request for 10.1.1.70: /tftpboot
Jun 22 14:05:18 nimmast daemon:info tftpd[463006]: [00000102] EZZ7046I : Status
Transaction completed successfully
.....
```

---

## 7.5.5 NFS-related file

Table 7-6 lists the file related to nfs. This is a text file.

*Table 7-6 NFS file*

| File        | Purpose                                                  |
|-------------|----------------------------------------------------------|
| /etc/rc.nfs | Contains the startup script for the NFS and NIS daemons. |

For further information regarding nfs performance, refer to *AIX 5L Practical Performance Tools and Tuning Guide*, SG24-6478.

Next, we present practical examples for a NIM environment and a POWER5 case study.

### ***NIM case study***

Here we work through the performance tuning process for an AIX system that is using the Network Installation Manager (NIM) software. Network Install Manager is a complex application which relies on several subsystems to provide software installation and maintenance in an AIX, or a mixed AIX/Linux environment (from AIX 5L V5.3).

NIM uses a client server model which provides clients with all the necessary resources for booting, installing, maintaining or diagnosing (AIX only) client machines. In a NIM environment, the following subsystems should be considered as candidates for performance tuning: network (TCP/IP), NFS, Virtual Memory Manager, Disk I/O and Logical Volume Manager (LVM).

### ***POWER5 case study***

This section considers specific POWER5 performance issues. We monitor the CPU performance of a POWER5-based system using a simple case scenario.

## 7.6 Case study: NIM server performance

In this case study we utilized an IBM eServer pSeries model 690 server that was configured into four separate logical partitions (LPAR). Each partition included one 10/100 Ethernet adapter, one gigabit Ethernet adapter, and one internal SCSI hard disk. The partition configured as the NIM master (server) also had assigned to it two fibre channel adapters and an additional local SCSI hard disk.

For our first test, we had all partitions using the 10/100 Ethernet adapters, connected to a switch, with effective link parameters of 100 Mbps, full duplex. The NIM server resources were allocated on the second internal SCSI hard disk.

Later we configured NIM to use the gigabit Ethernet (connected to a GbitE switch), and also used the external fibre channel (FC) storage, connected via a Storage Area Network (a FC switch). A diagram of our test environment is presented in Figure 7-4.

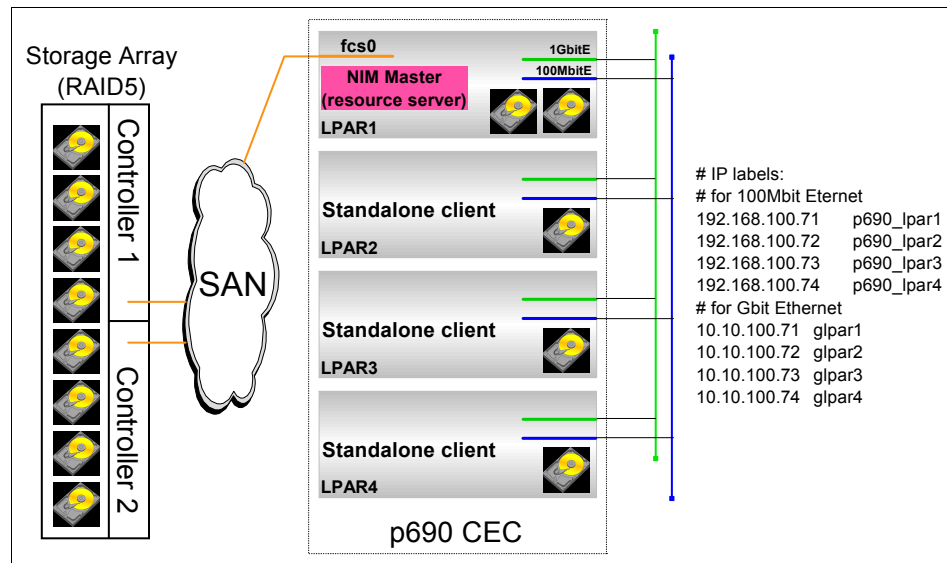

Figure 7-4 Test environment NIM diagram

### 7.6.1 Setting up the environment

We installed the NIM master (in our case, LPAR1) from AIX installation CD-ROMs with AIX 5L V5.3. For this purpose, we assigned the CD-ROM drive available in the media drawer to LPAR1.

After installation, we configured the NIM master and defined the resources to be used in our environment. We wanted to install the three remaining LPARs (LPAR2, LPAR3, LPAR4) from the NIM master.

For this purpose, in the initial phase we needed to define the following resources:

1. A NIM repository containing the software packages to be used for installing the clients (similar to the content of the AIX installation CD set). This type of resource is known as `lpp_source`.
2. A repository containing the binaries (executables) and libraries to be used for executing various operations (programs) during client installation, together with the kernel image used for booting the clients. This is known as Shared Product Object Tree (SPOT), and is a directory similar to the `/usr` file system.
3. The three clients (LPAR2, LPAR3, LPAR4), which are defined in the NIM environment as standalone machines (after installation they will boot from their own disks and run an independent copy of the operating system).

These machines are defined using the MAC address of the network (Ethernet) adapter to be used for installation and an associated IP address.

We observed that defining the LPPSOURCE- and SPOT-type resources is I/O disk resource-intensive, as explained here:

- ▶ Creating the LPPSOURCE consists of copying the necessary Licensed Program Products (LPPs) from the AIX installation CD-ROMs to a designated space on the disk.
- ▶ Creating the SPOT is similar to an installation process, where the installation takes place on the defined disk (file system) space.

After these resources were created, we installed the clients. You can install clients in a NIM environment using one of several installation types: SPOT installation; `bos rte`; or `mksysb`. During initial client installation (using the `bos rte` type), the following resources are used:

- ▶ The bootp server (to allow clients to boot over the network)
- ▶ The tftp server (to transfer the kernel to be loaded by the clients)
- ▶ The NFS subsystem (to run the install programs and retrieve the necessary LPPs for installing the client)

Because the NIM software repository resides on a file system, and this file system is NFS-exported to the NIM clients, the following subsystems are also involved during the installation process:

- ▶ The Virtual Memory Manager
- ▶ The TCP/IP subsystem
- ▶ The NFS subsystem
- ▶ The Logical Volume Manager

We found useful to tune these subsystems in order to obtain maximum performance for our NIM master. We started by monitoring an idle NIM master, and then gradually tried to identify the bottlenecks during various NIM operations.

## 7.6.2 Monitoring the NIM master using topas

During the client installation process, we began the performance tuning process for the system by monitoring it using **topas**; Example 7-26 shows the output.

*Example 7-26 topas output for NIM server*

---

```

Topas Monitor for host: p690_lpar1 EVENTS/QUEUES FILE/TTY
Fri Oct 22 17:23:42 2004 Interval: 2 Cswitch 1040 Readch 0
 Syscall 204 Writech 199
Kernel 6.2 |## Reads 0 Rawin 0
User 0.0 | Writes 0 Ttyout 199
Wait 0.0 | Forks 0 Igets 0
Idle 93.8 |##### Execs 0 Namei 2
 Runqueue 0.0 Dirblk 0
Network KBPS I-Pack O-Pack KB-In KB-Out Waitqueue 0.0
en1 11473.5 8387.0 705.0 458.8 22488.2
lo0 0.0 0.0 0.0 0.0 0.0
Disk Busy% KBPS TPS KB-Read KB-Writ Steals 0 % Comp 17.9
hdisk1 12.5 11136.0 90.0 22272.0 0.0 PgspIn 0 % Noncomp 27.6
...(lines omitted)...

```

---

As shown in the **topas** output, the only resource that was running at maximum speed was Ethernet adapter en1. A 10/100 adapter running at 100\_Full\_Duplex, has a transmit speed limit of approximately 10 Megabytes per second (10 MB/second = 10,000 KB/second). The **topas** output shows en1 at 11,437.5 KB/second.

None of the other devices were overutilized at this point. The direct attached SCSI disk hdisk1, which contained the file systems being used for the NIM resources, is only 12.5% busy.

When a resource is running at its maximum speed, and is the limiting factor in the system, you need to add additional resources. In this case, tuning will not be able to compensate for the device data rate limit of the Ethernet adapter.

To increase the network throughput bandwidth, we allocated a Gigabit Ethernet adapter to the system. A Gigabit Ethernet adapter has a one-direction maximum data rate of 100 Mbytes per second, which is ten times the rate of a 100 Mbit adapter.

## Creating a benchmark

One of the difficulties with simply monitoring the NIM server as it handles NIM client requests is that the workload varies. For tuning, it is desirable to have a representative workload that can be used as a benchmark. This benchmark workload can be run before and after tuning to see if any improvement occurs. Note that this approach does not eliminate the need to monitor the system to determine actual workload benefits from tuning, but it does provide a useful way to see if performance tuning is helping a related workload.

Because NIM uses NFS to transfer data between the server and clients, a simple workload is to mount an NFS directory on the clients and generate I/O with the `dd` command. The NIM server can use `rsh` to connect to the NIM clients, which will be useful in automating the workload.

Example 7-27 shows how to export the directory that is being used for NIM resources. Then we used the remote shell (`rsh`) to mount the exported directory on each of the NIM clients.

---

### *Example 7-27 Setting up for the NIM benchmark run*

```
exportfs -i -o root=glpar2:glpar3:glpar4 /dasbk
for i in 2 3 4 ; do
> rsh glpar$i "mount 192.168.100.71:/dasbk /mnt"
> done
```

---

To facilitate the benchmarking effort we created two scripts, one for generating write I/O and one for generating read I/O. Example 7-28 displays the NIM write I/O script.

---

### *Example 7-28 NIM write I/O benchmark script*

```
#!/usr/bin/ksh

for i in 2 3 4
do
 rsh glpar$i "dd if=/dev/zero of=/mnt/file$i bs=128K count=8000" &
done

#wait command waits for all background processes to finish before continuing
wait
```

---

Example 7-29 displays the NIM read I/O script.

---

### *Example 7-29 NIM read I/O benchmark script*

```
#!/usr/bin/ksh

for i in 2 3 4
```

```

do
 rsh glpar$i "dd if=/mnt/file$i of=/dev/null bs=128K count=8000" &
done

#wait command waits for all background processes to finish before continuing
wait

```

---

We first execute the **writenim.sh** with the **timex** command to get the total run time of the script.

*Example 7-30 NIM write I/O benchmark script using timex command*

---

```

timex ./writenim.sh
8000+0 records in
8000+0 records out
8000+0 records in.
8000+0 records out.
8000+0 records in.
8000+0 records out.

real 386.79
user 0.02
sys 0.00

```

---

We observed that it took 386.79 seconds to write 3000 MB (1000 MB per NIM client). This gives us a throughput of 7.75 MB/second.

We also collected a topas screen output, shown in Example 7-31, which showed similar results to the actual workload from Example 7-26 on page 595.

*Example 7-31 The topas output from write I/O benchmark script*

---

|                          |             |               |          |                       |         |           |                  |
|--------------------------|-------------|---------------|----------|-----------------------|---------|-----------|------------------|
| Topas Monitor for host:  | p690_lpar1  | EVENTS/QUEUES | FILE/TTY |                       |         |           |                  |
| Tue Oct 26 10:19:18 2004 | Interval: 2 | Cswitch       | 1750     | Readch 0              |         |           |                  |
|                          |             | Syscall       | 207      | Writech 95            |         |           |                  |
| Kernel                   | 13.0        | ####          |          | Reads 0 Rawin 0       |         |           |                  |
| User                     | 0.0         |               |          | Writes 0 Ttyout 95    |         |           |                  |
| Wait                     | 0.0         |               |          | Forks 0 Igets 0       |         |           |                  |
| Idle                     | 87.0        | #####         |          | Execs 0 Namei 2       |         |           |                  |
|                          |             |               |          | Runqueue 0.0 Dirblk 0 |         |           |                  |
| Network                  | KBPS        | I-Pack        | O-Pack   | KB-In                 | KB-Out  | Waitqueue | 0.0              |
| en1                      | 12011.6     | 16283.0       | 1748.0   | 23809.5               | 213.7   |           |                  |
| en0                      | 0.1         | 3.0           | 0.0      | 0.1                   | 0.0     | PAGING    | MEMORY           |
| lo0                      | 0.0         | 0.0           | 0.0      | 0.0                   | 0.0     | Faults    | 1 Real,MB 4095   |
|                          |             |               |          |                       |         | Steals    | 0 % Comp 12.8    |
| Disk                     | Busy%       | KBPS          | TPS      | KB-Read               | KB-Writ | PgspIn    | 0 % Noncomp 10.7 |
| hdisk1                   | 84.5        | 11538.0       | 358.5    | 4.0                   | 23072.0 | PgspOut   | 0 % Client 10.9  |

---

To get an accurate result from the read I/O script, we needed to unmount all the related file systems. This was necessary in order to flush the caches (both the file system cache of the NIM server and the NFS client caches of the NIM clients).

*Example 7-32 NIM read I/O benchmark script - unmounting related file systems*

---

```
umount /dasbk
mount /dasbk
for i in 2 3 4 ; do
> rsh glpar$i umount /mnt
> rsh glpar$i mount 192.168.100.71:/dasbk /mnt
> done
timex ./readnim.sh
8000+0 records in.
8000+0 records out.
8000+0 records in
8000+0 records out
8000+0 records in.
8000+0 records out.

real 268.74
user 0.02
sys 0.00
```

---

The read benchmark executed in 268.74 seconds, so the read throughput was 11.16 MB/second (3000 MB / 268.74 second).

In Example 7-33 we collected a topas screen output, which indicated that we had reached the limit of hdisk0, as well.

*Example 7-33 The topas output from read I/O benchmark script*

---

```
Topas Monitor for host: p690_lpar1 EVENTS/QUEUES FILE/TTY
Tue Oct 26 10:32:38 2004 Interval: 2 Cswitch 1232 Readch 0
 Syscall 204 Writech 170
Kernel 10.0 |###| Reads 0 Rawin 0
User 0.0 | | Writes 0 Ttyout 170
Wait 46.2 |#####| Forks 0 Igets 0
Idle 43.8 |#####| Execs 0 Namei 2
 Runqueue 0.0 Dirblk 0
Network KBPS I-Pack O-Pack KB-In KB-Out Waitqueue 3.0
en1 11799.0 8635.0 801.0 488.0 23110.1
en0 0.5 5.0 0.0 1.0 0.0 PAGING
lo0 0.0 0.0 0.0 0.0 0.0 Faults 197 MEMORY
 Steals 0 Real,MB 4095
 % Comp 12.8
Disk Busy% KBPS TPS KB-Read KB-Writ PgspIn 0 % Noncomp 5.5
hdisk1 100.0 11494.0 302.5 22988.0 0.0 PgspOut 0 % Client 5.7
```

---



### 7.6.3 Upgrading a NIM environment to Gbit Ethernet

Now that we had a representative workload, we could add the gigabit Ethernet adapter and rerun the benchmark workloads. This would give an idea of what performance increase we might get in the actual workload.

Running the NIM script for write I/O resulted in a time of 260.40 seconds for a throughput of 11.5 MB/second. The execution was identical to Example 7-30 on page 597.

We captured the output from the **topas** command was captured, as shown in Example 7-34.

*Example 7-34 The topas output from write I/O benchmark script*

---

|                          |             |               |          |         |                |
|--------------------------|-------------|---------------|----------|---------|----------------|
| Topas Monitor for host:  | p690_lpar1  | EVENTS/QUEUES | FILE/TTY |         |                |
| Tue Oct 26 11:17:07 2004 | Interval: 2 | Cswitch 14586 | Readch   | 0       |                |
|                          |             | Syscall 64    | Writech  | 148     |                |
| Kernel 63.5              | #####       | Reads         | 0        | Rawin   | 0              |
| User 0.0                 |             | Writes        | 0        | Ttyout  | 148            |
| Wait 0.0                 |             | Forks         | 0        | Igets   | 0              |
| Idle 36.5                | #####       | Execs         | 0        | Namei   | 0              |
|                          |             | Runqueue 2.5  | Dirblk   | 0       |                |
| Network KBPS             | I-Pack      | O-Pack        | KB-In    | KB-Out  | Waitqueue 0.0  |
| en0 72998.9              | 99075.0     | 9752.0        | 141.4K   | 1247.4  |                |
| en1 0.6                  | 8.0         | 1.0           | 0.8      | 0.3     | PAGING         |
| lo0 0.0                  | 0.0         | 0.0           | 0.0      | 0.0     | Faults 0       |
|                          |             |               |          |         | Steals 0       |
| Disk Busy%               | KBPS        | TPS           | KB-Read  | KB-Writ | PgspIn 0       |
| hdisk1 100.0             | 42304.0     | 661.0         | 0.0      | 84608.0 | PgspOut 0      |
| hdisk3 0.0               | 0.0         | 0.0           | 0.0      | 0.0     | PageIn 0       |
|                          |             |               |          |         | Real,MB 4095   |
|                          |             |               |          |         | % Comp 17.3    |
|                          |             |               |          |         | % Noncomp 50.5 |
|                          |             |               |          |         | % Client 50.7  |

---

As you can see, the network throughput and CPU utilization had increased, but hdisk1 (the actual disk used for NIM repository) was now 100% busy, and was the current bottleneck. Although we increased the throughput of the networking component ten-fold, our benchmark did not see the same amount of performance improvement.

This is typical of the performance tuning process. Increasing one resource often moves the bottleneck to a different component of the system.

Running the NIM script for read I/O resulted in a time of 175.87 seconds for a throughput of 17.1 MB/second. The execution was identical to Example 7-32 on page 598.

We captured the output from the **topas** command, as shown in Example 7-35 on page 600.

*Example 7-35 The topas output from read I/O benchmark script*

---

|                                      |         |         |        |               |         |           |                  |
|--------------------------------------|---------|---------|--------|---------------|---------|-----------|------------------|
| Topas Monitor for host: p690_lpar1   |         |         |        | EVENTS/QUEUES |         | FILE/TTY  |                  |
| Tue Oct 26 11:23:31 2004 Interval: 2 |         |         |        | Cswitch       | 919     | Readch    | 0                |
|                                      |         |         |        | Syscall       | 59      | Writech   | 162              |
| Kernel                               | 5.0     | ##      |        | Reads         | 0       | Rawin     | 0                |
| User                                 | 0.0     |         |        | Writes        | 0       | Ttyout    | 162              |
| Wait                                 | 95.0    | #####   |        | Forks         | 0       | Igets     | 0                |
| Idle                                 | 0.0     |         |        | Execs         | 0       | Namei     | 0                |
|                                      |         |         |        | Runqueue      | 0.0     | Dirblk    | 0                |
| Network                              | KBPS    | I-Pack  | O-Pack | KB-In         | KB-Out  | Waitqueue | 8.0              |
| en0                                  | 13896.1 | 9133.0  | 969.0  | 527.7         | 27264.4 |           |                  |
| en1                                  | 0.6     | 8.0     | 1.0    | 0.8           | 0.4     | PAGING    | MEMORY           |
| lo0                                  | 0.0     | 0.0     | 0.0    | 0.0           | 0.0     | Faults    | 526 Real,MB 4095 |
|                                      |         |         |        | Steals        | 0       | % Comp    | 17.2             |
| Disk                                 | Busy%   | KBPS    | TPS    | KB-Read       | KB-Writ | PgspIn    | 0 % Noncomp 9.5  |
| hdisk1                               | 100.0   | 13556.0 | 372.5  | 27112.0       | 0.0     | PgspOut   | 0 % Client 9.7   |
| hdisk3                               | 0.0     | 0.0     | 0.0    | 0.0           | 0.0     | PageIn    | 3388             |

---

### **NIM workload results with gigabit Ethernet**

Utilizing the benchmark script, we saw a performance improvement in both read I/O and write I/O. Next, we wanted to see what kind of improvement occurred when the NIM server handled NIM client requests. So we collected topas output as well as iostat output while three NIM client installs processed simultaneously. Example 7-36 shows the NIM server topas output.

*Example 7-36 NIM server topas output*

---

|                                      |         |         |        |               |          |           |                  |
|--------------------------------------|---------|---------|--------|---------------|----------|-----------|------------------|
| Topas Monitor for host: p690_lpar1   |         |         |        | EVENTS/QUEUES |          | FILE/TTY  |                  |
| Tue Oct 26 08:36:13 2004 Interval: 2 |         |         |        | Cswitch       | 2143     | Readch    | 0                |
|                                      |         |         |        | Syscall       | 268      | Writech   | 500              |
| Kernel                               | 15.0    | ####    |        | Reads         | 0        | Rawin     | 0                |
| User                                 | 0.0     |         |        | Writes        | 1        | Ttyout    | 326              |
| Wait                                 | 85.0    | #####   |        | Forks         | 0        | Igets     | 0                |
| Idle                                 | 0.0     |         |        | Execs         | 0        | Namei     | 2                |
|                                      |         |         |        | Runqueue      | 0.0      | Dirblk    | 0                |
| Network                              | KBPS    | I-Pack  | O-Pack | KB-In         | KB-Out   | Waitqueue | 8.0              |
| en0                                  | 28098.3 | 18455.0 | 1901.0 | 1027.2        | 55169.4K |           |                  |
| en1                                  | 0.5     | 4.0     | 2.0    | 0.2           | 0.7      | PAGING    | MEMORY           |
| lo0                                  | 0.0     | 0.0     | 0.0    | 0.0           | 0.0      | Faults    | 532 Real,MB 4095 |
|                                      |         |         |        | Steals        | 0        | % Comp    | 15.2             |
| Disk                                 | Busy%   | KBPS    | TPS    | KB-Read       | KB-Writ  | PgspIn    | 0 % Noncomp 38.8 |
| hdisk1                               | 100.0   | 27352.0 | 156.0  | 54704.0       | 0.0      | PgspOut   | 0 % Client 38.9  |

---

The output is similar to what was seen during the benchmark script runs. Network throughput had increased, but hdisk1 had become completely busy.

During the NIM client installation process, we collected **iostat** command output, using **iostat 5 >> iostat.out**. This started **iostat** collecting statistics every 5 seconds and saved the output to the file **iostat.out**. After the client installs completed, we stopped the command processing by **Ctrl-C**.

Example 7-37 shows the NIM server **iostat** output.

*Example 7-37 NIM server iostat output*

---

|        |          |         |          |         |         |        |          |
|--------|----------|---------|----------|---------|---------|--------|----------|
| tty:   | tin      | tout    | avg-cpu: | % user  | % sys   | % idle | % iowait |
|        | 0.2      | 275.4   |          | 0.0     | 16.2    | 0.2    | 83.6     |
| Disks: | % tm_act | Kbps    | tps      | Kb_read | Kb_wrtn |        |          |
| hdisk0 | 0.2      | 3.2     | 0.8      | 0       | 16      |        |          |
| hdisk1 | 100.0    | 27371.2 | 167.8    | 136856  | 0       |        |          |
| tty:   | tin      | tout    | avg-cpu: | % user  | % sys   | % idle | % iowait |
|        | 0.0      | 146.2   |          | 0.3     | 14.6    | 0.0    | 85.1     |
| Disks: | % tm_act | Kbps    | tps      | Kb_read | Kb_wrtn |        |          |
| hdisk0 | 0.2      | 4.0     | 1.2      | 0       | 20      |        |          |
| hdisk1 | 100.0    | 26365.6 | 181.0    | 131828  | 0       |        |          |
| tty:   | tin      | tout    | avg-cpu: | % user  | % sys   | % idle | % iowait |
|        | 0.0      | 224.4   |          | 0.2     | 10.3    | 0.4    | 89.1     |
| Disks: | % tm_act | Kbps    | tps      | Kb_read | Kb_wrtn |        |          |
| hdisk0 | 0.2      | 4.0     | 0.8      | 0       | 20      |        |          |
| hdisk1 | 100.0    | 22391.2 | 186.4    | 111956  | 0       |        |          |

---

## 7.6.4 Upgrading the disk storage

Using a single locally attached SCSI drive poses many problems. For example, there is no data redundancy. Also, the performance is insufficient to handle client requests.

We decided to move the NIM server resources to an IBM storage subsystem DS4500 (FAStT 900). We assigned two LUNs to the NIM server. These LUNs resided on separate RAID groups. The RAID groups were comprised of 7 disks each and were configured in RAID5, with a stripe size of 64 KB.

There were many ways of configuring these two DS4500 LUNs. Because the disk subsystem was handling the data redundancy, we did not need to use LVM

mirroring. Our two main choices at this point were to use either a spread logical volume or a striped logical volume, as explained here:

- ▶ A spread logical volume (also known as “coarse striping”), alternates data between the hdisks in a volume group on a physical partition level (PP).
- ▶ A striped logical volume alternates data between hdisks on a finer basis. With a striped logical volume, you can specify a stripe size from 4KB to 128KB (must be a power of two).

Ultimately we decided to use a JFS2 file system, which gave us additional choices about how to create the JFS2 log (inline, or on a separate logical volume).

### ***Configuring the LVM***

AIX 5.3 has the device drivers and disk type preloaded for DS4500 disk devices. After configuring the DS4500 storage and assigning the LUNs to the server, the command **cfmgmgr** detects the new storage and configures it to the system.

After the disk is configured to the system, it needs to be assigned to a volume group. After being assigned to a volume group, the disk is automatically split into physical partitions. These physical partitions can then be made into logical volumes, and the file system can be configured on the logical volumes.

To start the process we created a new volume group with the DS4500 disk devices. As shown in Example 7-38, we first listed the disks available to the system with the **lsdev** command, then defined the volume group with **mkvg**. Finally, we checked the characteristics of the volume group with **lsvg**.

#### *Example 7-38 Creating a new volume group*

---

```
lsdev -Cc disk
hdisk0 Available 3s-08-00-8,0 16 Bit LVD SCSI Disk Drive
hdisk1 Available 5M-08-00-8,0 16 Bit LVD SCSI Disk Drive
hdisk2 Available 41-08-02 MPIIO Other FC SCSI Disk Drive
hdisk3 Available 41-08-02 MPIIO Other FC SCSI Disk Drive
hdisk4 Available 41-08-02 1742-900 (900) Disk Array Device
hdisk5 Available 4Q-08-02 1742-900 (900) Disk Array Device

mkvg -y ds4500vg hdisk4 hdisk5
ds4500vg

lsvg ds4500vg
VOLUME GROUP: ds4500vg VG IDENTIFIER:
0022be2a00004c00000000ff6b94f26
VG STATE: active PP SIZE: 32 megabyte(s)
VG PERMISSION: read/write TOTAL PPs: 1022 (32704
megabytes)
```

|                     |                  |                 |                        |
|---------------------|------------------|-----------------|------------------------|
| MAX LVs:            | 256              | FREE PPs:       | 1022 (32704 megabytes) |
| LVs:                | 0                | USED PPs:       | 0 (0 megabytes)        |
| OPEN LVs:           | 0                | QUORUM:         | 2                      |
| TOTAL PVs:          | 2                | VG DESCRIPTORS: | 3                      |
| STALE PVs:          | 0                | STALE PPs:      | 0                      |
| ACTIVE PVs:         | 2                | AUTO ON:        | yes                    |
| MAX PPs per VG:     | 32512            |                 |                        |
| MAX PPs per PV:     | 1016             | MAX PVs:        | 32                     |
| LTG size (Dynamic): | 1024 kilobyte(s) | AUTO SYNC:      | no                     |
| HOT SPARE:          | no               | BB POLICY:      | relocatable            |

---

The volume group contained two physical volumes, with a physical partition (PP) size of 32 megabytes. There are a total of 1022 PP, and the volume group has a logical track group (LTG) of 1024 kilobytes.

## Spread versus striped logical volume

We could not be sure, initially, which type of logical volume would provide the best performance. To help determine which to use, we created both spread logical volumes and striped logical volumes and ran the benchmark script; see Example 7-39.

### *Example 7-39 Creating spread logical volumes and stripe logical volumes*

---

```
mklv -y'spreadlv' -t'jfs2' -e'x' ds4500vg 120
spreadlv
mklv -y'stripe1v' -t'jfs2' '-S64K' ds4500vg 120 hdisk4 hdisk5
stripe1v
```

---

After the logical volumes were created, we created the jfs2 file systems on these logical volumes.

### *Example 7-40 Create and mount file systems*

---

```
mklv -y'spreadlv' -t'jfs2' -e'x' ds4500vg 120
spreadlv
mklv -y'stripe1v' -t'jfs2' '-S64K' ds4500vg 120 hdisk4 hdisk5
stripe1v
crfs -v jfs2 -d'spreadlv' -m'/spreadfs' -A'No' -p'rw' -a agblksize='4096'
File system created successfully.
3931836 kilobytes total disk space.
New File System size is 7864320
crfs -v jfs2 -d'stripe1v' -m'/stripefs' -A'No' -p'rw' -a agblksize='4096'
File system created successfully.
3931836 kilobytes total disk space.
New File System size is 7864320
mount /spreadfs
```

```
mount /stripefs
```

---

With the file systems mounted, we needed to export the file systems and mount them on the NIM clients, as we did in Example 7-27 on page 596.

*Example 7-41 Exporting file systems for benchmark testing*

---

```
exportfs -i -o root=glpar2:glpar3:glpar4 /spreadfs
exportfs -i -o root=glpar2:glpar3:glpar4 /stripefs
```

---

**Benchmarking the spread file system**

With the file systems exported, we mounted one of them and ran the benchmark as shown in Example 7-42.

*Example 7-42 Mounting spreadfs on NIM clients*

---

```
for i in 2 3 4; do
> rsh glpar$i "mount glpar1:/spreadfs /mnt"
> done
```

---

The hostname `glpar2` is the IP label (as associated in the `/etc/hosts` file) for the LPAR2 Gbit Ethernet interface, and so on (see the IP label assignment in Figure 7-4 on page 593).

With the `spreadfs` file system NFS mounted on each of the NIM clients, we ran the same script from Example 7-28 on page 596.

*Example 7-43 Script for NIM write I/O benchmark - gigabit and DS4500*

---

```
timex ./writenim.sh
8000+0 records in.
8000+0 records out.
8000+0 records in
8000+0 records out
8000+0 records in.
8000+0 records out.

real 44.99
user 0.02
sys 0.01
```

---

With both gigabit Ethernet and the DS4500 disk subsystem, the write throughput has increased dramatically to 66.7 MB/second (3000 MB / 44.99 second).

In Example 7-44 on page 605 we show the full `topas` screen output, because there was enough load for the other values to also be of interest.

Example 7-44 The topas output for NIM write benchmark - DS4500 spread and gigabit Ethernet

---

|                          |               |                |                |               |                 |           |                    |
|--------------------------|---------------|----------------|----------------|---------------|-----------------|-----------|--------------------|
| Topas Monitor for host:  |               | p690_lpar1     |                | EVENTS/QUEUES |                 | FILE/TTY  |                    |
| Wed Oct 27 08:59:00 2004 |               | Interval: 2    |                | Cswitch       | 12640           | Readch    | 0                  |
|                          |               |                |                | Syscall       | 61              | Writech   | 163                |
| <b>Kernel</b>            | <b>92.0</b>   | #####          |                | Reads         | 0               | Rawin     | 0                  |
| User                     | 0.0           |                |                | Writes        | 0               | Ttyout    | 163                |
| Wait                     | 0.0           |                |                | Forks         | 0               | Igets     | 0                  |
| Idle                     | 8.0           | ###            |                | Execs         | 0               | Namei     | 0                  |
|                          |               |                |                | Runqueue      | 0.0             | Dirblk    | 0                  |
| Network                  | KBPS          | I-Pack         | O-Pack         | KB-In         | KB-Out          | Waitqueue | 0.0                |
| <b>en0</b>               | <b>110.8K</b> | <b>151.0K</b>  | <b>13837.0</b> | <b>219.8K</b> | <b>1861.7</b>   |           |                    |
| en1                      | 0.3           | 3.0            | 1.0            | 0.1           | 0.4             | PAGING    | MEMORY             |
| lo0                      | 0.0           | 0.0            | 0.0            | 0.0           | 0.0             | Faults    | 0 Real,MB 4095     |
|                          |               |                |                |               |                 | Steals    | 0 % Comp 17.2      |
| Disk                     | Busy%         | KBPS           | TPS            | KB-Read       | KB-Writ         | PgspIn    | 0 % Noncomp 50.4   |
| <b>hdisk5</b>            | <b>100.0</b>  | <b>54720.0</b> | <b>53.5</b>    | <b>0.0</b>    | <b>106.9K</b>   | PgspOut   | 0 % Client 50.4    |
| <b>hdisk4</b>            | <b>84.5</b>   | <b>59408.0</b> | <b>140.0</b>   | <b>0.0</b>    | <b>116.0K</b>   | PageIn    | 0                  |
| hdisk2                   | 0.0           | 0.0            | 0.0            | 0.0           | 0.0             | PageOut   | 28542 PAGING SPACE |
|                          |               |                |                |               |                 | Sios      | 27255 Size,MB 512  |
| Name                     | PID           | CPU%           | PgSp           | Owner         |                 |           | % Used 1.0         |
| <b>nfsd</b>              | <b>409606</b> | <b>50.1</b>    | <b>0.8</b>     | <b>root</b>   | NFS (calls/sec) | % Free    | 98.9               |
| j2pg                     | 147544        | 0.0            | 0.2            | root          | ServerV2        | 0         |                    |
| topas                    | 307366        | 0.0            | 1.2            | root          | ClientV2        | 0         | Press:             |
| gil                      | 73764         | 0.0            | 0.1            | root          | ServerV3        | 3412      | "h" for help       |
| pilegc                   | 61470         | 0.0            | 0.2            | root          | ClientV3        | 0         | "q" to quit        |

---

The topas output shows that some of the system resources were being fully utilized, which is desirable. The CPU was only 8% idle, but was showing zero wait time. The new disks were fully utilized, but appeared to be slightly imbalanced. And the Gbit Ethernet card throughput (one direction) was close to its maximum of 100 MB/second.

Now we ran the read I/O benchmark, making sure to flush the caches as shown in Example 7-45.

Example 7-45 Script for NIM read I/O benchmark - DS4500 spread and gigabit

---

```
umount /spreadfs
mount /spreadfs
for i in 2 3 4 ; do
> rsh glpar$i umount /mnt
> rsh glpar$i mount glpar1:/spreadfs /mnt
> done
timex ./readnim.sh
8000+0 records in.
8000+0 records out.
8000+0 records in.
8000+0 records out.
```

8000+0 records in  
8000+0 records out

real 30.20  
user 0.02  
sys 0.00

With both gigabit Ethernet and the DS4500 disk subsystem, the read throughput had increased dramatically to 99.3 MB/second (3000 MB / 30.20 second).

In Example 7-46 we show the full topas screen output, because there was enough load for the other values to also be of interest.

*Example 7-46 The topas output for NIM read benchmark - DS4500 spread and gigabit Ethernet*

---

```
Topas Monitor for host: p690_lpar1 EVENTS/QUEUES FILE/TTY
Wed Oct 27 09:04:54 2004 Interval: 2 Cswitch 6905 Readch 0
 Syscall 53 Writech 185
Kernel 52.2 |#####| Reads 0 Rawin 0
User 0.0 | | Writes 0 Ttyout 185
Wait 24.0 |#####| Forks 0 Igets 0
Idle 23.8 |#####| Execs 0 Namei 0
 Runqueue 2.5 Dirblk 0

Network KBPS I-Pack O-Pack KB-In KB-Out Waitqueue 0.5
en0 102.5K 69925.0 7118.0 4028.4 201.1K
en1 0.3 4.0 1.0 0.2 0.4
lo0 0.0 0.0 0.0 0.0 0.0
PAGING
Faults 648 Real,MB 4095
Steals 0 % Comp 17.2

Disk Busy% KBPS TPS KB-Read KB-Writ PgpsIn 0 % Noncomp 38.9
hdisk4 56.5 53248.0 1524.0 104.0K 0.0 PgpsOut 0 % Client 39.0
hdisk5 43.0 49152.0 1360.0 98304.0 0.0
hdisk2 0.0 0.0 0.0 0.0 0.0
PageIn 25584
PageOut 0 PAGING SPACE
Sios 25602 Size,MB 512
 % Used 1.0
 % Free 98.9
NFS (calls/sec)
ServerV2 0
ClientV2 0 Press:
ServerV3 3198 "h" for help
ClientV3 0 "q" to quit
```

---

Although the read throughput was higher, the resources did not report being as busy as with the write workload. The network adapter was still close to its limit at 100 MB/second.

Now that we had some numbers for a spread file system, we ran the same benchmark for the striped file system.



## Benchmarking stripe file system

To prepare for running the same benchmark against the stripe file system, we needed to unmount the spread file system from the NIM clients, and then mount the striped file system and run the script; see Example 7-47.

Example 7-47 Script for NIM write I/O benchmark - gigabit and DS4500 striped

```
for i in 2 3 4 ; do
> rsh glpar$i "umount /mnt"
> rsh glpar$i "mount glpar1:/stripefs /mnt"
> done
timex ./writenim.sh
8000+0 records in.
8000+0 records out.
8000+0 records in.
8000+0 records out.
8000+0 records in
8000+0 records out

real 98.00
user 0.02
sys 0.00
```

The striped file system finished in 98 seconds, giving a throughput of 30.6 MB/s (3000 MB/98 seconds). This was much slower than the spread file system, which finished in less than half the time at 45 seconds.

This may be a good indication that in our environment we are using large sequential reads and writes (which is a typical NIM environment).

Example 7-48 The topas output for NIM write benchmark - DS4500 stripe and Gigabit Ethernet

```
Topas Monitor for host: p690_lpar1 EVENTS/QUEUES FILE/TTY
Wed Oct 27 09:25:51 2004 Interval: 2 Cswitch 7700 Readch 0
 Syscall 54 Writech 142
Kernel 94.1 |#####| Reads 0 Rawin 0
User 0.0 | | Writes 0 Ttyout 142
Wait 0.0 | | Forks 0 Igets 0
Idle 5.9 |## | Execs 0 Namei 0
 Runqueue 17.9 Dirblk 0
Network KBPS I-Pack O-Pack KB-In KB-Out Waitqueue 0.0
en0 96998.7 127.4K10872.0 183.2K 1512.8
en1 0.5 5.0 1.0 0.6 0.3 PAGING
lo0 0.0 0.0 0.0 0.0 0.0 Faults 0 Real,MB 4095
 Steals 23301 % Comp 17.2
Disk Busy% KBPS TPS KB-Read KB-Writ PgpsIn 0 % Noncomp 77.1
hdisk5 100.0 49019.5 140.5 4.0 95584.0 PgpsOut 0 % Client 77.2
hdisk4 95.3 46992.8 782.1 20.0 91616.0 PageIn 0
```

|             |               |             |            |             |     |                 |       |              |      |
|-------------|---------------|-------------|------------|-------------|-----|-----------------|-------|--------------|------|
| hdisk2      | 0.0           | 0.0         | 0.0        | 0.0         | 0.0 | PageOut         | 24054 | PAGING SPACE |      |
|             |               |             |            |             |     | Sios            | 23294 | Size,MB      | 512  |
| Name        | PID           | CPU%        | PgSp       | Owner       |     |                 |       | % Used       | 1.0  |
| <b>nfsd</b> | <b>409606</b> | <b>52.2</b> | <b>0.8</b> | <b>root</b> |     | NFS (calls/sec) |       | % Free       | 98.9 |
| lrud        | 45078         | 26.1        | 0.1        | root        |     | ServerV2        | 0     |              |      |
| j2pg        | 147544        | 0.0         | 0.2        | root        |     | ClientV2        | 0     | Press:       |      |
| topas       | 286806        | 0.0         | 1.5        | root        |     | ServerV3        | 2976  | "h" for help |      |
| gil         | 73764         | 0.0         | 0.1        | root        |     | ClientV3        | 0     | "q" to quit  |      |

As the topas output in Example 7-48 on page 607 shows, Disk Busy% increased but KBPS for the disks was lower. The extra overhead in splitting the I/Os into 64 KB strips between the DS4500 RAID LUNs resulted in decreased write performance. Coarse striping from implementing a spread file system appears to outperform fine striping, as shown in Example 7-49.

After we observed the write performance, it was time to finish the benchmark comparison by running the read I/O script; see Example 7-49.

*Example 7-49 Script for NIM read I/O benchmark - gigabit and DS4500 striped*

```
umount /stripefs;mount /stripefs
for i in 2 3 4 ; do
> rsh glpar$i "umount /mnt"
> rsh glpar$i "mount glpar1:/stripefs /mnt"
> done
timex ./readnim.sh
8000+0 records in.
8000+0 records out.
8000+0 records in.
8000+0 records out.
8000+0 records in
8000+0 records out
real 29.46
user 0.02
sys 0.00
```

Read throughput for the striped file system was comparable and finished less than a second quicker than the spread file system. With both gigabit Ethernet and the DS4500 disk subsystem, the read throughput for the striped file system has increased to 101.8 MB/second (3000 MB/29.46 second).

In Example 7-50 we show the topas screen output for the NIM read benchmark to the striped file system.

*Example 7-50 The topas output for NIM read benchmark - DS4500 stripe and Gigabit Ethernet*

```
Topas Monitor for host: p690_lpar1 EVENTS/QUEUES FILE/TTY
```

```

Wed Oct 27 09:32:52 2004 Interval: 2 Cswitch 7185 Readch 0
 Syscall 59 Writech 228
Kernel 53.5 |#####| Reads 0 Rawin 0
User 0.0 | | Writes 0 Ttyout 228
Wait 25.0 |#####| Forks 0 Igets 0
Idle 21.5 |#####| Execs 0 Namei 0
 Runqueue 0.5 Dirblk 0

Network KBPS I-Pack O-Pack KB-In KB-Out Waitqueue 5.0
en0 104.4K 71323.0 7186.0 4107.7 204.8K
en1 0.5 3.0 1.0 0.6 0.5
lo0 0.0 0.0 0.0 0.0 0.0
PAGING MEMORY
Faults 639 Real,MB 4095
Steals 0 % Comp 17.2
Disk Busy% KBPS TPS KB-Read KB-Writ PgpsIn 0 % Noncomp 46.4
hdisk4 89.0 52166.0 1377.0 101.9K 0.0 PgpsOut 0 % Client 46.4
hdisk5 70.0 52140.0 1361.0 101.8K 0.0 PageIn 26065
hdisk2 0.0 0.0 0.0 0.0 0.0 PageOut 0 PAGING SPACE
Sios 26060 Size,MB 512
 % Used 1.0
Name PID CPU% PgSp Owner NFS (calls/sec) % Free 98.9
nfds 409606 25.0 0.8 root ServerV2 0
topas 266346 0.0 1.5 root ClientV2 0 Press:
j2pg 147544 0.0 0.2 root ServerV3 3257 "h" for help
aixmibd 442596 0.0 0.6 root ClientV3 0 "q" to quit
rpc.lockd 385272 0.0 0.2 root

```

---

The Disk Busy% was much higher for the striped file system, but the load was better balanced. The rest of the resource utilization was similar to the spread file system.

## 7.6.5 Real workload with spread file system

Although the striped file system outperformed the spread file system for read operations, the difference was small. The difference between write throughput was significant; the spread file system had more than double the write throughput of the striped file system. Because of these results, we decided to use the spread file system.

**Important:** Little benefit is gained from performing a similar procedure twice. For example, with database applications, it is good practice to avoid “double buffering”. This term refers to having both the application and the operating system use memory as cache, because this consumes memory that could be used for other operations and wastes CPU cycles by doing redundant caching.

It is a similar case with striping. DS4500 LUNs are already striped across disks, so using LVM striping across DS4500 LUNs results in (for lack of a better term) “double striping”. In effect, the DS4500 controller will receive small stripes alternating between different disk groups, but the extra striping does not benefit the disk subsystem, and could even cause performance degradation.

Therefore, it is important to understand the workload that the application is generating in order to use system resources most efficiently.

With the NIM resources moved to the spread file system, we could then monitor a real workload. For this, we simultaneously restored three NIM clients and monitored the output with **topas**, **iostat**, and **sar** as shown in Example 7-51.

*Example 7-51 The topas output after Gigabit Ethernet and DS4500 storage*

```

Topas Monitor for host: p690_lpar1 EVENTS/QUEUES FILE/TTY
Wed Oct 27 17:18:50 2004 Interval: 2 Cswitch 5126 Readch 0
 Syscall 218 Writech 645
Kernel 34.5 |#####| Reads 0 Rawin 0
User 0.2 |#| Writes 1 Ttyout 189
Wait 4.5 |##| Forks 0 Igets 0
Idle 61.2 |#####| Execs 0 Namei 2
 Runqueue 0.0 Dirblk 0
Network KBPS I-Pack O-Pack KB-In KB-Out Waitqueue 0.0
en0 73874.8 47437.0 4809.0 2651.3 141.7K
en1 0.3 5.0 1.0 0.2 0.4 PAGING
lo0 0.0 0.0 0.0 0.0 0.0 Faults 175 Real,MB 4095
 Steals 0 % Comp 18.1
Disk Busy% KBPS TPS KB-Read KB-Writ PgpsIn 0 % Noncomp 37.2
hdisk5 31.0 36776.0 261.0 73552.0 0.0 PgpsOut 0 % Client 37.3
hdisk4 28.0 35480.0 199.0 70960.0 0.0 PageIn 17942
hdisk2 0.0 0.0 0.0 0.0 0.0 PageOut 0 PAGING SPACE
 Sios 18022 Size,MB 512
Name PID CPU% PgSp Owner % Used 1.0
nfsd 409606 0.0 0.8 root NFS (calls/sec) % Free 98.9
topas 348170 0.0 1.2 root ServerV2 0
sadc 393360 0.0 0.2 root ClientV2 0 Press:
nimesis 262222 0.0 1.4 root ServerV3 2232 "h" for help

```

As you can see, the three NIM clients definitely made use of the additional network and storage resources. They did not constrain the available resources, based on the benchmark testing.

To collect iostat information we executed the command **iostat 5 60 >> iostat.out**, as shown in Example 7-52. This collected statistics every 5 seconds for 60 intervals, for a total of five minutes. We scanned through the output; Example 7-52 displays the interval where activity was the highest.

*Example 7-52 The iostat output after gigabit Ethernet and DS4500 storage*

---

|          |          |         |          |         |         |        |          |
|----------|----------|---------|----------|---------|---------|--------|----------|
| tty:     | tin      | tout    | avg-cpu: | % user  | % sys   | % idle | % iowait |
|          | 0.4      | 80.8    |          | 0.2     | 25.7    | 73.1   | 1.0      |
|          |          |         |          |         |         |        |          |
| Disks:   | % tm_act | Kbps    | tps      | Kb_read | Kb_wrtn |        |          |
| hdisk0   | 0.0      | 0.0     | 0.0      | 0       | 0       |        |          |
| hdisk1   | 0.0      | 0.0     | 0.0      | 0       | 0       |        |          |
| hdisk3   | 0.0      | 0.0     | 0.0      | 0       | 0       |        |          |
| hdisk2   | 0.0      | 0.0     | 0.0      | 0       | 0       |        |          |
| dac0     | 0.0      | 27161.6 | 97.4     | 135808  | 0       |        |          |
| dac0-utm | 0.0      | 0.0     | 0.0      | 0       | 0       |        |          |
| dac1     | 0.0      | 25395.2 | 97.0     | 126976  | 0       |        |          |
| dac1-utm | 0.0      | 0.0     | 0.0      | 0       | 0       |        |          |
| hdisk4   | 18.8     | 27161.6 | 97.4     | 135808  | 0       |        |          |
| hdisk5   | 20.0     | 25395.2 | 97.0     | 126976  | 0       |        |          |
| cd0      | 0.0      | 0.0     | 0.0      | 0       | 0       |        |          |

---

The dac0 and dac1 items in the Disks: column were the DS4500 controllers. If there were more disks per controller and activity on the disks, the dac0 and dac1 would show a cumulative value. Because there was only one disk per controller in our configuration, the values were the same for the disk and its associated controller.

As shown, the DS4500 system was handling the I/O requests and had some throughput left over. The load was spread quite evenly over the two DS4500 hdisks.

Using the **sar** command is another useful way of collecting disk statistics. To collect the disks statistics shown in Example 7-53, we executed the command **sar -d 5 60 >> sar.out**. We then scanned the output and selected the interval with the highest utilization.

*Example 7-53 The sar output after gigabit Ethernet and DS4500 storage*

---

|           |        |       |       |       |       |       |       |
|-----------|--------|-------|-------|-------|-------|-------|-------|
| 117:15:28 | device | %busy | avque | r+w/s | Kbs/s | await | aserv |
|-----------|--------|-------|-------|-------|-------|-------|-------|

```

...(lines omitted)....
 dac0 0 0.0 145 33231 0.0 0.0
 dac0-utm 0 0.0 0 0 0.0 0.0
 dac1 0 0.0 150 32261 0.0 0.0
 dac1-utm 0 0.0 0 0 0.0 0.0
 hdisk4 24 0.0 145 33231 0.0 0.0
 hdisk5 24 0.0 150 32261 0.0 0.0
...(lines omitted)....

```

---

The output from **sar -d** is similar to **iostat**, but with **sar** you receive additional values that can be useful.

Zero values for **avque**, **await**, and **avserv** are desirable. You should subject non-zero values to further investigation and tuning.

## 7.6.6 Summary

Performance tuning is an iterative process. This case study went through a few basic iterations of the process. It is important to accurately identify system bottlenecks and then make the correct choice regarding whether to add resources, tune resources, or leave the system alone.

Performance tuning on a production system is risky. Therefore, the first step in the performance tuning process is to understand the system workload and the effects of tuning commands. Also, having system backups and system documentation can provide significant assistance in recovering from bad tuning choices.

## 7.6.7 Multi-threaded option for the NIM nimesis daemon

If you are installing a large number of nodes, enable the multi-threaded option on the NIM nimesis daemon by setting the `max_nimesis_threads` value. Setting this value improves the performance of NIM when you are working with large numbers of nodes.

The multi-threaded option provides better handling of the volume of client information change requests and client state changes. Without the use of the multi-threaded option, the NIM master can become overloaded by activity on the NIM database and the number of active processes, resulting in simultaneous failures during the installation of a large number of client machines. The multi-threaded nimesis daemon will serialize and buffer NIM client requests to protect the NIM master from process overload, without causing significant performance degradation.

The number of threads assigned to this daemon determines how many simultaneous NIM client requests can be handled in the NIM environment. Because most of the NIM client requests are processed rapidly, you do not need to have one thread for every client installing.

The number of threads needed to support the activities in a NIM environment depends upon several factors. Keep the following considerations in mind then determining the appropriate number of threads:

- ▶ Number of clients that will be operated on at the same time
- ▶ Processing capacity of the NIM master machine
- ▶ What type of operations are planned

In general, one thread can support two to four clients that are installing BOS at the same time. For example, when installing 150 machines, 50 to 75 threads is sufficient. Be aware that the number of threads is also highly dependent on the processing power of the NIM master machine, and slower master machines may require more threads.

For smaller NIM environments, enabling the multi-threaded daemon can monopolize system resources on the master that will not be used. So, when installing 50 machines simultaneously, 20 to 25 threads or even the single-threaded daemon would suffice.

**Note:** The multi-threaded option alone will not allow more machines to be installed simultaneously. The multi-threaded option should be used in conjunction with global export of NIM resources, distribution of NIM resources throughout the NIM environment (that is, resource servers), and a network environment capable of handling a large volume of throughput.

You can specify a value from 20 to 150 (the default is 20). The general rule is to set it for approximately half the number of nodes on which you are operating simultaneously. For example, if you want to install 100 nodes, set the value to 50. Issue the following command to set the `max_nimesis_threads` value:

```
nim -o change -a max_nimesis_threads=50 master
```

When resources are allocated for use during NIM operations, they are NFS-exported to the client machines where the operations will be performed. If operations are performed simultaneously on many different clients, the `/etc/exports` and `/etc/xtab` files may become very large on the NIM master. This may cause size limits to be exceeded in the files, and it may also negatively affect NIM performance as the files are locked and modified for each resource allocation or deallocation.

So, if you are installing a large number of nodes, set the `global_exports` attribute to `yes` on the NIM master.

```
nim -o change -a global_export=yes master
```

It is useful to set this attribute when you are simultaneously running NIM operations to many nodes.





## General LPAR sizing and creation with mig2p5 tools

This appendix explains how to perform general LPAR sizing and creating using mig2p5 tools. The mig2p5 tools, which are a set of perl scripts, were developed to provide a set of user-friendly tools that enable you to facilitate the migration of workloads from older AIX machines to POWER5 LPARs (with either dedicated or shared processors). The mig2p5 files were written by the IBM Yorktown research team and were incorporated into the nim\_move\_up tool written by the STG team in Austin.

The mig2p5 tools have been designed to work with the nim\_move\_up tool, but can also be used as standalone scripts. In this appendix, we provide a brief introduction about how to use these scripts outside of the nim\_move\_up environment.

The appendix covers the following topics:

- ▶ An overview of the mig2p5 tools
- ▶ A description of the standalone mig2p5 tool
- ▶ Examples of using the mig2p5 tools from a NIM master

## The mig2p5 tools

The mig2p5 tools are set of perl scripts. These scripts define a process for automating the sizing and creation of POWER5 LPARS. The basic flow of this process is described as follows and is illustrated in Figure A-1.

1. Collect the source LPARs CPU and memory utilization. This task is performed by getSrcUtil.
2. Collect the source LPARs hardware configuration. This task is performed by getSrcCfg.
3. Capture the target POWER5 machine's hardware configuration. This task is performed by getTgtRsrc.
4. Generate the target LPAR's required configuration, based on the hardware requirements and CPU/memory utilization collected in step one. This task is executed by TgtCfg.
5. Create the target LPAR on the POWER5 machine via createTgtLPAR.

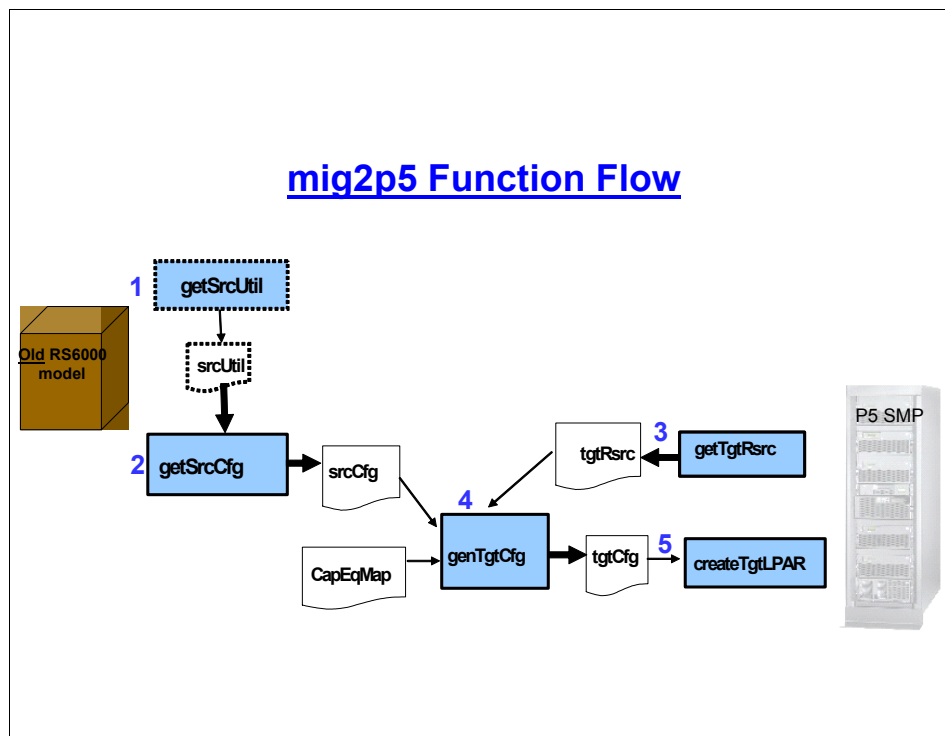

Figure A-1 mig2p5 function flow

The mig2p5 scripts are listed as follows:

```
/usr/lpp/bos.sysmgt/nim/methods/getSrcUtil
/usr/lpp/bos.sysmgt/nim/methods/getSrcCfg
/usr/lpp/bos.sysmgt/nim/methods/getTgtRsrc
/usr/lpp/bos.sysmgt/nim/methods/genTgtCfg
/usr/lpp/bos.sysmgt/nim/methods/createTgtLPAR
```

They are incorporated with the nim\_move\_up utility, but can be used outside of this to size and create new POWER5 LPARs.

### ***/usr/lpp/bos.sysmgt/nim/methods/getSrcUtil***

This script generates a file (srcUtil) containing the system's CPU and memory utilization over a period of time (which you can specify). It collects vmstat information that is used by the genTgtCfg script to size the new POWER5 LPAR.

To collect data over a longer period of time, you can adjust the interval and loop count. The following will collect performance data on LPAR4 for a 24-hour period:

```
{nimast}:/usr/lpp/bos.sysmgt/nim/methods # ./getSrcUtil -s LPAR4 -o
/tmp/mig2p5/lpar4util.out -i 10 -l 9000
```

### ***/usr/lpp/bos.sysmgt/nim/methods/getSrcCfg***

This script generates a file (srcCfg) with the source systems hardware configuration.

### ***/usr/lpp/bos.sysmgt/nim/methods/getTgtRsrc***

This script generates a file (tgtRsrc) containing information about hardware resources available on the target POWER5 machine.

### ***/usr/lpp/bos.sysmgt/nim/methods/genTgtCfg***

This script generates the new LPAR definition which will be used to create the new LPAR on the POWER5 system. It uses the capEqMap file (/usr/lpp/bos.sysmgt/nim/methods/capEqMaps), and the srcCfg and tgtRsrc files during this process. It creates a file (tgtCfg) that contains the target LPARs configuration.

## **/usr/lpp/bos.sysmgt/nim/methods/createTgtLPAR**

This script creates the new LPAR definition and profile on the POWER5 system, based on the tgtCfg file.

## **Standalone mig2p5 tool**

As shown in Figure A-2 on page 619, the mig2p5 tools can be issued from any standalone AIX 5L V5.3 machine. When issuing the tools from a standalone AIX instance, the following occurs:

1. From the standalone AIX system, getSrcUtil and getSrcCfg connect to the source system (via rsh or ssh) and collect CPU/memory utilization and hardware configuration information. Refer to 4.5, “NIM mksysb migration and nim\_move\_up POWER5 tools” on page 205 and to the topic “Setting up secure script execution between SSH clients and the HMC” (at the Web site below) for more information about configuring SSH keys for communication between an AIX host and an HMC.

<http://publib.boulder.ibm.com/infocenter/eserver/v1r3s/index.jsp>

2. getTgtRsrc connects the POWER5 HMC via ssh and gathers hardware resource information for the POWER5 machine.
3. genTgtCfg generates the target LPAR's required configuration.
4. The createTgtLPAR script creates the new LPAR definition on the POWER5 machine.

## Standalone mig2p5 Tool Issued from an AIX Instance

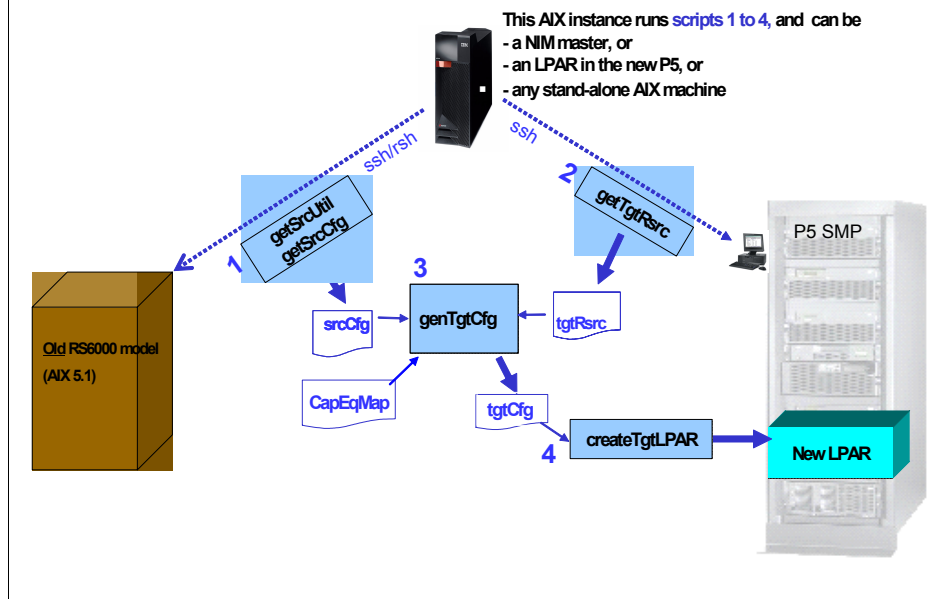

Figure A-2 Using mig2p5 to size and create a POWER5 LPAR

The following are examples of using the mig2p5 tools from a NIM master. These scripts are currently delivered via the bos.sysmgt.nim.master fileset. Note that you can copy these scripts to another AIX system if you want to run them somewhere other than the NIM master.

### Get the source LPARs hardware configuration

Example A-1 shows how to get the source LPAR hardware configuration.

*Example: A-1 Acquiring the source LPAR hardware configuration*

```
{nimmast}:/usr/lpp/bos.sysmgt/nim/methods # ./getSrcCfg -s lpar4 -o
/tmp/mig2p5/lpar4cfg.out -util /tmp/mig2p5/lpar4util.out
INPUT:
Source Hostname = lpar4
File name for source configuration= /tmp/mig2p5/lpar4cfg.out
File containing utilization data = /tmp/mig2p5/lpar4util.out

Getting the type & model of the given source machine.....

```

```
Getting the info about CPUs and Memory in the source machine.....

Adding utilization info from the /tmp/mig2p5/lpar4util.out
File.....

Getting the info about volume groups in the source machine.....

Getting the info about network adapters in the source machine....
```

---

## Get the source LPARs CPU and memory utilization

Example A-2 shows how to get the source LPAR hardware configuration.

*Example: A-2 Acquiring the source LPAR CPU and memory utilization*

---

```
{nimmast}:/usr/lpp/bos.sysmgmt/nim/methods # ./getSrcUtil -s LPAR4 -o
/tmp/mig2p5/lpar4util.out -i 10 -l 9000
```

```
The number of vmstat loops : 9000
The Average of Active virtual pages: 229 MB
The Average of Size of the free list: 6 MB
The sum of the CPU %idle: 291
The Average of CPU idle: 97.00
The Average of CPU utilization: 3.00
```

---

## Flags for getSrcCfg command

Example A-3 shows how to get the source LPAR hardware configuration.

*Example: A-3 Flags for getSrcCfg command*

---

```
{nimmast}:/usr/lpp/bos.sysmgmt/nim/methods # ./getSrcCfg
```

SYNTAX:

```
getSrcCfg -s <srcHostname> [-o <srcCfgFile>] [-util <utilFile>]
```

where

<srcHost> : Hostname of the source machine

<utilFile> : File Containing the CPU and Memory utilization

values for the source

<srcCfgFile> : Output file into which the source configuration  
will be written

-h : prints this syntax help. This flag cannot be used with other flags.

NOTE: This version only works for <srcHostname> running AIX 5.0  
and above (as it uses the lsconf command).

---

## Flags for the getSrcUtil command

Example A-4 shows how to get the source LPAR hardware configuration.

*Example: A-4 Flags for the getSrcUtil command*

---

```
{nimmast}:/usr/lpp/bos.sysmgt/nim/methods # ./getSrcUtil
```

SYNTAX:

```
getSrcUtil -s <srcHost> [-o <srcUtilFile>] [-i <interval>] [-l <loops>] [-h]
[-v]
```

where flag

```
-o writes the output to a file. Default file: /tmp/srcUtil
-i denotes the <interval> in # seconds. Default: 1
-l denotes the number of loops; Default: 10
-v Version number
```

---

## Get the target POWER5 machine resources via its HMC

Example A-5 shows how to get the source LPAR hardware configuration.

*Example: A-5 Acquiring the target POWER5 machine resources*

---

```
{nimmast}:/usr/lpp/bos.sysmgt/nim/methods # ./getTgtRsrc -hmc hmcsark -u
hscroot -m SARK-520-65C544E -viosEth VI02 -viosDisk VI02 -o
/tmp/mig2p5/tgtrsc.out
```

INPUT:

```
HMC Host = hmcsark
HMC Username = hscroot
Managed System name = SARK-520-65C544E
Ethernet VIO Server(s) = VI02
Disk VIO Server(s) = VI02
Output file = /tmp/mig2p5/tgtrsc.out
```

-----  
Getting the type & model of the given P5 machine.....

```
cmd = ssh hscroot@hmcsark lssyscfg -m SARK-520-65C544E -r sys -Ftype_model
Type-Model = 9111-520
```

-----  
Getting the number of processing units in the given P5 machine.....

```
cmd = ssh hscroot@hmcsark lshwres -m SARK-520-65C544E -r proc --level sys
-Fconfigurable_sys_proc_units
available_proc_units = 2.0
```

-----  
Getting the amount of memory in MBs in the given P5 machine.....

```

Configurable Memory = 16384
Available memory = 11648
LMB Size = 64

Getting the available physical I/O slots.....

Getting the volume groups info in the VIO Disk server(s).....
Command:
 ssh hscroot@hmcsark viosvr cmd -m SARK-520-65C544E -p VIO2 -c "\lsvg\"|
Command:
 ssh hscroot@hmcsark viosvr cmd -m SARK-520-65C544E -p VIO2 -c "\lsvg
rootvg\"|
VIO Server = VIO2; VG = rootvg; Size = 41088MB

Getting the available VLANs info in the VIO server(s).....
Command:
 ssh hscroot@hmcsark lshwres -m SARK-520-65C544E -r virtualio --subtype eth
--level lpar --filter "lpar_names=VIO2"

-Flpar_name:slot_num:port_vlan_id:is_trunk
VIO Server = VIO2; VLAN Id = 1; Slot number = 30

```

---

## Flags for the getTgtRsrc command

Example A-6 shows how to get the source LPAR hardware configuration.

### *Example: A-6 Flags for the getTgtRsrc command*

---

```
{nimmast}:/usr/lpp/bos.sysmgmt/nim/methods # ./getTgtRsrc
```

#### SYNTAX:

```
getTgtRsrc -hmc <hmcHost> -u <hmcUser> -m <managedSys> [-viosEth
<vioEthServers>] [-viosDisk <vioDiskServers>] -o <outFile>
```

where

```

<hmcHost> : Hostname of the target HMC
<hmcUser> : Name of the user on the HMC who can execute Administrative
commands
<managedSys> : Name of the target managed system
<vioEthServers> : LPAR names of the VIO servers for Ethernet.
 If you have multiple VIO server LPARs, separate
 the names with comma.
<vioDiskServers> : LPAR names of the VIO servers for Hard Disks.
 If you have multiple VIO server LPARs, separate

```



the names with comma.  
<outFile> : Name of the file into which the output will be written  
-h : Prints this syntax help. Cannot be used with other flags.  
E.g.: ./getTgtRsrc -hmc myhmc -u ssh\_user1 -m myP5 -vio vioLP1,vioLP2 -o  
tgtRsrc

---

## Flags for the genTgtCfg command

Example A-7 shows how to get the source LPAR hardware configuration.

*Example: A-7 Flags for the genTgtCfg command*

---

```
{nimmast}:/usr/lpp/bos.sysmgmt/nim/methods # ./genTgtCfg
```

SYNTAX:

```
genTgtCfg.pl -s <srcCfgFile> -m <tgtRsrcFile> -e <eqMapsFile>
 -lpar <lparName> -prof <profileName> -o <tgtLPARFile>
 [-dedCpu] [-dedEth] [-dedDisk]
```

where

```
<srcCfgFile> : Name of the file containing the source system info
<tgtRsrcFile> : Name of the file containing the target machine info
<eqMapsFile> : Name of the file containing the capacity equivalence info
<lparName> : Name of the LPAR to be created in the target machine
<profileName> : Profile for the above LPAR
<tgtLPARFile> : Name of the file into which the target LPAR configuration info
will be written.
-dedCpu : Use dedicated CPUs for the target LPAR
-dedEth : Use dedicated Ethernet adapters for the target LPAR
-dedDisk : Use dedicated hard disks for the target LPAR
-T : assess user_defined volume groups other than rootvg from the original
client
-h : Prints this syntax help. This flag cannot be used with other flags.
E.g.: ./genTgtCfg -s srcCfg -m tgtSmpRsrc -e eqMaps -lpar LP1 -prof Profile1 -o
tgtLPARcfg
```

---

## Generate the target LPARs profile information

Example A-8 shows how to get the source LPAR hardware configuration.

*Example: A-8 Generation of the target LPAR profile information*

---

```
{nimmast}:/usr/lpp/bos.sysmgmt/nim/methods # ./genTgtCfg -s
/tmp/mig2p5/lpar4cfg.out -m /tmp/mig2p5/tgtrsc.out -e
```

```
/usr/lpp/bos.sysmgmt/nim/methods/capEqMaps -lpar newlpar -prof normal -o
/tmp/mig2p5/newlparcfg.out
```

INPUT:

```
Source Configuration file : /tmp/mig2p5/lpar4cfg.out
Target Machine information file : /tmp/mig2p5/tgtrsc.out
Capacity equivalence maps file :
/usr/lpp/bos.sysmgmt/nim/methods/capEqMaps
Target LPAR name : newlpar
Name of the profile to be created in LPAR: normal
Target LPAR file : /tmp/mig2p5/newlparcfg.out
Use dedicated CPUs? : No
Use dedicated Ethernet adapters? : No
Use dedicated Hard disks? : No
```

-----  
Reading the Source Configure from the given file.....

10002

src\_mem\_util = 99

Machine Type-model of the source machine = 7040-671

Number of CPUs in the source machine = 2

Amount of memory in the source machine = 1024

Network slots in source machine = 10/100 Mbps Ethernet PCI Adapter II  
(1410ff01)

-----  
Reading the target P5 managed system configuration.....

Available processing units = 2.0

Available memory = 11648

IO slots = 21010002/none/Universal Serial Bus UHC Spec:21030002/none/Fibre  
Channel Serial Bus:21040002/none/Empty slot:21050002/none/Fibre

Channel Serial Bus:21030003/none/Empty slot:21040003/none/PCI 1Gbps Ethernet  
Fiber 2-port

Storage IO slots =

Network IO slots = 21040003/none/PCI 1Gbps Ethernet Fiber 2-port

VIO Volume groups = rootvg,VI02,41088

VIO Hard disks =

VIO VLANs = 1,VI02,30

```

src_freq = 1000, tgt_freq = 1500

Calculating the resource requirements of target LPAR.....

des_procs = 0.1
des_memory = 1024
New Physical io slots =

Creating the target LPAR configuration file.....

```

---

## Generated Target LPAR configuration information

Example A-9 shows how to get the source LPAR hardware configuration.

*Example: A-9 Generated target LPAR configuration information*

---

```

{nimmast}:/tmp/mig2p5 # cat newlparcfg.out
LPAR_NAME = newlpar
PROFILE_NAME = normal
PROC_UNITS = <min> <desired> <max>
PROC_UNITS = 0.1 0.1 0.2
MEMORY = <min MB> <desired MB> <max MB>
MEMORY = 512 1024 2048
VIO_VG_INFO = <vgname_src>,<size in MB>,<vgname_vio>,<lpar_name>
Where <vgname_src> is the VG name in source machine, and
<vgname_vio> is the VG name in VIO server LPAR
VIO_VG_INFO = rootvg,17344,rootvg,VIO2
VIO_VLAN_INFO = <vlan id>,<lpar name>,<slot number>
VIO_VLAN_INFO = 1,VIO2,30

```

---

At this point you can either choose to create the LPAR with the createTgtLPAR script or—if all you require is the sizing information (shown in Example A-9 on the newlparcfg.out file), then you can stop now.

If you want to automate the entire process from sizing to LPAR creation to NIM installation, then use the nim\_move\_up tool alone.

## Create the target LPAR definition on the POWER5 machine

Example A-10 on page 626 shows how to get the source LPAR hardware configuration.

*Example: A-10 Creation of the target LPAR definition*

---

```
{nimmast}:/usr/lpp/bos.sysmgt/nim/methods # createTgtLPAR -m
/tmp/mig2p5/tgtrsc.out -t /tmp/mig2p5/newlparcfg.out
INPUT:
Target Machine configuration file = /tmp/mig2p5/tgtrsc.out
Target LPAR configuration file = /tmp/mig2p5/newlparcfg.out
Managed system = SARK-520-65C544E
HMC Hostname = hmcsark
User configured for remote ssh to HMC = hscroot
LPAR name: newlpar
Profile name: normal
Proc units: Min=0.6, Desired=1.3, Max=2.0
CPUs: Min=1, Desired=2, Max=2
Memory: Min=3520, Desired=7040, Max=14080
Virtual IO VGs:
rootvg,17344,rootvg,VI02

Virtual IO VLANs:
1,VI02,30

Creating the target LPAR profile with proc units and memory.....
Command:
ssh hscroot@hmcsark mksyscfg -r lpar -m SARK-520-65C544E -i

name=newlpar,profile_name=normal,lpar_env=aixlinux,proc_mode=shared,sharing_mod
e=cap,min_proc_units=0.6,desired_proc_units=1.3,max_proc_units=2

.0,min_procs=1,desired_procs=2,max_procs=2,min_mem=3520,desired_mem=7040,max_me
m=14080,boot_mode=norm

Discovering the LPAR id assigned to the above LPAR.....
Command:
ssh hscroot@hmcsark lssyscfg -r lpar -m SARK-520-65C544E --filter
lpar_names=newlpar -Flpar_id
LPAR ID = 12

Adding Physical I/O slots to the LPAR profile.....
.....No physical I/O slots to add to the LPAR profile.

Adding Virtual I/O to the LPAR profile.....

Getting the list of existing vscsi devices in the VIO server.....
Command:
ssh hscroot@hmcsark viosvr cmd -m SARK-520-65C544E -p VI02 -c "\lsdev
-virtual\""
```

```

Determining the free virtual slot number in the VIO server.....
Command:
 ssh hscroot@hmcsark lshwres -r virtualio --rsubtype slot -m SARK-520-65C544E
--level slot --filter "lpar_names=VIO2" -Fslot_num

Creating virtual scsi adapter in the VIO server.....
Adding the vscsi adapter to the VIO server using DR operation.
Command = ssh hscroot@hmcsark chhwres -r virtualio --rsubtype scsi -m
SARK-520-65C544E -o a -p VIO2 -s 42 -a

"adapter_type=server,remote_slot_num=2,remote_lpar_name=newlpar"

Getting the default and current profile names of VIO server...
Command:
 ssh hscroot@hmcsark lssyscfg -r lpar -m SARK-520-65C544E --filter
"lpar_names=VIO2" -Fdefault_profile:curr_profile

Adding the vscsi adapter to the default profile of VIO server....
Command:
 ssh hscroot@hmcsark chsyscfg -r prof -m SARK-520-65C544E -i
"name=normal,lpar_name=VIO2,virtual_scsi_adapters+=42/server/12/newlpar/2/1"

Configuring the virtual scsi adapter in the VIO server.....
Command:
 ssh hscroot@hmcsark viosvrcmd -m SARK-520-65C544E -p VIO2 -c "\"cfgdev\""
:-----
Determining the OS-generated vscsi device name for the new adapter....
Command:
 ssh hscroot@hmcsark viosvrcmd -m SARK-520-65C544E -p VIO2 -c "\"lsdev
-virtual\""

Creating a logical volume in the VIO server.....
Command:
 ssh hscroot@hmcsark viosvrcmd -m SARK-520-65C544E -p VIO2 -c "\"mklv -lv
rootvg_12 rootvg 17G\""
rootvg_12

Attaching the above LV to the vscsi device created earlier.....
Command:
 ssh hscroot@hmcsark viosvrcmd -m SARK-520-65C544E -p VIO2 -c "\"mkvdev -vdev
rootvg_12 -vadapter vhost12 -dev vtscsi12\""
vtscsi12 Available

Creating the virtual scsi adapter for client LPAR.....
Command:
 ssh hscroot@hmcsark chsyscfg -r prof -m SARK-520-65C544E -i
name=normal,lpar_name=newlpar,virtual_scsi_adapters+=2/client//VIO2/42/1

```

```

Creating the virtual ethernet adapters for client LPAR.....
Command:
ssh hscroot@hmcsark chsyscfg -r prof -m SARK-520-65C544E -i
name=normal,lpar_name=newlpar,virtual_eth_adapters+=3/0/1//0/1
```

---

## Flags for the createTgtLPAR command

Example A-11 shows how to get the source LPAR hardware configuration.

*Example: A-11 Flags for the create TgtLPAR command*

---

```
{nimmast}:/usr/lpp/bos.sysmgmt/nim/methods # ./createTgtLPAR
```

### SYNTAX:

```
createTgtLPAR.pl -m <tgtMachFile> -t <tgtCfgFile> -v <vginfo_file> -T
```

where

<tgtMachFile> : File containing the information about the target machine

<tgtCfgFile> : File containing the description of the target LPAR

<vginfo\_file> : File to which the vhost and slot number of each VG is

written

-T : Create user VGs as well.

-h : Prints this syntax help. Cannot be used with other flags.

E.g.: ./createTgtLPAR -m myP5 -t myLPAR

---



# Automatic provisioning NIM and Tivoli Provisioning Manager

This appendix describes how to implement NIM as an automated provisioning tool with Tivoli Provisioning Manager. It covers the following topics:

- ▶ Overview of Tivoli Provisioning Manager
- ▶ Explanation of why to use Tivoli Provisioning Manager
- ▶ Description of the architecture
- ▶ Explanation of Tivoli Provisioning Manager terminology
- ▶ Workflow to define a NIM client
- ▶ Automated provisioning scenario
- ▶ Ways to automate

## Overview of Tivoli Provisioning Manager

IBM Tivoli Provisioning Manager (TPM) provides the capability to automate the provisioning of servers (both real and virtual), software, network connections, and storage.

TPM permits the rapid deployment of resources within your infrastructure. It is an end-to-end automation tool. It captures a customer's existing procedures by linking together their systems management tools and executing them and new processes in a repetitive, error-free manner either within or across organizational boundaries.

## Why use Tivoli Provisioning Manager

TPM helps to boost server-to-administrator ratios and reduce human error by automating the manual and repetitive steps required to provision a production server or to update it with the latest fixpack or security patch. By utilizing existing hardware, software, and network devices without rewiring, you can minimize implementation times and achieve a fast return on investment.

In addition, IBM Tivoli Provisioning Manager allows you to create, customize, and use automation workflows. Prebuilt workflows provide control and configuration of major vendors' products, and customized workflows can implement your company's data center best practices and procedures.

You can determine whether TPM is providing the workflows to automate your configuration or installation at a central Web site known as IBM Tivoli Open Process Automation Library (search for terms like “nim”, for example):

<http://catalog.lotus.com/wps/portal/tpm/>

## The architectural picture

This is a global architectural overview that includes Tivoli Intelligent Orchestrator. As shown in Figure B-1 on page 631, TPM is represented by two components: the Deployment Engine, and the Data Center Model.



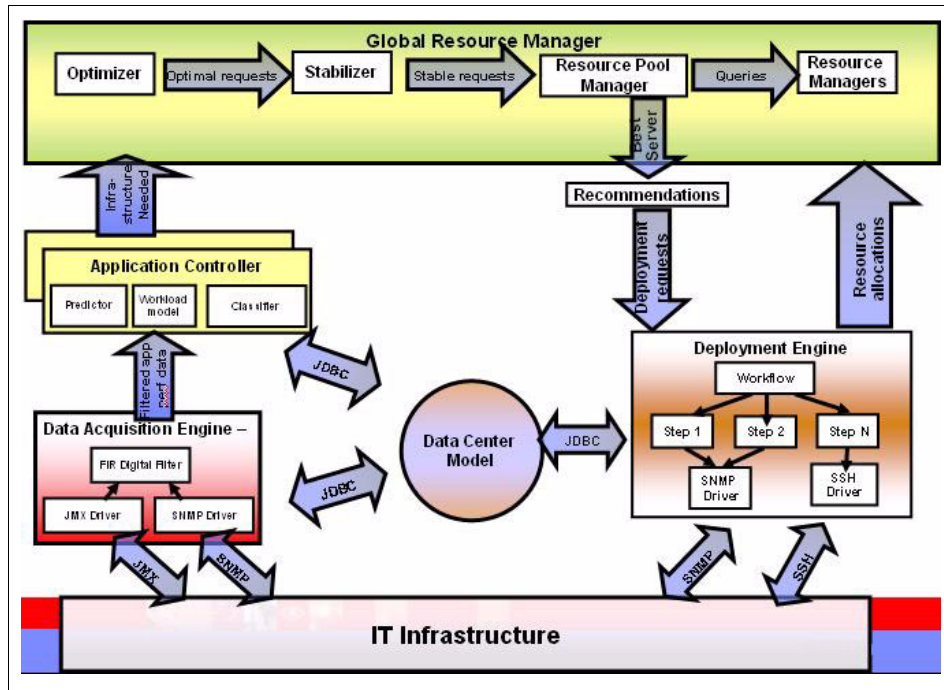

Figure B-1 TPM architecture

## TPM terminology

In this section we explain the TPM terminology used in this appendix.

### Data Center Model

The Data Center Model (DCM) represents physical and logical devices within the infrastructure that can be managed by TPM. Each object has a unique identifier, and this ID is used by the workflows during the provisioning mechanism.

### Workflow

It is a usually a best practice to complete an activity, for instance, installing an operating system. A workflow is composed of *transitions*, which are the steps to execute to complete the activity. A step could be a command, a piece of code, or another workflow.

## Driver

A driver is a package containing several workflows, documentation, and scripts. TPM provides some drivers for the IBM @server pSeries platform and AIX 5L that contain all the workflows to automate tasks; for example:

- ▶ pSeries-Server.tcdriver
- ▶ LPAR-cpu.tcdriver
- ▶ AIX-Operating-System.tcdriver
- ▶ NIM.tcdriver
- ▶ AIX-LVM.tcdriver

## Boot server

A boot server has the capability to deploy images, install an operating system, and back up images. The Network Installation Manager (NIM) master is considered a boot server.

## Software definition

A software definition represents a piece of software and the information required to install and configure it. It acts as a container that brings together all the information about a piece of software.

## Software installable

An installable file is the actual software package or image file that is distributed and installed on a target system.

## Host platform

A host platform is a hosting server (like a pSeries machine) on which logical partitions can be created. An ESX server is also a host platform because it can host virtual machines.

## Server template

A server template contains information about the required characteristics to create a server, such as CPU, memory, disk, and so on. Each value affected to a machine is deducted from the host platform.

## Discovery technology

Code is provided within TPM to automatically discover information on many types of hardware, for example, the Hardware Management Console (HMC) for the IBM @server pSeries, IBM Director for xSeries®, and NIM objects.

## TPM drivers for NIM

Figure B-1 on page 631 lists all the workflows available for the NIM driver.

Table B-1 TPM drivers available for NIM

| File                                      | Description                                                                                  |
|-------------------------------------------|----------------------------------------------------------------------------------------------|
| /repository/nim_ckstatus.sh               | Script to check NIM installation status using NIM transition.                                |
| /repository/nim_cust.sh                   | Script to launch a NIM customization operation.                                              |
| /repository/nim_define_client.sh          | Script to define a server as a client to the NIM master.                                     |
| /repository/nim_install.sh                | Script to launch a NIM BOS install.                                                          |
| /repository/nim_mk_clone.sh               | Script to create a mksysb.                                                                   |
| /repository/inventory_export.pl           | Standalone script used to export NIM inventory for population of DCM.                        |
| /doc/NIM.html                             | README.doc.                                                                                  |
| /workflow/Get_NIM_TimeOut.wkf             | Workflow to get the NIM timeout from a device or use default.                                |
| /workflow/Check_NIM_Install_Status.wkf    | Workflow to drive the nim_ckstatus.sh script.                                                |
| /workflow/Install_NIM_Client.wkf          | Workflow to drive the nim_install.sh script.                                                 |
| /workflow/Customize_a_NIM_Client.wkf      | Workflow to drive the nim_cust.sh script.                                                    |
| /workflow/NIM_Copy_File_from_Local.wkf    | Workflow to copy a local file to a server.                                                   |
| /workflow/NIM_Remote_Remove_File.wkf      | Workflow to remove a file from a server.                                                     |
| /workflow/Get_NIM_Client_Attributes.wkf   | Workflow to get NIM client variable information from a server.                               |
| /workflow/Get_NIM_Software_Attributes.wkf | Workflow to get NIM software variable information form a software product or software stack. |
| /workflow/NIM_Create_Clone_Image.wkf      | Workflow to call nim_mk_clone.sh                                                             |
| /workflow/Create_Clone_AIX_Image.wkf      | Workflow to create a mksysb of a client.                                                     |
| /workflow/Define_NIM_Client.wkf           | Workflow to drive the nim_define_client.sh script.                                           |
| /workflow/Define_NIM_Client_from_DCM.wkf  | Workflow to define a server as a NIM client to a NIM master.                                 |
| /workflow/AIX_Image_Install.wkf           | Workflow to BOS install an AIX server.                                                       |

| File                                 | Description                                                                   |
|--------------------------------------|-------------------------------------------------------------------------------|
| /workflow/AIX_Reset_Install.wkf      | Workflow to reset a NIM install.                                              |
| /workflow/AIX_Software_Install.wkf   | Workflow to Install software using the NIM management server onto a server.   |
| /workflow/AIX_Software_Uninstall.wkf | Workflow to uninstall software using the NIM management server from a server. |

## Workflow to define a NIM client

Example B-1 illustrates the workflow to define a NIM client. Notice all the ids passed as parameters; TPM is an object oriented application and provides a flexible way to write automation code for an activity.

The workflow will retrieve the NIM master name and IP address from the Data Center Model (in which you have to define the “NIM master” boot server. Then the workflow will transfer and execute the script `define_nim_client.sh` on the NIM master.

### *Example: B-1 Workflow to define a NIM client*

---

```

Licensed Materials - Property of IBM
5724-F75
(C) Copyright IBM Corp. 2003, 2004
All Rights Reserved
US Government Users Restricted Rights -Use, duplication or
disclosure restricted by GSA ADP Schedule Contract with IBM Corp.
#
#Defines a server in the DCM as a NIM client to a specified NIM master
workflow Define_NIM_Client_from_DCM(in NIM_Master_ID, out NIM_name, out
Return_code, in Server_ID, out Stderr) LocaleInsensitive
 var Unmanaged_Network_Interface_ID
 var IP_address
 var Unmanaged_Network_NIC_ID
 var NIM_name_key
 var IF_Name
 var Copied_script_location
 var mac_address
 var NIM_masterID_key
 var Server_name
 var Copied_script_name
 NIM_name_key = "NIM.name"
 NIM_masterID_key = "NIM.masterID"
```

```

 NIM_name =
DCMQuery(/Server[@id=$Server_ID]/property[@componentId="5"]/@NIM.name)

java:com.thinkdynamics.kanaha.de.javaplugin.datacentermodel.FindServer(<null>,
<null>, <null>, <null>, <null>, Server_name, <null>, <null>, Server_ID,
Unmanaged_Network_Interface_ID)

java:com.thinkdynamics.kanaha.de.javaplugin.datacentermodel.FindNetworkInterface(IP_address, <null>, <null>, IF_Name, Unmanaged_Network_Interface_ID,
Unmanaged_Network_NIC_ID, <null>, <null>)

 try
 java:com.thinkdynamics.kanaha.de.javaplugin.datacentermodel.FindNic(<null>,
<null>, mac_address, <null>, Unmanaged_Network_NIC_ID, <null>, <null>, <null>,
<null>, <null>)
 catchall
 endtry

 # Replace spaces with '_' in Server_name
 var Copy_server_name=Jython[""]

java:com.thinkdynamics.kanaha.de.javaplugin.stringoperations.ReplaceAll(Server_
name, " ", "_", Copy_server_name)

 Copied_script_name = Jython["nim_define_client_" + Copy_server_name + ".sh"
]

 NIM_Copy_File_from_Local(NIM_Master_ID, Copied_script_name, "/tmp",
Copied_script_location, "nim_define_client.sh")

 Define_NIM_Client(IF_Name, IP_address, mac_address, NIM_Master_ID, NIM_name,
Return_code, Stderr, NIM_name, Copied_script_location, Server_name)

 NIM_Remote_Remove_File(NIM_Master_ID, Copied_script_name, "/tmp")

 #Sets the NIM.masterID variable on the server
DCMInsert parent=DCMQuery(/Server[@id=$Server_ID]/@id) <<EOINSERT
 <property component="DEPLOYMENT_ENGINE" name="NIM.masterID"
value="$NIM_Master_ID" />
EOINSERT

 #Sets the NIM_name variable on the server
DCMInsert parent=DCMQuery(/Server[@id=$Server_ID]/@id) <<EOINSERT
 <property component="DEPLOYMENT_ENGINE" name="NIM.name" value="$NIM_name"
/>
EOINSERT

```

---

After you have defined the NIM client, you can use the AIX\_Image\_Install workflow to install the operating system on the client partition.

## Automated provisioning scenario

In this scenario, we describe the process of creating a partition with Tivoli Provisioning Manager, and we explain how the NIM master is used to install the operating system. We also discuss processes you can use to automate such a procedure.

TPM 3.1 provides a driver known as pSeries-Server.tcdriver. It contains a workflow to create a logical partition (LP) on POWER4 or POWER5 technologies.

Before using a workflow within TPM, we have to define the virtual objects that represent the real infrastructure. Thus, we create the following objects:

- ▶ A host platform that represents the IBM System p p570. This object is associated with the pSeries-Server.tcdriver.
- ▶ A boot server that represents the NIM master.
- ▶ A software definition for the AIX 5L operating system.
- ▶ A software installable for AIX 5L V5.3 and information for installation, as shown in Figure B-2.

| Key           | Component         | Value                  |
|---------------|-------------------|------------------------|
| NIM.bid       | Deployment engine | BID_NP_HD0             |
| NIM.fb_script | Deployment engine | ADD_ROUTE              |
| NIM.mksysb    | Deployment engine | MK_PBENCH_53ML2_291105 |
| NIM.spot      | Deployment engine | SPOT_530_ML02          |
| NIM.Timeout   | Deployment engine | 12000                  |
| OS_Type       | Entire system     | AIX                    |

Figure B-2 Variable in AIX 5L V5.3

## Partition creation

Every object in TPM has a unique identifier known as a DCM ID. Thus, each of our four required objects has its own id, which will be provided as inputs to the workflow.

A key concept within TPM is the logical operation, as shown in Figure B-3. The workflow is implementing a logical operation called `HostPlatform.CreateVirtualServer`.

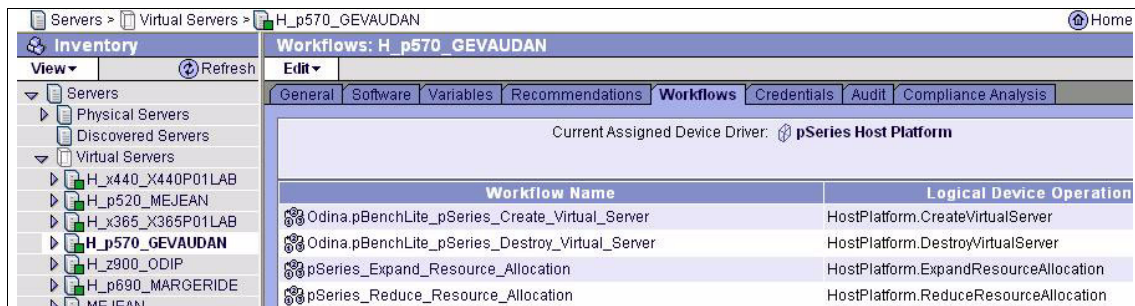

Figure B-3 Workflows

In this case, we have associated the `HostPlatform` with our custom workflow. Therefore, when the logical operation `HostPlatform.CreateVirtualServer` is called with the `HostPlatformID` as an input parameter, TPM automatically calls the following Implementation:

```
Odina.pBenchLite_pSeries_Create_Virtual_Server(HostPlatformID,
ServerTemplateID, Name, out ServerID) implements
HostPlatform.CreateVirtualServer
```

After the execution of this workflow, we will have a partition created on the machine and a virtual object in TPM (with an id of `ServerID`) to execute the other workflows.

### Partition installation

After the partition is created, we use the NIM driver to define the client and install the AIX 5L image. The same principle is applied: the boot server representing the NIM master is associated with a driver that contains implemented workflows. We have the inputs DCM ID of the NIM master and the `ServerID` that is the output of the previous creation step; for example:

```
Odina.pBenchLite_Define_NIM_Client_from_DCM(NIM_Master_ID, out
NIM_name, out Return_code, Server_ID, out Stderr)
```

We have the inputs DCM ID of the NIM master which is the `BootServerID`, and the one for the `SoftwareInstallable` which is the `SoftwareStackImageID`. The `ServerID` is the `DestinationDeviceID`; for example:

```
Odina.pBenchLite_AIX_Image_Install(BootServerID,
SoftwareStackImageID, DestinationDeviceID) implements
BootServer.InstallImage
```

## **Automation methods (interfaces, command line, Web services)**

TPM has the technical workflow to execute commands within the real infrastructure, but you still need to launch the workflows from the TPM Web interface and fill in the right parameters. If you want to automate the execution of workflows, you have several options:

- ▶ Using the TPM-provided scheduler.
- ▶ Using Tivoli Intelligent Orchestrator to sense the environment (it gets performance information from the servers running the business applications) and give orders to TPM to execute deployments.
- ▶ Using scripts associated to a custom scheduler that invoke the TPM command line interface.
- ▶ Using TPM exposed Web services to launch workflows from any other application or process.

In the On Demand IN Action Project, we used a Web service approach with a reservation portal as a front end.





# C

## **NIM and System i operating system installation for an AIX 5L LPAR**

This appendix provides an overview describing how NIM runs on a System i machine.

# IBM System i operating system installation for an AIX 5L LPAR

IBM System i and IBM System p rely on the same hardware platform and processor (POWER 5). The only differences come from the microcode and the HMC. In fact, after the System i machine has been partitioned, Network Installation Manager (NIM) does not differentiate between an AIX 5L System p partition and an AIX 5L System i partition.

The AIX 5L System i partition can be a NIM master or a NIM client. This partition can also be used as a resource server. Basically there is no difference, from the NIM perspective, between both systems.

Figure 7-5 shows an example of a mixed NIM environment with System p machines and System i machines.

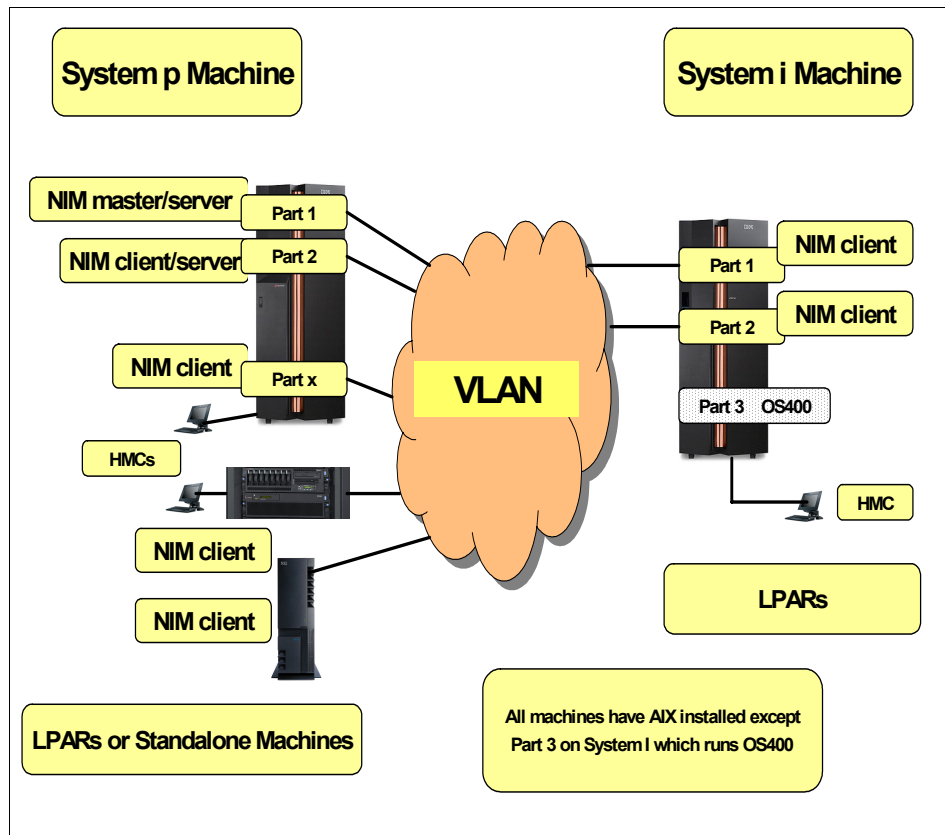

Figure 7-5 NIM environment with System i partitions

Refer to Chapter 3, “Basic configuration of a Network Installation Manager environment” on page 51 for details about how to configure and use a NIM environment.





## Additional material

This book refers to additional material that can be downloaded from the Internet as described below.

### Locating the Web material

The Web material associated with this book is available in softcopy on the Internet from the IBM Redbooks Web server. Point your Web browser to:

<ftp://www.redbooks.ibm.com/redbooks/SG247296>

Alternatively, you can go to the IBM Redbooks Web site at:

[ibm.com/redbooks](http://ibm.com/redbooks)

Select the **Additional materials** and open the directory that corresponds with the IBM Redbooks form number, SG247296.

### Using the Web material

The additional Web material that accompanies this book includes the following files:

| <i>File name</i>    | <i>Description</i>        |
|---------------------|---------------------------|
| <b>SG247296.zip</b> | Scripts used in this book |

## **System requirements for downloading the Web material**

The following system configuration is recommended:

**Operating system:** AIX

## **How to use the Web material**

Create a subdirectory (folder) on your workstation, and unzip the contents of the Web material zip file into this folder.

# Abbreviations and acronyms

|              |                                    |              |                                              |
|--------------|------------------------------------|--------------|----------------------------------------------|
| <b>AIX</b>   | Advanced Interactive Executive     | <b>GUI</b>   | graphical user interface                     |
| <b>ACL</b>   | access control list                | <b>HA</b>    | High Availability                            |
| <b>APAR</b>  | authorized program analysis report | <b>HACMP</b> | High Availability Cluster Multi-Processing   |
| <b>API</b>   | application program interface      | <b>HANIM</b> | High Availability NIM                        |
| <b>ARP</b>   | Address Resolution Protocol        | <b>HBA</b>   | Host Bus Adapter                             |
| <b>BFF</b>   | Backup File Format                 | <b>HMC</b>   | Hardware Management Console                  |
| <b>BOS</b>   | Base Operating System              | <b>HTML</b>  | HyperText Markup Language                    |
| <b>CDE</b>   | Common Desktop Environment         | <b>HTTP</b>  | HyperText Transfer Protocol                  |
| <b>CEC</b>   | Central Electronic Complex         | <b>HTTPS</b> | HTTP-Secure                                  |
| <b>CHRP</b>  | Common Hardware Reference Platform | <b>I/O</b>   | input/output                                 |
| <b>CLI</b>   | Command Line Interface             | <b>IBM</b>   | International Business Machines Corporation  |
| <b>CNAME</b> | Canonical Name                     | <b>ICMP</b>  | Internet Control Messaging Protocol          |
| <b>COSI</b>  | Common OS Image                    | <b>ID</b>    | identification                               |
| <b>CPU</b>   | central processing unit            | <b>IDE</b>   | Integrated Development Environment           |
| <b>CPUID</b> | CPU Identification                 | <b>IP</b>    | Internet Protocol                            |
| <b>CSM</b>   | Cluster Systems Management         | <b>IPL</b>   | initial program load                         |
| <b>CSP</b>   | Concluding Service Pack            | <b>ITSO</b>  | International Technical Support Organization |
| <b>CWD</b>   | Current Working Directory          | <b>JFS</b>   | Journaled File System                        |
| <b>DHCP</b>  | Dynamic Host Configuration Program | <b>LAN</b>   | local area network                           |
| <b>DLPAR</b> | Dynamic LPAR                       | <b>LDAP</b>  | Lightweight Directory Access Protocol        |
| <b>DMZ</b>   | Demilitarized Zone                 | <b>LED</b>   | light emitting diode                         |
| <b>DNP</b>   | Dynamic Node Priority              | <b>LIC</b>   | Licensed Internal Code                       |
| <b>DNS</b>   | Dynamic Name Service               | <b>LPAR</b>  | logical partition                            |
| <b>FC</b>    | Fibre Channel                      | <b>LPP</b>   | Licensed Program Product                     |
| <b>FQDN</b>  | Fully Qualified Domain Name        | <b>LTG</b>   | Logical Track Group                          |
| <b>FTP</b>   | File Transfer Protocol             | <b>LUN</b>   | logical unit number                          |
| <b>GSA</b>   | Global Storage Architecture        | <b>LV</b>    | Logical Volume                               |

|              |                                      |               |                                                 |
|--------------|--------------------------------------|---------------|-------------------------------------------------|
| <b>LVD</b>   | Low-Voltage Differential (SCSI)      | <b>ROM</b>    | Read-Only Memory                                |
| <b>LVM</b>   | Logical Volume Manager               | <b>RPC</b>    | Remote Procedure Call                           |
| <b>MAC</b>   | Media Access Card                    | <b>RPD</b>    | RSCT Peer Domain                                |
| <b>ML</b>    | Maintenance Level                    | <b>RPM</b>    | RPM Package Manager                             |
| <b>MPIO</b>  | Multi-Path I/O                       | <b>RSA</b>    | Remote Supervisor Adapter                       |
| <b>MTU</b>   | Maximum Transfer Unit                | <b>RSCT</b>   | Reliable Scalable Clustering Technology         |
| <b>NFS</b>   | Network File System                  | <b>RSH</b>    | Remote Shell                                    |
| <b>NIC</b>   | Network Interface Card               | <b>SAN</b>    | Storage Area Network                            |
| <b>NIM</b>   | Network Install Manager              | <b>SCSI</b>   | Small Computer Systems Interface                |
| <b>NIMSH</b> | NIM Service Handler                  | <b>SDD</b>    | Subsystem Device Driver                         |
| <b>NIS</b>   | Network Information Service          | <b>SDDPCM</b> | SDD Path Control Module                         |
| <b>NTP</b>   | Network Time Protocol                | <b>SDK</b>    | Systems Development Kit                         |
| <b>ODM</b>   | Object Data Manager                  | <b>SLES</b>   | SUSE Linux Enterprise Server                    |
| <b>PC</b>    | personal computer                    | <b>SME</b>    | Systems Management Environment                  |
| <b>PCI</b>   | Peripheral Component Interconnect    | <b>SMIT</b>   | System Management Interface Tool                |
| <b>PCI-X</b> | PCI-Extended                         | <b>SMS</b>    | System management Services                      |
| <b>PCM</b>   | Path Control Module                  | <b>SOE</b>    | Standard Operating Environment                  |
| <b>PID</b>   | Process ID                           | <b>SPOC</b>   | single point of control                         |
| <b>PP</b>    | physical partition                   | <b>SPOT</b>   | Shared Product Object Tree                      |
| <b>PSSP</b>  | Parallel Systems Support Program     | <b>SRC</b>    | System Resource Controller                      |
| <b>PTF</b>   | Program Temporary Fix                | <b>SRPM</b>   | Source RPM                                      |
| <b>PVID</b>  | Physical Volume ID                   | <b>SSH</b>    | Secure Shell                                    |
| <b>PXE</b>   | Pre-boot eXecution Environment       | <b>SSL</b>    | Secure Socket Layer                             |
| <b>RAID</b>  | Redundant Array of Independent Disks | <b>SUMA</b>   | Service Update Management Assistant             |
| <b>RAM</b>   | Random Access Memory                 | <b>TCB</b>    | Trusted Computing Base                          |
| <b>RAS</b>   | Reliably Availability Serviceability | <b>TCP</b>    | Transmission Control Protocol                   |
| <b>RFC</b>   | Request For Comment                  | <b>TCP/IP</b> | Transmission Control Protocol/Internet Protocol |
| <b>RHEL</b>  | RedHat Enterprise Linux              | <b>TFTP</b>   | Trivial File Transfer Protocol                  |
| <b>RM</b>    | Resource Manager                     |               |                                                 |
| <b>RMC</b>   | Resource Monitoring and Control      |               |                                                 |



|              |                                |
|--------------|--------------------------------|
| <b>TID</b>   | Thread ID                      |
| <b>TL</b>    | Technology Level               |
| <b>TOC</b>   | table of contents              |
| <b>TPM</b>   | Tivoli Provisioning Manager    |
| <b>TPS</b>   | Transactions Processing System |
| <b>TSM</b>   | Tivoli Storage Manager         |
| <b>UDP</b>   | Universal Datagram Protocol    |
| <b>URL</b>   | Universal Resource Locator     |
| <b>VG</b>    | Volume Group                   |
| <b>VIO</b>   | virtual I/O                    |
| <b>VIOS</b>  | VIO Server                     |
| <b>VIPA</b>  | Virtual IP Address             |
| <b>VLAN</b>  | Virtual LAN                    |
| <b>VLSI</b>  | Very Large Scale Integration   |
| <b>VSCSI</b> | Virtual SCSI                   |
| <b>XML</b>   | eXtended Markup Language       |



# Related publications

The publications listed in this section are considered particularly suitable for a more detailed discussion of the topics covered in this book.

## IBM Redbooks

For information on ordering these publications, see “How to get IBM Redbooks” on page 650. Note that some of the documents referenced here may be available in softcopy only.

- ▶ *Linux Applications on pSeries*, SG24-6033
- ▶ *AIX 5L Practical Performance Tools and Tuning Guide*, SG24-6478
- ▶ *Advanced POWER Virtualization on IBM System p5*, SG24-7940
- ▶ *NIM From A to Z in AIX 4.3*, SG24-5524

## Other publications

This publication is also relevant as a further information source:

- ▶ *AIX 5L V5.3 Installation and Migration*, SC23-4887
- ▶ *AIX 5L Version 5.3 Performance Management Guide*, SC23-4905
- ▶ *AIX 5L Version 5.3 Commands Reference, Volume 3*, SC23-4890
- ▶ *General Programming Concepts: Writing and Debugging Programs*, SC23-4896

## Online resources

These Web sites and URLs are also relevant as further information sources:

- ▶ SUMA is a complement to the UNIX servers product family portion of the IBM Support Fix Central  
<http://www.ibm.com/eserver/support/fixes/>
- ▶ RPM Package Manager  
<http://www.rpm.org/>

- ▶ AIX 5.3 TL4 Release Notes  
[http://publib.boulder.ibm.com/infocenter/pseries/v5r3/topic/com.ibm.aix.resources/RELNOTES/5304\\_base\\_relnotes.pdf](http://publib.boulder.ibm.com/infocenter/pseries/v5r3/topic/com.ibm.aix.resources/RELNOTES/5304_base_relnotes.pdf)
- ▶ VIO Server documentation  
<http://publib.boulder.ibm.com/infocenter/eserver/v1r3s/topic/iphb1/iphb1kickoff.htm>
- ▶ SUMA white paper  
<http://www.ibm.com/servers/aix/whitepapers/suma.html>
- ▶ IBM AIX 5L Service Strategy  
[http://www.ibm.com/servers/eserver/support/unixservers/aix\\_service\\_strategy.html](http://www.ibm.com/servers/eserver/support/unixservers/aix_service_strategy.html)
- ▶ CSM documentation  
<http://publib.boulder.ibm.com/infocenter/pseries/v5r3/topic/com.ibm.help.csm.doc/csm.html>

## How to get IBM Redbooks

You can search for, view, or download Redbooks, Redpapers, Hints and Tips, draft publications and Additional materials, as well as order hardcopy Redbooks or CD-ROMs, at this Web site:

[ibm.com/redbooks](http://ibm.com/redbooks)

## Help from IBM

IBM Support and downloads

[ibm.com/support](http://ibm.com/support)

IBM Global Services

[ibm.com/services](http://ibm.com/services)

# Index

## A

adapter definition file 423  
AIX migration 180  
alog 70  
alt\_disk\_install 168, 261  
alternate boot image 280  
alternate disk migration 123, 163, 168, 261, 265, 276  
alternate NIM master 43, 125, 128, 130, 132–133, 307, 311, 317, 390, 407  
alternate\_disk\_install 130  
alternate\_master 11, 13  
APAR 319  
attribute 416  
availability 45, 50

## B

backup 2–3, 5, 451  
backup file 55  
Backup File Format (BFF) 355  
basic resources 17, 31–32  
BFF 20–21, 123, 354  
BFF package 359  
bffcreate 71, 73, 116  
boot file 67–68, 70  
boot image 35  
BOOTP 68, 83, 86, 93, 284–285, 439  
bootp 51, 68, 438  
BOOTP client 439  
BOOTP server 439  
bootpd 66–68  
BOS install 17, 33, 42  
BOS installation 198, 415, 467, 473, 475  
bos rte install 53  
BOS run-time environment 277  
bosinst.data 127, 199, 203, 206, 210–212, 216, 228, 389, 465  
bosinst\_data 11–12, 14–16, 23, 47–48, 113, 117–118, 121–122  
BOSINST\_DEBUG 199  
bundles 354, 370

## C

cdmount 72  
check 414  
class name 13  
classes 11–12, 18  
client 10, 30  
client CPUID 426  
clients 8, 10, 26, 28–29, 36, 41–42, 44, 46, 49  
cloning 263, 475  
Cluster Systems Management (CSM) 2, 4  
command  
    /usr/sbin/rsct/install/bin/cfgct 462  
    /usr/sbin/rsct/install/bin/uncfgct -n 462  
alt\_disk\_install 158, 281  
alt\_disk\_install -x altinst\_rootvg 284  
backupos 386  
bicheck 211  
blvset 170  
bootlist 166, 187, 291  
bootptodhcp 288  
bosboot 279  
cfgdev 380  
cfgmgr 383  
chmod 126  
chresponse 403  
claddserv 311  
clfindres 315  
clRGmove 314–315  
compare\_report 324, 341–342, 345  
cp 366  
cthactrl 400  
cthasctrl 400  
cthatstune 400  
ctskeygen 478  
ctsthl 401, 477  
dig 322  
exportfs 304  
gencopy 39  
geninstall 39, 355  
geninv 342  
grep 352  
host 322  
installios 385  
installp 21, 126, 355, 361

- instfix 341
- inutoc 126
- lppchk 258, 465
- lppmgr 333
- lscfg 286
- lscmg 399
- lscosi 303
- lslpp 341
- lsnim 153, 160, 444
- lsnim -a info 191
- lsnim -c groups 16
- lsnim -c machines 12
- lsnim -c networks 14
- lsnim -l 13
- lsnim -t spot 19
- lsrpdomain 394
- lsrpnode 395
- lsrsrc 395, 477
- lsrsrcs 316
- lssrc 316
- lsts 304
- lsvg 171
- mkcondition 403
- mkcondresp 405
- mkcosi 302
- mkinstallp 355
- mkszfile 470
- mkts 303
- netstat 441
- nfso 448
- nim 39, 223
- nim\_clients\_setup 42, 119
- nim\_master\_setup 41, 53, 115
- nim\_move\_up 44, 205, 217, 222
- nim\_move\_up -r 245
- nimadapters 415, 421, 423
- nimadm 218
- nimclient 425, 435
- nimclient -C 427
- nimclient -P 436
- nimclient -p 436
- nimconfig -c 432
- nimdef 120
- niminit 268
- niminv 324
- nimquery 426
- nslookup 322
- oslevel 341, 465, 480
- oslevel -r 20

- preprnode 393
- restore 360
- restvg 465
- rmcosi 303
- rmts 306
- rpm 347, 364
- rpbuid 364
- savevg 464
- script 169, 202
- showled 198
- snap 153, 169, 171
- startcondresp 405
- startrpdomain 394
- stoprpnode 406
- suma 320, 326, 334
- vmstat 232
- wsm 96
- commands
  - lsnim 455
  - mount 419
  - nimadapters 415–416
  - nimclient 425
- common OS image 299
- Common OS Image (COSI) 123, 302
- Concluding Service Pack (CSP) 54, 479
- console 10, 16, 23, 36, 459
- control\_flow stanza 199
- COSI 123, 298
  - operations 301
- CPU utilization statistics 235
- cron 132, 156, 175, 196, 320, 328
- crontab 132, 329–331
- cryptographic authentication 433–434
- CSP 54, 56–57
- Cstate 13, 35–36, 192, 213, 256–257
- ctrl\_hosts 138
- customization 258

## D

- daemon
  - dhcpcsd 291
  - inetd 286
  - nim 440
  - nimesis 436
  - nimreg 440
  - NIMSH 425
  - nimsh 426
  - rshd 263, 425, 451

- dataless 8, 11, 29, 79, 96, 125, 298–299, 301, 303–304, 389
  - operations 301
- dataless machine 299
- debug output 199
- Device drivers 17
- DHCP 284, 286
- DHCP server 285, 290
- diagnostic 479
- directory
  - /ftptboot 178, 460
  - /usr/es/sbin/cluster/utilities 311
  - /usr/lpp/bos.sysmgmt/nim/methods 425
  - RPMS/ppc 137
- disaster recovery 3
- diskless 8, 11, 29, 79, 96, 125, 298–299, 301, 303, 305, 389
  - operations 301
- diskless machine 299
- DNS 33, 476
- DVD 55, 71–72, 74, 83, 91, 99

## E

- Etherchannel 49
- Ethernet 2, 461
- EXISTING\_SYSTEM\_OVERWRITE 468
- EZNIM 30, 115

## F

- Fibre Channel 49–50, 244, 461
- file
  - .toc 414
  - /etc/bootptab 287, 437, 460
  - /etc/ct\_node\_id 462, 478
  - /etc/dhcpsd.cnf 285, 288
  - /etc/environment 435
  - /etc/exports 437
  - /etc/filesystems 284
  - /etc/group 263
  - /etc/hosts 222
  - /etc/inetd.conf 286
  - /etc/irs.conf 310
  - /etc/motd 174
  - /etc/netsvc.conf 310
  - /etc/niminfo 426, 437, 445, 447
  - /etc/passwd 263
  - /etc/security/passwd 263
  - /etc/sendmail.cf 174

- /etc/tunables/nextboot 171, 263
- /usr/lpp/bosinst/bosinst.template.README 467
- /usr/sbin/cluster/netmon.cf 310
- /var/adm/ras/nimsh.log 426
- /var/ct/cfg/ct\_has.thl 477
- /var/ct/cfg/ctrmc.acls 462, 476, 478
- ~/rhosts 268, 451, 474
- bosinst.data 127
- bosint.data 465
- ct\_has.pkf 478
- ct\_has.qkf 478
- image.data 465
- secondary adapter rules 416
- fileset
  - bos.alt\_disk\_install.rte 249
- filesets 8, 17, 20–22, 27, 29, 31, 36, 39
- firewall 424, 434, 437, 450
- firstboot script 127
- fixes 8, 40
- FTP 320

## G

- Groups class 12, 16

## H

- HACMP 123, 164, 168–169, 307–312, 314, 316, 318
  - application server 311
  - DNP 316
  - Dynamic Node Priority 316
  - resource group 311
- HACMP configuration 308, 311
- HANIM 123, 154, 307, 313
- hardlink 76
- Hardware Management Console (HMC) 153
- High Availability NIM 154
- High Availability Cluster Multi-Processing 307
- HMC 5, 8, 10, 180, 191, 202, 222, 228, 476
- HMC command
  - vtmenu 199
- hostname 476
- HTTP 320
- HTTPS 320
- hypervisor 53

## I

- IBM System p 4–5

image.data 127, 159, 175, 203, 248, 250, 274, 349,  
354, 386, 465  
image\_data 11, 16, 47–48  
inetd 66–70  
install 3–4  
installation method 23, 33  
installing 1  
installp 63, 71–72, 74–75  
installp bundle 452  
installp\_bundle 130, 370–371  
IP label 32  
irs.conf 65–66

## K

kernel 35, 451

## L

LDAP 476  
LED code 463  
LED code 605 463  
Linux 53  
Linux clients 137  
Linux distribution 293  
linux\_source 137–139  
local disk caching 272  
LPAR 2  
lpp\_source 11–12, 15–16, 18, 20–22, 26–27,  
31–32, 36–37, 39–41, 43–45, 47–48, 54–57, 59–60,  
63, 71–74, 83, 103–104, 112, 116–117, 119,  
121–122, 126–127, 130, 137, 139, 143, 146, 148,  
154, 160, 178–179, 213, 217–219, 223, 225, 227,  
230–232, 235, 247, 249, 253, 256, 258–259, 262,  
266, 272, 276, 302, 309–310, 323, 333–337,  
339–340, 344–345, 355, 362–363, 368–369, 372,  
392, 410, 414  
lppmgr 37, 40, 412  
lsnim 59, 61–62, 72–73, 78–80, 121–122  
lssrc 66  
LUN 188

## M

MAC address 286  
mac\_group 11–12, 16  
machines 8–13, 16–17, 23, 26–28, 35, 53, 57–59,  
61–62, 64, 79–80, 96, 115, 117, 120, 122  
Machines class 12  
maintain 2–4

maintenance 479  
maintenance level 47, 319  
manual network boot 214  
master 8–12, 14–15, 19, 22–23, 26–28, 30–32, 36,  
38, 41, 43, 45–46, 49–50, 410  
memory utilization statistics 235  
microcode 153  
micro-partition 209  
Micro-partitioning 5  
migration 191  
minimum AIX image 10  
mksysb 3, 11, 15, 20, 22–23, 26–28, 33, 39–44,  
47–48, 53–55, 57–58, 71, 76, 82, 94, 115–118,  
121–123, 127, 145, 147–151, 153, 158, 163–165,  
169, 173, 196–197, 205–206, 208, 210–218,  
220–221, 223–224, 246–247, 249–252, 254, 256,  
261, 264, 271, 349–352, 354, 385–389, 463  
mksysb image 451–453, 464  
mksysb installation 221  
mksysb migration 44, 205, 212, 214, 461  
ML 3  
Mstate 13, 36, 193

## N

name resolution 26  
naming convention 10, 47, 49, 54–58  
net\_addr 59, 118  
netboot 291  
Netmask 58  
netname 60  
netsvc.conf 65  
network boot 3, 457  
network install 437  
Networks class 12–13  
NFS 17–18, 27, 440  
NFS reserved ports 441–442  
    disabling 447  
    enabling 445  
NFS server 448  
NFS server portcheck 449  
nfs\_reserved\_port 444, 447  
NIM 1, 3–5  
NIM client 10, 32, 34, 46  
    maintenance 478  
NIM client installation 84  
NIM client migration 169  
NIM database 11–12, 14, 18, 51, 64, 76, 78, 177,  
440



- nim group 3
- NIM install 437
- NIM master takeover 124
- NIM methods
  - /usr/lpp/bos.sysmgmt/nim/methods/c\_cfgadptrs 415
- NIM migration 460
- NIM name 14
- NIM network 58–59, 79–80, 101
- NIM operation 426, 450
  - bos\_inst 219
  - change 447
  - check 414
  - COSI operations 301
  - customization 424
  - dataless client 301
  - diskless client 301
  - installing RPM packages 368
  - nim\_move\_up 44
  - nimadm 283
- NIM operations
  - nim -o bos\_inst 415, 417
  - nim -o cust 415, 417
- NIM resource 9, 14
  - BOSINST\_DATA 223
  - bosinst\_data 198, 213, 451, 467
  - deallocating 288
  - exclude\_files 223
  - image\_data 473
  - installp\_bundle 371
  - mksysb 212, 452, 454, 457
  - SPOT 213, 452
- NIM server 2
- NIM synchronization 124, 126–127, 130, 132–133
- NIM takeover 135, 403
- NIM terminology 7
- NIM update 411
- nim\_bosinst 84
- NIM\_MKSYSB\_SUBDIRS 55, 57
- nim\_move\_up 123, 151, 205, 216–226, 228, 230–233, 235, 245, 247, 249, 253–257, 259–261
- nim\_script 55, 60, 62, 117–118, 122
- nimadm 261, 263–264, 274
  - Local Disk Caching 263
- nimclient 63
- nimconfig 60–61, 63, 72
- nimesis 60, 63, 79, 116
- niminit 60, 63–64
- nimlog 70

- NIMSH 425–426, 428, 433–434
  - cryptographic authentication 426
  - NIM Service Handler 425
- nimsh 43, 45
- NIMSH secondary port 434
- Nstate 14
- NTP 476

## O

- Object Data Management 11
- Object Data Manager 62
- ODM 11, 62, 277
- OpenSSH 138, 217, 221
- OpenSSL 138, 424, 428–430
- OS\_install 51, 53, 123, 137–142
- os\_resources 138
- osinstall\_config 138, 143
- oslevel 23, 29, 36, 56

## P

- pax 72–73, 76
- port mapper 440, 450
- ports 438
- Pre-boot eXecution Environment 284
- prev\_state 59, 72, 79–81, 118–119, 122
- protocols 438
- PTF 36, 319
- public key 431
- pull 10–11, 23, 34
- pull mode 10, 35
- pull operation 434
  - disabling 436
- push installation 473–474
- push mode 10
- push operation 434
  - disabling 435
- PXE 284, 294

## R

- ramdisk 17, 284
- RECOVER\_DEVICES 468
- recovering devices 463
- registration ports 434
- remote command execution 424
- Remote IPL 180
- Remote Procedure Call 440
- Remote shell 438

- res\_group 11, 16, 119, 121
- resource
  - mksysb 456
  - SPOT 456
- resource server 9–10, 14, 27, 143–149, 299, 305, 453
- resource\_servers 138
- resources
  - adapter\_def 415, 422
- resources class 18
- restore process 459
- RMC 462, 478
  - ACL 478
  - security files 478
  - trusted host list file 478
- rootvg 23, 28, 41–42, 44, 171
- rootvg cloning 175
- RPM 20–21, 39, 123, 354, 364
- RSCT 309, 462
- RSCT Peer Domain 123
- rshd 424
- Rstate 15–16, 19, 22–24, 62, 72, 77, 118
- rte 22, 28, 33, 45, 53, 55, 63, 71, 75–76, 82, 84
- rte installation 476
- Run Time Environment 33

## S

- SAN 212, 475–476
- SAN disks (LUNs) 476
- script 11, 16, 22, 25, 47–48
  - nim\_clients\_setup 116
  - pre\_migration 155
- SCSI 209, 244, 461, 463
- SDD 153, 169, 194
- SDDPCM 153, 169
- secondary adapter 416–417, 419
- secondary adapter attribute 418
- secondary adapter definitions 421
- secondary adapter stanza 423
- Secondary adapter support 415
- server farm 1
- service console 219
- Service Update Management Assistant 123, 319
- Shared Ethernet Adapter (SEA) 374, 383
- Shared Virtual Ethernet 383
- show\_progress 43
- simage 55
- simages 22, 32, 40, 72–73, 119

- SMIT 9, 22, 29, 32, 38–41
- SMIT fastpath
  - smit nim\_perms 436
  - smitty clstart 314
  - smitty nim\_adapt\_def 422
  - smitty nim\_bosinst 475
  - smitty nim\_chmac 443
  - smitty nim\_client\_inst 430
  - smitty nim\_config\_services 427
  - smitty nim\_global\_nfs 442, 448
  - smitty nim\_mac 474
  - smitty nim\_mkres 456, 466
  - smitty nim\_ssl 431
  - smitty nim\_switch\_master 445, 474
  - smitty suma\_config\_base 325
  - smitty suma\_task\_defaults 326
  - smitty tscosi\_client 300
- SMS 10, 36, 180, 187
- SMS menu 83, 85, 92
- snm 59, 118
- software maintenance 2, 414
- source 16, 27, 29, 36, 41
- SPOT 16–20, 22–23, 29, 31–32, 34–35, 40–41, 43–44, 47–48, 55–56, 63, 74, 76–77, 83–84, 104, 106, 111–112, 116, 304, 410, 455
- spot 11–12, 15, 18–19, 27, 32, 36
- SPOT copy 44
- SSH keys 228
- SSL authentication 431
- SSL certificates 428
- SSL directory structure 429
- standalone 8, 10–12, 33, 35, 63, 79–80, 82, 84, 119, 121–122
- SUMA 123, 309
- SUMA tasks 327
- SYSLOG 68, 70
- system backup 3
- System Resource Controller 425
- systems administrators 1

## T

- takeover 313
- tape 55
- TCB 268–269
- TCP socket 438
- TCP/IP 451
- Technology Level 36, 319
- technology levels 3

TFTP 67, 69, 83, 93, 284, 439, 450  
tftp 291, 438  
tftpboot 54, 60, 62, 67–70, 93–94, 116–118, 122  
ftpd 66, 68–70  
thin server 299, 303  
thin server command  
    chcosi 300  
    cpcosi 300  
    dbts 300  
    lscosi 300  
    lsts 300  
    mkcosi 300  
    mkts 300  
    rmcosi 300  
    rmts 300  
    swts 300  
thin servers 29  
TIME\_WAIT 434  
Tivoli Storage Manager 153, 173  
TL 3  
toc 73  
TSM 173

## U

UDP 439  
upgrade 2, 4  
upgrading 1  
user volume groups 28

## V

VIO 209, 373  
VIO client 374, 384  
VIO server 5, 220–222, 244, 374  
virtual Ethernet 380  
virtual host device 380  
virtual I/O 2, 220  
virtual I/O resources 244  
virtual optical device 382  
virtual SCSI 373, 380  
virtual SCSI adapter 244–245  
virtual SCSI device 380  
Virtual Shared Ethernet 374  
Virtual Target Device mapping (VTD) 381  
VLAN 53  
volume group structure 174  
volume groups backups 28  
vterm 191

## W

Web-Based System Management 435  
WebSM 96, 110  
WebSphere 54  
wget 347

## Z

zoning 462, 475–476



**IBM**



**Redbooks**

# **NIM from A to Z in AIX 5L**

(1.0" spine)  
0.875" <-> 1.498"  
460 <-> 788 pages







# NIM from A to Z in AIX 5L



**Configuring NIM -  
illustrated**

**Sample best  
practices**

**NIM case scenarios**

This IBM Redbooks publication will help the AIX 5L technical community, and in particular system administrators who are well versed in the concepts and terminology of the AIX operating system, to understand the benefits of implementing a Network Installation Manager (NIM) environment in their data center. The book applies to AIX 5L V5.3 Technology Level 5, Cluster Systems Management (CSM) V1.5.1, and IBM Director V5.1.

The concept of a cluster (that is, at least two IBM System p machines connected through a network) presents the challenge of installing, maintaining, updating and backing up the various participants in the cluster. NIM, a critical feature of AIX, can perform these tasks for your System p server farm. Using NIM, you can install or upgrade many IBM System p machines and LPARs with the same (or different) images at the same time.

This publication complements the information found in IBM technical AIX 5L manuals, and will be most useful as a reference guide.

**INTERNATIONAL  
TECHNICAL  
SUPPORT  
ORGANIZATION**

**BUILDING TECHNICAL  
INFORMATION BASED ON  
PRACTICAL EXPERIENCE**

IBM Redbooks are developed by the IBM International Technical Support Organization. Experts from IBM, Customers and Partners from around the world create timely technical information based on realistic scenarios. Specific recommendations are provided to help you implement IT solutions more effectively in your environment.

**For more information:  
[ibm.com/redbooks](http://ibm.com/redbooks)**