

The IBM Magstar Virtual Tape Server and Enhancements to Magstar: New Era in Tape

November 1996

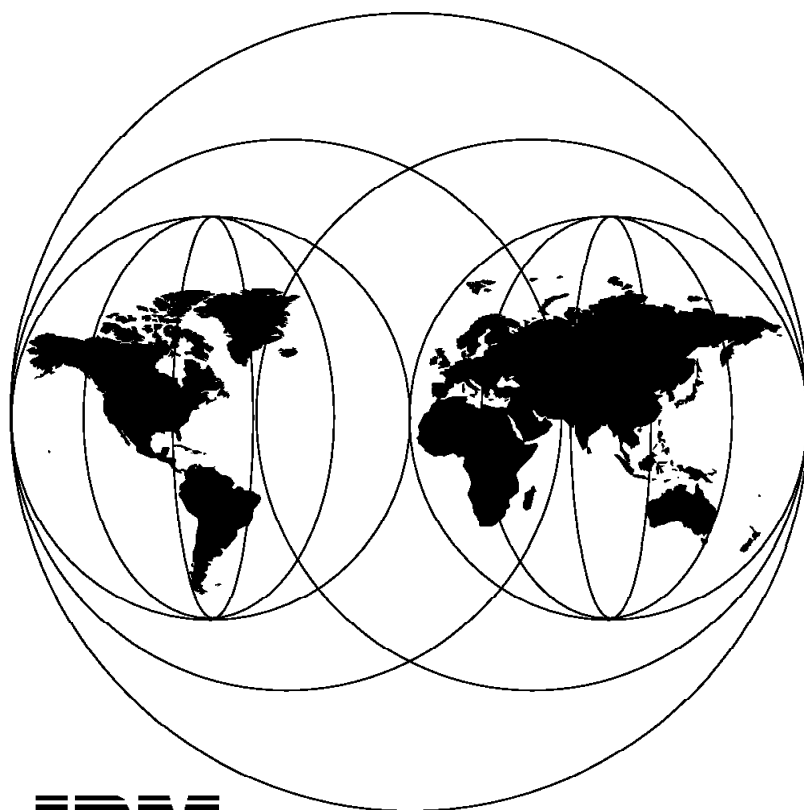

IBM

**International Technical Support Organization
San Jose Center**



International Technical Support Organization

SG24-4917-00

**The IBM Magstar Virtual Tape Server
and Enhancements to Magstar: New Era in Tape**

November 1996

Take Note!

Before using this information and the product it supports, be sure to read the general information in Appendix B, "Special Notices" on page 185.

First Edition (November 1996)

This edition applies to IBM Magstar Virtual Tape Server Subsystem, IBM 3590 High Performance Tape Subsystem, IBM 3591 Tape Subsystem, IBM 3590 model C12 Silo-Compatible Frame, IBM 3570 Magstar MP Tape Subsystem, and IBM 3494 and IBM 3495 Automated Tape Library Dataservers.

Comments may be addressed to:

IBM Corporation, International Technical Support Organization
Dept. 471 Building 80-E2
650 Harry Road
San Jose, California 95120-6099

When you send information to IBM, you grant IBM a non-exclusive right to use or distribute the information in any way it believes appropriate without incurring any obligation to you.

© **Copyright International Business Machines Corporation 1996. All rights reserved.**

Note to U.S. Government Users — Documentation related to restricted rights — Use, duplication or disclosure is subject to restrictions set forth in GSA ADP Schedule Contract with IBM Corp.

Contents

Figures	ix
Tables	xi
Preface	xiii
How This Redbook Is Organized	xiii
The Team That Wrote This Redbook	xiv
Comments Welcome	xv
Chapter 1. Introduction	1
1.1 Information Explosion	2
1.2 New Data Sources	4
1.3 Tape Utilization	5
1.4 IBM Announcements	6
1.5 Virtual Storage, Disks, and Tapes	9
1.6 The View of Tape Space	11
1.7 IBM 3590 Tape Subsystem ESCON Summary	12
1.8 IBM 3590 Tape Subsystem SCSI Summary	14
1.9 IBM 3570 Magstar MultiPurpose Tape Subsystem SCSI Summary	15
Chapter 2. The IBM Magstar Virtual Tape Server	17
2.1 Now Announced the IBM Magstar Virtual Tape Server	18
2.1.1 Virtual Tape Server for IBM 3494 Tape Library	18
2.1.2 Virtual Tape Server for IBM 3495 Tape Library	19
2.2 Introduction to the IBM Magstar Virtual Tape Server	20
2.2.1 Transparent Capacity Exploitation and Management	20
2.2.2 Fully Integrated in IBM 3494 and IBM 3495 Tape Libraries	21
2.2.3 Integration of Proven IBM Technologies	21
2.3 Virtual Tape Server Key Attributes	23
2.3.1 One VTS Subsystem per IBM 3494 or IBM 3495	23
2.3.2 Defined Physical Configurations	24
2.3.3 Up to 40 TB of Tape Data per Virtual Tape Server Subsystem	25
2.4 Virtual Tape Server Key Concepts	26
2.4.1 Virtual Volumes	27
2.4.2 Virtual Devices	27
2.4.3 Logical Volumes	28
2.4.4 Physical Volumes	28
2.4.5 Physical Devices	29
2.5 Hardware Overview	30
2.5.1 IBM 3494 Tape Library	30
2.5.2 IBM 3495 Tape Library Models L20, L30, L40, L50	31
2.6 IBM Magstar Virtual Tape Server Host Software Support	33
2.6.1 MVS/ESA	33
2.6.2 VM/ESA	34
2.6.3 VSE/ESA	34
2.7 IBM 3494 Host and Library Manager Attachment	35
2.7.1 ESCON Host Attachment	35
2.7.2 Library Manager Attachment	35
2.7.3 IBM 3494-D12 and IBM 3494-B16 Frame Connections	36
2.8 IBM 3494 Virtual Tape Server Configuration Guidelines	37
2.8.1 The L12/L14 Frame Can Be Without Drives	37

2.8.2	The D12/B16 Frame Must Be Within The First Eight Frames	37
2.8.3	The D12 Frame Must Always Be to the Left of the B16 Frame	38
2.8.4	The D12 and B16 Frames Must Directly Attach to One Another	38
2.8.5	A Modem Must Be Supplied for the IBM 3494-B16 Frame	38
2.9	New IBM 3494 Features, Their Codes and Model Upgrades	39
2.9.1	Features and Their Codes	39
2.9.2	Model Upgrades	40
2.10	IBM 3494 Environmental Requirements	42
2.11	IBM 3495 Virtual Tape Server Configuration Guidelines	43
2.11.1	One IBM 3495-B16 Must Be Installed	43
2.11.2	One IBM 3590-A14 Frame Must Be Installed	43
2.11.3	Library Manager Attachment	44
2.11.4	IBM 3495-B16 and IBM 3590-A14 Must Be Installed Side by Side	44
2.11.5	Reduction of IBM 3495 Storage Cells when a VTS is Installed	44
2.11.6	A Modem Must Be Supplied for The IBM 3495-B16	44
2.12	IBM 3495 Virtual Tape Server Frame Placement	45
2.13	IBM 3495 Virtual Tape Server Models and Features	47
2.13.1	IBM 3590 Model A14 Plus Feature 9010	47
2.13.2	IBM 3495 Model B16 Feature Codes	47
2.13.3	Feature Codes For IBM 3495 Model L20, L30, L40 and L50	48
2.14	IBM 3495 Environmental Requirements	49
2.15	Logical Data Flow	50
2.16	Scratch Mount Scenario	51
2.17	Specific Mount Scenario	54
2.17.1	Volume in Tape Volume Cache	54
2.17.2	Volume not in Tape Volume Cache	54
2.18	Space Reclamation	55
2.18.1	Tape Volume Cache	55
2.18.2	Stacked Magstar Cartridges	56
2.19	Virtual to Real Volume Comparisons	58
2.19.1	Virtual Volume	58
2.19.2	Physical Volume	59
2.19.3	Virtual Volume Advantages	59
2.20	Sizing Guidelines	61
2.21	Sizing a Virtual Tape Server	63
2.22	Real and Virtual 3490E Device Coexistence	65
2.22.1	Physical Installation	65
2.22.2	Library Manager View	65
2.22.3	Host View	66
2.23	Virtual Tape Server Installation Tasks	67
2.23.1	Physical Installation and Checkout	67
2.23.2	Logical Partitioning	67
2.23.3	Teach and Inventory	67
2.23.4	Hardware Configuration Definition (HCD) Required For Library Devices	68
2.23.5	Define the New Library to the Host	68
2.23.6	Define Volume Serial Number Ranges	68
2.23.7	Add Magstar Cartridges	69
2.23.8	Define Fast-Ready Categories	69
2.23.9	Define Reclamation Schedule	69
2.24	Implementing the Virtual Tape Server	70
2.24.1	MVS/ESA Environments	70
2.24.2	VM/ESA Environments	71
2.24.3	VSE/ESA Guests	72
2.25	Migration to the IBM Magstar Virtual Tape Server	73

2.25.1 Which Data?	73
2.25.2 How to Migrate?	74
2.25.3 Migration from Physical IBM 3490E	74
2.26 Monitoring the IBM Magstar Virtual Tape Server	76
2.26.1 Event Logging	76
2.26.2 Library Reporting	78
2.26.3 Library Manager Displayed Information	78
2.27 Operating the IBM Magstar Virtual Tape Server	80
2.27.1 Library Manager Updates	80
2.27.2 Vaulting	80
2.27.3 Error Recovery	81
Chapter 3. IBM Magstar 3590 in the S/390 Environment	83
3.1 Introduction	84
3.2 The IBM 3590-A00 ESCON Control Unit	85
3.2.1 ESCON Attachment	85
3.2.2 Stand-Alone Tapes and Automation	85
3.2.3 Up to Four Attached IBM 3590 Drives	85
3.2.4 Logical and Physical Paths	86
3.3 IBM 3590-A00 Schematic Diagram	87
3.4 IBM Magstar ESCON Control Unit Comparison	88
3.4.1 Device Emulation	88
3.4.2 ESCON Attachments	89
3.4.3 ESCON Multiple paths From One Host	89
3.4.4 ESCON and SCSI Hosts Sharing Drives	89
3.4.5 Subsystem Housing Frames	89
3.4.6 Subsystem Similarities	89
3.5 IBM 3590 Configurations for S/390	90
3.5.1 Host Attachment	90
3.5.2 ESCON Considerations	91
3.5.3 Library Manager Attachments	92
3.6 IBM 3494 ESCON Configuration	93
3.7 The IBM 3590-A14 Frame	96
3.8 IBM 3495 Configuration	98
3.9 IBM 3590 Feature Codes	101
3.9.1 Non-Chargeable Features	102
3.9.2 MES Field-installation Features	103
3.9.3 New Features	103
3.10 Ordering Tape Cartridges from IBM	105
3.10.1 Cartridge Features for All IBM 3494 Models	106
3.10.2 Cartridge Features for IBM 3590-B11	106
3.10.3 Cartridge Features for IBM 3590-C12	106
3.11 Migration to IBM 3590 High-Capacity Tape	108
3.11.1 Tape Applications for IBM 3590	108
3.11.2 Migration Issues	109
3.12 IBM 3590 Software Implications for S/390 Platforms	110
3.12.1 MVS/ESA	110
3.12.2 VM/ESA	111
3.12.3 VSE/ESA	111
3.12.4 Transaction Processing Facility (TPF)	111
3.13 IBM 3494 Tape Library Dataserver Capacity Enhancement	112
3.14 IBM 3494 Tape Library Dataserver Capacity Requirements	113
3.15 IBM 3494 Expanded Cartridge and Drive Capacity	115
3.16 IBM 3494 Current Capacity Enhancements	116
3.17 IBM 3494 Expanded Capacity Configuration Options	119

3.17.1 Cartridge and Drive Unit Maximums	119
3.17.2 New Features	120
3.17.3 Installation Considerations	121
3.18 IBM 3494 Expanded Capacity Summary	122
Chapter 4. IBM 3570 Magstar MP Tape Subsystem	123
4.1 Introduction	124
4.2 IBM Magstar MP Models	127
4.3 IBM Magstar MP 3570-B00 Single-Drive Without Autoloader	129
4.4 IBM 3570 Magstar MP Library Models	130
4.5 IBM 3570 Magstar MP Environmental Factors	131
4.6 IBM 3570 Magstar MP Library Magazine	133
4.7 IBM 3570 Magstar MP Library Loader	134
4.7.1 Library Door	134
4.7.2 Magazine Release Lever	134
4.7.3 10-Cartridge Magazines	134
4.7.4 Input/Output Cell	135
4.7.5 Operator Panel and Status Screen	135
4.8 IBM 3570 Operator Panel	136
4.8.1 Options Menu	136
4.8.2 Operating Status Screen	136
4.9 IBM 3570 Magstar MP Attention Messages	139
4.10 IBM 3570 Magstar MP Library Modes of Operation	140
4.10.1 Automatic Mode	140
4.10.2 Manual Mode	141
4.10.3 Random Mode	141
4.11 New IBM Magstar MP Cartridge	143
4.12 IBM RISC System/6000 Configurations	145
4.12.1 RISC System/6000 and POWERparallel SP	145
4.12.2 Other Systems	145
4.13 IBM RISC System/6000 Cables and Interfaces	146
4.13.1 IBM RISC System/6000 I/O adapters	146
4.13.2 IBM RISC System/6000 Model Support	146
4.13.3 IBM RISC System/6000 Supported Cables	147
4.14 IBM RISC System/6000 Software Support	148
4.15 IBM AS/400 Configurations	149
4.16 IBM AS/400 Cables and Interposer	150
4.16.1 IBM AS/400 Model Support and I/O Adapter	150
4.16.2 IBM AS/400 Supporting Cables	150
4.17 IBM 3570 Magstar MP AS/400 Software Support	151
4.18 IBM 3570 Magstar MP Feature Codes	152
4.18.1 Cartridge Features	152
4.18.2 Device Drivers	153
4.18.3 Cables and interposers	153
Chapter 5. IBM Magstar 3590 Silo-Compatible Tape Subsystem	155
5.1 STK Trademarks	156
5.2 Why Use IBM 3590 Magstar in an STK Silo?	158
5.3 Configuration Overview	160
5.4 IBM 3590 Model C12	162
5.4.1 IBM 3590-C12 Features	164
5.4.2 IBM 3590-B1A Features	165
5.5 IBM 3591 Model A01	166
5.5.1 IBM 3591-A01 Features	168
5.6 Allowed Device Combinations	169

5.7 Multi-ATL Scratch Tape Allocation	171
5.8 Multi-ATL Specific Tape Allocation	173
5.9 Installation and Operation	175
5.9.1 Installation	175
5.9.2 Operation	178
5.10 Migration Path to IBM 3494	180
Appendix A. Sample Cleaning Program	183
Appendix B. Special Notices	185
Appendix C. Related Publications	187
C.1 International Technical Support Organization Publications	187
C.2 Redbooks on CD-ROMs	187
C.3 Other Publications	187
How To Get ITSO Redbooks	189
How IBM Employees Can Get ITSO Redbooks	189
How Customers Can Get ITSO Redbooks	190
IBM Redbook Order Form	191
Index	193

Figures

1.	Information Explosion	2
2.	New Data Sources and Their Relative Space Demands	4
3.	Tape Utilization Today	5
4.	IBM Announces New Products and Enhancements	6
5.	Virtual Storage, Disks, and Tapes	9
6.	The View of Tape Space	11
7.	IBM 3590 Tape Subsystem ESCON Summary	12
8.	IBM 3590 Tape Subsystem SCSI Summary	14
9.	IBM 3570 Magstar MP Tape Subsystem SCSI Summary	15
10.	Title Slide of the IBM Magstar Virtual Tape Server Presentation	17
11.	Now Announced the IBM Magstar Virtual Tape Server	18
12.	Introduction to the IBM Magstar Virtual Tape Server	20
13.	Virtual Tape Server Key Attributes	23
14.	Virtual Tape Server Key Concepts.	26
15.	Hardware Overview	30
16.	IBM Magstar Virtual Tape Server Host Software Support	33
17.	IBM 3494 Host and Library Manager Attachment	35
18.	IBM 3494: VTS Configuration Guidelines	37
19.	New IBM 3494 Features, Their Codes and Model Upgrades	39
20.	IBM 3494 Environmental Requirements	42
21.	IBM 3495 Virtual Tape Server Configuration Guidelines	43
22.	IBM 3495 Virtual Tape Server Frame Placement	45
23.	IBM 3495 Virtual Tape Server Models and Features	47
24.	IBM 3495 Environmental Requirements	49
25.	Logical Data Flow	50
26.	Scratch Mount Scenario	51
27.	Specific Mount Scenario	54
28.	Space Reclamation	55
29.	Comparison of Virtual to Real Volumes.	58
30.	Sizing Guidelines	61
31.	Sizing a Virtual Tape Server	63
32.	Real and Virtual 3490E Device Coexistence	65
33.	Virtual Tape Server Installation Tasks	67
34.	Implementing the Virtual Tape Server	70
35.	Migration to the IBM Magstar Virtual Tape Server	73
36.	Monitoring the IBM Magstar Virtual Tape Server	76
37.	Operating the IBM Magstar Virtual Tape Server	80
38.	Title Slide for the IBM Magstar 3590 ESCON Controller	83
39.	IBM Magstar 3590 ESCON Connectivity	84
40.	The IBM 3590-A00 ESCON Control Unit	85
41.	IBM 3590-A00 Schematic Diagram	87
42.	A Comparison of the Two IBM Magstar ESCON Control Units	88
43.	IBM 3590 Configuration for S/390	90
44.	IBM 3494 ESCON Configuration	93
45.	The IBM 3590-A14 Purpose-Built Frame	96
46.	IBM 3495 Configuration	98
47.	IBM 3590 Tape Subsystem Feature Codes for ESCON Platform	101
48.	Ordering IBM Tape Cartridges from IBM	105
49.	Migration to IBM 3590 High-Capacity Tape	108
50.	IBM 3590 Software Implications for S/390 Platforms	110
51.	Title Slide for IBM 3494 Capacity Enhancement	112

52.	IBM 3494 Tape Library Dataserver Capacity Requirements	113
53.	IBM 3494 Expanded Cartridge and Drive Capacity	115
54.	IBM 3494 Current Capacity Enhancements	116
55.	IBM 3494 Expanded Capacity Configuration Options	119
56.	IBM 3494 Expanded Capacity Summary	122
57.	Title Slide for the IBM 3570 Magstar MP Tape Subsystem	123
58.	Introducing IBM Magstar MP Tape Subsystem	124
59.	IBM 3570 Magstar MP Models	127
60.	IBM Magstar MP 3570-B00 Single-Drive Without Autoloader	129
61.	IBM Magstar MP Library Model (with Autoloaders)	130
62.	IBM Magstar MP Environmental Factors	131
63.	IBM 3570 Magstar MP Library Magazine	133
64.	IBM 3570 Magstar MP Library Loader	134
65.	IBM Magstar MP Library Model Operator Panel	136
66.	IBM Magstar MP Library Model Operator Panel Attentions	139
67.	IBM Magstar MP Library Modes of Operation	140
68.	IBM Magstar MP Fast Access Linear Tape Cartridge	143
69.	IBM RISC System/6000 Configurations	145
70.	IBM RISC System/6000 Cables, Interfaces, and Interposers	146
71.	IBM RISC System/6000 Software Required to Support the IBM Magstar MP Tape Subsystem	148
72.	IBM AS/400 Configurations	149
73.	AS/400 Cables Interfaces and Interposers	150
74.	AS/400 Software Required to Support the IBM Magstar MP Subsystem	151
75.	IBM 3570 Tape Subsystem Cartridge Feature Codes	152
76.	STK Trademarks	156
77.	Why Use IBM 3590 in an STK Silo?	158
78.	Configuration Overview	160
79.	IBM 3590 Model C12	162
80.	IBM 3591 Model A01	166
81.	Allowed Device Combinations	169
82.	Multi-ATL Scratch Tape Allocation	171
83.	Multi-ATL Specific Tape Allocation	173
84.	Installation and Operation	175
85.	Migration Path to IBM 3494	180
86.	JCL for Sample Cleaning Program	183

Tables

1.	Planned Availability Dates	8
2.	IBM 3590 Feature Codes	102
3.	IBM Tape Cartridge Part Numbers	105
4.	Supported Configurations for the IBM 3494 expansion features	118
5.	IBM 3570 Environmental Specifications	131
6.	IBM 3590-C12 Physical Characteristics	163
7.	IBM 3590-C12 Features	164
8.	IBM 3590-B1A Features	165
9.	IBM 3591-A01 Software Support	167
10.	IBM 3591-A01 Physical Characteristics	167
11.	IBM 3591-A01 Features	168
12.	APARs	176

Preface

This redbook gives technical explanations for new tape and tape library products announced on September 10, 1996. The new products are IBM Magstar Virtual Tape Server subsystems for IBM 3494 and 3495 Tape Library Servers, IBM 3590-A00 ESCON tape control unit, IBM 3590 tape drives STK Silos attachment, IBM 3494 enhancements, and IBM 3570 Magstar MP tape subsystem.

This redbook was written for storage system technical professionals within both customers and IBM.

Some knowledge of IBM tape subsystems and tape library is assumed.

How This Redbook Is Organized

This redbook contains 201 pages. It is organized as follows:

- Chapter 1, "Introduction"

This chapter gives an overview of major enhancements and additions to the IBM Magstar High Performance Tape Subsystems.

- Chapter 2, "The IBM Magstar Virtual Tape Server"

This chapter explains what the IBM Magstar Virtual Tape Server (VTS) is and also describes VTS hardware components, software support, configuration, implementation considerations, and operational considerations.

- Chapter 3, "IBM Magstar 3590 in the S/390 Environment"

This chapter provides technical descriptions for the enhanced IBM 3590 tape subsystem, for IBM 3494 and IBM 3495 Automated Tape Library Dataservers, and for IBM 3591 tape subsystem in the S/390 environment.

- Chapter 4, "IBM 3570 Magstar MP Tape Subsystem"

This chapter provides the technical descriptions for new IBM 3570 Magstar MP (Multi-Purpose) tape subsystem.

- Chapter 5, "IBM Magstar 3590 Silo-Compatible Tape Subsystem"

This chapter describes how the IBM 3590 Magstar tape drives can be installed in a StorageTek Automated Cartridge System.

- Appendix A, "Sample Cleaning Program"

This chapter shows how to get a sample cleaning program for IBM 3590 tape drives that are installed in the StorageTek Automated Cartridge System.

The Team That Wrote This Redbook

This redbook was produced by a team of specialists from around the world working at the International Technical Support Organization (ITSO) San Jose Center.

Minoru Massaki is a Senior Systems Engineer at the International Technical Support Organization, San Jose Center. He writes extensively and teaches IBM classes worldwide on all areas of tape and tape library storage products. Before joining ITSO three years ago, he worked in Systems Management Support Center, IBM Japan, as a large-systems specialist. He has been working for large systems and storage systems area since before MVS was announced in early 1970.

Christina P. Coutts is a Senior Systems Specialist for storage products in the UK. She worked as a post-graduate student at Kings College, London, for 5 years before joining IBM. As a storage specialist she worked in IBM manufacturing, IBM Enterprise clients, and in IBM UK Enterprise Marketing. She has contributed to several other ITSO redbooks.

Babette Häusser is a Advisory Systems Engineer for storage systems products in IBM Germany. She has written several redbooks for storage systems, especially tape and tape library products such as *Guide to Sharing and Partitioning IBM Tape Library Dataserver* which is one of top ten best-selling Redbooks in 1995.

Kjell E. Nyström heads Storage Systems Marketing in IBM Nordic. He has 30 years of experience in S/390 and Storage Systems. His areas of expertise include all major hardware and software products for the S/390 platform. He has written extensively on various storage hardware and software products, and developed classes for data disaster recovery.

Thanks to the following people for their invaluable contributions to this project:

Darrel Armstrong	IBM Tucson
Enrique Aviles	IBM Tucson
Carl Bauske	IBM San Jose
James Devine	Technical writer
Gary Dillon	IBM Tucson
Kathy Eldred	IBM Tucson
William Greeley	IBM Tucson
Tim Griffin	IBM Tucson
Nadine Hart	IBM San Jose
Greg Kishi	IBM Tucson
Robert Maness	IBM Tucson
Ralph Mersiowsky	IBM Tucson
Nigel Morton	IBM United Kingdom
Jukka Myyryläinen	IBM Finland
Daniel Sheehy	IBM Tucson
Taisei Takai	IBM Japan
Jesse Thrall	IBM Tucson
Jon Peake	IBM Tucson
Richard Replogle	IBM Tucson
Cameron Whitnall	IBM Australia
Maggie Cutler	Technical Editor
Shirley Hentzell	Technical Editor

Comments Welcome

We want our redbooks to be as helpful as possible. Should you have any comments about this or other redbooks, please send us a note at the following address:

redbook@vnet.ibm.com

Your comments are important to us!

Chapter 1. Introduction

This chapter gives an overview of major enhancement and additions to the IBM Magstar High Performance Tape Subsystem.

For background and technical details on already announced products in the IBM Magstar family, see *Magstar and IBM 3590 High Performance Tape Subsystem Technical Guide*.

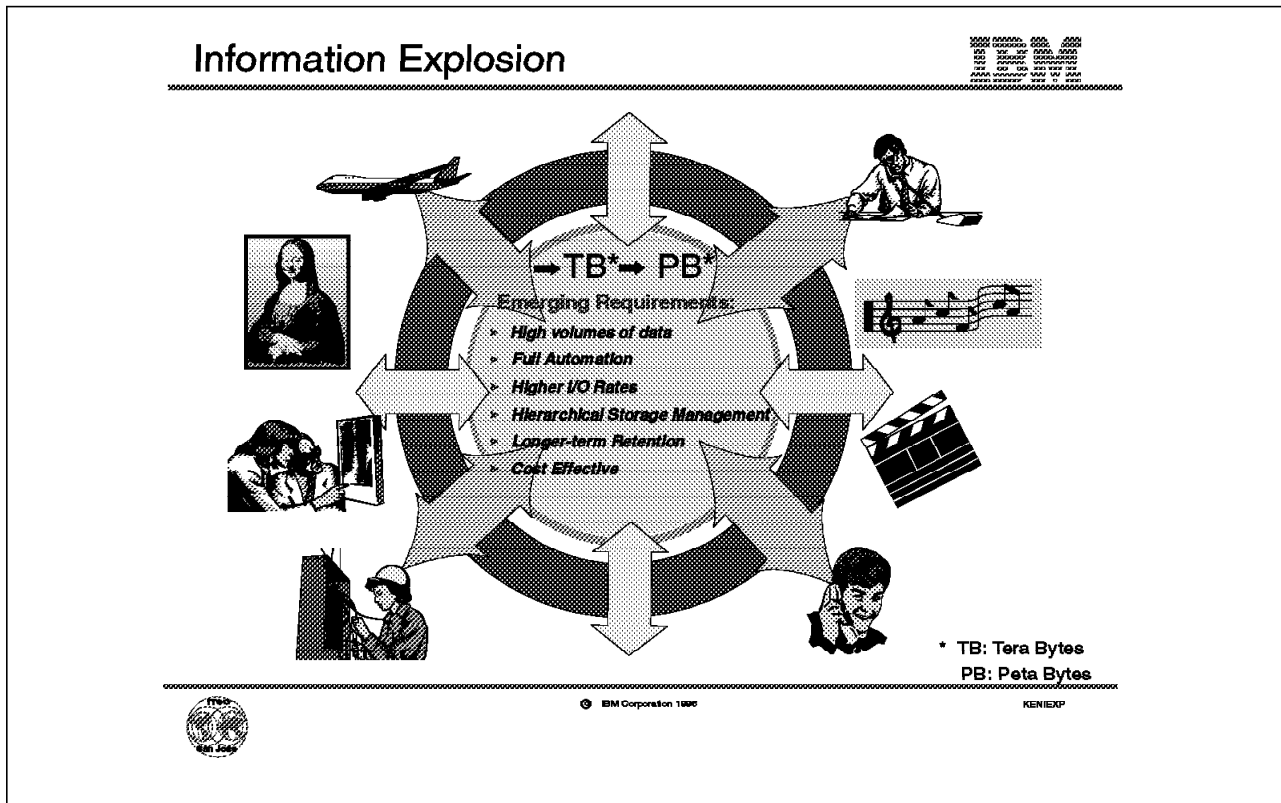

Figure 1. Information Explosion

1.1 Information Explosion

In the last few years, we have seen many new applications requiring much more space for the data or information they use. New applications may not only use traditional coded data, they may also use voice, pictures, and even video, as described in Section 1.2, "New Data Sources" on page 4. At the same time, new application environments, like the Internet, force us to move much of the information now stored on paper to some kind of machine-accessible media. Many studies show that only a small fraction (2 to 5%) of all information available is stored on magnetic media. Much of this data can be, and will be, transferred to magnetic disks, and optical disks, as well as magnetic tapes to make it available for future applications.

Magnetic tape is today used both for interchange and to store archived or migrated data. Tape is the preferred medium for backups, both for local recovery and for disaster recovery. The difference between archived or migrated data and backup data is that there is usually one copy of migrated or archived data, whereas there are often many versions of backup data. As the requirement for space to store data or information increases, the requirement for backup space grows dramatically, as much as ten, twenty, or even thirty times as much as the space required to store the source data.

At the same time, we require our applications to be available more hours, up to 24 hours a day. This forces housekeeping applications, such as migration and backup, into a smaller and smaller time window. As more archive applications are introduced, we see more and more requests to recall data. For this reason the elapsed time for this type of application has to be reduced, both by improved

technology as well as by new techniques and procedures. Both migration and recall as well as backup and recovery applications today require high performance and full automation to satisfy a high volume of requests from the end users or from your customers using your data and information via Internet applications.

We also want the most-referenced data to be available in just a few milliseconds, although we can accept a delay of a few seconds or even minutes for infrequently used data or archived data, as long as it is always available. For this reason, we need advanced and fully automated migration and recall functions implemented in the system software or as microcode in the hardware.

As the required space for data and backups increases, it becomes even more important to maximize the utilization of installed hardware and media. For the last decade, we have had techniques for disks attached to S/390 hosts to maximize and optimize the disk space through the DFSMS/MVS product, that is through automatic migration and recall driven by thresholds on disk and by the reference pattern of data. Data can be compressed using hardware-assisted compression and today we also have the Tape Mount Management (TMM) techniques and procedures, which optimize the capacity for some cartridges in our tape subsystems as well as increasing operator productivity by reducing the number of tape mounts. Another advantage with TMM is that the data sets themselves are system managed, with all the additional functionality available to data sets stored on disk — for example, the ability to read data sets concurrently or to use advanced DFSMS/MVS functions like striping.

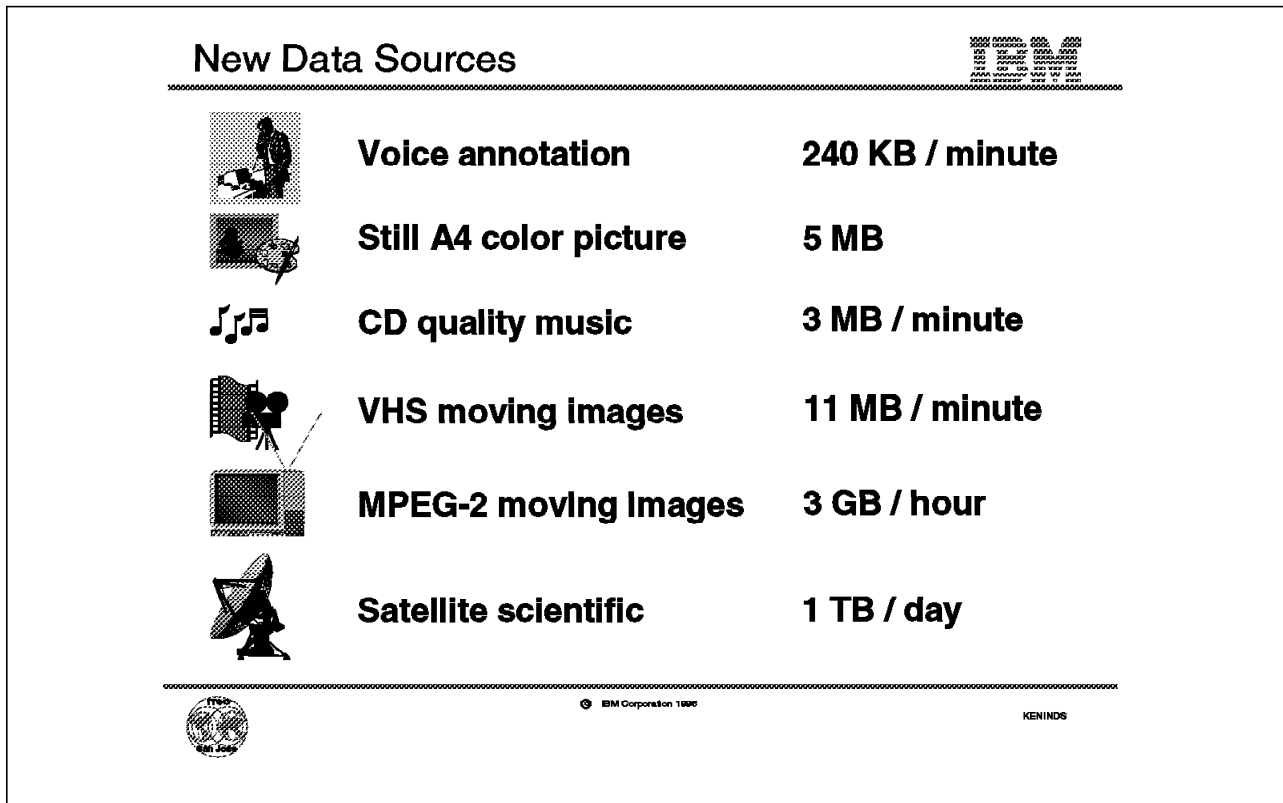

Figure 2. New Data Sources and Their Relative Space Demands

1.2 New Data Sources

Most data stored on magnetic media is still coded data. It is stored as records or blocks of data in data sets or databases. From a capacity point of view, it has been easy to calculate the amount of space needed for the source data as well as the number of tapes needed to archive or back this data up. From a performance point of view, coded data is easy to monitor or plan for, as most coded data has the same characteristics.

As new applications emerge, you will see new types of information in your systems, together with traditional coded data. Figure 2 shows some examples of new data sources with information on approximate space and performance requirements. Remember, the amounts shown are for only the primary copy of the new data; it will also need to be backed up. You must plan the resources needed for your backup procedures.

Tape Utilization

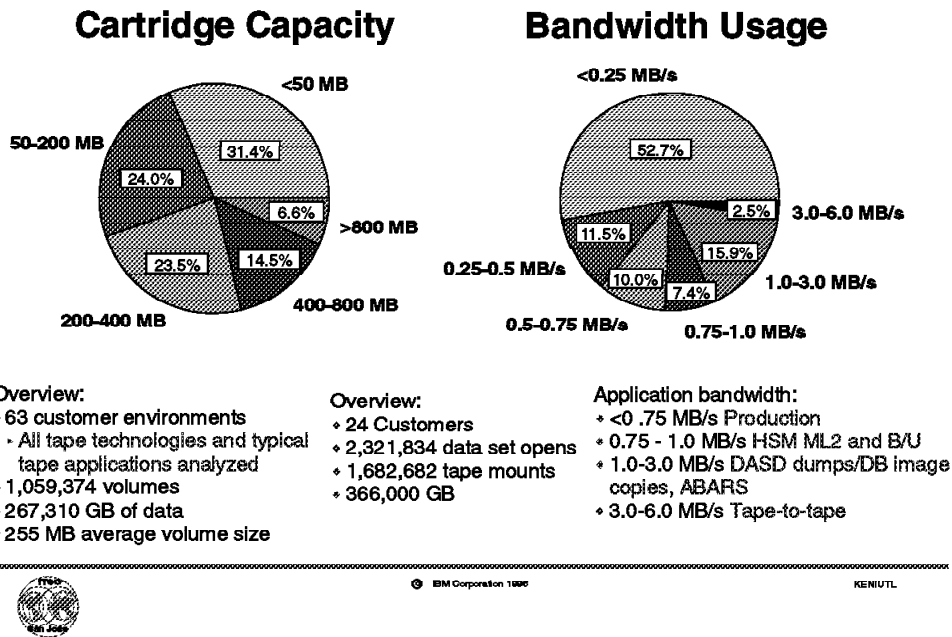

Figure 3. Tape Utilization Today

1.3 Tape Utilization

In 1995 IBM did studies on how well different installations utilized the cartridge capacity and bandwidth available in tape subsystems. Some of the findings from the study are shown in Figure 3.

One part of the study shows that one-third of the used cartridges had only small (less than 50 MB) amounts of data stored, as shown in the chart on the left in Figure 3. More than half of all cartridges (55%) had less than 200 MB of data written. The average size of data stored on cartridges was 255 MB. These figures should be compared with available cartridge capacities of either 1200 MB or 2400 MB. This study shows that even if techniques like TMM were used, a more effective way of maximizing available cartridge capacity is needed.

The other part of the study showed that applications use only a fraction of the available bandwidth for a single tape drive. The only applications that fully utilize the performance of the tape drives are the tape-to-tape applications. In today's installations, where more and more of the applications are transaction driven, we see less and less of traditional tape-to-tape applications. Tape is used for backup, archive, migration or similar applications. This study shows that from a bandwidth point of view, techniques are needed to improve utilization of the bandwidth available in present and future IBM Magstar tape drives.

The only type of application that is likely to differ from the findings in this study is the DASD dump as the performance of modern DASDs has improved (an example is the RAMAC 3 devices). You can expect DASD dump applications to require up to three times the bandwidth found in the study.

IBM Announces ...

0000 00000 000 000
00 00 00 0000 0000
00 0000 0000000
00 00 00 00 00 00
00000000 000 00 000
00000000 000 00 000

● New Functions and Features

- ◆ Virtual tapes
- ◆ Cartridge features

● Enhanced Products

- ◆ IBM 3494 extension
 - Up to 6240 cartridges
- ◆ IBM 3590-A00 tape control unit
 - One or two ESCON adapters
 - In rack replacing IBM 3591-A01
- ◆ IBM 3590-A14 in two shapes
 - With IBM 3590-B11
 - With IBM 3590-B1A



September 10, 1996

● New Products

- ◆ IBM 3494/5-B16 VTS Unit
 - Virtual Tape Server logic and disk cache
- ◆ IBM 3590-C12 Frame
 - IBM 3590-B1A tape drives attached to a STK Silo
- ◆ IBM 3570 Magstar MP
 - Magstar technology
 - New two-reel cartridge



© IBM Corporation 1996

KENIANN

Figure 4. IBM Announces New Products and Enhancements

1.4 IBM Announcements

On April 10, 1995, IBM announced the IBM 3590 Magstar tape drive. Now IBM has announced major extensions to and enhancement of current tape products as well as new products, functions and features:

• *Virtual Tapes*

The first-generation magnetic tapes were announced by IBM in 1952. The second generation was announced in 1984 when IBM announced the IBM 3480 Cartridge Tape Subsystem. The first part of the third generation was announced in 1995 when IBM announced the Magstar IBM 3590 High Performance Subsystem. At that time, IBM announced its intention of making functions available to automatically utilize the capacity of the Magstar cartridge and tape drive.

IBM has now introduced the concept of virtual tapes and virtual tape drives, which will be used to fully exploit the capacity of the IBM Magstar Tape Subsystem and its media. Virtual tapes and drives will have the same revolutionary effect for tape applications as virtual storage once had for host applications.

• *Cartridge Features*

In the past, cartridges had to be ordered separately when Magstar tape drives were ordered. IBM now offers the option of ordering various amounts of cartridges to be delivered with drives or frames.

- **IBM 3494 Extension**

IBM now offers the possibility of extending the IBM 3494 Automated Tape Server from 8 frames to 12 or 16 frames. The maximum number of cartridges that can be stored within one IBM 3494 is now 6240 cartridges (CST, ECCST, or 3590). ih1.IBM announcements

- **IBM 3590-A00 Tape Control Unit**

When the IBM 3590-A00 ESCON control unit was originally announced, the only option was to have two ESCON adapters. Now the IBM 3590-A00 can be ordered with only one ESCON adapter at a lower price. A second ESCON adapter can still be installed, if required. The IBM 3590-A00 control unit brings 3590 ESCON to the IBM Tape Libraries.

The IBM 3590-A00 can also replace the rack-mounted IBM 3591-A01.

- **IBM 3590-A14 Frame in Two Shapes**

When the IBM 3590-A14 frame was announced, it provided support for IBM 3590-B11 drives (the version with automated cartridge facility, ACF, installed). The 3590-A14 can now be configured with IBM 3590-B1A drives when attached to an IBM 3495 Automated Tape Library Dataserver.

- **IBM 3494-B16 and 3495-B16 Virtual Tape Server Unit**

The new B16 Virtual Tape Server unit frame is the heart of the new IBM Virtual Tape Server hosting the necessary hardware, software, and disk cache to implement Virtual Tapes and Virtual Tape Drives.

- **IBM 3590-C12 Frame**

This is a new frame that attaches to a StorageTek Automated Cartridge System, offering a migration path for current "Silo" installations to quickly exploit part of the Magstar technology and later migrate into a full-function IBM Automated Tape Library.

- **IBM 3570 Magstar MP Tape Subsystem**

The IBM 3570 Magstar MultiPurpose is a completely new tape subsystem in the Magstar family. The IBM 3570 Magstar MP tape drive uses Magstar technology and a new, two-reel cartridge with an uncompacted capacity of 5 GB. The IBM Magstar MP tape drive is SCSI-attached and comes as a stand-alone drive or as a library version. The IBM Magstar MP tape drive has the same basic functions as the IBM 3590 Magstar drive (for example, compression) but it writes data to the tape at a speed of 2.2 MB/sec and can load the cartridge faster.

Table 1 shows the planned availability dates of the products.

<i>Table 1. Planned Availability Dates</i>	
Product	Planned Date
Cartridge features Features 8410, 8420, 8510, 8520, 9540	September 27, 1996
IBM 3590-B11 Magazine and cartridges Features 8001, 8130	September 27, 1996
IBM 3570-B01,B11 (AS/400 only)	September 27, 1996
IBM 3590-C12	September 27, 1996
IBM 3591-A01 Freestanding Feature 5000	May 31, 1996
IBM 3494-L14/D14	October 25, 1996
IBM 3590-A00 in IBM 3590-A14, IBM 3494, and Rack to replace IBM 3591-A01	October 25, 1996
IBM 3570-B00	November 22, 1996
IBM 3570-B01,B11 (RISC System/6000)	November 22, 1996
IBM 3494 extension to 12 or 16 frames	January 31, 1997
IBM 3570-B02,B12	March,28, 1997
IBM 3590 Models B1A/A00/A14 Attached to IBM 3495	March 28, 1997
IBM 3590-A00 Second ESCON/SCSI adapter Feature 3312	March 28, 1997
IBM 3494-B16 Virtual Tape Server	June 27, 1997
IBM 3495-B16 Virtual Tape Server	September 26, 1997
IBM 3590-A14 attachment to IBM 3495-B16 Feature 9020	September 26, 1997

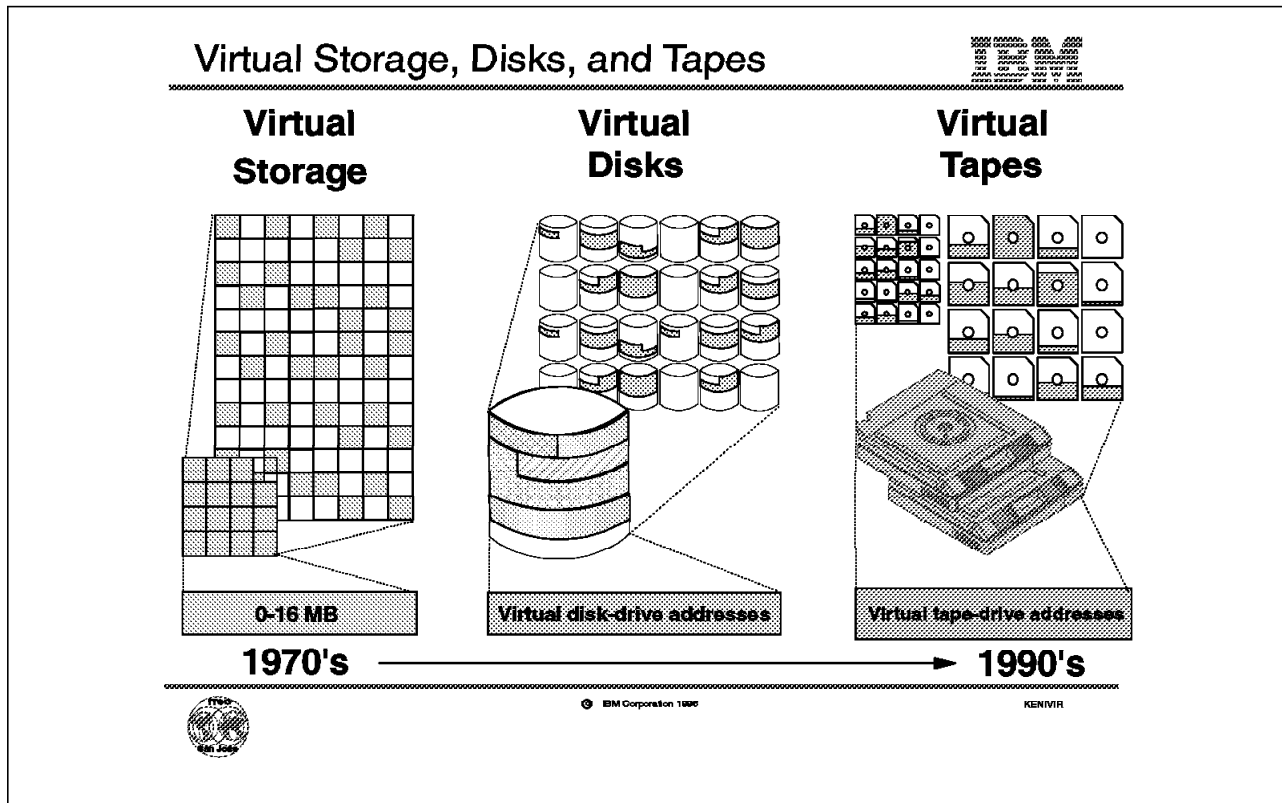

Figure 5. Virtual Storage, Disks, and Tapes

1.5 Virtual Storage, Disks, and Tapes

More than twenty years ago, IBM announced virtual storage, in the operating system called Single Virtual Storage (SVS). It was an addition to the most current operating system at the time OS/360 MVT (Multiple Variable number of Tasks). This gave the operating system a view of one big central store in which to run applications. The real central storage of the processor was much smaller but only referenced parts (4096 bytes each) of the virtual storage were actually stored in processor storage. Unreferenced or unallocated parts were stored in specialized system data sets called page data sets. Soon after, the first version of MVS (Multiple Virtual Storage) operating system was announced, giving each single user its own virtual storage. Virtual storage allowed installations to make maximum use of the very expensive central storage; with MVS, systems could have more active tasks running and in that way make full use of the available processor capacity.

IBM's first version of a virtual disk was introduced with the IBM 3850 Mass Storage Subsystem (MSS). Today, virtual disks are available in the IBM RAMAC Virtual Array Subsystem. Virtual disk has the same concept as virtual storage: it gives the user a view of an "endless" storage, but uses hardware to actually store only written data, not allocated space. At the same time, multiple users have their own view of the disk space and disk devices, even if only one or a few physical resources are available.

Now IBM introduces virtual tapes or cartridges and virtual tape drives giving the user the same benefit as for virtual storage or disk. With this concept, the user can request a virtual tape (scratch or specific) to be mounted on a virtual tape

drive. The Virtual Tape Server will then maximize the use of the existing hardware and media that are available.

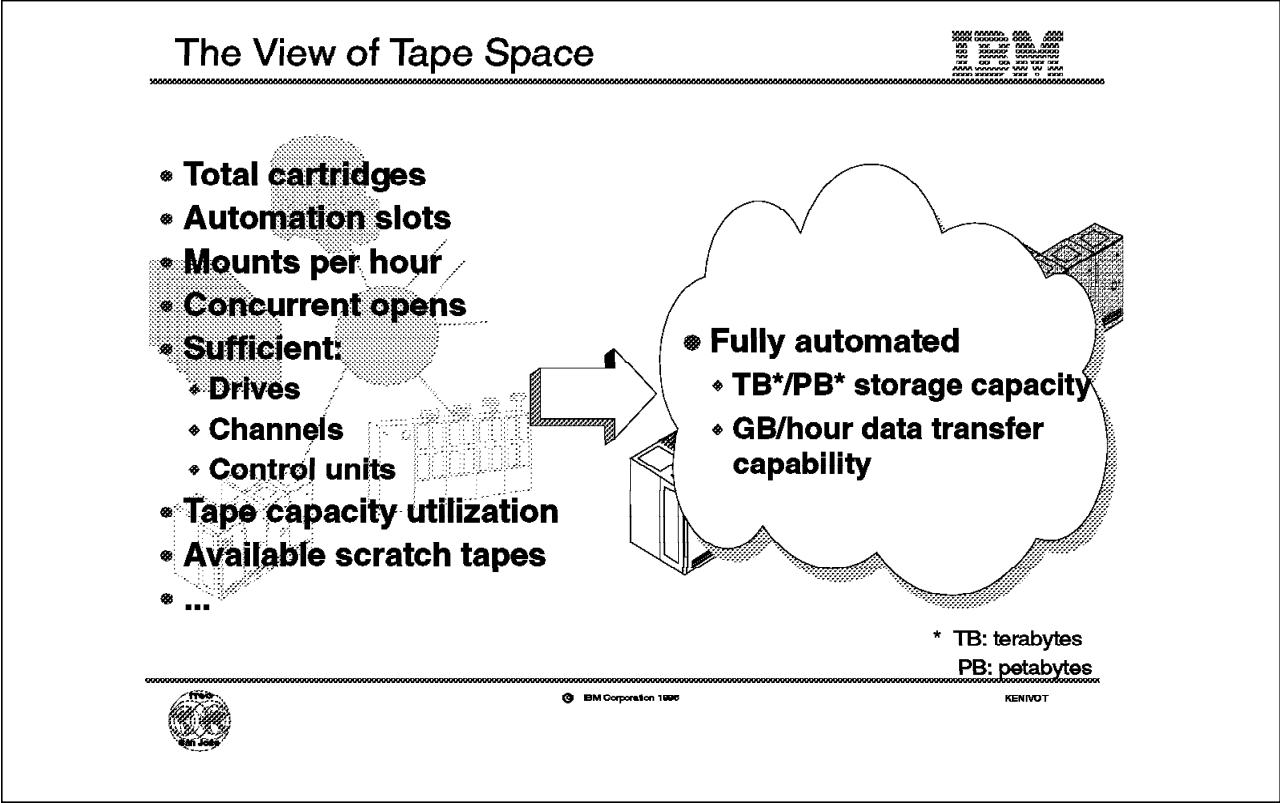

Figure 6. The View of Tape Space

1.6 The View of Tape Space

Many years ago, when disk drives were introduced, configuration, capacity, and performance planning were based on disk volumes or units. Number of channels to access the data was also a part of this planning. Today, you probably plan in terms of the number of gigabytes of space needed for your active data, access density, and required paths. Some installations have even stopped planning for disk response times, as most of the accesses of disk data today are cache hits.

Today, configuration, capacity, and performance for tape subsystems are planned as they were in the early days of disk; that is, in numbers of devices and units of media. Tape libraries, and especially the introduction of the Virtual Tape Server (VTS), have changed the way you need to plan for tape.

The advent of virtual tapes and drives means that you need to think in terms of gigabytes (GB), terabytes (TB), and petabytes (PB) of tape space and number of GB, TB, and PB transferred per minute, or hour, or day. When planning for future tape subsystems, thinking in terms of the hardware components is no longer enough.

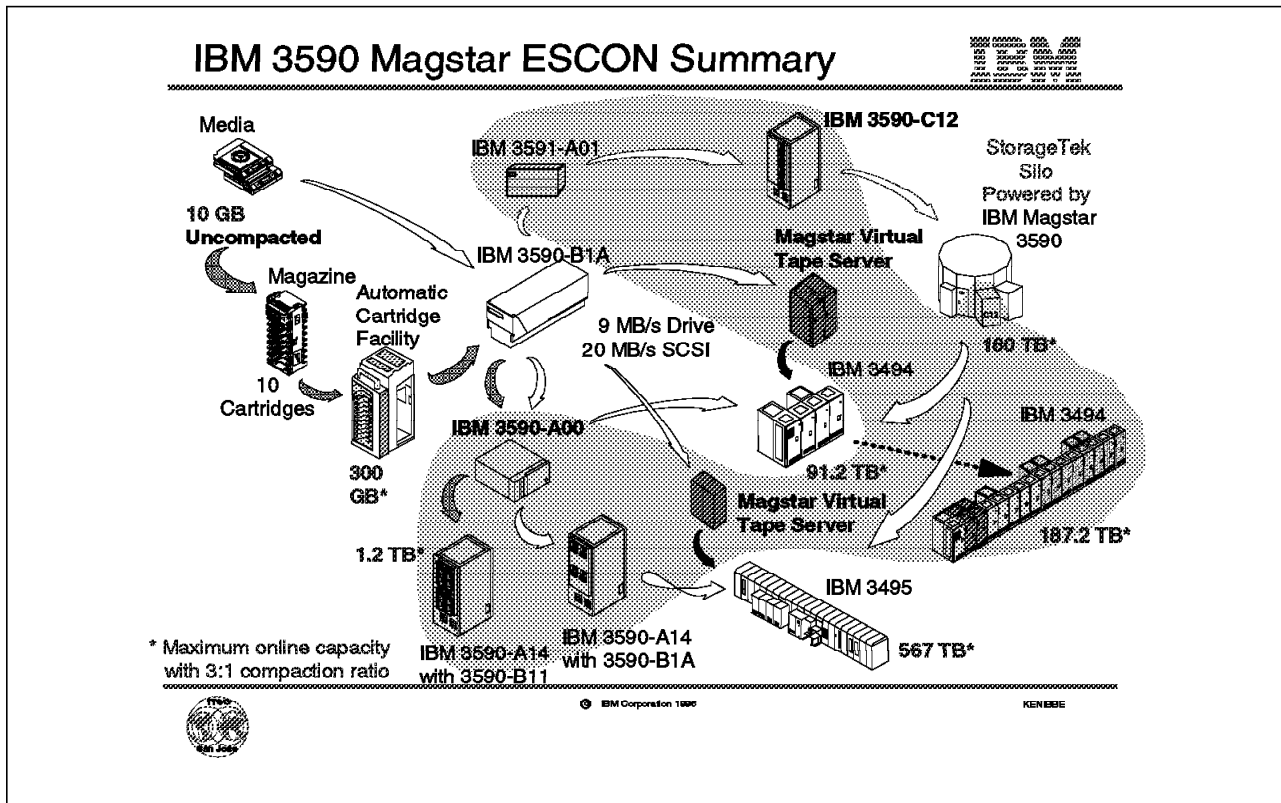

Figure 7. IBM 3590 Tape Subsystem ESCON Summary

1.7 IBM 3590 Tape Subsystem ESCON Summary

Figure 7 shows a summary of the possibilities for using the IBM 3590 tape subsystem in an ESCON environment. New or enhanced possibilities are in the gray shaded area:

- The Magstar Virtual Tape Servers for the IBM Automated Tape Library Data servers, described in detail in Chapter 2, "The IBM Magstar Virtual Tape Server" on page 17.
- Two versions of the IBM 3590-A14 frame, described in Section 3.7, "The IBM 3590-A14 Frame" on page 96.
- The new IBM 3590-A00 ESCON control unit, described in Chapter 3, "IBM Magstar 3590 in the S/390 Environment" on page 83.
- The extended IBM 3494 Tape Library, described in Section 3.15, "IBM 3494 Expanded Cartridge and Drive Capacity" on page 115.
- The migration path for StorageTek Automated Cartridge Systems, including
 - The freestanding version of IBM 3591-A01 ESCON control unit, and
 - The IBM 3590-C12 frame.

The migration path for the StorageTek Automated Cartridge System is described in Chapter 5, "IBM Magstar 3590 Silo-Compatible Tape Subsystem" on page 155.

The possibility of having a rack-mounted IBM 3591-A01 with IBM 3590-B11 devices is not shown in Figure 7. The IBM 3590-A00 can be installed to replace

the rack-mounted IBM 3591-A01, but the preferred configuration is an IBM 3590-A14 frame with the IBM 3590-A00 controller.

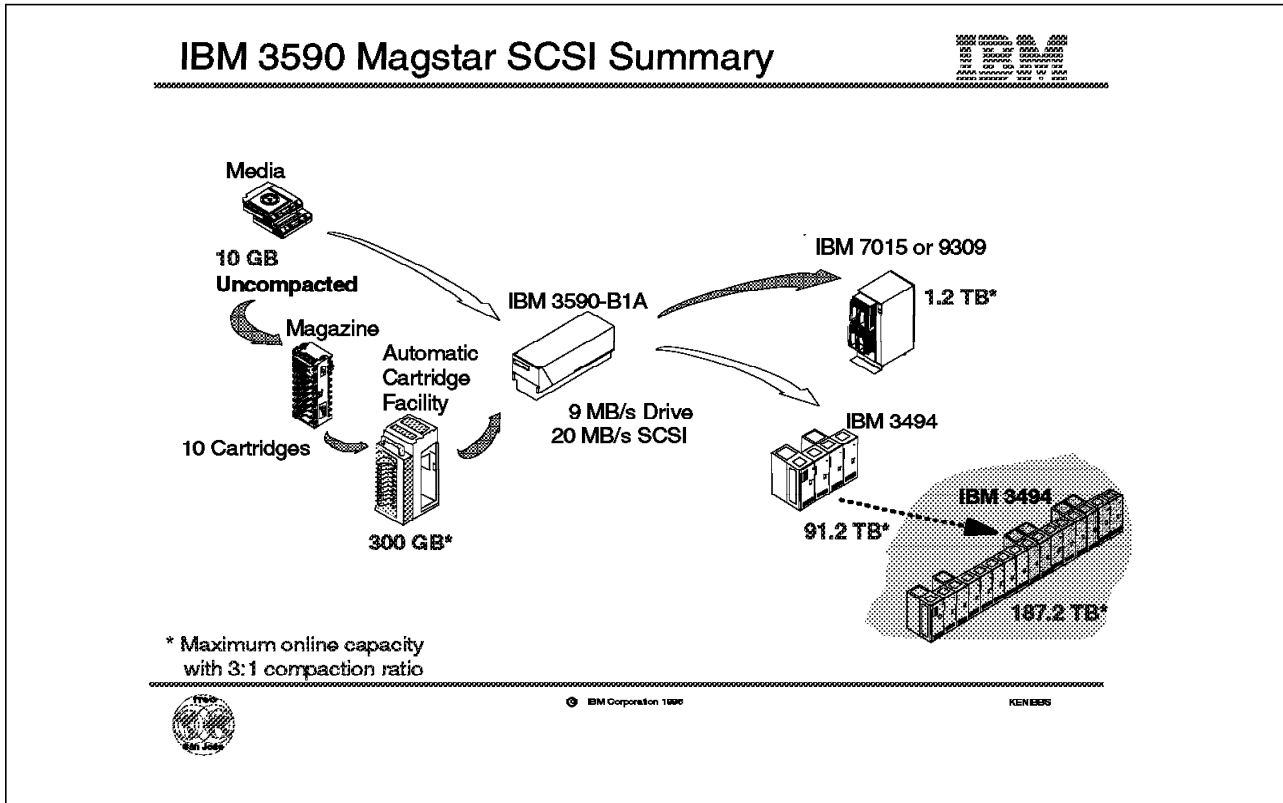

Figure 8. IBM 3590 Tape Subsystem SCSI Summary

1.8 IBM 3590 Tape Subsystem SCSI Summary

Figure 8 shows a summary of the possibilities for using the IBM 3590 Magstar tape subsystem in a SCSI environment. The gray shaded area shows the possible enhancement.

The extended IBM 3494 Tape Library is described in Section 3.15, “IBM 3494 Expanded Cartridge and Drive Capacity” on page 115.

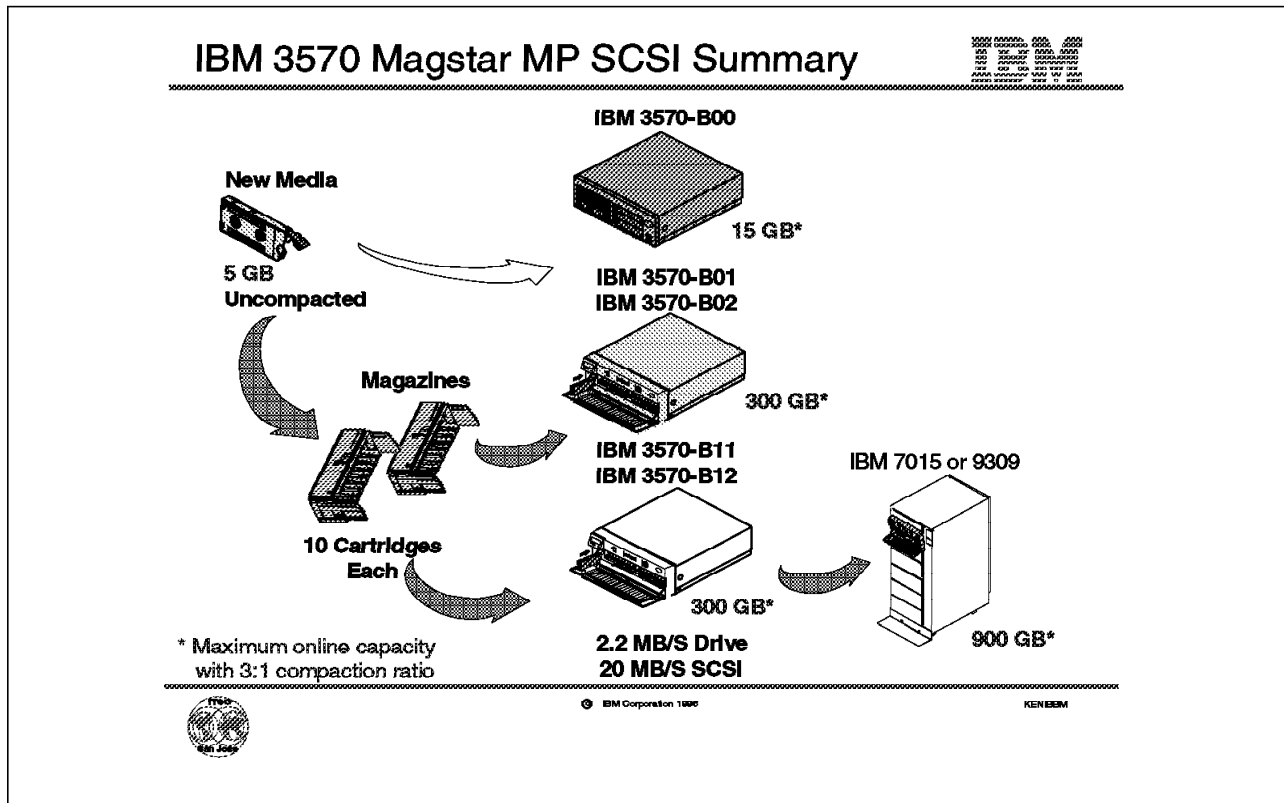

Figure 9. IBM 3570 Magstar MP Tape Subsystem SCSI Summary

1.9 IBM 3570 Magstar MultiPurpose Tape Subsystem SCSI Summary

Figure 9 shows a summary of the possibilities for using the IBM 3570 Magstar MultiPurpose tape subsystem in a SCSI environment:

- **A new type of metal particle medium** includes a binder formulation for greater reliability and longer archive life. The new medium is used in a two-reel cartridge with a capacity of 5 GB uncompacted data. The new two-reel cartridge uses 8-mm-wide tape and is specifically developed for the IBM Magstar MP Tape Subsystem.
- **A 10-cartridge magazine** provides quick loading and removal of a set of cartridges to and from the library autoloader. The magazine can hold up to 10 cartridges.
- The host attachment of the Magstar MP tape drive uses a SCSI interface. The tape drive has its own integrated control-unit function, a 2.2 MB/sec drive data rate, and a 20 MB/sec SCSI data rate. The IBM 3570 Magstar tape drive also has an improved compression algorithm (Ziv-Lempel) which is called *IBMLZ1* and will be more efficient than the binary arithmetic compression (BAC) algorithm used in the IBM 3480 and 3490 Tape Subsystem's improved data recording capability (IDRC).

The Magstar MP tape drive will be available in several configurations:

- As a stand-alone tape drive, *IBM 3570-B00*
- In a table-top library unit with either one (*IBM 3570-B01*) or two (*IBM 3570-B02*) tape drives installed. The library unit has an autoloader in

which two magazines can be mounted, giving a total online capacity of up to 300 GB (with a compaction ratio of 3:1).

- Up to three rack-mounted library units, *IBM 3570-B11* (one Magstar MP tape drive) or *IBM 3570-B12* (two Magstar MP tape drives) can be installed in a standard 19-inch rack, such as the IBM 7202 or the IBM 9309, which gives an online capacity of just under 1 TB (compacted).

The IBM 3570 Magstar MultiPurpose Tape Subsystem is described in more detail in Chapter 4, “IBM 3570 Magstar MP Tape Subsystem” on page 123.

Chapter 2. The IBM Magstar Virtual Tape Server

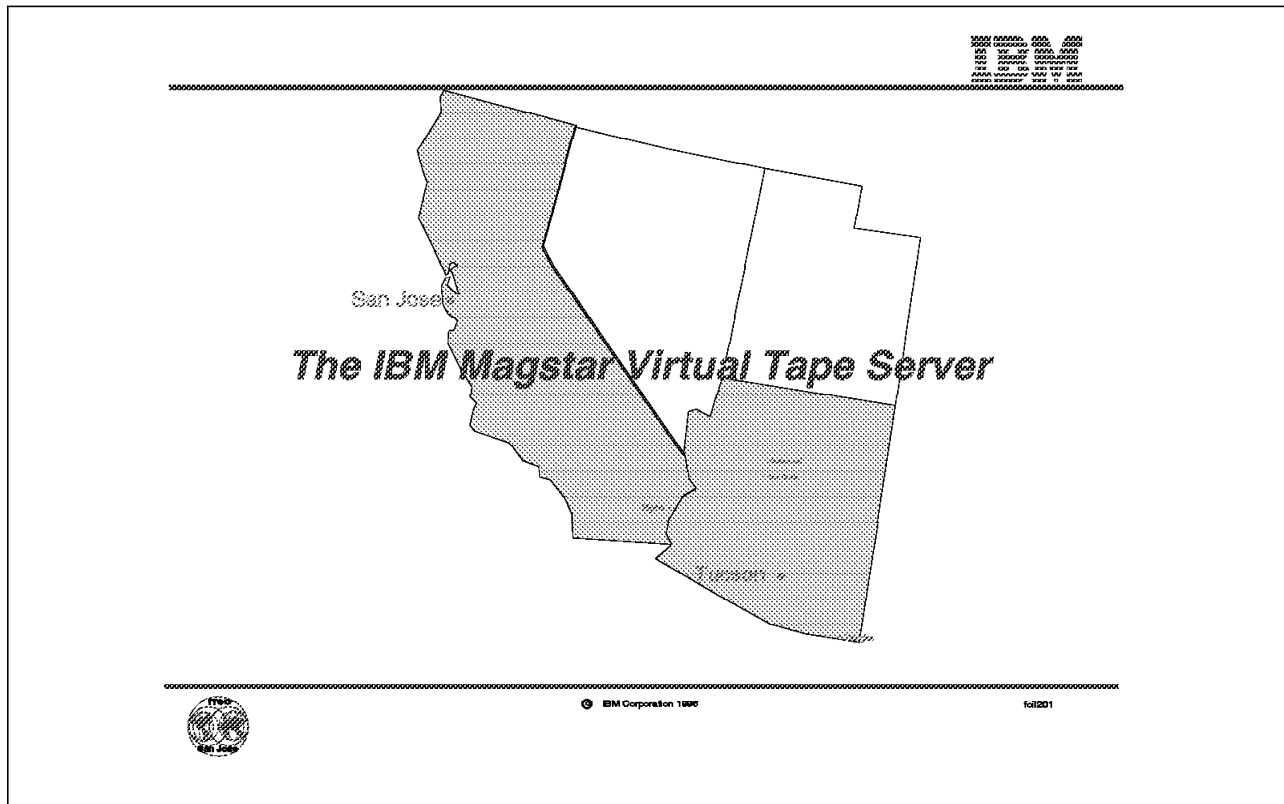

Figure 10. Title Slide of the IBM Magstar Virtual Tape Server Presentation

The IBM Magstar Virtual Tape Server, integrated with the IBM Tape Library Dataservers, delivers an increased level of storage capable to the traditional storage products hierarchy. The host software sees Virtual Tape Server subsystem as a 3490 Enhanced Capability (3490E) Tape Subsystem with associated standard (CST) or Enhanced Capacity Cartridge System Tapes (ECCST). This virtualization of both the tape devices and the storage media to the host allows for transparent utilization of the capabilities of the IBM 3590 tape technology.

In this chapter, we present the IBM Magstar Virtual Tape Server and cover the following topics:

- We introduce and give you a brief overview of the key attributes and the general concept of the Virtual Tape Server subsystem.
- We describe the hardware components and building blocks and list the supporting host software products.
- We provide the information required for sizing and configuration of a Virtual Tape Server subsystem.
- We explain the implementation considerations for supported host software environments.
- We describe migration and operational considerations.

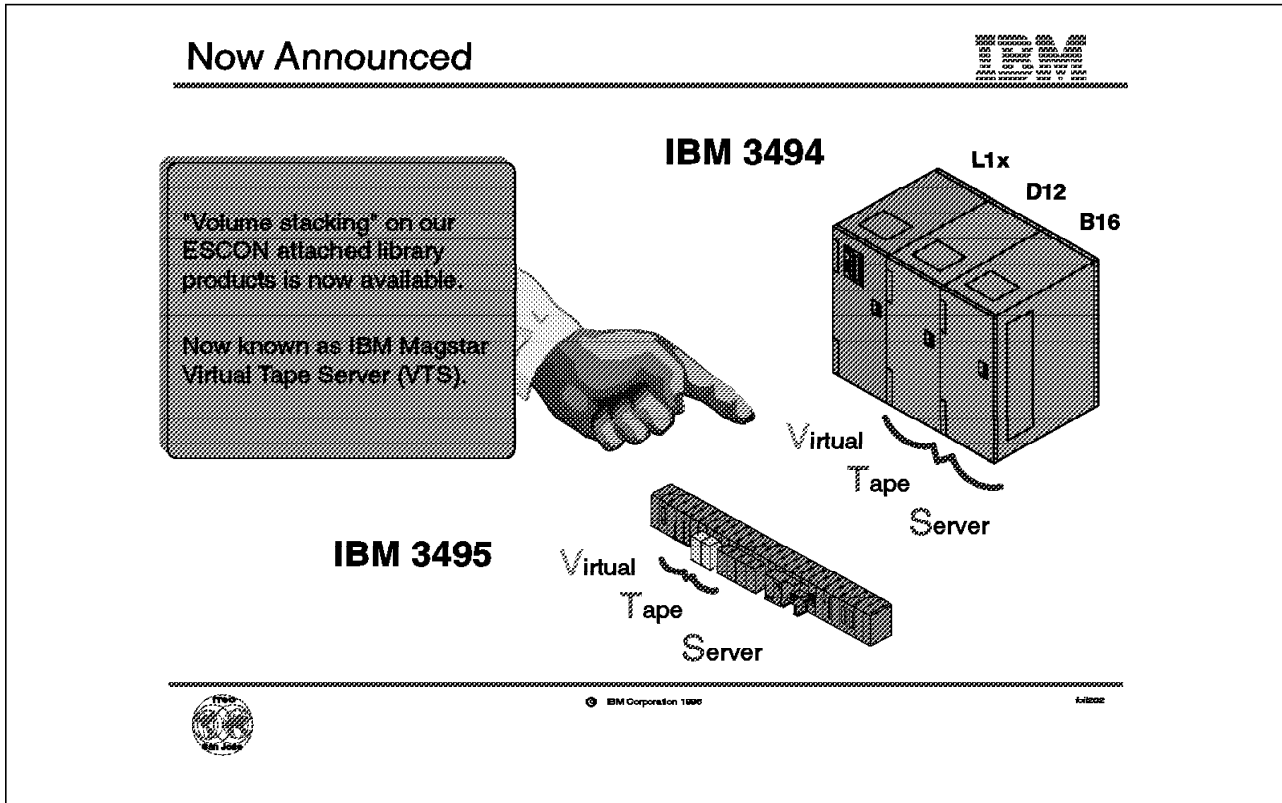

Figure 11. Now Announced the IBM Magstar Virtual Tape Server

2.1 Now Announced the IBM Magstar Virtual Tape Server

In April 1995, together with the announcement of the IBM Magstar 3590 High Performance Tape Subsystem, IBM announced a statement of direction to deliver capacity-enabling technology (also called volume stacking) on our ESCON-attached library products.

Fulfilling this statement of direction, IBM now announces the IBM Magstar Virtual Tape Server (VTS) for IBM 3494 and 3495 Tape Libraries.

2.1.1 Virtual Tape Server for IBM 3494 Tape Library

The VTS subsystem in an IBM 3494 is installed in two frames:

- One IBM 3494-D12 drive unit frame houses the IBM 3590-B1A tape drives that are dedicated to the Virtual Tape Server function.
- One IBM 3494-B16 Virtual Tape Server unit frame which contains the required hardware and microcode to enable full 3590 Magstar tape storage capacity, plus cartridge storage cells.

Figure 11 shows the minimum configuration of a Virtual Tape Server subsystem in IBM 3494 Tape Library including one library unit frame, one drive unit frame, and one Virtual Tape Server unit frame.

2.1.2 Virtual Tape Server for IBM 3495 Tape Library

Installed in an IBM 3495 Tape Library, the Virtual Tape Server subsystem is composed of:

- One IBM 3590-A14 frame that houses four IBM 3590-B1A tape drives which are dedicated to the Virtual Tape Server function. No IBM 3590-A00 ESCON tape controller is required.
- One IBM 3495-B16 Virtual Tape Server unit frame that contains the required hardware and microcode to enable full tape storage capacity.

Figure 11 on page 18 shows the smallest Virtual Tape Server subsystem in an IBM 3495 Tape Library configuration consisting of an IBM 3495 Tape Library Model L20, including the IBM Magstar Virtual Tape Server.

Introduction to the IBM Magstar VTS

- **Transparent capacity exploitation and management**

- **Host software transparency**
- **IBM Magstar Virtual Tape Server Controller**
 - Automatically fills and manages Magstar 3590 cartridge capacity
 - Volume movement to and from the Tape Volume Cache and 3590 cartridges or Magstar tape drives
- **High Capacity Tape Volume Cache**
 - All host interaction goes through the cache
 - Multi-logical volume access
 - Virtual volumes reaccessible at disk speeds

- **Fully integrated in IBM 3494/3495 Tape Libraries**

- **ESCON channel attachment**
- **Coexistence in same library with 3490 / 3490E / 3590**
- **Automatic exploitation of future tape technology evolution**

Integration of proven IBM technologies :
Magstar 3590, Serial Storage Architecture, Storage Management Techniques

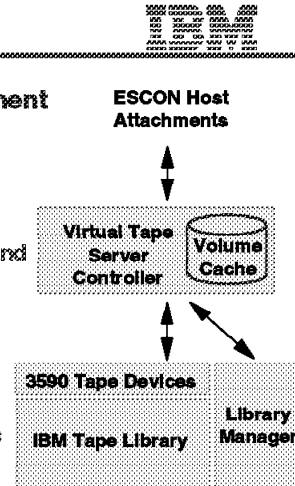

© IBM Corporation 1996

51220

Figure 12. Introduction to the IBM Magstar Virtual Tape Server

2.2 Introduction to the IBM Magstar Virtual Tape Server

The IBM Magstar Virtual Tape Server Controller, Tape Volume Cache, and the IBM 3590 Magstar tape drives, together with the required housing, make up the IBM Magstar Virtual Tape Server subsystem, allowing automatic utilization of the Magstar cartridge storage capacity and the drive data rate of 9 MB/s.

2.2.1 Transparent Capacity Exploitation and Management

The IBM Magstar Virtual Tape Server automatically fills the 30 GB Magstar 3590 cartridge. This is completed by the built-in storage management functions and is transparent to any software, whether operating system or third-party program.

2.2.1.1 Host Software Transparency

The operating system knows only about tape drives and volumes and does not need to manage the storage of virtual and stacked volumes. Therefore, in most installations you do not need to change your operating system software at all.

2.2.1.2 IBM Magstar Virtual Tape Server Controller

The IBM Magstar Tape Server Controller and its associated microcode, are the key components of the Virtual Tape Server subsystem:

- It automatically fills and manages Magstar 3590 cartridge capacity.
- It controls and manages the volume movement to and from the tape volume cache and 3590 cartridges or Magstar tape drives.

2.2.1.3 High Capacity Tape Volume Cache

The tape volume cache (TVC) is the disk component of the Virtual Tape Server subsystem. It is used to buffer virtual volumes created by the host before they are written to the physical IBM 3590 tape devices. It has these advantages:

- All host interaction is through the tape volume cache. The operating system sees 32 virtual tape devices which are physically represented by storage space on the tape volume cache's RAID (Redundant Array of Independent Disk) DASD. The operating system cannot directly write a logical volume to a stacked Magstar cartridge.
- Multiple virtual volumes can be accessed in parallel because they physically reside on the DASD.
- Virtual volumes are reaccessible at disk speeds. Tape motion commands such as space, locate, rewind, and unload are mapped into disk commands and happen in milliseconds, not seconds as for traditional tape commands.

2.2.2 Fully Integrated in IBM 3494 and IBM 3495 Tape Libraries

The IBM Magstar Virtual Tape Server can only be installed inside an IBM 3494 or 3495 Tape Library, and is fully supported through the Library Manager. For instance, the location of virtual volumes and physical Magstar cartridges is stored in the Library Manager console. Logical and physical volume serial ranges are defined at the Library Manager console.

2.2.2.1 ESCON Channel Attachment

The IBM Magstar Virtual Tape Server is attached to the host through ESCON channels, allowing two simultaneous ESCON data transfers.

2.2.2.2 Coexistence in Same Library with IBM 3490, 3490E or 3590

The IBM Magstar Virtual Tape Server can be installed in an IBM 3495 with IBM 3490, 3490E, and 3590 tape drives. Inside an IBM 3494, the IBM Magstar Virtual Tape Server can be installed together with IBM 3490E, and ESCON- and SCSI-attached IBM 3590 tape drives. This ensures investment protection and ease of migration.

2.2.2.3 Automatic Exploitation for Future Tape Technology Evolutions

The concept of the IBM Magstar Virtual Tape Server allows for immediate utilization of future enhancements to the IBM 3590 tape technology without impact to the host software.

2.2.3 Integration of Proven IBM Technologies

The IBM Magstar Virtual Tape Server is built using proven IBM technologies. The Virtual Tape Server controller, for example, is based on RISC technology

2.2.3.1 Magstar 3590

These are the industry's leading half-inch tape drives for performance, capacity, and reliability. Over 7,000 IBM 3590 tape drives have been shipped since general availability in September 1995.

2.2.3.2 Serial Storage Architecture

Serial Storage Architecture (SSA), together with high-performance disks, provides improved performance and availability over previous-generation disk architecture.

2.2.3.3 Storage Management Techniques

The storage management techniques are built on over 20 years of IBM experience; they use for example, many features and functions found in IBM's industry-leading DFSMSHsm and ADSM software products.

Virtual Tape Server Key Attributes

- **One VTS subsystem per IBM 3494 or 3495**
 - ◆ **32 logical 3490E drives**
 - ◆ **Up to 50,000 logical Volumes**
 - MEDIA1 = 400 MB
 - MEDIA2 = 800 MB
- **Defined physical configurations**
 - ◆ **IBM 3494**
 - Three IBM 3590-B1As plus 36 GB TVC
 - Six IBM 3590-B1As plus 72 GB TVC
 - ◆ **IBM 3495**
 - Four IBM 3590-B1As plus 36 GB TVC
 - Four IBM 3590-B1As plus 72 GB TVC
- **Up to 40 TB of tape data per VTS subsystem**

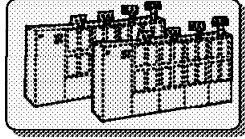
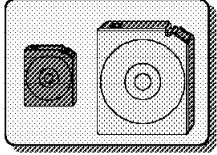
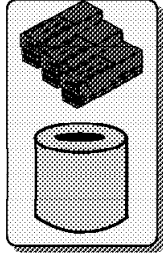

© IBM Corporation 1999



Figure 13. Virtual Tape Server Key Attributes

2.3 Virtual Tape Server Key Attributes

Figure 13 lists the logical and physical key attributes of the IBM Magstar Virtual Tape Server.

2.3.1 One VTS Subsystem per IBM 3494 or IBM 3495

Currently, one Virtual Tape Server subsystem can be installed in a single IBM 3494 or 3495 tape library. The Virtual Tape Server subsystem can be integrated into an existing automated tape library in addition to, or instead of, already installed physical tape drives. VTS tape drives can be shared across different platforms and Sysplexes, just like any other IBM 3490E subsystem can in our libraries. For details of the installation requirements, please refer to Figure 18 on page 37 through Figure 24 on page 49.

2.3.1.1 Number of Logical 3490E Tape Drives

Before this announcement, no more than sixteen IBM 3490E tape drives could be installed in a single IBM 3494 tape library or an IBM 3495-L20.

Each Virtual Tape Server subsystem presents itself to the host as 32 3490E tape drives, thus allowing much more parallelism in tape processing. Because of the large number of logical tape drives, more drives can now be dedicated to different hosts and platforms. In most cross-platform installations, dynamic and automatic sharing of tape drives may no longer be required, although the Virtual Tape Server fully supports existing tape drive sharing methods.

2.3.1.2 Up to 50,000 Logical Volumes

A single Virtual Tape Server subsystem can manage up to 50,000 logical 3490E volumes, making even a small tape library look very large. We describe logical volumes in detail in Section 2.4, “Virtual Tape Server Key Concepts” on page 26.

Logical volumes are defined through the Library Manager console and can have two different sizes:

- MEDIA1=400 MB
MEDIA1 reflects a CST type of cartridge written in 36-track recording technology without using the Improved Data Recording Capability (IDRC) that a physical IBM 3490E tape drive provides.
- MEDIA2=800 MB
MEDIA2 reflects an ECCST type of cartridge written in 36-track recording technology without using the IBM 3490E’s IDRC.

Logical 3490E volumes are stacked on physical Magstar cartridges allowing effective use of their large capacity of +30 GB and of the IBM 3590 tape drive’s excellent performance.

The number of stacked Magstar 3590 physical cartridges managed by the IBM Magstar Virtual Tape Server is limited only by the number of storage slots inside your IBM 3494 or 3495 tape library.

2.3.2 Defined Physical Configurations

Regardless of the physical Virtual Tape Server configuration, the logical attributes such as the number of virtual drives and volumes remain the same as listed above.

2.3.2.1 IBM 3494

The Virtual Tape Server in an IBM 3494 is supported in two configurations at general available time according to the number of physical IBM 3590-B1A tape drives and tape volume cache storage capacity:

- Three IBM 3590-B1As plus 36 GB of tape volume cache
If your tape operation is inhibited by the number of tape drives available but not in terms of throughput, you might consider installing this configuration. For details on sizing the IBM Magstar Virtual Tape Server, please refer to Figure 30 on page 61.
- Six IBM 3590-B1As plus 72 GB of tape volume cache
This configuration is the maximum configuration for a Virtual Tape Server subsystem in an IBM 3494.

More configurations are being tested; support for these will be announced at the completion of testing. Some of the configurations being tested are four- and five-drive configurations.

2.3.2.2 IBM 3495

An IBM 3590-A14 frame included in a IBM 3495 tape library must always contain four IBM 3590-B1A tape drives. Because the IBM 3590-B1As used by the Virtual Tape Server are installed in an IBM 3590-A14 frame, the following two configurations are available:

- Four IBM 3590-B1As plus 36 GB of tape volume cache
- Four IBM 3590-B1As plus 72 GB of tape volume cache

2.3.3 Up to 40 TB of Tape Data per Virtual Tape Server Subsystem

The IBM Magstar Virtual Tape Server introduces new dimensions for managing tape data. Instead of wasting tape storage capacity by not effectively utilizing the full length of a tape cartridge, the IBM Magstar Virtual Tape Server occupies only the amount of tape storage necessary to store the number of bytes written by a host application. For instance, a tape data set of 200 MB which is written to a virtual 3490E MEDIA2 cartridge will occupy only 200 MB on the tape volume cache and on the stacked Magstar cartridge and not use the possible 800 MB.

Defining the maximum number of logical volumes using MEDIA2 only, and making full use of their 800 MB capacity, allows you to store up to 40 TB of tape data in a single Virtual Tape Server subsystem.

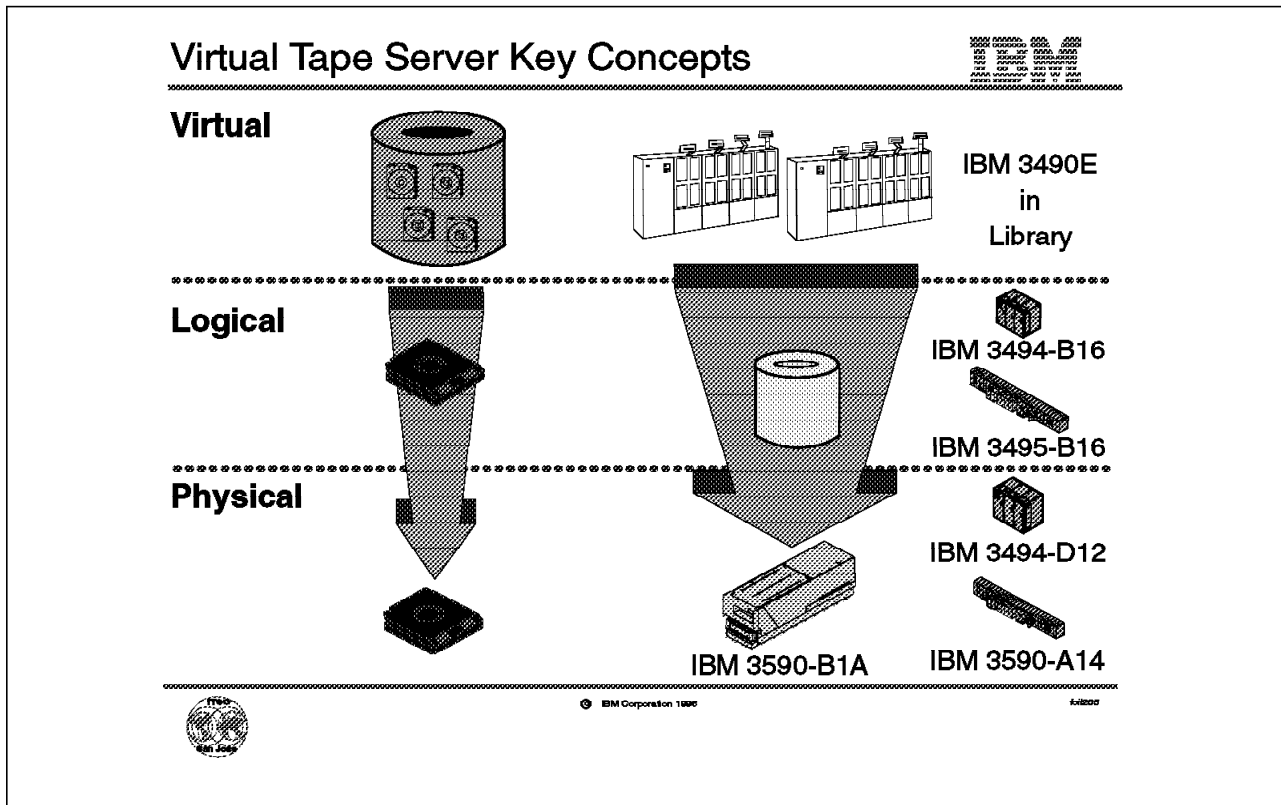

Figure 14. Virtual Tape Server Key Concepts.

2.4 Virtual Tape Server Key Concepts

Along with introducing the IBM Magstar Virtual Tape Server, we introduce new views of volumes and devices because of the different knowledge about volumes and devices in the host system and the hardware. Using a Virtual Tape Server subsystem, the host application writes tape data to virtual devices. The volumes created by the hosts are called Virtual Volumes and are physically stored in a tape volume cache which is built from RAID DASD.

Through tape volume cache management policies, the virtual tape server management software moves host-created volumes from the tape volume cache to a Magstar cartridge managed by the Virtual Tape Server subsystem. Once a virtual volume is moved from the tape volume cache to tape, it becomes a logical volume.

To allow software transparency and implementation of a Virtual Tape Server subsystem with no changes to the host's operating system software, the host has only a virtual view of the volumes and tape drives managed by the Virtual Tape Server subsystem. The host cannot distinguish physical from virtual volumes or their respective tape drives and will treat them as if they were "real" cartridges and devices.

Management of physical Magstar tape drives and Magstar cartridges is completely under control of the VTS storage management software.

2.4.1 Virtual Volumes

When the host application writes tape data to the IBM Magstar Virtual Tape Server, a virtual volume is created. Virtual volumes are physically stored in the tape volume cache and all host commands are issued to the virtual volume residing on DASD. All host interaction with tape data in a Virtual Tape Server subsystem is through virtual volumes and through virtual tape devices.

Each virtual volume has the following characteristics (just like a real volume):

- It has a unique volume serial (volser) number known to the host.
- It is loaded and unloaded on a virtual device.
- It supports all tape write modes, including Tape Write Immediate.
- It contains all standard tape marks and data blocks.
- It supports an IBM standard label.
- It can be appended to after it was initially written from the beginning of tape.
- Data written is guaranteed to be in the tape volume cache when a command is completed successfully that either implicitly or explicitly causes synchronization.
- Each host written record has a logical block ID.
- End of volume is signaled when the total number of bytes written has reached 400 MB for an emulated CST or 800 MB for an emulated ECCS T volume.

Virtual volumes can exist only in an IBM 3494 or 3495 tape library. You can direct a tape data set to a virtual tape drive by directing it into a specific tape library.

2.4.2 Virtual Devices

From a host perspective, the Virtual Tape Server subsystem looks like two IBM 3490E tape control units, each with 16 devices attached through ESCON channels. Virtual tape drives are defined just like physical IBM 3490-A10 controller with 16 addresses through HCD (Hardware Configuration Definition), or through IOCP (I/O Configuration Program), and MVSCP or HCPRIO macro. However, you should not define a preferred path for the virtual devices.

An IOCP example of two VTS strings has been included showing the virtual drives configured using the CUADD statements:

```
Virtual Tape Server IOCP

9032 - PORT D6 = CHPID'S 29 & 32
9032 - PORT D7 = CHPID'S 2A & 35

*
CNTLUNIT CUNUMBR=32E,PATH=(32,29),UNIT=TAPE, X
UNITADD=((00,16)),LINK=(D6,D6),CUADD=0
CNTLUNIT CUNUMBR=35E,PATH=(35,2A),UNIT=TAPE, X
UNITADD=((00,16)),LINK=(D7,D7),CUADD=0
TAPE1AE0 IODEVICE ADDRESS=(1AE0,16),UNIT=TAPE,CUNUMBR=(32E,35E), X
UNITADD=00
*
CNTLUNIT CUNUMBR=32F,PATH=(32,29),UNIT=TAPE, X
UNITADD=((00,16)),LINK=(D6,D6),CUADD=1
CNTLUNIT CUNUMBR=35F,PATH=(35,2A),UNIT=TAPE, X
```

```
UNITADD=((00,16)),LINK=(D7,D7),CUADD=1
TAPE1AFO IODEVICE ADDRESS=(1AFO,16),UNIT=TAPE,CUNUMBR=(32F,35F),      X
UNITADD=00
```

Each virtual device has the following characteristics (just like real tape devices):

- It has a host device address.
- It is included in the I/O generation for the system.
- It is varied online or offline to the host.
- It signals ready when a virtual volume is loaded.
- It responds and processes all IBM 3490E I/O commands
- It becomes not ready when a virtual volume is rewound and unloaded.

The functionality of the 3490E Integrated Cartridge Loader (ICL) is also included in the virtual device's capability. All virtual devices indicate that they have an ICL. You can associate a media type with the cartridge loader that will allow fast access for scratch mounts. The active status of the cartridge loader depends on the availability of scratch volumes of the assigned media type.

2.4.3 Logical Volumes

When a virtual volume is moved from the tape volume cache, the process is called Destaging, and the volume becomes a logical volume. When a logical volume is moved from a Magstar cartridge to the tape volume cache, the process is called staging and the volume becomes a virtual volume again.

As virtual volumes are moved from the tape volume cache to a Magstar cartridge, they are stacked on the cartridge end to end, taking up only the number of bytes written by the host, thereby effectively utilizing all of the cartridge's storage capacity.

You define the volume serial numbers for the logical volumes through the Library Manager console. The Library Manager console associates a Fast-Ready attribute with the category that the volume serial numbers are defined within. The Library Manager assigns the logical volumes to the insert category and notifies all attached hosts. Subsequent host inventory processing is performed as for physical CST and ECCST volumes.

Because a logical volume resides on a physical cartridge together with many other logical volumes, the library containing virtual and logical volumes must be treated as a closed store. This means that you can move the data on the volumes electronically but not physically.

Note: Currently, stacked Magstar cartridges cannot be removed from the IBM Magstar Virtual Tape Server. Therefore, these cartridges cannot be ejected from the tape library.

2.4.4 Physical Volumes

The physical Magstar cartridges used by the IBM Magstar Virtual Tape Server to store logical volumes are totally under the control of the Virtual Tape Server subsystem and are not known to the hosts. The physical volume is also called "stacked volume." However, they must have unique volume serial numbers like any other cartridge in a tape library.

Through the Library Manager console, you define which cartridges are to be used by the Virtual Tape Server subsystem. Logical volumes are mapped by the internal storage management software.

2.4.5 Physical Devices

The physical Magstar tape drives installed in the IBM Magstar Virtual Tape Server are invisible to any attached host system. They are completely under the control of the Virtual Tape Server subsystem and therefore cannot be addressed by any host system.

Virtual Tape Server Hardware Overview

• IBM 3494 Tape Library

- One Model L10, L12, or L14 frame
- One VTS subsystem per IBM 3494
 - One IBM 3494-D12 housing three or six IBM 3590-B1A tape drives
 - One IBM 3494-B16 frame including the Tape Volume Cache and the VTS subsystem controller
- Additional D10, D12, D14, S10 frames

• IBM 3495 Tape Library models L20, L30, L40, L50

- One VTS subsystem per IBM 3495
 - One IBM 3590-A14 frame housing four IBM 3590-B1A tape drives
 - One IBM 3495-B16 frame including the Tape Volume Cache and the VTS subsystem controller

IBM 3494

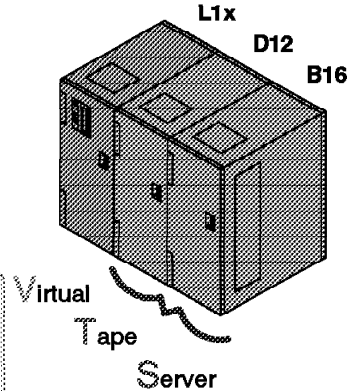

© IBM Corporation 1996

51200

Figure 15. Hardware Overview

2.5 Hardware Overview

This section describes hardware overview for Virtual Tape Server.

2.5.1 IBM 3494 Tape Library

An IBM 3494 Tape Library offers great configuration granularity because it is made up of frames of identical size. For details on IBM 3494 configurations, please refer to Figure 46 on page 98.

An IBM 3494 Tape Library including the IBM Magstar Virtual Tape Server is composed of the hardware frames discussed below.

2.5.1.1 One IBM 3494 Model L10, L12, or L14 Control Unit Frame

An IBM 3494 must include one library control-unit frame which contains the Library Manager, the convenience I/O station (optional), and up to two tape drives:

- IBM 3490E-CxA tape drives with an integrated controller in the IBM 3494-L10
- SCSI-attached IBM 3590-B1A tape drives in the IBM 3494-L12
- ESCON-attached IBM 3590-B1A tape drives and the IBM 3590-A00 controller in the IBM 3494-L14.

The IBM 3494-L12 and IBM 3494-L14 library control unit frame can be installed without drives. For an IBM 3494-L10 frame, you must submit a Request for Price Quotation (RPQ).

2.5.1.2 One VTS Subsystem per IBM 3494

Currently, only one Virtual Tape Server subsystem can be installed in each IBM 3494 tape library. The IBM Magstar Virtual Tape Server is made up of the following components:

- One IBM 3494-D12 drive frame housing three or six IBM 3590-B1As

These IBM 3590-B1As are for exclusive use of the IBM Magstar Virtual Tape Server. They are attached only to the Virtual Tape Server controller, which is installed in the IBM 3494-B16 frame, and are therefore not visible to any attached host. No additional tape drives that directly attach to any host can be installed inside an IBM 3494-D12 frame owned by the Virtual Tape Server.

When ordering an IBM 3494-D12 frame, you must order the tape drives separately, as you would for non-VTS-attached IBM 3494-D12 frames.

The IBM 3494-D12 frame provides 290 cartridge storage cells. The occupancy of the storage cells is under control of the Library Manager. Therefore, these storage cells can be used by the Library Manager to store any physical cartridge, not only those belonging to the Virtual Tape Server subsystem.

- One IBM 3494-B16 frame including the tape volume cache and the VTS subsystem controller

If you open the door of an IBM 3494-B16 frame, you will notice that it looks almost like an IBM 3494-S10 storage unit frame from the inside. This is because the IBM 3494-B16 frame provides storage capacity for 400 cartridges as well as containing the hardware and software components of the Virtual Tape Server. As in the Virtual Tape Server-owned IBM 3494-D12 frame, these storage cells can also contain cartridges that do not belong to the Virtual Tape Server subsystem.

2.5.1.3 Additional IBM 3494 Model D10, D12, D14, or S10 Frames

An IBM 3494 tape library can be composed of up to 16 frames. An additional 13 frames can be added, consisting of drive unit frame IBM 3494-D10/D12/D14 and storage unit frame IBM 3494-S10.

2.5.2 IBM 3495 Tape Library Models L20, L30, L40, L50

The IBM Magstar Virtual Tape Server is integrated in an IBM 3495 tape library by attaching two frames to either model, similar to adding two IBM 3590-A14 frames or a combination of one IBM 3490-A20 tape control unit and one IBM 3490-B40 tape drive box.

2.5.2.1 One Virtual Tape Server Subsystem per IBM 3495

At this time, only one Virtual Tape Server subsystem can be added to an IBM 3495 tape library. The Virtual Tape Server consists of:

- One IBM 3590 Model A14 frame, housing four Magstar tape drives Model B1A.

The IBM 3590-A14 frame for integration in a Virtual Tape Server does not include the IBM 3590-A00 controller. You must order the IBM 3590-B1A tape drives separately.

The IBM 3590-B1A tape drives are not accessible by any host system and are for exclusive use of the Virtual Tape Server. All of the tape drives in the IBM 3590-A14 are dedicated to the Virtual Tape Server subsystem and cannot directly attach to a host system instead.

- One IBM 3495-B16 Virtual Tape Server unit frame including the tape volume cache and the VTS subsystem controller.

- EREP V3.5 plus program temporary fix (PTF)

If you are using BTLS for DFSMS/MVS (5655-056), the following software levels are required:

- MVS/ESA V4.3.0 or V5.1.0
- DFSMS/MVS V1.1.0, V1.2.0, or V1.3.0
- EREP V3.5 plus PTF

If you are using other 3490E emulations, such as Magstar tape drives attached to the host through the IBM 3591-A01 controller, you must install BTLS to allow the host to distinguish between native and emulated IBM 3490E devices.

2.6.2 VM/ESA

In a native VM/ESA environment, the Virtual Tape Server requires the following software levels:

- VM/ESA V1.2 or higher
- DFSMS/VM Function Level 221

For guest operating system support, VM/ESA V1.2. or higher must be installed, but DFSMS/VM is not required.

2.6.3 VSE/ESA

Native VSE/ESA does not support the IBM Magstar Virtual Tape Server. If VSE/ESA is running as a guest under VM, the following software levels are required for support of a Virtual Tape Server subsystem installed in an IBM 3494 tape library:

- VSE/ESA V1.3.5 or higher plus PTFs
- EREP V3.5 plus PTFs

Please note that the IBM Magstar Virtual Tape Server in a IBM 3495 tape library is not supported for VSE/ESA, either native or running as a guest under VM.

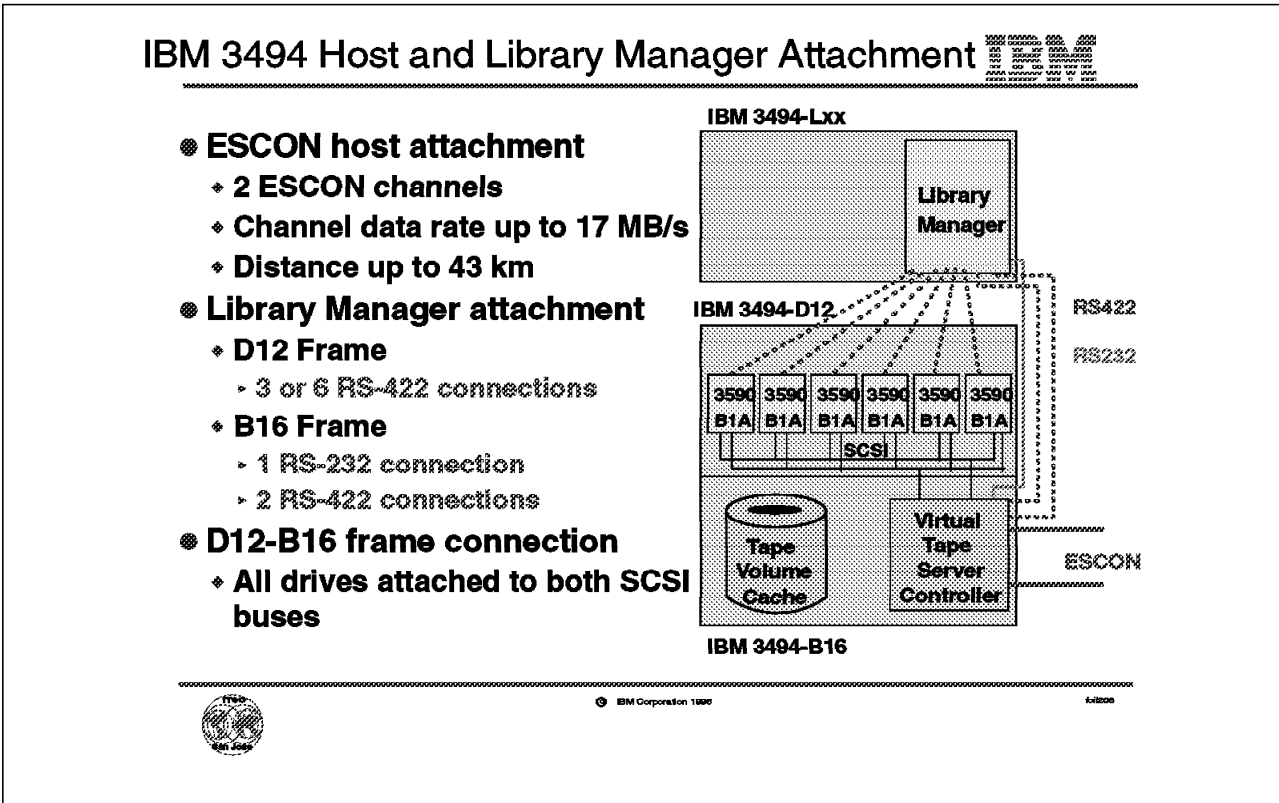

Figure 17. IBM 3494 Host and Library Manager Attachment

2.7 IBM 3494 Host and Library Manager Attachment

In Figure 17, we outline the integration of a Virtual Tape Server subsystem into an automated tape library through its attachments to the host and the Library Manager for an IBM 3494 tape library.

2.7.1 ESCON Host Attachment

The Virtual Tape Server subsystem is attached to the host through two ESCON channels, each providing 64 logical paths. Thus, the subsystem provides 128 logical paths in total.

Each ESCON channel provides a channel data rate of 17 MB/s instantaneous.

The Virtual Tape Server subsystem can be installed at the same distance of 43 km from the host as native Magstar tape drives.

All 32 virtual tape drives can be addressed through either ESCON channel.

2.7.2 Library Manager Attachment

The IBM 3590-B1A tape drives residing in the IBM 3494-D12 frame are not attached to any host system. They are attached solely to the Library Manager through an RS-422 connection to provide the required communication path for library-related commands, and to the Virtual Tape Server controller IBM 3494-B16.

The Virtual Tape Server controller is connected to the Library Manager through one RS-232 connection and two RS-422 connections to provide the required communication paths.

A total of five or eight RS-422 connections are required, depending on the number of Magstar tape drives installed in the Virtual Tape Server plus one RS-232 connection.

Without additional features installed on the library control-unit frame Models L10, L12, or L14, the library manager provides four RS-232 direct-attached host ports and four RS-422 control-unit or direct-attached drive connections. Currently, you need to order additional features for the IBM 3494 Model Lxx frames to provide the required Library Manager connections to the Virtual Tape Server subsystem.

Depending on the number of IBM 3590-B1A tape drives in the Virtual Tape Server controller (IBM 3494-B16) configuration and whether other control unit are installed in the IBM 3494, Feature 5229 and one or two Feature 5228 may need to be installed.

- If the IBM 3494-B16 contains three IBM 3590-B1A tape drives, up to an additional seven control units can be connected to the Library Manager with appropriate Features 5229 and 5228.
- If the IBM 3494-B16 contains six IBM 3590-B1A tape drives, up to an additional four control units can be connected to the Library Manager with appropriate Features 5229 and 5228.

For further details on configuring additional tape subsystems and their Library Manager connections, please refer to Section 3.6, “IBM 3494 ESCON Configuration” on page 93.

2.7.3 IBM 3494-D12 and IBM 3494-B16 Frame Connections

All IBM 3590-B1A tape drives installed in the IBM 3494-D12 frame are connected to both SCSI buses of the Virtual Tape Server controller IBM 3494-B16. Because of this connection, both frames must be installed adjacent to one another.

IBM 3494 VTS Configuration Guidelines

0000 000000 000 0000
0000 000000 000 0000
00 00 00 0000 0000
00 00000 00000000
00000000 00000000
00 00 00 00 00 00 00
0000 000000 000 0000
0000 000000 000 0000

- **D12/B16 frame must be inserted within the first eight frames**
- **D12 frame must always be left of the B16 frame**
- **D12 and B16 frames must directly attach to each other**
- **A modem must be supplied for the the B16 frame**
- **L12/L14 frames can be installed without drives**

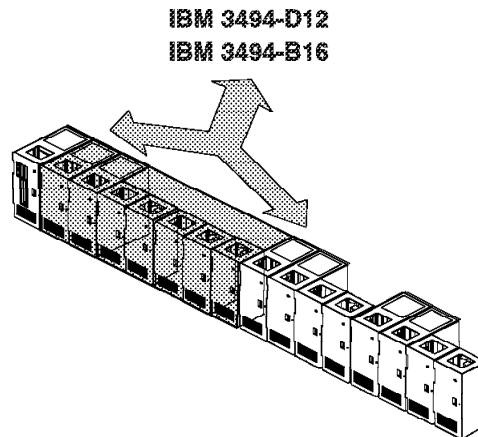

© IBM Corporation 1990

5/20/90

Figure 18. IBM 3494: VTS Configuration Guidelines

2.8 IBM 3494 Virtual Tape Server Configuration Guidelines

For physical configuration of an IBM 3494 Tape Library including the Virtual Tape Server, five basic configuration rules apply.

2.8.1 The L12/L14 Frame Can Be Without Drives

For a minimum configuration of an IBM 3494 with a Virtual Tape Server subsystem, the L12 or L14 frame can be installed without tape drives. Please submit an RPQ if you want to install a Model L10 frame without tape drives.

2.8.2 The D12/B16 Frame Must Be Within The First Eight Frames

If you are extending your current library to more than eight frames, you cannot install the Virtual Tape Server subsystem beyond the eighth frame.

If the configuration of frames in an installed IBM 3494 tape library has to be changed — for example, if frames must be moved to install a VTS subsystem, or if frames are moved from one IBM 3494 to another — an RPQ must be processed before the IBM 3494 Tape Library can be reconfigured. This RPQ is required for moving feature numbers 5300, 5302, 5304, and 5400, or Models B16, D10, D12, D14, and S10, and will ensure that the proper cables are available. The RPQ will also prepare for future changes or enhancements.

2.8.3 The D12 Frame Must Always Be to the Left of the B16 Frame

If you are planning to use an already installed IBM 3494-D12 frame to hold the IBM 3590-B1A tape drives of the Virtual Tape Server, it has to be installed to the left of the IBM 3494-B16 frame (between the IBM 3494-B16 and the IBM 3494-Lxx frames). If you want to change an existing empty IBM 3494-D14 frame into an IBM 3494-D12 frame, you must submit an RPQ.

2.8.4 The D12 and B16 Frames Must Directly Attach to One Another

You cannot install another frame between the IBM 3494-D12 and the IBM 3494-B16 frames that include an IBM Magstar Virtual Tape Server.

2.8.5 A Modem Must Be Supplied for the IBM 3494-B16 Frame

It is mandatory that you supply a modem for installation, operation, and remote support service of the IBM 3494-B16 frame. The same modems as for the IBM 3591-A01 and 3590-A00 Remote Support Facility (RSF) are supported. You can obtain a list of these modems from your IBM representative.

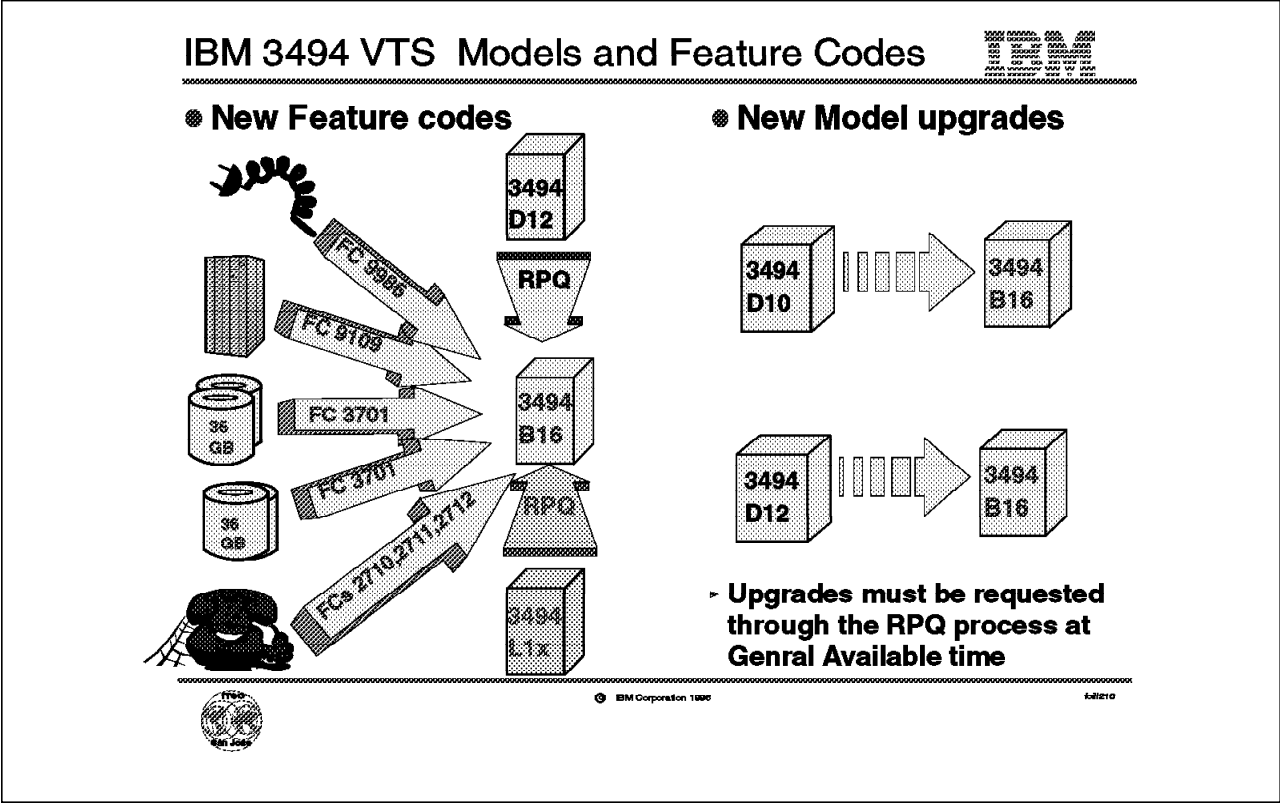

Figure 19. New IBM 3494 Features, Their Codes and Model Upgrades

2.9 New IBM 3494 Features, Their Codes and Model Upgrades

For integration of an IBM Magstar Virtual Tape Server into an existing IBM 3494, or for factory installation, you must order the features listed below. To use an existing IBM 3494 frames for installation of a Virtual Tape Server subsystem.

2.9.1 Features and Their Codes

To install an IBM 3494 plus IBM Magstar Virtual Tape Server, you must order some new features in addition to existing features and products. For instance, the IBM 3590-B1As that are installed inside the IBM 3494 Model D12 frame must be ordered separately.

2.9.1.1 IBM 3494 Model D12 plus Feature 9010

Feature 9010 for the IBM 3494 Model D12 frame indicates that the IBM 3590 tape drives in it are to be used by a Virtual Tape Server subsystem.

2.9.1.2 IBM 3494 Model L1x plus Feature 9006

To add an IBM 3494 Model B16 frame to a library, one feature 9006 must be specified for the library unit frames L10, L12, or L14 to track the number of frames installed in the library.

Note: Additional Library Manager connections are currently required for the installation of the Virtual Tape Server in an IBM 3494 tape library. Please refer to Section 2.7, "IBM 3494 Host and Library Manager Attachment" on page 35 for details about feature codes 5228 and 5229.

2.9.1.3 IBM 3494 Model B16 Feature Codes

Feature 9109 must be specified for the IBM 3494 Model B16 frame to specify its connection to the S/390 host systems.

Feature 9986 is required to provide a special line cord for Chicago, Illinois, U.S.A.

Feature 3701 provides the DASD storage for the tape volume cache. Each feature includes two DASD arrays providing you with 36 GB of usable tape volume cache. Currently, you can order either one or two Features 3701:

- Order one Feature 3701 if three IBM 3590-B1As are installed in the Virtual Tape Server subsystem.
- Order two Features 3701 if six IBM 3590-B1As are installed in the Virtual Tape Server subsystem.

It is required that you supply a modem for installation, operation, and remote support service of the Model B16 frame and that you install one of the following features code. The same modem and switch may be shared between an IBM 3494 Model B16, and an IBM 3590 Model A00.

2710 Remote Support Facility

This feature supplies a cable and connectors to attach a customer-supplied modem to the IBM 3494 Model B16 for remote diagnostic support. This feature should be specified only on the first IBM 3494 Model B16, or IBM 3590 Model A00 in an installation, as the Model B16s and Model A00s can use the same Remote Support Facility. Each IBM 3494 Model B16 must specify either Feature 2710, 2711, or 2712.

2711 Remote Support Switch

This feature provides a switch, cables, and connectors for the attachment of a IBM 3494 Model B16, and one or more 3590 Model A00 Controllers to the Remote Support Facility (Feature Code 2710). It should be ordered on a IBM 3494 Model B16, IBM 3495 Model B16, or IBM 3590 Model A00 that is the second product in an installation. Only one switch should be specified per installation site. Each IBM 3494 Model B16 must specify Feature 2710, 2711, or 2712.

2712 Remote Support Attachment

This feature provides an additional cable and connector to attach to the Remote Support Switch (feature code 2711). Order it on the IBM 3494 Model B16, or IBM 3590 Model A00 — that is, the third through fourteenth product in the installation. Each 3494 Model B16 must specify Feature 2710, 2711, or 2712.

Features 2710, 2711 and 2712 are both plant and field installable.

2.9.2 Model Upgrades

You must apply for an RPQ if you wish to upgrade an existing IBM 3494 Model D10 or D12 frame to an IBM 3494 Model B16 frame. The following Model conversions may be supported:

- IBM 3494 Model L10 to L12
- IBM 3494 Model L10 to L14

- IBM 3494 Model D10 to D12
- IBM 3494 Model D10 to D14
- IBM 3494 Model D10 to B16
- IBM 3494 Model D12 to B16
- IBM 3494 features 5300 to 5302
- IBM 3494 features 5300 to 5304

If you want to upgrade one or two existing frames to a D12+B16 frame combination and the model upgrades are not listed, also please submit an RPQ.

IBM 3494 VTS Environmental Requirements

0000 000000 000 000
 00 00 00 000 0000
 00 00000 000000000
 00 00 00000000000
 000 0000000000000
 000 00000000000000
 000 000000000000000

● Operating Environment

Condition	Temperature	Relative Humidity
Operating	10 to 37.0 C	20 to 80%
Nonoperating	10 to 51.7 C	8 to 80%
Storage	1 to 60.0 C	5 to 80%
Shipping	-40 to 60.0 C	5 to 100%

● Virtual Tape Server Specifications

Frame	Weight	Heat Output	Airflow	Max. Power
	*			
D12 + 3xB1A	405.8 kg	1.00 kw	3.9 qm/min	1.2 kVA
D12 + 6xB1A	491.6 kg	1.90 kw	7.8 qm/min	2.10 kVA
B16	450.0 kg	1.41 kw		2.16 kVA (1.83kVA)

* all weights assume no cartridges are installed in the 3494 frame.



© IBM Corporation 1996

52811

Figure 20. IBM 3494 Environmental Requirements

2.10 IBM 3494 Environmental Requirements

Figure 20 lists the physical specifications for the operation environment of an IBM 3494 tape library and the specifications for the Virtual Tape Server in IBM 3494.

The dimensions of the IBM 3494 Model B16 frame are the same as for every other IBM 3494 frame:

- Height: 1800 mm (70.9 in)
- Width : 750 mm (29.5 in)
- Depth : 1524 mm (60.0 in)

For further information on the Virtual Tape Server subsystem's physical installation please refer to *IBM 3494 Tape Library Dataserver Introduction and Planning Guide*.

IBM 3495 VTS Configuration Guidelines

- One IBM 3495-B16 is required
- One IBM 3590-A14 frame is required
 - ◆ Four IBM 3590-B1A tape drives
 - ◆ No IBM 3590-A00 controller
- B16 and A14 frames must be installed adjacent to each other
- A modem must be supplied for the IBM 3495-B16

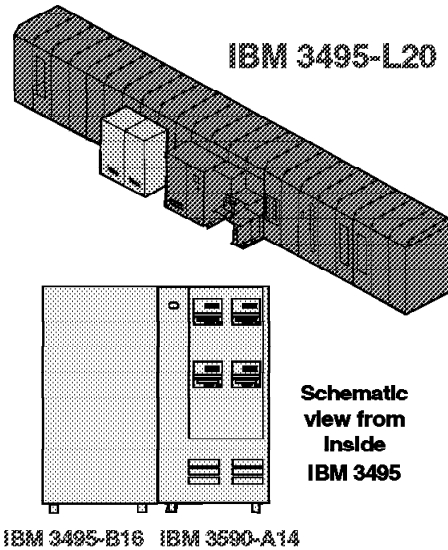

© IBM Corporation 1996

54812

Figure 21. IBM 3495 Virtual Tape Server Configuration Guidelines

2.11 IBM 3495 Virtual Tape Server Configuration Guidelines

For physical configuration of an IBM 3495 Tape Library including the Virtual Tape Server, the following basic configuration rules apply:

2.11.1 One IBM 3495-B16 Must Be Installed

The IBM 3495-B16 provides the ESCON connection to the host, and houses the tape volume cache and the Virtual Tape Server controller. In the IBM 3495 wall adjacent to the 3495-B16 storage cells can still exist, as is with the IBM 3490-Axx installed in an IBM 3495. These storage cells, which are managed by the Library Manager, can contain any cartridge and are not restricted to storing only Magstar cartridges that are used by Virtual Tape Server subsystem

2.11.2 One IBM 3590-A14 Frame Must Be Installed

One IBM 3590-A14 frame is required for the Virtual Tape Server subsystem. It contains four IBM 3590-B1As plus the necessary SCSI cabling to connect the tape drives to the IBM 3495-B16. Other than with ESCON-attached IBM 3590 tape drives the BM 3590-A14 frame used by a Virtual Tape Server does not require an IBM 3590-A00 control unit to be ordered.

You must order the IBM 3590-B1As in addition to the IBM 3590-A14 frame. However, you do not need to specify SCSI cables for the tape drives.

2.11.3 Library Manager Attachment

The Magstar tape drives residing in the IBM 3495-D12 frame are not attached to any host system. The drives are managed by the Virtual Tape Server controller. None of the IBM 3495 Library Manage RS-422 control unit ports are used by the VTS subsystem. They are attached solely to the Library Manager through a LAN connection to provide the required communication path for library-related commands, and to the Virtual Tape Server controller IBM 3495-B16.

The Virtual Tape Server controller is connected to the Library Manager through a dedicated LAN connection to provide the required communication paths.

2.11.4 IBM 3495-B16 and IBM 3590-A14 Must Be Installed Side by Side

The IBM 3495-B16 and the IBM 3590-A14 must be installed adjacent to one another. You cannot separate the two frames.

2.11.5 Reduction of IBM 3495 Storage Cells when a VTS is Installed

When a VTS is installed in an IBM 3495, the total amount of storage cells in the library may be decreased. If it is placed in a location where a 3490 subsystem already existed, the cell count is not affected. If the VTS is installed on an IBM 3495 Model L30, L40 or L50 in a position where no IBM 3490 string existed, then the cell count will drop by 520 tapes (two IBM 3495 storage racks, no reduction in the frame adjacent to the B16 frame).

2.11.6 A Modem Must Be Supplied for The IBM 3495-B16

It is mandatory that you supply a modem for installation, operation, and remote support service of the IBM 3495-B16. The same modems as for the IBM 3591-A01, and 3590-A00 Remote Support Facility (RSF) are supported. You can obtain a list of these modems from your IBM representative.

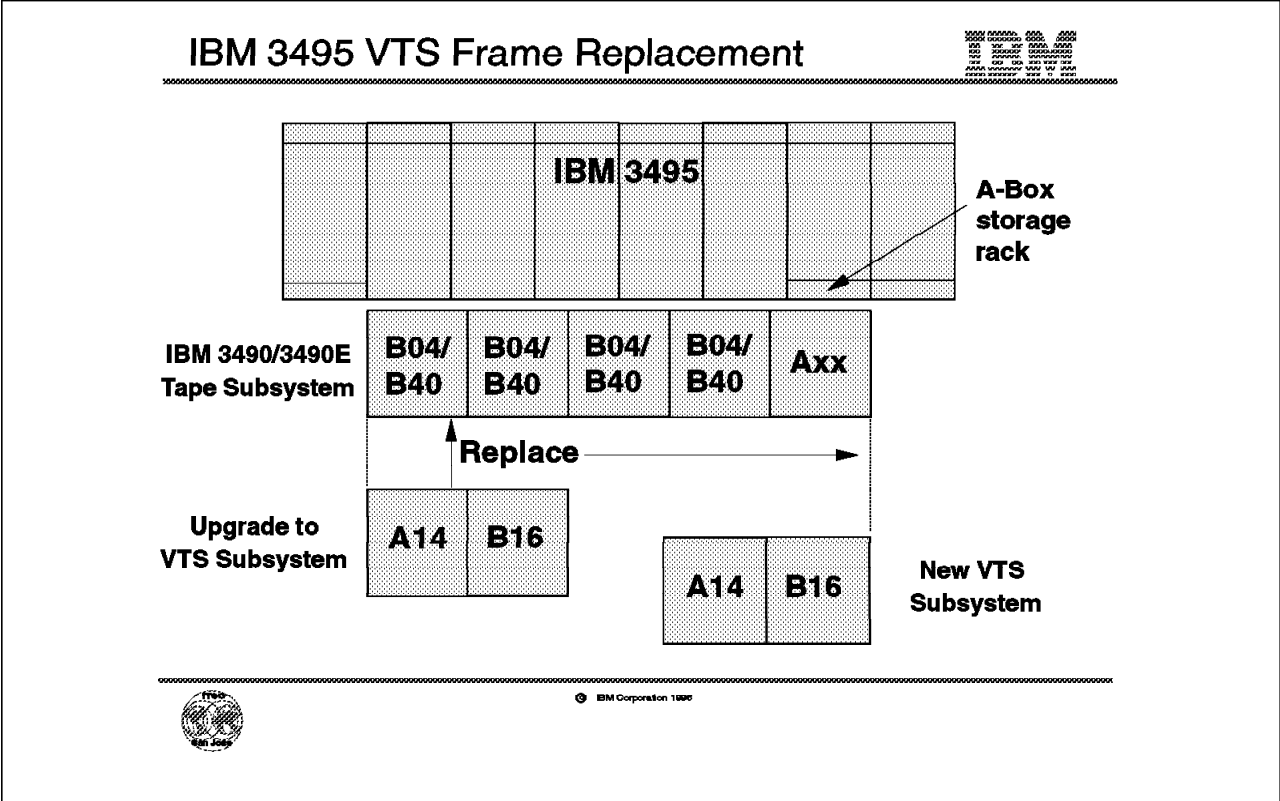

Figure 22. IBM 3495 Virtual Tape Server Frame Placement

2.12 IBM 3495 Virtual Tape Server Frame Placement

Each VTS subsystem is integrated into an IBM 3495 library through the installation of an IBM 3495-B16 and an adjacent IBM 3590-A14 frame. The IBM 3590-A14 frame must be installed to the left of the IBM 3495-B16 frame (when viewed from the front of the library) and must have no other frame between it and the IBM 3495-B16.

The two frames can be located along the library aisle wherever IBM 3490 or 3590 tape subsystems can be installed. Figure 22 shows where the A14/B16 frames can be installed relative to where the IBM 3490 frames are installed. If the VTS is being installed and replaces part of an existing IBM 3490 subsystem, it is installed to the left of the remaining IBM 3490 frames. If the VTS is replacing the entire IBM 3490 tape subsystem or is being installed where there was no previous IBM 3490 tape subsystem, the rightmost edge of the IBM 3495-B16 frame is placed on the IBM 3495 frame boundary. This similar to IBM 3490-Axx frame placement rules.

If a VTS replaces an existing IBM 3490 tape subsystem, the existing “A” box cartridge rack is left in place, even though there is no front service access requirement for the IBM 3495-B16 frame. It is suggested that a filler cover be installed in the hole in this frame.

The maximum number of VTS subsystems per physical IBM 3495 library is four. At the initial GA of VTS on the IBM 3495, only one VTS is supported per IBM 3495.

The VTS subsystem controller uses the LAN attachment method to communicate with the Library Manager. This leaves all existing eight control-unit attachment ports (RS422) into the LM available to connect to IBM 3490 subsystems and IBM 3590-A00 attached IBM 3590 tape subsystems.

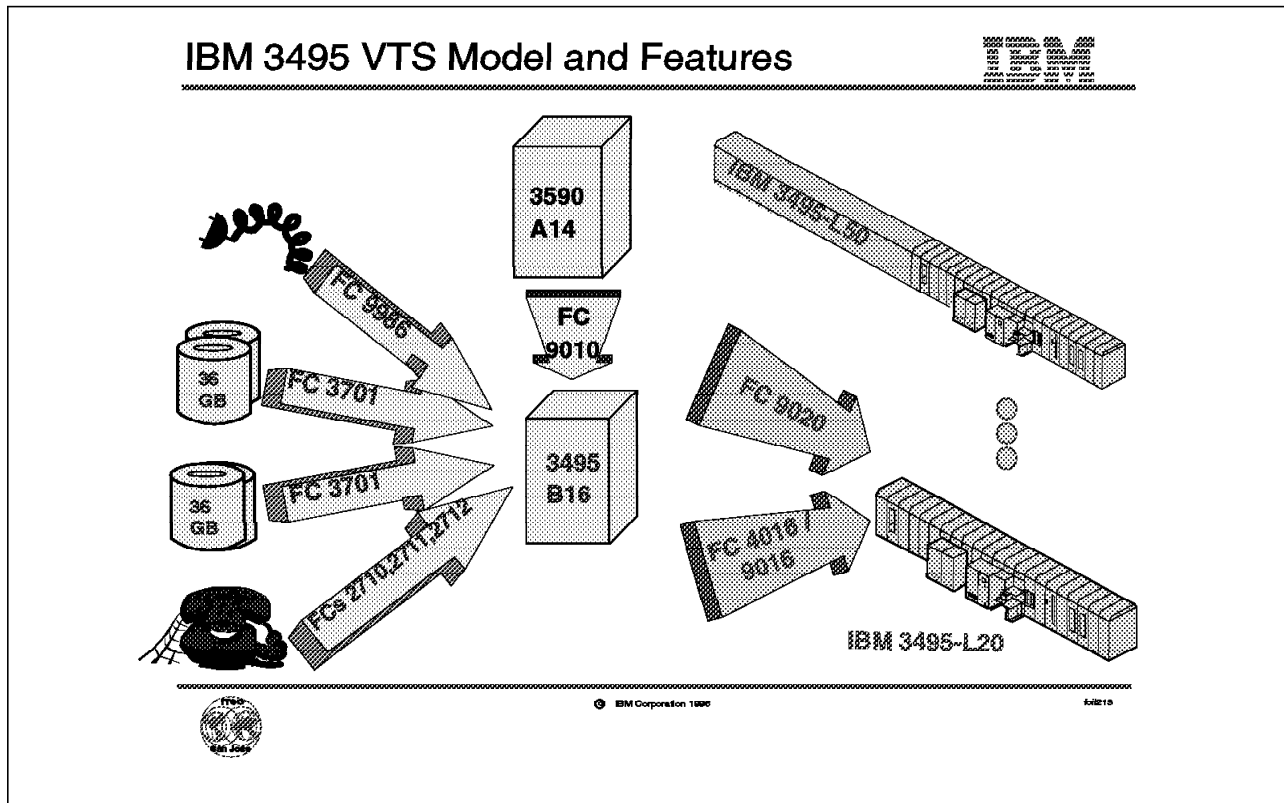

Figure 23. IBM 3495 Virtual Tape Server Models and Features

2.13 IBM 3495 Virtual Tape Server Models and Features

For integration of an IBM Magstar Virtual Tape Server into an existing IBM 3495, or for factory installation, you must order the features using the codes listed below.

To install an IBM 3495 plus IBM Magstar Virtual Tape Server, you must order the new features in addition to existing features and products. For instance, the IBM 3590-B1As that are installed inside the IBM 3590-A14 frame must be ordered separately. We list only the additional features that are required to include the Virtual Tape Server in the IBM 3495.

2.13.1 IBM 3590 Model A14 Plus Feature 9010

Feature 9010 for the IBM 3590-A14 frame indicates, that the IBM 3590 tape drives in it are to be used by a Virtual Tape Server subsystem. For additional information on ordering the IBM 3590-A14 frame, please refer to Chapter 3, “IBM Magstar 3590 in the S/390 Environment” on page 83.

2.13.2 IBM 3495 Model B16 Feature Codes

Feature 9986 is required to provide a special line cord for Chicago, Illinois, U.S.A.

Feature 3701 provides the DASD storage for the tape volume cache. Each feature provides you with 36 GB of usable tape volume cache. Currently, you can order either one or two Features 3701.

In addition to the modem you must supply for installation, operation, and remote support service of the IBM 3495-B16, you must install one of the following features:

- 2710** Remote Support Facility
- 2711** Remote Support Switch
- 2712** Remote Support Attachment

For detailed information on the features and their codes, please refer to Section 2.9, "New IBM 3494 Features, Their Codes and Model Upgrades" on page 39.

2.13.3 Feature Codes For IBM 3495 Model L20, L30, L40 and L50

When a Virtual Tape Server is installed in an IBM 3495, Feature 9020 must be specified for the tape library. This feature provides the hardware and microcode for the Library Manager to VTS controller communication path.

For a plant-installed IBM 3495-B16, you must order Feature 9016; for field installation, order Feature 4016.

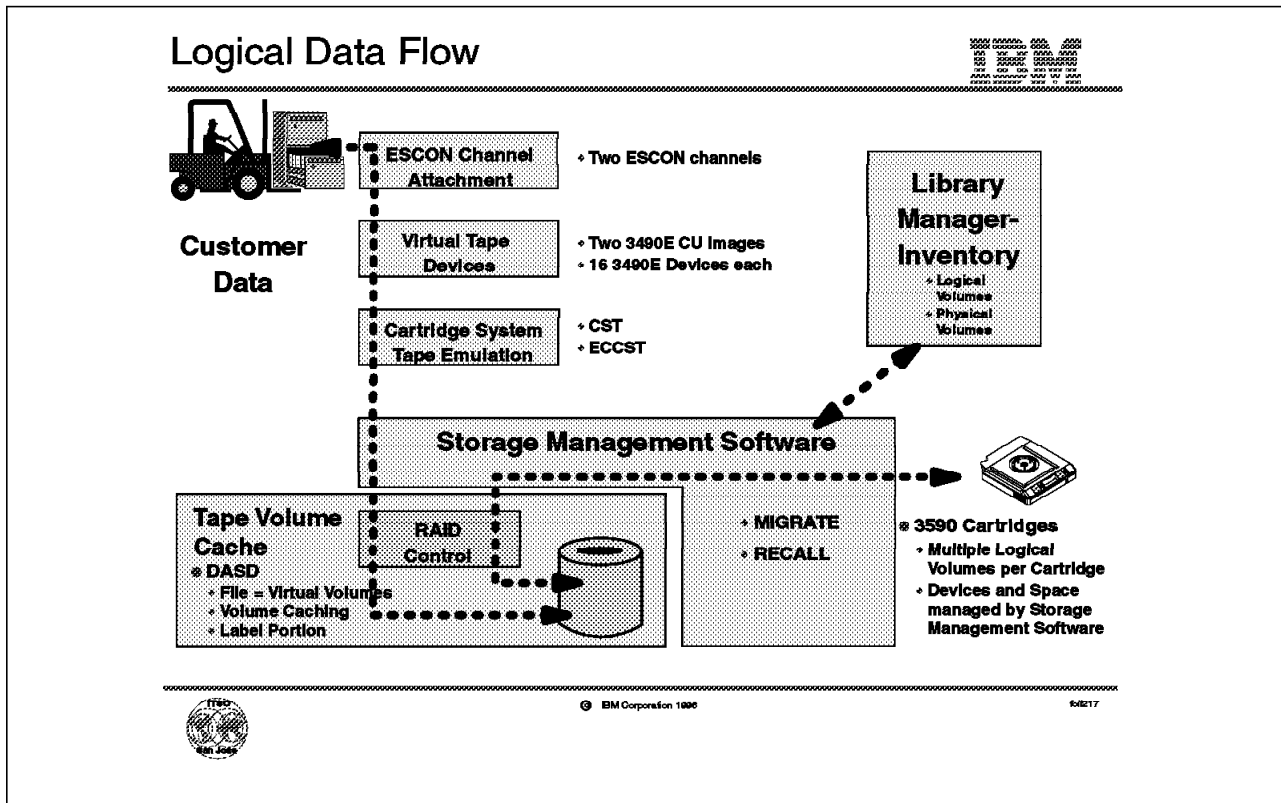

Figure 25. Logical Data Flow

2.15 Logical Data Flow

Figure 25 shows the logical data flow through an IBM Magstar Virtual Tape Server subsystem.

The host system has knowledge about the following components and interfaces that allow it to write data onto tape:

ESCON channel attachment: The host knows that there are two ESCON channels to the (virtual) 3490E tape drives. Either ESCON channel can access all virtual tape drives.

Virtual tape devices: The host sees two IBM 3490E control unit images, each of them fully configured with 16 tape drives for a total of 32 virtual 3490E tape drives.

Cartridge system tape emulation: The host can use virtual CST or ECCST media to store its data.

Library Manager: Through the Library Manager, the host is informed about logical volumes available in the IBM 3494 or 3495 tape library, their status, and status changes as well as about the status of the virtual devices.

The physical storage and management of the data written by the host is invisible to the host and its applications.

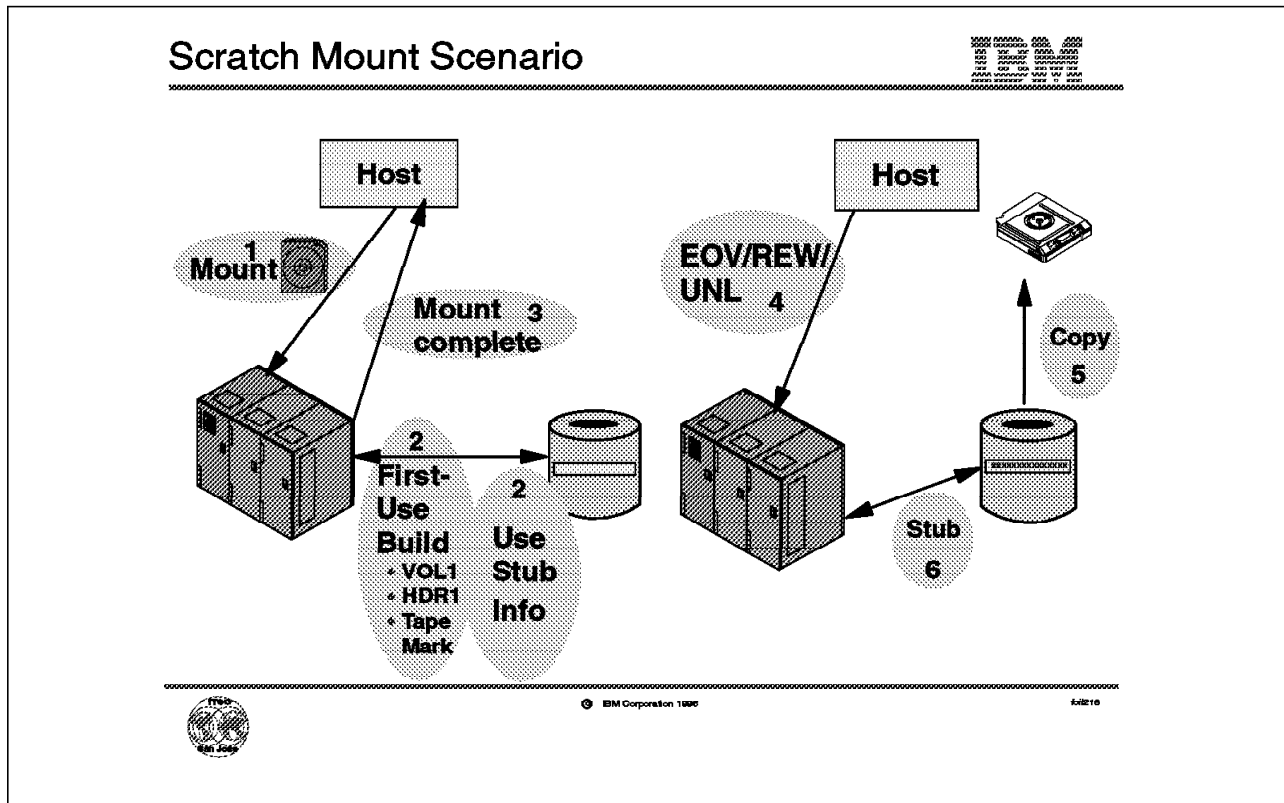

Figure 26. Scratch Mount Scenario

2.16 Scratch Mount Scenario

The Virtual Tape Server has special facilities for handling scratch (nonspecific) type mount. With the following facilities, the Virtual Tape Server processes scratch-mount requests in a fast and efficient manner.

- Virtual Volume Use Information.

After the first usage of a volume serial number as a virtual volume, information about that usage is maintained in the Tape Volume Cache even though most of the volume's data has been moved onto a Magstar cartridge into a logical volume. This portion of the data from the last usage of the volume is called the stub and includes the first several hundred bytes of data written during the last use of the volume. The information includes at least the data records that include a tape label.

- Automatic Initialization of a virtual volume on its first use.

Prior to the first use of a volume serial number as a virtual volume, the Tape Volume Cache will not have any information about the previous use of the volume. When the volume is mounted for the first time, the Storage Management Software will generate a set of records for the volume in the Tape Volume Cache as if the volume had been initialized using EDGINERS or IEHINITT specifying an IBM standard label, that is the volume will contain a VOL1, HDR1 and Tape Mark.

- Outboard Management of Volume Pools (Categories).

The IBM Tape Libraries, along with host software, provide a facility to have the Library Manager manage groups of volumes in pools. The pools are

called Categories and the host can assign one or more volumes to a category and later ask for a mount of a volume from the category. The Library Manager, on receiving a mount from category request, will select a volume from the specified category and make it ready on a tape device. As part of the operation to make the volume ready on a tape device, the Library Manager passes the volume serial number of the volume mounted back to the host software. Through the use of categories, the Library Manager can maintain a set of volumes that can be used for scratch mounts. Depending on the host software support at least two categories are used for scratch mounts, one for Media Type 1 - Standard Cartridge System Tape and one for Media Type 2 - Enhanced Capacity Cartridge System Tape.

- Fast-Ready Attribute for Categories

With the introduction of the Virtual Tape Server, an attribute can be assigned to a category that allows the Storage Management Software in the Virtual Tape Server to know that it can use the last usage information maintained in the Tape Volume Cache to process a nonspecific mount instead of having to recall the complete logical volume for the selected volume from a Magstar cartridge. The attribute for a specific category is set by the operator through a panel on the Library manager.

- Logical Volume Data Invalidation

Like a physical volume, the data that resides in a logical volume is accessible until two things happen. First, the Tape Management System determines that the data on the volume has expired and returns the volume to a scratch pool. Second, the volume is mounted in response to a scratch mount request and new data is written on the volume from the beginning of tape. The Storage Management Software in the Virtual Tape Server maintains a database to where the current accessible version of a logical volume is located on the IBM 3590 tape cartridges that it manages. This is done independent of whether the Tape Management System has returned the volume to a scratch pool or not. It is only when the volume serial number of the logical volume is reused as a virtual volume and modified, either from the beginning of tape or in an append operation, that the old location of the logical volume is deleted and the space it represents marked as invalid. When the new version of the logical volume is migrated to a Magstar cartridge, it will be in a different location on a different cartridge.

A nonspecific mount request for the first time a volume serial number is used is processed with the following steps:

1. The host sends a mount request for a scratch cartridge by specifying the category that contains either CST or ECCST volumes. The categories have the Fast-Ready attribute set. The Library Manager selects a logical volume serial number to satisfy the mount request.
2. The Storage Management Software in the Virtual Tape Server checks whether the selected volume has prior usage information in the Tape Volume Cache. Since this is the first usage of the volume, there will not be any information. The Storage Management Software will create that information including the data records for a VOL1, HDR1 and tape mark.
3. Mount complete is signaled to the host which then can write data to the virtual volume. Since there was no physical mount of a volume required, the nonspecific mount request is handled much faster than in a conventional tape library.

4. When the host closes the volume, End-of-Volume (EOV) processing is performed, and the volume is rewound and unloaded.
5. After the volume is unloaded, the virtual volume is scheduled to be copied onto a physical IBM 3590 cartridge.
6. After it is copied, the virtual volume remains in the Tape Volume Cache until the space it occupies is needed for other virtual volumes. When a virtual volume's space is needed, most of the volume's data is deleted, leaving a small portion stub of the volume's data. That stub has enough space to include the VOL1, HDR1 and HDR2 records, URL1 through URL8 records if present and a tape mark. Selection of when a virtual volume is stubbed in the Tape Volume Cache is through a Least Recently Used (LRU) algorithm.

After the host has expired the data on the logical volume, it becomes a scratch volume again and can be selected by the Library Manager in response to a mount request for a scratch volume.

A nonspecific mount request for a subsequent use of a volume serial number is processed with the following steps:

1. The host sends a mount request for a scratch cartridge by specifying the category that contains either CST or ECCST volumes. The categories have the Fast-Ready attribute set. The Library Manager selects a logical volume serial number to satisfy the mount request.
2. The Storage Management Software in the Virtual Tape Server will find that the selected volume has prior usage information in the Tape Volume Cache. This information contains all of the data records that the host Tape Management Software needs to validate the usage of the volume for a nonspecific mount request.
3. Since the volume was selected from a category that had the Fast-Ready attribute set, the Storage Management Software signals the host that the mount is complete without having to recall all of the data from the last usage of the volume from a physical cartridge. This results in a very low mount-response time since no physical movement or mounting of a cartridge is involved.
4. Same as in the first usage of a volume serial number.
5. After the volume is unloaded, the virtual volume is scheduled to be copied onto a physical 3590 tape cartridge. It is at this point that the last version of the data associated with the volume serial number is invalidated.
6. Same as in the first usage of a volume serial number.

Specific Mount Scenario

• Volume in TVC

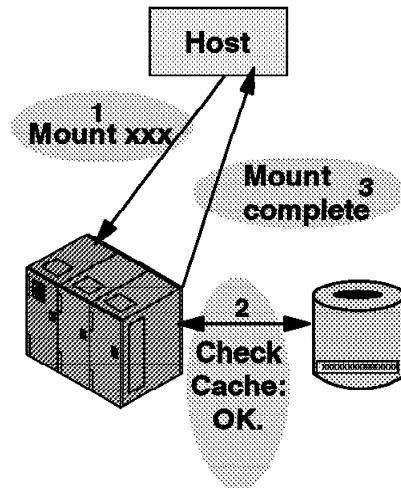

• Volume not in TVC

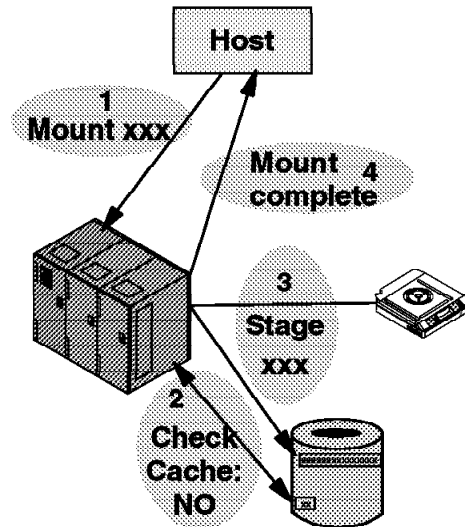

© IBM Corporation 1996

52716

Figure 27. Specific Mount Scenario

2.17 Specific Mount Scenario

When the host requests a specific logical volume, and the virtual volume exists in the tape volume cache, no physical mount is required to access this volume. If the tape volume cache contains only the usage information stub, the logical volume has to be staged to the tape volume cache first and become a virtual volume before the host can process it.

2.17.1 Volume in Tape Volume Cache

In case the virtual volume resides in the tape volume cache, the host can process the volume almost immediately, allowing very fast mount-response times.

2.17.2 Volume not in Tape Volume Cache

If the logical volume resides only on tape, it must be staged to the tape volume cache first. This involves a physical mount, positioning the tape and copying the logical volume to the tape volume cache. Mount complete is signaled to the host system only after the complete volume is available in the tape volume cache.

Space Reclamation

0000 000000 000 000
00 00 00 0000 0000
00 00000 00000000
00 00 00 000000
00000000 000 000
00000000 000 000



- **Tape Volume Cache**
 - ◆ **Disk space reconciliation every 18 - 24 hours**
 - ◆ **Premigrate**
 - Depending on Magstar tape drive occupancy
 - Delay 20-60 minutes



- **Stacked Magstar Cartridges**
 - ◆ **Automatic process**
 - Select tape with high amount of unusable space
 - Move all logical volumes
 - Return reclaimed volume to stacked scratch pool
 - ◆ **Inhibit space reclamation**
 - Through the Library Manager console
 - During certain periods of time
 - Ignored if scratch threshold is hit



© IBM Corporation 1999

5/12/99

Figure 28. Space Reclamation

2.18 Space Reclamation

In the IBM Magstar Virtual Tape Server, two levels of physical storage are managed automatically: the tape volume cache to free up DASD space, and the Magstar cartridges to free up tape space.

2.18.1 Tape Volume Cache

The tape volume cache is under complete and exclusive control of the Virtual Tape Server subsystem. There are no external interfaces to influence the management of the tape volume cache.

Disk space reconciliation for the tape volume cache is performed about once per day, which is every 18 to 24 hours depending on the Virtual Tape Server subsystem's workload and on occupancy of the Magstar tape drives.

Copying of a virtual volume onto a Magstar Cartridge is scheduled after the volume is rewound and unloaded. It is very likely that the virtual volume is copied during the following 20 to 60 minutes.

Once a virtual volume has been copied onto a Magstar cartridge, it becomes a candidate for being reduced to its usage information stub to make space available in the Tape Volume Cache space for other virtual mount requests. Candidates for reduction are managed with a Least Recently Used (LRU) algorithm meaning that, when space is needed, volumes that have been in the Tape Volume Cache the longest without being accessed are reduced until

enough space is freed up. Access includes when a virtual volume is read from as well as when written to.

2.18.2 Stacked Magstar Cartridges

When the data associated with a specific volume expires through the policies of the tape management system, the volume is returned to scratch. As part of the expiration process, DFSMSrmm (removable media manager) for example automatically notifies the Library Manager about the status change of the volume.

2.18.2.1 Logical Volume Space Use

With a Virtual Tape Server subsystem, the volume is a logical volume and resides on a stacked Magstar cartridge along with other logical volumes. When a logical volume is returned to a scratch pool, it becomes eligible to satisfy a nonspecific mount request. When the volume is next selected and written to, the space associated with the previous use of the logical volume on the Magstar cartridge becomes unusable, meaning it no longer contains valid active data and cannot be accessed or used.

Returning a volume to a scratch pool is not the only way space on a stacked Magstar cartridge becomes unusable. Any time a volume is modified, the space occupied by the previous use of the volume becomes unusable.

The reason the space becomes unusable is twofold.

1. As with other prior tape technology, the Magstar tape drive does not support writing data between two areas of valid data. The reason for this is that the valid data in the area directly after the newly written data may be partially overlaid.
2. The next time the logical volume is used, it may contain a greater number of bytes and would not fit on the tape.

Over a period of time, the amount of unusable space on a Magstar cartridge will grow until it becomes a large percentage of the total space of the cartridge. The reclamation of that unusable space, converting it to usable space, is part of the management responsibilities of the Virtual Tape Server.

2.18.2.2 Automatic process

Space management of the stacked 3590 cartridges is performed automatically without any external direction. The storage management software in the Virtual Tape Server monitors the utilized space on the 3590 cartridges that it manages and determines when a cartridge is a candidate to have its unusable space reclaimed. The reclamation process requires a portion of the resources of a Virtual Tape Server subsystem and as such can impact host usage of the subsystem. To minimize any impact, the storage management software in the Virtual Tape Server monitors how much of the subsystem resources are in use because of host processing and will normally perform reclamation processing in mostly idle periods.

In addition, you can specify through the Library Manager console during which time periods reclamation is normally not to be performed.

The above rules for when reclamation processing is performed are dependent on a threshold number of available scratch stacked 3590 cartridges. The dependencies are:

- There are fewer than 50 scratch stacked 3590 cartridges

If the number of available scratch stacked 3590 cartridges falls below 50, reclamation processing will be performed until it is again above 50 except for the time periods set through the Library Manager console. Host usage of the subsystems resources is ignored and may be impacted.

- There are fewer than 10 scratch stacked 3590 cartridges

If the number of available scratch stacked 3590 cartridges falls below 10, reclamation processing will be performed until it is again above 10. Host usage of the subsystems resources and any time period limits set through the Library Manager console are ignored.

Reclamation of unusable space involves the following general steps:

1. Selecting tape with a high amount of unusable space
2. Move all of the valid logical volumes on the selected stacked 3590 cartridge to another 3590 cartridge, restacking them end to end. The end result is a contiguous space from the end of the last valid logical volume (which could be the beginning of the stacked volume) to the logical end of tape of the stacked Magstar cartridge.
3. Returning the now empty stacked 3590 cartridge to the stacked volume scratch pool.

Virtual to Physical Volume Comparison

- **Virtual volume**
 - ◆ **Uncompressed size**
 - ◆ **Emulated CST = 400 MB**
 - ◆ **Emulated ECCST = 800 MB**
- **Physical volume**
 - ◆ **Magstar 3590 cartridge**
 - ◆ **+30 GB**
 - ◆ **Compression while data is destaged**
- **Virtual volume advantages**
 - ◆ **Short mount response time**
 - ◆ **Fast tape-motion commands**
 - ◆ **Random access**
 - ◆ **Cache volume reaccess**

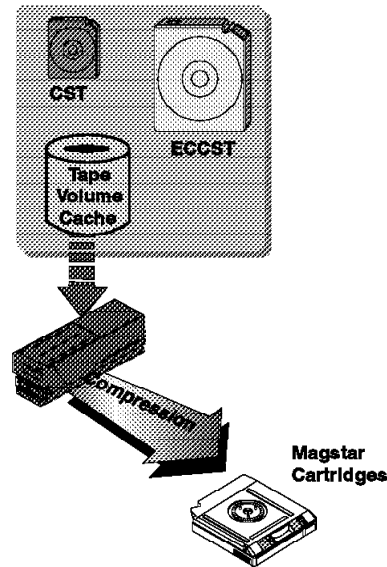

© IBM Corporation 1998

61821

Figure 29. Comparison of Virtual to Real Volumes.

2.19 Virtual to Real Volume Comparisons

In this section we compare the virtual volumes to real or physical volumes and list the advantages of the Virtual Tape Server implementation through 3490E emulation.

2.19.1 Virtual Volume

When the host application selects a tape, it can define whether it wants a media type of MEDIA1 or MEDIA2 to be used by using an appropriate data class. For example, if a volume residing in a Virtual Tape Server subsystem is selected, a virtual volume is created. A virtual volume is an emulated CST cartridge when MEDIA1 is selected, or ECCST when MEDIA2 is selected.

2.19.1.1 Uncompressed Size

The Virtual Tape Server controller does not have the hardware compression feature that allows a real 3490 device to store more data than the amount specified below on a single logical volume.

This might result in more multivolume files when migrating from real to emulated 3490E cartridges.

2.19.1.2 CST = 400 MB

The emulated CST cartridge stores up to 400 MB. This is different from a real CST cartridge, which can hold more than 400 MB because of the effects of IDRC. Assuming an average IDRC ratio of 1:3, a real CST cartridge can hold up to 1.2 GB of data.

Applications that attempt to directly copy a real CST cartridge onto an emulated CST cartridge will fail if more than 400 MB are on the real cartridge and the application cannot handle the change to a multivolume file. DFSMSHsm is an example of such an application. A copy of an emulated CST cartridge to a real cartridge, however, will always fit.

2.19.1.3 ECCST = 800 MB

The emulated ECCST cartridge stores up to 800 MB. This is different from a real ECCST cartridge, which can hold more than 800 MB because of the effects of IDRC. Assuming an average IDRC ratio of 1:3, a real ECCST cartridge can hold up to 2.4 GB of data.

Applications that attempt to directly copy a real CST cartridge onto an emulated CST cartridge will fail if more than 400 MB are on the real cartridge. A copy of an emulated CST cartridge to a real cartridge, however, will always fit.

2.19.2 Physical Volume

The physical volumes used in a Virtual Tape Server subsystem to store logical volumes are 3590 cartridges which provide a capacity of 10 GB if the data is not compressed. Because of a compression algorithm that is improved over the IDRC function of IBM 3490E devices, an IBM 3590 cartridge can store over 30 GB data.

The compression takes place in the IBM 3590 tape drive at the time the data is copied from the Tape Volume Cache to 3590 cartridges.

Assuming a compression ratio of 3:1, a single 3590 cartridge can physically store up to 75 emulated CST cartridges or up to 37 emulated ECCST cartridges, although the application cannot handle the change to a multivolume file. DFSMSHsm is an example of such an application.

2.19.3 Virtual Volume Advantages

A virtual volume is physically stored on DASD and therefore has some advantages over traditional tape processing.

2.19.3.1 Mount response time

The mount response time for a scratch mount request is a fraction of the time required on a physical volume because it is not dependent on the physical movement of a cartridge or the loading and threading delays of a physical tape.

The mount response time for a specific mount request, where the volume is in the tape volume cache, is a fraction of the time required on a physical volume because of the same reasons as above.

2.19.3.2 Fast tape motion commands

Tape positioning command such as Locate, Space or Rewind, for example, are performed in a fraction of the time required for a physical volume.

A Rewind/Unload command is performed in a fraction of time because it is not dependent on the delays of tape movement on a physical tape device.

2.19.3.3 Random access

You can randomly access tape data through the use of the available tape commands Read Block ID and Locate Block ID

2.19.3.4 Cache Volume reaccess

In many cases, data that is written to a tape volume from one job or job step is read by a subsequent job or job step. The time between creation and reaccess is variable. However, very often the reaccess occurs within the next few hours.

The tape volume cache is large enough to hold virtual volumes for several hours after they have been copied to stacked 3590 cartridges. The duration of this period is dependent upon the tape volume cache size and amount of data written by the host per hour.

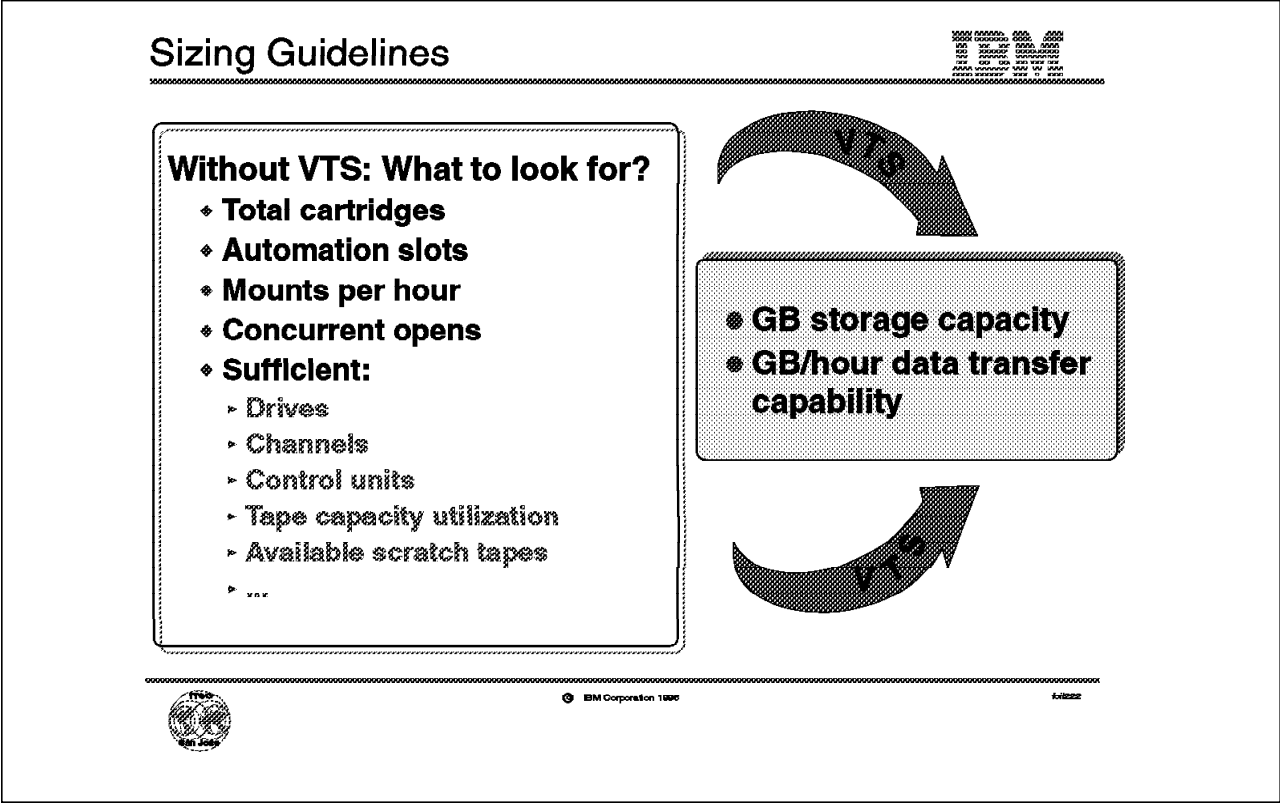

Figure 30. Sizing Guidelines

2.20 Sizing Guidelines

Today, to size an automated tape library and the tape drives included in it, you need to consider the number of:

- Total cartridges
- Automation slots
- Mounts per hour
- Concurrent opens
- Sufficient drives
- Sufficient channels
- Sufficient control units
- Sufficient tape capacity utilization
- Sufficient available scratch tapes

With the Virtual Tape Server, you need only to consider:

- How many gigabytes of tape data do I need to store?

For a single Virtual Tape Server subsystem, you can define up to 50,000 virtual volumes. If you define these volumes as ECCST, you can store up to 40 terabytes of data in a single Virtual Tape Server subsystem.

To calculate the physical number of Magstar cartridges required to store this data, a conservative approach would be to assume

- Compression ratio of 2:1
- 50% of the physical cartridges contain active data

This would allow an average of 10 GB per Magstar tape drive. Divide the required number of gigabytes of tape data by 10 to calculate the number of physical Magstar cartridges for your Virtual Tape Server.

- How much data will I need to transfer per hour?

We assume that the Virtual Tape Server capability is a throughput of 10 MB/s for a Virtual Tape Server subsystem, which equals an hourly throughput of 36 GB. Dividing your required hourly throughput by 36 will give you the number of Virtual Tape Server subsystems required for your environment.

information on the number of cartridges that are currently used, number of tape drives allocated in parallel, and gigabytes per hour written to tape.

- Quick and easy tape investigation and simulation (QUIETIS)

QUIETIS is an IBM internal analysis tool that provides information on your tape environment based on the information contained in the catalog of your tape management system on MVS. Currently, the following tape management systems are supported:

- DFSMSrmm
- EPIC/MVS
- TLMS
- CA-1

Please contact your technical IBM representative for further information.

- Tape Data Set Analysis (TDSA)

TDSA is an IBM internal tool specially developed for configuration of the IBM Magstar Virtual Tape Server. TDSA analyzes your tape environment based on VMA data and parameter input, and proposes the number of Virtual Tape Server subsystems, the IBM 3590 tape drives, and the library configuration of a Virtual Tape Server configuration that will meet your requirements today and in the future.

For analysis and for further information, please contact your technical IBM representative.

- DASD and Tape Magic for OS/2

DASD and Tape Magic for OS/2 make up a tool for IBM marketing use which helps in configuring IBM tape libraries. For details, please refer to your technical IBM representative.

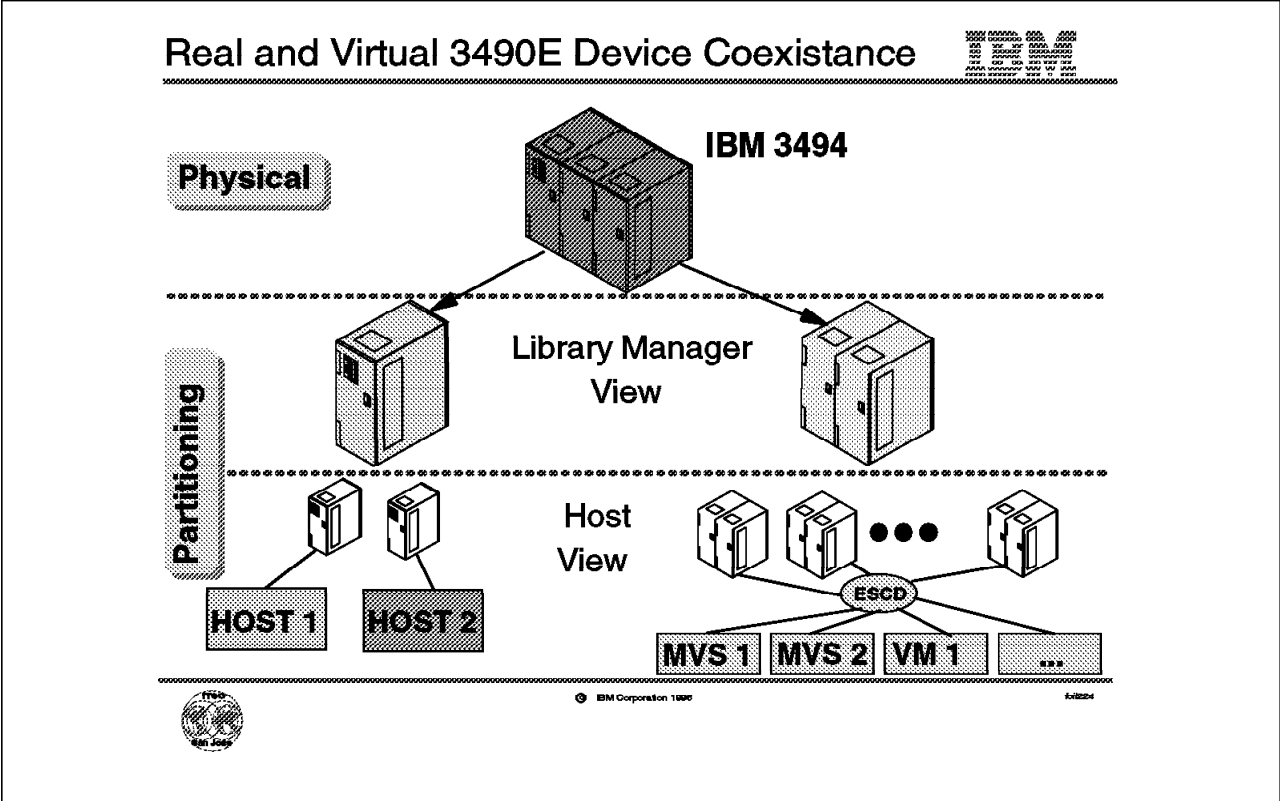

Figure 32. Real and Virtual 3490E Device Coexistence

2.22 Real and Virtual 3490E Device Coexistence

To support the coexistence of both real and virtual 3490E type devices in the same physical library, the library is logically partitioned.

Figure 32 shows the physical and logical implementation of an IBM Magstar Virtual Tape Server.

2.22.1 Physical Installation

A Virtual Tape Server subsystem must be installed in an IBM 3494 or 3495 tape library because the physical assets used by the Virtual Tape Server subsystem are managed by the Library Manager in the library. The physical assets include the Magstar tape drives and the Magstar cartridges used for stacking logical volumes.

2.22.2 Library Manager View

The Library Manager provides the support for logical partitioning of an IBM 3494 or 3495 tape library. To support the Virtual Tape Server’s capability to coexist with current native IBM 3490, 3490E, and 3590 tape devices in the same library, the Library Manager partitions the physical library into logical libraries. This must be done because the Virtual Tape Server presents an image of 3490E tape devices, and yet cannot read or write a real CST or ECCST type cartridge. By placing a Virtual Tape Server subsystem in its own logical library, the possibility of host software allocating a virtual 3490E tape device for a real 3490 mount is removed. This also removes the possibility that host software could allocate a real 3490 mount instead of a virtual 3490E tape device.

A logical library can contain either a Virtual Tape Server subsystem, or current IBM 3490/3490E with or without native IBM 3590 tape subsystems. Given general availability of the IBM Magstar Virtual Tape Server, each physical IBM 3494 or 3495 tape library can be partitioned into two logical libraries:

- One contains one Virtual Tape Server subsystem
- The other contains all real IBM 3490 and all native IBM 3590 subsystems.

2.22.3 Host View

Each logical library has its own library sequence number used in defining the logical library to the host and therefore looks like a separate physical library to the hosts attached to that partition.

A single logical Virtual Tape Server library, can be shared by multiple MVS, VM, and VSE guest systems in the same way that a physical library can be shared.

For details on sharing or partitioning a logical library, please refer to the *Guide to Sharing and Partitioning IBM Tape Library Dataserver*.

Virtual Tape Server Installation Tasks

- Physical installation and checkout
- Logical partitioning
- Teaching and inventory
- HCD required for library devices
 - ◆ Except BTLS
- Define the new library to the host
- Define volume serial (VOLSER) ranges
 - ◆ Logical volume
 - ◆ Physical volume
- Add Magstar cartridges
- Define fast-ready attribute
- Define inhibit reclamation schedule

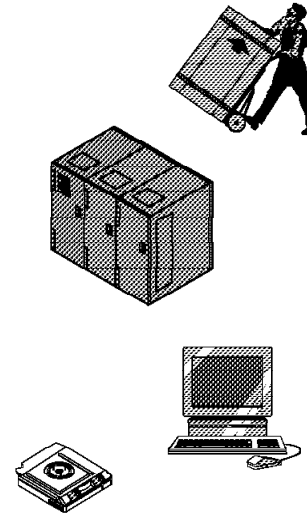

© IBM Corporation 1998

5/12/98

Figure 33. Virtual Tape Server Installation Tasks

2.23 Virtual Tape Server Installation Tasks

Figure 33 describes the tasks involved in installing an IBM Magstar Virtual Tape Server.

2.23.1 Physical Installation and Checkout

Hardware installation and checkout involves installing the hardware components of the Virtual Tape Server and performing the subsystem setup. At times during this phase, the library will either be unavailable to the host or degraded, because manual mode operation is required to satisfy host requests.

2.23.2 Logical Partitioning

Logical partitioning is performed by the hardware customer engineer as part of the physical installation of the Virtual Tape Server subsystem.

2.23.3 Teach and Inventory

Teaching the robotics the locations of the Magstar tape drives associated with the Virtual Tape Server and inventory of storage cells in the Virtual Tape Server frames is performed by the hardware customer engineer (CE) or customer service representative (CSR) as part of the Virtual Tape Server subsystem installation.

2.23.4 Hardware Configuration Definition (HCD) Required For Library Devices

Because the virtual tape drives of the Virtual Tape Server are library resident, you must define them through the hardware configuration definition dialogue specifying LIBRARY=YES. As for the VTS drives resident in the physical library, there is no definition in IOCP/MVSCP/HCPRIO.

For BTLS-managed libraries, HCD is not required, because BTLS does not require the LIBRARY=YES definition.

2.23.5 Define the New Library to the Host

For details on defining a new library to the host, please refer to Figure 34 on page 70.

2.23.6 Define Volume Serial Number Ranges

Although a physical library partitioned in the way described in Figure 32 on page 65 looks like two separate libraries to the host, they share the same library manager and its database. Because of this, the volume serial numbers of both the virtual and physical volumes in the same physical library must be unique.

Before you can insert physical 3590 cartridges for use by the Virtual Tape Server subsystem into a library, you must define them through the Library Manager console. You must also define a beginning set of volume serial ranges for your virtual volumes as well.

Volume serial numbers supported by the Virtual Tape Server must be six characters long and contain either an alphabetic or numeric character in any character position.

You add the volume serial number ranges through a Library Manager panel that contains two edit fields. If just one volume serial number is to be added, you enter the volume serial number in the first field and leave the second field empty. If a range of volume serial numbers is to be added, enter the two volume serial numbers that indicate the ends of the range in the two fields. You do not need to be concerned with which end to put in which field; the Library Manager will determine the range expansion regardless of whether the highest volume serial number is in field one or two.

Both volume serial numbers must have the same format. The same format means that if a character position in the first volume serial number is alphabetic, the corresponding character position in the second must be alphabetic as well. Likewise, if a character position in the first is numeric, the corresponding character position in the second one must also be numeric. For example, a range of ABC000 through ABD999 is valid, but ABC000 through ABCD99 is invalid.

To add multiple ranges, simply repeat the volume serial number entry process.

Volumes defined through the Library Manager console are processed as described below:

Logical

The Library Manager expands the specified volume serial number range, adds the resultant volumes to its inventory, places them in the insert category and notifies all attached hosts. The hosts can then

perform insert processing for these volumes as they would for physical cartridges in the library.

The range of volumes is expanded starting with the lower valued volume serial number (A is less than B, B is less than C, and so on). The volume serial number is incremented where alphabetic characters are incremented alphabetically and numeric characters are incremented numerically. For example, a volume serial number range specified as ABC000 and ABD999 would result in 2000 volumes being added (ABC000 - ABC999 and ABD000 - ABD999).

Physical If a 3590 cartridge is inserted into a library and fits into the volser range defined for physical volumes used by the Virtual Tape Server subsystem, the Library Manager does not notify any host. Management of these cartridges is under control of the Library Manager and the Virtual Tape Server subsystem. If you did not define the physical volumes for use by the Virtual Tape Server subsystem before entering them into the library, the Virtual Tape Server subsystem will not be able to use these cartridges.

You do not have to define all of the logical and physical ranges during installation. As needed, additional volume serial number ranges may be added later. You also do not have to have add all of the physical 3590 cartridges you defined at one time, they can be added as needed.

2.23.7 Add Magstar Cartridges

After you have defined the Magstar cartridges through the Library Manager console, you can insert them into the IBM 3494 or 3495 tape library.

2.23.8 Define Fast-Ready Categories

To take advantage of the scratch-mount performance advantages of the Virtual Tape Server, as described in Section 2.16, "Scratch Mount Scenario" on page 51, you need to indicate to the Library Manager the numbers of the categories used by the host for scratch volumes. You do this through the Library Manage console. The Library Manager provides a panel by which a 4-digit category number can entered. This will add the category to the list of categories in the library that have the Fast-Ready attribute set. To reset a category's Fast-Ready attribute, the Library Manager panel allows you to highlight one of the categories in the list with the Fast-Ready attribute set and then request that it be reset.

2.23.9 Define Reclamation Schedule

To minimize the effect of IBM Magstar Virtual Tape Server internal space reclamation on your tape operation, you can inhibit space reclamation for certain periods of time through the Library Manager console.

Implementing the Virtual Tape Server

IBM
Virtual
Tape
Server
and
Enhancements
to
Magstar

• MVS Environments

• DFSMS System-Managed Tape (SMT)

- Define new storage group with VTS library
- Storage group cannot include VTS and non-VTS libraries
- ACS routines direct allocations to the VTS

• BTLS

- Define esoteric unit name for virtual tape devices
- Use the esoteric unit name to allocate virtual tapes in VTS

• VM Environments

- Define new library and drives
- Define logical volser range for insert processing

• VSE Guests

- Define LIBCONFIG LIST
- Define LIBRCMS XREF
- Update TMS



© IBM Corporation 1996

51220

Figure 34. Implementing the Virtual Tape Server

2.24 Implementing the Virtual Tape Server

From software point of view, the Virtual Tape Server is same as the IBM Automated Tape Library Dataserver with IBM 3490E tape drives. We explain how to implement the Virtual Tape server in MVS/ESA, VM/ESA, and VSE/ESA environments.

2.24.1 MVS/ESA Environments

In general, the Virtual Tape Server subsystem must be defined as a new tape library, with IBM 3490E tape drives as the host system.

2.24.1.1 DFSMS System-Managed Tape (SMT)

To use the Virtual Tape Server subsystem under SMT, you must define the virtual 3490E devices through HCD specifying LIBRARY=YES.

During hardware installation of the Virtual Tape Server, the customer engineer assigns a five-character library sequence number to the VTS library. You use this sequence number to define a new library to SMS through the ISMF Library application.

To direct allocations to the Virtual Tape Server subsystem, you must define new storage groups that only contain VTS libraries. You cannot intermix VTS and non-VTS libraries in the same storage group. However, if you have more than one VTS library installed, you can define storage groups that span more than one VTS library.

You must change your ACS routines to assign these newly defined storage groups. If the storage group ACS routine assigns a storage group that contains a VTS library, the tape data set is directed to the Virtual Tape Server subsystem.

For details on the implementation in an SMS managed environment, please refer to the *DFSMS/MVS Version 1 Release 3 Object Access Method Planning, Installation, and Administration Guide for Tape Libraries*. For further information on sharing a VTS library, please refer to the *Guide to Sharing and Partitioning IBM Tape Library Dataserver*.

2.24.1.2 Basic Tape Library Support (BTLS)

If you implement the Virtual Tape Server subsystem under BTLS, you can define the tape drives through the Hardware Configuration Definition (HCD) dialogue, or you can use IOCP and MVSCP.

You need to define a new logical library to BTLS that contains all virtual devices associated with this logical library. If only BTLS is using the Virtual Tape Server subsystem, you define all 32 drives.

To direct tape allocations to the Virtual Tape Server, you define a new esoteric unit name and use it in the DD statement for the newly allocated tape data set.

Because of the library definitions, BTLS knows that the device allocated resides in a Virtual Tape Server library.

For BTLS implementation details, please refer to the *Basic Tape Library Support Version 1 Release 1 User's Guide and Reference*.

2.24.2 VM/ESA Environments

After you have defined the new library through HCD, you must define it to DFSMS/VM, if the VM system will directly use the Virtual Tape Server subsystem.

You define the VTS library through the DFSMS/VM DGTVCNTL DATA control file. You define the tape drives that are available through the RMCONFIG DATA configuration file.

To allow the removable media services (RMS) component of DFSMS/VM to perform automatic-insert bulk processing, you must create the RMBnnnnn DATA file in the VMSYS:DFSMS.CONTROL directory. The nnnnn matches up with the five-character library sequence number that is assigned to the Virtual Tape Server during hardware installation.

For details on the implementation of DFSMS/VM and RMS, please refer to the *VM/ESA DFSMS/VM Function Level 221 Removable Media Services User's Guide and Reference*. If the Virtual Tape Server subsystem is shared among your VM system and other systems, additional considerations apply. Please refer to the *Guide to Sharing and Partitioning IBM Tape Library Dataserver* for further information.

2.24.3 VSE/ESA Guests

VSE/ESA must run as a guest system under VM/ESA to use a VTS library. The VSE Guest Server (VGS) support must be installed as well as DFSMS/VM RMS for communication with the Library Manager of the VTS library.

You must define the LIBCONFIG file on the VGS service machine's A-disk. This file simply cross-references the VSE/ESA guest's library names with the names that DFSMS/VM uses.

To enable VSE/ESA guest exploitation of inventory support functions through the LIBSERV-VGS interface, the LIBRCMS part must be installed on the VM system. If VGS is to service inventory requests for multiple VSE/ESA guests, you must edit the LIBRCMS SRV NAMES cross-reference file. This file enables the inventory support server to access Librarian files on the correct VSE guest machine.

For further information, please refer to the *Guide to Sharing and Partitioning IBM Tape Library Dataserver*.

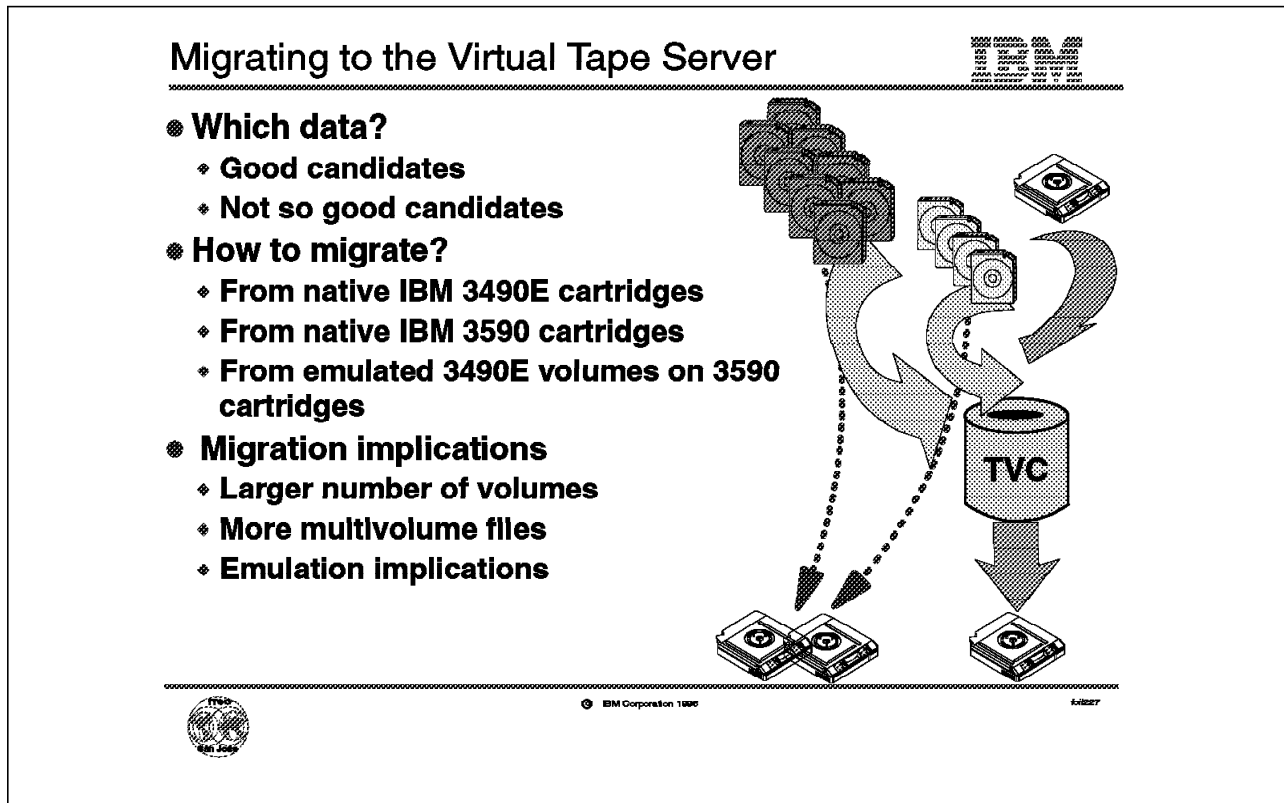

Figure 35. Migration to the IBM Magstar Virtual Tape Server

2.25 Migration to the IBM Magstar Virtual Tape Server

Although migrating to a Virtual Tape Server subsystem is transparent to the host, there are some considerations to be made because you are migrating from physical to logical volumes Figure 35. This is mainly because the physical and the logical volumes are of different size, owing to the fact that the Virtual Tape Server does not use hardware compaction.

2.25.1 Which Data?

In general, all tape data can be under control of a Virtual Tape Server subsystem. Especially if your tape processing is currently restricted by the number of tape drives, you may want to direct as much as possible to the Virtual Tape Server, utilizing the full 32 virtual tape drives.

Before migrating, you should however review the exceptions that you may want to leave on native tape cartridges. Exceptions could be:

- Data that must be removed from the Virtual Tape Server library.
Data in this category is usually interchange data or data that must be stored for some period of time in a remote vault. Such data should initially be directed to native tape or it must be copied from the Virtual Tape Server library to native tape.

- Data whose retrieval time from tape would increase too much.

Some data retrieval applications, involving extraction of just part of data residing on a volume, as for example for a DFSMSHsm recall, may

experience longer retrieval times if the volume is stacked and doesn't reside in the tape volume cache.

- Tape jobs whose nature makes native tape more cost effective.

Tape applications that already utilize both high tape bandwidth and capacity may be more effective if kept on native volumes. Such applications are not common, and are generally restricted to certain types of efforts, such as seismic data processing.

2.25.2 How to Migrate?

Migrating your tape data into a Virtual Tape Server subsystem can be done in two ways:

1. Copy your tape data.
2. Direct new allocations to the Virtual Tape Server and let the data outside the Virtual Tape Server expire.

The approach is the same no matter on which type of cartridge the tape data was stored before.

2.25.3 Migration from Physical IBM 3490E

There are some implications if you are migrating from native 3490E volumes to emulated 3490E volumes. Because the Virtual Tape Server subsystem does not have hardware compression, an emulated 3490E cartridge will either store 400 MB or 800 MB of tape data. If you are currently utilizing the full capacity of a CST or ECCST type cartridge, migrating to emulated 3490E will result in more multivolume files and thus in a larger number of volumes to be managed by your tape management system and the system catalog.

Reading data for a large data set could result in more tape mounts than before. Since some large data sets that once occupied just one physical volume will now occupy two or more logical volumes, there is a potential for more tape mounts to recall all of the logical volumes. However, extra tape mounts will not occur if the stacked cartridge is still in the drive when subsequent logical volumes are referenced. Please note that spreading the data over several logical volumes will not increase the number of physical scratch mounts. Analyses so far have shown that the increase in mounts resulting from multiple logical mounts is more than compensated for by the decrease in mounts due to scratch and read cache hits.

Data copied out of a Virtual Tape Server subsystem can occupy more native tapes than if the data were written initially on native drives. The DFSMSHsm TAPECOPY command, for example, may increase the number of cartridges that have to be trucked to offsite vaults or sent back to users.

There are some differences between the Virtual Tape Server subsystem's emulation of a 3490E device, and a real 3490E device, in addition to those described for the size of the logical and physical volumes. The differences are:

- Dynamic Device Reconfiguration (DDR)

DDR is an error recovery operation that is performed by the host to retry a failed operation on another physical tape device when an unrecoverable error has occurred. With virtual drives, there are no unrecoverable errors that could be resolved by swapping to a different drive. Therefore, error

codes that would indicate DDR are not reported; instead, ERA 35, Drive Equipment Check is reported.

- Read Buffer command

The Read Buffer command always returns zero bytes of data.

- Erase Gap command

The execution of the Erase Gap command does not cause an actual gap on the virtual device.

- Data Security Erase Command

The execution of the Data Security Erase command does not cause random data patterns to be written on a virtual volume to its virtual end-of-tape. Instead, the End-of-Data (EOD) mark is repositioned at the logical block location at which the command was issued. Any data beyond that logical block location is no longer accessible.

When the virtual volume is copied to a Magstar cartridge, only the data up to the EOD mark is written. Any data beyond this point is no longer accessible by the host.

- Reading or Positioning beyond EOD

The boundaries of a virtual volume are limited by the BOT and EOD mark location. Any attempt to read or position beyond the EOD mark fails, indicating ERA 36, End-of-Data.

- Load Display Command

The execution of the Load Display command is accepted and returns with an error-free ending status, but the information contained in the command is discarded.

- Block IDs

The format of the 4-byte field of a block ID is identical to that for a real 3490E device, except that the tape direction, segment, and format mode information contained in Bits 0-9 is set to B'0'.

The Virtual Tape Server subsystem maintains two block IDs for each virtual tape device:

Channel Block ID The channel block ID maintains the current tape position from the host program's perspective and reflects the tape positioning resulting from the last tape motion command issued by the host. The block ID identifies the next logical block to be accessed in the forward direction.

Device Block ID When performing write operations, the device block ID identifies the last logical block that was implicitly or explicitly synchronized to the physical DASD of the tape volume cache. For read operations, the device block ID is the same as the channel block ID.

- The subsystem always reports that it is achieving a 1:1 compaction ratio.

Monitoring the IBM Magstar VTS

IBM Corporation 1988

• Event Logging

- ◆ Accumulated and written to a virtual volume once a day
- ◆ Accessible by the host
- ◆ Three types of log records
 - Control Unit Initialization
 - Virtual Volume Event
 - Library Manager Hourly Statistics

• Library Reporting

- ◆ Operational statistics for a Virtual Tape Server
- ◆ SMF Record Type 94
 - Virtual mount statistics
 - VTS operational information
 - Physical library statistics
- ◆ Library Manager
 - Library statistics

Virtual Volume Events

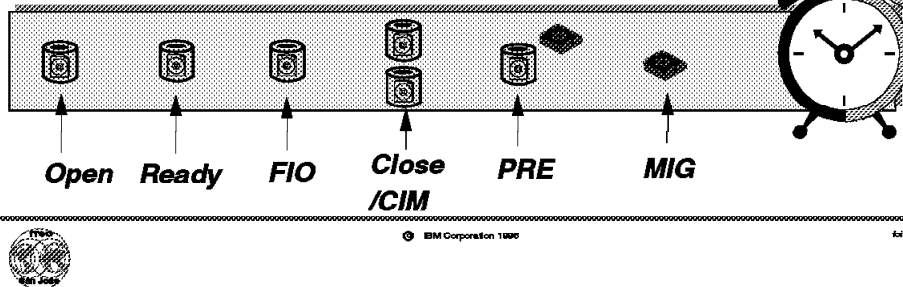

Figure 36. Monitoring the IBM Magstar Virtual Tape Server

2.26 Monitoring the IBM Magstar Virtual Tape Server

Figure 36 shows the monitoring provided by the Virtual Tape Server. Once a Virtual Tape Server has been installed and is operational, the focus of a customer's management shifts from "What kind of work will we have it do?" to "How is it doing?" The Virtual Tape Server, working with the Library Manager, provides ongoing management information to answer that question. Information about the performance and operational usage of the Virtual Tape Server is provided in both detailed and summary form and is host accessible. In addition, graphical displays of some of the key operational and performance aspects of the Virtual Tape Server are displayable through the Library Manager console.

The Virtual Tape Server/Library Manager provides:

- Virtual Tape Server event logging
- Operational Statistics for the virtual and physical aspects of the tape library
- Operational and Performance display graphs through the Library Manager console

2.26.1 Event Logging

Several kinds of events that occur in the Virtual Tape Server are logged. Most of the events provide detailed information about the actions taken against the virtual volumes in the server. Other events include when the Virtual Tape Server controller was initialized and an hourly summary of operational and performance statistics for the library. All log events are date- and time-stamped to a resolution of 1/100 of a second.

Log events are accumulated daily and then written out to a virtual volume in the system at midnight. A special set of volumes, one for each day of a year, are used for this purpose, providing a one-year rolling log of events. Once a day's log of events has been written to a virtual volume, that log is available for host access.

The log data for a day is contained in a single file on the volume. The size of the log file depends on the number of virtual volumes processed during the day. Nominally, the number of bytes logged for each virtual volume is between 200 and 300. If the library processes 5,000 virtual volumes in a day, that would result in a log file size of approximately 1.5 MB.

The types of log events are described in subsequent sections.

2.26.1.1 Control unit initialization

The log events provide detailed information about the use of each virtual volume by the Virtual Tape Server. Please see Figure 36 on page 76, which contains a time stamp, the event, and the library sequence number of the logical library that contains the Virtual Tape Server subsystem.

2.26.1.2 Virtual volume event

For a virtual volume, the following events are logged:

- The beginning of a mount operation for a virtual volume.
This event is indicated in the figure by Open
- The completion of a mount operation.
This event is logged when the virtual device is ready and is indicated by Ready. This log record also includes the size of the volume.
- The issuance of the first Read, Write, or Tape Motion command to the virtual device after a mount is completed.
This event is indicated in the figure by FIO.
- The completion of rewinding and unloading of a virtual volume.
This event is indicated in the figure by Close. The log record also includes the size of the volume, whether it was modified, and the number of bytes read or written from or to the volume by the host.
If a virtual volume was modified while it was open and is scheduled for premigration. This event is indicated in the figure by CIM.
- If the virtual volume was modified it will be premigrated.
This event is indicated in the figure by PRE.
- The removal of a virtual volume from the tape volume cache.
This event is indicated in the figure by MIG.

2.26.1.3 Library Manager hourly statistics

A group of records are written to the log that contain the data the library manager generated about the last hour's performance of the library. There are nine records in the group which contain the same information as is provided in SMF Record Type 94. This group of records is written to the log at the same time it is being provided to the attached hosts. Refer to Section 2.26.2, "Library Reporting" for the content of the records.

2.26.2 Library Reporting

SMF Record Type 94 will include the virtual mount statistics and VTS operational information when the record is written for a logical library that contains a Virtual Tape Server subsystem. The information listed below will be provided:

- Number of currently installed and available physical drives.
- Maximum, minimum, and average number of physical drives that were mounted in parallel during the last hour.
- Maximum, minimum, and average physical mount time during the last hour.
- Number of physical mounts completed during the last hour for:
 - Recalls
 - Migrate
 - Reclaim
- Number of currently configured virtual drives.
- Maximum, minimum, and average number of virtual drives that were mounted in last hour.
- Maximum, minimum, and average virtual mount time during the last hour.
 - Number of virtual mounts completed during the last hour for:
 - Fast-Ready
 - Specific tape volume cache
 - Recalls
 - Number of virtual volumes premigrated during the last hour.
 - Number of bytes written to and read from the VTS during the last hour.
- Number of bytes written and read from a stacked 3590 cartridges in the last hour.
- Average tape volume cache age at the end of the reported hour.
- Average volume size in the tape volume cache at the end of the reported hour.
- Number of virtual volumes in the tape volume cache at the end of the reported hour.
- Number of bytes of active data managed by the Virtual Tape Server determined as of the end of the previous day.
- Number of bytes of free space available in the VTS as of the end of the previous day.

2.26.3 Library Manager Displayed Information

Through the Library Manager console, several of the key operational and performance statistics regarding a Virtual Tape Server are displayed in a graphical format. These are in addition to the current performance graph. The information displayed includes:

- A 30 day graph showing the daily state of the storage space managed by the Virtual Tape Server. The graph displays four values:
 - Total effective managed storage capacity of the Virtual Tape Server.
 - Number of gigabytes of active data

- Number of gigabytes of free space
- Free-space alert threshold.
- A 24-hour graph showing the data throughput in gigabytes per hour of the Virtual Tape Server. The graph displays four values:
 - Host read gigabytes
 - Host write gigabytes
 - 3590 device read gigabytes
 - 3590 device write gigabytes
- A 24-hour graph showing how virtual mounts were performed during each hour. The graph displays three values:
 - Number of mounts completed with Fast-Ready (scratch mounts).
 - Number of mounts completed because the needed volume was in the Tape Volume Cache.
 - Number of mounts completed by recalling data from a stacked cartridge.
- A 24-hour graph of the hourly usage of the 3590 devices managed by the Virtual Tape Server. The graph displays three values:
 - Maximum physical devices concurrently mounted
 - Minimum physical devices concurrently mounted
 - Average physical devices concurrently mounted.
- A 24-hour graph of the virtual mounts completed each hour.

2.27.3 Error Recovery

If the IBM Magstar Virtual Tape Server detects either a write or read error on a 3590 cartridge and the error is not recoverable (the recovery process includes retrying the read or write on another 3590 device), the following occurs:

- The valid active data from the physical volume is moved to another physical volume.
- The physical volume is ejected to the convenience output station.
- A message is sent to each attached host indicating that an intervention is required in the library.
- The operator intervention panel on the Library Manager indicates that volume xxxxxx has a permanent data error and has been ejected.

The database information stored by the Library Manager and the Virtual Tape Server subsystem is critical to the operation of a Virtual Tape Server subsystem. The database contains the location of the physical resources in the library (devices, cartridge) as well as information on the logical volumes and their associated stacked volume locations.

The Virtual Tape Server subsystem provides facilities to allow for the recovery of the database information in the case of a major failure or disaster. Your involvement is not required to ensure that critical information is being protected, but your involvement can be required to perform some of the steps of a recovery operation.

In the worst case that all database information is lost, the database can be recreated from the information in the stacked volumes.

Chapter 3. IBM Magstar 3590 in the S/390 Environment

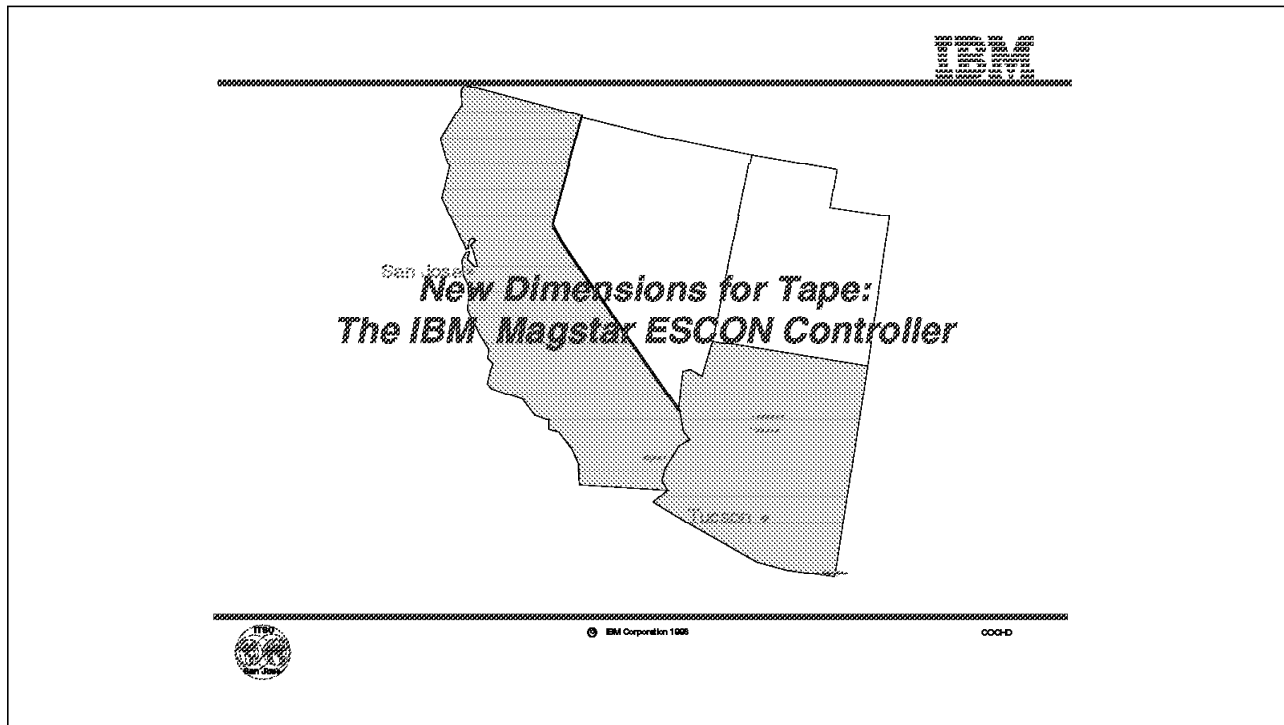

Figure 38. Title Slide for the IBM Magstar 3590 ESCON Controller

This chapter reviews the availability of Magstar with ESCON attachments and the implications in S/390 tape processing, and the IBM 3494 enhancements for large-capacity tape subsystems. The following topics are covered:

- The IBM 3590 ESCON control unit (Model A00)
- The IBM 3590 purpose-built frame (Model A14)
- A recap of the IBM 3591 Model A01 ESCON control unit
- IBM 3590 library configurations
- IBM feature codes for IBM 3590 ESCON attachment
- Migration to native IBM 3590 in an ESCON environment
- Software implications

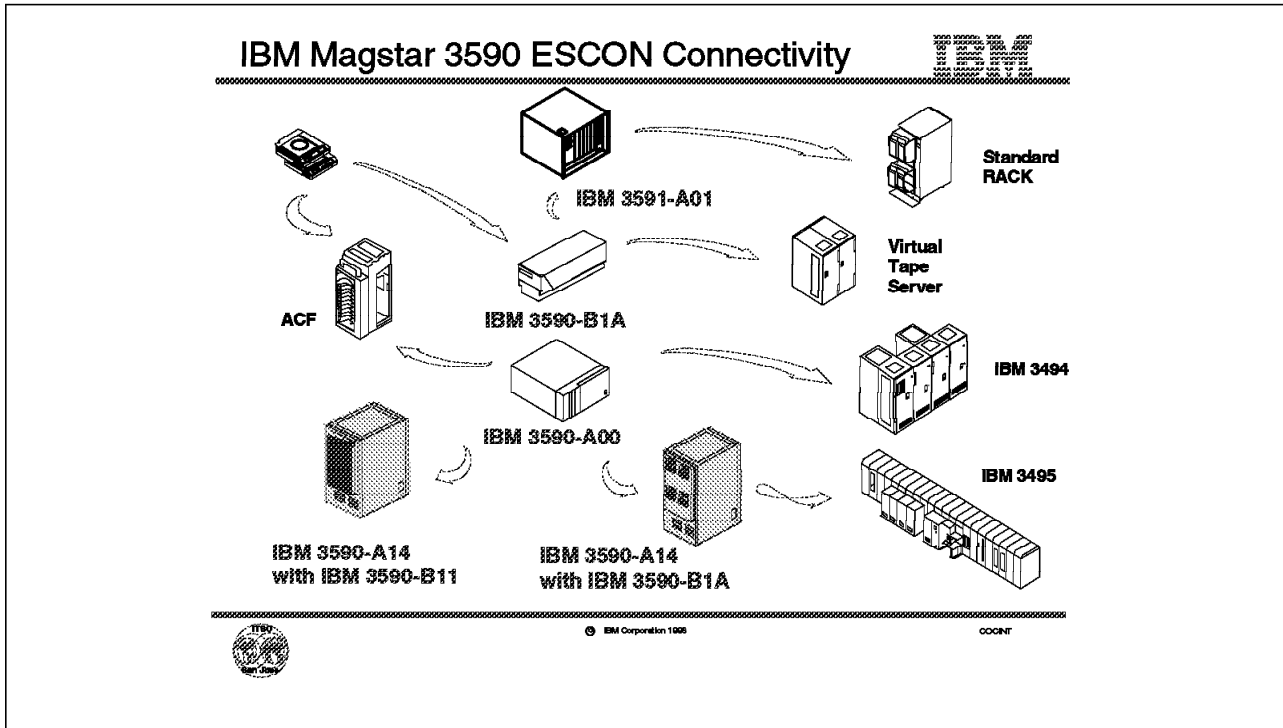

Figure 39. IBM Magstar 3590 ESCON Connectivity

3.1 Introduction

The availability of the IBM 3590-A00 ESCON control unit expands the picture first announced in April 1995. The IBM Magstar 3590 native SCSI-attached Models B11 and B1A have already achieved high success in the open systems and midrange arenas—both inside and outside libraries. The high levels of performance, reliability, data integrity, and cartridge capacity associated with IBM 3590 tape subsystems are now extended to ESCON-attached systems.

The IBM 3590-A00 ESCON Control Unit



- Provides ESCON attachment
- Stand-alone or automation
- Up to four IBM 3590 drives
- One or two channel attachments
 - NOTE: single channel initially
- Two concurrent data paths
- Up to 64 logical paths per physical path (128 per control unit)
- Up to 43 km distance
- 17 MB/s instantaneous data rate

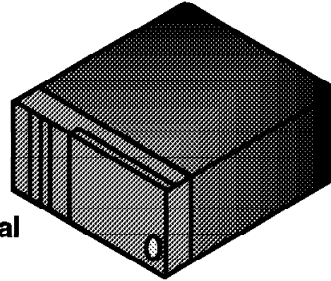

IBM 3590-A00



© IBM Corporation 1995

CC0A00

Figure 40. The IBM 3590-A00 ESCON Control Unit

3.2 The IBM 3590-A00 ESCON Control Unit

Figure 40 lists the features of the IBM 3590-A00 ESCON control unit.

3.2.1 ESCON Attachment

The IBM 3590 Model A00 Controller provides ESCON channel attachment of IBM's highest-performance, large-capacity tape subsystem. It is intended for large-system customers who require high performance and large storage capacity.

3.2.2 Stand-Alone Tapes and Automation

The IBM 3590-A00 can be used in an automated environment with the IBM 3590-B1A drives in an IBM 3494 or 3495 Tape Library Dataserver, or with IBM 3590-B11 drives in the IBM 3590-A14 purpose-built frame in a stand-alone environment.

3.2.3 Up to Four Attached IBM 3590 Drives

The IBM 3590-A00 supports up to four attached IBM 3590 drives.

1. When the IBM 3590-A00 is installed in a stand-alone (non automated) environment—that is, in an IBM 3590-A14 frame—you can attach between one and four IBM 3590-B11 drives. These drives include automated cartridge loaders.
2. When the IBM 3590-A00 is installed in an IBM 3494 tape library drive unit frame (IBM 3494-D14), you can attach up to four IBM 3590-B1A drives. These drives do not have automated cartridge Facilities (ACFs).

3. In the IBM 3494-L14 library unit frame, you can attach only two drives because there is space for only two IBM 3590-B1As with the IBM 3590-A00 controller.
4. When the IBM 3590-A00 is installed as part of the IBM 3495 library, it is housed in the IBM 3590-A14 frame. In the library environment, the IBM 3590-A14 frame must be fully configured with four IBM 3590-B1A drives attached to the IBM 3590-A00 controller.

3.2.4 Logical and Physical Paths

The IBM 3590-A00 is a single control unit, but, for a choice of entry price and greater flexibility in an ESCON configuration, you can install either a single ESCON adapter or two ESCON adapters. This option was not offered on the original announcement date in April 1995. Feature 3311 is now a required feature that provides the first ESCON channel adapter, and Feature 3312 is an optional feature that provides the second ESCON channel adapter.

Note: Until the first quarter of 1997, the IBM 3590-A00 is available with only one ESCON interface (Feature 3311). IBM has automatically added Feature 3311 (in addition to Feature 3312) to models currently on order; this ensures that they match the originally announced configuration— that is with two ESCON attachment features. However, if you require ESCON support in 1996, then Feature 3312 must be removed.

The IBM 3590-A00 controller supports 64 logical ESCON paths per physical path, or 128 logical paths in total. When configured with two ESCON adapters and at least two Magstar drives, the controller provides simultaneous data transfer on both adapters. Each adapter supports a maximum instantaneous data rate of 17 MB/s, and the controller supports a maximum channel distance of 43 km.

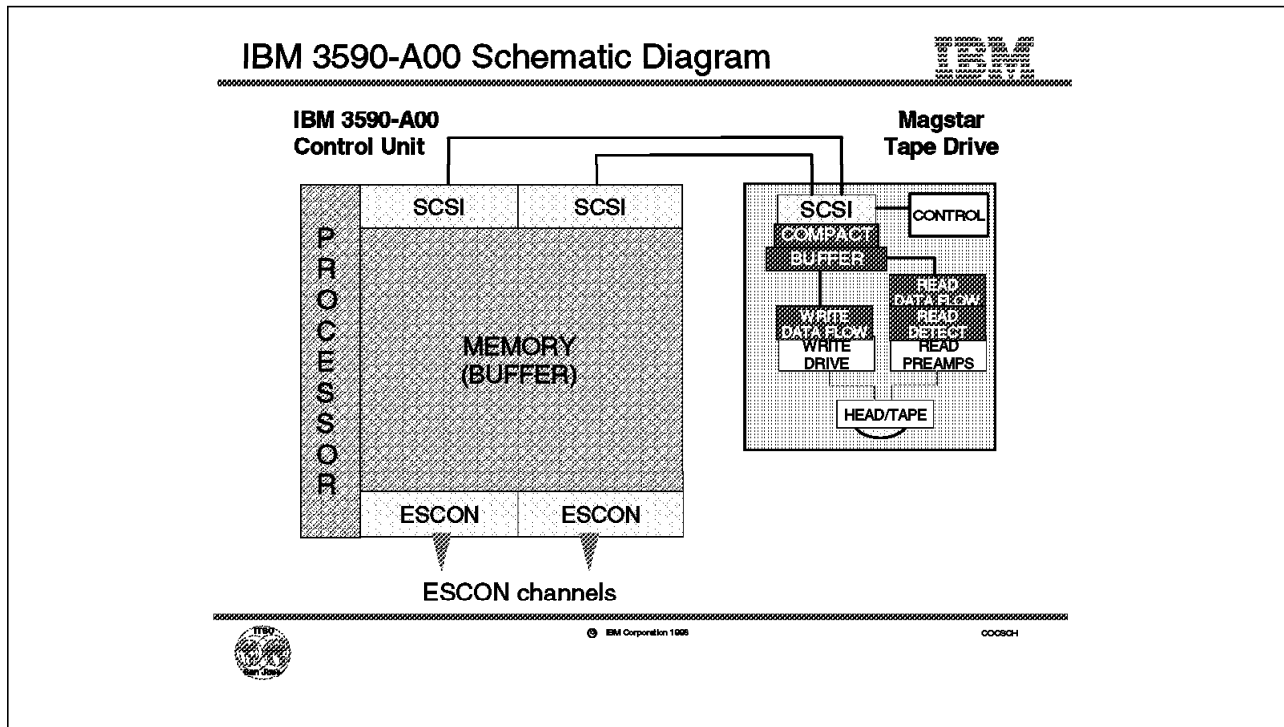

Figure 41. IBM 3590-A00 Schematic Diagram

3.3 IBM 3590-A00 Schematic Diagram

The controller contains a processor and Licensed Internal Code to convert ESCON protocol to SCSI protocol and the reverse. Data can be transferred simultaneously down both ESCON channels into the buffer and then, using the SCSI bus, to the tape device buffer. The data is compressed in the IBM 3590 device level buffer, as shown in Figure 41.

The controller has 4 MB buffer memory for each drive which is allocated statically.

The instantaneous data rate supported on each channel interface is 17 MB/s. However, the achieved data throughput in a subsystem is a result of many different factors, including host data rate from the disk subsystem, host block sizes, compaction ratio, and host applications, as well as factors within the tape subsystem itself. Preliminary performance data for the IBM 3590-A00 shows that the maximum aggregate data rate over a single ESCON channel is approximately 10 MB/s, where the compaction ratio is 3:1 and multiple IBM 3590 drives are operating. (The subsystem is not limited by the native drive speed of the 3590.) With both ESCON channels active, the overall maximum aggregate throughput increases by approximately 15-25%. Thus the second ESCON channel should be considered for configuration flexibility and redundancy rather than for performance enhancements.

IBM Magstar ESCON CU Comparison



● IBM 3590-A00

- ◆ Appears to host as 3590
- ◆ Two ESCON attachments
- ◆ Attached drive must be attached to only IBM 3590-A00
- ◆ Supported in IBM library and a purpose-built frame
- ◆ Supports up to four IBM 3590 drives
- ◆ Up to 43 km distance

● IBM 3591-A01

- ◆ Appears to host as 3490E
- ◆ One ESCON attachment
- ◆ Attached drive may attach second port to SCSI host
- ◆ Supported stand-alone in a standard rack
- ◆ Supports up to four IBM 3590 drives
- ◆ Up to 43 km distance



© IBM Corporation 1998

000A01

Figure 42. A Comparison of the Two IBM Magstar ESCON Control Units

3.4 IBM Magstar ESCON Control Unit Comparison

IBM already provides ESCON attachment for Magstar 3590 tape drives using the IBM 3591-A01 ESCON tape controller. However, there are some notable difference in the two subsystems (Figure 42). This is a brief review of the two subsystems to help clarify the differences and similarities.

3.4.1 Device Emulation

The most important difference is that the IBM 3591 tape subsystem emulates a 3490E-type tape subsystem. The host views it as an IBM 3490-A10 controller with attached IBM 3490E devices. When the IBM 3591 tape subsystem is installed, new levels of host software for new device support are not required, provided the current installed software supports 3490E-type devices. This may also present operational complications if real IBM 3494E drives are installed on the same system. See *Magstar and IBM 3590 High Performance Tape Subsystem: Multiplatform Implementation* for detail.

The IBM 3590 tape subsystem using the IBM 3590-A00 controller does not emulate other tape devices but provides native 3590 support. Consequently, new levels of host software are required for 3590 device support. However, the host will employ the full capabilities of the IBM 3590 tape subsystem rather than applying potential limitations; for example, the host will understand that the tape capacity is 10 GB.

3.4.2 ESCON Attachments

The IBM 3590 tape subsystem provides two ESCON channels to the host capable of concurrent data transfer. The IBM 3591 tape subsystem provides only one path.

Note: Initial shipments of the IBM 3590-A00 will provide only one of the possible two ESCON adapters.

3.4.3 ESCON Multiple paths From One Host

In the IBM 3590 tape subsystem a single host may access the same tape device over multiple logical paths to the same logical control unit. However, this is not the case for the IBM 3591 tape subsystem where the host may access the device over only a single logical path.

3.4.4 ESCON and SCSI Hosts Sharing Drives

In the IBM 3590 tape subsystem, without Feature 3311, both SCSI ports on the IBM 3590 drive unit must be attached to the IBM 3590-A00. This means that they are accessible only using the ESCON channels and therefore cannot be shared by a SCSI host. In the IBM 3591 tape subsystem, only one of the SCSI ports on the IBM 3590 drive unit need be attached to the IBM 3591-A01. If required the second port may be attached to a SCSI host (for example a RISC System/6000) and the drive can be used by either the ESCON or the SCSI-attached host. Note that the drive cannot be used by both hosts at the same time; it must be varied on and off to each host as required.

3.4.5 Subsystem Housing Frames

The IBM 3591 tape subsystem is housed in a standard 19-inch rack; for example, the IBM 9309-002 or IBM 7015-R00 rack. The IBM 3591 tape subsystem is not available in IBM Automated Tape Library Dataservers environments. However, it can be used in non-IBM automated tape library environments with IBM 3590 tape devices housed in an IBM 3590-C12 frame (see Section 5.4, "IBM 3590 Model C12" on page 162 for further details).

The IBM 3590 is available as a stand-alone or in an automated tape library. For a non-automated tape solution, the IBM 3590-A00 is available in the IBM 3590-A14 purpose-built frame. For an automated solution, the IBM 3590-A00 is housed either directly in an IBM 3494 frame (Models x14), or, in the IBM 3590-A14 frame which is incorporated in the IBM 3495 library.

Note: The IBM 3590-A00 is not available in a standard 19-inch rack, but it may replace a currently installed IBM 3591-A01 in a rack for migration purposes if required.

The IBM 3590-A14 installed in the IBM 3495 will be available in the first quarter of 1997.

3.4.6 Subsystem Similarities

Both IBM 3590 and 3591 tape subsystem controllers support up to four IBM 3590 tape drives.

Both subsystems are supported with an instantaneous data rate over the ESCON channel of 17 MB/s, and up to a distance of 43 km.

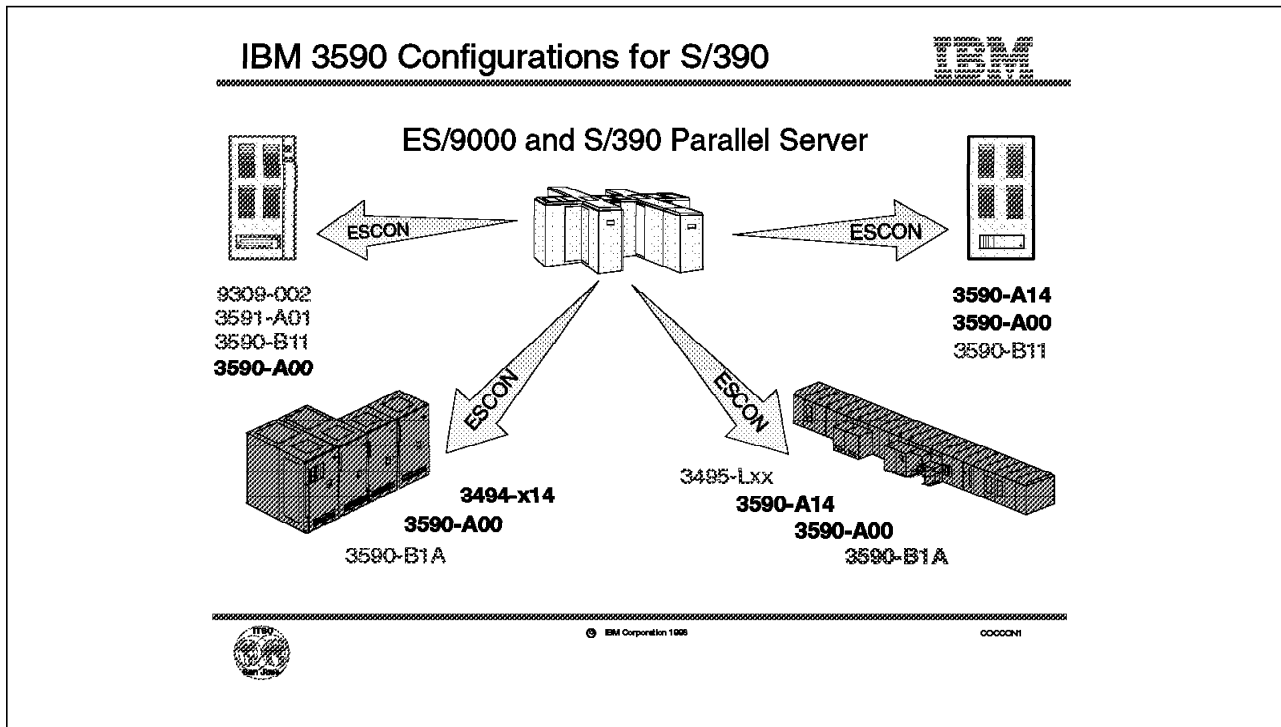

Figure 43. IBM 3590 Configuration for S/390

3.5 IBM 3590 Configurations for S/390

Figure 43 shows the four basic environments in which IBM 3590 technology is now available for S/390 ESCON platforms.

3.5.1 Host Attachment

IBM ES/9000 systems and S/390 Parallel Server systems attach to IBM 3590 configurations using only ESCON channels. Neither SCSI nor parallel channels are supported.

First, in the IBM 3591 subsystem environment, the IBM 3590 devices emulate an IBM 3490E subsystem. The basic differences between this environment and the IBM 3590 subsystem are discussed in Section 3.4, "IBM Magstar ESCON Control Unit Comparison" on page 88.

Second, in three different IBM 3590 subsystem environments, the devices are supported in native 3590 mode:

- The IBM 3494 library with IBM 3590 drives

ES/9000 systems and S/390 Parallel Server systems attach to IBM 3590-B1A tape drives inside an IBM 3494 library using the IBM 3590-A00 control unit. A drive unit frame (Model D14) supports zero or one IBM 3590-A00 with a minimum of zero and a maximum of four IBM 3590-B1As. The library unit frame (or control unit frame, a Model L14) supports zero or one IBM 3590-A00, with a minimum of zero and a maximum of two IBM 3590-B1As. Each IBM 3590-A00 (with its attached IBM 3590-B1As) is one control unit function. One library supports up to a maximum of sixteen control unit functions. (See Section 3.16, "IBM 3494 Current Capacity Enhancements" on page 116.) When installed to an IBM 3494-B16 inside an IBM 3494 library,

the IBM 3494-D12 frame that attaches to the IBM 3494-B16 must be configured with three or six IBM 3590-B1As installed. (See Section 2.8, “IBM 3494 Virtual Tape Server Configuration Guidelines” on page 37.)

- IBM 3590 stand-alone subsystem in the IBM 3590-A14 frame

The IBM 3590-A14 model is a purpose-built rack. It attaches to ES/9000 systems and S/390 Parallel Server systems using the two ESCON adapters in the integrated IBM 3590-A00. The IBM 3590-A14 can have from a minimum of one up to a maximum of four IBM 3590-B11s included. Note that an IBM 3590-A14 order will bring the rack only; the IBM 3590-A00 and the required IBM 3590-B11s must be ordered separately. A fully configured IBM 3590-A14 is one complete tape subsystem.

- IBM 3495 with IBM 3590 drives

As well as being an independent subsystem, the IBM 3590-A14 frame can be incorporated into an IBM 3495 library, either native or attached to the Virtual Tape Server. When part of a native (“real”) library, each IBM 3590-A14 subsystem must be fully configured with the IBM 3590-A00 controller and four IBM 3590-B1As installed. One IBM 3495 library supports up to a maximum of eight tape subsystems. (See Section 3.8, “IBM 3495 Configuration” on page 98.) When installed with an IBM 3495-B16 inside an IBM 3495 library, the IBM 3590-A14 subsystem that attached to the IBM 3495-B16 must be fully configured with four IBM 3590-B1As installed, but the IBM 3590-A00 controller is not required. (See Section 2.11, “IBM 3495 Virtual Tape Server Configuration Guidelines” on page 43).

IBM 3495-M10

The IBM 3495 Model M10 Manual Tape Library Dataserver does not support the IBM 3590 High Performance Tape Subsystem.

3.5.2 ESCON Considerations

The considerations for ESCON are as follows:

- Supported distances

The supported distance between a subsystem control unit and a host is limited by the communication protocols and the timing of the signals passed between the host and control unit. The IBM 3590-A00 control unit is supported at a distance of up to 43 km from the host system. The support of the maximum distance is required for the ESCON extended distance facility (XDF) channel, using a 20 km single-mode link to a director, a second 20 km single-mode link to a second director, and a final 3 km multimode LED link to the tape subsystem.

- Logical paths

Up to 64 logical ESCON paths can be defined for each physical path in the IBM 3590-A00: a total of 128 logical paths defined for the control unit. Only two of these paths can be active concurrently. Compare this with the IBM 3490-A20, for example, which has a maximum of eight ESCON physical paths to an ES/9000 host or hosts, each of which can have 16 logical paths, giving a total of 128 logical paths for the control unit. Again, only two of these paths can be concurrently active.

Note: Do not confuse the number of logical paths supported by an ESCON control unit with the number of paths that can be defined from a

system image to a single device. The processor complex channel subsystem (CSS) determines the number of paths that can be defined between a system image and a single device. The number of paths to a device depends on the processor type and model. ES/9000 711-based processors, 520-based processors, and 511-based processors can define up to eight physical channel paths to a device. All other ES/9000 and ES/3090 processors can define up to four paths to a device. This limit is enforced by the IOCP and the hardware configuration definition (HCD).

3.5.3 Library Manager Attachments

ES/9000 or S/390 Parallel Server hosts are connected to the IBM tape libraries by S/390 channels to the tape control units and drives. Data is passed down the ESCON channel to or from the drive, and Library Manager commands are passed to the control unit, which in turn directs them to the Library Manager. The tape control units are connected to the Library Manager inside the library using RS-422 connections. (See Section 3.16, "IBM 3494 Current Capacity Enhancements" on page 116 for details about the number of connections.)

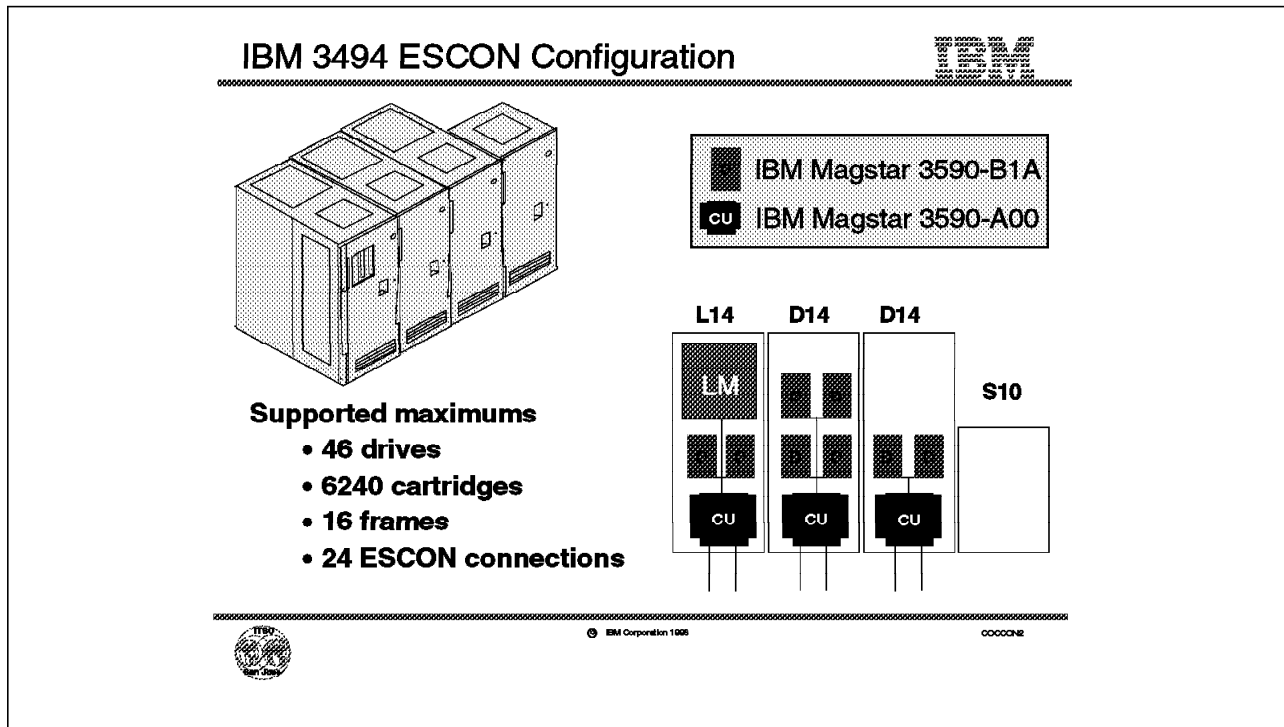

Figure 44. IBM 3494 ESCON Configuration

3.6 IBM 3494 ESCON Configuration

The IBM 3494 Tape Library Dataserver is designed for customers who need to store from 210 to 6040 cartridges. A given configuration consists of one to eight frames (one control unit frame and any combination of storage and drive unit frames up to a total of eight), with the possibility of extending by a further eight frames (giving a total of 16) within a fixed configuration. (See Section 3.15, "IBM 3494 Expanded Cartridge and Drive Capacity" on page 115 for a description of the new higher capacity IBM 3494 library.) A variety of frame types is available to customize the library capabilities. Three basic IBM 3494 models combine to make up the library:

- Control unit frame, Model Lxx (also referred to as the *library unit*), which contains one 3490E-C1A or C2A, or one or two IBM 3590 drives with an IBM 3590-A00 for ESCON attachment.
- Zero to seven optional storage unit frames, Model S10.
- Zero to seven optional drive unit frames, Model Dxx, which can contain one 3490E-C1A or C2A, or up to four IBM 3590 drives with an IBM 3590-A00 for ESCON attachment.

The IBM 3494 library now supports a maximum of sixteen tape control unit connections. (See Section 3.16, "IBM 3494 Current Capacity Enhancements" on page 116 for details of this enhancement.) Each IBM 3590-B1A (when attached without an IBM 3590-A00), and each IBM 3590-A00 (with any number of IBM 3590-B1As attached) uses one control unit connection, as does each IBM 3490-C1A or C2A. Thus the maximum number of tape drives supported in a single library depends on the mixture of tape drive models installed.

The IBM 3494 model types are of four basic groups, or families:

- The x10 models, which house IBM 3490E drives
- The x12 models, which house IBM 3590 native SCSI attached tape drives
- The x14 models, which house ESCON-attached IBM 3590 tape drives and an IBM 3590-A00 control unit
- The IBM 3494-S10 storage unit

All IBM 3494 frame models can be combined in one library, provided that the overall configuration rules are not broken. For example, the L10, L12, and L14 library units support S10 storage units, and the D10, D12, and D14 drive units. Basically, any combination is acceptable.

As stated above the number of tape drives that can be installed in an IBM 3494 library is model dependent and also can be limited by the number of internal communications paths to the Library Manager. Four, eight, or sixteen paths are available, and the different subsystems have different requirements:

- One path for each IBM 3490-C1A or IBM 3490-C2A
- One path for each IBM 3590-A00 (including its attached drives)
- One path for each direct SCSI-attached IBM 3590-B1A
- Five paths for each Virtual Tape Server subsystem (See Section 2.7.2, “Library Manager Attachment” on page 35 for details about the Virtual Tape Server)

In an IBM 3494 library limited to 3490E subsystems, with the IBM 3490E CxA models, it is not possible to exceed the supported number of control unit functions. No more than sixteen control units could be installed in the maximum number of IBM 3494 frames. However, in mixed configurations, a single Model D12 drive unit can accommodate six native SCSI-attached IBM 3590-B1A drives, each with its own integrated control unit.

As a result, using only IBM 3490 subsystems, the maximum number of drives that can be installed in an IBM 3494 library is 24, because the maximum number of drive unit frames in the enhanced capacity option of the IBM 3494 is 11 plus one library unit frame. This is explained in Section 3.17, “IBM 3494 Expanded Capacity Configuration Options” on page 119. Using only ESCON-attached IBM 3590-B1A drives with the IBM 3590-A00 control unit, the maximum number of drives is 46, whereas using only direct SCSI-attached IBM 3590-B1A drives, the maximum number of drives is sixteen. If a Virtual Tape Server is included in the IBM 3494 library, it uses either five or eight of the RS-422 connections and one RS-232 connection leaving either seven or four RS-422 connections for other tape drive control units. Any mixed configuration is possible, provided that the total number of paths to the Library Manager does not exceed those available.

It is easy to see that with different hosts and platforms sharing a mixed configuration of IBM 3490E and IBM 3590, it is necessary to exercise care in planning the IBM 3494 configuration.

Any one IBM 3590 can have only one type of channel attachment, either two ESCON adapters (using the IBM 3590-A00) or two SCSI adapters, but not one of each. This may be important when sharing tape drives between platforms that use different channel protocols. IBM 3490-Cxx models can be configured with

any combination of channel adapters (two for any one model Cxx), ESCON, parallel, or SCSI. So, although a tape drive can be online only to any one host at a time, and any one host must “see” a control unit as either ESCON, parallel, or SCSI attached, it is possible to attach one IBM 3490-CxA to two different hosts using different channel interfaces and then switch the tape drives between the two hosts as required. However, this scenario is not possible with an IBM 3590 tape drive. For further information on issues regarding sharing tape libraries and tape drives, see *Guide to Sharing and Partitioning IBM Tape Library Dataserver*.

IBM 3590-A14 Frame



- **Purpose-built frame**
- **Up to two ESCON attachments**
- **IBM 3590-A14 for stand-alone**
 - ✦ **One IBM 3590-A00 controller**
 - ✦ **From one to four IBM 3590-B11 drives**
 - ✦ **Up to 1.2 TB of ACF Capacity**
- **IBM 3590-A14 in the IBM 3495**
 - ✦ **One IBM 3590-A00 controller**
 - ✦ **Four IBM 3590-B1A drives**
- **IBM 3590-A14 for IBM 3495 VTS**
 - ✦ **Four IBM 3590-B1A drives**
 - ✦ **No IBM 3590-A00 controller**

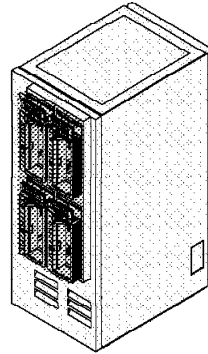

© IBM Corporation 1995

000414

Figure 45. The IBM 3590-A14 Purpose-Built Frame

3.7 The IBM 3590-A14 Frame

The IBM 3590-A14 is a purpose-built rack that houses an IBM 3590-A00 control unit and up to four IBM 3590 tape drives. An IBM 3590-A00 control unit and up to four IBM 3590-Bxx models must be ordered separately for installation in an IBM 3590-A14 frame.

This subsystem is similar to the IBM 3490 A and B models. When used as a stand-alone tape subsystem, between one and four IBM 3590-B11 drives are installed in the frame (the IBM 3590-B11 drive models include an automated cartridge facility). When incorporated into the IBM 3495 Automated Tape Library Dataserver, the IBM 3490-A14 must be fully configured with one IBM 3590-A00 and four IBM 3590-B1As installed (the IBM 3590-B1A drive models do not include the automated cartridge loader).

The IBM 3495 Library Manager supports attachment of up to eight control units (that is, IBM 3490 A-models or IBM 3590-A00s). Thus a maximum of eight IBM 3590-A14s (with 32 IBM 3590-B1A tape drives) can be incorporated into an IBM 3495 configuration. The physical positions of the IBM 3590-A14s in an IBM 3495 library configuration are the same as the positions where the IBM 3490 B-models are installed today. See Section 3.8, "IBM 3495 Configuration" on page 98.

The IBM 3590-A14 frame also forms part of the Virtual Tape Server when installed in an IBM 3495 library. When attached to an IBM 3495-B16 inside an IBM 3495 library, each IBM 3590-A14 frame must be fully configured with four IBM 3590-B1As installed, but the IBM 3590-A00 controller is not required. See Section 2.11, "IBM 3495 Virtual Tape Server Configuration Guidelines" on page 43.

IBM 3495-M10

The IBM 3590 is not supported in the IBM 3495-M10 Manual Tape Library Dataserver.

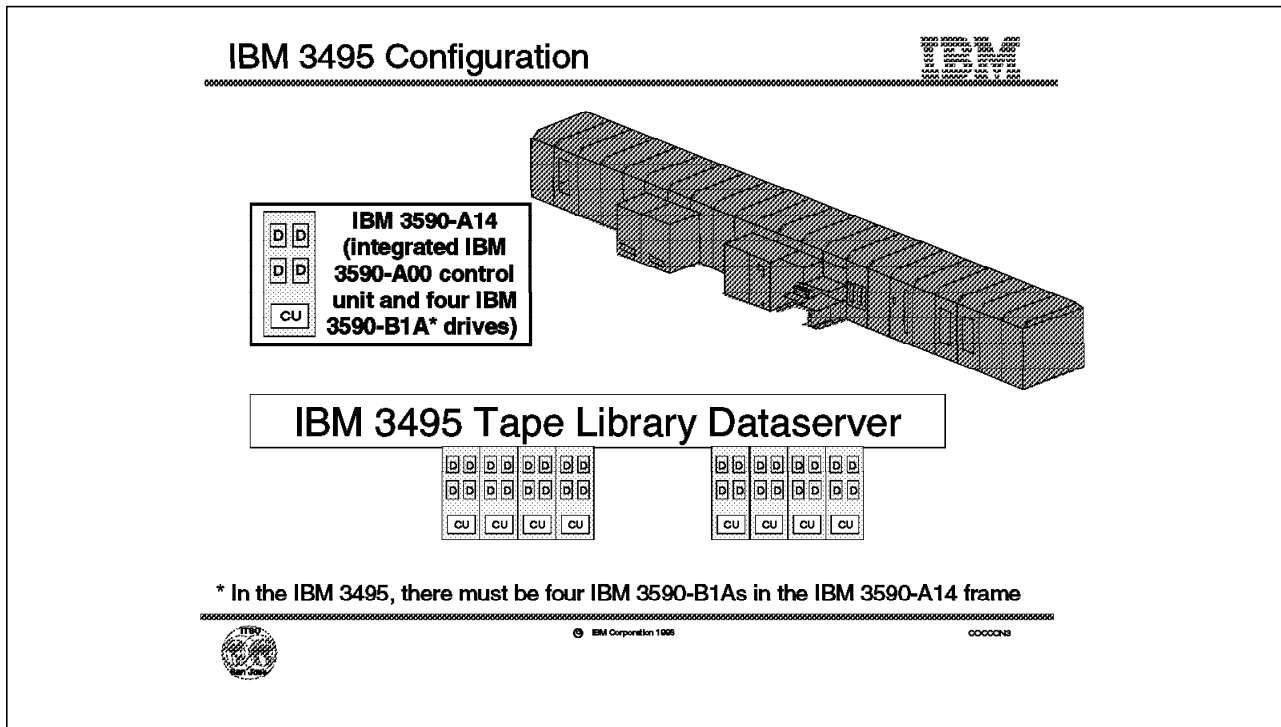

Figure 46. IBM 3495 Configuration

3.8 IBM 3495 Configuration

The IBM 3495 Automated Tape Library Dataserver (Figure 46) is designed to meet the needs of customers who want to automate the use of a large number of cartridges. Four models provide a range of cartridge capacities from 5660 to 18900 storage cells:

- IBM 3495-L20** 5660-6440 storage cells, 4-16 drives
- IBM 3495-L30** 8460-10580 storage cells, 4-32 drives
- IBM 3495-L40** 11280-14740 storage cells, 4-48 drives (4-32 drives if all IBM 3590)
- IBM 3495-L50** 14100-18900 storage cells, 4-64 drives (4-32 drives if all IBM 3590).

Each library model supports a mix of the three tape subsystems (3490, 3490E, and 3590) that can be installed in an IBM 3495 library and their associated tape storage media.

All IBM 3490 Models A01, A02, and B04 and IBM 3490E Models A10, A20, and B40 have a control unit (Model Axx) and a drive unit (Model Bxx). Multiple B units can be controlled by a single A unit.

IBM 3590-B1A tape drives are installed in the IBM 3495 library using the IBM 3590-A14 frame. The IBM 3590-A00 control unit (up to two control unit functions) and four IBM 3590-B1A drive units are packaged within the IBM 3590-A14 frame. Each IBM 3590-A14 frame must be fully configured with the maximum of four IBM 3590-B1A tape drives installed. One IBM 3590-A14 forms a complete subsystem; there is no control unit frame, and there are no additional B units that can be attached to the IBM 3590-A14. IBM 3590-A14 frames cannot be coupled together.

Note: Unlike the IBM 3490 and 3490E models, the IBM 3590 configurations are supported only on the IBM ES/9000 and S/390 Parallel Server platforms.

The number of tape drives that can be installed in an IBM 3495 library is model dependent, as shown above, but can also be limited by the number of internal communications paths with the Library Manager. When a Virtual Tape Server is installed in a IBM 3495, it uses a separate attachment to the Library Manager and does not use any of the existing eight connections. The connection paths differ as follows:

- One path for each IBM 3490-A01 or IBM 3490-A10
- Two paths for each IBM 3490-A02 or IBM 3490-A20
- One path for each IBM 3590-A00.

So, for example, using only IBM 3490 subsystems, the maximum number of drives that can be installed in an IBM 3495 library is 64, whereas using only IBM 3590 subsystems, the maximum number of drives is 32. Mixed configurations are possible, provided that the total number of paths to the Library Manager does not exceed eight.

The basic configuration of the IBM 3590 subsystem within the IBM 3495 library is similar to the IBM 3490E configuration. Subsystems are installed along the front side of the library, as shown in Figure 46 on page 98.

With IBM 3490 subsystems, the right side of the control unit model, Axx, is aligned with an IBM 3495 frame boundary. Subsequent Bxx models are attached to the left of the Axx unit; they do not line up with the frame boundaries. The spacing of the IBM 3495 frames and the IBM 3490 units requires that filler panels be installed to close a gap between the left-hand edge of the last Bxx unit in a string and the next IBM 3495 storage frame when a full string is not installed.

A rule of thumb for the placement of the IBM 3590-A14 models is this: wherever an IBM 3490E model Bxx can be installed today, an IBM 3590-A14 can be installed instead. This placement rule applies whether replacing currently installed IBM 3490 subsystems or installing new IBM 3590 subsystems and is independent of the model of the IBM 3495 library.

To replace a currently installed IBM 3490 string, the first IBM 3590-A14 will replace the IBM 3490-Bxx unit that is farthest from the IBM 3490-Axx unit. Subsequent IBM 3590-A14 frames are installed adjacent to (and to the right of) the existing A14 frames, each one replacing an IBM 3490-Bxx model. When the fourth IBM 3590-A14 replaces the final IBM 3490 in the string, the IBM 3490 Model Axx control unit is removed, and a filler panel is installed.

Note: Inside the library in front of the IBM 3490-Axx unit, a special storage rack is installed. This is not replaced when the IBM 3490-Axx unit is removed, but the gap left between this special A unit wall and edge of the next IBM 3590-A14 frame is filled with the blank panel.

When adding a completely new IBM 3590 string, install the first IBM 3590-A14 frame in the position where the IBM 3490-Bxx closest to the IBM 3490-Axx unit would normally be positioned, with a filler panel to close the gap to the adjacent IBM 3495 frame. Install additional IBM 3590-A14 frames adjacent to (and to the left of) the previously installed unit.

As stated, a maximum of eight IBM 3590-A14s can be installed in the IBM 3495 library. However, in a mixed configuration of IBM 3490 and IBM 3590 subsystems, the total number of tape subsystems (or control unit functions) must not exceed eight; that is, the total number of IBM 3590-A14s together with any IBM 3490-Axx models must not exceed eight because the number of RS-422 connections to the Library Manager within the library is currently limited to eight.

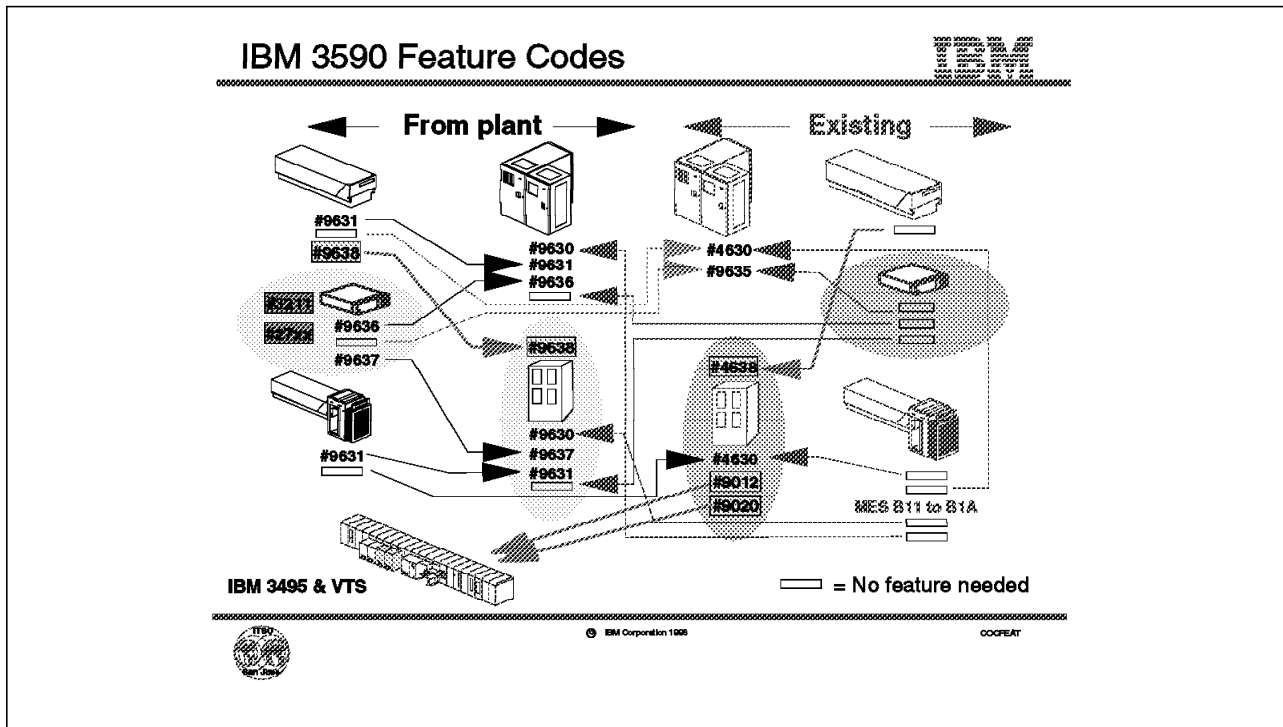

Figure 47. IBM 3590 Tape Subsystem Feature Codes for ESCON Platform

3.9 IBM 3590 Feature Codes

Figure 47 shows which features to order when installing new or existing IBM 3590s in new or existing IBM 3494 Tape Library and IBM 3590-A14 frames. As far as possible, the shaded areas mark the models and features that have been made available, or changed in some way.

Table 2 on page 102 summarizes some of the new feature codes.

The first column in Table 2 shows the IBM 3590 unit that is to be installed (in either an IBM 3494 Tape Library or an IBM-A14 frame). The Install Unit Feature Number column shows the feature that must be specified on the unit to be installed. N/A indicates, for example, that the IBM 3590-B11 cannot be installed in an IBM 3494 Tape Library.

IBM 3590 Unit to Be Installed	New IBM 3494		Existing IBM 3494		New IBM 3590-A14		Existing IBM 3590-A14	
	Install Unit Feature Number	Feature on IBM 3494	Install Unit Feature Number	Feature on IBM 3494	Install Unit Feature Number	Feature on IBM 3590-A14	Install Unit Feature Number	Feature on IBM 3590-A14
New B1A	9631	9631	none	4630	9638	9638	none	4638
Existing B1A	none	9630	none	4630	none	9639	none	4638
New B11	N/A	N/A	N/A	N/A	9631	9631	none	4630
Existing B11	N/A	N/A	N/A	N/A	none	9630	none	4630
New A00	9636	9636	none	4635	9637	9637	N/A	N/A
Existing A00	none	9635	none	4635	N/A	N/A	N/A	N/A

These features constitute the hardware needed to install the subsystems into the frames; the actual drives and control units must be ordered separately.

3.9.1 Non-Chargeable Features

Features numbered 9xxx are not chargeable and are for installation at time of manufacture:

- **9630**
 - An IBM 3494 feature that supplies the hardware to allow for later field installation of one IBM 3590-B1A in a frame
- **9631**
 - An IBM 3494 feature that causes one IBM 3590-B1A to be integrated in an IBM 3494 frame at the factory
 - An IBM 3590-B1A feature denoting that the tape drive will be integrated in an IBM 3494 frame at the factory
 - An IBM 3590-B11 feature denoting that the tape drive will be integrated in an IBM 3590-A14 frame at the factory
 - An IBM 3590-A14 feature that causes one IBM 3590-B11 to be integrated in an IBM 3590-A14 frame at the factory
- **9635**
 - An IBM 3494 feature that supplies the hardware to allow for later field installation of one IBM 3590-A00 in a frame. This feature is applicable only to IBM 3494 Models L14 and D14.

- **9636**
 - An IBM 3494 feature that causes one IBM 3590-A00 to be integrated in an IBM 3494 frame at the factory. This feature is applicable only to IBM 3494 Models L14 and D14.
- **9637**
 - An IBM 3590-A14 feature that causes one IBM 3590-A00 to be integrated in an IBM 3590-A14 frame at the factory
 - An IBM 3590-A00 feature code denoting that the control unit will be integrated in an IBM 3590-A14 frame at the factory
- **9638**
 - An IBM 3590-A14 feature that causes one IBM 3590-B1A to be integrated in an IBM 3590-A14 frame at the factory
 - An IBM 3590-B1A feature code denoting that the control unit will be integrated in an IBM 3590-A14 frame at the factory
- **9635**
 - An IBM 3590-A14 feature that supplies the hardware to allow for later field installation of one IBM 3590-B1A in the IBM 3590-A14 frame

3.9.2 MES Field-installation Features

- **4630**
 - An IBM 3494 feature that, when applied to the IBM 3494 Model D10, supplies the hardware to allow for field installation of an IBM 3490 Model CxA subsystem
 - An IBM 3494 feature that, when applied to the IBM 3494 (except the Models D10 and B16), supplies the hardware to allow for field installation of one IBM 3590-B1A. It is applicable if feature 9630 was not ordered at time of manufacture.
- **4635**
 - An IBM 3494 feature that supplies the hardware to allow for field installation of one IBM 3590-A00 in a frame. This feature is applicable only to IBM 3494 Models L14 and D14 and where Feature 9635 was not ordered at time of manufacture.
- **4638**
 - an IBM 3590-A14 feature that supplies the hardware to allow for field installation of one IBM 3590-B1A in the IBM 3590-A14 frame. This feature is applicable if Feature 9639 was not ordered at time of manufacture.

3.9.3 New Features

This covers some of the new features not applicable to the units in the table:

- **9010**
 - An IBM 3494-D12 feature code that denotes that the Model D12 is attached to the IBM 3494-B16 and forms part of the Virtual Tape Server.
 - An IBM 3494-A14 feature code denoting that the Model A14 is attached to an IBM 3495-B16 Virtual Tape Server; no IBM 3590-A00 controller has been installed; and it is mutually exclusive with Feature 9637.

- **9012**
 - An IBM 3590-A14 feature installed in the factory that allows the IBM 3590-A14 to be integrated in an IBM 3495 library.
- **3311 and 3312**
 - IBM 3590-A00 features that provide the ESCON/SCSI adapters. Feature 3311 is required and supplies the first ESCON and SCSI adapter; Feature 3312 is optional and supplies the second ESCON and SCSI adapter.
- **2710, 2711, and 2712**
 - IBM 3590-A00 features that provide rapid remote support capability. Each IBM 3590-A00 must have one of these features; 2710 is applied to the first IBM 3590-A0 in an installation; 2711 is applied to the second; and 2712 is applied to the third through fourteenth.

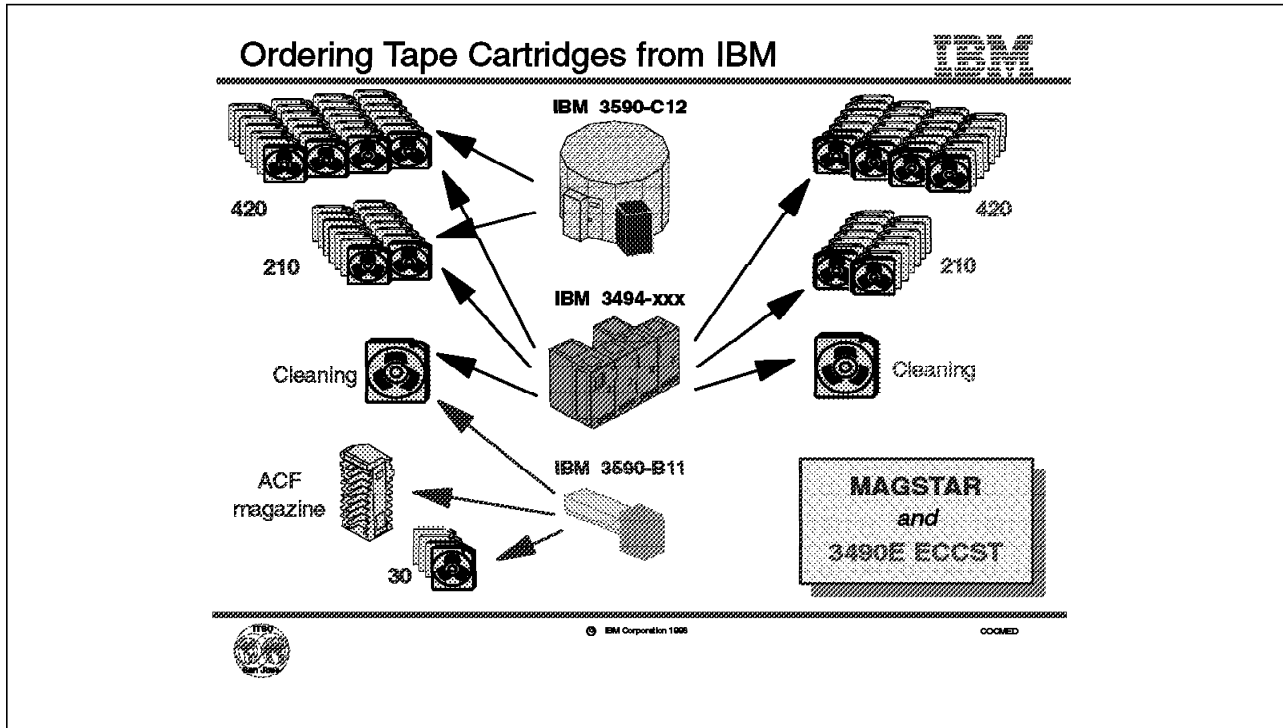

Figure 48. Ordering IBM Tape Cartridges from IBM

3.10 Ordering Tape Cartridges from IBM

Beginning in September 1996, you will be able to order tape cartridges for IBM tape subsystems from IBM. Feature codes for all IBM 3494 models (B16, L10, L12, L14, D10, D12, D14, or S10), IBM 3590 Model B11 (the drive unit with associated ACF), and IBM 3590 Model C12 (the frame for attachment to StorageTek libraries), will bring you fixed-quantity packs of cartridges. The individual feature codes, what they mean, and how you use them are described in this section.

After the machines are installed, when you need more cartridges not covered by these feature numbers, order them from IBM suppliers, or from the newly formed IBM media distribution business, using the part numbers in the following Table 3:

Part number	Description
09G4494	IBM 3490E Enhanced Capacity Cartridge System Tape
4770150	IBM 3490 or 3490E Cartridge System Tape
4780527	IBM 3490 or 3490E Cleaning Cartridge
05H4434	IBM High Performance 3590 Cartridge Tape
05H4435	IBM 3590 Cleaning Cartridge
39F4762	IBM 3590-B11 ACF Magazine

Note: Please refer to the IBM announcement letters for details relevant to your country.

3.10.1 Cartridge Features for All IBM 3494 Models

You must order one out of these five features when you order any of the IBM 3494 models:

- **8410** for a quantity of 210 IBM 3490E Enhanced Capacity Cartridges (800 MB uncompact capacity)
- **8420** for a quantity of 420 IBM 3490E Enhanced Capacity Cartridges (800 MB uncompact capacity)
- **8510** for a quantity of 210 IBM 3590 Magstar tapes
- **8520** for a quantity of 420 IBM 3590 Magstar tapes
- **9540** for no cartridges at all

It is mandatory that you select one of these features when you order an IBM 3494 model. You must not select more than one of these features, and you can select the feature only for shipment with the frame from the manufacturing plant.

You can order cleaning cartridge features for any of the IBM 3494 models:

- **8005** for one IBM 3490E cleaning cartridge
- **8002** for one IBM 3590 cleaning cartridge

You can order up to ten of each of these optional features and they may be ordered for shipment with the IBM 3494 frames as well as after installation.

3.10.2 Cartridge Features for IBM 3590-B11

You must order one of these two features for the IBM 3590 Model B11:

- **8130** for a quantity of 30 IBM 3590 Magstar tapes
- **9590** for no cartridges at all

It is mandatory to select one of these features when you order an IBM 3590-B11 model. You must not select more than four of Feature 8130, or one of Feature 9590; you can select them only for shipment with the device from the manufacturing plant.

You can also order optional features against the IBM 3590-B11 for data or cleaning cartridges, and cartridge magazines. They may be ordered for shipment with the IBM 3590 devices as well as after installation:

- **8001** for one IBM 3590 cartridge magazine (order up to 10)
- **8002** for one IBM 3590 cleaning cartridge (order up to 10)
- **8003** for 30 IBM 3590 Magstar tapes (order up to 99 features). Feature 8003 is for field installation only; if you want cartridges shipped with the device, use Feature code 8130.

Note: The feature codes in this section refer to the IBM 3590-B11 model; there are no equivalent cartridge feature codes for the Model B1A drive. The Model B1A always resides in an IBM frame against which the relevant cartridge features can be ordered.

3.10.3 Cartridge Features for IBM 3590-C12

You must order one out of these three features for the IBM 3590 Model C12 frame:

- **8210** for a quantity of 210 IBM 3590 Magstar tapes
- **8220** for a quantity of 420 IBM 3590 Magstar tapes
- **9590** for no cartridges at all

It is mandatory to select one of these features when you order an IBM 3590-C12 frame. You must not select more than one of these features, and you can select them only for shipment with the frame from the manufacturing plant.

You can also order the optional feature **8002** for one IBM 3590 cleaning cartridge; up to 10 of these features may be ordered with the IBM 3590-C12 frame, both for shipment with the IBM 3590-C12 as well as after installation.

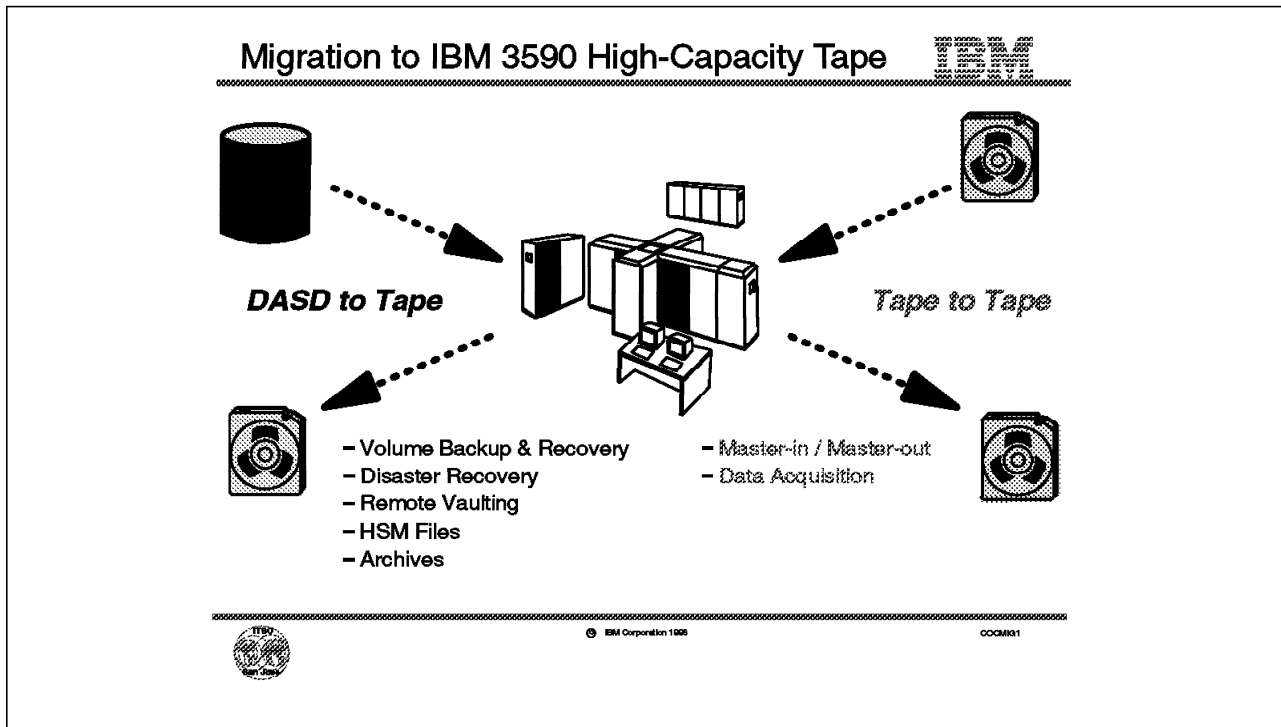

Figure 49. Migration to IBM 3590 High-Capacity Tape

3.11 Migration to IBM 3590 High-Capacity Tape

The higher capacity and performance of the IBM 3590, together with enhanced capacity library configurations, may eliminate the need to install additional automation and therefore represent a significant overall cost saving. Figure 49 illustrates the migration process.

3.11.1 Tape Applications for IBM 3590

IBM 3590 high-capacity tapes are well-suited to applications that have the capability of filling high-capacity (10-30 GB) tapes. The host software understands the full capability of the native IBM 3590 tape subsystem, unlike the IBM 3591 tape subsystem, which emulates the IBM 3490E. DFSMSHsm is a host application that can fully utilize large-capacity tapes; drastic reductions in tape usage have been seen in some customers.

Note: DFSMSHsm is also able to make full use of the IBM 3590 tapes in the IBM 3591 tape subsystem by making explicit changes to DFSMSHsm parameters to allow the percentage of tape usage to exceed 100%. However, tapes handled using, for example, Object Access Method (OAM) with the IBM 3591 tape subsystem were viewed as having only 3490E capacity and would not be filled.

For existing applications such as backup and restore, archive, disaster recovery, and the requirement for high-speed sequential application data sets, the benefit of using the IBM 3590 High Performance Tape subsystems is obvious. However, in addition, new applications such as remote vaulting, collection of seismic and scientific data, satellite telemetry, and other applications requiring high data rates can now be successfully addressed using the IBM 3590.

3.11.2 Migration Issues

To assist in data migration, the 3590 Model A00 with its associated Magstar 3590 tape drives can be intermixed with existing IBM 3490 models within either the IBM 3494 or IBM 3495 Tape Library Dataserver. This facilitates the migration to the new cartridge and drive.

The practical effects of moving to high-capacity tapes should be carefully considered with respect to, for example:

- Off-site tapes. How often are they removed? Will an application fill the tape before it is sent off-site? Will DFSMSHsm need to mark all the off-site tapes as “full” to ensure they are not continually requested for mounting from a remote vault?
- Data interchange. Does the interchange site have IBM 3590 technology? The IBM 3590 tapes cannot be read using the technology of IBM 3480, 3490, or 3490E drives.
- Performance. Are the performance characteristics of high-capacity tapes suited to the application? High-capacity tapes offer fast response for accessing large sequential files, but are not as good for random access to small files. It may take more time to retrieve the first byte of data.

Tape data sets and applications not suited to the native IBM 3590 ESCON environment may be candidates for migration to an IBM Magstar Virtual Tape Server. See Section 2.25, “Migration to the IBM Magstar Virtual Tape Server” on page 73 for more information about suitable candidates for the Virtual Tape Server.

The IBM 3590 High Performance Tape Drive is completely new; it is not compatible with other IBM tape subsystems. You cannot read from or write to this tape using IBM 3480, 3490, or 3490E tape subsystems. Nor can the IBM 3590 tape drive read from or write to previous IBM tape cartridge formats, whether 18- or 36-track format. In consequence, data is moved to the new cartridges by writing all new tape data sets to the new medium, recycling and allowing archive data to expire, or explicitly copying data.

The IBM 3590 cartridges written using the IBM 3591 subsystem emulating 3490E devices are in IBM 3590 tape format; they can be read and migrated directly to the native IBM 3590 ESCON environment. However, they will be listed as IBM 3490E datasets by the host system catalog, which means the host will not attempt to allocate them to the native ESCON IBM 3590 tape drives.

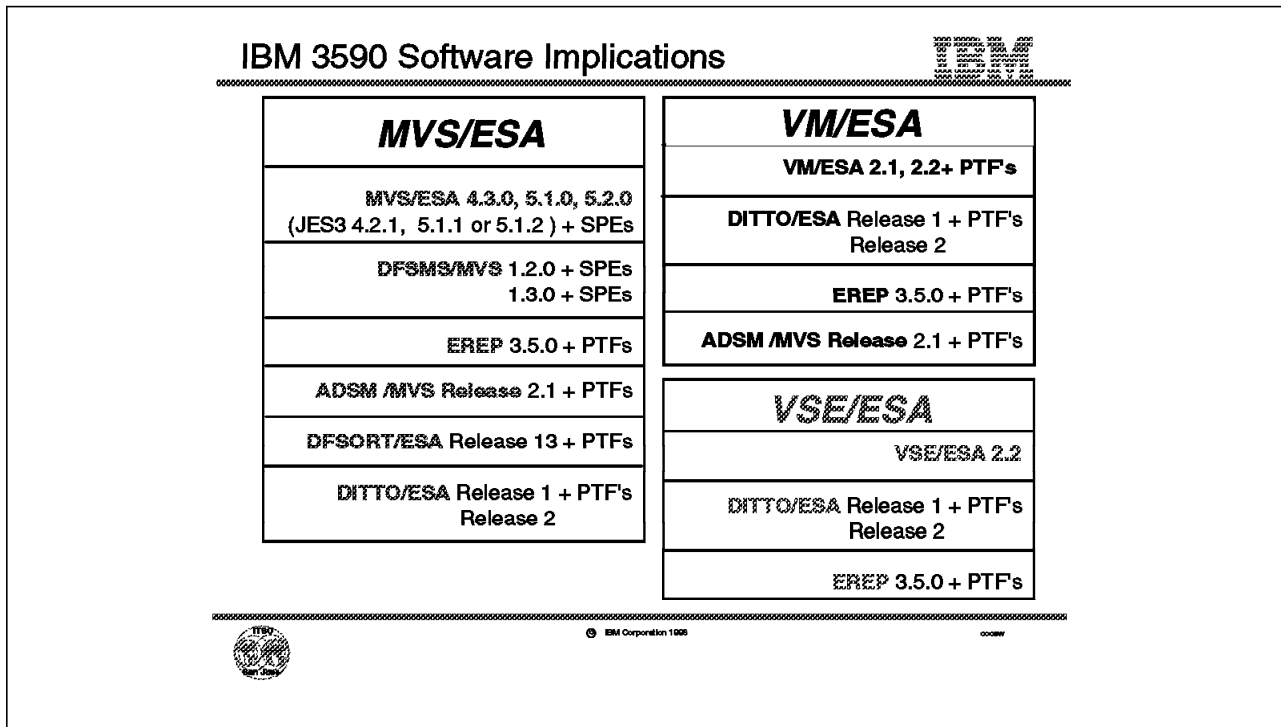

Figure 50. IBM 3590 Software Implications for S/390 Platforms

3.12 IBM 3590 Software Implications for S/390 Platforms

Figure 50 shows the software levels that support the IBM 3590 tape subsystem. The following subsections list the minimum software releases for IBM 3590 for S/390 platforms.

3.12.1 MVS/ESA

For MVS/ESA, the minimum software releases are:

- MVS/ESA SP 4.3 + SPE
- MVS/ESA SP 5.1.0 + SPE
- MVS/ESA SP 5.2.0 + SPE
- JES3 4.2.1 + SPE
- JES3 5.1.1 + SPE
- JES3 5.1.2 + SPE
- DFSMS/MVS 1.2.0 + SPE
- DFSMS/MVS 1.3.0 + SPE (available fourth quarter of 1996)
- EREP 3.5.0 + PTF
- ADSM/MVS Release 2.1 + PTFs
- DFSORT Release 13 + PTFs
- DITTO/ESA Release 1 + PTFs
- DITTO/ESA Release 2

3.12.2 VM/ESA

For VM/ESA, the minimum software releases are:

- VM/ESA Version 2.1 + PTFs
- VM/ESA Version 2.2
- EREP 3.5.0 + PTF
- DITTO/ESA Release 1 + PTFs
- DITTO/ESA Release 2
- ADSM/VM 2.1 + PTFs (available fourth quarter of 1996)

3.12.3 VSE/ESA

For VSE/ESA, the minimum software releases are:

- VSE/ESA Version 2.2 (available December 1996)
- EREP 3.5.0 + PTFs
- DITTO/ESA Release 1 + PTFs
- DITTO/ESA Release 2

3.12.4 Transaction Processing Facility (TPF)

For TPF, the minimum software release is TPF 4.1 plus PTFs and it is expected to be available third quarter of 1997.

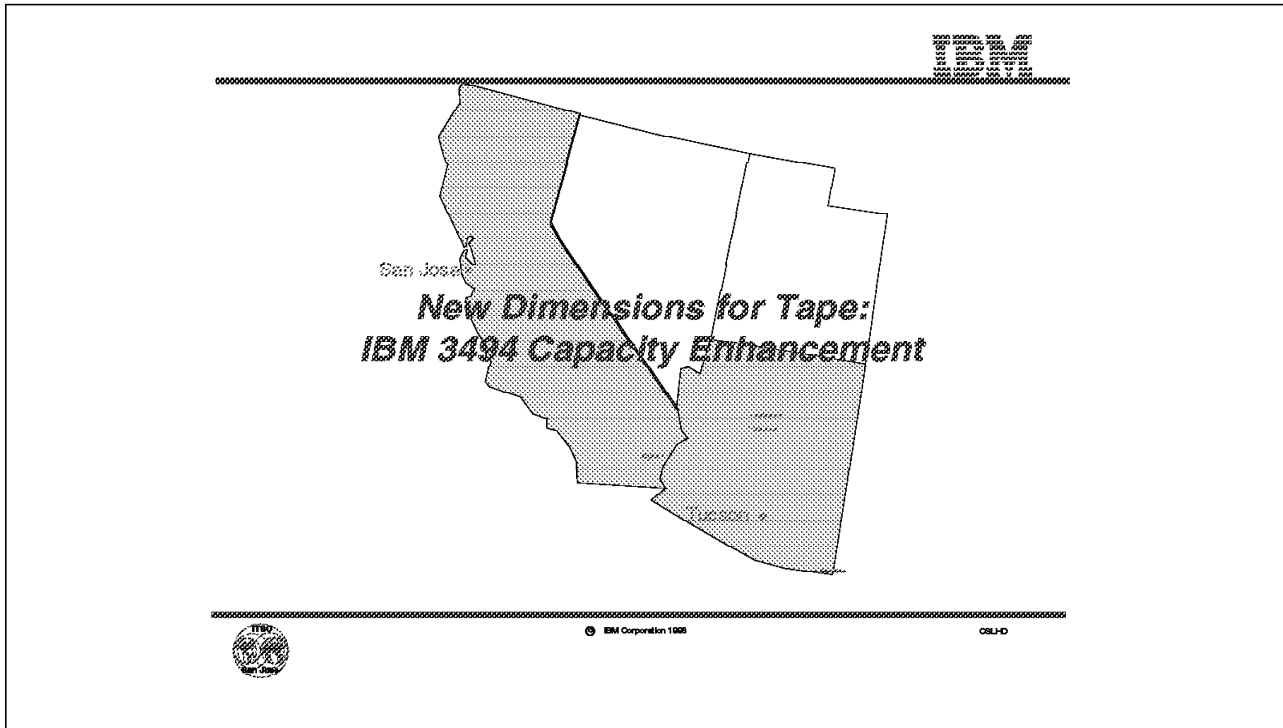

Figure 51. Title Slide for IBM 3494 Capacity Enhancement

3.13 IBM 3494 Tape Library Dataserver Capacity Enhancement

We describe capacity enhancements of the IBM 3494 Automated Tape Library Dataservers (Figure 51) in the following sections.

IBM 3494 Tape Library Dataserver



● IBM 3494 success

- ◆ Started as 600-cartridge midrange library and extended to 3040-cartridge, high-capacity solution
- ◆ Offers the benefit of a modular solution in a relatively small space
- ◆ S/390, ES/9000, AS/400, RS/6000 and Open Systems attachment

● But...

- ◆ Medium or large capacity tape libraries account for over half the automated tape library requirement
- ◆ Multiple IBM 3494s are being installed to achieve the required capacity

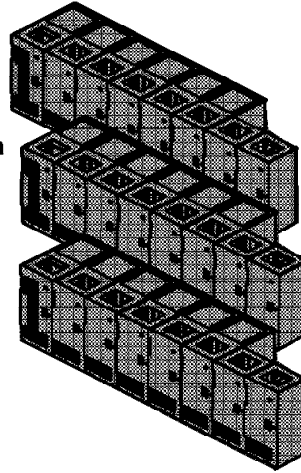

© IBM Corporation 1999

CSL/FEO

Figure 52. IBM 3494 Tape Library Dataserver Capacity Requirements

3.14 IBM 3494 Tape Library Dataserver Capacity Requirements

The IBM 3494 Tape Library Dataservers (Figure 52) are designed to be low-cost libraries providing an automated tape solution in a variety of system environments. The IBM 3494 supports the IBM 3490E model C tape drives, the IBM Magstar 3590 models, as well as the newly announced Virtual Tape Server.

Initially available with parallel or OEMI adapters and a capacity as low as 240 cartridges (subsequently with SCSI adapters and IBM Magstar support), the IBM 3494 proved highly successful for a variety of midrange customers. However, the relatively small footprint of the IBM 3494, ease of installation, and operation, together with the capacity expansion potential up to 3040 cartridges, have meant that it provided an appealing solution for high-end customers as well.

Since its announcement in September 1993, we have continued to develop and enhance the IBM 3494 in order to meet high capacity requirements including support for:

- High-capacity Magstar cartridges,
- High-performance Magstar drives,
- Larger library I/O stations,
- Increased numbers of drives, and
- Increased number of hosts.

Despite the large capacities possible with a single library (up to 91.2 TB compacted data), in some high-demand environments, customers are installing more than one IBM 3494 library to meet the increasing storage requirements. To address these needs, we have not only enhanced the IBM 3494 further with the new Model B16 Virtual Tape Server (described in Chapter 2, "The IBM Magstar

Virtual Tape Server” on page 17), but also expanded the cartridge and drive capacity of the library.

IBM 3494 Expanded Capacity



*Expanded cartridge
and drive capacity*

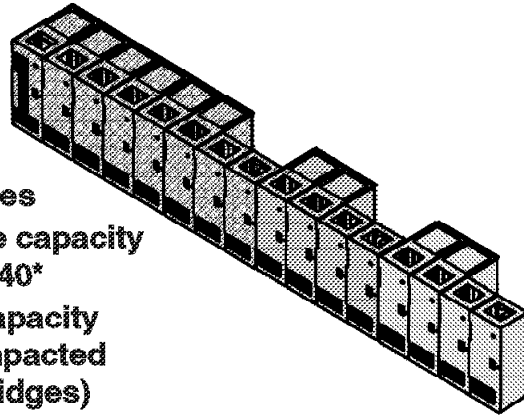

- Extends to 16 frames
- Increases cartridge capacity from 3040 up to 6240*
- Extends storage capacity up to 187 TB* (compacted Magstar 3590 cartridges)

*actual cartridge storage depends on configuration



© IBM Corporation 1995

OSLCAPE

Figure 53. IBM 3494 Expanded Cartridge and Drive Capacity

3.15 IBM 3494 Expanded Cartridge and Drive Capacity

The IBM 3494 expanded cartridge and drive capacity (Figure 53) is expected to be available beginning January 30, 1997. It increases the maximum number of frames in an IBM 3494 Tape Library Dataserver from 8 to 16.

You can add two new fixed-frame configurations to an existing 8-frame library in the following way:

- Two IBM 3494-D12 or IBM 3494-D14 drive units and two IBM 3494-S10 Storage Units can be added to the base eight frames for a total of 12 frames, and then
- Two more IBM 3494-D12 or IBM 3494-D14 drive units and two IBM 3494-S10 storage units can be added for a total of 16 frames.

This increases the total number of IBM 3590-B1A tape drives that can be supported in an IBM 3494 to 46, and more than doubles the cartridge capacity to 6240 cartridges, (up to 187 TB compacted data). This is important in those high-demand environments where data storage requirements are increasing and there is a desire to improve operator productivity by reducing the amount of tape handling.

Thus, through the use of both virtual and real capacity enhancements, the IBM 3494 Tape Library Dataserver has dramatically increased its data storage capacity for new and existing customers.

IBM 3494 Current Enhancements



Builds on high-capacity options available today:

- **30-cartridge input/output (Feature 5230)**

- **Support for 16 control units (Feature 5228)**

- up to 16 IBM 3590-B1A tape drives in a SCSI environment
- up to 46 IBM 3590-B1A tape drives in an ESCON environment
- up to 24 IBM 3490E tape drives in an ESCON, parallel, or SCSI environment

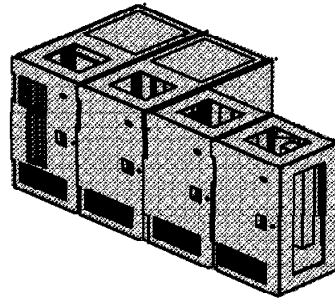

© IBM Corporation 1998

CSL0AP1

Figure 54. IBM 3494 Current Capacity Enhancements

3.16 IBM 3494 Current Capacity Enhancements

The IBM 3494 expanded capacity option (Figure 54) builds on previous enhancements to the library which were a response to customer requirements for additional flexibility in library configuration:

- **30-cartridge I/O station.**

The IBM 3494 library unit frame supports a 30-cartridge I/O station feature, which can be installed optionally as an alternative to the 10-cartridge Convenience I/O Station, by selecting Feature 5230 on the IBM 3494-L1x model. The 30-cartridge unit is installed in the library unit door and is operated in the same manner as the 10-cartridge I/O feature. It reduces the overall capacity of the library by 80 cartridges, rather than 40 with the 10-cartridge I/O station. The larger I/O station allows customers to remove or insert more cartridges without stopping the robot accessor as frequently and is of benefit to customers who use large numbers of cartridges for disaster backup/recovery operations.

- **Support for 16 control units.**

The drives in the IBM 3494 library communicate with the Library Manager, to report status or to route Perform Library Function (PLF) commands from an ESCON or parallel attached host, using RS-422 connections inside the library. To send commands to the library, SCSI-attached hosts need a separate external connection to the Library Manager (as well as the connection through the drives); this can be achieved by a direct RS-232 connection from each SCSI host or by a LAN connection. There are a limited number of RS-232 and RS-422 adapters in the Library Manager and this in turn limits the number of tape control unit functions supported in any IBM automated library.

The maximum number of tape control units that can be attached to the IBM 3494 library is 16. This is of most benefit in SCSI-attached environments with IBM Magstar 3590 High Performance Tape Subsystems where each drive uses one RS-422 attachment. This limit is independent of the total number of frames installed in an IBM 3494 (the maximum supported number of frames is 16).

The number of RS-232 and RS-422 is chosen by selecting a combination of Features 5228 and 5229. The candidates for selection are explained below and the combinations summarized in Table 4 on page 118:

– ***Neither Feature 5228 nor 5229***

The Library Manager has four RS-232 connections and four RS-422 connections supplied as standard. Thus it supports up to four tape drive control units and up to four externally connected SCSI hosts (for example RISC/6000 or AS/400).

– ***One Feature 5229***

Feature 5229 adds a further four RS-232 plus four RS-422 connections to the Library Manager which will then support up to eight control units and eight SCSI hosts.

Note: This feature is required if a Virtual Tape Server is included in the IBM 3494 configuration.

– ***One Feature 5228***

The addition of one Feature 5228 converts four of the available external RS-232 SCSI-host connections into four internal RS-422 control unit connections. If selected on the standard frame (without Feature 5229) you will have eight control unit attachments and no RS-232 host attachments for SCSI hosts. If selected in addition to Feature 5229 you will have 12 control unit attachments and four RS-232 host attachments for SCSI hosts.

Note: This feature is required if a Virtual Tape Server is included in the IBM 3494 configuration.

– ***One Feature 5229 with two Features 5228***

If two Feature 5228s are selected in addition to Feature 5229, you will have 16 control unit attachments (the maximum) and no RS-232 host attachments for SCSI hosts.

Note: This combination will not support the Virtual Tape Server. One of each Feature 5229 and Feature 5228 is required.

If the tape control unit expansion feature converts all RS-232 connections to RS-422 tape control unit connections, a Library Manager LAN adapter card will be required to provide SCSI host attachment. Order Feature 5219 for Token ring or Feature 5220 for Ethernet; both TCP/IP and APPC protocols are supported.

<i>Table 4. Supported Configurations for the IBM 3494 expansion features</i>			
Features	Available RS-232 ports	CU connections	Available SCSI host connection
None	4	4	RS-232 or LAN
5229	8	8	RS-232 or LAN
5228	0	8	LAN only
5229 + 5228	4	12	RS-232 or LAN
5229 + 2*5228	0	16	LAN only

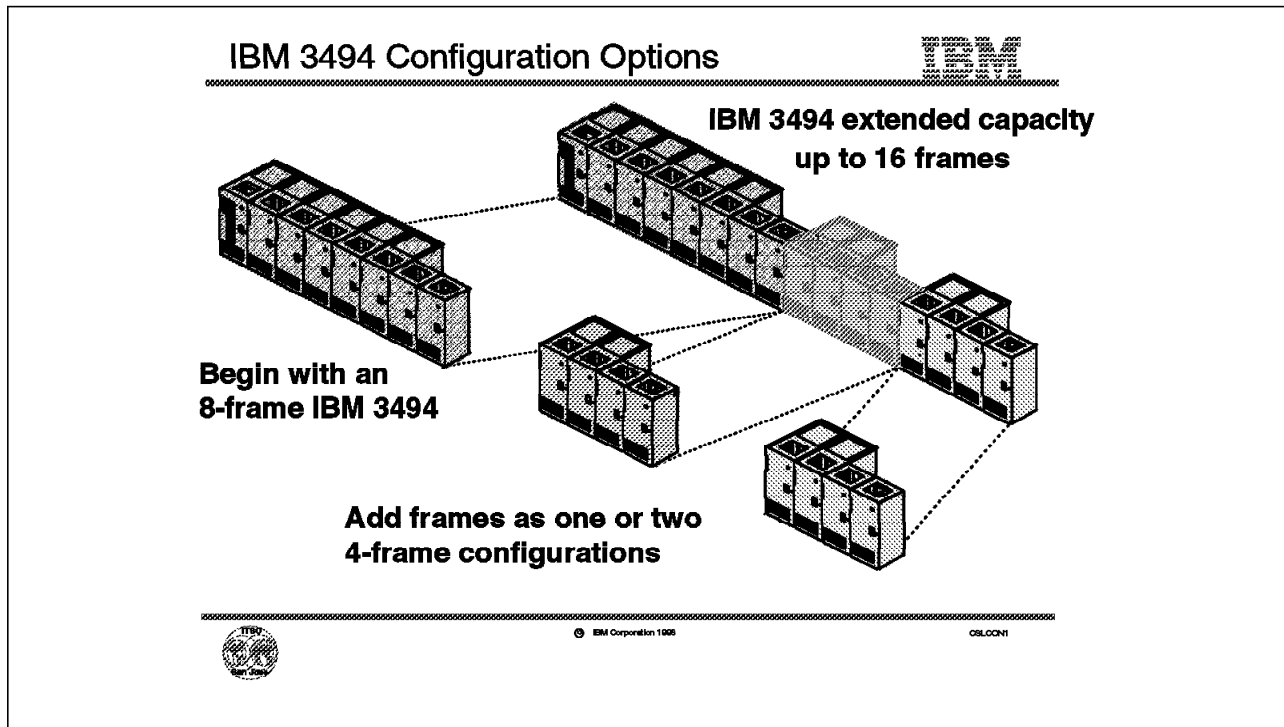

Figure 55. IBM 3494 Expanded Capacity Configuration Options

3.17 IBM 3494 Expanded Capacity Configuration Options

As described earlier, the expanded capacity options (Figure 55) will be available initially in two fixed-frame configurations. The first eight frames of the IBM 3494 library should be configured as usual; basically, any frame combination is acceptable. If a Virtual Tape Server is part of the configuration, then it is installed in the first eight frames. To expand the IBM 3494 capacity, up to two fixed four-frame configurations (consisting of two drive unit Models D1x and two storage unit Models S10) may be added to give a total of 16 frames.

These fixed configurations mean that the overall limit for drive unit frames (of any model) is 11. The maximum number of drives depends on the attachment protocol and control unit functions. To achieve the maximum number of drives in the expanded capacity library, you will need some combination of Features 5228 and 5229, as explained earlier in Section 3.16, "IBM 3494 Current Capacity Enhancements."

3.17.1 Cartridge and Drive Unit Maximums

The different IBM 3494 environments are described below:

- IBM 3590 ESCON-attached

If all 11 drive units are fully configured Model D14s with a library unit Model L14, then the maximum number of Magstar drives is 46 (12 control unit functions, using the IBM 3590-A00).

- IBM 3590 SCSI-attached

If all the drives are SCSI-attached using IBM 3494-D12s, then, because the IBM 3494 supports a maximum of 16 control unit functions, the maximum number of IBM 3590-B1A tape drives is 16. If you want a 16-frame

configuration you need one IBM 3494-L12 plus eight storage unit frames, then two fixed-frame configurations with four IBM 3494-D12 frames each; the 16 IBM 3590-B1A tape drives could be spread between the drive frames.

- IBM 3490E SCSI-, ESCON-, or parallel-attached

If all 11 drive units are fully configured IBM 3494-D10s with a library unit IBM 3494-L10, then the maximum number of 3490E tape drives is 24 (12 control unit functions, using the IBM 3490-C2A).

- Capacity for all three environments

The maximum cartridge capacity for the eight-frame library is 3040, with one library unit frame and seven storage unit frames. Adding two fixed four-frame configurations, where the IBM 3494-D1x frames are left empty (with cartridge slots in place of tape drives), increases this capacity by 3200 slots, giving a potential maximum capacity of 6240 cartridges.

Note: It is easy to see that in mixed environments, with different host platforms sharing the library, you must take particular care in planning the IBM 3494 configuration.

3.17.2 New Features

The IBM 3494 library unit frame has features indicating the host platforms to which it is attached, and indicating how many drive and storage units make up the whole library. IBM keeps a record of this information with the serial number of the library so that, for example, the proper internal cable for the accessor will be supplied, both for a new library and for future upgrades. The attachment features are slightly different for the expanded capacity library:

- ***Storage unit attachment, Feature 9002***

For every IBM 3494-S10 storage unit in the first eight frame positions in the library, at least one Feature 9002 must be applied to the IBM 3494-L1x model, up to a maximum of seven.

- ***Storage unit attachment, Feature 9004***

For every IBM 3494-S10 storage unit in frame positions 9 through 16 in the library, one Feature 9004 must be applied to the IBM 3494-L1x model, up to a maximum of four (because the expanded capacity model currently supports a maximum of four storage units).

- ***Drive unit attachment, Feature 9003***

For every IBM 3494-D1x drive unit in the first eight frame positions in the library, one Feature 9003 must be applied to the IBM 3494-L1x model, up to a maximum of seven.

- ***Drive unit attachment, Feature 9005***

For every IBM 3494-D1x drive unit in frame positions 9 through 16 in the library, one Feature 9005 must be applied to the IBM 3494-L1x model, up to a maximum of four. The expanded capacity model currently supports a maximum of four drive units.

- ***Virtual Tape Server attachment, Feature 9006***

If the library includes a Virtual Tape Server, then one Features 9006 must be applied to the IBM 3494-L1x model. This is currently limited to one per L1x model.

3.17.3 Installation Considerations

To expand the capacity of the library, either by adding frames or by installing a Virtual Tape Server, it may be necessary to change the position of the frames in an installed library. If this is the case, or if frames are moved from one IBM 3494 to another, an RPQ must be processed before the IBM 3494 libraries can be reconfigured. This RPQ is required for reconfiguring Features 5300, 5302, 5304, and 5400, or IBM 3494 Models B16, D10, D12, D14, and S10. This ensures that IBM can make the proper internal library cables available to support the new configuration, as well as preparing for future changes and enhancements.

Increasing the number of frames in the IBM 3494 library to 16 does not impose any additional software requirements.

IBM 3494 Capacity Summary

IBM

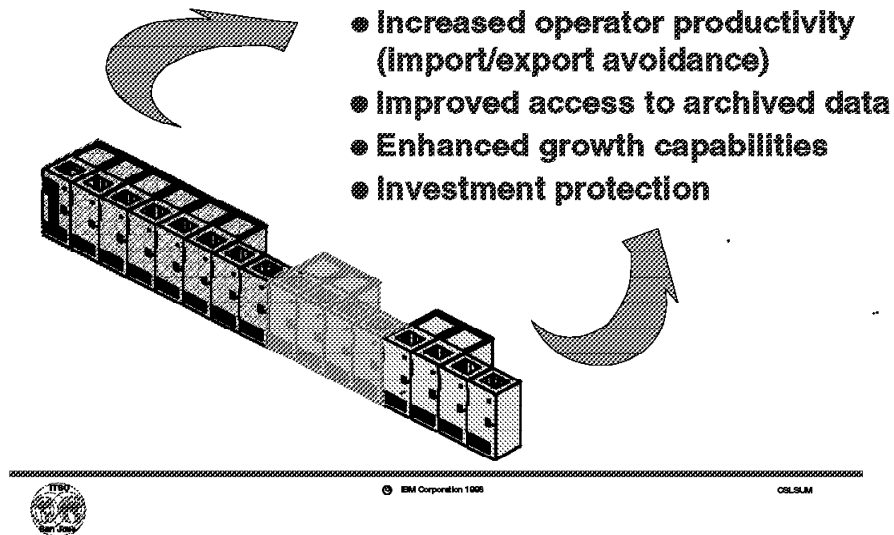

Figure 56. IBM 3494 Expanded Capacity Summary

3.18 IBM 3494 Expanded Capacity Summary

Increasing the capacity of the IBM 3494 (Figure 56) means that:

- More volumes will reside in the library, so the number of necessary imports and exports will be reduced, thereby improving operator productivity.
- You have the opportunity to automate access to archive data and thus provide faster service, improving user productivity.
- You can potentially meet growth requirements with a single IBM 3494 library, providing greater flexibility to share the resources, and ease of management.
- You can build on your current IBM 3494 investment by upgrading, taking advantage of new technology, and expanding capacity.

Chapter 4. IBM 3570 Magstar MP Tape Subsystem

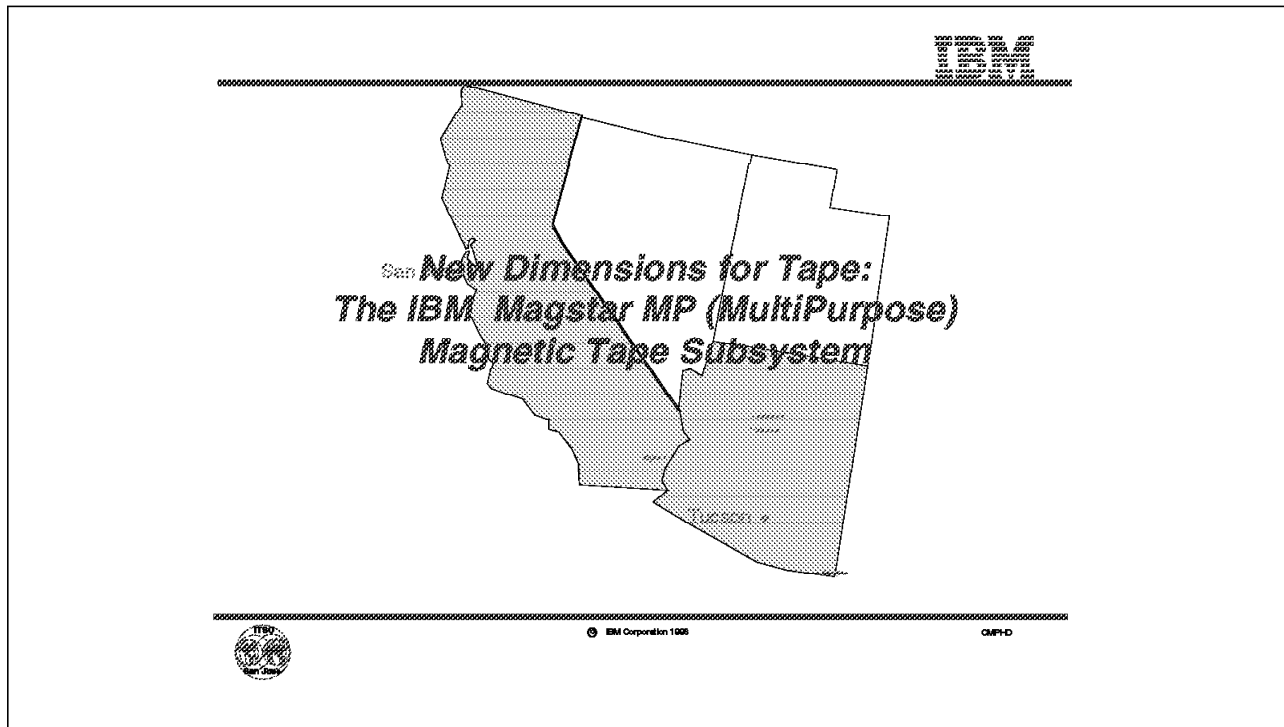

Figure 57. Title Slide for the IBM 3570 Magstar MP Tape Subsystem

This chapter introduces the new IBM 3570 Magstar MP Tape Subsystem (Figure 57), and also describes the models now available.

IBM 3570 Magstar MP Tape Subsystem



- **Fast access to data**
- **High reliability using Magstar technology**
- **Designed for automation**
- **High capacity and performance for mid-range platforms**
- **SCSI-2 attachment**
- **New two-reel cartridge**

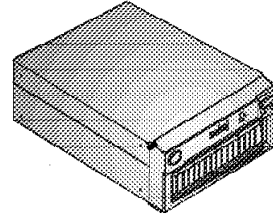
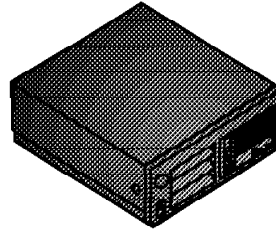

© IBM Corporation 1988

OMPNT

Figure 58. Introducing IBM Magstar MP Tape Subsystem

4.1 Introduction

The IBM Magstar MP is a compact, integrated storage device that significantly expands the functional utility of tape, optimizing both write and read-intensive operations (Figure 58). The IBM Magstar MP promises to bring a new dimension to tape storage because of its revolutionary data recall performance, allowing new applications to be enabled in addition to traditional tape applications. Its advantages include these:

- Fast access to data

The IBM Magstar MP has been designed to provide fast access to data. The drive and cartridge have been uniquely designed to allow fast cartridge insertion, almost instantaneous head/tape contact at load time, and midpoint load; where the tape is already positioned to achieve fast data access by moving quickly to the data in either direction.

The data is buffered in the drive, which means that the read and write speed can be balanced, and the drive is designed to provide high performance in both streaming and start/stop operations. These characteristics are exciting new technical advances in an environment where innovation has in the past meant only increased cartridge capacity and data rate.

When operating in a library mode, the leading-edge characteristics of the IBM Magstar MP offer new possibilities for data retrieval. The revolutionary data-recall capabilities result from:

- Fast average exchange time of 6 seconds.
- No threading around a tape path.
- Average access of 4 seconds to first byte of data.
- 5 m/s high-speed search.
- Midpoint tape cartridge load.

- Fast rewind and unload, because the tape stays in the cartridge.

Data retrieval actions taking minutes on other tape media take only seconds on IBM Magstar MP. At last, tape can be legitimately called near on-line storage.

- High reliability using Magstar technology.

The IBM Magstar MP provides outstanding reliability and offers high quality technology, already proven on the IBM 3590 Magstar family, but previously affordable only in the large systems environment.

The tape medium itself is a high-coercivity metal particle tape that has very reliable data retention capabilities. To ensure the accurate and consistent reading of the 128 tracks of data, the latest generation of IBM's magneto-resistive (MR) heads is employed. Heads and tracks are continuously synchronized using servo tracks on the medium to maintain read and write data integrity.

The linear cartridge tape is of a new design enclosed in an exceptionally strong case offering a dust-free environment. At no time is the tape removed from the cartridge, so the possibility of attrition of the medium through contact with wheels, pinions, channels, or recording drums is minimized. The cartridge door opens when the cartridge is inserted into the drive and the tape comes into contact directly with the recording heads, giving the system immediate access to the data. To ensure cleanliness of the heads, a cleaning cartridge is included inside all libraries; cleaning is done automatically.

Data is your most valuable asset, and much of it resides on magnetic tape. It is very important that it be available when required. The IBM Magstar MP sets new standards of reliability and data integrity.

- Designed for automation.

The IBM Magstar MP is the very first tape drive designed for automation while fulfilling all the requirements of a basic backup device. It offers both a sequential mode for traditional tape processing applications and a random mode for applications requiring direct access to data. The library operates with two 10-cartridge magazines providing from 100 to 300 GB of data accessible to the host system.

As your processing and storage management requirements change, this tape subsystem can evolve from a conventional solution for data backup into an automated tape library, using the SCSI-3 Move Media Command set already present in the IBM operating systems OS/400 and AIX. A fully intelligent tape library with automated data migration to and from the library can be achieved by the addition of a storage management software solution such as Backup Recovery and Media Services/400 (BRMS/400) for the AS/400 or ADSTAR Distributed Storage Manager/6000 (ADSM/6000) for the RISC System/6000.

The IBM Magstar MP library models were designed specifically to exploit the fast performance and match the reliability of the IBM Magstar MP drive. They have been extensively tested and tuned to handle the rigorous demands of automated tape handling.

- High capacity and performance for midrange systems.

The IBM Magstar MP Tape Subsystem has been specifically designed to provide midrange environments with a tape subsystem that has high levels of reliability and performance, attaching only to SCSI-2 adapters. It is based

on the same reliable Magstar technology as the IBM 3590 High Performance Tape Subsystem, but with a lower price, capacity, and performance than the IBM 3590. The IBM Magstar MP tape subsystem addresses the growing storage needs of midrange customers by offering a more durable technology that is designed to meet the tougher demands of automation.

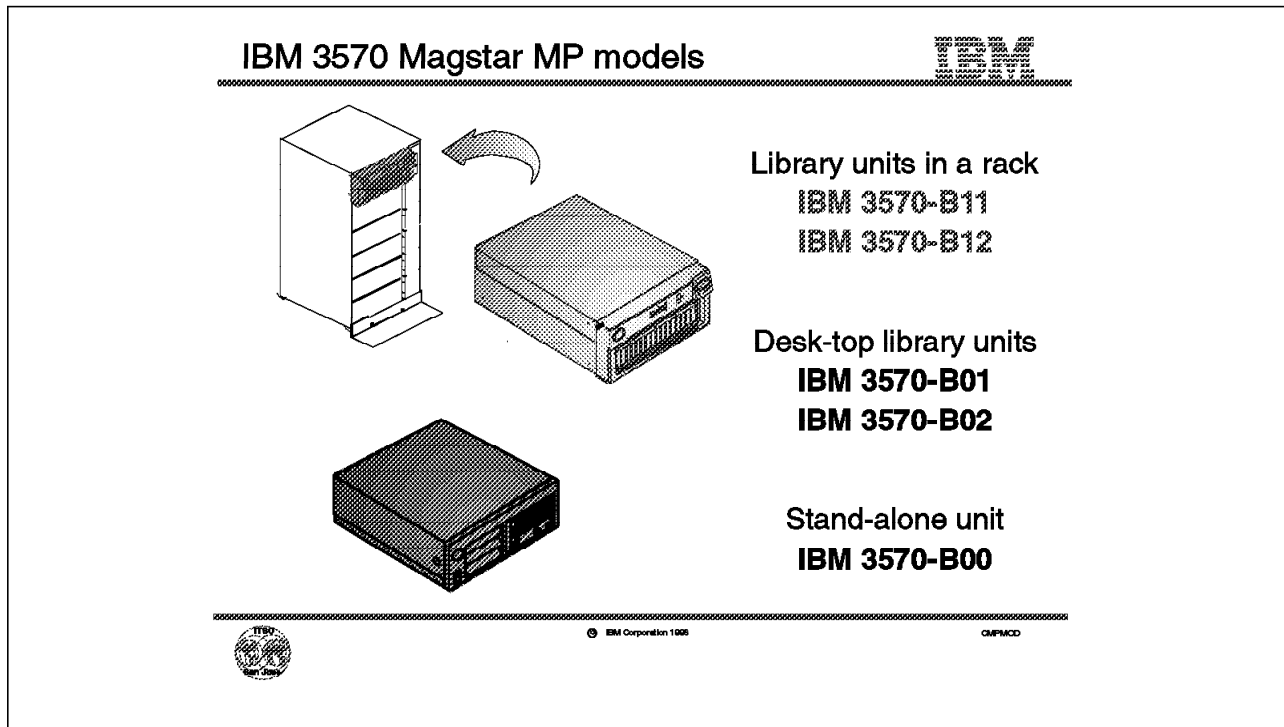

Figure 59. IBM 3570 Magstar MP Models

4.2 IBM Magstar MP Models

There are five IBM Magstar MP models (Figure 59) intended to be housed in a standard rack or for desk-top use:

- **IBM 3570-B00**

The Model B00 is a single-drive desk-top unit, available with black covers. It is attached to the host using a SCSI cable, and requires its own power cord.

- **IBM 3570-B01**

The Model B01 is also a single-drive desk-top library unit, but includes an autoloader, thus providing automated library functions. It is attached to the host using a SCSI cable, and requires its own power cord. Black or white covers may be specified.

- **IBM 3570-B02**

The Model B02, is like the Model B01, is a desk-top library unit, but with two drives. Like the Model B01, it is attached to the host using a SCSI cable, requires its own power cord, and is available with black or white covers.

- **IBM 3570-B11**

The Model B11 is a rack-mountable library unit with one drive. It requires five EIA units of space in an ANSI/EIA standard 19-inch rack. If space is available, it may be installed in an existing rack. It is attached to the host using a SCSI cable, and uses the power cord available with the rack. It is available with white covers.

- **IBM 3570-B12**

The Model B12 is, like the Model B11, a rack-mountable library unit but with two drives. It requires the same five EIA units of space, in a standard 19-inch rack, either existing or new. It is attached to the host using a SCSI cable, uses the power cord available with the rack, and is available with white covers.

IBM 3570 Magstar MP Single-Drive Model



- **IBM 3570-B00**
- **Single drive unit**
- **Manual operation**
- **Customer set up**
- **Installed horizontally or vertically**

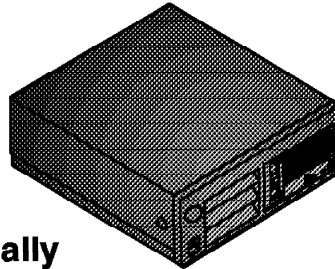

© IBM Corporation 1988

CMP800

Figure 60. IBM Magstar MP 3570-B00 Single-Drive Without Autoloader

4.3 IBM Magstar MP 3570-B00 Single-Drive Without Autoloader

The IBM Magstar MP single-drive model IBM 3570-B00 (Figure 60) is intended to be installed by the customer and used as a desk-top or floor-standing model. It can be installed horizontally or vertically.

The unit contains a single drive, with an integrated microprocessor control unit, and all necessary power and cooling components. The control unit contains the electronics and logic for reading and writing data plus control unit functions including management of the data buffer, LZ1 compression, error recovery procedures, and control of all tape drive operations and some channel operations.

The drive, which is the same type used in all the IBM Magstar MP models, attaches to a host system using a SCSI-2 adapter, supporting a data rate over the interface of 20 MB/s. The native drive data transfer rate is 2.2 MB/s, the maximum achievable for uncompacted data; the sustained or aggregate data rate overall with maximum compression (3:1) has been measured at 14 MB/s. The overall data rate achieved is dependent not only on the tape subsystem, but on many factors including applications, disk speed, and host performance.

The drive itself contains a compact loading mechanism that handles the new IBM Magstar MP Fast Access Linear Tape cartridge; this new cartridge is a different shape and uses a different format from previous IBM standards and is not compatible with them. Tapes are loaded into the drive manually, and the operator and service communications and message interface is handled by a combination of three LED indicators. See Section 4.8, "IBM 3570 Operator Panel" on page 136 and Section 4.9, "IBM 3570 Magstar MP Attention Messages" on page 139, for further details.

IBM 3570 Magstar MP Library Models

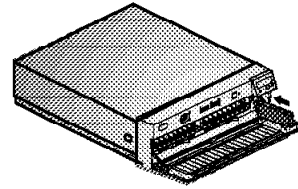

- **IBM 3570 Models Bx1, Bx2**
- **One or two drives**
- **Automated cartridge loading**
- **One or two 10-cartridge magazines**
- **Installed horizontally stand-alone or in a rack**

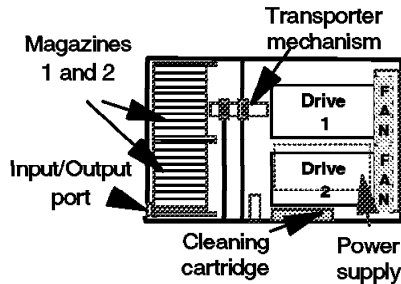

© IBM Corporation 1988

CMPE0X

Figure 61. IBM Magstar MP Library Model (with Autoloaders)

4.4 IBM 3570 Magstar MP Library Models

The other four IBM Magstar MP models (Figure 61) are all automated libraries supporting sequential and random-mode access to twenty cartridges from two removable 10-cartridge magazines; this can provide automated access to up to 300 GB of compacted data.

The library models use a cartridge loading and transport mechanism to automatically transport tape cartridges to and from the storage magazines and the tape drive. There is an LCD operator panel with control buttons, allowing selection of various menu options and information. The integrated control unit of the drive provides the electronics and logic for reading and writing the data, as well as controlling the library picker, and managing the operator display panel. The library units can be operated in three modes: automatic, random, and manual.

The IBM Magstar MP models IBM 3570-B01 and IBM 3570-B02 are desk-top library models with one and two drives, respectively. The IBM 3570-B11 and IBM 3570-B12 are for installation in a standard rack, and have one and two drives, respectively. All four library models are installed horizontally. The picture shows a desk-top model with the front panel of the automated cartridge loader folded down. The schematic diagram in Figure 61 shows a library model with two drives.

IBM 3570 Magstar MP Environmentals

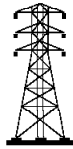

- Power source
 - 100-240 V ac
 - 50-60 Hz



- Class B device
 - 16-32 C
 - 8-80% humidity

DEVICE	DEPTH (mm)	HEIGHT (mm)	WIDTH (mm)	EIA Units	WEIGHT (Kg)	kVA
IBM 3570-B00	330	112	320	N/A	8.5	.06
IBM 3570-B01	771	217	483	N/A	40	.07
IBM 3570-B02	771	217	483	N/A	45	.07
IBM 3570-B11	714	217	444	5	24	.13
IBM 3570-B12	714	217	444	5	29	.13



© IBM Corporation 1985

01P5N

Figure 62. IBM Magstar MP Environmental Factors

4.5 IBM 3570 Magstar MP Environmental Factors

The physical and operating specifications are shown in Figure 62. Table 5 gives the dimensions in inches, the weight in pounds, and other specifications.

Table 5. IBM 3570 Environmental Specifications

IBM 3570 model	Depth (in.)	Height (in.)	Width (in.)	EIA units	Weight (lb)	Watts	Cal value (BTU/hr)
B00	13.3	4.4	12.6	N/A	19	60	205
B01/B02	30.4	8.5	19	N/A	40/45	70	239
B11/B12	28.1	8.5	19	5	24/29	130	444

Other factors of importance include these:

- **Power control**

Power control is provided by a power on and off switch on the front panel of the device. All models have LED indicators which light up for a short time when the power switch is on. The library models have an operator panel indicating that the power is on when the unit is active.

AC power is supplied from a wall outlet for the desk-top models, or from the rack for the rack-mounted models.

The IBM Magstar MP unit itself does not provide remote power control. If required, remote power control is provided by the enclosure or higher level subassembly.

- **Input voltages**

The IBM Magstar MP is designed to accept a wide variety of input voltages and frequencies; from 100-127 V ac (nominal) or 200-240 V ac (nominal), and from 50 Hz (nominal) to 60 Hz (nominal). The device will automatically adjust itself for proper operation when presented with any combination of these voltages and frequencies.

- **Cooling requirements**

The IBM Magstar MP devices are designed to operate in an office environment. The noise levels are 55 decibels idle and 58 decibels operating.

The units require ambient temperatures that are consistent with the environmental specifications for a Class B extended operating and shipping environment. One cooling fan is used to cool the drives and another to cool the power supply. The air inlets for the fans must not be obstructed.

IBM 3570 Magstar MP Library Magazine



10-cartridge magazine

Cartridges in import and export positions

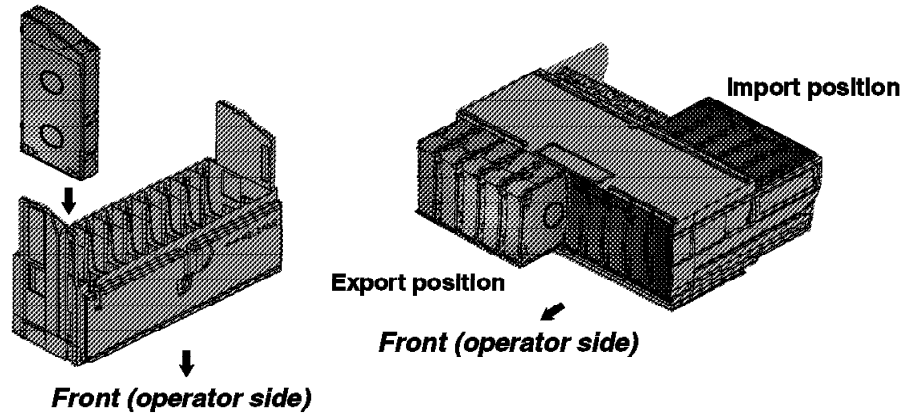

© IBM Corporation 1995

CMPMA0

Figure 63. IBM 3570 Magstar MP Library Magazine

4.6 IBM 3570 Magstar MP Library Magazine

The cartridge magazine is for use with the library models. You can use the libraries with one or two magazines. Each magazine contains up to ten cartridges, giving the library an overall capacity of twenty cartridges.

A cartridge lock is built into the magazine to hold the cartridges in place. The lock is released when the magazine is in position in the library. Cartridges can be loaded into the magazine outside the library, as shown in Figure 63, by releasing a latch on the magazine.

The cartridges are stored in the magazine in either the import or the export position, as shown in Figure 63. In the import position, the cartridge transport mechanism can access the cartridge, but the operator would have difficulty removing the cartridge. The export position is used when the library is in manual or automatic mode (see Section 4.10, "IBM 3570 Magstar MP Library Modes of Operation" on page 140 for information on the library modes). The transport mechanism moves processed cartridges to the export position so that the operator can easily identify them for removal.

IBM 3570 Magstar MP Library Loader

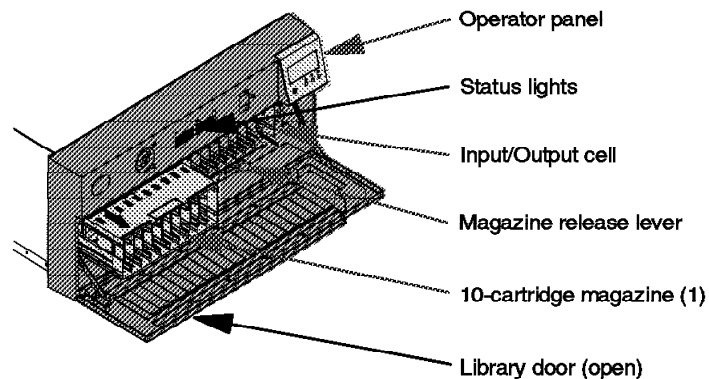

© IBM Corporation 1985

CMPACL

Figure 64. IBM 3570 Magstar MP Library Loader

4.7 IBM 3570 Magstar MP Library Loader

The features of the IBM Magstar MP Library Loader are discussed below.

4.7.1 Library Door

Figure 64 shows the automated cartridge loader of the library unit. Part of the front cover forms the library door, shown folded down, revealing the cartridge magazines and slots. Cartridge motion ceases when the door is opened. If a cartridge is being processed in the drive, processing will continue until the transport mechanism is requested to return the cartridge to its cell.

4.7.2 Magazine Release Lever

There is a release lever under each magazine. To insert a magazine into the library, open the door; put the lever in the open position (to the right); slide the magazine in (with its own release latch to the bottom) until it is fully seated; move the magazine release lever back to the left; then close the library door. To remove a magazine, reverse the procedure.

4.7.3 10-Cartridge Magazines

Two magazines are fitted into the library models of the IBM Magstar MP, as described above. Figure 64 shows a magazine being seated into Position 1, while Magazine 2 is already in place.

Cartridges may be removed from the magazine inside the library by opening the library door and taking out those in the export position (partly ejected). New cartridges are inserted in the correct orientation and flush with the front of the magazine (the import position).

4.7.4 Input/Output Cell

The right-most cartridge slot is used as a priority cell or an input/output port, depending on the library mode. In automatic mode, the operator can supply additional external cartridges to an application by using the priority cell instead of opening the library door; in random mode, however, the priority cell is used as an import/export station to add or remove cartridges from the library because the library door is kept closed.

To use the priority cell, Magazine 2 must always be present and the right-most cell must be left empty. When using the priority cell, the cartridge must be placed in the import position or it will not go in and a check condition will occur.

4.7.5 Operator Panel and Status Screen

All the models have status lights on the front of the unit. Model B00 uses the lights in different combinations to communicate the status of the unit to the operator. The library models show: "priority cell in use," "magazine 1 in use," and "magazine 2 in use."

The library models have an operator panel located to the right of the door. It provides a menu-driven operator and service display interface, using a liquid crystal display (LCD) operator status screen, which is described in Section 4.8, "IBM 3570 Operator Panel" on page 136,

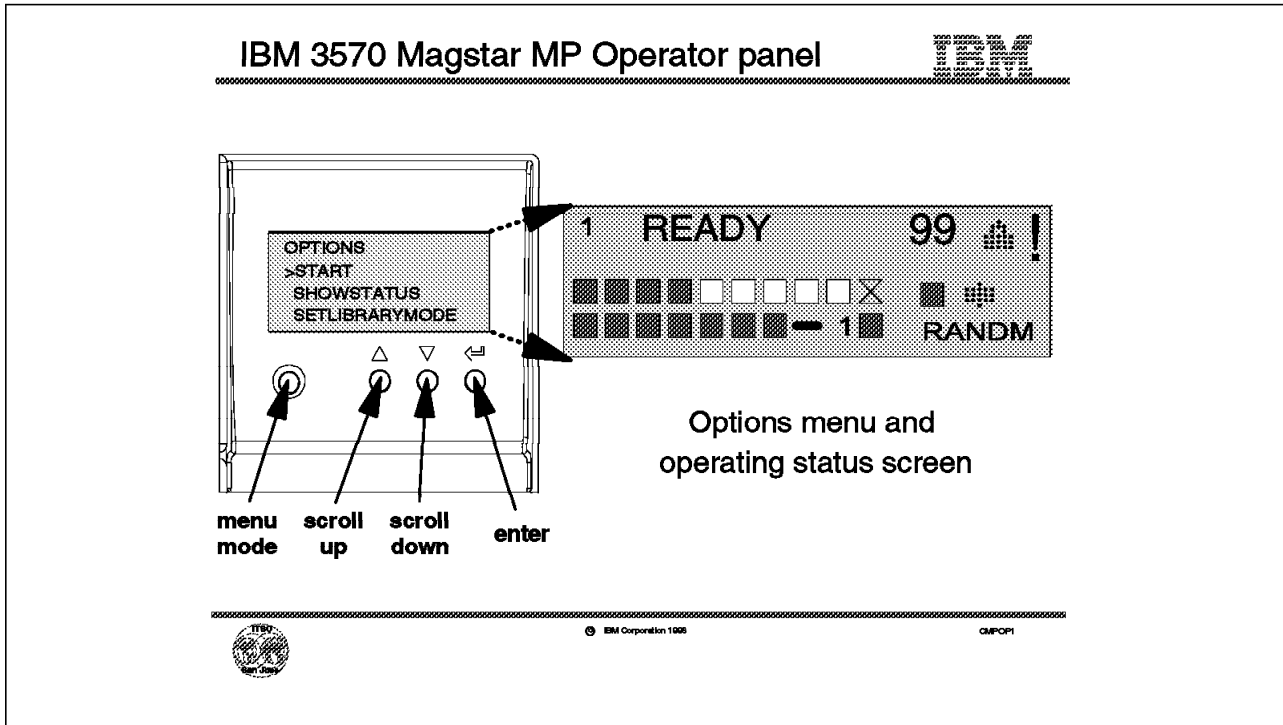

Figure 65. IBM Magstar MP Library Model Operator Panel

4.8 IBM 3570 Operator Panel

Figure 65 shows the operator panel for the library models and the LCD screen, which is 58 mm by 25 mm (2.3 in. by 1 in.) in size.

4.8.1 Options Menu

Menu options are displayed on the screen shown in Figure 65, and are selected by using the Scroll Up and Scroll Down buttons, and then pressing the Enter button.

The menu mode button is used to select service mode; at power on it is in operator mode. It is recessed slightly to avoid inadvertent selection during normal operation. When pressed, the message Warning – Service Personnel Only will appear, and you can cancel the operation if required.

4.8.2 Operating Status Screen

In Operator mode, four types of screens are displayed on the operator panel:

- **Status screen**

This is the default screen in operator mode, and is illustrated in Figure 65.

- **Intervention screen**

When operator intervention is required in Operator mode, the Status screen is overlaid by the Intervention screen. Examples of this screen are shown in Figure 66 on page 139. For example, FID1, FID2, FID3, FID4, Attention, Mount, De-mount, and Clean messages are intervention screen messages.

- **Supplemental screens**

Some menu-option screens and intervention screens have supplemental status screens that further describe the condition or requirement and provide clarification. For example, ATTENTION DRIVE errors are caused by conditions that the operator should be able to resolve without the necessity of a service call. In these cases, pressing the **Enter** button will cause a supplemental message to appear that will further clarify the nature of the problem.

- **Menu screens**

These screens are used in Operator mode and allow the operator a method to select various actions.

The status screen (the default) on the library models provides a view of the current operational status of the transport mechanism and drive. If some other screen is the current display and you want to check status, select this screen from the Options menu and select **Show Status**. Messages and indicators appear on four line positions on the status screen:

- **Line 1**

The first line displays the status of Drive 1. The number 1 on the first line indicates that the remainder of this line of text refers to Drive 1.

At character positions 2 through 10, a word such as READY is displayed to indicate a brief status of the drive (for example, cleaning, ready, loading, locating, reading, writing, erasing, rewinding, unloading, load pt, accessing, xferring, diag run, ucode ld).

Positions 12 and 13 indicate the percentage of media that has been processed.

Position 15 is a lock that indicates the status of the file-protect switch on the cartridge currently loaded. An open or closed padlock indicates whether the file-protect switch is in the allow-write position or the write-prevent position.

Position 16 when the exclamation point (!) is displayed, indicates that a dump is available. A dump contains detailed information about device operation at the time of a failure.

- **Line 2**

The second line displays the status of Drive 2.

- **Line 3**

Positions 1 through 10 indicate the state of the ten storage cells associated with Magazine 1 (the magazine on the left). A solid pattern indicates that a cartridge is present and that it is fully inserted into the import position; that is, accessible to the transport mechanism. An open pattern indicates that a cartridge is present, but that it is in the export position; that is, not fully inserted and therefore not accessible to the transport mechanism. A number "n" indicates that the cartridge is in Drive n. A dash (-) indicates that no cartridge is present in that position of the magazine. An hour-glass shape (an X filled in at the top and bottom) indicates that the IBM Magstar MP has not determined the status of a magazine cell.

Position 12 indicates the status of the cleaning-cartridge storage cell located inside the IBM Magstar MP subsystem. A solid pattern indicates that the cleaning cartridge is in the storage cell.

Position 14 indicates the transport mechanism status; that is, if the transport mechanism is moving, a gripper is shown (as at 16). If a cartridge is being moved, a horizontal line appears between the fingers of the gripper, as shown in Figure 65 on page 136.

- **Line 4**

Positions 1 through 10 indicate the state of the ten storage elements associated with Magazine 2 (the magazine on the right). Figure 65 on page 136 indicates that the tape cartridge at Position 9 is in Drive 1. The significance of the symbols or characters in each position on Line 4 is the same as on Line 3.

Position 10 is the priority cell where the operator can load a cartridge when a priority mount command occurs.

Positions 12 through 16 display the transport mechanism mode (AUTO, MANL, or RANDM) for the library unit. During a power-on reset before the microcode can determine the mode set in its memory, NONE is displayed.

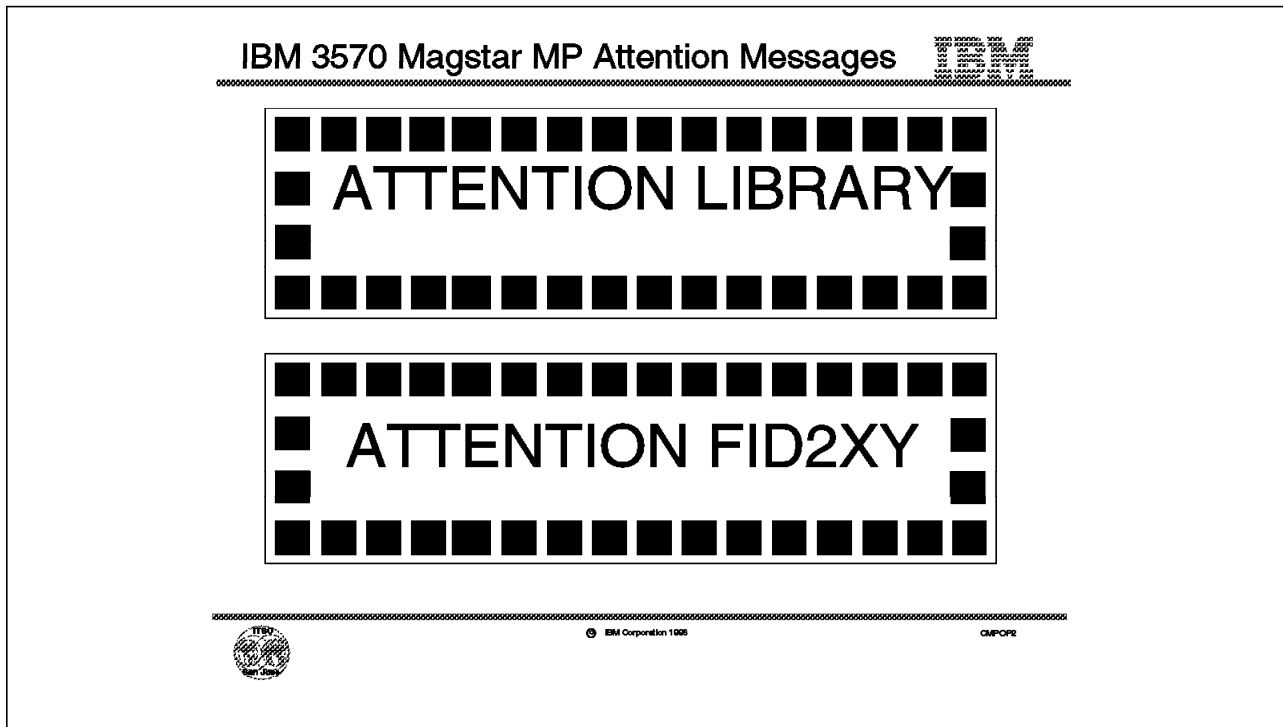

Figure 66. IBM Magstar MP Library Model Operator Panel Attention Messages

4.9 IBM 3570 Magstar MP Attention Messages

Intervention messages are presented on the operator panel in the intervention screen. The intervention screen consists of a message displayed in a screen with a black border (Figure 66). The message types are these:

- An FID1 message is generated when a hardware failure occurs within the device and a service engineer must be called; it has priority over all other types of message; it remains until the **Enter** push button is pressed.
- Attention messages indicate error conditions that you may be able to resolve, for example **no magazine** or a defective cartridge.
- Routine messages consist of messages received from the host through the SCSI Display Message command, for example, MOUNT, DISMOUNT.
- FID2 and FID3 messages indicate that the drive is in a degraded state but can still be used; for example, that the Magazine 1 present sensor is defective.
- An FID4 message indicates that some service circuitry failed.

IBM 3570 Magstar MP Library Modes



- ◆ **Manual**
 - ◆ Operator initiates load
 - ◆ Cartridge replaced in original cell
 - ◆ One cartridge processed for each operator action
- ◆ **Automatic (sequential)**
 - ◆ Transport mechanism initiates load from next cell
 - ◆ Processing begins at right-most cell
 - ◆ Cartridge replaced in original cell
- ◆ **Random**
 - ◆ Initiator controls self-contained library
 - ◆ Source and destination cell controlled by initiator
 - ◆ Priority cell used for cartridge import and export



© IBM Corporation 1988

CMPLB

Figure 67. IBM Magstar MP Library Modes of Operation

4.10 IBM 3570 Magstar MP Library Modes of Operation

The library units may be set to automatic, manual, or random modes (Figure 67) from the operator panel. The selected mode is stored in nonvolatile storage and becomes the default mode during subsequent power-on cycles.

4.10.1 Automatic Mode

Automatic (sequential) mode allows the operator to keep the drive continually fed with cartridges from the magazines. After being enabled, the transport mechanism automatically loads and unloads cartridges until all of the cartridges in the magazine are processed. Each cartridge is returned to the magazine location it was taken from and placed in the export position.

The transport starts processing cartridges beginning at the rightmost cell in each magazine. The search for unprocessed cartridges is always from right to left within a magazine, as viewed from the front of the Library.

The operator can supply additional external cartridges to an application by using the priority cell instead of opening the library door. Any cartridge inserted in the priority cell will automatically be the next cartridge loaded into the drive. When that specific cartridge is unloaded, the transport mechanism returns it to the priority cell in the export position (whence it can be removed) and resumes processing cartridges from the magazine. The transport mechanism continues to search for unprocessed cartridges until it has searched all 20 cells without finding an unprocessed cartridge. At that time, the transport mechanism becomes disabled.

The operator can remove cartridges that are in the export position from magazines and add cartridges in the import position to the magazine while the

transport mechanism is in automatic mode. The transport mechanism stops when the door is opened, and resumes operation when the door is closed. If a cartridge is in a drive when the door is opened, processing continues until complete. When the door is closed, the cartridge is returned to the cell from which it was removed.

4.10.2 Manual Mode

Manual mode allows the same functions to occur as the automatic mode, except that manual mode allows the operator to initiate each load operation. Each time the operator presses **Start** from the Set Library Mode menu, the Library unit selects the cartridge from the next unprocessed magazine cell and mounts it in the drive. Manual mode operation is also activated by placing a cartridge in the import position of the priority cell. Only one cartridge is processed for each operator action. After being unloaded, each cartridge is returned to the magazine location it was taken from and placed in the export position.

The transport starts processing cartridges beginning at the rightmost cell in each magazine. The search for unprocessed cartridges is from right to left across both magazines, as viewed from the front of the Library. Each manual operation ends when:

- The cartridge is unloaded and returned to its original cell and there is no cartridge in the import position of the priority cell.
- There is no cartridge in the import position in either magazine.
- An attention condition exists in the Library, such as an extra cartridge condition.
- No magazine is installed; choosing **Start** causes the Library to immediately return to the disabled state.

4.10.3 Random Mode

Random mode allows the IBM Magstar MP to act as a self-contained library of up to 19 cartridges, controlled entirely by SCSI initiators. In addition, access is provided to Cartridge 20 through the priority cell. The initiator uses SCSI commands to select a cartridge from a source cell and move it to its destination cell. Control of the source and destination cells is left entirely to the initiator.

A request for an external cartridge to be mounted can be satisfied by inserting the cartridge into the priority cell in the import position. The IBM Magstar MP notifies initiators of the presence of a cartridge in the priority cell, but the initiator must address that cell specifically to access the cartridge.

When the destination of a move is a magazine cell, the transport mechanism places the cartridge in the cell in the import position for possible later reuse. However, if the destination is the priority cell, the transport mechanism places the cartridge in the cell in the export position.

Random mode can be set at any time the library subsystem is not ready:ehp0, but cannot be enabled unless a magazine is present.

Because the library door must be closed while in random mode, the priority cell is used as an import/export station to add or remove cartridges from the library without violating the integrity of the magazine inventory. An initiator can cause cartridges from the priority cell to be moved to any empty magazine cell or to a device. It can also cause cartridges from a magazine cell or a device to be moved to the priority cell. Requests for external cartridges to be mounted can

be satisfied only when Magazine 2 (the right-most magazine) is present. Library inventory and control is entirely the responsibility of the initiators. If the library door is opened while in random mode, the drive responds to the next command with a Unit Attention message, after which the initiators should reinventory the library contents.

New IBM 3570 Magstar MP Cartridge



- **New form factor**
 - ◆ Two tape reels
 - ◆ Center load point
 - ◆ Tape remains in cartridge
- **Robust design**
- **5 GB uncompact capacity**
- **Incompatible with previous tape technologies**

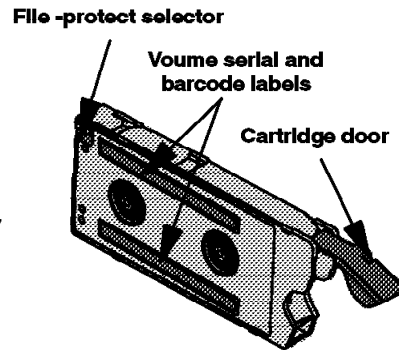

© IBM Corporation 1988

CMPCART

Figure 68. IBM Magstar MP Fast Access Linear Tape Cartridge

4.11 New IBM Magstar MP Cartridge

The IBM Magstar MP uses a completely new type of cartridge, which is designed for fast access, high capacity, high reliability, and automation. As shown in Figure 68, it has these advantages:

- ***New form reduces access time and tape wear.***

The tape cartridge is a completely new shape; it is approximately half the size of IBM 3480/3490/3590 cartridge tapes. The tape drive reads and writes data in a 128-track format, reading and writing four tracks at a time in a new format. Data is written using an interleaved serpentine longitudinal recording format, starting at the center of the tape (midtape load point) and continuing to near the end of the tape. The head is indexed to the next set of four tracks and data is written back to the midtape load point. This process is continued in the other direction until the tape is full.

This design provides faster data access than other tape technologies because the load point for the tape is near the midpoint of the tape length, with half the tape wound onto each of two spools. As a result, the maximum distance that must be travelled to access data is half the length of the tape, thereby shortening data acquisition time and reducing head wear. In addition, the tape is accessed while remaining in the cartridge, thus eliminating the time spent threading the tape before it can be used to read or write data. When the cartridge is loaded into the drive, the cartridge door is opened automatically, allowing the read/write element to access the tape path.

Because the IBM Magstar MP Fast Access Linear Tape cartridges are different from cartridges used in other IBM tape storage products, they cannot be interchanged with the media used in other IBM tape products.

- ***Robust design prevents tape damage.***

The IBM Magstar MP Fast Access Linear Tape cartridge contains major enhancements over conventional data recording cartridges. It has a rugged case designed for repetitive handling by automated pickers that protecting the medium in an enclosed environment. The cartridge contains an advanced metal-particle tape medium developed for high capacity and durability. The tape never leaves the cartridge, and maintains a self-enclosed tape path that allows the medium to avoid being handled by external pickers, rollers, or external guides. The unique tape path eliminates tape thread time, reduces complexity, and provides higher reliability. The cartridge door remains closed during storage and handling to protect the medium and tape path from contamination.

- ***The 5 GB native capacity is housed in a smaller cartridge.***

A completely written cartridge has a maximum storage capacity of 5 GB of uncompacted data; the tape drive provides a data compression algorithm that can increase the typical volume capacity up to 15 GB. The physical size of the cartridge is approximately half that of IBM 3480 and IBM 3490 Cartridge System tapes and 3590 High-Performance System tape. Each tape cartridge includes a file-protect selector which, when set, prevents data from being written on or erased from the tape.

The data and cleaning cartridges are color coded. On data cartridges, the file-protect selector and cartridge door are blue, and the product label has blue lettering on a white background. For cleaning cartridges, the file-protect selector and cartridge door are gray, and the product label has gray lettering on a white background.

Each cartridge is identified by a volume serial (volser) number and bar code label on the front and edge of the cartridge. The label has a small area for the operator to write comments. User-supplied labels should not be affixed to the cartridge since they may interfere with the proper handling of the cartridge in either the drive or the library transport mechanism.

Note: The bar code on the cartridge must not be marked or obscured or the system will malfunction.

Incorrect handling or an incorrect environment can damage magnetic tape or cartridges. Normal handling of the cartridge and simple precautions will prevent damage to cartridges and drives. For example, ensure that the cartridge case is clean and not damaged before loading it into a drive; do not touch the tape; do not expose the tape to any high magnetic field (that is, do not store cartridges near high-current cables or power supplies); do not attempt to open the cartridge case; store cartridges vertically. You may lay them flat for short periods but do not stack more than six cartridges.

Degaussing or ac bulk erasing a tape cartridge will make it unusable. If you need to dispose of the tape in a secure manner, you can erase the tape using a high-energy (minimum of 4000 gauss) ac degausser; however you cannot use the cartridge afterward.

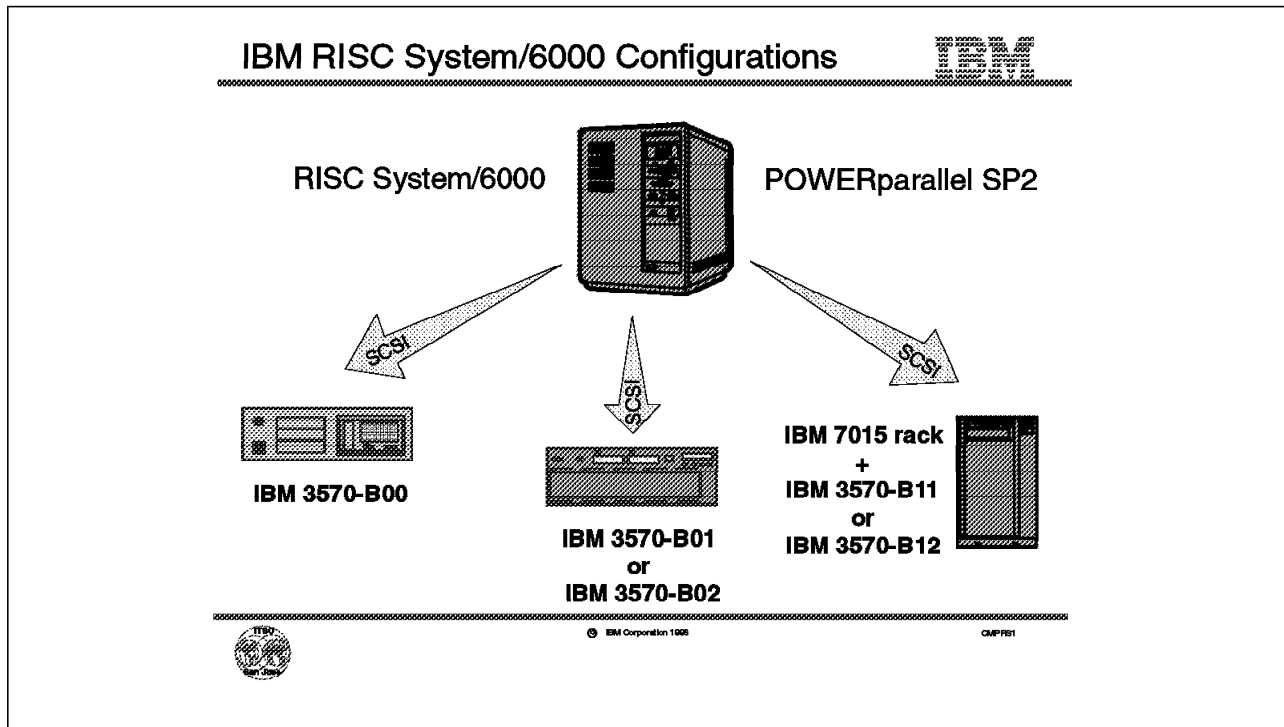

Figure 69. IBM RISC System/6000 Configurations

4.12 IBM RISC System/6000 Configurations

All IBM Magstar MP models can be attached to the IBM RISC System/6000 or POWERparallel SP2 host, using a SCSI interface (Figure 69). The IBM 3570-B00 is a single-drive model designed for customer installation on or under a desk. The IBM 3570-B01 and 3570-B02 are for desk-top library use; they are stand-alone models. The IBM 3570-B11 and 3570-B12 are library models, requiring an IBM 7015-R00 rack or space in an existing customer rack.

4.12.1 RISC System/6000 and POWERparallel SP

The IBM Magstar MP is supported on all models that support the following adapters:

- Enhanced SCSI-2 Differential Fast/Wide Adapter/A (No.2412)
- SCSI-2 Differential Fast/Wide Adapter/A (No.2416)
- SCSI-2 Differential High-Performance External I/O Controller (No.2420)
- PCI SCSI-2 Differential Fast/Wide Adapter (No.2409)

4.12.2 Other Systems

The IBM Magstar MP may also be compatible with other SCSI-compliant differential adapters. Please review your requirements with your IBM representative.

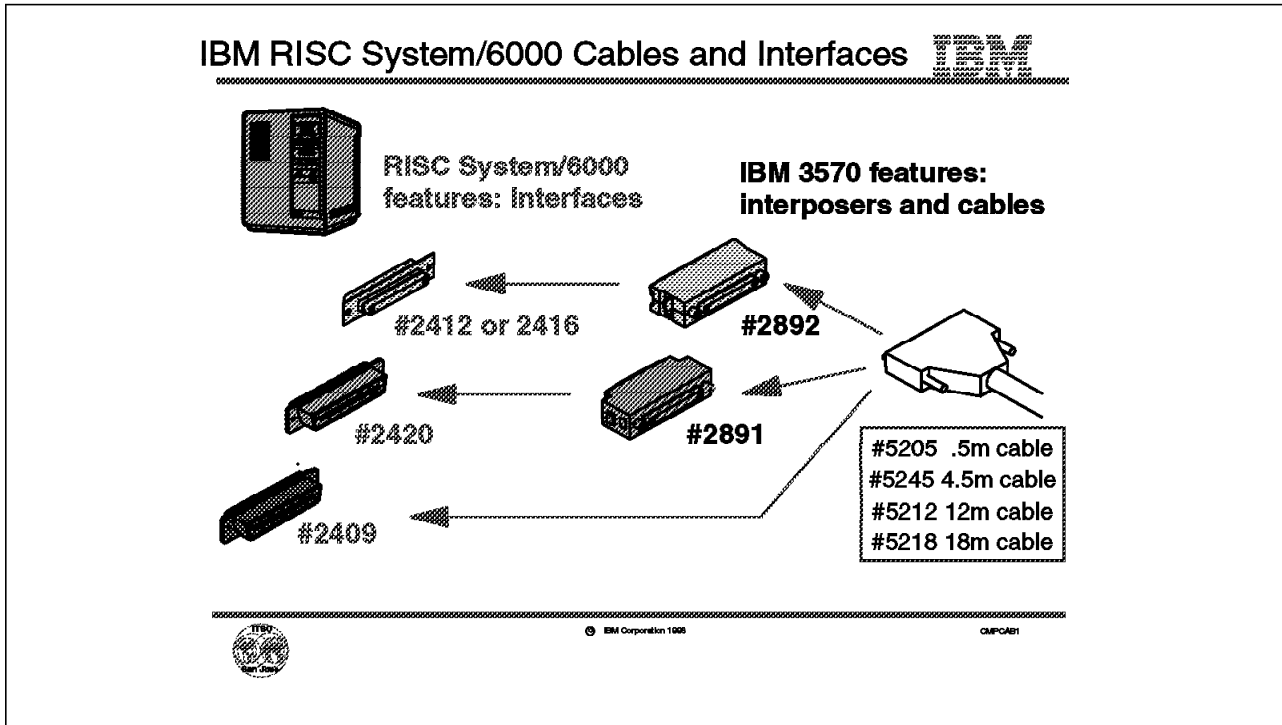

Figure 70. IBM RISC System/6000 Cables, Interfaces, and Interposers

4.13 IBM RISC System/6000 Cables and Interfaces

For attachment to the IBM RISC System/6000 or POWERparallel SP2, the appropriate SCSI cable must be selected, plus the appropriate interposer (see Figure 65 on page 136).

4.13.1 IBM RISC System/6000 I/O adapters

Attachment to the Feature 2412 or 2416 adapters requires a CC68/HD68 interposer, Feature 2892, on the IBM Magstar MP.

Attachment to the Feature 2420 adapter requires a HD68/HD50 interposer, Feature 2891, on the IBM Magstar MP.

No interposer is required for attachment to the Feature 2409 adapter.

4.13.2 IBM RISC System/6000 Model Support

The IBM Magstar MP is supported for attachment to the Enhanced SCSI-2 Differential Fast/Wide Adapter/A (Feature 2412) or the SCSI-2 Differential Fast/Wide Adapter/A (Feature 2416) on the following RISC System/6000 systems:

- IBM 7006 - 41T, 41W, 42T, 42W
- IBM 7009 - C10, C20
- IBM 7011 - 25E, 25F, 25S, 25T, 25W, 250
- IBM 7012 - G30, G40, 32E, 32H, 34H, 340, 350, 355, 36T, 360, 365, 37T, 370, 375, 380, 39H, 390
- IBM 7013 - J01, J30, J40, 52H, 53E, 53H, 55E, 55L, 55S, 550, 56F, 560, 57F, 570, 58F, 58H, 580, 59H, 590, 591
- IBM 7015 - R10, R20, R21, R24, R3U, R30, R40, R4U, 95E, 950, 97B, 97E, 97F, 970, 98B, 98E, 98F, 980, 99E, 99F, 99J, 99K, 990

- IBM 7030 - 3AT, 3BT, 3CT

The IBM Magstar MP is supported for attachment to the SCSI-2 Differential High-Performance External I/O Controller (Feature 2420) on the following RISC System/6000 systems:

- IBM 7006 - 41T, 41W, 42T, 42W
- IBM 7009 - C10, C20
- IBM 7011 - 25E, 25F, 25S, 25T, 25W, 250
- IBM 7012 - G30, G40, 32E, 32H, 34H, 340, 350, 355, 36T, 360, 365, 37T, 370, 375, 380, 39H, 390
- IBM 7013 - J01, J30, J40, 52H, 53E, 53H, 55E, 55L, 55S, 550, 56F, 560, 57F, 570, 58F, 58H, 580, 59H, 590, 591
- IBM 7015 - R10, R20, R21, R24, R3U, R30, R40, R4U, 95E, 950, 97B, 97E, 97F, 970, 98B, 98E, 98F, 980, 99E, 99F, 99J, 99K, 990
- IBM 7030 - 3AT, 3BT, 3CT

The IBM Magstar MP is supported for attachment to the PCI SCSI-2 Differential Fast/Wide Adapter (Feature 2409) on the following RISC System/6000 systems:

- IBM 7024 - E20, E30
- IBM 7025 - F30
- IBM 7248 - 100, 120, 132, 43P

4.13.3 IBM RISC System/6000 Supported Cables

A SCSI cable is required for host attachment. If none is available, one SCSI cable should be specified on the initial order. An interposer may also be required, depending on the host's I/O adapter, as described. The following feature codes for the IBM 3570-Bxx models are available for specifying SCSI cables:

- Feature 5205 - 0.5 meter
- Feature 5212 - 12 meters
- Feature 5218 - 18 meters
- Feature 5245 - 4.5 meters

The following feature codes for the IBM 3570-Bxx models are available for specifying interposers:

- Feature 2891 - HD50/HD68 Fast and Narrow Differential Interposer
- Feature 2892 - CC68/HD68 Fast and Wide Differential Interposer



RISC System/6000 POWERparallel SP
AIX version 3.2.5 or 4.1.1 and later (device support with hardware)
ADSM /AIX Version 2.1
NetTAPE for AIX with ADSM
AIX Sysback/6000 with AIX



Figure 71. IBM RISC System/6000 Software Required to Support the IBM Magstar MP Tape Subsystem

4.14 IBM RISC System/6000 Software Support

The IBM Magstar MP is supported on AIX Version 3.2.5 or AIX 4.1.1 and later releases including support for the library in random mode. Specific device support for AIX is included with each tape subsystem.

Support is also provided by the following products:

- ADSTAR Distributed Storage Manager for AIX Version 2.1 (ADSM/AIX) supports the IBM Magstar MP. ADSM/AIX offers highly automated, centrally scheduled, policy-managed backup and archive facilities to protect data in distributed enterprises using AIX/6000 systems as servers.
- The IBM Network Tape Access and Control System (NetTAPE) for AIX works with ADSM to allow access to and sharing of tape drives and libraries in a network of AIX workstations. It creates a single-system view of tape operations and allows two or more Magstar MP drives with random access to be used like one tape library.
- AIX System Backup & Recovery/6000 (Sysback) from IBM Corporation is a menu-driven application that provides system administrators and other AIX users with a simple, efficient way to back up data and recover from hardware failures. It was designed to give AIX Version 3.2 and Version 4.1 users the fastest possible method of recovering all or part of the system after a system or hardware failure.

Additional software support is available from many industry leading tape application vendors.

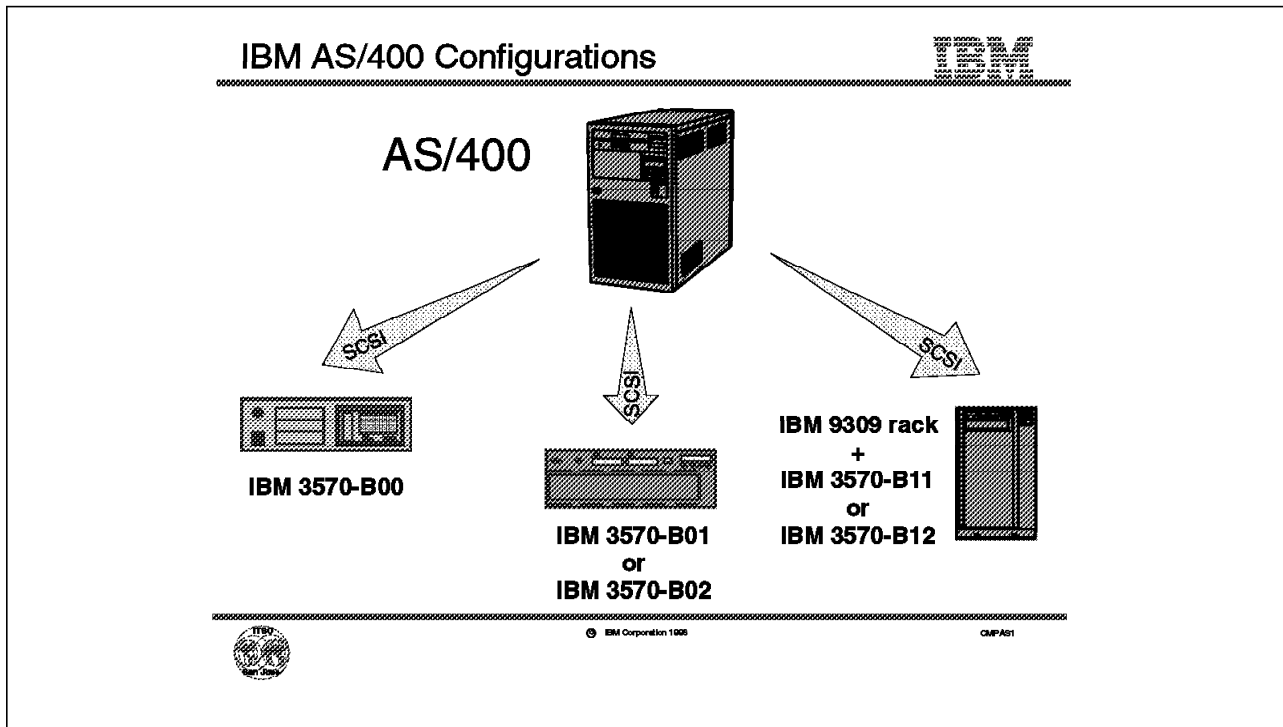

Figure 72. IBM AS/400 Configurations

4.15 IBM AS/400 Configurations

All IBM Magstar MP models can be attached to the IBM AS/400 using the SCSI interface (Figure 72). The IBM 3570-B00 is a single-drive model designed for customer installation on or under a desk. The IBM 3570-B01 and 3570-B02 are for desk-top library use; they are stand-alone models. The IBM 3570-B11 and 3570-B12 are library models and require an IBM 9309-002 rack enclosure or space in an existing customer rack.

Note: The B02 and B12 models (that is, those with two drives) can be used only in a split configuration which appears to the IBM AS/400 as two independent tape libraries.

IBM AS/400 Cables and Interfaces

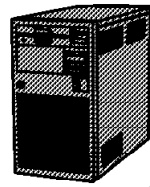

AS/400
SCSI interface

**3570 features:
Interposers and cables**



#6501



#2895

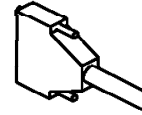

#5205 .5m cable
#5245 4.5m cable
#5212 12m cable
#5218 18m cable



© IBM Corporation 1995

CMPCAB2

Figure 73. AS/400 Cables Interfaces and Interposers

4.16 IBM AS/400 Cables and Interposer

For attachment to the IBM AS/400, the appropriate SCSI cable must be selected, and the appropriate interposer (Figure 73). An interposer, Feature 2895, must be ordered to attach the SCSI cable to the IBM AS/400 Magnetic Media Subsystem Controller, Feature 6501.

4.16.1 IBM AS/400 Model Support and I/O Adapter

The IBM Magstar MP can be attached to all Dxx and later models of the AS/400, except the X02 and P03 models using the IBM AS/400's Magnetic Media Subsystem Controller (Feature 6501). Each Feature 6501 can support up to two subsystems.

4.16.2 IBM AS/400 Supporting Cables

A SCSI cable is required for host attachment. If none is available, one SCSI cable should be specified on the initial order. An interposer (Feature 2895) is also required for attachment to the AS/400. The following feature codes are available for specifying SCSI cables for the IBM 3570-Bxx models

- Feature 5205 - 0.5 meter
- Feature 5212 - 12 meters
- Feature 5218 - 18 meters
- Feature 5245 - 4.5 meters

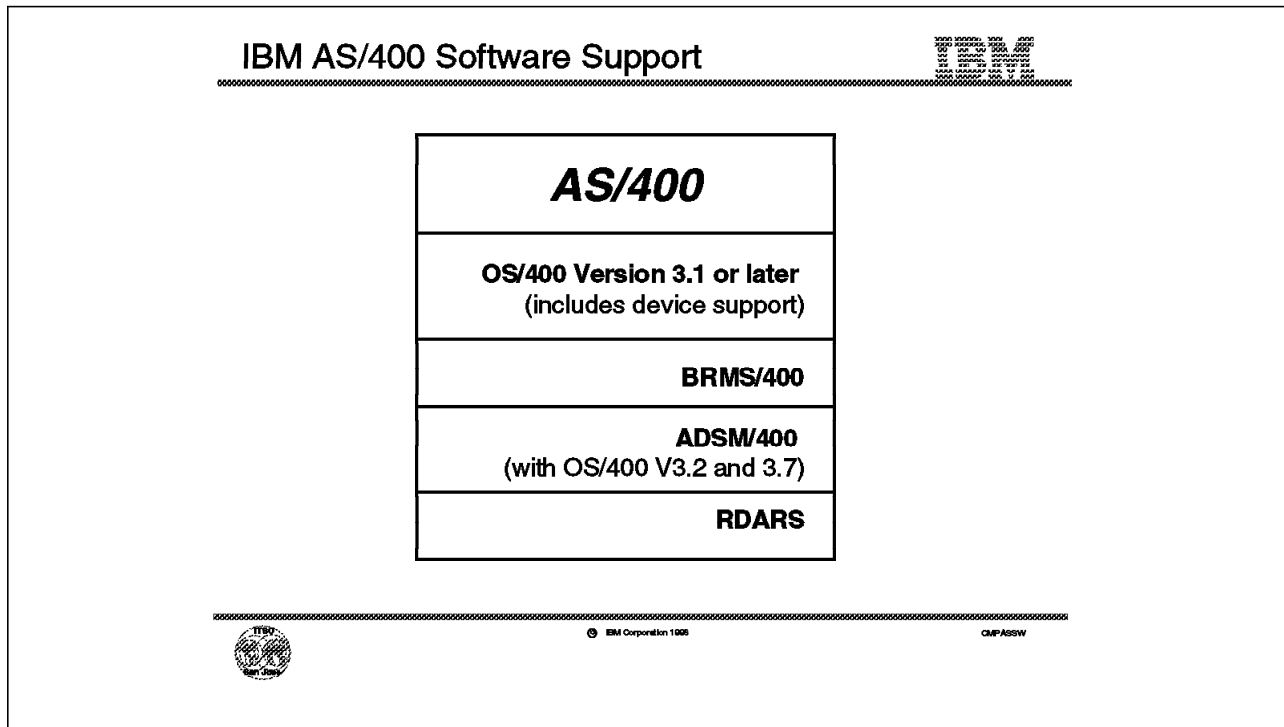

Figure 74. AS/400 Software Required to Support the IBM Magstar MP Subsystem

4.17 IBM 3570 Magstar MP AS/400 Software Support

The IBM Magstar MP Tape Subsystem is supported on OS/400 Version 3 Release 1 or later, including support for the library in random mode. ADSM/400 is supported only on OS/400 V3R2 and V3R7 (Figure 74).

Support is also provided by the following products:

- Backup Recovery and Media Services/400 (BRMS/400) is recommended to support automation in tape handling, media management, and automatic migration of data between tape and DASD based on user-defined policies.
- ADSTAR Distributed Storage Manager/400 (ADSM/400) is a client/server storage management product that provides save and restore functions for workstations and LAN file servers on the AS/400.
- Report/Data Archive and Retrieval System (R/DARS) is an application solution which stores and retrieves data on disk, optical, or tape media.

For those developing unique applications, OS/400 provides a command interface.

Alternate IPL is supported; for V3R1 and V3R2, RPQ 843910 is required. IBM software distribution will not be provided for the IBM Magstar MP. A second tape drive other than the IBM Magstar MP will be required on the V3R1 and V3R2 IMPI machines.

In the initial release (V3R7 and below), AS/400 will support Models B02 and B12 only in a split configuration mode, where each of the two attached systems has exclusive control of one drive and one magazine. Sharing of drives and magazines between systems is not permitted in this mode.

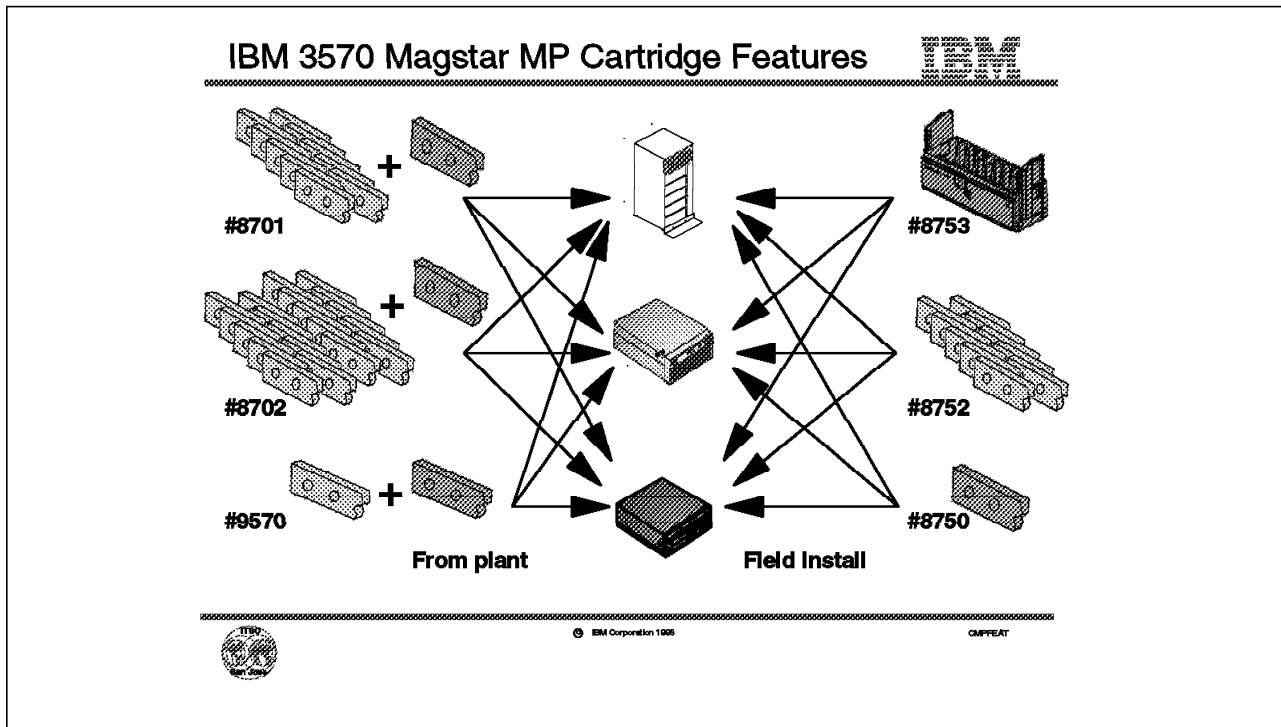

Figure 75. IBM 3570 Tape Subsystem Cartridge Feature Codes

4.18 IBM 3570 Magstar MP Feature Codes

This section describes the new features relevant to the IBM Magstar MP and their feature codes (Figure 75).

4.18.1 Cartridge Features

You can order cartridges by selecting features for the IBM Magstar MP. You must order one of these three features for the IBM Magstar MP:

- **Feature 8701** for a quantity of 10 data cartridges and one cleaning cartridge
- **Feature 8702** for a quantity of 20 data cartridges and one cleaning cartridge
- **Feature 9570** a nonchargeable feature that supplies one data cartridge and one cleaning cartridge.

It is mandatory to select one of these features when you order an IBM Magstar MP. You must not select more than one of these three features and you can select yours only for shipment with the device from the manufacturing plant.

You can also order optional features for the IBM Magstar MP. Data or cleaning cartridges, and cartridge magazines may be ordered for shipment with the IBM 3570 devices as well as after installation:

- **Feature 8753** for one IBM 3570 cartridge magazine (up to 10)
- **Feature 8750** for one IBM 3570 cleaning cartridge (up to 10)
- **Feature 8752** for a quantity of 10 IBM 3570 Magstar MP tapes (up to 99 features). Feature 8752 is for field installation only; if you want cartridges shipped with the device, then you should use Feature 8701 or 8702.

4.18.2 Device Drivers

Device drivers for IBM Magstar MP are supplied with the OS/400 operating software. For AIX systems, order Feature 9603 for the IBM Magstar MP (AIX device driver for IBM RISC System/6000 or SP2).

4.18.3 Cables and interposers

SCSI cables available for the IBM Magstar MP and their respective lengths are as follows:

- Feature 5205 is an 0.5 meter (1.6 ft) cable with high-density 68-pin (HD68) connectors on both ends.
- Feature 5212 is a 12 meter (39 ft) cable with HD68 connectors on both ends.
- Feature 5218 is an 18 meter (59 ft) cable with HD68 connectors on both ends.
- Feature 5245 is a 4.5 meter (15 ft) cable with HD68 connectors on both ends.

The following interposers are available for IBM Magstar MP:

- Feature 2891, HD50/HD68 Fast and Narrow Differential Interposer
- Feature 2892, CC68/HD68 Fast and Wide Differential Interposer
- Feature 2895, Interposer for AS/400

Chapter 5. IBM Magstar 3590 Silo-Compatible Tape Subsystem

This chapter describes how the IBM 3590 Magstar Tape Drive can be installed in a StorageTek Automated Cartridge System.

- **Library Control Unit (LCU)**
Receives and responds to requests from the hosts and directs the function to the robotics of the Library Storage Module (LSM).
- **Library Management Unit (LMU)**
Provides an interface between the Host Software Component (HSC), and the Library Control Units (LCUs), attached to each Library Storage Module (LSM).
- **Library Storage Module (LSM)**
The LSM is a free-standing robotic arm within a twelve-sided cylindrical housing (the Silo), with storage capacity for approximately 6000 cartridges.
- **RedWood SD-3 Helical Cartridge Tape Subsystem**
This is the latest tape drive announced from StorageTek; it uses helical-scan technology. Because helicalscan is a very expensive technology to use and maintain, this type of device should only be used for very special niche applications.
- **Silo**
Some people use this term as the name of the whole subsystem and some use it as the name of the LSM. Nicknames for the Silo exist in different local languages.
- **Silverton 4490 Cartridge Subsystem**
This is the StorageTek IBM 3490E-compatible tape subsystem, using 36-track format standard cartridges and is able to attach to parallel channels only.
- **StorageTek**
StorageTek or STK are short versions of the company name of Storage Technology Corporation.
- **TimberLine 9490 Cartridge Tape Subsystem**
This is the StorageTek IBM 3490E-compatible tape subsystem, using 36-track format extended cartridges and with a performance twice that of the Silverton 4490 Cartridge Subsystem.

See Section 5.3, "Configuration Overview" on page 160 for an overview of a StorageTek Automated Cartridge System with IBM Magstar tape drives.

Why Use IBM 3590 Magstar in an STK Silo?

0000 000000 000 0000
0000 000000 000 0000
00 00 00 00 0000 0000
00 00000 00000000
000 000000 00000000
00 00 00 00 0000 00
0000 000000 000 0000
0000 000000 000 0000

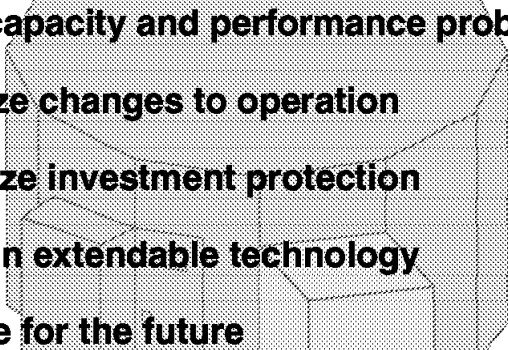
- 
- **Solve capacity and performance problems**
 - **Minimize changes to operation**
 - **Maximize investment protection**
 - **Invest in extendable technology**
 - **Prepare for the future**



© IBM Corporation 1996

KENGVHYY

Figure 77. Why Use IBM 3590 in an STK Silo?

5.2 Why Use IBM 3590 Magstar in an STK Silo?

- ***Solve capacity and performance problems.***

The capacity in terabytes of a StorageTek Silo can be increased by up to 50 times by attaching IBM 3590-C12 frames. Comparing on the basis of the uncompacted storage capacity of a cartridge and recording technology, the IBM Magstar cartridge can store 50 times as much as IBM 3480 drive technologies and 12 times as much as IBM 3490E drive technologies using an Enhanced Capacity cartridge.

The performance of the IBM Magstar tape drives may substantially improve throughput for certain tape applications. They will also have the performance to improve dump and restore times for the newly announced RAMAC-3 array disk.

- ***Minimize changes to operation.***

When installing an IBM 3590-C12 frame, no new software is required because existing 3490E tape applications also run on IBM 3590-C12. If the esoteric unit names used by existing applications are defined for the new drives, no JCL-changes are required.

- ***Maximize investment protection.***

By adding an IBM 3590-C12 frame, or installing it to replace existing tape drives, the investment in all other parts of the StorageTek Automated Cartridge System is retained at the same time as the capacity and the performance are improved.

Later, the IBM Magstar 3590 cartridges and the IBM 3590-B1A drives can be moved and installed in an IBM Automated Tape Server, such as the IBM 3494, giving you the option to use virtual tapes and drives to maximize the utilization of your investment.

- ***Invest in extendable technology.***

In 1995, IBM first announced the IBM Magstar 3590 tape subsystem and now in 1996 substantial additions have been announced in products, functions, and features. The IBM Magstar technology will be further enhanced and new products, functions, and features will be included in future announcements. By installing the IBM 3590-C12 in the StorageTek Silo, you will invest in a technology that will be extended in the future.

- ***Prepare for the future.***

As you have seen in earlier chapters of this book some functions and features of the IBM Magstar technology will be available next year and even more are expected in the future. By installing the IBM 3590-C12 now, you prepare to take full advantage of all functions and features of the IBM Magstar technology. Also by installing the IBM 3590-C12 now, you reduce the number of cartridges, and convert all your tape data to the new technology.

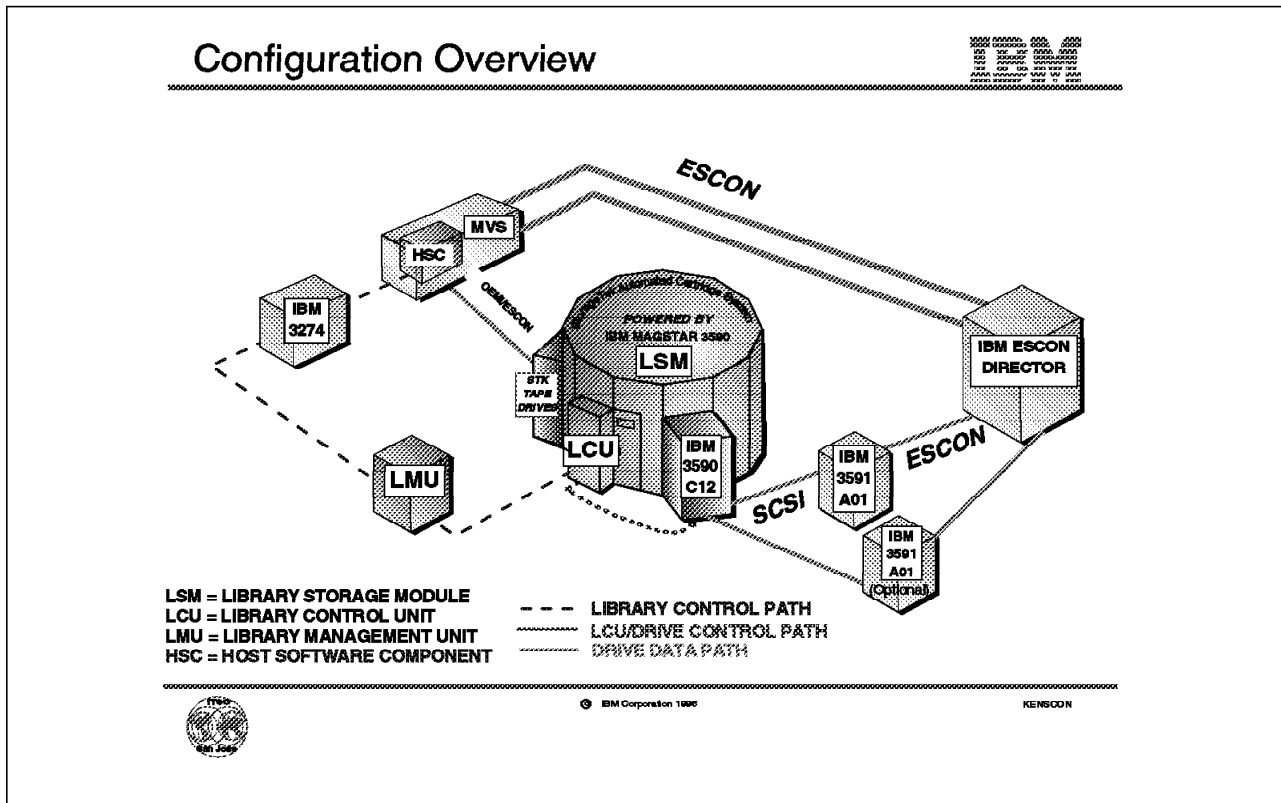

Figure 78. Configuration Overview

5.3 Configuration Overview

The components of a StorageTek Automated Cartridge System with an IBM 3590 Model C12 Silo-Compatible Frame installed (Figure 78) are as follows:

- **Library Storage Module (LSM)**
 - Contains the Magstar 3590 Data Cartridges, Magstar 3590 Cleaning Cartridges, and Magstar 3590 Diagnostic Cartridges, and cartridges for STK drives, if installed, as well as storage slots and robotics.
 - Up to sixteen drives can be attached to one LSM.
- **Library Control Unit (LCU)**
 - Controls the robotics motion and interfaces to the drives through the LCU/DRIVE Control Path. The LCU gets orders from the Library Management Unit, see below, through the Library Control Path.
- **IBM 3590-C12 (Silo-Compatible Frame)**
 - Contains four IBM 3590-B1A drives attached to StorageTek LSM and interfaces with the StorageTek LCU through the LCU/DRIVE Control Path. More information on the IBM 3590-C12 will follow in Section 5.4, "IBM 3590 Model C12" on page 162.
- **StorageTek Tape Drives**
 - These may be installed at the same time as the IBM 3590-C12.

- **IBM 3591-A01 (ESCON Tape Controller)**

IBM 3591-A01 ESCON tape controller provides for ESCON attachment of the IBM 3590-B1A drives as if they are IBM 3490E drives. More information on the IBM 3591-A01 will follow in Section 5.4, "IBM 3590 Model C12" on page 162.

- **IBM ESCON Director**

The ESCON director allows the drives in the IBM 3590-C12 to be accessed from multiple hosts or logical partitions. This is optional.

- **Library Management Unit (LMU)**

The LMU converts the mount commands from up to 16 hosts to robotic commands for up to 16 LCUs. The LMU interfaces with the LCUs and with the hosts (via a Network Controller, see below) through the Library Control Path.

- **Network Controller (for example, IBM 3274)**

The controller allows the Host Software Component, see below, to access the LMU through the Library Control Path.

- **Host Software Component (HSC)**

The HSC manages the cartridge-to-slot database and steers drive allocation.

IBM provides maintenance for the entire library subsystem and problem determination assistance for interoperability issues in split maintenance environments.

See Table 7 on page 164 for ordering data cartridges with the IBM 3590-C12 Frame. For detailed information on ordering additional cartridges, see:

- *IBM 3590 Magstar High Performance Tape Subsystem Silo-Compatible Frame Model C12 Introduction, Planning, and User's Guide.*

Up to four IBM 3590-C12 units can attach to one LSM, allowing up to 16 IBM 3590-B1A drives.

Feature	Specification
Height	1803 mm (71 in.)
Width	724 mm (28.5 in.)
Depth (Free-Standing)	975 mm (38.4 in.)
Depth (Installed)	775 mm (30.5 in.) ¹
Weight	400 kg (880 lb) ²
Notes:	
1. In the service position, the maximum installed depth for Model C12 is 1635 mm (62.1 in.).	
2. This is the weight of a fullyloaded C12 frame.	

For more information on environmental specifications and additional information about the IBM 3590 Model C12, see:

- *IBM 3590 Magstar High Performance Tape Subsystem Silo-Compatible Frame Model C12 Introduction, Planning, and User's Guide.*

For additional information about the IBM 3590 Magstar tape drive, see:

- *IBM 3590 High Performance Tape Subsystem Introduction and Planning Guide*
- *IBM 3590 High Performance Tape Subsystem User's Guide,*
- *IBM 3590 High Performance Tape Subsystem Hardware Reference*
- *Magstar and IBM 3590 High Performance Tape Subsystem: Multiplatform Implementation*

An optional display mounted on the top of the IBM 3494-C12 (not shown in Figure 79 on page 162) is available from Texas Digital Systems, Inc. (TDS) of College Station, Texas 77845, USA, telephone (409) 693-9378. The TDS display features an 11-color LED display that can be read from a distance up to 27 meters, and provides drive status information. The display attaches to the RS-422 interface of each IBM 3590-B1A drive through a display controller mounted in the IBM 3494-C12 frame.

5.4.1 IBM 3590-C12 Features

Table 7 shows the feature codes for the features applicable to the IBM 3590-C12 frame.

Description	Feature Code
One 12 m (39.4 ft) SCSI cable; One SCSI bus with four drives	5201
Two 12 m (39.4 ft) SCSI cables; Two SCSI buses with two drives each	5202
One cleaning cartridge	8002
Seven 30-packs of tape cartridges (210 cartridges); without seventh character on VOLSER label	8210
Fourteen 30-packs of tape cartridges (420 cartridges); without seventh character on VOLSER label	8220
No data cartridges	9590
Chicago line cord, 2 meters	9986

- **Feature 520x**

You must select either Feature 5201 or 5202. Installation is performed at the plant. The 12-m cable is shipped separately from the drive and is installed in the field. Approximately 10 m of the 12-m SCSI cable length is available for connection to the IBM 3591-A01 ESCON controller.

Feature 5201 supplies one 12-m SCSI cable for attachment of a IBM 3590-B1A drive to a IBM 3591-A01 ESCON controller, and three 4-m SCSI cables for daisy-chaining to three additional IBM 3590-B1A drives in an IBM 3590-C12 frame. The SCSI cables are daisy-chained from the lowest drive in the frame to the top drive (see Figure 80 on page 166). A terminator is attached to the last connector in the top drive. The uppermost drive in the frame has SCSI address 0 and the bottom drive has SCSI address 3.

Feature 5202 supplies two 12-m SCSI cables for attachment of two IBM 3590-B1A drives each to two IBM 3591-A01 ESCON controllers, and two 4-m SCSI cables, each of which is used to daisy-chain the two drives connected to the IBM 3591 controllers. This results in two IBM 3590-drives on each bus (Figure 80 on page 166).

- **Feature 8002**

This feature supplies one cleaning cartridge. Up to ten Features 8002 can be specified for plant or field install.

- **Feature 8210**

You can order no more than one Feature 8210 containing 210 IBM 3590 Data Cartridges without the “seventh character” J on the external label.

- **Feature 8220**

You can order no more than Feature 8220 containing 420 IBM 3590 Data Cartridges without the “seventh character” J on the external label.

Features 8210 and 8220 are plant install only.

- **Feature 9590**

This feature should be specified if no data cartridges should be delivered with the IBM 3590-C12 frame.

Note: One of Features 8210, 8220, or 9590 must be ordered with every IBM 3590-C12 frame.

- **Feature 9986**

Feature 9986 is required for a IBM 3590-C12 installed in Chicago.

5.4.2 IBM 3590-B1A Features

Table 8 shows the features for the IBM 3590-B1A drive.

Description	Feature Code
C12 Attachment	2003
ES/9000 Attachment	9000

- **Feature 2003**

Feature 2003 is required on a IBM 3590-B1A to be installed in the IBM 3590-C12. This feature adds a target for the robotic vision system and a holder for the display.

- **Feature 9000**

Feature 9000 should be specified when IBM 3590-B1A will be attached to a ES/3090, ES/9000, or S/390 system.

Support for the IBM 3590-C12 Silo-compatible frame together with one or two IBM 3591-A01 ESCON control units is provided in the MVS/ESA operating environment. No new software is required because existing IBM 3490E tape applications also run on IBM 3590-C12.

Table 9 shows which software releases support the IBM 3590-B1A drives attached to an IBM 3591-A01 ESCON controller.

<i>Table 9. IBM 3591-A01 Software Support</i>					
MVS Level	DFP		DFSMS		
	3.3.0	3.3.2	1.1.0	1.2.0	1.3.0
4.2.0	Yes	Yes			
4.2.2	Yes	Yes			
4.3.0	Yes	Yes	Yes	Yes	Yes
5.1.0	Yes	Yes	Yes	Yes	Yes
5.2.0			Yes	Yes	Yes
5.2.2			Yes	Yes	Yes

For more information on software support for the IBM 3591-A01 ESCON controller, see *Magstar and IBM 3590 High Performance Tape Subsystem: Multiplatform Implementation*.

Table 10 shows the physical specifications of the IBM 3591-A01 ESCON control unit.

<i>Table 10. IBM 3591-A01 Physical Characteristics</i>	
Dimension	Specification
Height	381 mm (15.0 in.)
Width	482.6 mm (19 in.)
Depth (free-standing)	441.3 mm (17.4 in.)
Depth (installed)	533.4 (21 in.) ¹
Weight	40.8 kg (90 lb)
Notes:	
1. The installed depth includes the added length of the front cover and rear plug.	

For more information on environmental specifications, see

- *IBM 3590 Magstar High Performance Tape Subsystem Silo-Compatible Frame Model C12 Introduction, Planning, and User's Guide*.

For additional information about the IBM 3591 Model A01, see:

- *IBM 3591 Tape Control Unit Model A01 Introduction, Planning, and User's Guide.*

5.5.1 IBM 3591-A01 Features

Table 11 shows the features for the IBM 3591-A01 ESCON control unit.

Description	Feature Code
Remote support facility	2700
Remote support switch	2701
Remote support attachment	2702.
ESCON Adapter Card	3311
IBM 3591-A01 Floor-Standing Package	5000

- **Feature 2700**

Feature 2700 attaches a customer-supplied modem for installation, operation, and remote diagnostic support. It should be ordered for the first IBM 3591-A01 in one location. Only one Feature 2700 should be specified for each site, because up to 14 IBM 3591-A01 units can use the same Remote Support Facility (RSF).

- **Feature 2701**

Feature 2701 attaches to multiple IBM 3591-A01 ESCON control units to the Remote Support Facility (Feature 2700). It should be ordered for the second IBM 3591-A01 in one location. Only one Feature 2701 should be ordered for each customer site.

- **Feature 2702**

Feature 2702 attaches to the Remote Support Facility (Feature 2700). It should be ordered for the third through fourteenth IBM 3591-A01 in one location. Only one Feature 2701 should be ordered for each site.

Note: Each IBM 3591-A01 must specify either Feature 2700, Feature 2701, or Feature 2702. All are plant or field installable.

- **Feature 3311**

An ESCON adapter card, Feature 3311, is required on all IBM 3591-A01 ESCON controllers; it provides an ESCON channel for attachment to a host processor ESCON channel or to a port of an IBM ESCON director. A SCSI adapter is included for attachment of IBM 3590-B1A drives on a SCSI bus. Only one Feature 3311 is needed for plant installation.

- **Feature 5000**

Feature 5000 provides the hardware necessary to have the IBM 3591-A01 as a free-standing box, not requiring a rack.

ESCON cables are ordered with the IBM 3591-A01 ESCON control unit. For information on ordering ESCON cables, refer to:

- *IBM 3591 Tape Control Unit Model A01 Introduction, Planning, and User's Guide.*

Esoteric unit names are used to steer allocation inside and outside the StorageTek Automated Cartridge System. More information on allocation is given in Section 5.7, "Multi-ATL Scratch Tape Allocation" on page 171 and Section 5.8, "Multi-ATL Specific Tape Allocation" on page 173.

- **HSC 2.x**

The following tape device combinations are allowed when using 3590 drives in a StorageTek Automated Cartridge System under HSC 2.x:

1. IBM 3590 only
2. StorageTek 4480, SD-3 or both, plus and IBM 3590
3. StorageTek 4480, SD-3 or both, plus StorageTek 4490 and IBM 3590
4. StorageTek 4480, SD-3 or both, plus StorageTek 9490 and IBM 3590

The IBM 3590 drives emulate StorageTek 4490 **or** 9490 drives, and cannot be introduced into the Automated Cartridge System if 4490 **and** 9490 tape drives are present.

Use explicit ranges of VOLSERS for IBM 3590 media. The following volume attribute definitions are suggested to manage drive-media relationships:

- One or more statements for IBM 3590 Data Cartridges to identify 3590 tapes as a unique media type associated exclusively with the recording technology of the model type they emulate (StorageTek 4490 or 9490).
- One statement for IBM 3590 Cleaning Cartridges; the same media and recording technology attributes used for IBM 3590 Data Cartridges should be applied.
- Additional statements as required to associate media for other drive types with their appropriate recording technology.
- A statement to designate a default recording technology. In a mixed configuration do not specify the IBM 3590 media as the default.

Unit attribute statements are needed to associate IBM 3590 drives with the model type they emulate. Esoteric unit names are used to steer allocation inside and outside the Automated Cartridge System. More information on allocation will be given in Section 5.7, "Multi-ATL Scratch Tape Allocation" on page 171 and Section 5.8, "Multi-ATL Specific Tape Allocation" on page 173.

For additional information on how to define devices and cartridges to HSC, see:

- *StorageTek Host Software Component (MVS/XA-ESA Implementation) System Programmers Guide, Release 1.2, 4044266-2*
- *StorageTek Host Software Component MVS System Programmers Guide, Release 2.0.1, 112156401.*

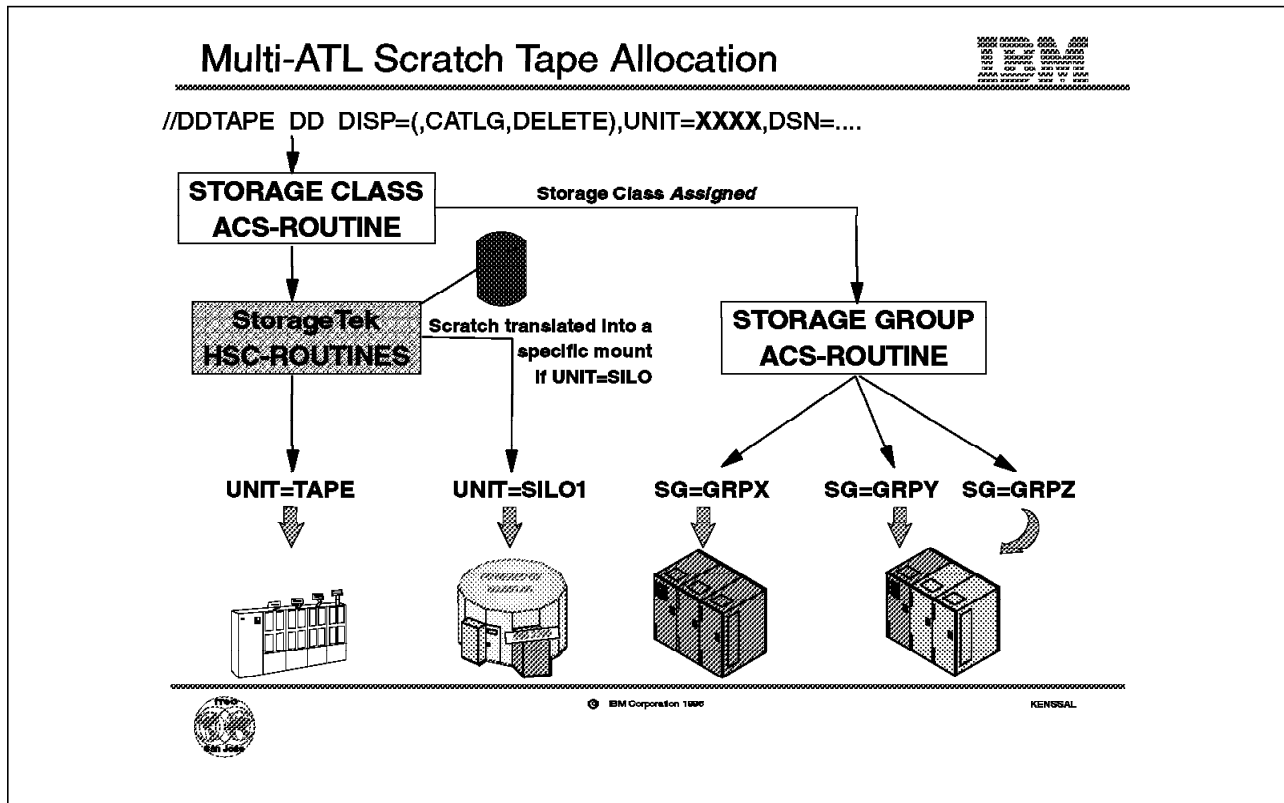

Figure 82. Multi-ATL Scratch Tape Allocation

5.7 Multi-ATL Scratch Tape Allocation

When you decide to install an IBM 3494 or IBM 3495 Automatic Tape Library Dataservers beside an already installed StorageTek Silo to make a smooth migration, you need to know which data is written on which cartridges in which library. This section describes how new tape allocations, that is scratch allocations, are handled in a multivendor tape library installation (Figure 82).

When the IBM Automatic Tape Library is installed, you define it to DFSMS/MVS and define groups for the tape volumes that will be system-managed storage groups. You also add some statements to the automatic class selection routines of DFSMS/MVS to direct new allocations to the correct tape storage groups. For more information on how to implement system managed tape, see:

- *IBM 3495 Implementation Primer for MVS.*

When you define a JCL statement, requesting a scratch tape, the information is first passed to the DFSMS automatic class selection (ACS), routines. If the logic of the Storage Class ACS routine assigns a storage class to this request, the volume requested by this allocation will be system managed. The logic of the storage group ACS routine then assigns a storage group to this allocation. The storage group name is then used by MVS allocation to direct this scratch request to the library or libraries defined to host it. A scratch volume is selected by the Library Manager in the library selected.

If the storage class ACS routine does not assign a storage class to this request, it is not system managed, and is handled as a traditional scratch tape allocation.

After DFSMS, the StorageTek HSC routines will pick up this tape scratch allocation. If the allocation request is directed to an esoteric unit name defined for the tape drives in a Silo, the HSC software will select a scratch volume from the Control Data Set and turn this allocation into a specific allocation.

If the scratch allocation is for a unit-name not defined for a Silo, the allocation will go to some tape drive of the requested type outside the tape libraries. The operator is then requested to mount a scratch tape, if the scratch request could not be satisfied by a cartridge loader on the tape drive.

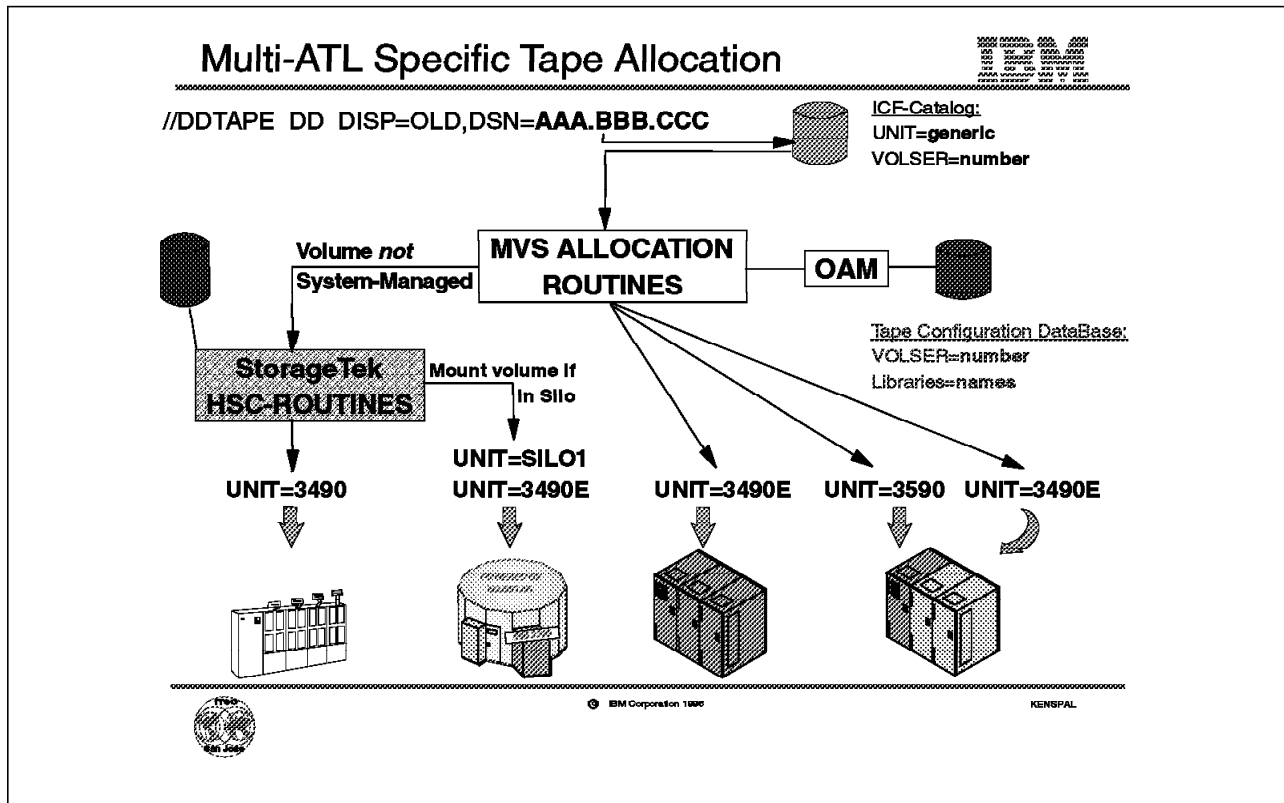

Figure 83. Multi-ATL Specific Tape Allocation

5.8 Multi-ATL Specific Tape Allocation

As described in Section 5.7, “Multi-ATL Scratch Tape Allocation” on page 171 you can use system managed tape together with a StorageTek Silo for scratch requests, once data is created. This section describes how stored data can then be retrieved.

The most common request for data already stored in your system is to specify the name of the data set and specify disposition OLD or SHR, as shown in Figure 83. MVS routines extract the unit and volume information from the system catalog, if it is not specified in the allocation request.

MVS allocation together with the library support routines included in DFSMS Object Access Method (OAM) component and information in the Tape Configuration Database (TCDB), will see if this is a system-managed tape, and if so, in which library the tape is stored. For all system-managed tapes, MVS allocation directs the allocation to the drives installed in the library containing the tape.

If the tape is not system managed, the StorageTek HSC routines see the allocation request afterward. The HSC routines check the control data set to find in which Silo the tape is stored and which drives to use in order to mount the volume. The HSC routines update the allocation information and send the mount order to the robotics in the Silo.

If the tape is not system-managed, and is not defined in the HSC control data set, the allocation is directed to any stand-alone tape drive that can satisfy the

request. The operator is then requested to mount the tape on the allocated tape drive.

Installation and Operation

0000 000000 000 0000
0000 000000 000 0000
00 00 00 0000 0000
00 000000 00000000
00 000000 00000000
00 00 00 00 0000 00
0000 000000 000 0000
0000 000000 000 0000

Steps to install

1. Install PTFs
2. DFSMS/MVS IOGEN
3. Cleaning program
4. HSC updates
5. Hardware installation
6. Restart HSC

Operational procedures

- Manual mode
- Drive cleaning
- External labels
- Inventories and catalogs



© IBM Corporation 1990

KENSIAD

Figure 84. Installation and Operation

5.9 Installation and Operation

This section describes the installation of the IBM 3590-C12 and IBM 3591-A01 and explains operation procedures for the installation.

5.9.1 Installation

We describe six installation steps:

1. *Install PTFs*

No new software releases are required to use the IBM 3590-C12. The IBM 3591-A01 ESCON controller emulates the IBM 3490E, and functions with existing system-level and application software. The software restrictions, limitations, and maintenance associated with IBM 3591-A01 apply to IBM 3590-C12.

Table 12 on page 176 shows the Authorized Program Analysis Reports (APARs) that should be installed in order to exploit the full capacity of the IBM 3590 Magstar Cartridges.

<i>Table 12. APARs</i>	
Software Component	APAR number
DFHSM	OW20500
DFSMSHsm	OW20192
DFDSS V2.5 (FMID HAE2502)	PN74583 PN77830
DFSMSdss 1.1.0, 1.2.0, 1.3.0 (FMID JDZ1120, HDZ11B0, HDZ11C0)	OW14835 OW16802

The APARs are described as followed:

- **APARS OW20500 and OW20192**

These allow the TAPE UTILIZATION to be specified with four digits, that is up to 9999. This function is needed in order to utilize the Magstar cartridge capacity if the tape utilization option is not NOLIMIT.

- **APARS PN74583 and OW14835**

These implement the new BUILDSA command and provide stand-alone support for restoration from a file that is not the first file on the tape.

- **APARS PN77830 and OW16802**

provide support for restoration from a file that is not the first file on the tape.

For more information refer to:

- *IBM 3591 Tape Control Unit Model A01 Introduction, Planning, and User's Guide.*

Your IBM installation planning representative and IBM marketing representative can determine the latest levels of software, microcode, and hardware available for your subsystem.

2. **Install DFSMS/MVS IOGEN**

Each IBM 3591-A01 ESCON control unit can have only one logical path specified to each host image. Specify four addresses for all IBM 3591-A01 control units, even if only two devices are attached.

Specify the IBM 3590-B1A drives as 3490E devices.

You also need to define an esoteric unit name for the devices as the StorageTek HSC uses it to direct the allocations.

3. **Set Cleaning program**

The drive cleaning mode is determined at installation; the service representative either enables or disables automatic cleaning for each IBM 3590-B1A drive. In automatic cleaning, a drive informs the Automated Cartridge System that cleaning is required; the Automated Cartridge System then delivers a cleaning cartridge to the drive. When automatic cleaning is disabled, the operator runs a job that mounts a cleaning cartridge (see Appendix A, "Sample Cleaning Program" on page 183 and Figure 86 on page 183).

In a mixed-drive environment, automatic cleaning is performed for non-3590 drives, while cleaning jobs are scheduled at regular intervals for IBM 3590-B1A drives. If there are no mixed media in the Automated Cartridge

System and only 3590 drives are present, then automatic cleaning can be enabled.

Install the cleaning job and the cleaning program even if automatic cleaning is enabled. You find information on how to obtain the necessary MVS JCL and source code of the cleaning program in Appendix A, "Sample Cleaning Program" on page 183.

4. ***Make HSC updates possible***

Define one or more statements for IBM 3590 Data Cartridges to identify tapes as:

- Long media operated with 36-track recording technology if HSC 1.2 is used
- A unique media type associated exclusively with the recording technology of the model type they emulate (4490 or 9490) if HSC 2.x is used.

Define one statement for IBM 3590 Cleaning Cartridges (prefix **MGC**); the same media and recording technology attributes used for IBM 3590 Data Cartridges should be applied.

The IBM 3590 Diagnostic Cartridges (prefix **DGC**) are not to be defined to the HSC.

Define unit attribute statements to associate IBM 3590-B1A drives with the model type they emulate.

Add statements as required to associate media for other drive types with their appropriate recording technology. Esoteric unit names are used to steer allocation inside and outside the StorageTek Automated Cartridge System.

Add one statement to designate a default recording technology. In a mixed configuration do not specify the IBM 3590 media as the default.

In an Automated Cartridge System that has only IBM 3590-B1A drive, the cleaning prefix for autocleaning can be set to **MGC**, and the drives themselves can be configured to request autocleaning. See also Section 5.9.2, "Operation" on page 178.

5. ***Install Hardware***

Relocate the cartridges in the LSM drive panel (top four and bottom four cartridge arrays) into which the IBM 3590-C12 is to be installed. This action is not necessary if you audit the LSM panel when the LSM is varied online.

Setup and verify the IBM 3590-C12 and IBM 3591-A01 before the LSM is taken offline. During installation, the LSM is offline for approximately 2 hours. Total installation time is 6.5 hours.

6. ***Restart the Host Component Software***

After the hardware is installed:

- a. Stop the HSC
- b. Run the reconfiguration program.
- c. Start HSC, with new LIBGEN and control statements in place.
- d. Enter IBM 3590 Magstar data and cleaning cartridges into the LSM.

5.9.2 Operation

Four types of operation are described:

- **Manual mode**

Varying the Library Storage Module (LSM) offline while the HSC is active allows you to enter the LSM and load cartridges manually into the IBM 3590-B1A drives. To load a cartridge manually, with the metal washer facing down, gently slide the cartridge into the drive's loading slot until it stops. Then, push the cartridge into the drive; after you push the cartridge about 1.5 cm into the drive, the loading mechanism pulls the cartridge into the drive and completes the load.

Some LSM actions can leave the drive unable to load a cartridge on the first mount after opening the LSM door. If pushing the cartridge into the drive fails to start the loader, leave the cartridge in the slot and select ALLOW LOAD on the display panel main menu. This should start the load. If it does not, remove the cartridge and repeat the manual loading procedure.

In manual mode, the panel displays the cartridge VOLSER and LSM cell coordinates.

- **Drive cleaning**

When IBM units are intermixed with StorageTek drives and media in an Automated Cartridge System, special measures are required to ensure that the IBM 3590 cleaning cartridges are mounted on IBM 3590-B1A drives, and StorageTek cleaning cartridges are mounted on StorageTek drives. Since a single cleaning prefix is available in support of all tape drives in an Automated Cartridge System, either IBM 3590-B1A drives or StorageTek drives, but not both, can be enabled for automatic cleaning.

At installation, the IBM 3590-B1A drives are configured to either enable or disable autocleaning in the Automated Cartridge System environment. It is recommended that IBM 3590 drives be enabled for autocleaning only when they are in an Automated Cartridge System containing only IBM 3590 drives and media. In a mixed-drive or mixed media Automated Cartridge System, the IBM 3590 drives are configured so that they do not request cleaning. Autocleaning is enabled for the Automated Cartridge System, but will be requested only by the StorageTek drives. IBM 3590-B1A drive cleaning is accomplished through special, regularly scheduled jobs that request mounting of an IBM 3590 cleaning cartridge on a specific IBM 3590 drive. Typically, once every day is sufficient; customize your cleaning schedule based on drive usage.

An example of a drive cleaning program and job control language can be obtained through FTP service. See Appendix A, "Sample Cleaning Program" on page 183 for more information. The cleaning program in that example receives a drive address as an input parameter. Defined constants in the program specify the cleaning prefix **MGC** and the high and low sequence numbers, 000-020, for the range of available cleaning cartridges. An additional defined constant specifies the maximum number of times that a cleaning cartridge should be used.

The example program searches for a suitable cleaning cartridge by starting at the low end of the range and issuing an SLSXREQ QVOLUME command for the VOLSER. If a cartridge is encountered that has been mounted for the maximum number of times, it is ejected from the library by means of SLSXREQ EJECT.

The sample cleaning program and the JCL are optimized for cleaning drives successively rather than concurrently. Four job steps are used to request the cleaning of each IBM 3590 tape drive in the IBM 3590-C12 frame.

- **External labels**

Typically, J is the media identification character for the IBM Magstar 3590 High Performance Tape Cartridge and is in the seventh character position. For IBM 3590-C12, cartridges without a media identification character are recommended for the reasons listed below.

The following consequences occur when using J-labeled cartridges:

- Warning messages appear on the operator console when the library vision system encounters this unexpected J media type
- Redundant robotic movements occur during the physical mounting of J-labeled cartridges
- J-labeled cartridges cannot be entered temporarily into the Automated Cartridge System to satisfy specific mount requests.

You can use J-labeled cartridges that are already present, but be aware of the effects listed above. It is recommended that the J labels be removed.

When existing J-labeled cartridges associated with IBM automated or stand-alone libraries or drives are requested for temporary or permanent entry in an Automated Cartridge System, the J can be removed or temporarily concealed to allow the cartridge to be used without the effects listed above.

Note: IBM Magstar 3590 cartridges without J-labels can be used effectively in IBM tape libraries and distinguished from other media types.

- **Inventories and catalogs.**

Inventories and catalogs that associate 3590 datasets with emulated 3490E tape units require future modification when the 3590 device type is introduced as a native device.

application data, DFHSM/ADSM or other migrated data, interchange data, archive data, local backup copies, or disaster backups copies, in the appropriate tape library or the real or virtual tape server. It does all of this using the technology of your choice, IBM 3490, IBM 3490E (real or virtual), or IBM 3590, and selects the cartridge type defined in DFSMS without any JCL changes.

- ***Virtual Tape Server***

The IBM 3590-B1A drives can also be moved into an IBM 3494-D12 frame. Used together with an IBM 3494-B16 frame, the combination forms a IBM Virtual Tape Server. This configuration will give you all the benefits of virtual tape support described in this book.

Appendix A. Sample Cleaning Program

An example of a drive cleaning program, and job control language, can be obtained over the Internet through file transfer protocol (FTP) server. The name of the anonymous FTP server is *index.storsys.ibm.com*. Access the FTP server as you would an anonymous service. The driver and documentation are in directory */devdrv*.

In summary:

FTP site: index.storsys.ibm.com
URL: ftp://index.storsys.ibm.com/devdrv
User: anonymous
Password: <email>
Files: /devdrv/3590_C12/README
/devdrv/3590_C12/clean_asm /* 370 assembler source example */

```
//CLEANMAG JOB 000,MSGLEVEL=(1,1)
//*
//CLNMAG PROC DEVNO=
//CLNDRV EXEC PGM=CLEANDRV,PARM='&DEVNO'
//STEPLIB DD DISP=SHR,DSN=YOUR.LINKLIB * LIBRARY CONTAINING PROGRAM
// DD DISP=SHR,DSN=SLS.SLSLINK * LIBRARY CONTAINING STK-CODE
//DUMDD DD UNIT=(&DEVNO,,DEFER) * STOP OTHERS USING DRIVE
// PEND
//*
//CLNE50 EXEC CLNMAG,DEVNO=E50
//CLNE51 EXEC CLNMAG,DEVNO=E51
//CLNE52 EXEC CLNMAG,DEVNO=E52
//CLNE53 EXEC CLNMAG,DEVNO=E53
//
```

Figure 86. JCL for Sample Cleaning Program

The sample program requires the device number of the tape drive to be cleaned as a parameter. The device number may be specified with three or four characters.

The return code from this program is:

104	Invalid input
108	Cleaner cartridge not available
R15 after SLSXREQ call	HSC not active
Value of SLXCMDRC	Mount of cleaner cartridge failed

Appendix B. Special Notices

This publication is intended to help storage system technical professionals both in customers and IBM to implement IBM Magstar Virtual Tape Server and other Magstar enhancements that are announced in September 1996. The information in this publication is not intended as the specification of any programming interfaces that are provided by IBM Magstar Virtual Tape Server subsystem, IBM 3590-A00 tape control unit, IBM 3591-A01 tape control unit, IBM 3590-C12 frame, IBM Magstar MP tape subsystem, or IBM 3494 Tape Library enhancements.

References in this publication to IBM products, programs or services do not imply that IBM intends to make these available in all countries in which IBM operates. Any reference to an IBM product, program, or service is not intended to state or imply that only IBM's product, program, or service may be used. Any functionally equivalent program that does not infringe any of IBM's intellectual property rights may be used instead of the IBM product, program or service.

Information in this book was developed in conjunction with use of the equipment specified, and is limited in application to those specific hardware and software products and levels.

IBM may have patents or pending patent applications covering subject matter in this document. The furnishing of this document does not give you any license to these patents. You can send license inquiries, in writing, to the IBM Director of Licensing, IBM Corporation, 500 Columbus Avenue, Thornwood, NY 10594 USA.

Licensees of this program who wish to have information about it for the purpose of enabling: (i) the exchange of information between independently created programs and other programs (including this one) and (ii) the mutual use of the information which has been exchanged, should contact IBM Corporation, Dept. 600A, Mail Drop 1329, Somers, NY 10589 USA.

Such information may be available, subject to appropriate terms and conditions, including in some cases, payment of a fee.

The information contained in this document has not been submitted to any formal IBM test and is distributed AS IS. The information about non-IBM ("vendor") products in this manual has been supplied by the vendor and IBM assumes no responsibility for its accuracy or completeness. The use of this information or the implementation of any of these techniques is a customer responsibility and depends on the customer's ability to evaluate and integrate them into the customer's operational environment. While each item may have been reviewed by IBM for accuracy in a specific situation, there is no guarantee that the same or similar results will be obtained elsewhere. Customers attempting to adapt these techniques to their own environments do so at their own risk.

Any performance data contained in this document was determined in a controlled environment, and therefore, the results that may be obtained in other operating environments may vary significantly. Users of this document should verify the applicable data for their specific environment.

Reference to PTF numbers that have not been released through the normal distribution process does not imply general availability. The purpose of

including these reference numbers is to alert IBM customers to specific information relative to the implementation of the PTF when it becomes available to each customer according to the normal IBM PTF distribution process.

You can reproduce a page in this document as a transparency, if that page has the copyright notice on it. The copyright notice must appear on each page being reproduced.

The following terms are trademarks of the International Business Machines Corporation in the United States and/or other countries:

ADSTAR	AIX
AIX/6000	AS/400
DFSMS	DFSMS/MVS
DFSMS/VM	DFSMSdfp
DFSMSdss	DFSMSshsm
DFSMSrmm	DFSORT
Enterprise System/3090	Enterprise System/9000
Enterprise Systems Architecture/370	Enterprise Systems Architecture/390
Enterprise Systems Connection Architecture	ES/3090
ES/9000	ESA/370
ESA/390	ESCON XDF
ESCON	IBM
Magstar	MVS
MVS/DFP	MVS/ESA
MVS/SP	MVS/XA
Operating System/2	Operating System/400
OS/2	OS/390
OS/400	Parallel Sysplex
POWERparallel	PR/SM
RAMAC	RISC System/6000
RMF	RS/6000
S/370	S/390
Scalable POWERparallel Systems	SP2
System/370	System/390
Virtual Machine/Enterprise Systems Architecture	VM/ESA
VSE/ESA	

The following terms are trademarks of other companies:

C-bus is a trademark of Corollary, Inc.

PC Direct is a trademark of Ziff Communications Company and is used by IBM Corporation under license.

UNIX is a registered trademark in the United States and other countries licensed exclusively through X/Open Company Limited.

Microsoft, Windows, and the Windows 95 logo are trademarks or registered trademarks of Microsoft Corporation.

Other trademarks are trademarks of their respective companies.

Appendix C. Related Publications

The publications listed in this section are considered particularly suitable for a more detailed discussion of the topics covered in this redbook.

C.1 International Technical Support Organization Publications

For information on ordering these ITSO publications see "How To Get ITSO Redbooks" on page 189.

- *Magstar and IBM 3590 High Performance Tape Subsystem Technical Guide*, GG24-2506
- *Magstar and IBM 3590 High Performance Tape Subsystem: Multiplatform Implementation*, SG24-2594
- *Guide to Sharing and Partitioning IBM Automated Tape Library Dataservers*, SG24-4409

C.2 Redbooks on CD-ROMs

Redbooks are also available on CD-ROMs. **Order a subscription** and receive updates 2-4 times a year at significant savings.

CD-ROM Title	Subscription Number	Collection Kit Number
System/390 Redbooks Collection	SBOF-7201	SK2T-2177
Networking and Systems Management Redbooks Collection	SBOF-7370	SK2T-6022
Transaction Processing and Data Management Redbook	SBOF-7240	SK2T-8038
AS/400 Redbooks Collection	SBOF-7270	SK2T-2849
RISC System/6000 Redbooks Collection (HTML, BkMgr)	SBOF-7230	SK2T-8040
RISC System/6000 Redbooks Collection (PostScript)	SBOF-7205	SK2T-8041
Application Development Redbooks Collection	SBOF-7290	SK2T-8037
Personal Systems Redbooks Collection	SBOF-7250	SK2T-8042

C.3 Other Publications

These publications are also relevant as further information sources:

- *IBM 3590 High Performance Tape Subsystem Introduction and Planning Guide*, GA32-0329
- *IBM 3590 High Performance Tape Subsystem User's Guide*, GA32-0330
- *IBM 3590 High Performance Tape Subsystem Hardware Reference*, GA32-0331
- *IBM 3590 Magstar High Performance Tape Subsystem Silo-Compatible Frame Model C12 Introduction, Planning, and User's Guide*, GA32-0366.
- *IBM 3591 Tape Control Unit Model A01 Introduction, Planning, and User's Guide*, GA32-0358
- *IBM 3494 Tape Library Dataserver Introduction and Planning Guide*, GA32-0279
- *IBM 3495 Tape Library Dataserver Introduction and Planning Guide*, GA32-0234

- *DFSMS/MVS Version 1 Release 3 Object Access Method Planning, Installation, and Administration Guide for Tape Libraries*, SC26-3051
- *Basic Tape Library Support Version 1 Release 1 User's Guide and reference*, SC26-7016
- *VM/ESA DFSMS/VM Function Level 221 Removable Media Services User's Guide and Reference*, SC35-0141

How To Get ITSO Redbooks

This section explains how both customers and IBM employees can find out about ITSO redbooks, CD-ROMs, workshops, and residencies. A form for ordering books and CD-ROMs is also provided.

This information was current at the time of publication, but is continually subject to change. The latest information may be found at URL <http://www.redbooks.ibm.com>.

How IBM Employees Can Get ITSO Redbooks

Employees may request ITSO deliverables (redbooks, BookManager BOOKs, and CD-ROMs) and information about redbooks, workshops, and residencies in the following ways:

- **PUBORDER** — to order hardcopies in United States
- **GOPHER link to the Internet** - type GOPHER.WTSCPOK.ITSO.IBM.COM
- **Tools disks**

To get LIST3820s of redbooks, type one of the following commands:

```
TOOLS SENDTO EHONE4 TOOLS2 REDPRINT GET SG24xxxx PACKAGE
TOOLS SENDTO CANVM2 TOOLS REDPRINT GET SG24xxxx PACKAGE (Canadian users only)
```

To get lists of redbooks:

```
TOOLS SENDTO WTSCPOK TOOLS REDBOOKS GET REDBOOKS CATALOG
TOOLS SENDTO USDIST MKTTOOLS MKTTOOLS GET ITSOCAT TXT
TOOLS SENDTO USDIST MKTTOOLS MKTTOOLS GET LISTSERV PACKAGE
```

To register for information on workshops, residencies, and redbooks:

```
TOOLS SENDTO WTSCPOK TOOLS ZDISK GET ITSOREGI 1996
```

For a list of product area specialists in the ITSO:

```
TOOLS SENDTO WTSCPOK TOOLS ZDISK GET ORGCARD PACKAGE
```

- **Redbooks Home Page on the World Wide Web**

<http://w3.itso.ibm.com/redbooks>

- **IBM Direct Publications Catalog on the World Wide Web**

<http://www.elink.ibm.link.ibm.com/pb1/pb1>

IBM employees may obtain LIST3820s of redbooks from this page.

- **REDBOOKS category on INEWS**
- **Online** — send orders to: USIB6FPL at IBMMAIL or DKIBMBSH at IBMMAIL
- **Internet Listserver**

With an Internet E-mail address, anyone can subscribe to an IBM Announcement Listserver. To initiate the service, send an E-mail note to announce@webster.ibm.link.ibm.com with the keyword subscribe in the body of the note (leave the subject line blank). A category form and detailed instructions will be sent to you.

How Customers Can Get ITSO Redbooks

Customers may request ITSO deliverables (redbooks, BookManager BOOKs, and CD-ROMs) and information about redbooks, workshops, and residencies in the following ways:

- **Online Orders** (Do not send credit card information over the Internet) — send orders to:

	IBMMAIL	Internet
In United States:	usib6fpl at ibmmail	usib6fpl@ibmmail.com
In Canada:	caibmbkz at ibmmail	lmannix@vnet.ibm.com
Outside North America:	dkibmbsh at ibmmail	bookshop@dk.ibm.com

- **Telephone orders**

United States (toll free)	1-800-879-2755
Canada (toll free)	1-800-IBM-4YOU
Outside North America	(long distance charges apply)
(+45) 4810-1320 - Danish	(+45) 4810-1020 - German
(+45) 4810-1420 - Dutch	(+45) 4810-1620 - Italian
(+45) 4810-1540 - English	(+45) 4810-1270 - Norwegian
(+45) 4810-1670 - Finnish	(+45) 4810-1120 - Spanish
(+45) 4810-1220 - French	(+45) 4810-1170 - Swedish

- **Mail Orders** — send orders to:

IBM Publications Publications Customer Support P.O. Box 29570 Raleigh, NC 27626-0570 USA	IBM Publications 144-4th Avenue, S.W. Calgary, Alberta T2P 3N5 Canada	IBM Direct Services Sortemosevej 21 DK-3450 Allerød Denmark
--	--	--

- **Fax** — send orders to:

United States (toll free)	1-800-445-9269
Canada	1-403-267-4455
Outside North America	(+45) 48 14 2207 (long distance charge)

- **1-800-IBM-4FAX (United States) or (+1) 415 855 43 29 (Outside USA)** — ask for:

Index # 4421 Abstracts of new redbooks
Index # 4422 IBM redbooks
Index # 4420 Redbooks for last six months

- **Direct Services** - send note to softwareshop@vnet.ibm.com

- **On the World Wide Web**

Redbooks Home Page	http://www.redbooks.ibm.com
IBM Direct Publications Catalog	http://www.elink.ibm.com/pbl/pbl

- **Internet Listserver**

With an Internet E-mail address, anyone can subscribe to an IBM Announcement Listserv. To initiate the service, send an E-mail note to announce@webster.ibm.com with the keyword `subscribe` in the body of the note (leave the subject line blank).

IBM Redbook Order Form

Please send me the following:

Title	Order Number	Quantity
-------	--------------	----------

- Please put me on the mailing list for updated versions of the IBM Redbook Catalog.
-

First name	Last name
------------	-----------

Company

Address

City	Postal code	Country
------	-------------	---------

Telephone number	Telefax number	VAT number
------------------	----------------	------------

- Invoice to customer number _____

- Credit card number _____
-

Credit card expiration date	Card issued to	Signature
-----------------------------	----------------	-----------

We accept American Express, Diners, Eurocard, Master Card, and Visa. Payment by credit card not available in all countries. Signature mandatory for credit card payment.

DO NOT SEND CREDIT CARD INFORMATION OVER THE INTERNET.

Index

A

ACS routine
 scratch allocation 171
 storage class 171
 storage group 171
aggregate data rate
 IBM 3590-A00 87
allocation
 automatic class selection routine 171
 Host Software Component 173
 scratch request 171
 Silo 171, 173
 specific request 173
 tape library 171, 173
attention message
 IBM Magstar MP 139
Automated Cartridge System
 cleaning program 176
 drive cleaning 178
 operation 178
automatic class selection
 See ACS
automatic mode
 IBM Magstar MP 140

B

bandwidth
 tape 5
Basic Tape Library Support
 See BTLS
block ID
 Virtual Tape Server 75
BTLS
 Virtual Tape Server 33, 71
buffer memory
 IBM 3590-A00 87

C

cable
 IBM Magstar MP 153
capacity
 tape cartridge 5
cartridge feature
 announcement 6
 IBM 3494 extension 7
 IBM 3494-B16 7
 IBM 3495-B16 7
 IBM 3570 7
 IBM 3590-A00 7
 IBM 3590-A14 7
 IBM 3590-C12 7
 IBM Magstar MP 7

cartridge magazine
 IBM Magstar MP 130, 134
cartridge ordering
 IBM Magstar MP 152
cartridge system tape
 See CST
channel attachment
 Virtual Tape Server 21
cleaning program
 Automated Cartridge System 176
 IBM 3590 183
 IBM 3590-B1A 176
 IBM 3590-C12 183
 IBM 3591 tape subsystem 183
 Silo 176
compaction ratio
 Virtual Tape Server 75
compression
 physical volume 59
 virtual volume 58
configuration
 IBM 3494 93
 IBM 3495 98
 IBM 3590 tape subsystem 90
 IBM 3590-C12 160
 IBM AS/400 149
 IBM Magstar MP 145, 149
 IBM RISC System/6000 145
 POWERparallel SP 145
 Silo 160
 StorageTek Automated Cartridge System 160
 Virtual Tape Server 24
CST
 logical volume 24
 virtual volume 59

D

data
 coded 4
data invalidation
 logical volume 52
 Virtual Tape Server 52
Data Security Erase command
 Virtual Tape Server 75
data source
 CD music 4
 color picture 4
 moving images 4
 scientific 4
 video images 4
 voice 4
DDR 74
definition
 logical volume 68

- definition (*continued*)
 - physical volume 69
- device coexistence
 - Virtual Tape Server 65
- device driver
 - IBM Magstar MP 153
- device emulation
 - IBM 3490E 88
 - IBM 3591-A01 88
- DFSMS system-managed tape
 - Virtual Tape Server 70
- DFSMS/MVS
 - Virtual Tape Server 33
- DFSMS/VM
 - Virtual Tape Server 34
- dimension
 - IBM 3494-B16 42
 - IBM 3495-B16 49
 - IBM Magstar MP 131
 - Virtual Tape Server 42, 49
- display
 - IBM 3590-C12 163
 - Texas Digital Systems, Inc. (TDS) 163
- drive cleaning
 - Automated Cartridge System 178
 - IBM 3590-B1A 178
 - IBM 3590-C12 178
 - Silo 178
- dynamic device reconfiguration
 - See DDR

E

- ECCST
 - logical volume 24
 - virtual volume 59
- EDGINERS
 - Virtual Tape Server 51
- end-of-data
 - See EOD
- enhanced capacity cartridge system tape
 - See ECCST
- enterprise systems connection
 - See ESCON
- Environmental Record Editing and Printing
 - See EREP
- environmentals
 - IBM 3494-B16 42
 - IBM 3495-B16 49
 - IBM Magstar MP 131
 - Virtual Tape Server 42, 49
- EOD
 - Virtual Tape Server 75
- Erase Gap command
 - Virtual Tape Server 75
- EREP
 - Virtual Tape Server 33, 34
- error recovery
 - physical volume 81

- error recovery (*continued*)
 - Virtual Tape Server 81
- ESCON
 - IBM 3590 tape subsystem 12
- ESCON adapter
 - IBM 3591-A01 168
- ESCON attachment
 - IBM 3590-A00 85
- ESCON channel
 - Virtual Tape Server 35
- ESCON configuration
 - IBM 3494 93
- ESCON connectivity
 - IBM 3590 tape subsystem 84
- ESCON considerations
 - IBM 3590 tape subsystem 91
- ESCON tape control unit
 - comparison 88
 - IBM 3590-A00 88
 - IBM 3591-A01 88
- event logging
 - Virtual Tape Server 76
 - virtual volume 77
- external label
 - IBM 3590 cartridge 179
 - IBM 3590-C12 164, 179
 - Silo 164, 179

F

- Fast-Ready attribute
 - logical volume 28, 52
 - scratch mount 69
 - setting 69
 - Virtual Tape Server 52
- features
 - IBM 3494 39, 120
 - IBM 3494-B16 40
 - IBM 3495 47
 - IBM 3495-B16 47
 - IBM 3590 tape subsystem 101
 - IBM 3590-B1A 165
 - IBM 3590-C12 164
 - IBM 3591-A01 168
 - IBM Magstar MP 152
 - Remote Support Facility 168
 - Virtual Tape Server 39, 47

H

- hardware configuration definition
 - See HCD
- HCD
 - virtual device 27
 - Virtual Tape Server 27, 68
- helical scan
 - RedWood SD-3 Helical Cartridge Tape Subsystem 157

- HSC
 - device combination 169, 170
 - IBM 3590 169, 170
 - installation 177
 - level 2.1 169
 - level 2.x 170
 - specific allocation 173
 - StorageTek 4480 170
 - StorageTek 4490 170
 - StorageTek 9490 170
 - StorageTek SD-3 170

- I
 - I/O adapter
 - IBM RISC System/6000 146
 - I/O configuration program
 - See IOCP
 - IBM 3480 compatible
 - 4480 Cartridge Tape Subsystem 156
 - IBM 3490E
 - device emulation 88
 - Silo 158
 - IBM 3490E compatible
 - Silverton 4490 Cartridge Subsystem 157
 - Timberline 9490 Cartridge Tape Subsystem 157
 - IBM 3494
 - 30-cartridge I/O station 116
 - capacity requirements 113
 - cartridge and drive capacity 115
 - cartridge and drive unit maximums 119
 - configuration 93
 - current capacity enhancements 116
 - ESCON configuration 93
 - expanded capacity configuration options 119
 - extension 7
 - features 39
 - installation considerations 121
 - model upgrades 41
 - new features 120
 - scratch allocation 171
 - support for 16 control units 116
 - Virtual Tape Server 21
 - Virtual Tape Server configuration 24, 30, 37
 - IBM 3494 extension
 - announcement 7
 - planned available date 8
 - IBM 3494-B16
 - announcement 7
 - dimension 42
 - environmentals 42
 - features 40
 - Library Manager attachment 35
 - planned available date 8
 - Remote Support Facility 38
 - Virtual Tape Server 18
 - Virtual Tape Server configuration 31, 37
 - IBM 3494-D10
 - Virtual Tape Server configuration 31
 - IBM 3494-D12
 - Library Manager attachment 35
 - Virtual Tape Server configuration 31
 - IBM 3494-D14
 - Virtual Tape Server configuration 31
 - IBM 3494-L10
 - Virtual Tape Server configuration 30
 - IBM 3494-L12
 - Virtual Tape Server configuration 30
 - IBM 3494-L14
 - Virtual Tape Server configuration 30
 - IBM 3494-S10
 - Virtual Tape Server configuration 31
 - IBM 3495
 - configuration 98
 - features 47
 - frame replacement 45
 - Library Manager attachment 44
 - scratch allocation 171
 - Virtual Tape Server 19, 21
 - Virtual Tape Server configuration 25, 31, 43
 - IBM 3495-B16
 - announcement 7
 - dimension 49
 - environmentals 49
 - features 47
 - planned available date 8
 - Remote Support Facility 44
 - Virtual Tape Server 19
 - Virtual Tape Server configuration 43
 - IBM 3495-L20 98
 - IBM 3495-L30 98
 - IBM 3495-L40 98
 - IBM 3495-L50 98
 - IBM 3495-M10 97
 - IBM 3570
 - See IBM Magstar MP
 - IBM 3570-B00
 - IBM Magstar MP 127, 129
 - IBM 3570-B01
 - IBM Magstar MP 127, 130
 - IBM 3570-B02
 - IBM Magstar MP 127, 130
 - IBM 3570-B11
 - IBM Magstar MP 127, 130
 - IBM 3570-B12
 - IBM Magstar MP 127, 130
 - IBM 3590
 - cleaning cartridge 169
 - data cartridge 169
 - Host Software Component 169
 - migration 108
 - MVS/ESA 110
 - sample cleaning program 183
 - software support 110
 - TPF 111
 - Virtual Tape Server 18, 21
 - VM/ESA 111

- IBM 3590 (*continued*)
 - VSE/ESA 111
- IBM 3590 cartridge
 - external label 179
- IBM 3590 tape drive
 - IBM 3590-A00 85
- IBM 3590 tape subsystem
 - announcement summary 12, 14
 - configuration for S/390 90
 - ESCON connectivity 84
 - ESCON considerations 91
 - features 101
 - IBM 3590-A14 96
 - Library Manager attachment 92
 - MES field-installation features 103
 - new features 103
 - non-chargeable features 102
 - Silo 155, 159
 - StorageTek Automated Cartridge System 155
- IBM 3590-A00
 - aggregate data rate 87
 - announcement 7
 - buffer memory 87
 - comparison 88
 - ESCON attachment 85
 - IBM 3590 tape drive 85
 - IBM 3590-A14 85
 - logical path 86
 - path 89
 - physical path 86
 - planned available date 8
 - schematic diagram 87
 - sharing IBM 3590 tape drives 89
 - subsystem housing 89
 - Virtual Tape Server configuration 30
- IBM 3590-A14
 - announcement 7
 - IBM 3590 tape subsystem 96
 - IBM 3590-A00 85
 - planned available date 8
 - Virtual Tape Server configuration 31, 43
- IBM 3590-B1A
 - cleaning program 176
 - Feature 2003 165
 - Feature 9000 165
 - features 165
 - IBM 3590-C12 162
 - Virtual Tape Server configuration 30, 31
- IBM 3590-C12
 - announcement 7
 - display 163
 - external label 164, 179
 - Feature 520x 164
 - Feature 8002 164
 - Feature 8210 164
 - Feature 8220 164
 - Feature 9590 164
 - Feature 9986 165
- IBM 3590-C12 (*continued*)
 - features 164
 - IBM 3590-B1A 162
 - IBM 3591-A01 162
 - installation 175
 - physical characteristics 163
 - planned available date 8
 - PTF 175
 - sample cleaning program 183
 - SCSI cable 164
 - Silo 7, 158, 159, 160
 - Silo-compatible frame 162
 - StorageTek Automated Cartridge System 7, 160
 - Texas Digital Systems, Inc. (TDS) 163
- IBM 3591 tape subsystem
 - sample cleaning program 183
- IBM 3591-A01
 - comparison 88
 - device emulation 88
 - ESCON adapter 168
 - Feature 2700 168
 - Feature 2701 168
 - Feature 2702 168
 - Feature 3311 168
 - Feature 5000 168
 - features 168
 - IBM 3590-C12 162, 166
 - logical path 166
 - path 89
 - physical characteristics 167
 - planned available date 8
 - sharing IBM 3590 tape drives 89
 - software support 167
 - subsystem housing 89
- IBM 3850 Mass Storage Subsystem (MSS) 9
- IBM announcements
 - cartridge feature 6
 - IBM 3570 15
 - IBM 3590 tape subsystem 12, 14
 - IBM Magstar MP tape subsystem 15
 - Virtual Tape Server 6
- IBM AS/400 configurations
 - IBM Magstar MP 149
- IBM AS/400 software support
 - IBM Magstar MP 151
- IBM Magstar MP
 - 10-cartridge magazine 130, 134
 - announcement 7
 - attention message 139
 - automatic mode 140
 - cables 153
 - cartridge ordering 152
 - configuration 145, 149
 - data transfer rate 129
 - device drivers 153
 - dimension 131
 - environmentals 131
 - features 152

- IBM Magstar MP (*continued*)
 - IBM 3570-B00 127, 129
 - IBM 3570-B01 127, 130
 - IBM 3570-B02 127, 130
 - IBM 3570-B11 127, 130
 - IBM 3570-B12 127, 130
 - IBM AS/400 cables interposer 150
 - IBM AS/400 configurations 149
 - IBM AS/400 software support 151
 - IBM RISC System/6000 configurations 145
 - IBM RISC System/6000 software support 148
 - Input/Output cell 135
 - interposers 153
 - introduction 124
 - library loader 134
 - library magazine 133
 - library models 130
 - manual mode 141
 - models 127
 - modes of operation 140
 - operator panel 135, 136
 - planned available date 8
 - POWERparallel SP configuration 145
 - priority cell 135
 - random mode 141
 - SCSI cable 146
 - sequential mode 140
 - software support 148, 151
 - tape cartridge 129, 143
- IBM Magstar MP tape subsystem
 - announcement summary 15
- IBM RAMAC Virtual Array Subsystem 9
- IBM RISC System/6000
 - I/O adapter 146
 - interfaces 146
 - SCSI cable 146
 - supported models 146
- IBM RISC System/6000 configurations
 - IBM Magstar MP 145
- IBM RISC System/6000 software support
 - IBM Magstar MP 148
- IDRC
 - logical volume 24
 - virtual volume 59
- IEHINITT
 - Virtual Tape Server 51
- improved data recording capability
 - See IDRC
- information explosion
 - magnetic tape 2
- Input/Output cell
 - IBM Magstar MP 135
- installation
 - Host Software Component 177
 - IBM 3590-C12 175
- installation considerations
 - IBM 3494 121

- installation tasks
 - Virtual Tape Server 67
- interfaces
 - IBM RISC System/6000 146
- interposer
 - IBM Magstar MP 153
- inventories and catalog
 - Silo 179
- inventory
 - Virtual Tape Server 67
- IOCP
 - virtual device 27
 - Virtual Tape Server 27

J

- JES3
 - Virtual Tape Server 33

L

- library loader
 - IBM Magstar MP 134
- library magazine
 - Magstar MP 133
- Library Manager
 - displayed information 78
 - logical volume 28
 - SMF record type 94 77
 - statistics 77
 - Virtual Tape Server 65
- Library Manager attachment
 - IBM 3494-B16 35
 - IBM 3494-D12 35
 - IBM 3495 44
 - IBM 3590 tape subsystem 92
 - RS-232 36
 - RS-422 35
 - Virtual Tape Server 35, 44
- library modes
 - IBM Magstar MP 140
- Load Display command
 - Virtual Tape Server 75
- logging
 - Virtual Tape Server 76
 - virtual volume 77
- logical partitioning
 - Virtual Tape Server 67
- logical path
 - IBM 3590-A00 86, 89
 - IBM 3591-A01 89, 166
- logical volume
 - concept 28
 - CST 24
 - data invalidation 52
 - definition 68
 - ECCST 24
 - Fast-Ready attribute 28, 52
 - IDRC 24

logical volume (*continued*)

- Library Manager 28
- MEDIA1 24
- MEDIA2 24
- space reclamation 56
- tape volume cache 28
- Virtual Tape Server 24
- virtual volume 28

M

- magnetic tape
 - information explosion 2
- manual mode
 - IBM Magstar MP 141
- MEDIA1
 - logical volume 24
- MEDIA2
 - logical volume 24
- migration
 - DFSMSHsm 108
 - IBM 3590 108, 180
 - native 3490E 74
 - Silo 180
 - Virtual Tape Server 73
- model upgrades
 - IBM 3494 41
- modem
 - Remote Support Facility 38, 44
- monitoring
 - Virtual Tape Server 76
- mount response time
 - virtual volume 59
- MVS/DFP
 - Virtual Tape Server 33
- MVS/ESA
 - BTLS 71
 - DFSMS system-managed tape 70
 - IBM 3590 support 110
 - Virtual Tape Server 33, 70

N

- nonspecific mount
 - Virtual Tape Server 51

O

- operation
 - Automated Cartridge System 178
 - drive cleaning 178
 - Silo 178
- operator panel
 - attention message 139
 - IBM Magstar MP 135, 136
- ordering
 - tape cartridge 105

P

- partitioning
 - Library Manager 65
 - Virtual Tape Server 65
- physical characteristics
 - IBM 3591-A01 167
- physical device
 - concept 29
 - Virtual Tape Server 29
- physical installation
 - Virtual Tape Server 67
- physical path
 - IBM 3590-A00 86, 89
 - IBM 3591-A01 89
- physical volume
 - compression 59
 - concept 28
 - definition 69
 - error recovery 81
 - space reclamation 56
 - Virtual Tape Server 28, 69
- planned available date 8
- POWERparallel SP configuration
 - IBM Magstar MP 145
- priority cell
 - IBM Magstar MP 135
- random mode 141
- PTF
 - IBM 3590-C12 175

Q

- QUIETIS 64

R

- RAID
 - Tape Volume Cache 21
- random access
 - virtual volume 60
- random mode
 - IBM Magstar MP 141
 - priority cell 141
- Read Buffer command
 - Virtual Tape Server 75
- Redundant Array of Inexpensive Disk
 - See RAID
- Remote Support Facility
 - See RSF
- RS-232
 - Library Manager attachment 36
 - Virtual Tape Server 36
- RS-422
 - Library Manager attachment 35
 - Virtual Tape Server 35
- RSF
 - IBM 3494-B16 38
 - IBM 3495-B16 44

RSF (*continued*)
IBM 3591-A01 168
modem 38, 44

S

scratch mount
Fast-Ready attribute 69
Virtual Tape Server 51

SCSI
IBM 3570 15
IBM 3590 tape subsystem 14
IBM Magstar MP tape subsystem 15

SCSI cable
IBM 3590-C12 164
IBM Magstar MP 150

sequential mode
IBM Magstar MP 140

Serial Storage Architecture
See SSA

sharing IBM 3590 tape drives
IBM 3590-A00 89
IBM 3591-A01 89

Silo
4410 Automated Cartridge System 156
9310 PowderHore Automated Cartridge System 156
cleaning program 176
configuration 160
device combination 169
drive cleaning 178
ESCON director 161
external label 179
Host Software Component 156, 161
IBM 3490E 158
IBM 3590 tape subsystem 155, 159
IBM 3590-C12 7, 158, 159, 160, 162
IBM 3591-A01 161
inventories and catalog 179
Library Control Unit 157, 160
Library Management Unit 157, 161
Library Storage Module 157, 160
migration 180
Network Controller 161
operation 178
PowderHore 156
scratch allocation 171
specific allocation 173
Virtual Tape Server 181

sizing
guidelines 61
tools 63
Virtual Tape Server 61, 63

small computer system interface
See SCSI

SMF record type 94
Library Manager statistics 77
Virtual Tape Server operational information 78

software implementation
BTL5 71
DFSMS system-managed tape 70
MVS/ESA 70
VM/ESA 71
VSE/ESA 71

software support
IBM 3590 110
IBM 3591-A01 167
IBM Magstar MP 148, 151
Virtual Tape Server 33

space reclamation
logical volume 56
physical volume 56
schedule 69
Tape Volume Cache 55
Virtual Tape Server 55, 69

specific mount
Virtual Tape Server 54

SSA
Virtual Tape Server 22

stacked volume
concept 28
Virtual Tape Server 28

statistics
Library Manager 77
SMF record type 94 77
Virtual Tape Server 76

storage capacity
Virtual Tape Server 25

storage cell
IBM 3495 44
Virtual Tape Server 44

storage class
scratch allocation 171

storage group
scratch allocation 171

StorageTek 157
4410 Automated Cartridge System 156
4480 Cartridge Tape Subsystem 156
4480 tape drive 169
4490 tape drive 169
9310 PowderHore Automated Cartridge System 156
9490 tape drive 169
Host Software Component 156, 161
Library Control Unit 157
Library Management Unit 157, 161
Library Storage Module 157
Nearline 156
PowderHore 156
RedWood SD-3 Helical Cartridge Tape Subsystem 157
Silo 156, 157
Silverton 4490 Cartridge Subsystem 157
Timberline 9490 Cartridge Tape Subsystem 157
StorageTek Automated Cartridge System configuration 160

StorageTek Automated Cartridge System (*continued*)

- ESCON director 161
- Host Software Component 161
- IBM 3590 tape subsystem 155
- IBM 3590-C12 7, 160
- IBM 3591-A01 161
- Library Control Unit 160
- Library Management Unit 161
- Library Storage Module 160
- Network Controller 161

stub

- Virtual Tape Server 51
- virtual volume 51

T

- tape cartridge
 - IBM Magstar MP 129, 143
 - ordering 105
- Tape Configuration Database
 - See TCDB
- tape control unit
 - IBM 3590-A00 7
 - IBM 3591-A01 7
- Tape Data Set Analysis
 - See TDSA
- tape label
 - initialize 51
 - Virtual Tape Server 27, 51
- tape library
 - scratch allocation 171
- Tape Mount Management
 - See TMM
- tape positioning commands
 - virtual volume 60
- tape utilization
 - bandwidth 5
 - cartridge capacity 5
 - study 5
- Tape Volume Cache
 - See TVC
- tape-to-tape application 5
- TCDB
 - specific allocation 173
- TDSA 64
- teach
 - Virtual Tape Server 67
- Texas Digital Systems, Inc. (TDS)
 - display 163
 - IBM 3590-C12 163
- TMM 3
- tools
 - DASD and Tape Magic for OS/2 64
 - Quick and easy tape investigation and simulation
 - See QUIETIS
 - Volume Mount Analyzer
 - See VMA
- TPF
 - IBM 3590 support 111

Transaction Processing Facility

See TPF

TVC

- IBM 3494 24
- IBM 3495 25
- logical volume 28
- RAID 21
- space reclamation 55
- Virtual Tape Server 54
- virtual volume 21

V

vaulting

- Virtual Tape Server 80

virtual device

- characteristics 27
- coexistence 65
- concept 27
- definition 27
- HCD 27
- IBM 3490E 65
- IOCP 27
- Virtual Tape Server 27

virtual disk 9

virtual storage 9

virtual tape 9

Virtual Tape Server

See VTS

virtual volume

- advantage 59
- capacity 59
- characteristics 27
- compression 58
- concept 27
- CST 59
- ECCST 59
- event logging 77
- IDRC 59
- logical volume 28
- mount response time 59
- random access 60
- stub 51
- tape positioning commands 60
- Tape Volume Cache 21, 54

VM/ESA

- IBM 3590 support 111
- Virtual Tape Server 34, 71

VMA 63

volume serial

- definition 68
- logical volume 68
- physical volume 69
- Virtual Tape Server 53, 68

VSE/ESA

- IBM 3590 support 111
- Virtual Tape Server 34, 71

VTS

- announce 18

VTS (continued)

- announcement 6, 7
- block ID 75
- BTLS 33
- channel attachment 21
- coexistence 21
- compaction ratio 75
- configuration 24
- configuration guidelines 37, 43
- controller 7, 20
- CST 24
- data invalidation 52
- Data Security Erase command 75
 - DDR 74
- DFSMS/MVS 33
- DFSMS/VM 34
- dimension 42, 49
- ECCST 24
- EDGINERS 51
- environmentals 42, 49
- Erase Gap command 75
- EREP 33, 34
- error recovery 81
- ESCON channel 35
- event logging 76
- Fast-Ready attribute 52
- features 39, 47
- frame replacement 45
- HCD 27, 68
- IBM 3494 18, 20, 21, 30
- IBM 3494-B16 18, 31
- IBM 3494-D10 31
- IBM 3494-D12 31
- IBM 3494-D14 31
- IBM 3494-S10 31
- IBM 3495 21, 31
- IBM 3495-B16 19, 43
- IBM 3590 18, 21
- IBM 3590-A14 43
- IDRC 24
- IEHINITT 51
- installation tasks 67
- introduction 20
- inventory 67
- IOCP 27
- JES3 33
- key attributes 23
- key concepts 26
- Library Manager attachment 35
- Load Display command 75
- logging 76
- logical data flow 50
- logical partitioning 67
- logical tape drive 23
- logical volume 24, 28
- MEDIA1 24
- MEDIA2 24
- migration 73

VTS (continued)

- monitoring 76
- MVS/DFP 33
- MVS/ESA 33
- nonspecific mount 51
- operational considerations 80
- operational information 78
- operational statistics 76
- partitioning 65
- physical device 29
- physical installation 65, 67
- physical tape drive 23
- physical volume 28
- planned available date 8
- positioning beyond EOD 75
- Read Buffer command 75
- scratch mount 51
- Serial Storage Architecture 22
- Silo 181
- sizing 63
- sizing guidelines 61
- software implementation 70
- software support 33
- software transparency 20
- space reclamation 55
- specific mount 54
- stacked volume 28
- storage capacity 25
- storage cell 44
- storage management 22
- stub 51
- tape label 27, 51
- tape space 11
- Tape Volume Cache 21
- teach 67
- technology 21
- vaulting 80
- virtual device 27
- virtual volume 27
- VM/ESA 34
- volume serial 53, 68
- VSE/ESA 34



Printed in U.S.A.

SG24-4917-00

