

8514-ULTRA™



Made in Canada 90 09 01

ATI TECHNOLOGIES INC.
3761 Victoria Park Avenue
Scarborough, Ontario
Canada M1W 3S2
Tel: (416) 756-0718
Fax: (416) 756-0720

User's Guide

8514/ULTRA Installation Guide

Version 1.0 - October, 1990

P/N: 10701F0101

ATI Technologies Inc. reserves the right to make changes to this document, and the products which it describes without notice. ATI shall not be liable for technical or editorial errors or omissions made herein; nor for incidental or consequential damages resulting from the furnishing, performance, or use of this material.

© Copyright 1990, by:

ATI Technologies Inc.	Support:	(416) 756-0711
3761 Victoria Park Avenue	Office:	(416) 756-0718
Scarborough, Ontario	Fax:	(416) 756-0720
Canada M1W 3S2	BBS:	(416) 756-4591

All rights reserved, including those to reproduce this manual or parts thereof, in any form without the express written permission of ATI Technologies Inc.

Trademarks, registered or otherwise, used in this manual are:

ATI, 8514/ULTRA, Mach 8, CRYSTAL Fonts - ATI Technologies Inc.; Postscript - Adobe; IBM, PC, PC/XT, PC/AT, PS/2, VGA, 8514/A, Courier, Micro Channel, XGA - International Business Machines; 1-2-3 - Lotus Development Corp.; Windows, OS/2, Presentation Manager, Microsoft - Microsoft Corp.; MultiSync - NEC Home Electronics Inc.; Dutch, Swiss - Software Arts; VESA - Video Electronics Standards Association; AutoCAD, AutoSHADE, 3D Studio - Autodesk Inc.; Facelift - Bitstream; LHARC - H. Yoshizaki

➤ **WARNING**

You MUST complete the card configuration procedure described in Chapter 5 for the 8514/ULTRA to operate correctly. Do NOT attempt to operate the 8514/ULTRA without having completed the configuration process.

FCC COMPLIANCE STATEMENT

WARNING

Changes or modifications to this unit not expressly approved by the party responsible for compliance could void the user's authority to operate this equipment.

NOTE

This device complies with Part 15 of FCC Rules. Operation is subject to the following two conditions:

- (1) this device may not cause harmful interference, and
- (2) this device must accept any interference received, including interference that may cause undesired operation.

This equipment has been tested and found to comply with the limits for a Class B digital device, pursuant to Part 15 of the FCC Rules. These limits are designed to provide reasonable protection against harmful interference in a residential installation. This equipment generates, uses and can radiate radio frequency energy and, if not installed and used in accordance with manufacturer's instructions, may cause harmful interference to radio communications.

However, there is no guarantee that interference will not occur in a particular installation. If this equipment does cause harmful interference to radio or television reception, which can be determined by turning the equipment off and on, the user is encouraged to try to correct the interference by one or more of the following measures:

- Re-orient or relocate the receiving antenna.
- Increase the separation between the equipment and receiver.
- Connect the equipment into an outlet on a circuit different from that to which the receiver is connected.
- Consult the dealer or an experienced radio/TV technician for help.

WARNING

The use of shielded cables for connection of the monitor to the card is required to assure compliance with FCC regulations.

DOC COMPLIANCE STATEMENT

This digital apparatus does not exceed the class B limits for radio noise emissions from digital apparatus set out in the Radio Interference Regulations of the Canadian Department of Communications.

DOC AVIS DE CONFORMATION

Le présent appareil numérique n'émet pas de bruits radioélectriques dépassant les limites applicables aux appareils numériques de la Classe B prescrites dans le Règlement sur le brouillage radioélectriques édicté par le Ministère des Communications du Canada.

Table Of Contents

1. Introduction and Features	1
2. Contents of this Package	5
3. Installing on ISA/EISA Computer	8
4. Installing on Micro Channel Computer	13
5. Configuring the 8514/ULTRA	18
6. Software Installation	23
7. Turbo AI and Software Support	31
8. CRYSTAL Fonts and Windows	33
9. The ATI AutoCAD Display List Driver	38
Appendix A	47
Troubleshooting	47
Problem Report Form	54
Appendix B	58
Memory Upgrade	58
Specifications	61
Warranty	62
Index	64

8514/ULTRA

1

INTRODUCTION

Congratulations on your purchase of the **8514/ULTRA**. You are in possession of one of the most advanced graphics controllers available for personal computers today.

The **8514/ULTRA** will transform your PC into a powerful graphics workstation. Its high performance graphics coprocessor and 16-bit design accelerates your graphics programs. Adds new life to CAD, DTP, and Windows applications.

The **8514/ULTRA** offers clear, high resolution graphics with its non-interlaced 1024x768/256 color display; and its **CRYSTAL Fonts** make your screen the equivalent of your laser printer.

The **8514/ULTRA** is 100% register-level compatible with the IBM 8514/A graphics adapter. Register compatibility ensures that all software written for the IBM 8514/A graphics adapter will run on the **8514/ULTRA**. Plus, you have the option of using the **Turbo AI** (Adapter Interface) to provide superior performance for applications that support the Adapter Interface Standard.

Your **8514/ULTRA** will maintain a high level of reliability, performance and compatibility for years of video enjoyment and productivity. Welcome to a new world of high-performance video.

FEATURES

1. High-Performance Graphics Coprocessor

- A highly optimized graphics coprocessor provides workstation graphics performance on IBM PC and PS/2

compatible computers. Up to 10x faster than the IBM 8514/A and much faster than TI 34010/34020 based graphics cards. Boost performance up to 65x compared to VGA cards.

2. Non-interlaced 1024x768 Graphics Modes

- Displays non-interlaced 1024x768 graphics with suitable monitors.
- Provides superior flicker-free graphics. With its ergonomic 70 Hz vertical refresh rate, flicker is virtually eliminated, reducing eyestrain and serving to increase productivity.

3. 100% Register-Level Compatibility

- The **8514/ULTRA** will run any application written to the 8514/A standard - whether programmed directly to the registers or through the Adapter Interface (AI).

4. ATI CRYSTAL Fonts

- Displays screen fonts with quality equivalent to Postscript laser printers. Provides scalable, true WYSIWYG screen fonts.
- Provides laser quality, 300 dpi screen fonts on conventional 1024x768 (96 dpi) monitors. Dramatically improves productivity. Improves on-screen reading and proofing, even with small 6 point text.
- Scales automatically in real time, offering you the advantages of:

Convenience - don't have to generate fonts for each individual size;

Disk Space - uses 85% less disk space than a family of bit-mapped fonts;

Speed - uses ATI's **Mach 8** coprocessor to generate fonts in real time. No more waiting for screen fonts to be pre-generated.

- Includes 13 **CRYSTAL Fonts** in Postscript styles (Swiss, Dutch, Courier and Symbol in different weights).
5. **High-Speed Turbo AI (Adapter Interface)**
- Program provides software support for applications which use the 8514/A Adapter Interface - but up to 3.5x faster! Also adds compatibility with XGA programs.
6. **Advanced Software Drivers**
- Includes drivers for AutoCAD and Windows having enhanced support for the 8514/ULTRA's additional performance and features.
7. **Dual Bus Architecture**
- Supports both Micro Channel and Industry Standard Architecture (ISA) or AT bus on a single card.
8. **VGA Pass-Through Connector**
- Supports VGA pass-through (VESA* specification) for single monitor operation. Cable included.
9. **Advanced CMOS VLSI Gate Array Technology**
- Built around the exclusive **ATI Mach 8** Graphics coprocessor, the 8514/ULTRA features low power consumption, high-speed performance, and complete reliability, all at an incredibly affordable price.
10. **Available in 512K or 1MB Versions**
- 8514/ULTRA comes with either 512K or 1MB video memory. 512K versions can be expanded to 1MB (see Appendix B) to support more colors.

* Video Electronics Standards Association

Resolution	Colors with 512K	Colors with 1MB
1024x768	16	256
640x480	256	256

11. Warranty

- Two year warranty.

How To Use This Manual

1. Refer to the **README** file on disk #1 for the latest changes.
2. To install the graphics card in an AT (ISA) bus computer, refer to Chapter 3. If installing into an MCA bus computer, refer to Chapter 4.
3. To install the utilities and software drivers, refer to Chapters 5 and 6 to ensure correct configuration and optimum performance.

Command Syntax

When prompted to use the 8514/ULTRA utilities in this guide, the following convention is used:

Example: C:\>COMMAND [option] [keyword] <enter>
 C:\> - Refers to the DOS command prompt.
 COMMAND - Is an executable file (i.e. VCONFIG).
 [keyword] - Denotes an optional keyword.
 [option] - Denotes an optional argument or condition.
 <enter> - Press the key inside the bracket.

README Files

On disk #1 is a **README** file containing the notes on the latest revisions. In addition, there is a **README.XXX** file in each driver subdirectory that contains specific instructions for each driver. To examine the **README[.XXX]** files, at the DOS prompt type:

A:\>TYPE README[.XXX] <enter>

or use a word processor to print this file.

Contents Of The Package

2

Your 8514/ULTRA package includes the following:

- 8514/ULTRA adapter.
- Installation guide.
- ISA-style retaining bracket assembly
- Micro Channel retaining bracket and card-guide extension.
- VGA Pass-through cable.
- Utility disks (in high density, 5¼" and 3½" formats).
- VGA terminator plug.
- Micro Channel installation tool.

Be sure to make working copies of the original disk to prevent loss of important files due to accidental erasure.

To make a backup copy of the disks, use the following procedure:

1. Obtain a blank formatted disk in the media type that you intend to use.
2. Insert the disk into drive A. For a two drive system, insert the source disk into drive A and the destination disk into drive B.
3. Type the DOS command:
C:\>DISKCOPY A: B: <enter>
4. When prompted for your SOURCE disk, insert the 8514/ULTRA Utilities disk.
5. When prompted for your TARGET disk, insert the blank formatted disk.

- **NOTE**
Completion of your Warranty Card, contained at the back of this manual, is important in order to validate your Warranty and to use Technical Support Services.

8514/ULTRA Block Diagram

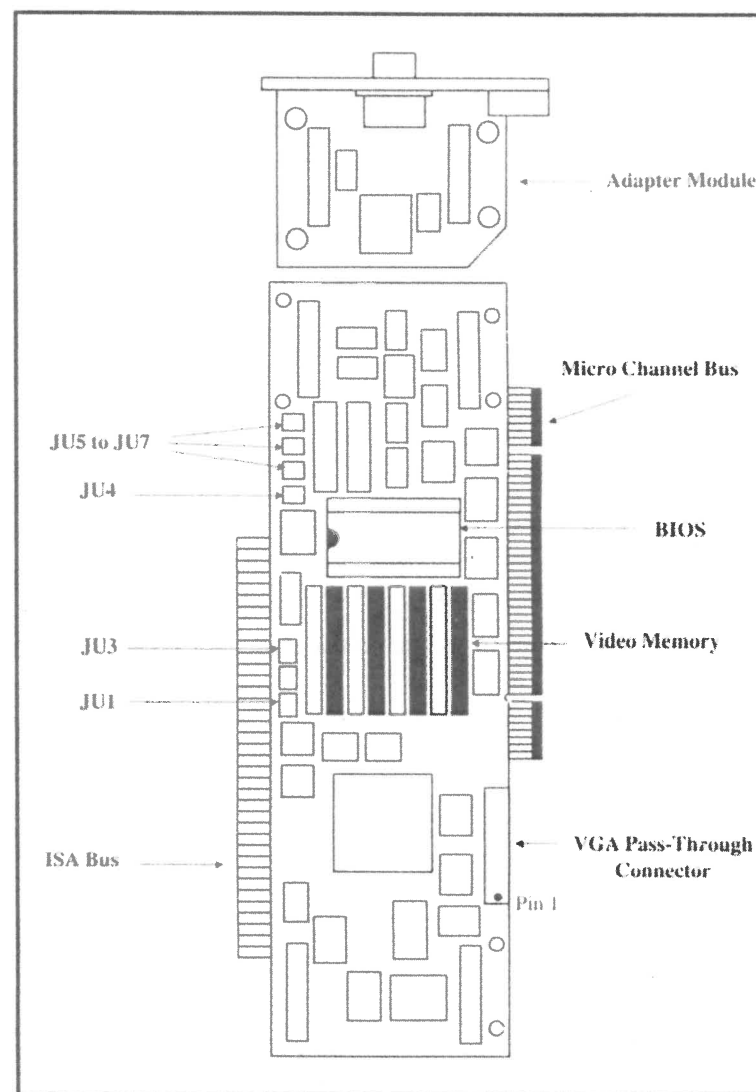

The following table describes the jumpers on the 8514/ULTRA. Refer to Appendix A for further information. DO NOT change the jumper settings unless necessary.

Jumper Information

Jumper	Function	Jumper Setting	
		Closed***	Open***
JU1	EEPROM	OFF	ON*
JU3	Memory Size	512K	1.0MB
JU4	Compatibility	OFF*	ON
JU5	IRQ 5**	ON	OFF*
JU6	IRQ 3**	ON	OFF*
JU7	IRQ 2**	ON	OFF*

* Factory Default

** Applies to ISA computers only. The IRQ (Interrupt Request) level on the 8514/ULTRA is not used by any known software. These jumpers have been provided for possible future considerations. The factory default is set for all interrupts disabled.

*** Refer to Jumper Position diagram below.

Jumper Position

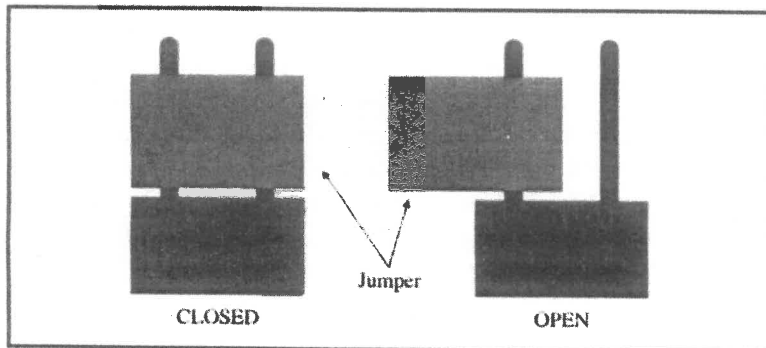

Installing On ISA/EISA Computers

3

This section describes how to install the 8514/ULTRA on machines with an ISA (Industry Standard Architecture) or EISA (Extended Industry Standard Architecture) bus. PC or AT compatible computers have ISA bus slots. IBM PS/2 Computers except for the Model 30, have Micro Channel bus slots. If you are using a Micro Channel computer, refer to Chapter 4.

➤ **WARNING**

If you have previously installed the 8514/ULTRA, you must use the UNINSTALL option in the INSTALL program before moving the card to a different system. This step is necessary to prevent conflicts between the 8514/ULTRA boot ROM and other adapter ROM or RAM when installing into a new system. This step is particularly necessary when moving the 8514/ULTRA between Micro Channel and ISA machines, or vice-versa.

The 8514/ULTRA is designed for use in any 8- or 16-bit expansion slot in an IBM PC/AT or compatible machine, or in the IBM Personal System/2 Model 25 and 30. You must use a VGA controller with the 8514/ULTRA to boot the card.

➤ **NOTE**

Static electricity can seriously damage the components in your computer. You must ensure that you have discharged any static electricity by grounding yourself to the chassis of the PC before you begin.

The **8514/ULTRA** comes factory installed for ISA computers. If you have removed the Adapter module, use the instructions in step 1 for reassembly.

1. Mount the module assembly on the **8514/ULTRA** adapter as shown in the following diagram. Make sure that the module is placed on the connector on the side of the AT bus with the notch facing away from the AT bus. The AT bus connector can be identified as the two gold fingers on the bottom of the card. The **8514/ULTRA** is shipped with the module installed for ISA bus computers. Fasten it with the four plastic screws.

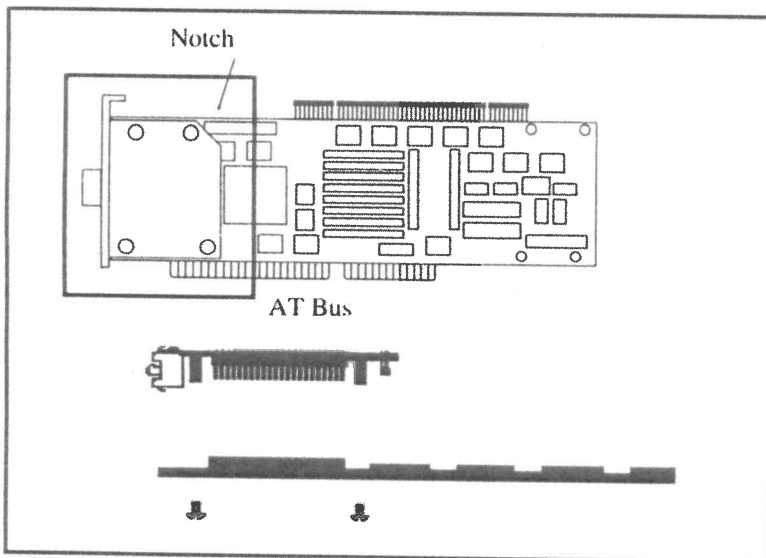

2. Ensure that the system is switched off and the power cord removed before proceeding. Damage to the **8514/ULTRA** and the system may result if the power is left on during installation.
3. Follow the manufacturer's instructions for the removal of the system unit cover from your computer.

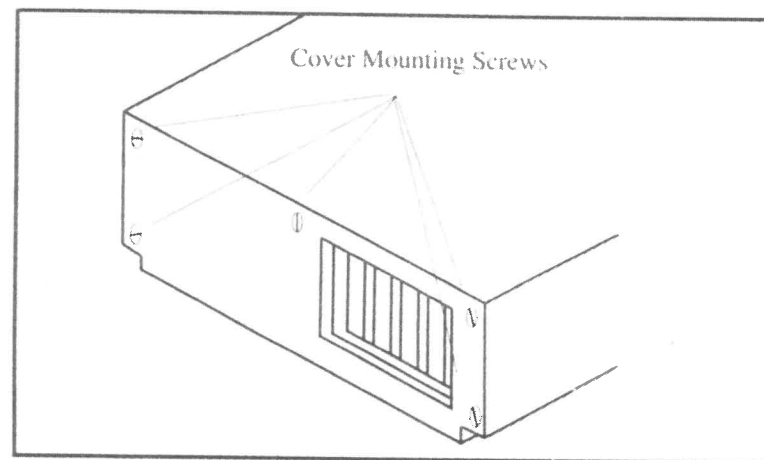

4. Select an empty slot adjacent to the computer's VGA card, if applicable. If you are using a single monitor, the **8514/ULTRA** must be installed in a slot either in front of, or immediately behind the VGA card. You may have to rearrange other cards in your system to free up a slot next to the VGA card.

If your system has VGA built into the motherboard, select the slot closest to the VGA Feature Connector on the mother board.

You may need to refer to your Computer System User's Manual to locate the motherboard VGA Feature Connector and may require a special cable which may be obtained from your dealer if the feature connector is not of the standard VGA type.

5. Remove the slot cover at the rear of the system. Grasping the card by the top left edge, firmly seat it into the expansion slot as shown in the diagram on the following page. Insert the screw from the expansion slot cover in the hole at the top of the **8514/ULTRA**'s retaining bracket and tighten it.

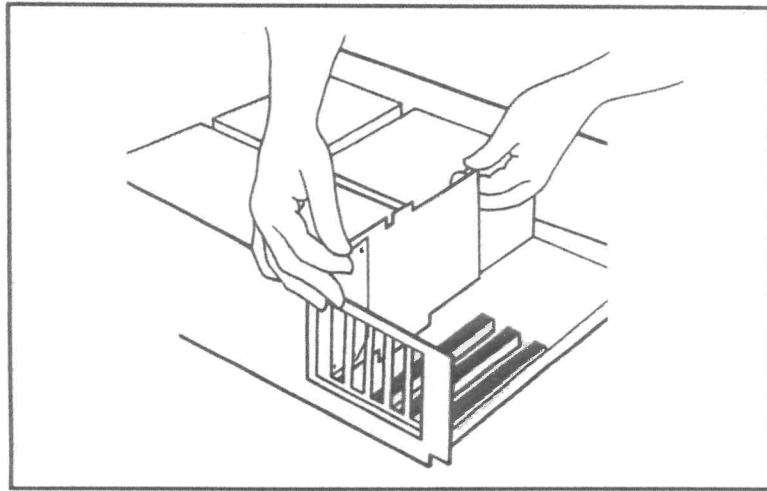

- **NOTE**
 For the best results, insert the 8514/ULTRA into a 16-bit slot. A 16-bit slot will accommodate both of the gold connectors located on the bottom of the 8514/ULTRA.

6. If you are running a single monitor, connect one end of the pass-through cable to the stake header connector on the 8514/ULTRA and the other end to the gold-edged Feature Connector on the top of the VGA card.

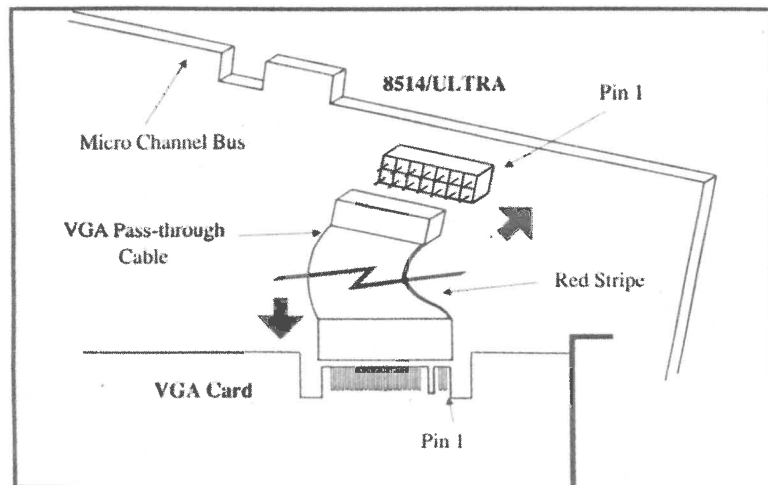

- **NOTE**
 Be careful not to twist the cable. The cable must be attached to pin 1 of the VGA card and the 8514/ULTRA as shown on the previous page.
- **WARNING**
 If you are using the VGA Pass-through with the VGAWONDER or other video cards with digital monitor support, DO NOT connect to any digital monitors (EGA, CGA, TTL Monochrome) if running in pass-through mode, as serious damage could result to the monitor.

If the Feature Connector on your VGA or motherboard is a stake header connector instead of a gold-edged connector, you will have to order a special pass-through cable from your dealer.

If you are using a single monitor, plug the monitor cable into the 8514/ULTRA. Connect the VGA terminator plug into the DB-15 port on your VGA card.

If you are using a dual monitor system, plug the VGA monitor cable into the VGA card. Plug the cable from the high-resolution monitor into the 8514/ULTRA.

7. Replace the system unit cover and tighten the screws.
8. Before using your 8514/ULTRA, you must first configure the card. Refer to the INSTALL.EXE program supplied on the 8514/ULTRA Utilities Disk. Turn to Chapter 5 for instructions on how to configure the 8514/ULTRA.

Installing On Micro Channel Computers

4

This section describes how to install the **8514/ULTRA** graphics card into computers with a Micro Channel bus. If you are using a computer with an AT (ISA) bus, refer to Chapter 3.

► NOTE

Static electricity can seriously damage the components in your computer. You must ensure that you have discharged any static electricity by grounding yourself to the chassis of the PC before you begin.

1. Locate the following parts included with the **8514/ULTRA** for the installation into a Micro Channel computer:
 - Bracket, - Plastic Clip, - Bolt, - MC Tool

Using the tools provided by ATI, remove the 4 screws on the back side of the Adapter Module and remove the nuts holding the existing bracket. Install the parts as shown in the diagram below, fastening the plastic clip first. Slide the 3 prong end of the Micro Channel bracket into the plastic clip and then tighten the nuts.

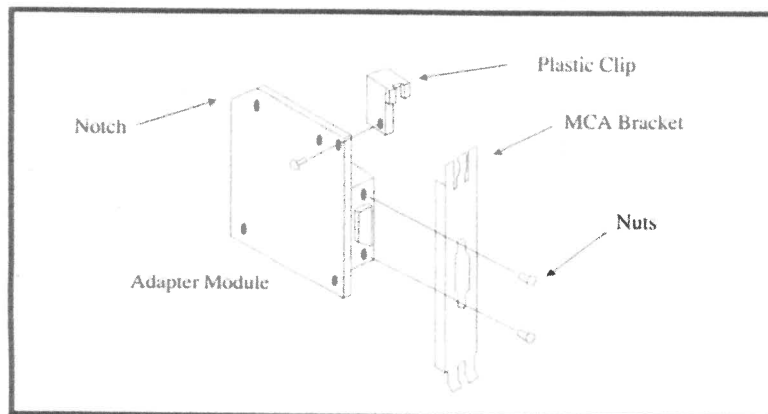

2. Mount the module with the Micro Channel retaining bracket on the **8514/ULTRA** as shown in the diagram below. Fasten the retaining bracket onto the **8514/ULTRA** using the four plastic screws. Make sure that the notch on the module is facing up (away from the MCA bus connector).

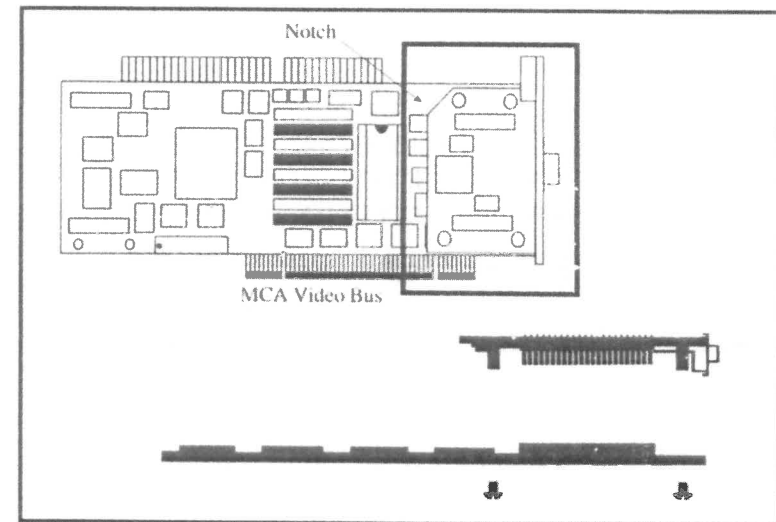

3. Ensure that the system is switched off and that the power cord is removed before proceeding. Damage to the **8514/ULTRA** and the computer system may result if the power is left on.
4. Follow the manufacturer's instructions for the removal of the system unit cover.
5. The **8514/ULTRA** must be installed in slot 1 of Micro Channel computers. This bus slot contains additional connectors for the Video Bus which is used by the **8514/ULTRA** to pass VGA signals to the monitor connected to the **8514/ULTRA**.
Slot 1 may be identified by the additional connectors for the video bus. If an adapter is already installed in slot 1, move that card to a different slot.
6. Remove the slot cover at the rear of the system by loosening the retaining screw, and pulling upward gently.

Install the **8514/ULTRA** into the empty expansion slot. Grasping the card by the top left edge, firmly seat it into the expansion slot as shown below.

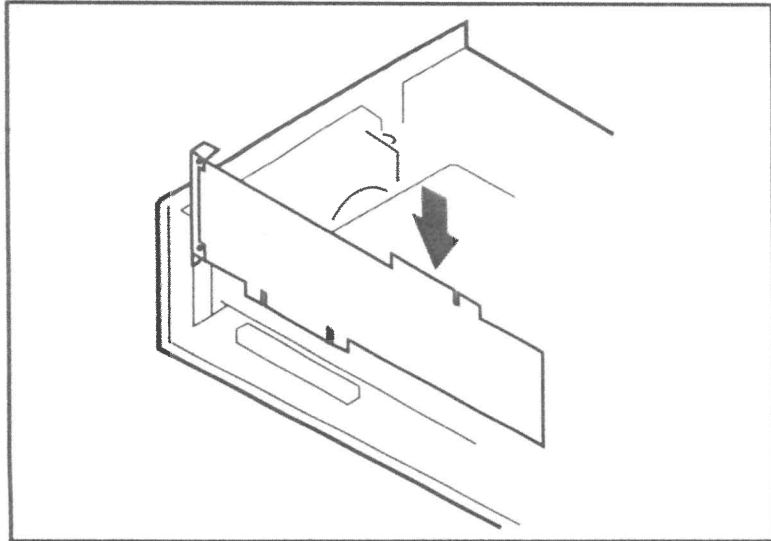

Gently retighten the retaining bracket screw at the bottom of the adapter cover opening.

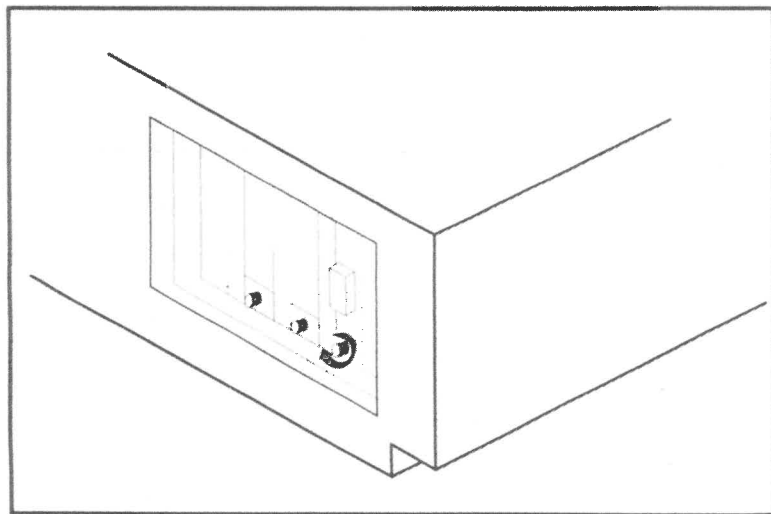

7. Replace the system unit cover, and fasten the screws.
8. If you are using a single monitor, plug the video cable into the **8514/ULTRA**. If you are using two monitors, plug the high resolution monitor, into the **8514/ULTRA** and the other video cable into the lower video port on the PS/2 computer.
9. The system must be reconfigured using the **8514/ULTRA Utility Disk**. To configure the system, refer to the following instructions:
 - a) **Reference Disk**

Insert your system **Reference Disk** into drive A and turn on the system.

► **NOTE**

You must reconfigure the computer using the **Reference Disk** even if your system is configured for the **IBM 8514/A** card. Use the most recent backup copy of the **Reference Disk** to avoid unnecessary complications. Refer to your **System Reference Manual** for further information.

b) **Error Messages**

Your system will report error 165 and beep twice. Press <enter> after the IBM logo appears. Press <PgDn> until the following message appears on-screen:

"Automatically Configure System (Y/N) "

Select <N> for No and the next screen will appear.

c) **Option Disk**

Select the option:

"3. Copy an Option disk"

and insert your **8514/ULTRA Utility Disk** into drive A. If you have a single disk drive, you will need to swap the disk several times to copy it. When the duplication procedure is complete, leave the **Reference Disk** in drive A and press <enter>.

d) **Configuration**

Select the option:

"3. Set Configuration"

then select:

"5. Run Automatic Configuration"

and press <enter>.

When the configuration process is completed, press <esc> and then <enter> to restart the system. Remove the updated **Reference Disk**. Continue with the **INSTALL** process in Chapter 5.

➤ **IMPORTANT**

The 8514/ULTRA will not operate correctly unless the adapter has been configured using the INSTALL procedure outlined in Chapter 5.

Configuring The 8514/ULTRA

5

Before using the **8514/ULTRA**, you **MUST** configure the card using the program, **INSTALL**, provided on the **Utilities Disk**. The card will not operate correctly until it has been configured by the **INSTALL** program.

Turn on your computer. If an error message occurs, check over your installation or consult Appendix A for a Troubleshooting Guide.

To configure the card, insert the **Utility Disk** into drive A and type:
A:\>INSTALL <enter>

A prompt will ask the floppy drive where the **INSTALL** files are located; press <enter> to accept the default or <backspace> to type your choice.

The following menu will appear on your monitor:

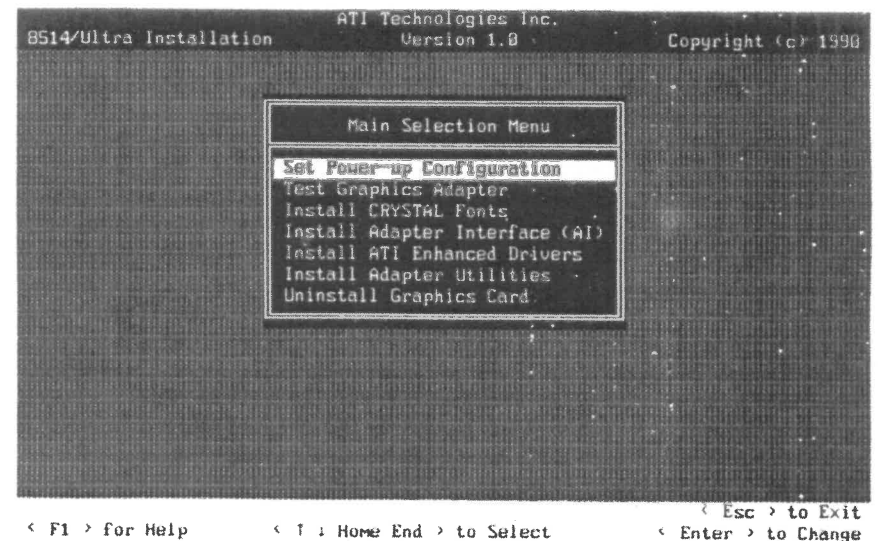

The bottom bar of the menu screen shows relevant keys for using the **INSTALL** menus.

Select the first option, "Set Power-up Configuration" which is already highlighted by pressing <enter>.

a) **Selecting a Monitor Type**

By selecting the correct monitor type you will be able to display the "best" quality image supported by your monitor.

➤ **WARNING**

Using the wrong monitor selection could damage your monitor.

Three choices will appear under the "Set Power-up Configuration" option. Press <enter> at the highlighted "Monitor Type" option. The following menu will appear:

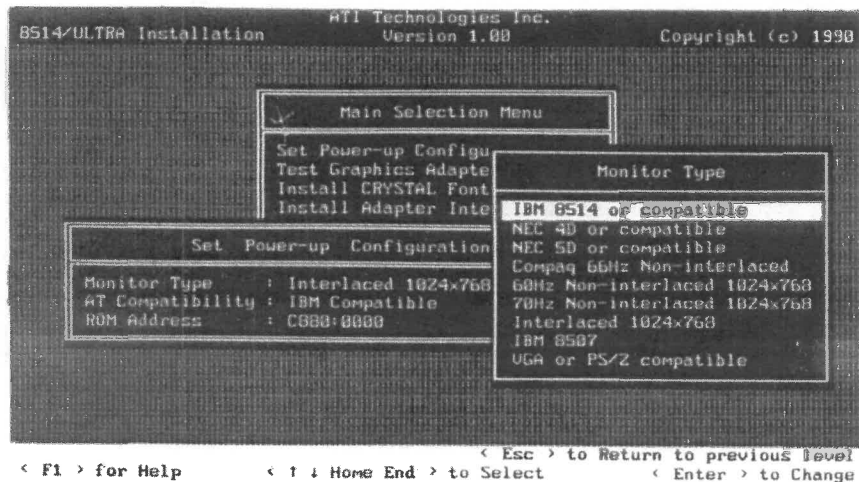

To select a monitor type, move the highlight bar using the arrow keys to the option that best matches your monitor. Press <enter> to select the monitor type.

➤ **NOTE**

Refer to your monitor manual for the maximum resolution and vertical refresh rate supported. The Specifications section at the back of this manual indicates which frequencies are supported. If you are using a dual monitor system, the

selection should be based upon the monitor connected to the 8514/ULTRA. The 8514/ULTRA always uses the maximum refresh rate supported by the monitor selection.

b) **Set AT Compatibility (ISA systems only)**

Selection of this option may optimize performance of the 8514/ULTRA. This option enables the use of an 80386 acceleration mode on some computer systems.

Three selections appear after pressing <enter> at this option:

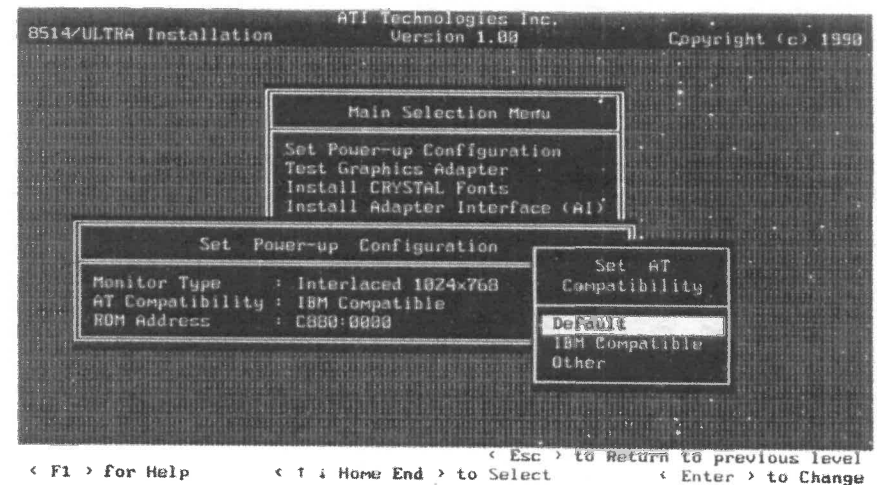

Default

Automatically the user to select the acceleration mode on some 80286 computers.

IBM AT Compatible

Allows the user to select the acceleration mode on some 80286 computers.

➤ **NOTE**

This item may cause some systems to lock up. To correct the problem remove the 8514/ULTRA from your computer and change the JUI jumper. Refer to Appendix A troubleshooting information. Set the option to "Other" to correct the problem.

Software Installation



The **8514/ULTRA** comes with a variety of software utilities and drivers designed to provide enhanced features and performance using special features of the **8514/ULTRA**. You must run the software installation process to install the **8514/ULTRA** drivers.

Utilities and Drivers

The **8514/ULTRA** disks contain the following files:

README	- Latest updates and additions to the 8514/ULTRA disks.
INSTALL.EXE	- Program for configuring the 8514/ULTRA and installing software drivers.
INSTALL.HLP	- Help file for INSTALL program.
8-INFO.EXE*	- Utility for reading system configuration.
TEST.COM*	- 8514/ULTRA File Diagnostic Program.
@8088.ADF	- Option file for Micro Channel configuration.
ULTRA.DRV	- Fast Windows 3.0 driver for 1024x768 in 16 or 256 colors.
ULTRAGS.DRV	- 1024x768 in monochrome or 256 color Windows driver supporting CRYSTAL Fonts .
README.WIN	> Other Window 3.0 files
OEMINSTALL.INF	

* Loaded through running **INSTALL**.

In addition, the disks contain several subdirectories with the following files:

ACAD Subdirectory:

ACADINST.EXE	- Installation program for AutoCAD.
ACADINST.HLP	- Help file for ACADINST.EXE .
ACAD8E10.EXE	- Real Mode Display List Driver for AutoCAD Release 10 with Bird's Eye.
ACAD8E10.EXP	- Protected Mode Display List Driver for AutoCAD 386 Release 10.
ACAD8E11.EXP	- Protected Mode Display List Driver for AutoCAD 386 Release 11.

HDIPCDOS Subdirectory:

HDILOAD.EXE	- Turbo AI (Adapter Interface) for use with 8514/ULTRA .
STAN1220.FNT	> Various AI compatible system fonts in 12x20, 7x15 and 8x14 sizes.
STAN0715.FNT	
STAN0814.FNT	

CRYSTAL Fonts Subdirectory:

LHARC.EXE	- Decompression utility.
GSFONTS.LZH	- CRYSTAL Fonts file compressed.

Installing INSTALL

The **INSTALL** program configures and installs the **8514/ULTRA**, as well as, the driver and utility programs.

To start **INSTALL**, insert the **Utilities Disk** into drive A and type:
A:\>**INSTALL**<enter>

The menu on the following page will appear:

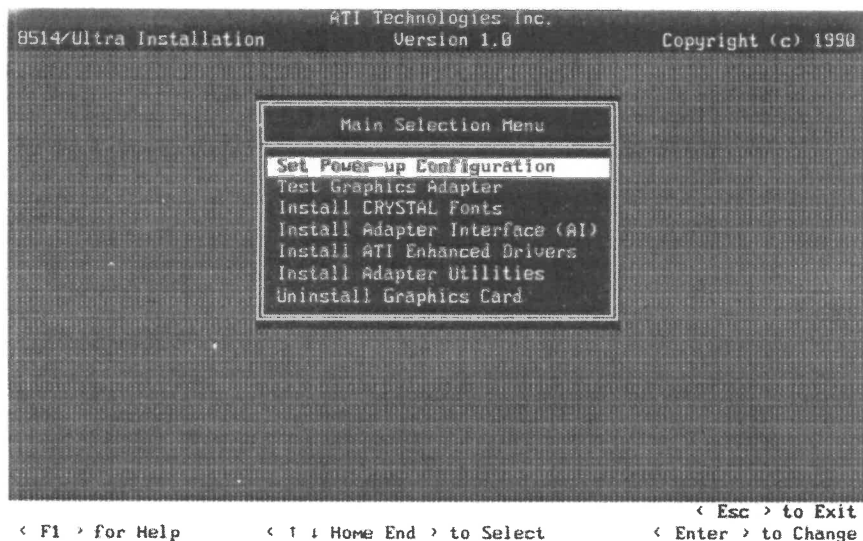

The following section describes the options in the **INSTALL** menu.

Set Power-up Configuration

This option configures the **8514/ULTRA** and must be run. See Chapter 5 for a complete description.

Test Graphics Adapter

Selection of this item will operate the Diagnostics and System Information programs. See Appendix A for details.

Install CRYSTAL Fonts

This option will install **CRYSTAL Fonts** on your hard disk, for use with Microsoft Windows and other GUI (Graphics User Interface) programs. When you select this option, the menu on the following page will appear:

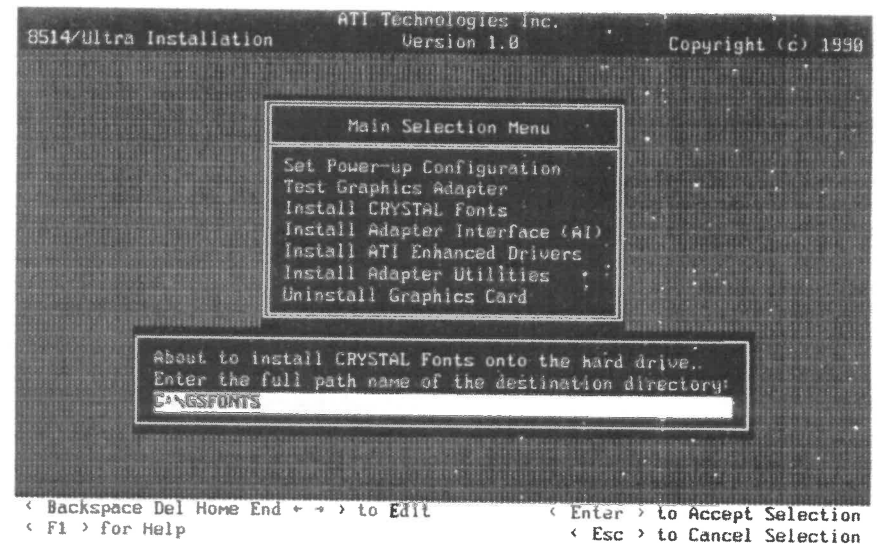

Press <enter> to install the fonts in the **C:\GSGFONTS** directory and to update the **AUTOEXEC.BAT** file.

If the fonts are installed in any directory other than **C:\GSGFONTS**, the environment variable, **GSGFONTS**, must be set to the path where the fonts are located, in order for the applications program to use them. Refer to Chapter 8 for further information on **CRYSTAL Fonts**.

Install Adapter Interface (AI)

Selection of this option will install the **Turbo AI** and **AI** font files onto a directory on your hard disk. Press <enter> and the menu on the following page will appear:

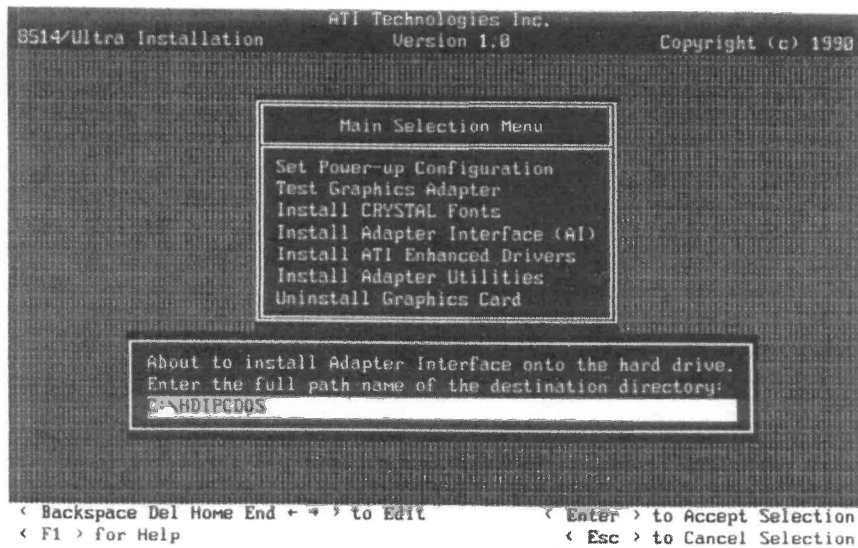

Press <enter> to accept the default directory or specify a new path and directory; your AUTOEXEC.BAT file will be updated to include the path for the Turbo AI.

Refer to Chapter 7 for instructions on using the Turbo AI.

➤ NOTE

Some applications require that the AI font files be located in the directory \HDIPCDOS on your current working drive. Avoid changing the directory name for compatibility with all programs which support the applications interface.

Install ATI Enhanced Drivers

This option will install the software drivers customized for the 8514/ULTRA. Press <enter> and the menu on the following page will appear:

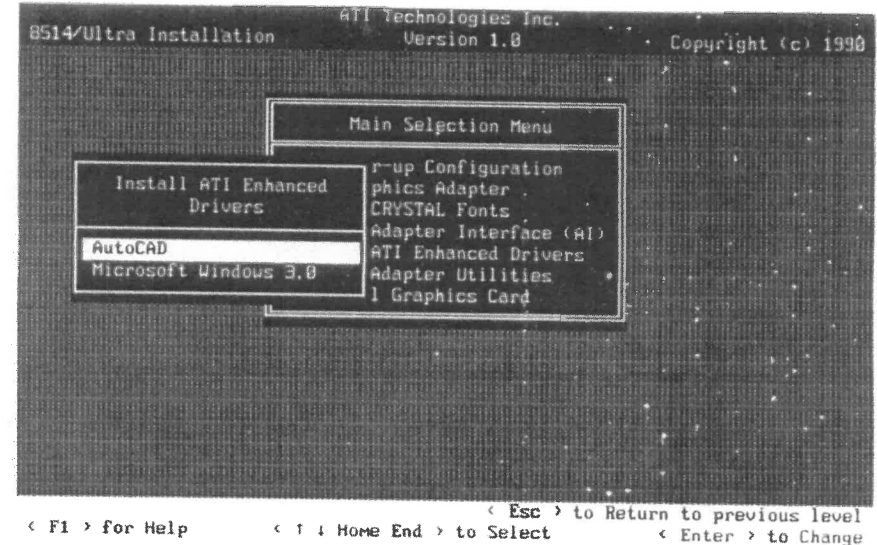

Refer to Chapter 8, "CRYSTAL Fonts and Windows" for information on installing Windows.

Refer to Chapter 9 for AutoCAD installation.

Refer to the README file for information on new drivers in the OTHER option.

Install Adapter Utilities

Select this option to install the 8514/ULTRA INSTALL program on your hard disk. Press <enter> and the menu on the following page will appear:

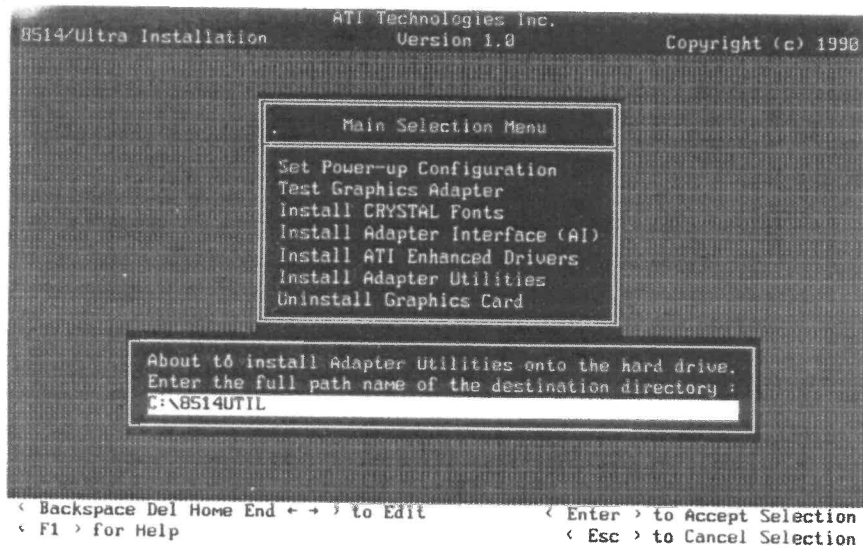

Press <enter> to accept the default directory C:\8514UTIL or type in your choice.

A prompt will appear asking if you want to update the AUTOEXEC.BAT file to include this in the PATH. Type <Y> to accept or <N> for No.

Uninstall Graphics Adapter

Select this option if you are moving the 8514/ULTRA to a different system. Press <enter> and the menu on the following page will appear:

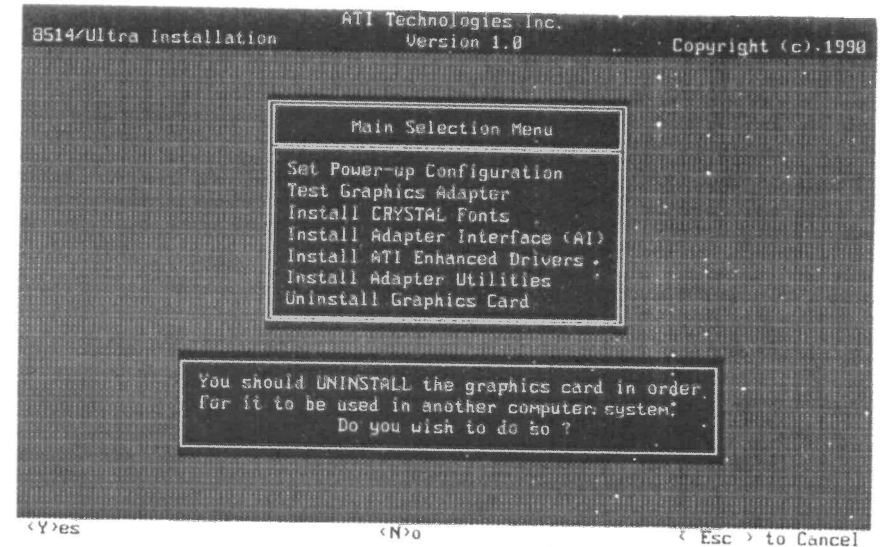

Enter <Y> for Yes to uninstall the 8514/ULTRA and reset to the factory default.

► WARNING

The 8514/ULTRA may not function correctly in another system unless it has been uninstalled before removing the 8514/ULTRA from the system in which it was originally installed.

Turbo AI and Software Support

7

There are two categories of software drivers which support the IBM 8514/A graphics adapter:

1. **Direct-to-register**
Those which write directly to the 8514/A registers;
2. **Adapter Interface**
Those which access the 8514/A through the Adapter Interface.

Direct-to-register software writes directly to the registers of the 8514/A. Examples of programs which fall into this category are: Microsoft Windows, OS/2 Presentation Manager, and the ATI AutoCAD Display List Driver. If you have followed the installation instructions in the preceding chapters, these programs will run out of the package, without any further preparation. Performance-orientated programs will usually write directly to the 8514/A registers.

Many programs will access the 8514/A using a software interface designed by IBM called the Adapter Interface (AI). On an IBM 8514/A adapter, software support for the AI is provided by loading a TSR program called **HDILOAD.EXE**. Examples of programs that fall into this category are: Lotus 1-2-3; WordPerfect; and Turbo-Pascal. For applications where graphics performance is not of the utmost necessity, the AI allows software developers to develop drivers with greater ease than when writing directly to the 8514/A registers. Most DOS-based programs use the AI approach. ATI's **Turbo AI** also supports programs written to the XGA AI.

The **8514/ULTRA** comes with its own **HDILOAD.EXE** program. This is the **Turbo AI** which is installed through the option "Install Adapter Interface (AI)" option in the **INSTALL** program.

Because of the way that the IBM AI operates, many applications require that these files be located in the **C:\HDIPCDOS** directory. **HDILOAD** may be installed in other directories if desired, but this should be done with caution, as not all applications will run correctly if **HDILOAD** (and particularly, the AI fonts) is installed in a different directory.

To execute the **HDIPCDOS** program, enter the following command from the DOS prompt:

```
C:\>HDILOAD
```

➤ **NOTE**

If you are unsure of which AI is being used, the version number will appear after it is loaded. Using the IBM AI will provide less than optimal performance. The Turbo AI will accelerate the application up to 3.5x faster over the IBM 8514/A AI.

The **HDILOAD** program should be run once after rebooting the computer, before starting any programs requiring AI support. You may wish to add the line, **HDILOAD** to your **AUTOEXEC.BAT** file.

HDILOAD is a Terminate-and-Stay-Resident (TSR) program, which loads itself into the memory and stays there until the computer is re-booted or turned off. Although the **HDILOAD** program only requires 18K of memory, it may be removed from memory, thereby allowing applications which don't require the Adapter Interface to use the additional memory. To remove the AI from memory, type:

```
C:\>HDILOAD UNLOAD
```

➤ **NOTE**

Programs that use the AI will display an error message if the AI is not present before starting the application.

CRYSTAL Fonts and Windows



About ATI Windows Drivers

The 8514/ULTRA comes with a selection of two different drivers for Windows 3.0:

1. A fast Windows driver without **CRYSTAL Fonts**.
2. A color Windows driver with **CRYSTAL Fonts**.

Each driver is different and suited to varying needs of individual users. For a detailed discussion about **CRYSTAL Fonts**, refer to the section, "About **CRYSTAL Fonts**" in this chapter. All Windows 3.0 drivers support 1024x768 resolution; 512K versions of 8514/ULTRA support 16 colors and 1MB versions support 256 colors.

Fast Windows Driver

The **ULTRA.DRV** driver provides the best performance under Windows and has minimal hardware requirements. The trade-off for the versatility and performance is the loss of the **CRYSTAL Fonts** support. It supports all operating modes of Windows 3.0 (real, standard and enhanced) and supports 16 or 256 colors.

CRYSTAL Fonts Windows Driver

The **ULTRAGS.DRV** driver adds the **CRYSTAL Fonts** feature in monochrome or full 256 color mode. 512K cards will display monochrome in 16 shades of gray. Hardware requirements are 2.0MB of system memory and an 8514/ULTRA with 1MB of video memory.

Installing Windows

To install the enhanced windows drivers for the 8514/ULTRA, use the following procedures.

1. Run "SETUP" from the Windows **INSTALL** disk. Select <enter> at the opening screen. When prompted for a directory, specify the path (where Windows is installed or for new installations, where you want Windows to be installed) and press <enter>.
2. A list of hardware and software components will appear. Move the cursor to the "Display:" option (it should read 8514/A); press <enter> and move the cursor to the "Other" option at the bottom. Insert the **8514/ULTRA Utility Disk** into drive A and press <enter>.
3. The following selections will appear on screen:

```
8514/ULTRA: Fast Driver (512K/1MB)
8514/ULTRA: CRYSTAL Fonts (512K/1MB)
```

Move the arrow keys to highlight your selection and press <enter> to continue.

4. Continue the installation as per the prompts by the Windows program.

About CRYSTAL Fonts

The 8514/ULTRA with its **Mach 8** coprocessor features an integrated hardware font engine for generating **CRYSTAL Fonts**. Only from ATI, **CRYSTAL Fonts** offer advantages of having a Postscript laser printer for the screen. **CRYSTAL Fonts** provide true WYSIWYG (300 dpi) resolution and the advantages of scalable fonts.

Using a technique developed by MIT (Massachusetts Institute of Technology) called anti-aliasing, shades of gray are added to edges of fonts to increase the perceived resolution. **CRYSTAL Fonts** use 16 shades of gray to increase the perceived resolution to nearly 300 dpi, or resolution equivalent to 3200x2400. The result is LASER QUALITY screen fonts on conventional 1024x768 monitors. Even text as small as 6 point can be clearly read right from the computer screen.

Enlarged View of 8 point text at 1024x768 Resolution

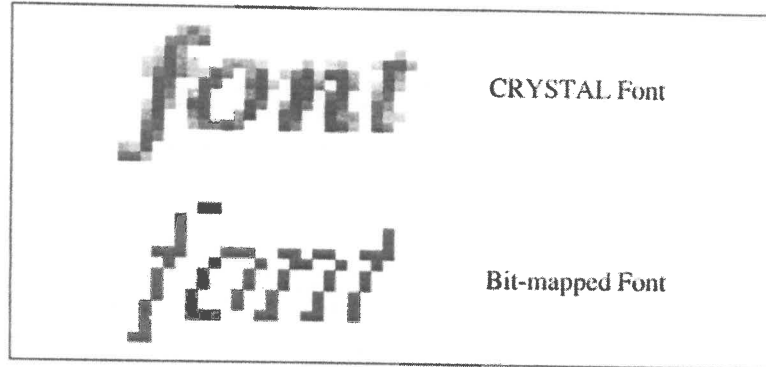

The font engine on the 8514/ULTRA generates 16 versions of each character and determines the best fit. Fonts are positionable to quarter-pixel accuracy (at 400 dpi), for on-screen kerning.

CRYSTAL Fonts greatly increase the productivity of the user. It improves on screen legibility and accuracy, as well as, eliminating wasted time using the laser printer as a proofing device. What you see now is TRULY what you get!

CRYSTAL Fonts are generated from font outlines which vary from 36KB to 58KB in size. Compared to conventional bit-mapped fonts, CRYSTAL Fonts save disk space and offer convenience, as they do not have to be generated for each individual size needed. And because CRYSTAL Fonts use a hardware accelerator, the speed at which they are created is much faster than software-based scalable font generators.

The 8514/ULTRA includes 13 CRYSTAL Fonts in Dutch, Swiss, Courier and Symbol styles.

Compatibility

CRYSTAL Fonts are intended for use with GUI (Graphical User Interface) programs* such as Microsoft Windows.

* Additional support is planned for other GUI's.

CRYSTAL Fonts will work with other font products which may have been installed on your screen. Therefore, if your program calls for a font style that is not available in CRYSTAL format, the required font will be used from your hard disk. The order of preference for font usage by the application program using the ATI CRYSTAL Font driver is:

1. CRYSTAL Fonts.
2. Adobe Type Manager or Facelift (scalable fonts).
(see Appendix A, Notes ABOUT CRYSTAL Fonts)
3. Bit-mapped fonts.

Programs that use Windows font format are compatible with CRYSTAL Fonts. There are, however, a few drawing programs which use a proprietary font format that does not support CRYSTAL Fonts; in those instances, the program will use its own fonts.

ATI also provides additional fonts to match the set of Postscript 35 and translator utilities to convert Adobe and Bitstream fonts to CRYSTAL format. These are available from your computer dealer or direct from ATI.

Installing CRYSTAL Fonts

When you select the "Install CRYSTAL Fonts" option from the INSTALL program, a subdirectory GSFONTS is created on your hard disk. This directory contains the CRYSTAL Font outlines and font tables. With the 8514/ULTRA utility disk in the default drive, press <enter> to install the base set of CRYSTAL Fonts. To install the optional fonts, insert the new fonts disk and press <enter>.

In addition, the installation process adds the following line to your AUTOEXEC.BAT file:

```
SET GSFONTS = C:\GSFONTS
```

This line must be present in order for the applications program to find where the CRYSTAL Fonts information is located.

For each style of **CRYSTAL Font** installed, there are two corresponding files with the following file names:

FONT00XX.PFM
FONT00XX.GSF

where XX = Font Number
.PFM = Font Metric Information File
.GSF = Font Outline File

The following font numbers refer to the following styles:

Number	Style
00	Dutch Normal
01	Dutch Italic
02	Dutch Bold
03	Dutch Bold Italic
04	Swiss Normal
05	Swiss Oblique
06	Swiss Bold
07	Swiss Bold Oblique
08	Courier Normal
09	Courier Italic
10	Courier Bold
11	Courier Bold Italic
12	Symbol

The ATI AutoCAD Display List Driver



This chapter describes how to install and use the special features of the **8514/ULTRA** ADI drivers for AutoCAD, AutoShade and 3D Studio. You can skip over this chapter if you are not using one of the forementioned programs.

What is the ADI Driver?

The ADI Display List Driver provided by ATI speeds up REDRAW, PAN and ZOOM operations in AutoCAD, as well as adding special features. The AutoCAD driver is loaded into memory between the **8514/ULTRA** and AutoCAD, storing vector information in a Display List. The Display List allows the driver to perform the REDRAW operations rather than having AutoCAD do so.

ATI provides three separate drivers which support both AutoCAD (real mode) and AutoCAD 386 (protected mode). Features of the Display List Drivers are:

- **Speed**
Up to 15x faster than the AI driver supplied by AutoDESK. Supports the special functions of the **Mach 8** coprocessor on the **8514/ULTRA** including Fast Line Draw and Hardware Pre-clipping.
- **Dynamic Bird's Eye View**
An adjustable Bird's Eye function allows for fast zooming into any area of a drawing, selectable directly from the AutoCAD menu. Frame size is adjustable with mouse or digitizer.
- **Display List Meter**
Displays the amount of Display List memory actually being used. This allows the user to monitor and adjust the size of the Display List according to actual drawing types.

Installing the AutoCAD (Real Mode) Driver*

If you are using AutoCAD 386, refer to the section on "Installing AutoCAD 386."

To install the AutoCAD (for Release 10 and 11) Real Mode Drivers from the "INSTALL" menu, select the following options:

- Menu 1 - "Install ATI Enhanced Drivers"<enter>
- Menu 2 - "AutoCAD"<enter>
- Menu 3 - "AutoCAD Release 10"<enter>

The following menu will appear on screen:

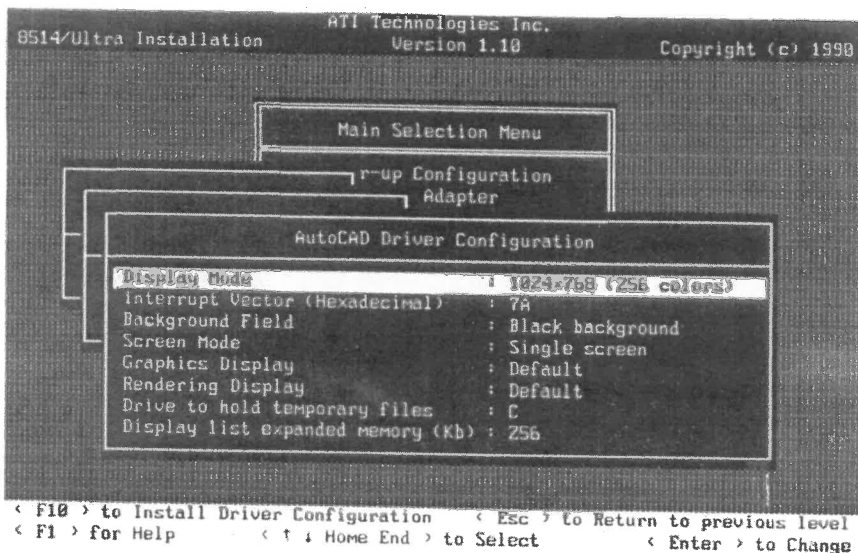

* To use the Display List, the driver requires a minimum of 16KB of expanded memory. The driver uses 45KB of conventional memory, in addition, to the memory allocated to the Display List.

To configure the "Real Mode Driver", move the arrow keys to the option and press <enter>. Default settings are shown in the menu and are described below:

Display Mode

Select 1024x768/256 colors for 8514/ULTRA-1.0MB and 1024x768/16 colors for 8514/ULTRA-512K. Performance is not affected by the number of colors.

Interrupt Vector

Specifies the interrupt vector location for the 8514/ULTRA (from 78 to 7F hexadecimal). The default should suffice for most systems. Change if display card error message appears when loading AutoCAD or if using on a Novell network.

Background Field

Specify your choice of either Black (default) or White/Gray background.

Screen Mode

Select Single Screen (default), Dual Screen (8514/VGA) or Dual Screen (8514/Mono) depending on the system configuration.

Graphic Display/Rendering Display

Used only for AutoShade. Select your choice for saving the file.

Drive to Hold Temporary Files

Specify Drive C or other hard disk, if applicable.

Display List Expanded Memory

Specify in 16KB increments.

Select <F10> to continue and specify the full path of your ACAD directory at the prompt. Press <enter> to complete the installation process.

To start the AutoCAD with the Display List Driver, change into the AutoCAD directory and type:

`C:\ACAD>AACAD <enter>`

You can also configure the AutoCAD driver manually with the following options:

usage: ACAD8E10 [h] [i] [d] [v??] [s] [e??] [u]
where:

- h : this help message
- i : gray background (default: black background)
- d : dual screen (default: single monitor)
(8514 and a monochrome TTL monitor)
- dc : dual screen
(8514 and an analog monitor)
- l : 16 color display (default: 256 colors)
- v?? : hexadecimal interrupt vector(default: vector 7A hex)
- s? : select drive for temp file (default: drive c:\)
Example: option sd selects drive D:\ to temporary files.
- e?? : decimal Expanded Memory Pages (default: 16 pages 256K)
Example: option e16 selects 16 Expanded memory pages for a total of 256K of expanded memory used for the display list.
Use option e0 to disable the Display List.
- u : Unload ADI driver from memory. If the driver was installed with a different interrupt vector than 7Ah, precede the "u" option with the "v??" Interrupt Vector that was installed.

Installing the AutoCAD 386 Driver *

To install the AutoCAD 386 Protected Mode driver, load "INSTALL" and select the following options:

- Menu 1 - "Install ATI Enhanced Drivers" <enter>
- Menu 2 - "AutoCAD" <enter>
- Menu 3 - "AutoCAD 386 Release 10" <enter>
or "AutoCAD 386 Release 11" <enter> as appropriate

The following menu will appear on screen:

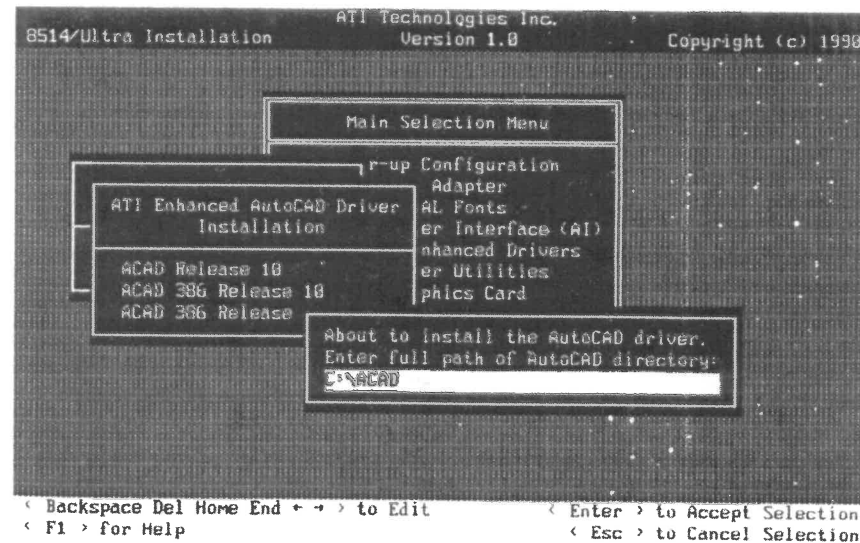

* Although the Real Mode driver also supports AutoCAD 386, the Protected Mode driver will provide significantly better performance (up to 9x faster).

Specify the full path of your AutoCAD 386 directory at the prompt and select <enter> to continue.

To configure the driver, start AutoCAD and select:

"5. Configure AutoCAD" <enter>

Enter the appropriate choices at these options:

0	Black background
1	Gray background
0	Single monitor
1	Dual 8514 and Monochrome
2	Dual 8514 and Analog
0	256 colors
1	16 colors
Display List size xxxxK	
New size (0 disables) xxxx	

Enter the Display List size in 16KB increments. After completing this menu, you will be given the choice of saving the new configuration; select <Y> for yes.

The Display List driver is automatically loaded when you start AutoCAD 386.

Using the Display List Driver

The 8514/ULTRA's Display List Driver adds two new functions to AutoCAD and AutoCAD 386:

1. Bird's Eye View
2. Display List Meter

After installing the ATI driver, two new functions appear in the AutoCAD menu in the lower right hand corner of the screen.

Bird's Eye View

To operate the Bird's Eye View, move the cursor into the Display List Meter selection on the bottom right hand corner of the screen. The menu will change to read "Birdseye"; Click on the left mouse button to select. Bird's Eye can also be activated by typing at the command line:

BEV<enter>

or ZOOMD<enter>

A zoom box or Bird's Eye box will appear on screen, as shown below:

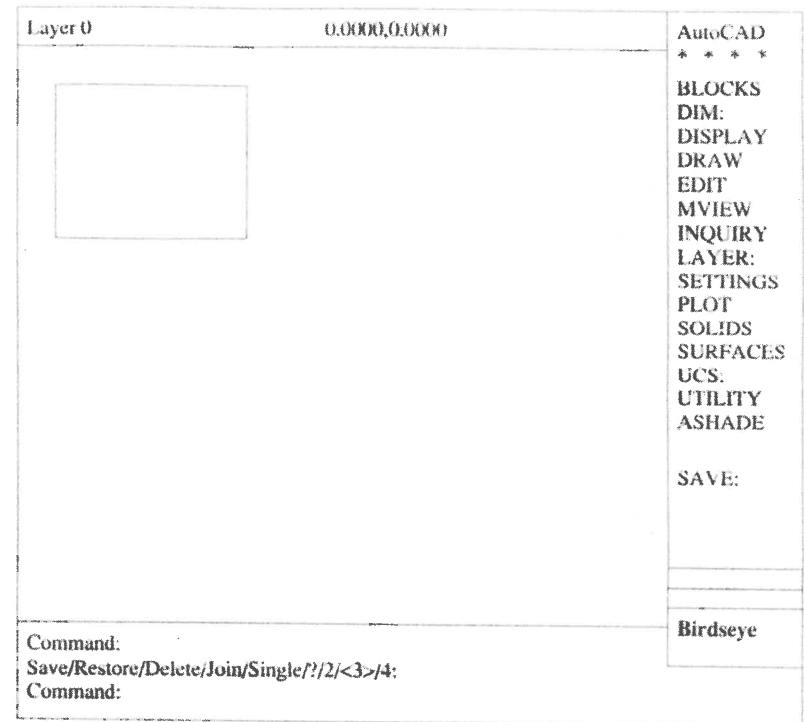

The left mouse button will allow you to dynamically adjust the size of the Bird's Eye. After selecting the Bird's Eye, click on the left button to resize the box. Move the mouse until the box is the size required; click again on the left button to select that size.

Move the zoom box to the area of the drawing you wish to view in more detail. Press the right mouse button to zoom in on the view. The view will be magnified and the Bird's Eye box will disappear.

To exit the Bird's Eye without zooming in on an area, move the cursor to the AutoCAD icon in the upper right hand corner of the screen and click the left button.

The outer boundaries of the active view contained in the Display List will be surrounded in a flashing white box. If you elect to zoom in on an area outside the Display List, or attempt to zoom in for too much detail, a **REGEN** warning will appear on the top of the AutoCAD menu bar.

➤ **NOTE**
Bird's Eye View will not operate on a Viewport that is displaying a "Perspective" view. This is an AutoCAD restriction.

Display List Meter

When adding lines and solids, zooming, panning or changing the active view, you will notice that the numbers on the Display List Meter at the bottom right corner of the screen will change with each operation. With each operation, the contents of the Display List are updated to include the new vector information.

Layer 0	0.0000,0.0000	AutoCAD * * * *
		BLOCKS DIM: DISPLAY DRAW EDIT MVIEW INQUIRY LAYER: SETTINGS PLOT SOLIDS SURFACES UCS: UTILITY ASHADE
		SAVE:
		X of XXXX K
Command: Save/Restore/Delete/Join/Single/?/2/<3>/4: Command:		

Because the Display List is a limited size, it is useful to monitor its size with the Meter. When you exceed the size of the available Display List, AutoCAD will redraw at its normal speed.

Therefore, it is desirable to clear the Display List of outdated information that is not relevant to the current view (if you are approaching the limits of the Display List). To clean the Display List, at the AutoCAD command prompt, type:

REGEN<enter>

➤ **NOTE**
If you are consistently filling the Display List, increase the size of the Display List memory.

APPENDIX A

Troubleshooting and Diagnostics

The 8514/ULTRA comes complete with two advanced diagnostic programs; one which tests the card on power-up and the other which can be performed by the user.

Automatic Power-Up Test

When the computer is first turned on, the 8514/ULTRA initializes itself and then runs through a self-test procedure, checking each component of the adapter.

If an error is detected, the following diagram appears on screen:

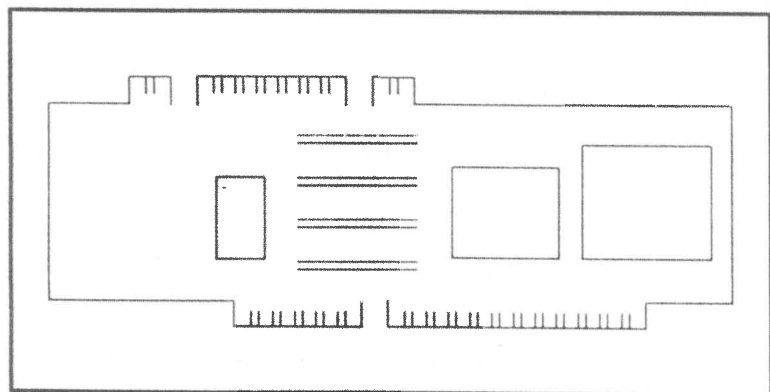

The fault is indicated by a flashing component indicating an error code. The error codes are listed on the following page.

Error Messages

Errors are followed by a pictograph indicating the possible defective component. Unless otherwise specified, these errors may be generated from the boot ROM or the extended diagnostic program TEST.COM.

Error messages are in the format:

```
142nn xxxx xxxx Error message
where 142 is the error code identifying the 8514/ULTRA.
      nn is the error number.
      xxxx addition error information.
```

14201 Video Adapter Not Detected

Only occurs in TEST.COM and indicates that no 8514/ULTRA is present in the system. If the 8514/ULTRA is actually present, this message would indicate a severe failure (i.e. I/O conflict with another board, bad bus timing, or bad gate array, or a bad board).

14202 Pass-through Connector Configuration Error

Occurs when a VGA Card is attached to a digital monitor and the pass-through cable connected. This is an invalid configuration and may cause irreparable damage to the monitor connected to the 8514/ULTRA. Either disconnect the digital monitor or disconnect the pass-through cable.

14203 Subsystem Failure

Indicates a severe failure.

14204 Graphics Subsystem Failure

Generic error which indicates an error with the Mach 8 coprocessor. Should be treated as a severe failure.

14205 RAMDAC Failure

Indicates a failure in the RAMDAC test. Check the connection of the daughter board to the 8514/ULTRA.

14206 RAM Failure

Indicates a RAM data error. If every second RAM chip is failing, check the MEM_SIZE jumper. Multiple RAM failures would suggest a board level fault.

14207 RAM Addressing Failure

Should be treated as a RAM data failure.

14208 POST ROM Checksum Failure

An error has occurred during the POST ROM self check. Check that the

ROM address does not conflict with anything else. In Micro Channel systems, the ROM address is not configurable and must reside at C680.

14209 Configuration Failure

Indicates a bad EEPROM. Run the **INSTALL** utility and if the problem persists, it is a board failure.

14213 FIFO Overflow Failure

Indicates a severe failure.

14214 Data Not Ready Failure.

Indicates a severe failure.

INSTALL - Test Graphics Adapter

The **INSTALL** program has two options for testing the **8514/ULTRA**, as shown in the following menu:

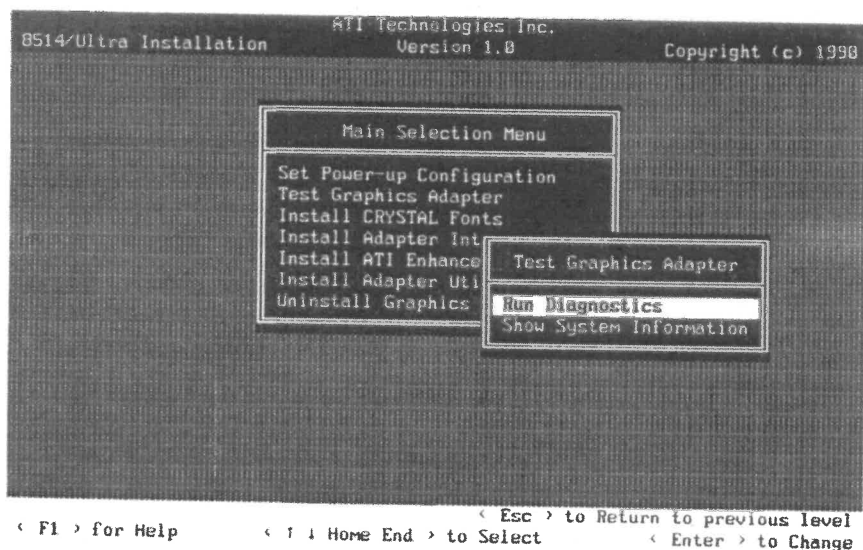

Diagnostic Test

The Diagnostic Utility contains detailed tests of the video display modes and the **8514/ULTRA**. The test screen on the following page, will appear when this option is selected.

Testing Video RAM
 ROM Integrity
 Register Integrity
 FIFO Integrity
 RAMDAC Integrity
 Test Sequence 1
 Test Sequence 2
 Test Sequence 3
 Test Pattern 1 (1024x768x8, interlaced)
 Test Pattern 2 (640x480x8, non-interlaced)
 Test Pattern 3 (640x480x4, non-interlaced)
 Test Pattern 4 (1024x768x8, 60 Hz non-interlaced)
 Test Pattern 5 (1024x768x8, 66 Hz non-interlaced)
 Test Pattern 6 (1024x768x8, 70 Hz non-interlaced)

► NOTE

As not all modes are functional on all monitors, these test patterns will be indicated as being skipped.

The following is a description of tests that the diagnostic program **TEST.COM** performs.

ROM Integrity Test

Performs a CRC checksum on the boot ROM. Fails if the ROM is bad or if there is a ROM address conflict. This test is skipped if the **8514/ULTRA** has not yet been installed.

Register Integrity Test

Performs writes and reads to some of the **8514/ULTRA** registers. An error with this test indicates a severe failure.

FIFO Integrity Test

Tests the FIFO. An error with this test indicates a severe failure.

RAMDAC Integrity Test

Tests the daughter board. In case of error, check the connection of the daughter board to the main board.

Video RAM Test

Tests the integrity of the video RAMs. If every second RAM chip is failing, check the JU3 (MEM_SIZE) jumper. If multiple RAM are failing the board is suspect.

Test Sequences

There are five test sequences. Boards equipped with 1M of memory will perform Test Sequences 1, 2 and 3. Minimum mode boards (512K) will perform Test Sequences 1M, 2M, and 3. These test all draw engine operations. Any error within any of these tests would indicate a failure of the Mach 8 coprocessor.

Test Patterns

There are seven test patterns as follows:

- Test Pattern 1 - 1024x768x8 87Hz interlaced
- Test Pattern 1M - 1024x767x4 87Hz interlaced
- Test Pattern 2 - 640x480x8 non-interlaced
- Test Pattern 3 - 640x480x4 non-interlaced
- Test Pattern 4 - 1024x768x8 60Hz non-interlaced
- Test Pattern 5 - 1024x768x8 66Hz non-interlaced
- Test Pattern 6 - 1024x768x8 70Hz non-interlaced

512K boards will only display Test Patterns 1M and 3.

Boards with interlaced monitors attached will display Test Patterns 1, 2 and 3.

60 Hz monitors will display Test Patterns 1, 2, 3, and 4.

66 Hz monitors will display Test Patterns 2, 3, and 5.

70 Hz monitors will display Test Patterns 1, 2, 3, and 6.

System Information

This option reports the configuration of the 8514/ULTRA and the contents of the AUTOEXEC.BAT and CONFIG.SYS files.

Troubleshooting

Refer to the following section to correct common problems encountered during the installation process. Because the typical

computer system consists of many different parts, difficulties may arise from a combination of items, from software or hardware installation to monitor compatibility.

In Case Of Severe Failure

Remove all unnecessary boards, disable shadow RAM, disable all high RAM, ensure that ROM is running, ensure that the 8514/ULTRA has been installed using the ATI utilities, ensure that the board is seated correctly; put the 8514/ULTRA in the slot closest to the VGA; try both 16 and 8 bit slots; try 16 bit slot with JU4 removed.

If The User Has Trouble Installing The ROM

Disable shadow RAM, disable all high RAM, try various different addresses until INSTALL.EXE accepts the location. The boot ROM only requires 4K of address space. Remember that Micro Channel machines must locate the boot ROM at C680 and is not configurable.

If The System Won't Boot

Power down, set JU1 to a closed position, power up, run INSTALL.EXE; power down; set JU1 to an open position; power up; you should see the 8514/ULTRA banner.

If The TEST.COM Test Patterns Are OK, But Applications Won't Sync.

The wrong monitor type has been selected, re-INSTALL.

If The Windows Driver Isn't Installing

The ULTRAGS.DRV driver requires at least 2M of memory with HIMEM.SYS installed. The ULTRAGS driver also requires that the CRYSTAL Fonts have been previously installed and the GSFONTS environment variable be set. Windows will not run correctly in protected mode if any EMM (Expanded Memory Manager) drivers, other than the Windows EMM Driver, are installed.

➤ NOTE

OEMSETUP.INF is different depending on whether Windows was originally installed using 5¼" or 3½" diskettes. This affects the CRYSTAL Fonts driver installation procedure. The CRYSTAL Fonts driver should be installed using the same diskette type as Windows was originally installed.

If The AutoCAD Driver Isn't Installing

If using a 386, ensure that AutoCAD has been configured for the ADI driver. The protected mode driver requires extended memory. If the user has a 286, the driver must be loaded as a TSR. The AutoCAD driver relies on the fonts supplied on the Utilities diskette. If they are not available, it falls back to the VGA character set. If the VGA character set is not available, AutoCAD will display garbage instead of text.

Notes About . . .**286 Systems**

Certain 286 chip sets may cause the ROM and/or diagnostics to report a severe failure. In this case, power down and set JU4 to an open position and try again.

8088 And 8086 Systems

Not supported.

Micro Channel Machines

Boot ROM address must reside at C680 and is not configurable. IRQ2 is forced and is not configurable. Micro Channel machines must be configured with their reference disks before using **INSTALL.EXE**.

Minimum Mode

The **8514/ULTRA** behaves very differently in the 512K configuration than it does in 1MB configuration. If an application uses direct register writes, ensure that it also supports min mode if using a 512K board.

Network Cards And XT Hard Disk Controllers.

Many network cards have a default I/O port base address of 2E0. This conflicts with the **8514/ULTRA**. The network card must be reconfigured since the address of the **8514/ULTRA** is not configurable. XT hard disk controllers have an adapter ROM at default address C800. If the adapter ROM is larger than 2K, it will conflict with the VESA recommended 8514/A address of C880.

VGA Cards

Some VGA cards do not support pass-through mode and will conflict any 8514/A graphics cards. These include cards using early revisions of the Tseng Labs ET3000 chip. Consult the manufacturer of the VGA card for a fix.

VGA's With Auto Monitor Detection

All VGA's which have this capability must use the analog VGA termination plug supplied with the **8514/ULTRA** package.

Windows

Only version 3.0 is supported. On laser printers using bit-mapped fonts, the appropriate printer bitmap must be available for the **CRYSTAL Font** to be displayed.

Using CRYSTAL Fonts with Specific Applications**Aldus PageMaker 3.01 & CRYSTAL Fonts**

For the best results with Aldus PageMaker, in the PageMaker Preferences dialog box, set "Greek Test Below..." to 1, and set "Vector Text Above..." to 127. This will allow the **CRYSTAL Driver** to provide **CRYSTAL Fonts** for all screen fonts regardless of display size.

Windows & CRYSTAL Fonts

Because of the design of Windows, **CRYSTAL Fonts** will not scale below 4-point size if a bit-mapped font of the same style resides on your hard disk. Therefore, Times Roman, Helvetica, and Symbol fonts cannot be scaled to show sizes below 4-points as a physical display size on the computer screen.

Windows & CRYSTAL Fonts 256 Color Driver

Because the **CRYSTAL Fonts** driver reserves a certain number of colors for the anti-aliasing technique, "palette-aware" programs, such as Powerpoint and Corel Draw, will use a dithering process to simulate additional colors. A combination of 20 pure colors are used by the driver to create dither patterns. If the dither patterns are not

satisfactory, it is recommended that you switch to the fast **CRYSTAL Font** driver for full 256 color support.

The majority of Windows applications are "not palette-aware" and will look better using the **CRYSTAL Fonts** driver. ATI uses a different algorithm for dithering which is superior to the one used by the standard IBM 8514/A driver.

Technical Support Form

Run these utilities before calling the Technical Support Department at ATI Technologies Inc. Record the information on the following forms. Have it available when talking to one of our representatives. If you write, please complete both pages of this report and mail to the address given on the back of this manual or fax to (416) 756-0720.

➤ **NOTE**

Run INSTALL and fill in the information from the Diagnostics and System Information program. ATI TECHNOLOGIES INC. WILL BE UNABLE TO PROCESS YOUR CALL WITHOUT THIS INFORMATION.

Diagnostics Test

Circle the problem areas on the following diagram.

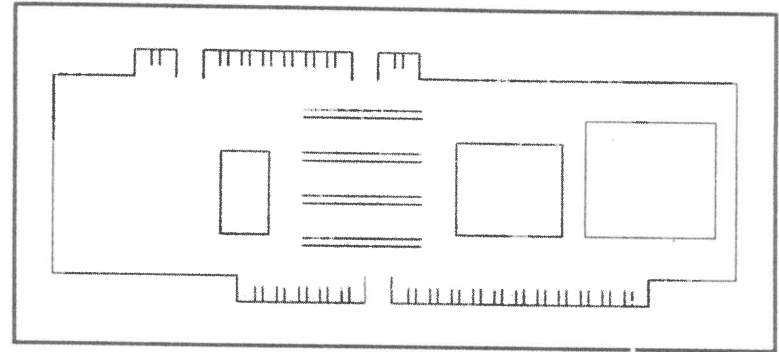

Name:	
Address:	
Phone No.:	Fax No.:
Serial No.:	
BIOS Version*:	INSTALL Version:
VGA Card:	
Type & Model of Computer:	
Type & Model of Monitor:	
Other Add-on Boards Installed & Version:	
Memory Board:	Driver Version:
Mouse (make):	Network:
Software & Version:	

* BIOS Version is displayed on the screen upon power up.

- | | | |
|---------------------|----------------------------------|--|
| EEPROM: | <input type="checkbox"/> Enabled | <input type="checkbox"/> Disabled |
| Bus Operation: | <input type="checkbox"/> 16-bit | <input type="checkbox"/> 8-bit |
| Bus Type: | <input type="checkbox"/> ISA | <input type="checkbox"/> Micro Channel |
| VRAM Memory: | <input type="checkbox"/> 1MB | <input type="checkbox"/> 512K |
| ROM Location: _____ | Version : _____ | |

System Information

DOS Version: _____

System ROM Date: _____

Computer Type: _____

Monitor: _____

Contents of AUTOEXEC.BAT: _____

Contents of CONFIG.SYS: _____

List the Steps to Recreate the Problem:

- **The ATI Technical Support Department hours:**
Monday, Wednesday to Friday 9:00 a.m. - 5:30 p.m. E.S.T.
Tuesday 10:30 a.m. - 5:30 p.m. E.S.T.
Tel: (416) 756-0711 Fax: (416) 756-0720

APPENDIX B

Memory Upgrade

To upgrade the memory to 1.0MB, it is required that you use one of the following VRAM chip types, Part number: Texas Instruments TMS 44C251-10 or 44C251-8 or NEC D42274V-10 or D42274V-8 (256x4 VRAM ZIP Packaging).

- **WARNING**
ZIP packaged components (such as VRAM) are more difficult to install than DIP packaged components. Use extreme care when installing the memory.
- **WARNING**
VRAM chips are static sensitive devices. Discharge any static electricity by grounding yourself to the chassis of the PC before handling the chips.

Install the VRAM chips in the empty sockets in the middle of the 8514/ULTRA board. Ensure that the orientation of the chip, as indicated by a notch at one end, is installed in the same direction as the other VRAMs on the card. After installation, inspect each chip carefully for bent pins or reverse insertion. A diagram is located on the following page.

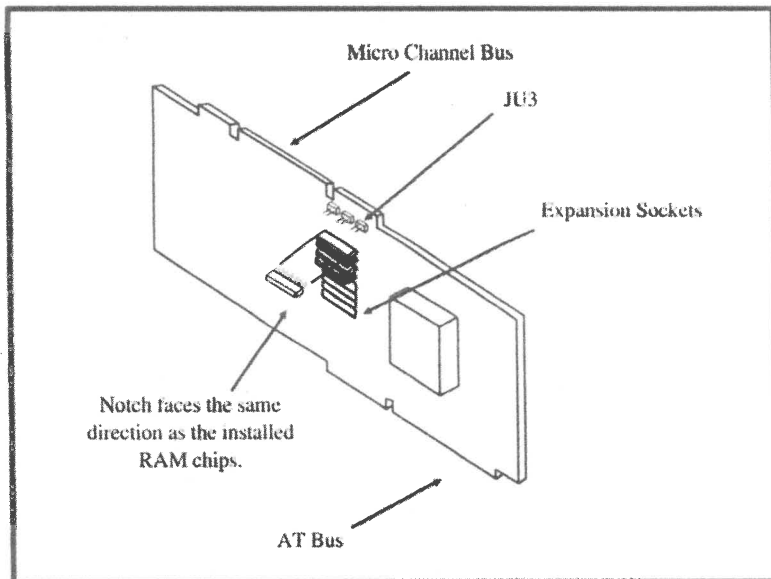

Move the jumper marked JU3, located on the top of the memory card to the open position.

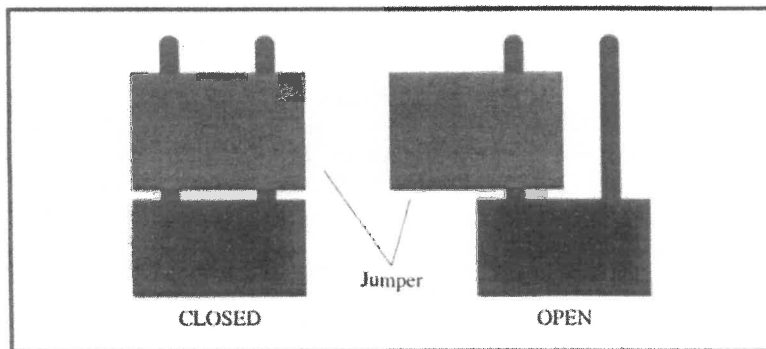

To check that the VRAM chips installed are in working order, run **INSTALL**. Select the option, "Test Graphics Adapter", followed by the option "Diagnostic Test". If a problem exists with the upgraded memory, it will be reported here. For more information on **INSTALL**, refer to Appendix A.

Specifications

System Requirements: IBM PC/AT, PS/2 Model or compatible systems.

Bus: 8 or 16 bit IBM PC/AT or Micro Channel with video bus.

Video Display Buffer: 512K or 1.0MB of video memory. 512K versions socketed for additional 512K expansion. Requires 256x4 VRAM 100ns ZIP packaging.

Pixel Clock Rate: Up to 75MHz.

Video Display Modes:

1024x768 (non-interlaced) in 16 or 256 colors.

1024x768 (interlaced) in 16 or 256 colors.

640x480 (non-interlaced) in 256 colors.

Sync Signals:	Horizontal	Vertical	Resolution
	56.0kHz	70Hz	1024x768 non-interlaced
	54.0kHz	66Hz	1024x768 non-interlaced Compaq AGC
	48.0kHz	60Hz	1024x768 non-interlaced
	35.5kHz	87Hz	1024x768 interlaced
	31.5kHz	60Hz	640x480 non-interlaced

Connectors: Analog Video: 15 pin D shell (female) IBM standard.

VGA Pass-through: 26 pin stake header (cable included) and Micro Channel video bus.

Monitor Compatibility: IBM 8514 analog color monitor, Multisync 3D, 4D or 5D compatible monitors. See Sync Signals for frequency support.

Performance*:	Random Vectors (5 pixel)	479,000/sec
	BITBLT (screen to screen)	21.5M pixels/sec
	Peak Linedraw Rate (random)	8.2M pixels/sec
	Rectangle Fill	41.0M pixels/sec
	Patterned Lines (50 pixel)	160,000/sec
	Screen Erase	100µs (2.5B pixels/sec)

*Results based on IBM PS/2 Model 70 80386 - 16MHz.

Dimensions: 3.5" (W) x 9.0" (D)

Power Requirements: +5V +/-5% @ 1.3A typical

MTBF: 120,000 hours.

Warranty: Two year warranty.

WARRANTY

ATI Technologies Inc. warrants that the hardware product is in good working condition, according to its specifications at the time of shipment, for a period of two years from the date of purchase. Should the product, in ATI Technologies Inc.'s opinion, malfunction with the warranty period, ATI Technologies Inc. will repair or replace the product without charge. Any replaced parts become the property of ATI Technologies Inc. This warranty does not apply to the software component of a product or a product which has been damaged due to accident, misuse, abuse, improper installation, usage not in accordance with product specifications and instructions, natural or personal disaster or unauthorized alterations, repairs or modifications.

Limitations

ALL WARRANTIES FOR THIS PRODUCT, EXPRESSED OR IMPLIED, ARE LIMITED TO TWO YEARS FROM THE DATE OF PURCHASE AND NO WARRANTIES, EXPRESSED OR IMPLIED, WILL APPLY AFTER THAT PERIOD.

NO WARRANTIES FOR THIS PRODUCT, EXPRESSED OR IMPLIED, SHALL EXTEND TO ANY PERSON WHO PURCHASES THE PRODUCT IN A USED CONDITION.

THE LIABILITY OF ATI TECHNOLOGIES INC. IN RESPECT OF ANY DEFECTIVE PRODUCT WILL BE LIMITED TO THE REPAIR OR REPLACEMENT OF SUCH PRODUCT. ATI TECHNOLOGIES INC. MAY USE NEW OR EQUIVALENT TO NEW REPLACEMENT PARTS.

ATI TECHNOLOGIES INC. MAKES NO OTHER REPRESENTATIONS OR WARRANTIES AS TO FITNESS FOR PURPOSE, MERCHANTABILITY OR OTHERWISE IN RESPECT OF THE PRODUCT. NO OTHER REPRESENTATIONS, WARRANTIES OR CONDITIONS, SHALL BE IMPLIED BY STATUTE OR OTHERWISE.

IN NO EVENT SHALL ATI TECHNOLOGIES INC. BE RESPONSIBLE OR LIABLE FOR ANY DAMAGES ARISING

- (a) FROM THE USE OF THE PRODUCT;
- (b) FROM THE LOSS OF USE, REVENUE OR PROFIT OF THE PRODUCT; OR
- (c) AS A RESULT OF ANY EVENT, CIRCUMSTANCE, ACTION OR ABUSE BEYOND THE CONTROL OF ATI TECHNOLOGIES INC.;

WHETHER SUCH DAMAGES BE DIRECT, INDIRECT, CONSEQUENTIAL, SPECIAL OR OTHERWISE AND WHETHER SUCH DAMAGES ARE INCURRED BY THE PERSON TO WHOM THIS WARRANTY EXTENDS OR A THIRD PARTY.

Warranty Service

Units requiring repair under warranty require an RMA number. To obtain service under this warranty, first contact:

ATI TECHNOLOGIES INC.
TECHNICAL SUPPORT
Tel: (416) 756-0711
Fax: (416) 756-0720

or by writing:

ATI TECHNOLOGIES INC.
TECHNICAL SUPPORT
3761 Victoria Park Avenue,
Scarborough, Ontario,
Canada M1W 3S2

and request a Return Material Authorization Number (RMA). This number must be clearly displayed on the unit's external packaging. Units shipped without an RMA number will not be accepted. Include with the unit, proof of purchase (including date of purchase), a note outlining the problem, and the RMA number.

Product should be sent to:

ATI TECHNOLOGIES INC.
SERVICE CENTRE
60 Valleybrook Drive
Don Mills, Ontario
Canada M3B 2S9

IMPORTANT

When shipping your unit, pack securely and ship prepaid and insured. ATI Technologies Inc. will not be held liable for damage or loss to the product in shipment.

INDEX

- A**
 Adapter Interface - 3, 31
 Adobe Type Manager - 36, 53
 Appendix A - 47
 Appendix B - 57
 AutoCAD - 19, 27
 Automatic Power-Up Test - 47
 AutoSHADE - 27
- B**
 Bird's Eye View - 44
- C**
 Compatibility - 36
 Configuring the 8514/ULTRA - 18
 Contents of the Package - 5
 CRYSTAL Fonts - 2, 34, 53
- D**
 Diagnostics - 47
 Diagnostics Test - 50, 55
 Display List Meter - 45
 DOC Compliance Statement - i
 Drivers - 23
 ADI - 38
 ATI Enhanced - 27
 AutoCAD - 39
 AutoCAD 386 - 42
 Display List - 43
 Real Mode - 39
 Windows - 33, 34
- E**
 Error Messages - 47
- F**
 FCC Compliance Statement - i
 Features - 1
- G**
 Graphics Adapter
 Test - 25, 49
 Uninstall - 29
 Install Test - 49
- I**
 Installation
 Adapter Interface - 26
 Adapter Utilities - 28
 ATI Enhanced Drivers - 27
 AutoCAD Driver - 39
 AutoCAD 386 Driver - 42
 CRYSTAL Fonts - 25
 ISA/EISA - 8
 INSTALL - 24
 Micro Channel - 13
- Software - 23
 Test Graphics Adapter - 49
 Windows - 34
- Introduction - 1
 ISA - 6, 8
- J**
 Jumpers - 6, 7
- M**
 Memory Upgrade - 57
 Micro Channel - 6, 13
 Monitor Selection - 19
- N**
 Notes - 53
- P**
 PageMaker - 53
- R**
 Real Mode Driver - 39
 Background Field - 40
 Display List Expanded Memory - 40
 Display Mode - 40
 Drive to Hold Temporary Files - 40
 Graphic Rendering Display - 40
 Interrupt Vector - 40
 Screen Mode - 40
 ROM Address Selection - 20
- S**
 Save Configuration - 20
 Set Power-Up
 Configuration - 19, 25
 Software
 Installation - 23
 Support - 31
 Specifications - 59
 System Information - 51, 56
- T**
 Technical Support Form - 54
 Troubleshooting - 47, 52
- U**
 Using the Display List Driver - 43
 Utilities 23
- V**
 VGA Pass-through - 6
- W**
 Warranty - 60
 Windows - 33, 34

8514/ULTRA WARRANTY REGISTRATION CARD

Name: _____ Title: _____
 Company: _____ Purchased From: _____
 Address: _____ Address: _____
 State _____ Zip _____ State _____ Zip _____
 Telephone _____ Telephone _____

Serial No. (see back of the card): _____ Price: _____
 Purchase Date: _____/_____/_____
 1. I've decided to buy because of:
 Price High Res. Quality Compatibility Brand Name
 Driver Support Analog/Digital Monitors Dealer Recommendation Availability Other: (specify) _____

2. VGA card used:
 Brand: _____ Model: _____ Mon: _____ Color _____
 Digital VGA Analog 8514 Multisync

3. Monitor used:
 Brand: _____ Model: _____ Color _____
 Digital VGA Analog 8514 Multisync

4. I read:
 PC Magazine PC World PC Week InfoWorld
 Other: (specify) _____

5. My Principal Software Applications are:
 1. _____
 2. _____
 3. _____

6. I heard about this product from:
 Dealer Referral Trade Show Ad in: (specify) _____

7. Do you use:
 Modem-Mdl: _____ Brand: _____
 Fax - Mdl: _____ Brand: _____
 Plan to Buy: _____ Modem: _____
 Fax: _____

Warranty Registration Card

Technical Support is only available to registered users. Please complete the Warranty Card and return within 30 days of purchase. Proof of purchase including date and place of purchase must accompany product returned for service. A two year limited warranty is provided by ATI Technologies Inc.