



2K x 8 Static RAM

Features

- **Automatic power-down when deselected**
- **CMOS for optimum speed/power**
- **High speed**
— 15 ns
- **Low active power**
— 660 mW (commercial)
— 688 mW (military—20 ns)
- **Low standby power**
— 110 mW (20 ns)
- **TTL-compatible inputs and outputs**
- **Capable of withstanding greater than 2001V electrostatic discharge**
- **V_{IH} of 2.2V**

provided by an active LOW Chip Enable (\overline{CE}), and active LOW Output Enable (\overline{OE}) and three-state drivers. The CY7C128A has an automatic power-down feature, reducing the power consumption by 83% when deselected.

Writing to the device is accomplished when the Chip Enable (\overline{CE}) and Write Enable (\overline{WE}) inputs are both LOW.

Data on the eight I/O pins (I/O₀ through I/O₇) is written into the memory location specified on the address pins (A₀ through A₁₀).

Reading the device is accomplished by taking Chip Enable (\overline{CE}) and Output Enable (\overline{OE}) LOW while Write Enable (\overline{WE}) remains HIGH. Under these conditions, the contents of the memory location specified on the address pins will appear on the eight I/O pins.

The I/O pins remain in high-impedance state when Chip Enable (\overline{CE}) or Output Enable (\overline{OE}) is HIGH or Write Enable (\overline{WE}) is LOW.

The CY7C128A utilizes a die coat to insure alpha immunity.

Functional Description

The CY7C128A is a high-performance CMOS static RAM organized as 2048 words by 8 bits. Easy memory expansion is

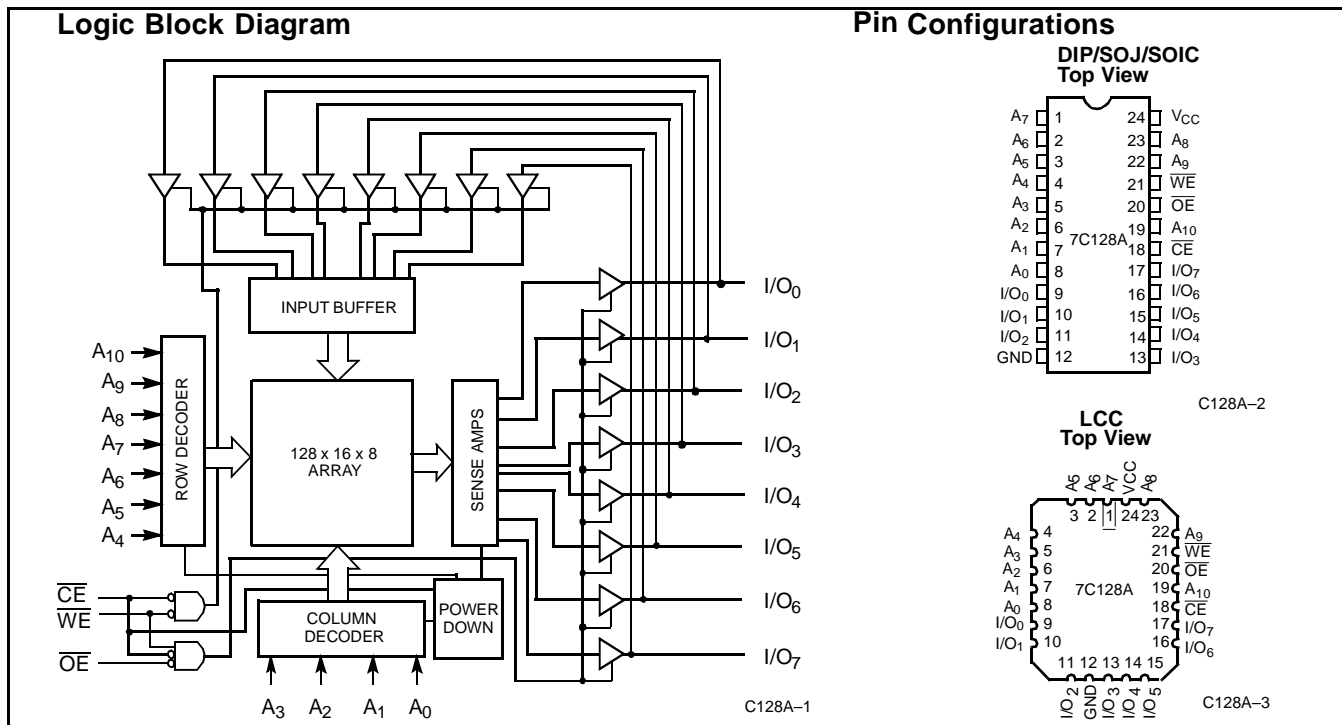

Selection Guide

		7C128A-15	7C128A-20	7C128A-25	7C128A-35	7C128A-45
Maximum Access Time (ns)		15	20	25	35	45
Maximum Operating Current (mA)	Commercial	120	120	120	120	120
	Military	-	125	125	125	125
Maximum Standby Current (mA)	Commercial	40	20	20	20	20
	Military	-	20	20	20	20

Maximum Ratings

(Above which the useful life may be impaired. For user guidelines, not tested.)

Storage Temperature	-65°C to +150°C
Ambient Temperature with Power Applied.....	-55°C to +125°C
Supply Voltage to Ground Potential (Pin 28 to Pin 14).....	-0.5V to +7.0V
DC Voltage Applied to Outputs in High Z State.....	-0.5V to +7.0V
DC Input Voltage.....	-3.0V to +7.0V

Output Current into Outputs (LOW).....	20 mA
Static Discharge Voltage	>2001V (per MIL-STD-883, Method 3015)
Latch-Up Current.....	>200 mA

Operating Range

Range	Ambient Temperature	V _{CC}
Commercial	0°C to +70°C	5V ± 10%
Military ^[1]	-55°C to +125°C	5V ± 10%

Electrical Characteristics Over the Operating Range^[2]

Parameter	Description	Test Conditions	7C128A-15		7C128A-20		7C128A-25		7C128A-35,45		Unit
			Min.	Max.	Min.	Max.	Min.	Max.	Min.	Max.	
V _{OH}	Output HIGH Voltage	V _{CC} = Min., I _{OH} = -4.0 mA	2.4		2.4		2.4		2.4		V
V _{OL}	Output LOW Voltage	V _{CC} = Min., I _{OL} = 8.0 mA		0.4		0.4		0.4		0.4	V
V _{IH}	Input HIGH Voltage		2.2	V _{CC}	2.2	V _{CC}	2.2	V _{CC}	2.2	V _{CC}	V
V _{IL}	Input LOW Voltage ^[3]		-0.5	0.8	-0.5	0.8	-0.5	0.8	-0.5	0.8	V
I _{Ix}	Input Load Current	GND ≤ V _I ≤ V _{CC}	-10	+10	-10	+10	-10	+10	-10	+10	μA
I _{OZ}	Output Leakage Current	GND ≤ V _I ≤ V _{CC} Output Disabled	-10	+10	-10	+10	-10	+10	-10	+10	μA
I _{OS}	Output Short Circuit Current ^[4]	V _{CC} = Max., V _{OUT} = GND		-300		-300		-300		-300	mA
I _{CC}	V _{CC} Operating Supply Current	V _{CC} = Max. I _{OUT} = 0 mA	Com'l	120		120		120		120	mA
			Mil	-		125		125		125	
I _{SB1}	Automatic \overline{CE} Power-Down Current	Max. V _{CC} , $\overline{CE} \geq V_{IH}$, Min. Duty Cycle = 100%	Com'l	40		40		20		20	mA
			Mil	-		40		40		20	
I _{SB2}	Automatic \overline{CE} Power-Down Current	Max. V _{CC} , $\overline{CE}_1 \geq V_{CC} - 0.3V$, $V_{IN} \geq V_{CC} - 0.3V$ or $V_{IN} \leq 0.3V$	Com'l	40		20		20		20	mA
			Mil	-		20		20		20	

Capacitance^[5]

Parameter	Description	Test Conditions	Max.	Unit
C _{IN}	Input Capacitance	T _A = 25°C, f = 1 MHz, V _{CC} = 5.0V	10	pF
C _{OUT}	Output Capacitance		10	pF

Notes:

1. T_A is the "instant on" case temperature.
2. See the last page of this specification for Group A subgroup testing information.
3. V_{IL} (min.) = -3.0V for pulse durations less than 30 ns.
4. Not more than 1 output should be shorted at one time. Duration of the short circuit should not exceed 30 seconds.
5. Tested initially and after any design or process changes that may affect these parameters.

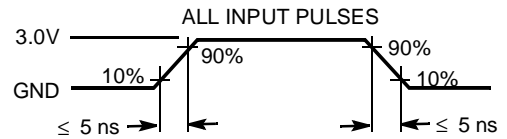
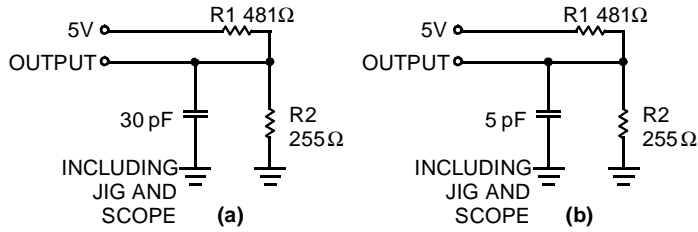
AC Test Loads and Waveforms

Equivalent to: THÉVENIN EQUIVALENT

C128A-4

C128A-5

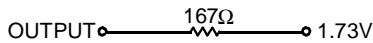
Switching Characteristics Over the Operating Range^[2, 6]

Parameter	Description	7C128A-15		7C128A-20		7C128A-25		7C128A-35		7C128A-45		Unit
		Min.	Max.	Min.	Max.	Min.	Max.	Min.	Max.	Min.	Max.	
READ CYCLE												
t_{RC}	Read Cycle Time	15		20		25		35		45		ns
t_{AA}	Address to Data Valid		15		20		25		35		45	ns
t_{OHA}	Data Hold from Address Change	5		5		5		5		5		ns
t_{ACE}	\overline{CE} LOW to Data Valid		15		20		25		35		45	ns
t_{DOE}	\overline{OE} LOW to Data Valid		10		10		12		15		20	ns
t_{LZOE}	\overline{OE} LOW to Low Z	3		3		3		3		3		ns
t_{HZOE}	\overline{OE} HIGH to High Z ^[7]		8		8		10		12		15	ns
t_{LZCE}	\overline{CE} LOW to Low Z ^[8]	5		5		5		5		5		ns
t_{HZCE}	\overline{CE} HIGH to High Z ^[7, 8]		8		8		10		15		15	ns
t_{PU}	\overline{CE} LOW to Power-Up	0		0		0		0		0		ns
t_{PD}	\overline{CE} HIGH to Power-Down		15		20		20		20		25	ns
WRITE CYCLE^[9]												
t_{WC}	Write Cycle Time	15		20		20		25		40		ns
t_{SCE}	\overline{CE} LOW to Write End	12		15		20		25		30		ns
t_{AW}	Address Set-Up to Write End	12		15		20		25		30		ns
t_{HA}	Address Hold from Write End	0		0		0		0		0		ns
t_{SA}	Address Set-Up to Write Start	0		0		0		0		0		ns
t_{PWE}	\overline{WE} Pulse Width	12		15		15		20		20		ns
t_{SD}	Data Set-Up to Write End	10		10		10		15		15		ns
t_{HD}	Data Hold from Write End	0		0		0		0		0		ns
t_{HZWE}	\overline{WE} LOW to High Z ^[7]		7		7		7		10		15	ns
t_{LZWE}	\overline{WE} HIGH to Low Z	5		5		5		5		5		ns

Notes:

- Test conditions assume signal transition time of 5 ns or less, timing reference levels of 1.5V, input pulse levels of 0 to 3.0V, and output loading of the specified I_{OL}/I_{OH} and 30-pF load capacitance.
- t_{HZOE} , t_{HZCE} , and t_{HZWE} are specified with $C_L = 5$ pF as in part (b) of AC Test Loads. Transition is measured ± 500 mV from steady state voltage.
- At any given temperature and voltage condition, t_{HZCE} is less than t_{LZCE} for any given device.
- The internal write time of the memory is defined by the overlap of \overline{CE} LOW and \overline{WE} LOW. Both signals must be LOW to initiate a write and either signal can terminate a write by going HIGH. The data input set-up and hold timing should be referenced to the rising edge of the signal that terminates the write.

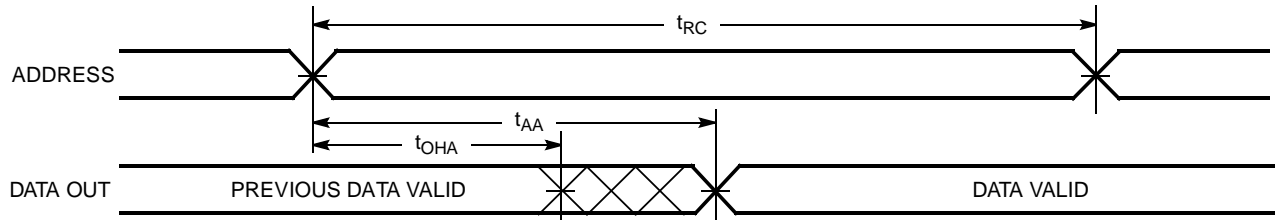
Switching Waveforms
Read Cycle No. 1^[10, 11]

C128A-6

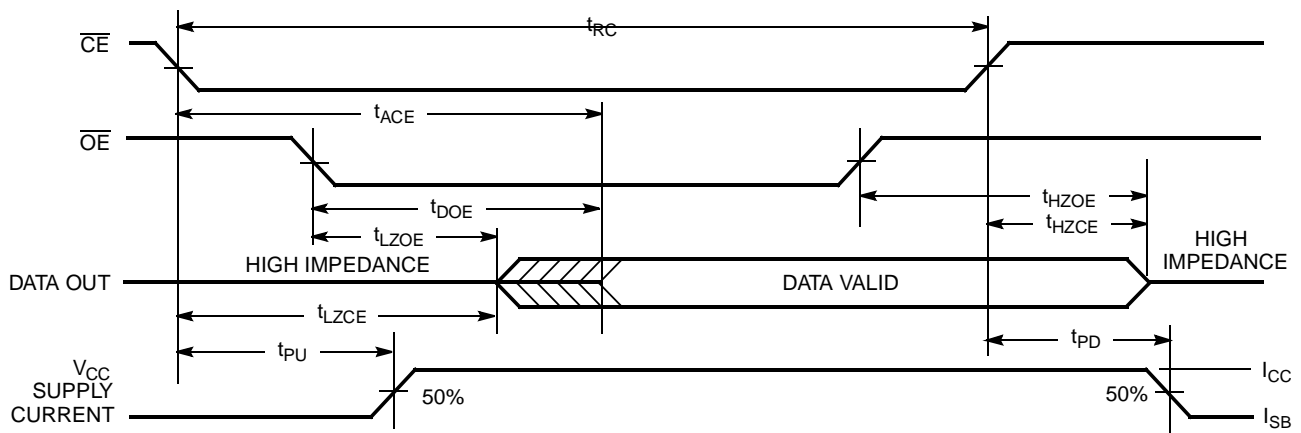
Read Cycle No. 2^[10, 12]

C128A-7

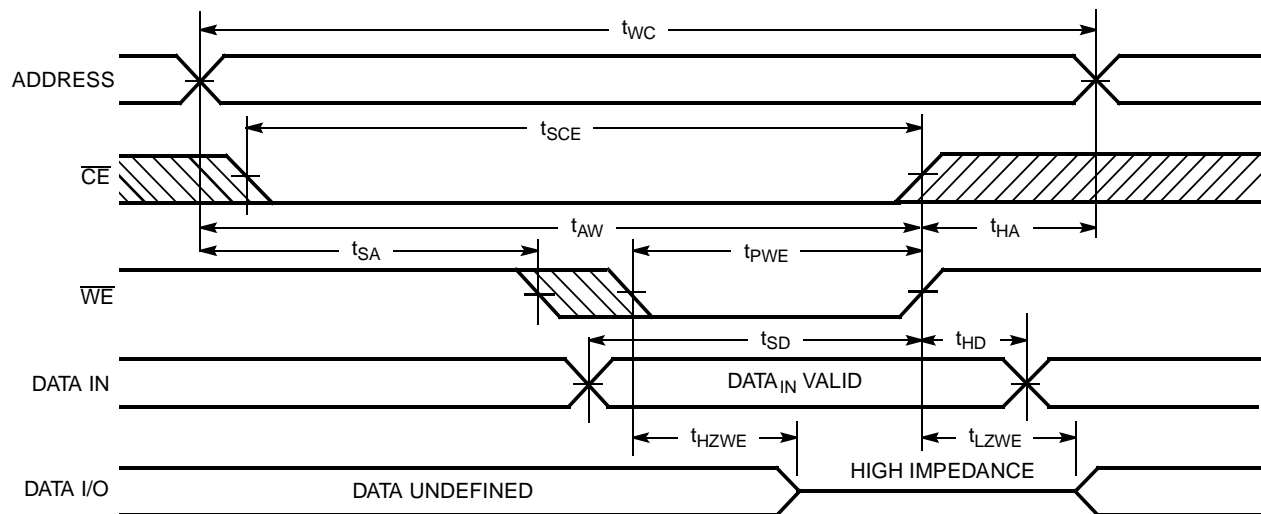
Write Cycle No. 1 (WE Controlled)^[9,]

C128A-8

Notes:

10. \overline{WE} is HIGH for read cycle.
11. Device is continuously selected. $\overline{OE}, \overline{CE} = V_{IL}$.
12. Address valid prior to or coincident with \overline{CE} transition LOW.
13. Data I/O pins enter high-impedance state, as shown, when \overline{OE} is held LOW during write.

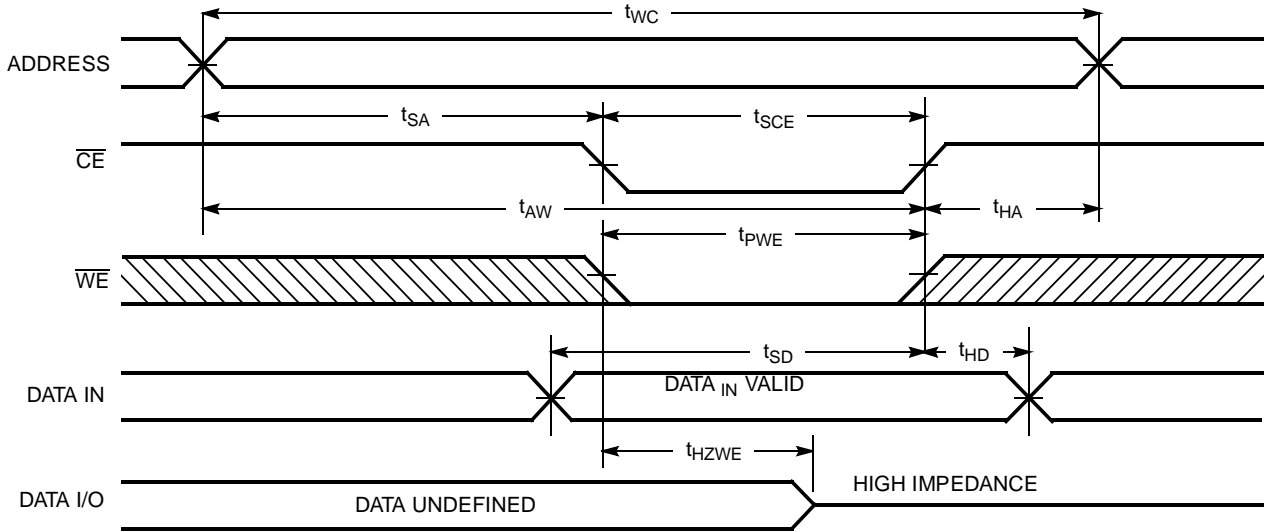
Switching Waveforms (continued)
Write Cycle No. 2 (\overline{CE} Controlled)^[9, 13, 14]

C128A-9

Notes:

14. If \overline{CE} goes HIGH simultaneously with \overline{WE} HIGH, the output remains in a high-impedance state.

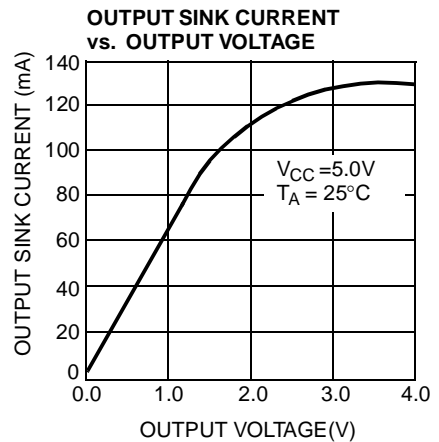
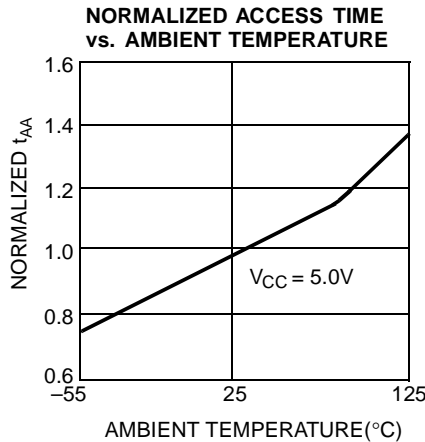
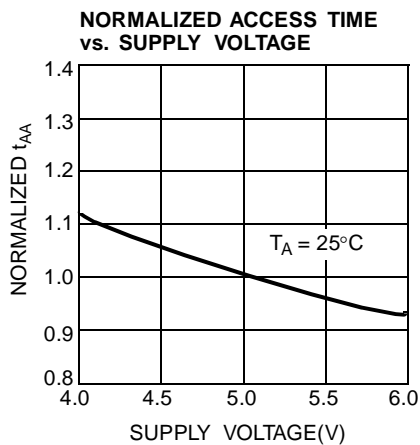
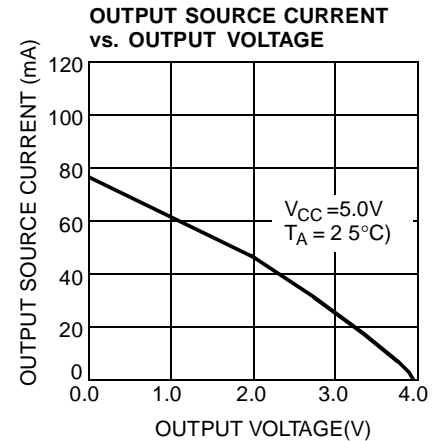
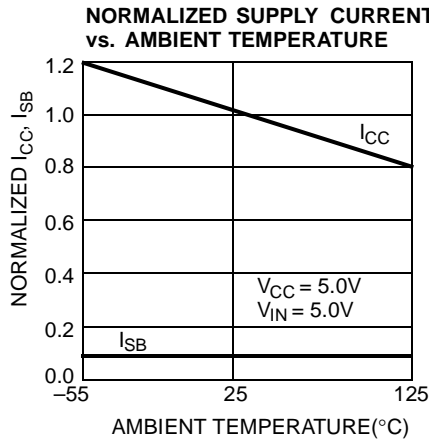
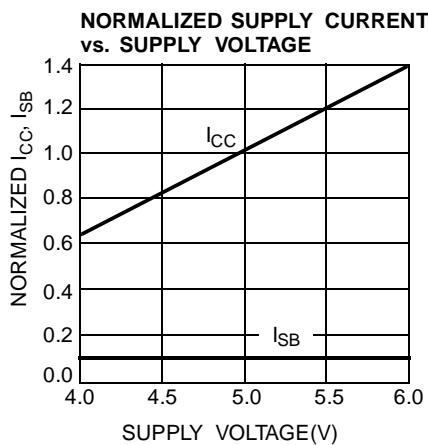
Typical DC and AC Characteristics

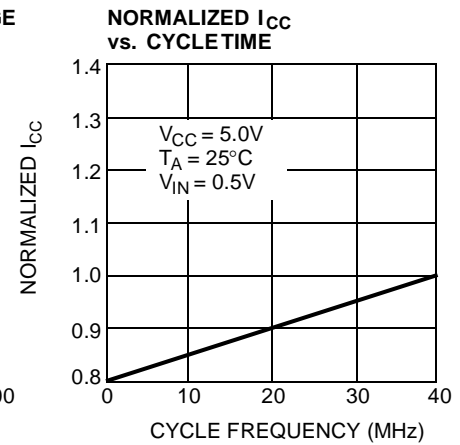
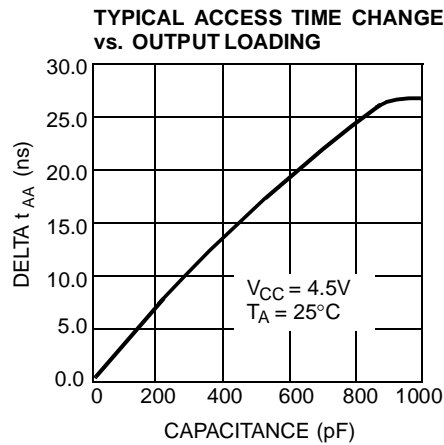
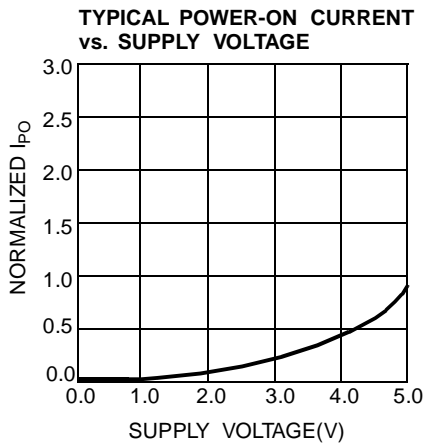
Typical DC and AC Characteristics (continued)

Ordering Information

Speed (ns)	Ordering Code	Package Name	Package Type	Operating Range
15	CY7C128A-15PC	P13	24-Lead (300-Mil) Molded DIP	Commercial
	CY7C128A-15VC	V13	24-Lead Molded SOJ	
	CY7C128A-15SC	S13	24-Lead (300-Mil) Molded SOIC	
20	CY7C128A-20PC	P13	24-Lead (300-Mil) Molded DIP	Commercial
	CY7C128A-20VC	V13	24-Lead Molded SOJ	
	CY7C128A-20SC	S13	24-Lead (300-Mil) Molded SOIC	
	CY7C128A-20DMB	D14	24-Lead (300-Mil) CerDIP	Military
	CY7C128A-20LMB	L53	24-Pin Rectangular Leadless Chip Carrier	
25	CY7C128A-25PC	P13	24-Lead (300-Mil) Molded DIP	Commercial
	CY7C128A-25VC	V13	24-Lead Molded SOJ	
	CY7C128A-25SC	S13	24-Lead (300-Mil) Molded SOIC	
	CY7C128A-25DMB	D14	24-Lead (300-Mil) CerDIP	Military
35	CY7C128A-35PC	P13	24-Lead (300-Mil) Molded DIP	Commercial
	CY7C128A-35VC	V13	24-Lead Molded SOJ	
	CY7C128A-35SC	S13	24-Lead (300-Mil) Molded SOIC	
	CY7C128A-35DMB	D14	24-Lead (300-Mil) CerDIP	Military
45	CY7C128A-45PC	P13	24-Lead (300-Mil) Molded DIP	Commercial
	CY7C128A-45VC	V13	24-Lead Molded SOJ	
	CY7C128A-45SC	S13	24-Lead (300-Mil) Molded SOIC	
	CY7C128A-45DMB	D14	24-Lead (300-Mil) CerDIP	Military
	CY7C128A-45LMB	L53	24-Pin Rectangular Leadless Chip Carrier	

MILITARY SPECIFICATIONS
Group A Subgroup Testing
DC Characteristics

Parameter	Subgroups
V_{OH}	1, 2, 3
V_{OL}	1, 2, 3
V_{IH}	1, 2, 3
V_{IL} Max.	1, 2, 3
I_{IX}	1, 2, 3
I_{OZ}	1, 2, 3
I_{CC}	1, 2, 3
I_{SB}	1, 2, 3

Switching Characteristics

Parameter	Subgroups
READ CYCLE	
t_{RC}	7, 8, 9, 10, 11
t_{AA}	7, 8, 9, 10, 11
t_{OHA}	7, 8, 9, 10, 11
t_{ACE}	7, 8, 9, 10, 11
t_{DOE}	7, 8, 9, 10, 11
WRITE CYCLE	
t_{WC}	7, 8, 9, 10, 11
t_{SCE}	7, 8, 9, 10, 11
t_{AW}	7, 8, 9, 10, 11
t_{HA}	7, 8, 9, 10, 11
t_{SA}	7, 8, 9, 10, 11
t_{PWE}	7, 8, 9, 10, 11
t_{SD}	7, 8, 9, 10, 11
t_{HD}	7, 8, 9, 10, 11

Document #: 38-00094-C

Package Diagrams

24-Lead (300-Mil) CerDIP D14
MIL-STD-1835 D-9 Config.A

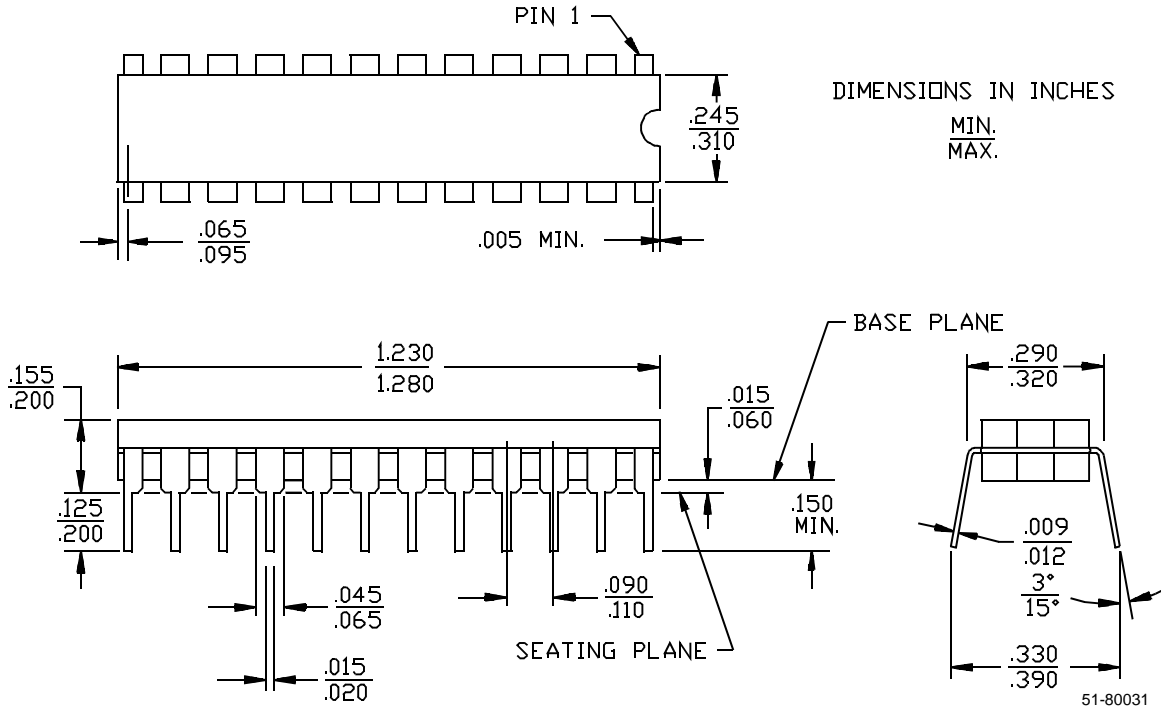

24-Pin Rectangular Leadless Chip Carrier L53

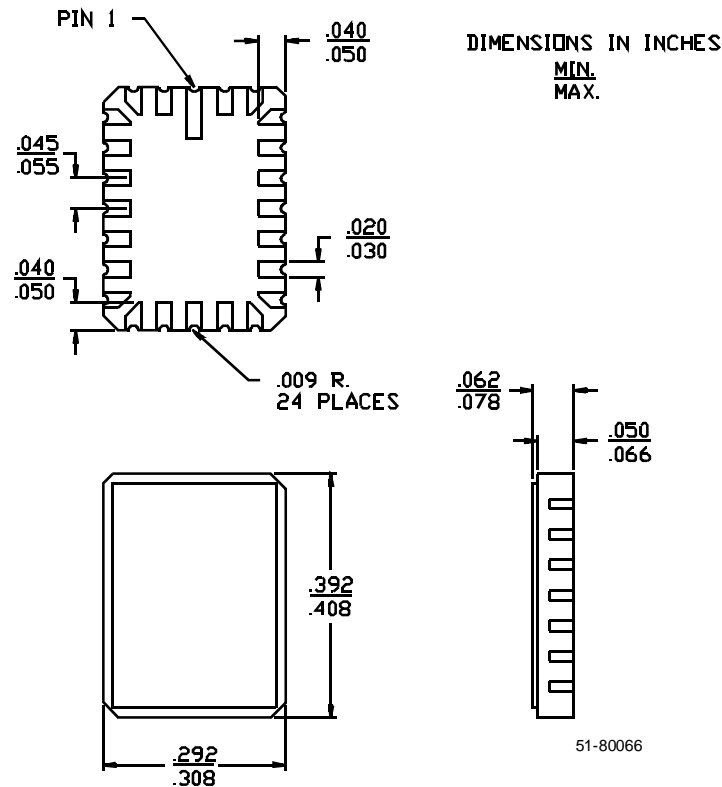

Package Diagrams (continued)
24-Lead (300-Mil) Molded DIP P13/P13A

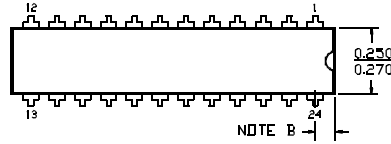
 DIMENSIONS IN INCHES MIN.
MAX.

	P 13	P 13A
NOTE A	1.170 1.200	1.230 1.260
NOTE B	0.030 0.050	0.060 0.080

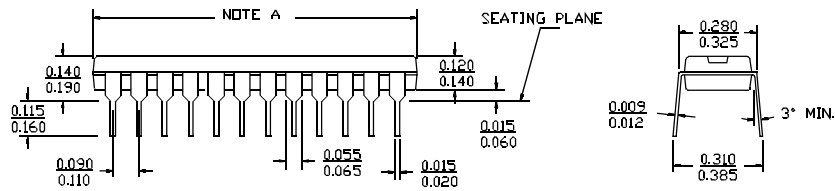
24-Lead (300-Mil) Molded SOJ V13

 DIMENSIONS IN INCHES MIN.
MAX.
