

FEATURES

- **32-bit GUI acceleration (CL-GD5426/28/29)**
 - BitBLT (Bit block transfer) engine
 - Color expansion for 8- or 16-bit pixels
- **16/32-bit CPU interface**
 - VESA® VL-Bus™ (up to 50 MHz)
 - ISA bus (12.5 MHz)
 - Zero-wait-state write cycles
- **Resolutions up to 1280 × 1024**
 - 1024 × 768 × 256 colors, non-interlaced
 - 800 × 600 × 64K colors, non-interlaced
 - 640 × 480 × 16M colors, non-interlaced
 - 1280 × 1024 × 256 colors, interlaced
 - 1024 × 768 × 64K colors, interlaced
- **Programmable dual-clock synthesizer**
 - Pixel clock programmable up to 86 MHz
 - Memory clock programmable up to 60 MHz
- **Integrated 24-bit true-color RAMDAC**
- **'Green PC' power-saving features**
 - VESA® DPMS (Display Power Management Signal)
 - Internal DAC with programmable power-down mode
 - Static monitor sync signals
- **Support for multimedia applications**
 - 3-3-2 RGB DAC modes for video playback (CL-GD5425/28/29)
 - Support of VAFC (VESA® advanced feature connector) baseline for video overlay (CL-GD5425/29)
- **100% hardware- and BIOS-compatible with IBM® VGA display standards**

True Color VGA Family

- CL-GD5429** — Memory-Mapped I/O VGA GUI Accelerator with Local Bus
- CL-GD5428** — Enhanced VGA GUI Accelerator with Local Bus
- CL-GD5426** — VGA GUI Accelerator with Local Bus
- CL-GD5425** — True Color VGA Controller with TV Output
- CL-GD5424** — True Color VGA with Local Bus
- CL-GD5422** — True Color VGA
- CL-GD5420** — Super VGA

OVERVIEW

The CL-GD542X family of true-color VGA controllers offers an extensive range of industry-leading features and functionality for IBM®-compatible personal computers.

Ideally suited to highly integrated systems, CL-GD542X devices require no external support other than display memory and a crystal frequency reference. CL-GD542X devices are 100% hardware- and BIOS-compatible with IBM VGA standards, and connect directly to an ISA or local bus, allowing a minimum adapter solution.

Operating at dot clock rates programmable up to 86 MHz, CL-GD542X devices support standard and VESA® high-resolution and extended modes. The internal palette DAC may be configured as an industry-standard RAMDAC to provide a palette of 256K colors, or true-color displays of 32K, 64K, and 16.8 million colors.

(cont.)

(cont.)

System Block Diagram

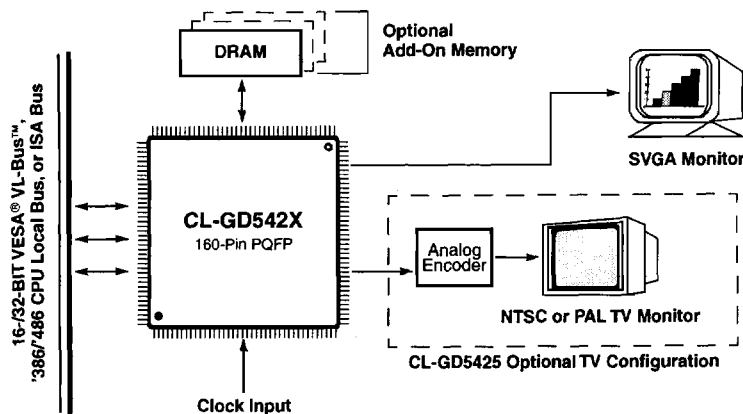

OVERVIEW (cont.)

The internal dual-frequency synthesizer requires a single crystal or reference for all supported screen resolutions, as well as all standard display memory speeds and formats. The CL-GD542X devices implement all control and data registers according to current VGA standards. They also implement all standard data path and manipulation functions, providing complete hardware compatibility.

In addition, the CL-GD542X devices support extended registers and capabilities to provide functional and performance enhancements beyond standard VGA.

CL-GD542X devices support ISA or 32-bit VESA VL-Bus interfaces in all operations, including I/O and memory

operations in planar modes. The write cycles to memory are optimized with zero-wait-state capability. Sixteen-/thirty-two-bit local bus interfacing can be achieved for '386SX, '386DX, and '486 microprocessors as well as VESA VL-Bus. The CL-GD5426/28/29 also offer BitBLT operation for GUI acceleration.

The CL-GD542X family also includes many power-saving ('Green PC') features, including an internal DAC with programmable power-down mode, sync signals that can be individually disabled (static levels), and internal clocks programmable to low frequencies for nearly static operation.

Software Support

| Software Drivers | Resolution Supported ^a | No. of Colors |
|---|---|------------------|
| Microsoft® Windows® 95 <i>CL-GD5425</i> | 640 × 480, 800 × 600, 1024 × 768 | 256 |
| | 640 × 480, 800 × 600 | 32,768 |
| | 640 × 480 | 16.8 million |
| Microsoft® Intel® DCI <i>CL-GD5425</i> | 640 × 480, 800 × 600, 1024 × 768 | 256 |
| | 640 × 480, 800 × 600 | 65,536 |
| | 640 × 480 | 16.8 million |
| Microsoft® Windows® v3.X <i>CL-GD5425</i> | 640 × 480, 800 × 600, 1024 × 768, 1280 × 1024 | 16 |
| | 640 × 480, 800 × 600, 1024 × 768, 1280 × 1024 | 256 |
| | 640 × 480, 800 × 600, 1024 × 768 | 65,536 |
| | 640 × 480 | 16.8 million |
| Microsoft® Windows NT™ v1.X | 640 × 480, 800 × 600, 1024 × 768 | 16 and 256 |
| OS/2® v2.0, v2.1 | 800 × 600, 1024, × 768 | 16 ^b |
| | 640 × 480, 800 × 600, 1024, × 768 | 256 ^b |
| AutoCAD® v11, v12, Autoshade® v2.0, w/ Renderman, 3D Studio™ v1,v2 | 640 × 480, 800 × 600, 1024 × 768, 1280 × 1024 | 16 |
| | 640 × 480, 800 × 600, 1024 × 768, 1280 × 1024 | 256 |
| | 640 × 480, 800 × 600, 1024 × 768 | 65,536 |
| | 640 × 480 | 16.8 million |
| GEM™ v3.X | 800 × 600, 1024 × 768 | 16 |
| Ventura Publisher® v2, v3 | 800 × 600, 1024 × 768 | 16 |
| Lotus® 1-2-3® v2.X, | 132 × 25, 132 × 43 (text) | 16 |
| | 800 × 600 | 16 |
| Lotus® 1-2-3® v3.X | 132 × 25, 132 × 43 (text) | 16 |
| | 800 × 600, 1024 × 768 | 16 |
| Microsoft® Word v5.X | 132 × 25, 132 × 43 (text) | 16 |
| | 800 × 600, 1024 × 768 | 16 |
| WordPerfect® v5.0 | 800 × 600 | 16 |
| WordPerfect® v5.1 | 132 × 25, 132 × 43 (text) | 16 |
| | 800 × 600, 1024 × 768 | 16 |
| WordStar® v5.5–v7.0 | 800 × 600, 1024 × 768 | 16 |

^a Not all monitors support all resolutions; 640 × 480 drivers will run on PS/2®,-type monitors. Extended resolutions are dependent upon monitor type and VGA system implementation.

^b OS/2® v2.0 requires a v2.0 Corrective Service Pack for 256 colors.

CL-GD5425 Highlights True Color VGA Controller with TV Output

FEATURES

- **True color VGA controller with TV output**
 - Scaling fits full VGA display into TV viewing area while maintaining proper aspect ratio
 - Flicker-filter reduces interlaced artifacts associated with computer-generated graphic images
- **Glueless interface to popular TV encoders**
- **Multimedia support**
 - Video overlay of 16-bit RGB, 16-bit YCrCb
 - 8-bit feature connector
 - 16-bit VAFC (VESA® advanced feature connector)
 - GENLOCK support
- **Graphics acceleration features:**
 - Color expansion reduces host bus traffic
 - 64 × 64 hardware cursor
 - Display memory linear addressing
- **Flexible 16-bit host interface**
 - VESA® VL-Bus™ (up to 50 MHz)
 - ISA bus
- **Flexible 32-bit display memory interface**
 - Supports 256K ×4, ×8, ×16 DRAMs
 - 512-Kbyte or 1-Mbyte memory capacity
- **Integrated 24-bit DAC**
 - VGA resolution up to 1024 × 768, 256 colors
 - NTSC resolution up to 640 × 480, 64K colors, scaled with flicker filter
 - PAL resolution up to 640 × 480, 64K colors with flicker filter

OVERVIEW

The CL-GD5425 integrates a Super VGA controller, dual-frequency synthesizer, true-color palette DAC, and TV processing support into a single device.

A member of the industry-standard CL-GD542X family of true color VGA controllers, the CL-GD5425 is fully backed by software and design support.

The CL-GD5425 provides NTSC/PAL timing for standard VGA display modes, as well as the following extended resolutions:

Extended Resolutions for TV Output

| Resolution | No. of Colors | Memory |
|------------|---------------|-----------|
| 640 × 480 | 256 | 512 Kbyte |
| 640 × 480 | 64K | 1 Mbyte |
| 640 × 400 | 64K | 512 Kbyte |

The CL-GD5425 provides integrated scaling, flicker reduction, and a glueless encoder interface that delivers high-quality TV display at the lowest possible cost without the need for additional frame or line stores.

The programmable flicker-reduction function reduces interlaced artifacts inherent in computer-generated images displayed on interlaced TV monitors. The degree of filtering is selectable by the end-user.

The CL-GD5425 is 100% hardware- and BIOS-compatible with VGA standards, and connects directly to the VESA® VL-Bus™ or ISA bus. A single DRAM, two frequency references, and an economical analog encoder are added to make a complete set-top graphics system.

CL-GD542X ADVANTAGES

Unique Features

Cost Effectiveness —

- Glueless interface to as few as one DRAM, built-in true-color palette DAC and dual-frequency synthesizer
- Interface to ×4, ×8, ×16 DRAMs

High Performance —

- 16-bit VESA® VL-Bus™ and local bus interface
- Hardware BitBLT for Windows® (CL-GD5425/26/28/29)
- 32-bit-wide DRAM interface
- Maximizes fast-page mode access to display-memory DRAMs
- Host access to DRAMs through advanced write buffers
- 15-, 16-, or 24-bit true-color palette DAC

Multimedia —

- 3-3-2 RGB DAC modes for video playback (CL-GD5425/28/29)
- NTSC or PAL output (CL-GD5425)
- Overlay and 'color key', and GENLOCK support

Compatibility —

- Compatible with VGA and VESA® standards
- Drivers supplied at various resolutions for Windows® 3.1, Windows® 95™, and other key applications
- Connects directly to multifrequency analog monitors

BIOS SUPPORT

- Fully IBM® VGA-compatible BIOS
- Relocatable, 32 Kbytes with VESA® VL-Bus™ local bus support
- VBE (VESA® BIOS extensions) support in ROM
- Support for DPMS (display power management signaling) in ROM

Benefits

- Minimizes chip count and board space; enables a cost-effective solution.
- Allows design flexibility for use of appropriate type and amount of memory.
- Increases system throughput.
- Accelerates GUI applications such as Microsoft® Windows® and similar applications.
- Eliminates display-memory bottleneck.
- Improves CPU performance by accessing maximum bandwidth available from DRAM display memory.
- Provides faster host access for writes to display memory.
- Provides high- and true-color display for photo-realistic images; 32K, 64K, or 16.8 million colors displayed simultaneously on screen for lifelike images.
- Enables high-resolution playback for live video applications.
- Allows TV viewing of PC games and applications.
- Allows 16-bit per pixel interfacing through the VESA® connector for multimedia applications.
- Ensures compatibility with installed base of systems and software.
- Provides a 'ready-to-go' solution that minimizes the need for additional driver development.
- Drives all PC-industry-standard, high-resolution monitors to ensure compatibility.

UTILITIES

- Graphics and video diagnostics test
- Windows® and DOS utilities
- Video mode configuration utility — CLMODE
- Set resolution in Windows® utility — WINMODE
- Configurable system integration for OEMs — OEMSI

CL-GD542X Family Features

| Features | 'GD5420 | 'GD5422 | 'GD5424 | 'GD5425 | 'GD5426 | 'GD5428 | 'GD5429 |
|--|---------------|---------------|---------------|---------------|---------------|---------------|---------------|
| Performance | | | | | | | |
| VESA® VL-Bus™ and Direct 80386 or 80486 CPU interface | | | ✓ | ✓ | ✓ | ✓ | ✓ |
| BitBLT engine | | | | | ✓ | Enhanced | MM I/O |
| Zero-wait-state operation | ✓ | ✓ | ✓ | ✓ | ✓ | ✓ | ✓ |
| Maximum display memory | 1 Mbyte | 1 Mbyte | 1 Mbyte | 1 Mbyte | 2 Mbytes | 2 Mbytes | 2 Mbytes |
| Display memory interface | 16-bit | 32-bit | 32-bit | 32-bit | 32-bit | 32-bit | 32-bit |
| Hardware cursor (in pixels) | up to 32 × 32 | up to 64 × 64 | up to 64 × 64 | up to 64 × 64 | up to 64 × 64 | up to 64 × 64 | up to 64 × 64 |
| Maximum dot clock frequency | 75 MHz | 80 MHz | 80 MHz | 80 MHz | 80 MHz | 80 MHz | 86 MHz |
| Maximum MCLK frequency | 50 MHz | 50 MHz | 50 MHz | 60 MHz | 50 MHz | 50 MHz | 60 MHz |
| High integration | | | | | | | |
| Integrated palette DAC and dual-frequency synthesizer | ✓ | ✓ | ✓ | ✓ | ✓ | ✓ | ✓ |
| Motherboard VGA solution with only two ICs | ✓ | ✓ | ✓ | Plus Encoder | ✓ | ✓ | ✓ |
| Built-in port for VESA® feature connector | ✓ | ✓ | ✓ | ✓ | ✓ | ✓ | ✓ |
| Built-in ISA (up to 12.5 MHz) bus support | ✓ | ✓ | ✓ | ✓ | ✓ | ✓ | ✓ |
| Built-in TV output support | | | | ✓ | | | |
| Flexibility | | | | | | | |
| Support for x4-, x8-, and x16-bit-wide DRAMs | ✓ | ✓ | ✓ | ✓ | ✓ | ✓ | ✓ |
| 8- or 16-bit host bus I/O and memory interface | ✓ | ✓ | ✓ | ✓ | ✓ | ✓ | ✓ |
| 8-bit gray and 3-3-2 RGB DAC modes | | | | ✓ | | ✓ | ✓ |
| CCIR 601 YCrCb mode | | | | ✓ | | | |
| General | | | | | | | |
| 100% hardware- and BIOS-compatible with IBM® VGA display standards | ✓ | ✓ | ✓ | ✓ | ✓ | ✓ | ✓ |
| 'Green PC' compliant | ✓ | ✓ | ✓ | ✓ | ✓ | ✓ | ✓ |
| 132-column text mode support | ✓ | ✓ | ✓ | ✓ | ✓ | ✓ | ✓ |
| 46E8 or 3C3 sleep mechanism | | ✓ | ✓ | ✓ | ✓ | ✓ | ✓ |
| Video overlay and 'color key' support | | ✓ | ✓ | ✓ | ✓ | ✓ | ✓ |
| VESA® VAFC™ base support (for video overlay) | | | | ✓ | | | ✓ |
| Low-power CMOS, 160-pin package | ✓ | ✓ | ✓ | ✓ | ✓ | ✓ | ✓ |
| Screen resolution and colors | | | | | | | |
| 640 × 480 | up to 256 | up to 16M | up to 16M | up to 16M | up to 16M | up to 16M | up to 16M |
| 800 × 600 | up to 256 | up to 64K | up to 64K | up to 64K | up to 64K | up to 64K | up to 64K |
| 1024 × 768 (interlaced) | up to 256 | up to 256 | up to 256 | up to 256 | up to 256 | up to 64K | up to 64K |
| 1024 × 768 (non-interlaced) | up to 256 | up to 256 | up to 256 | up to 256 | up to 256 | up to 256 | up to 256 |
| 1280 × 1024 (interlaced) | | up to 16 | up to 16 | up to 16 | up to 256 | up to 256 | up to 256 |

Table of Contents

| | |
|---|------------|
| CONVENTIONS | 8 |
| 1. PIN INFORMATION | 10 |
| 1.1 Pin Diagram (ISA Bus) | 10 |
| 1.2 Pin Diagram (MicroChannel® Bus) | 11 |
| 1.3 Pin Diagram (Local Bus) | 12 |
| 1.4 Pin Summary | 13 |
| 2. DETAILED PIN DESCRIPTIONS | 21 |
| 2.1 Host Interface — ISA Bus Mode | 21 |
| 2.2 Host Interface — MicroChannel® Bus Mode | 25 |
| 2.3 Host Interface — Local Bus (CL-GD5424/25/26/28/29 only) | 28 |
| 2.4 Dual-Frequency Synthesizer Interface | 31 |
| 2.5 Video Interface | 32 |
| 2.6 Display Memory Interface | 34 |
| 2.7 Miscellaneous Pins | 35 |
| 2.8 Power Pins | 36 |
| 3. FUNCTIONAL DESCRIPTION | 37 |
| 3.1 General | 37 |
| 3.2 Functional Blocks | 37 |
| 3.3 Functional Operation | 39 |
| 3.4 Performance | 40 |
| 3.5 Compatibility | 40 |
| 3.6 Board Testability | 40 |
| 4. CL-GD542X CONFIGURATION TABLES | 41 |
| 4.1 Video Modes | 41 |
| 4.2 Configuration Register, CF1 | 45 |
| 4.3 Host Interface Signals | 46 |
| 5. VGA REGISTER PORT MAP | 47 |
| 6. CL-GD542X REGISTERS | 48 |
| 7. ELECTRICAL SPECIFICATIONS | 54 |
| 7.1 Absolute Maximum Ratings | 54 |
| 7.2 DC Specifications (Digital) | 55 |
| 7.3 DC Specifications (Palette DAC) | 56 |
| 7.4 DC Specifications (Frequency Synthesizer) | 56 |
| 7.5 DAC Characteristics | 57 |
| 7.6 List of Waveforms | 58 |
| 8. PACKAGE DIMENSIONS | 101 |
| 9. ORDERING INFORMATION EXAMPLES | 102 |
| INDEX | 103 |

List of Figures

| | | |
|-------------|-----------------------------------|----|
| Figure 3-1. | CL-GD542X Chip Block Diagram..... | 38 |
|-------------|-----------------------------------|----|

List of Tables

| | | |
|------------|--|----|
| | Extended Resolutions for TV Output..... | 3 |
| | CL-GD542X Family Features..... | 5 |
| Table 1-1. | Host Interface — ISA/MicroChannel®..... | 13 |
| Table 1-2. | Host Interface — Local Bus (CL-GD5424/25/26/28/29 only)..... | 14 |
| Table 1-3. | Synthesizer Interface..... | 16 |
| Table 1-4. | Video Interface..... | 16 |
| Table 1-5. | Display Memory Interface..... | 17 |
| Table 1-6. | Miscellaneous Pins..... | 19 |
| Table 1-7. | Power and Ground..... | 20 |
| Table 2-1. | SBHE/A0 Decoding..... | 21 |
| Table 2-2. | IOCS16* Addresses..... | 23 |
| Table 2-3. | MSC16* Addresses..... | 23 |
| Table 2-4. | Zero Wait State* Cycles..... | 24 |
| Table 2-5. | –SBHE/A0 Decoding..... | 25 |
| Table 2-6. | MicroChannel® Cycle Type Encoding..... | 26 |
| Table 2-7. | –CD_DS16 Addresses..... | 27 |
| Table 2-8. | Redefined Host Interface Pins..... | 28 |
| Table 4-1. | Standard VGA Modes..... | 41 |
| Table 4-2. | Cirrus Logic Extended Video Modes..... | 42 |
| Table 4-3. | NTSC TV Video Modes (CL-GD5425 only)..... | 44 |
| Table 4-4. | PAL TV Video Modes (CL-GD5425 only)..... | 44 |
| Table 4-5. | Configuration Register Bits..... | 45 |
| Table 4-6. | Bus Connections..... | 46 |
| Table 5-1. | VGA Register Port Map..... | 47 |
| Table 6-1. | External/General Registers..... | 48 |
| Table 6-2. | VGA Sequencer Registers..... | 48 |
| Table 6-3. | CRT Controller Registers..... | 49 |
| Table 6-4. | VGA Graphics Controller Registers..... | 50 |
| Table 6-5. | VGA Attribute Controller Registers..... | 50 |
| Table 6-6. | Extension Registers..... | 51 |
| Table 6-7. | CL-GD5426/28/29 BitBLT Registers..... | 52 |

Revision History

The following are the differences between the July 1994 and May 1995 versions of this data book:

- The CL-GD5425 device and all pertinent information regarding it has been added.
- The BIOS timing diagrams have been updated.

CONVENTIONS

This section lists conventions used in this data book. 'CL-GD542X' represents CL-GD5420, CL-GD5422, CL-GD5424, CL-GD5425, CL-GD5426, CL-GD5428, and CL-GD5429, the six members of the True Color VGA controller family.

Abbreviations

| Units of measure | Symbol |
|----------------------------------|--------|
| degree Celsius | °C |
| hertz (cycle per second) | Hz |
| kilobyte (1,024 bytes) | Kbyte |
| kilohertz | kHz |
| kilohm | kΩ |
| megabyte (1,048,576 bytes) | Mbyte |
| megahertz (1,000 kilohertz) | MHz |
| microfarad | μF |
| microsecond (1,000 nanoseconds) | μs |
| milliampere | mA |
| millisecond (1,000 microseconds) | ms |
| nanosecond | ns |
| picovolt | pV |

The use of 'tbd' indicates values that are 'to be determined', 'n/a' designates 'not available', and 'n/c' indicates a pin that is a 'no connect'.

Acronyms

The following table lists acronyms used in this data book.

| Acronym | Definition |
|---------|---|
| AC | alternating current |
| BIOS | basic input/output system |
| BitBLT | bit boundary block transfer |
| CAD | computer-aided design |
| CAS | column address strobe |
| CLUT | color lookup table |
| CMOS | complementary metal-oxide semiconductor |
| CRT | cathode ray tube |
| DAC | digital-to-analog converter |
| DC | direct current |

| Acronym | Definition (cont.) |
|-------------|---|
| DPMS | display power management signaling |
| DRAM | dynamic random-access memory |
| EEPROM | electrically erasable/programmable read-only memory |
| EISA | extended industry standard architecture |
| EPROM | electrically programmable read-only memory |
| FIFO | first in/first out |
| HI-Z | high-impedance |
| HSYNC/VSYNC | horizontal/vertical synchronization |
| ISA | industry standard architecture |
| LSB | least-significant bit |
| LUT | lookup table |
| MD | memory data |
| MSB | most-significant bit |
| PCI | peripheral component interconnect |
| PQFP | plastic quad-flat pack |
| RAM | random-access memory |
| RAS | row address strobe |
| RGB | red, green, blue |
| ROPs | raster operations |
| R/W | read/write |
| SC | serial clock |
| TSR | terminate and stay resident |
| TTL | transistor-transistor logic |
| VAFC | VESA® advance feature connector |
| VESA® | Video Electronics Standards Association |
| VGA | video graphics array |
| VRAM | video random-access memory |

Numeric Naming

Hexadecimal numbers are represented with all letters in uppercase and a lowercase 'h' is appended to them (for example, '14h', '3A7h', and 'C000h' are hexadecimal numbers). Numbers not indicated by an 'h' are decimal.

1. PIN INFORMATION

The CL-GD542X family of VGA controllers is available in a 160-pin quad flat pack device configuration, shown below.

1.1 Pin Diagram (ISA Bus)

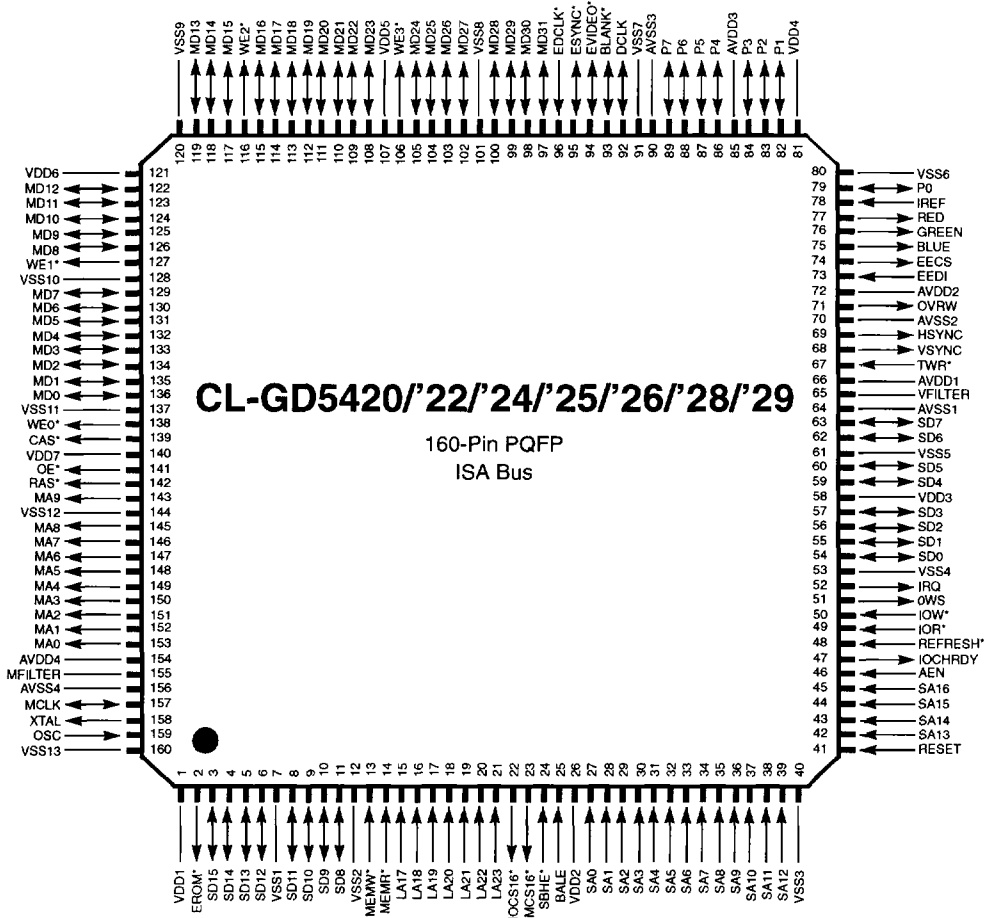

NOTE: WE1*, WE0*, MD[15:0], and OVRW are reserved on CL-GD5420.

1.2 Pin Diagram (MicroChannel® Bus)

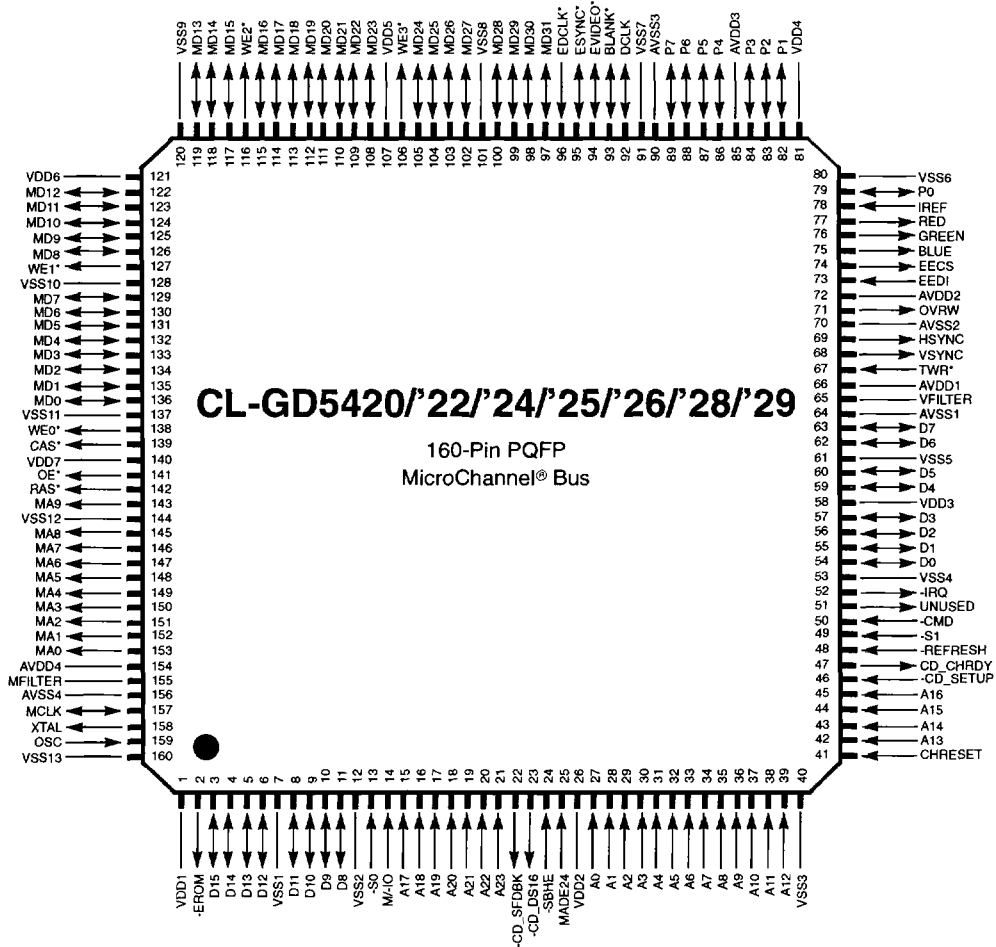

NOTES:

- 1) WE1*, WE0*, MD[15:0], and OVRW are reserved on CL-GD5420.
- 2) '-' indicates active-LOW on the MicroChannel bus.

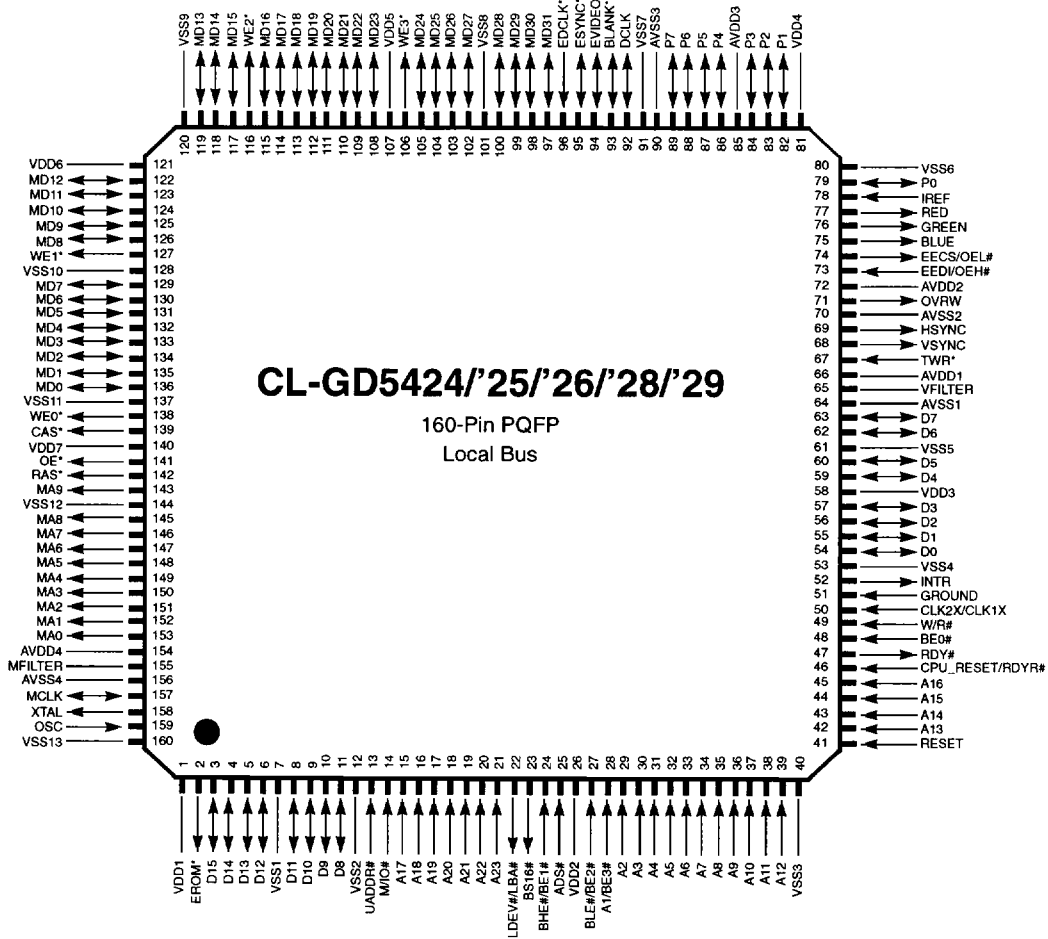
1.3 Pin Diagram (Local Bus)

1.4 Pin Summary

Table 1-1. Host Interface — ISA/MicroChannel®

| Pin Number | Pin Type | Pull-up ^a | I _{OH} ^b (mA) | I _{OL} (mA) | Load (pF) | ISA | MicroChannel® |
|------------|----------|----------------------|-----------------------------------|----------------------|-----------|-------|---------------|
| 21 | In | • | | | | LA23 | A23 |
| 20 | In | • | | | | LA22 | A22 |
| 19 | In | • | | | | LA21 | A21 |
| 18 | In | • | | | | LA20 | A20 |
| 17 | In | • | | | | LA19 | A19 |
| 16 | In | • | | | | LA18 | A18 |
| 15 | In | • | | | | LA17 | A17 |
| 45 | In | | | | | SA16 | A16 |
| 44 | In | | | | | SA15 | A15 |
| 43 | In | | | | | SA14 | A14 |
| 42 | In | | | | | SA13 | A13 |
| 39 | In | | | | | SA12 | A12 |
| 38 | In | | | | | SA11 | A11 |
| 37 | In | | | | | SA10 | A10 |
| 36 | In | | | | | SA9 | A9 |
| 35 | In | | | | | SA8 | A8 |
| 34 | In | | | | | SA7 | A7 |
| 33 | In | | | | | SA6 | A6 |
| 32 | In | | | | | SA5 | A5 |
| 31 | In | | | | | SA4 | A4 |
| 30 | In | | | | | SA3 | A3 |
| 29 | In | | | | | SA2 | A2 |
| 28 | In | | | | | SA1 | A1 |
| 27 | In | | | | | SA0 | A0 |
| 3 | I/O | • | -3 | 12 | 240 | SD15 | D15 |
| 4 | I/O | • | -3 | 12 | 240 | SD14 | D14 |
| 5 | I/O | • | -3 | 12 | 240 | SD13 | D13 |
| 6 | I/O | • | -3 | 12 | 240 | SD12 | D12 |
| 8 | I/O | • | -3 | 12 | 240 | SD11 | D11 |
| 9 | I/O | • | -3 | 12 | 240 | SD10 | D10 |
| 10 | I/O | • | -3 | 12 | 240 | SD9 | D9 |
| 11 | I/O | • | -3 | 12 | 240 | SD8 | D8 |
| 63 | I/O | | -3 | 12 | 240 | SD7 | D7 |
| 62 | I/O | | -3 | 12 | 240 | SD6 | D6 |
| 60 | I/O | | -3 | 12 | 240 | SD5 | D5 |
| 59 | I/O | | -3 | 12 | 240 | SD4 | D4 |
| 57 | I/O | | -3 | 12 | 240 | SD3 | D3 |
| 56 | I/O | | -3 | 12 | 240 | SD2 | D2 |
| 55 | I/O | | -3 | 12 | 240 | SD1 | D1 |
| 54 | I/O | | -3 | 12 | 240 | SD0 | D0 |
| 24 | In | • | | | | SBHE* | -SBHE |

Table 1-1. Host Interface — ISA/MicroChannel® (cont.)

| Pin Number | Pin Type | Pull-up ^a | I _{OH} ^b (mA) | I _{OL} (mA) | Load (pF) | ISA | MicroChannel® |
|------------|----------|----------------------|-----------------------------------|----------------------|-----------|----------|---------------|
| 25 | In | | | | | BALE | MADE24 |
| 46 | In | | | | | AEN | -CD_SETUP |
| 49 | In | | | | | IOR* | -S1 |
| 50 | In | | | | | IOW* | -CMD |
| 14 | In | | | | | MEMR* | M-/IO |
| 13 | In | | | | | MEMW* | -S0 |
| 41 | In | • | | | | RESET | CHRESET |
| 48 | In | | | | | REFRESH* | -REFRESH |
| 47 | Out | | -3 | 20 | 200 | IOCHRDY | CD_CHRDY |
| 22 | Out | | -3 | 20 | 200 | IOCS16* | -CD_SFDBK |
| 23 | Out | | -3 | 20 | 200 | MCS16* | -CD_DS16 |
| 51 | Out | | (OC) | 20 | 200 | OVS | (unused) |
| 52 | Out | | -3 | 20 | 200 | IRQ | -IRQ |

^a • indicates the presence of a 250 kΩ, ± 50 % pull-up resistor.

^b Data pads nominally rated at -3 mA I_{OH} will sink -15 mA at V_{OH} = 2.0 V.

Table 1-2. Host Interface — Local Bus (CL-GD5424/'25/'26/'28/'29 only)

| Pin Number | Pin Type | Pull-up ^a | I _{OH} ^b (mA) | I _{OL} (mA) | Load (pF) | '386SX | '386DX | '486 | VESA® VL-Bus™ |
|------------|----------|----------------------|-----------------------------------|----------------------|-----------|--------|--------|------|---------------|
| 21 | In | • | | | | A23 | A23 | A23 | A23 |
| 20 | In | • | | | | A22 | A22 | A22 | A22 |
| 19 | In | • | | | | A21 | A21 | A21 | A21 |
| 18 | In | • | | | | A20 | A20 | A20 | A20 |
| 17 | In | • | | | | A19 | A19 | A19 | A19 |
| 16 | In | • | | | | A18 | A18 | A18 | A18 |
| 15 | In | • | | | | A17 | A17 | A17 | A17 |
| 45 | In | | | | | A16 | A16 | A16 | A16 |
| 44 | In | | | | | A15 | A15 | A15 | A15 |
| 43 | In | | | | | A14 | A14 | A14 | A14 |
| 42 | In | | | | | A13 | A13 | A13 | A13 |
| 39 | In | | | | | A12 | A12 | A12 | A12 |
| 38 | In | | | | | A11 | A11 | A11 | A11 |
| 37 | In | | | | | A10 | A10 | A10 | A10 |
| 36 | In | | | | | A9 | A9 | A9 | A9 |
| 35 | In | | | | | A8 | A8 | A8 | A8 |
| 34 | In | | | | | A7 | A7 | A7 | A7 |
| 33 | In | | | | | A6 | A6 | A6 | A6 |
| 32 | In | | | | | A5 | A5 | A5 | A5 |
| 31 | In | | | | | A4 | A4 | A4 | A4 |
| 30 | In | | | | | A3 | A3 | A3 | A3 |

Table 1-2. Host Interface — Local Bus (CL-GD5424/'25/'26/'28/'29 only) (cont.)

| Pin Number | Pin Type | Pull-up ^a | I _{OH} ^b (mA) | I _{OL} (mA) | Load (pF) | '386SX | '386DX | '486 | VESA® VL-Bus™ |
|------------|----------|----------------------|-----------------------------------|----------------------|-----------|-----------|-----------|-----------|---------------|
| 29 | In | | | | | A2 | A2 | A2 | A2 |
| 28 | In | | | | | A1 | BE3# | BE3# | BE3# |
| 27 | In | | | | | BLE# | BE2# | BE2# | BE2# |
| 3 | I/O | • | -3 | 12 | 240 | D15 | D15 | D15 | D15 |
| 4 | I/O | • | -3 | 12 | 240 | D14 | D14 | D14 | D14 |
| 5 | I/O | • | -3 | 12 | 240 | D13 | D13 | D13 | D13 |
| 6 | I/O | • | -3 | 12 | 240 | D12 | D12 | D12 | D12 |
| 8 | I/O | • | -3 | 12 | 240 | D11 | D11 | D11 | D11 |
| 9 | I/O | • | -3 | 12 | 240 | D10 | D10 | D10 | D10 |
| 10 | I/O | • | -3 | 12 | 240 | D9 | D9 | D9 | D9 |
| 11 | I/O | • | -3 | 12 | 240 | D8 | D8 | D8 | D8 |
| 63 | I/O | | -3 | 12 | 240 | D7 | D7 | D7 | D7 |
| 62 | I/O | | -3 | 12 | 240 | D6 | D6 | D6 | D6 |
| 60 | I/O | | -3 | 12 | 240 | D5 | D5 | D5 | D5 |
| 59 | I/O | | -3 | 12 | 240 | D4 | D4 | D4 | D4 |
| 57 | I/O | | -3 | 12 | 240 | D3 | D3 | D3 | D3 |
| 56 | I/O | | -3 | 12 | 240 | D2 | D2 | D2 | D2 |
| 55 | I/O | | -3 | 12 | 240 | D1 | D1 | D1 | D1 |
| 54 | I/O | | -3 | 12 | 240 | D0 | D0 | D0 | D0 |
| 24 | In | • | | | | BHE# | BE1# | BE1# | BE1# |
| 25 | In | | | | | ADS# | ADS# | ADS# | LADS# |
| 46 | In | | | | | CPU-Reset | CPU-Reset | CPU-Reset | RDYRTN# |
| 49 | In | | | | | W/R# | W/R# | W/R# | W/R# |
| 50 | In | | | | | CLK2X | CLK2X | CLK1X | LCLK |
| 14 | In | | | | | M/IO# | M/IO# | M/IO# | M/IO# |
| 13 | In | | | | | (unused) | UADDR# | UADDR# | UADDR# |
| 41 | In | • | | | | RESET | RESET | RESET | RESET |
| 48 | In | | | | | (unused) | BE0# | BE0# | BE0# |
| 47 | Out | | -3 | 20 | 200 | READY# | READY# | RDY# | RDY# |
| 22 | Out | | -3 | 20 | 200 | LBA# | LBA# | LBA# | LDEV# |
| 23 | Out | | -3 | 20 | 200 | (unused) | BS16# | BS16# | LDS16# |
| 51 | In | | (OC) | 20 | 200 | GROUND | GROUND | GROUND | GROUND |
| 52 | Out | | -3 | 20 | 200 | INTR | INTR | INTR | INTR |

^a • indicates the presence of a 250 kΩ, ± 50 % pull-up resistor.

^b Data pads nominally rated at -3 mA I_{OH} will sink -15 mA at V_{OH} = 2.0 V.

Table 1-3. Synthesizer Interface

| Pin Number | Pin Type | Pull-up | I _{OH} (mA) | I _{OL} (mA) | Load (pF) | Name |
|------------|---------------------------------------|---------|----------------------|----------------------|-----------|---------|
| 159 | In | | | | | OSC |
| 158 | Analog Out/TTL In (CL-GD5425 only) | | | | | XTAL |
| 155 | Analog | | | | | MFILTER |
| 65 | Analog | | | | | VFILTER |
| 157 | I/O | | -12 | 12 | 20 | MCLK |

Table 1-4. Video Interface

| Pin Number | Pin Type | Pull-up ^a | I _{OH} (mA) | I _{OL} (mA) | Load (pF) | Name |
|------------|------------|----------------------|----------------------|----------------------|-----------|---------|
| 68 | I/O | | -12 | -12 | 50 | VSYNC |
| 69 | I/O | | -12 | -12 | 50 | HSYNC |
| 93 | I/O | | -12 | 12 | 50 | BLANK* |
| 89 | I/O | | -12 | 12 | 50 | P7 |
| 88 | I/O | | -12 | 12 | 50 | P6 |
| 87 | I/O | | -12 | 12 | 50 | P5 |
| 86 | I/O | | -12 | 12 | 50 | P4 |
| 84 | I/O | | -12 | 12 | 50 | P3 |
| 83 | I/O | | -12 | 12 | 50 | P2 |
| 82 | I/O | | -12 | 12 | 50 | P1 |
| 79 | I/O | | -12 | 12 | 50 | P0 |
| 92 | I/O | | -12 | 12 | 50 | DCLK |
| 95 | I/O | • | | | | ESYNC* |
| 94 | I/O | • | | | | EVIDEO* |
| 96 | In | • | | | | EDCLK* |
| 77 | Analog Out | | | | | RED |
| 76 | Analog Out | | | | | GREEN |
| 75 | Analog Out | | | | | BLUE |
| 78 | Analog In | | | | | IREF |

^a • indicates the presence of a 250 k Ω , \pm 50% pull-up resistor.

Table 1-5. Display Memory Interface

| Pin Number | Pin Type | Pull-up ^a | I _{OH} (mA) | I _{OL} (mA) | Load (pF) | Name |
|------------|----------|----------------------|----------------------|----------------------|-----------|-------------------|
| 142 | Out | | -8 | 12 | 50 | RAS* |
| 139 | Out | | -12 | 12 | 50 | CAS* ^b |
| 141 | Out | | -12 | 12 | 50 | OE* ^c |
| 106 | Out | | -12 | 12 | 50 | WE3* ^d |
| 116 | Out | | -12 | 12 | 50 | WE2* |
| 127 | Out | | -12 | 12 | 50 | WE1* ^e |
| 138 | Out | | -12 | 12 | 50 | WE0* ^e |
| 143 | Out | | -12 | 12 | 50 | MA9 |
| 145 | Out | | -12 | 12 | 50 | MA8 |
| 146 | Out | | -12 | 12 | 50 | MA7 |
| 147 | Out | | -12 | 12 | 50 | MA6 |
| 148 | Out | | -12 | 12 | 50 | MA5 |
| 149 | Out | | -12 | 12 | 50 | MA4 |
| 150 | Out | | -12 | 12 | 50 | MA3 |
| 151 | Out | | -12 | 12 | 50 | MA2 |
| 152 | Out | | -12 | 12 | 50 | MA1 |
| 153 | Out | | -12 | 12 | 50 | MA0 |
| 97 | I/O | • | -12 | 12 | 50 | MD31 |
| 98 | I/O | • | -12 | 12 | 50 | MD30 |
| 99 | I/O | • | -12 | 12 | 50 | MD29 |
| 100 | I/O | • | -12 | 12 | 50 | MD28 |
| 102 | I/O | • | -12 | 12 | 50 | MD27 |
| 103 | I/O | • | -12 | 12 | 50 | MD26 |
| 104 | I/O | • | -12 | 12 | 50 | MD25 |
| 105 | I/O | • | -12 | 12 | 50 | MD24 |
| 108 | I/O | • | -12 | 12 | 50 | MD23 |
| 109 | I/O | • | -12 | 12 | 50 | MD22 |
| 110 | I/O | • | -12 | 12 | 50 | MD21 |

Table 1-5. Display Memory Interface (cont.)

| Pin Number | Pin Type | Pull-up ^a | I _{OH} (mA) | I _{OL} (mA) | Load (pF) | Name |
|------------|----------|----------------------|----------------------|----------------------|-----------|-------------------|
| 111 | I/O | • | -12 | 12 | 50 | MD20 |
| 112 | I/O | • | -12 | 12 | 50 | MD19 |
| 113 | I/O | • | -12 | 12 | 50 | MD18 |
| 114 | I/O | • | -12 | 12 | 50 | MD17 |
| 115 | I/O | • | -12 | 12 | 50 | MD16 |
| 117 | I/O | • | -12 | 12 | 50 | MD15 ^e |
| 118 | I/O | • | -12 | 12 | 50 | MD14 ^e |
| 119 | I/O | • | -12 | 12 | 50 | MD13 ^e |
| 122 | I/O | • | -12 | 12 | 50 | MD12 ^e |
| 123 | I/O | • | -12 | 12 | 50 | MD11 ^e |
| 124 | I/O | • | -12 | 12 | 50 | MD10 ^e |
| 125 | I/O | • | -12 | 12 | 50 | MD9 ^e |
| 126 | I/O | • | -12 | 12 | 50 | MD8 ^e |
| 129 | I/O | • | -12 | 12 | 50 | MD7 ^e |
| 130 | I/O | • | -12 | 12 | 50 | MD6 ^e |
| 131 | I/O | • | -12 | 12 | 50 | MD5 ^e |
| 132 | I/O | • | -12 | 12 | 50 | MD4 ^e |
| 133 | I/O | • | -12 | 12 | 50 | MD3 ^e |
| 134 | I/O | • | -12 | 12 | 50 | MD2 ^e |
| 135 | I/O | • | -12 | 12 | 50 | MD1 ^e |
| 136 | I/O | • | -12 | 12 | 50 | MD0 ^e |

^a • indicates the presence of a 250 k Ω , \pm 50 % pull-up resistor.

^b CAS* is redefined as WE* for multiple-CAS* 256K \times 16 DRAMs for the CL-GD5422/24/25/26/28/29.

^c OE* is redefined as RAS1* for 2-Mbyte display memory configurations for the CL-GD5426/28/29 only.

^d WE*[3:0] are redefined as CAS*[3:0] for multiple-CAS* 256K \times 16 DRAMs for the CL-GD5422/24/25/26/28/29.

^e WE1*, WE0, MD[15:0] are reserved on the CL-GD5420.

Table 1-6. Miscellaneous Pins

| Pin Number | Pin Type | Pull-up ^a | I _{OH} (mA) | I _{OL} (mA) | Load (pF) | Name |
|------------|----------|----------------------|----------------------|----------------------|-----------|-------------------|
| 74 | Out | | -12 | 12 | 35 | EECS ^b |
| 73 | In | | | | | EEDI ^c |
| 2 | Out | | -12 | 12 | 35 | EROM* |
| 71 | Out | | -12 | 12 | 35 | OVRW ^d |
| 67 | In | | | | | TWR* |

^a • indicates the presence of a 250 k Ω , \pm 50 % pull-up resistor.

^b EECS is redefined as OEL# when the CL-GD5424/25/26/28/29 (only) is configured for '486, VESA VL-Bus, or local bus operation.

^c EEDI is redefined as OEH# when the CL-GD5424/25/26/28/29 (only) is configured for '486, VESA VL-Bus, or local bus operation.

^d OVRW is reserved on the CL-GD5420.

Table 1-7. Power and Ground

| Pin Number | Pin Type | Pull-up | I _{OH} | I _{OL} | Load (pF) | Name | Note |
|------------|----------|---------|-----------------|-----------------|-----------|-------|---------|
| 140 | Power | | | | | VDD7 | Digital |
| 121 | Power | | | | | VDD6 | Digital |
| 107 | Power | | | | | VDD5 | Digital |
| 81 | Power | | | | | VDD4 | Digital |
| 58 | Power | | | | | VDD3 | Digital |
| 26 | Power | | | | | VDD2 | Digital |
| 1 | Power | | | | | VDD1 | Digital |
| 160 | Ground | | | | | VSS13 | Digital |
| 144 | Ground | | | | | VSS12 | Digital |
| 137 | Ground | | | | | VSS11 | Digital |
| 128 | Ground | | | | | VSS10 | Digital |
| 120 | Ground | | | | | VSS9 | Digital |
| 101 | Ground | | | | | VSS8 | Digital |
| 91 | Ground | | | | | VSS7 | Digital |
| 80 | Ground | | | | | VSS6 | Digital |
| 61 | Ground | | | | | VSS5 | Digital |
| 53 | Ground | | | | | VSS4 | Digital |
| 40 | Ground | | | | | VSS3 | Digital |
| 12 | Ground | | | | | VSS2 | Digital |
| 7 | Ground | | | | | VSS1 | Digital |
| 66 | Power | | | | | AVDD1 | VCLK |
| 64 | Ground | | | | | AVSS1 | VCLK |
| 154 | Power | | | | | AVDD4 | MCLK |
| 156 | Ground | | | | | AVSS4 | MCLK |
| 85 | Power | | | | | AVDD3 | DAC |
| 72 | Power | | | | | AVDD2 | DAC |
| 90 | Ground | | | | | AVSS3 | DAC |
| 70 | Ground | | | | | AVSS2 | DAC |

2. DETAILED PIN DESCRIPTIONS

The following abbreviations are used for pin types in the following sections: (I) indicates input; (O) indicates output; (I/O) indicates a bidirectional signal; (TS) indicates three-state; (OC) indicates open collector.

2.1 Host Interface — ISA Bus Mode

| Name | Type | Description | | | | | | | | | | | | | | | |
|--|------|--|-------|----|----------|---|---|-----------------|---|---|---------------------|---|---|---------------------|---|---|--------------------------------------|
| LA[23:17] | I | ADDRESS [23:17]: These inputs, in conjunction with SA[16:0], are used to select the resource to be accessed during memory operations. These address bits are latched with the falling edge of BALE. | | | | | | | | | | | | | | | |
| SA[16:0] | I | ADDRESS [16:0]: These inputs, in conjunction with LA[23:17], are used to select the resource to be accessed during any memory or I/O operation. These address bits must remain valid throughout the cycle. | | | | | | | | | | | | | | | |
| SD[15:8] | TS | SYSTEM DATA [15:8]: These bidirectional pins are used to transfer data during 16-bit memory or I/O operations. These pins can be directly connected to the corresponding ISA bus pins. These pads have pull-up resistors to guarantee a valid input level when not connected. | | | | | | | | | | | | | | | |
| SD[7:0] | TS | SYSTEM DATA [7:0]: These bidirectional pins are used to transfer data during any memory or I/O operation. These pins can be directly connected to the corresponding ISA bus pins. | | | | | | | | | | | | | | | |
| SBHE* | I | SYSTEM BYTE HIGH ENABLE: This input is used in conjunction with A[0] to determine the width and alignment of a data transfer. SBHE* and A[0] are decoded as shown in Table 2-1: | | | | | | | | | | | | | | | |
| Table 2-1. SBHE/A0 Decoding | | | | | | | | | | | | | | | | | |
| <table border="1" style="width: 100%; border-collapse: collapse;"> <thead> <tr> <th>SBHE*</th> <th>A0</th> <th>Function</th> </tr> </thead> <tbody> <tr> <td style="text-align: center;">0</td> <td style="text-align: center;">0</td> <td>16-bit Transfer</td> </tr> <tr> <td style="text-align: center;">0</td> <td style="text-align: center;">1</td> <td>Upper-byte Transfer</td> </tr> <tr> <td style="text-align: center;">1</td> <td style="text-align: center;">0</td> <td>Lower-byte Transfer</td> </tr> <tr> <td style="text-align: center;">1</td> <td style="text-align: center;">1</td> <td>Lower-byte Transfer (on odd address)</td> </tr> </tbody> </table> | | | SBHE* | A0 | Function | 0 | 0 | 16-bit Transfer | 0 | 1 | Upper-byte Transfer | 1 | 0 | Lower-byte Transfer | 1 | 1 | Lower-byte Transfer (on odd address) |
| SBHE* | A0 | Function | | | | | | | | | | | | | | | |
| 0 | 0 | 16-bit Transfer | | | | | | | | | | | | | | | |
| 0 | 1 | Upper-byte Transfer | | | | | | | | | | | | | | | |
| 1 | 0 | Lower-byte Transfer | | | | | | | | | | | | | | | |
| 1 | 1 | Lower-byte Transfer (on odd address) | | | | | | | | | | | | | | | |
| BALE | I | BUS ADDRESS LATCH ENABLE: This active-high input is used to latch LA[23:17] on the high-to-low transition. | | | | | | | | | | | | | | | |
| AEN | I | ADDRESS ENABLE: If this input is high, it indicates that the current cycle is a DMA cycle. In this case, the CL-GD542X will not respond to I/O cycles. There is no effect on memory cycles. | | | | | | | | | | | | | | | |

2.1 Host Interface — ISA Bus Mode *(cont.)*

| Name | Type | Description |
|-----------------|-------------|---|
| IOR* | I | I/O READ: This active-low input is used to indicate that an I/O read is occurring. If the address on SA[15:0] is within the range of the CL-GD542X, it will respond by placing the contents of the appropriate register on the System Data bus. |
| IOW* | I | I/O WRITE: This active-low input is used to indicate that an I/O write is occurring. If the address on SA[15:0] is within the range of the CL-GD542X, it will respond by transferring the contents of the System Data bus into the appropriate register. The transfer will occur on the trailing (rising) edge of this signal. A list of I/O addresses that the CL-GD542X will respond appears in Section 5 on page 47. When a 16-bit I/O write is done, the address specified is typically the Index register for one of the VGA groups. The index should appear on SD[7:0] and the data should appear on SD[15:8]. |
| MEMR* | I | MEMORY READ: This active-low input is used to indicate that a memory read is occurring. If linear addressing is being used, this pin must be connected to ISA signal MEMR*. If linear addressing is not being used, this pin must be connected to ISA signal SMEMR*. The CL-GD542X decodes A[23:15] to determine if a display memory read is occurring. If so, data is placed on the System Data pins according to the read mode and the contents of display memory. The CL-GD542X decodes A[23:15] to determine if a BIOS read is occurring. If so, the CL-GD542X makes EROM* active for the duration of MEMR*. |
| MEMW* | I | MEMORY WRITE: This active-low input is used to indicate that a memory write is occurring. If linear addressing is being used, this pin must be connected to ISA signal MEMW*. If linear addressing is not being used, this pin must be connected to ISA signal SMEMW*. The CL-GD542X decodes A[23:15] to determine if a display memory write is occurring. If so, data is written into display memory according to the write mode and the data on SD[15:0]. The data are latched in the CL-GD542X on the rising edge of this signal, and are actually transferred to display memory later. |
| RESET | I | RESET: This active-high signal is used to initialize the CL-GD542X to a known state. The trailing (falling) edge of this input loads the Configuration register CF[14:0] with the data on MD[30:16], determined by internal pull-up resistors and (optional) external pull-down resistors. |
| REFRESH* | I | REFRESH*: This active-low signal indicates that a DRAM refresh is occurring. The CL-GD542X ignores memory read operations occurring when REFRESH* is active since it controls the refresh of display memory. |

2.1 Host Interface — ISA Bus Mode (cont.)

| Name | Type | Description |
|---------|------|---|
| IOCHRDY | TS | I/O CHANNEL READY: When driven low, this output indicates that additional wait states are to be inserted into the current display memory read or write cycle. This output is never driven low during I/O cycles or BIOS reads. During a display memory read cycle, this signal is always driven low as soon as MEMR* goes active. When the data are ready to be placed on the System Data bus, this signal is driven high. It remains high until MEMR* goes inactive; it then goes high impedance. During a display memory write cycle, this signal is driven high as soon as MEMW* goes active if there is space in the Write Buffer. If there is no space in the Write Buffer, this signal is driven low as soon as MEMW* goes active and remains low until there is space. Once there is space in the Write Buffer, this signal is driven high. It will remain high until MEMW* goes inactive; it then goes high-impedance. |

| | | |
|---------|----|--|
| IOCS16* | OC | I/O CHIP SELECT 16*: This open-collector output is driven low to indicate that the CL-GD542X can execute an I/O operation at the address currently on the bus in 16-bit mode. This signal is generated from a decode of A[15:0] and AEN. Table 2-2 indicates the range of addresses that the CL-GD542X will generate IOCS16*: |
|---------|----|--|

Table 2-2. IOCS16* Addresses

| Address | Function |
|------------------|-------------------------|
| 3C4, 3C5 | Sequencer |
| 3CE, 3CF | Graphics controller |
| 3B4/3D4, 3B5/3D5 | CRT controller |
| 3BA/3DA | Input Status register 1 |

| | | |
|--------|----|--|
| MCS16* | OC | MEMORY CHIP SELECT 16*: This open-collector output is driven low to indicate that the CL-GD542X can execute a memory operation at the address currently on the bus in 16-bit mode. Table 2-3 summarizes the conditions where MCS16* is made active. |
|--------|----|--|

Table 2-3. MSC16* Addresses

| Resource | Address Bits | Address Range | Qualifier |
|----------------|--------------|---------------|-----------------------------------|
| Display memory | A[23:17] | A000:0-BFFF:F | SR8[6] = 1 (No other VGA card) |
| Display memory | A[23:17] | 1 Mbyte | SR7[7:4] ≠ 0 Linear Addressing |
| BIOS | A[23:15] | C000:0-C7FF:F | CF[6] = 0 (16-bit BIOS) |

NOTE: The SA bits are generated late enough to typically make them unusable for generating MCS16*. The CL-GD542X uses a fast path from SA[16:15] to MCS16*.

2.1 Host Interface — ISA Bus Mode (cont.)

| Name | Type | Description |
|------|------|-------------|
|------|------|-------------|

| | | |
|------|----|--|
| 0WS* | OC | ZERO WAIT STATE* : This open-collector output is driven low to indicate that the current cycle can be completed without any additional wait states. The circumstances under which 0WS* will be made active are summarized in Table 2-4. |
|------|----|--|

Table 2-4. Zero Wait State* Cycles

| Cycle Type | Qualifier |
|----------------------|------------------------------|
| Display memory write | Write buffer not full |
| BIOS Read | CF[1] = 0 (not on CL-GD5429) |

| | | |
|-----|----|---|
| IRQ | TS | INTERRUPT REQUEST : This active-high output indicates the CL-GD542X has reached the end of an active field. Specifically, the transition occurs at the beginning of the bottom border. This pin is typically unused in PC/AT add-in cards, but can be connected to IRQ2/IRQ9 via a jumper block. See register CR11 for a description of the controls for this pin. |
|-----|----|---|

2.2 Host Interface — MicroChannel® Bus Mode

| Name | Type | Description | | | | | | | | | | | | | | | |
|---|------|---|----------------|----|----------|---|---|-----------------|---|---|---------------------|---|---|---------------------|---|---|---|
| A[23:0] | I | ADDRESS [23:0]: These inputs are used to select the resource to be accessed during a memory or I/O operation. These address bits are latched with the falling edge of -CMD . A[23:17] have internal pull-ups, whereas A[16:0] do not. | | | | | | | | | | | | | | | |
| D[15:0] | TS | DATA [15:0]: These bidirectional pins are used to transfer data during memory or I/O operation. These pins can be directly connected to the corresponding MicroChannel bus pins. | | | | | | | | | | | | | | | |
| -SBHE | I | $\text{-SYSTEM BYTE HIGH ENABLE}$: This input is used in conjunction with A[0] to determine the width and alignment of a data transfer. This signal is latched with -CMD low. This pad has a pull-up resistor. -SBHE and A[0] are decoded as shown in Table 2-5. Table 2-5. -SBHE/A0 Decoding | | | | | | | | | | | | | | | |
| <table border="1"> <thead> <tr> <th>-SBHE</th> <th>A0</th> <th>Function</th> </tr> </thead> <tbody> <tr> <td>0</td> <td>0</td> <td>16-bit Transfer</td> </tr> <tr> <td>0</td> <td>1</td> <td>Upper-byte Transfer</td> </tr> <tr> <td>1</td> <td>0</td> <td>Lower-byte Transfer</td> </tr> <tr> <td>1</td> <td>1</td> <td>Lower-byte Transfer (<i>on odd address</i>)</td> </tr> </tbody> </table> | | | -SBHE | A0 | Function | 0 | 0 | 16-bit Transfer | 0 | 1 | Upper-byte Transfer | 1 | 0 | Lower-byte Transfer | 1 | 1 | Lower-byte Transfer (<i>on odd address</i>) |
| -SBHE | A0 | Function | | | | | | | | | | | | | | | |
| 0 | 0 | 16-bit Transfer | | | | | | | | | | | | | | | |
| 0 | 1 | Upper-byte Transfer | | | | | | | | | | | | | | | |
| 1 | 0 | Lower-byte Transfer | | | | | | | | | | | | | | | |
| 1 | 1 | Lower-byte Transfer (<i>on odd address</i>) | | | | | | | | | | | | | | | |
| MADE24 | I | MEMORY ADDRESS ENABLE 24: This active-high input is latched the falling edge of -CMD . It indicates that the address is in the lower 16 Mbytes of address space. MADE24 must be high for the CL-GD542X to participate in a memory cycle. | | | | | | | | | | | | | | | |
| -CD_SETUP | I | -CARD SETUP: When this active-low input is active, the CL-GD542X is placed in Setup mode. In Setup mode, the CL-GD542X will respond only to POS102 accesses. It will not respond to any other I/O accesses or to display memory accesses. It will respond to BIOS reads. This signal is latched with the falling edge of -CMD . | | | | | | | | | | | | | | | |

2.2 Host Interface — MicroChannel® Bus Mode (cont.)

| Name | Type | Description |
|------|------|-------------|
|------|------|-------------|

| | | |
|-----|---|--|
| -S1 | I | -STATUS 1: This signal, in conjunction with -S0 and M/-IO, is used to determine the cycle type that occurs. The encoding is shown in Table 2-6: |
|-----|---|--|

Table 2-6. MicroChannel® Cycle Type Encoding

| M/-IO | -S0 | -S1 | Cycle |
|-------|-----|-----|--------------|
| 0 | 0 | 0 | Reserved |
| 0 | 0 | 1 | I/O write |
| 0 | 1 | 0 | I/O read |
| 0 | 1 | 1 | Reserved |
| 1 | 0 | 0 | Reserved |
| 1 | 0 | 1 | Memory write |
| 1 | 1 | 0 | Memory read |
| 1 | 1 | 1 | Reserved |

| | | |
|------|---|--|
| -CMD | I | -COMMAND: The falling edge of this input is used to latch the address bus, MADE24, -SBHE, -REFRESH, M/-IO, -CD_SETUP, -S0, and -S1. It is also used to time the actual data transfer. During I/O or memory-read cycles, the CL-GD542X drives valid data onto the bus prior to the trailing edge of this signal. During write cycles, the CL-GD542X expects valid data while this input is active and latches the data at the trailing edge. |
|------|---|--|

| | | |
|-------|---|--|
| M/-IO | I | MEMORY/-IO: This signal, in conjunction with -S0 and -S1, is decoded to determine the cycle type. See the description of -S1. |
|-------|---|--|

| | | |
|-----|---|---|
| -S0 | I | -STATUS 0: This signal, in conjunction with -S1 and M/-IO, is decoded to determine the cycle type. See the description of -S1. |
|-----|---|---|

| | | |
|-------|---|---|
| RESET | I | RESET: This active-high signal is used to initialize the CL-GD542X to a known state. The trailing (falling) edge of this input loads the Configuration register CF[14:0] with the data on MD[30:16], determined by internal pull-up resistors and (optional) external pull-down resistors. |
|-------|---|---|

| | | |
|----------|---|---|
| -REFRESH | I | -REFRESH: This active-low signal indicates that a DRAM refresh is occurring. This signal is latched with -CMD low. The CL-GD542X ignores memory-read operations occurring when -REFRESH is active since it controls the refresh of display memory. |
|----------|---|---|

2.2 Host Interface — MicroChannel® Bus Mode (cont.)

| Name | Type | Description | | | | | | | | | | | | | | | |
|--|-------------------|--|----------|--------------|---------------|----------------|-------------------|------------------------|----------------|-------------------|---------|---------------------------------|-------------------|------------------------|-----|------------------|---|
| CD_CHRDY | O | CARD CHANNEL READY: This output is driven low to request that additional wait states be inserted into the current display memory read or write cycle. This output is never driven low during I/O cycles or BIOS reads. During a display memory read cycle, this signal is always driven low as soon as -S1 goes low. When the data are ready to be placed on the System Data bus, this signal is driven high. During a display memory write cycle, this signal is driven high as soon as -S0 goes low if there is space in the Write Buffer. If there is no space in the Write Buffer, this signal is driven low as soon as -S0 goes low, and remains low until there is space. Once there is space in the Write Buffer, this signal is driven high. | | | | | | | | | | | | | | | |
| -CD_SFDBK | OC | $\text{-CARD SELECTED FEEDBACK}$: This open-collector output is driven low to indicate that the CL-GD542X can respond to the addresses currently on the bus. This signal is generated from a decode of -REFRESH , MADE24 , $\text{A}[23:0]$, and M/I-O . This signal is made active for the Address Range C000:0-C7FF:F only if $\text{CF}[6] = 0$ (indicating a 16-bit BIOS). If $\text{CF}[6] = 1$, this signal will not be made active for Address Range C000:0-C7FF:F . Also, this signal will not be made active for Addresses 102 or 103 if M/I-O is low, indicating I/O. | | | | | | | | | | | | | | | |
| -CD_DS16 | OC | -CARD SIZE 16: This open-collector output is driven low to indicate that the CL-GD542X can execute a memory or I/O operation at the address currently on the bus in 16-bit mode. This output is generated from a decode of $\text{A}[23:0]$, MADE24 , -REFRESH , and M/I-O . Table 2-7 summarizes the conditions under which -CD_DS16 is made active. | | | | | | | | | | | | | | | |
| <p>Table 2-7. -CD_DS16 Addresses</p> <table border="1"> <thead> <tr> <th>Resource</th> <th>Address Bits</th> <th>Address Range</th> </tr> </thead> <tbody> <tr> <td>Display memory</td> <td>$\text{A}[23:15]$</td> <td>A000:0-BFFF:F</td> </tr> <tr> <td>Display memory</td> <td>$\text{A}[23:15]$</td> <td>1 Mbyte</td> </tr> <tr> <td>BIOS ($\text{CF}[6] = 0$ only)</td> <td>$\text{A}[23:11]$</td> <td>C000:0-C7FF:F</td> </tr> <tr> <td>I/O</td> <td>$\text{A}[15:1]$</td> <td>3C4, 3C5 3CE, 3CF 3B/D4, 3B/D5 3B/DA</td> </tr> </tbody> </table> | | | Resource | Address Bits | Address Range | Display memory | $\text{A}[23:15]$ | A000:0-BFFF:F | Display memory | $\text{A}[23:15]$ | 1 Mbyte | BIOS ($\text{CF}[6] = 0$ only) | $\text{A}[23:11]$ | C000:0-C7FF:F | I/O | $\text{A}[15:1]$ | 3C4, 3C5 3CE, 3CF 3B/D4, 3B/D5 3B/DA |
| Resource | Address Bits | Address Range | | | | | | | | | | | | | | | |
| Display memory | $\text{A}[23:15]$ | A000:0-BFFF:F | | | | | | | | | | | | | | | |
| Display memory | $\text{A}[23:15]$ | 1 Mbyte | | | | | | | | | | | | | | | |
| BIOS ($\text{CF}[6] = 0$ only) | $\text{A}[23:11]$ | C000:0-C7FF:F | | | | | | | | | | | | | | | |
| I/O | $\text{A}[15:1]$ | 3C4, 3C5 3CE, 3CF 3B/D4, 3B/D5 3B/DA | | | | | | | | | | | | | | | |
| -IRQ | OC | $\text{-INTERRUPT REQUEST}$: This open-collector output indicates the CL-GD542X has reached the end of an active field. Specifically, the transition occurs at the beginning of the bottom border. This pin is typically connected to IRQ9 via a jumper block. See register CR11 for a description of the controls for this pin. This pin is never driven high. | | | | | | | | | | | | | | | |

2.3 Host Interface — Local Bus (CL-GD5424/25/26/28/29 only)

A number of bus interface pins are redefined according to the local bus type connecting to the CL-GD5424/25/26/28/29. The host interface pins are listed in Table 2-8 by CL-GD5424/25/26/28/29 pin number.

Table 2-8. Redefined Host Interface Pins

| Pin | '386SX | '386DX | '486 | VESA® VL-Bus™ |
|-----|-----------|-----------|--------|---------------|
| 13 | (unused) | UADDR# | UADDR# | UADDR# |
| 23 | (unused) | BS16# | BS16# | LBS16# |
| 24 | BHE# | BE1# | BE1# | BE1# |
| 27 | BLE# | BE2# | BE2# | BE2# |
| 28 | A1 | BE3# | BE3# | BE3# |
| 46 | CPU-RESET | CPU-RESET | GND | RDYRTN# |
| 47 | READY# | READY# | BRDY# | BRDY# |
| 48 | (unused) | BE0# | BE0# | BE0# |
| 50 | CLK2X | CLK2X | CLK1X | LCLK |
| 51 | GROUND | GROUND | GROUND | GROUND |
| 73 | (unused) | (unused) | OEH# | OEH# |
| 74 | (unused) | (unused) | OEL# | OEL# |

2.3 Host Interface — Local Bus (CL-GD5424/'25/'26/'28/'29 only) (cont.)

| Name | Type | Description |
|-----------|------|---|
| A[23:2] | I | ADDRESS [23:2]: These inputs are used to select the resource to be accessed during memory or I/O operations. A[23:17] have internal pull-up resistors; A[16:2] do not. A[3:2] are burst address bits for the '486. |
| D[15:0] | TS | DATA [15:0]: These bidirectional pins are used to transfer data during any memory or I/O operation. These pins are directly connected to D[15:0] of the '386SX or '386DX bus. These pins are connected via four bidirectional data transceivers to the 32 data pins of the '486 or VESA VL-Bus. The transceivers are controlled with OE#, OEL#, and W/R#. These pads have pull-up resistors. |
| BE[3:0]# | I | BYTE ENABLE [3:0]#: These active-low inputs are directly connected to the '386DX/'486 or VESA VL-Bus byte enable outputs. In the case of the '386SX, BE0# is unused and can be left unconnected. BE1#, 2, and 3 are redefined as BHE#, BLE#, and A1, respectively. They must be directly connected to the corresponding '386 outputs. |
| ADS# | I | ADDRESS STROBE: This active-low input indicates that a new cycle has begun. It must be directly connected to the ADS# pin on the CPU. For VESA VL-Bus, this pin is connected to LADS#. |
| CPU-RESET | I | CPU RESET: When this active-high input is active, the CL-GD542X is forced into an initial condition. It is used to synchronize the CL-GD542X to CLK1X or CLK2X. This pin <i>must</i> be connected to the RESET pin of the CPU in a '386 system; it <i>must</i> be connected to ground in a '486 system; it <i>must</i> be connected to RDYRTN# in a VESA VL-Bus system. |
| W/R# | I | WRITE/READ: This input indicates whether a write or read operation is to occur. It must be directly connected to the W/R# pin on the CPU. If W/R# is high, a write will occur. If it is low, a read will occur. |
| CLK2X | I | CLOCK 2X: This is the timing reference for the CL-GD542X when connected to a '386SX or '386DX local bus. This is redefined as CLK1X for the '486 local bus. In either case, it must be directly connected to the corresponding CPU pin. For VESA VL-Bus, this pin is connected to LCLK. |
| M/IO# | I | MEMORY/IO#: This input indicates whether a memory or I/O operation is to occur. It must be directly connected to the M/IO# pin on the CPU. If M/IO# is high, a memory operation will occur. If it is low, an I/O operation will occur. |
| UADDR# | I | UPPER ADDRESS: This active-low input is a decode of the upper-CPU Address bits A[32:24]. This input is unused in the case of a '386SX local bus and can be left unconnected. Refer to appendixes in the <i>CL-GD542X Technical Reference Manual</i> for information on the generation of this signal. |

2.3 Host Interface — Local Bus (CL-GD5424/25/26/28/29 only) (cont.)

| Name | Type | Description |
|-------|------|---|
| RESET | I | RESET: This active-high input initializes the CL-GD542X to a known state. The trailing (falling) edge of this input loads the Configuration register CF[14:0] with the data on MD[30:16], determined by internal pull-up resistors and (optional) external pull-down resistors. |
| RDY# | TS | RDY #: This active-low signal is used as an output to terminate a CL-GD542X bus cycle. |
| LBA# | TS | LOCAL BUS ACKNOWLEDGE #: This open-collector output is driven low to indicate that the CL-GD542X will respond to the current cycle. This signal is generated from a decode of A[23:2], UADDR#, and M/IO#. This output will be active before the middle of the first T2 after an active ADS#. For VESA VL-Bus, this pin is connected to LDEV#. |
| BS16# | OC | BUS SIZE 16 #: This active-low output is driven by the CL-GD542X to indicate that the current cycle addresses a 16-bit resource. The '386DX/'486 will convert the cycle to an appropriate number of 16-bit transfers. This pin is not used for a '386SX local bus and can be left unconnected. For VESA VL-Bus, this pin is connected to LBS16#. |
| INTR | TS | INTERRUPT REQUEST: This active-high output indicates the CL-GD542X has reached the end of an active field. Specifically, the transition occurs at the beginning of the bottom border. See register CR11 for a description of the controls for this pin. |
| OEH# | O | OUTPUT ENABLE HIGH#: This active-low output controls the output enables for the data transceivers that connect the CL-GD542X SD[15:0] pins to the '486 or VESA VL-Bus D[31:16] pins. |
| OEL# | O | OUTPUT ENABLE LOW#: This active-low output controls the output enables for the data transceivers that connect the CL-GD542X SD[15:0] pins to the '486 or VESA VL-Bus D[15:0] pins. |

2.4 Dual-Frequency Synthesizer Interface

| Name | Type | Description |
|---------|------|---|
| OSC | I | <p>OSCILLATOR INPUT: This TTL input pin supplies the reference frequency for the dual-frequency synthesizer. It requires an input frequency of $14.31818 \pm 0.01\%$ MHz with a duty cycle of $50 \pm 10\%$. This input can be supplied from the appropriate pin on the ISA or MicroChannel bus, from an oscillator, or with a series-resonant crystal connected between this pin and the XTAL pin.</p> <p>NOTE: When the CL-GD5425 (only) is configured for PAL/NTSC operation (pull-down installed on MD16), this pin should be driven with 17.734475 MHz. This is the reference frequency for PAL.</p> |
| XTAL | I/O | <p>CRYSTAL: This output pin allows the use of a crystal to supply the reference frequency for the synthesizer. A series-resonant crystal can be connected between this pin and the OSC pin. If this pin is not used for a crystal connection, it <i>must</i> be left unconnected (except for CL-GD5425).</p> <p>When the CL-GD5425 (only) is configured for PAL/NTSC operation (pull-down installed on MD16), this is an input pin and should be driven with 14.31818 MHz. This is the reference frequency for NTSC, the MCLK synthesizer, and VGA modes.</p> |
| MFILTER | O | <p>MEMORY CLOCK FILTER: This pin must be connected to a π RC filter returned to AVSS4. The values of the two capacitors and the resistor are shown in Appendix B17 in the <i>CL-GD542X Technical Reference Manual</i>. The filter components, especially the input capacitor and the resistor, must be placed as closely as possible to this pin.</p> |
| VFILTER | O | <p>VIDEO CLOCK FILTER: This pin <i>must</i> be connected to a π RC filter returned to AVSS1 or AVDD1, depending on processing. The values of the two capacitors and the resistor are shown in Appendix B17 in the <i>CL-GD542X Technical Reference Manual</i>. The filter components, especially the input capacitor and the resistor, <i>must</i> be placed as closely as possible to this pin.</p> |
| MCLK | I/O | <p>MEMORY CLOCK: This pin is normally an output and can be used to monitor the internal MCLK. Typically, it would not be connected. If CF[4] is a zero, MCLK will be an input and the internal MCLK oscillator will be disabled. This configuration is intended for testing only.</p> <p>NOTE: For the CL-GD5425 and CL-GD5429 only, this pin can be configured to output the internal VCLK VCO. If a pull-down is installed on MD31 (and no pull-down on MD20), the internal VCLK VCO (prior to the post-scalar) will be driven onto this pin.</p> |

2.5 Video Interface

| Name | Type | Description |
|---------|------|--|
| VSYNC | I/O | <p>VERTICAL SYNC: This output supplies the vertical synchronization pulse to the monitor. The polarity of this output is programmable. This pin is put into high impedance when ESYNC* is low. This pin can be directly connected to the corresponding pin on the feature connector.</p> <p>NOTE: When the CL-GD5425 (only) is configured for VSYNC GENLOCK, by programming CR1C[7] to '1', VSYNC becomes an input.</p> |
| HSYNC | I/O | <p>HORIZONTAL SYNC: This output supplies the horizontal synchronization pulse to the monitor. The polarity of this output is programmable. This pin is put into high impedance when ESYNC* is low. This pin can be directly connected to the corresponding pin on the feature connector.</p> <p>NOTE: When the CL-GD5425 (only) is configured for HSYNC GENLOCK, by programming CR1C[6] to '1', HSYNC becomes an input.</p> |
| BLANK* | I/O | <p>BLANK*: This is a bidirectional pin. If ESYNC* is high, BLANK* is an output. As an output, it supplies a blanking signal to the feature connector. If ESYNC* is low, BLANK* is an input. As an active-low input, it forces the RED, GREEN, and BLUE outputs to zero current. This pin can be directly connected to the corresponding pin on the feature connector.</p> <p>NOTE: When the CL-GD5425 (only) is configured for TV mode by programming CR30[3] to '1', this pin becomes the Color Carrier Reference (Nx fsc).</p> |
| P[7:0] | I/O | <p>PIXEL BUS [7:0]: These are bidirectional pins. If EVIDEO* is high, these pins are outputs and reflect the address into the palette DAC. If EVIDEO* is low, these pins are inputs and can be used to drive pixel values into the palette DAC. These pins can be directly connected to the corresponding pins on the feature connector.</p> |
| DCLK | I/O | <p>VIDEO DOT CLOCK: This is a bidirectional pin. If EDCLK* is high, this is an output and can be used to externally latch the data on the Pixel Bus. If EDCLK* is low, this is an input and can be used to clock data on the Pixel bus into the CL-GD542X. This pin can be directly connected to the corresponding pin on the feature connector.</p> |
| ESYNC* | I/O | <p>ENABLE SYNC AND BLANK: This input is used to control the buffers on HSYNC, VSYNC, and BLANK*. If ESYNC* is high, the controlled pins are outputs. If ESYNC* is low, BLANK* is an input. HSYNC and VSYNC are not driven by the CL-GD542X and must be driven externally to valid input levels. This pin can be directly connected to the corresponding pin on the feature connector.</p> <p>NOTE: For the CL-GD5425, the ESYNC* pin will be an output and will reflect SR8[2] whenever Overlay mode is selected by programming CR1A[3:2] to any value other than '0,0' or whenever TV mode is selected by programming CR30[3] to '1'.</p> |
| EVIDEO* | I/O | <p>ENABLE VIDEO: This input controls the buffers on P[7:0]. If EVIDEO* is high, P[7:0] are outputs; if EVIDEO* is low, P[7:0] are inputs. This pin can be directly connected to the corresponding pin on the feature connector. This pin is not limited to static operation; it can switch at the DCLK rate.</p> |

2.5 Video Interface (cont.)

| Name | Type | Description |
|--------|------|---|
| EDCLK* | I | ENABLE DOT CLOCK: This input is used to control the buffer on DCLK. If EDCLK* is high, DCLK is an output; if EDCLK* is low, DCLK is an input. This pin can be directly connected to the corresponding pin on the feature connector. |
| RED | O | <p>RED VIDEO: This analog output supplies current corresponding to the red value of the pixel being displayed. Each of the three DACs consists of 255 summed current sources. For each pixel, either the 6-bit value from the LUT or a 5-, 6-, or 8-bit true-color value is applied to each DAC input to determine the number of current sources to be summed. Full-scale current on the RED, GREEN, and BLUE outputs is related to IREF as follows:</p> $I_f = (63/30) \times IREF$ <p>To maintain IBM VGA compatibility, each DAC output is typically terminated to monitor ground with a 75-Ω 2-percent resistor. This resistor, in parallel with the 75-Ω resistor in the monitor, will yield a 37.5-Ω impedance to ground. For a full-scale voltage of 700 mV, full-scale current output should be 18.7 mA.</p> |
| GREEN | O | GREEN VIDEO: This analog output supplies current corresponding to the green value of the pixel being displayed. See the description of RED for information regarding the termination of this pin. |
| BLUE | O | BLUE VIDEO: This analog output supplies current corresponding to the blue value of the pixel being displayed. See the description of RED for information regarding the termination of this pin. |
| IREF | I | DAC CURRENT REFERENCE: The current drawn from AV _{DD} through this pin determines the full-scale output of each DAC. Connect this pin to a constant current source. A recommended circuit is provided in appendixes of the <i>CL-GD542X Technical Reference Manual</i> . |

2.6 Display Memory Interface

| Name | Type | Description |
|----------|------|---|
| RAS* | O | <p>ROW ADDRESS STROBE *: This active-low output is used to latch the row address from MA[9:0] into the DRAMs. This pin must be connected to the RAS* pins of all the DRAMs in the display memory array. These pads, and those for the other DRAM controls, are matched for one-to-four loads. If eight DRAMs are used, damping resistors may be required to control edge rates and undershoot on these, and other, control pins.</p> |
| CAS* | O | <p>COLUMN ADDRESS STROBE *: This active-low output is used to latch the Column Address from MA[9:0] into the DRAMs. This pin must be connected to the CAS* pins of all the DRAMs in the display memory array.</p> <p>NOTE: If CF[12] = 0 (dual-CAS* DRAMs), this pin becomes WE*.</p> |
| OE* | O | <p>OUTPUT ENABLE *: This active-low output is used to control the output enables of the DRAMs. For 256K × 4 DRAMs and 256K × 16 DRAMs with Dual-write Enables, this pin <i>must</i> be connected to the OE* pins of all the DRAMs in the display memory array. For 256K × 16 DRAMs with dual-CAS*, this pin is a no-connect. For the CL-GD5426/28/29 with 2 Mbytes of display memory, this pin becomes RAS1*. See the DRAM configuration tables in Section 4 on page 41.</p> <p>NOTE: For the CL-GD5425 (only), this pin is ODD/EVEN when the chip is configured for TV-out and indicates which field is being displayed.</p> |
| WE[3:0]* | O | <p>WRITE ENABLE [3:0]*: These active-low outputs are used to control the write enable inputs of the DRAMs. These pins <i>must</i> be connected to the WE* pins of the DRAMs as indicated in the DRAM configuration tables in Section 4 on page 41.</p> <p>NOTE: If CF[12] = 0 (dual-CAS* DRAMs) these pins become CAS[3:0]*. These pins can be connected to the CAS* pins of the DRAMs. WE[1:0]* are reserved on the CL-GD5420 (Revision 'A').</p> |
| MA[9] | O | <p>MEMORY ADDRESS [9]: This pin controls one address input of the DRAMs. See the DRAM configuration tables in Section 4 on page 41.</p> <p>When the CL-GD5425 (only) is configured for TV mode, by programming CR30[3] to '1', this pin becomes CSYNC out. CSYNC includes all horizontal and vertical timing and serration pulses.</p> |
| MA[8:0] | O | <p>MEMORY ADDRESS [8:0]: These pins control the address inputs of the DRAMs. These pins must be connected to the address pins of the DRAMs. See the DRAM configuration tables in Section 4 on page 41.</p> |
| MD[31:0] | TS | <p>MEMORY DATA [31:0]: These pins are used to transfer data between the CL-GD542X and the display memory. These pins must be connected to the data pins of the DRAMs. See the DRAM configuration tables in Section 4 on page 41. These pins are forced into high impedance when RESET is active. This allows the configuration pull-down resistors to override the weak pull-ups and be loaded into the Configuration register CF. MD[15:0] are reserved on the CL-GD5420 (Revision 'A').</p> |

2.7 Miscellaneous Pins

| Name | Type | Description |
|-------|------|---|
| EECS | O | <p>EEPROM CHIP SELECT: This pin is used to control the Chip Select of the optional configuration EEPROM, and should be directly connected to that pin (ISA and Micro-channel only).</p> <p>NOTE: This pin is redefined as OEL* for the '486 or VESA VL-Bus (CL-GD5424/'26/'28/'29 only).</p> |
| EEDI | I | <p>EEPROM DATA IN: This pin is used to read the data from the optional configuration EEPROM, and should be directly connected to the Data Out pin (ISA and Micro-channel only).</p> <p>NOTE: This pin is redefined as OEH* for the '486 or VESA VL-Bus (CL-GD5424/'26/'28/'29 only).</p> |
| EROM* | O | <p>ENABLE ROM BUFFERS*: This active-low output is used to control the Output Enable pins of up to two 8-bit bus drivers. These buffers are used to connect the data pins of the BIOS EPROMs to the System Data bus. This output is forced high when RESET is active. This output goes active only for memory read cycles to the address range C000:0–C7FF:F. It is gated with MEMR* in ISA mode, and with –CMD in MicroChannel mode. It is un-latched address decode in Local Bus modes.</p> |
| OVRW | O | <p>OVERLAY WINDOW: This output signal is active-high. It is intended to be used in applications involving video overlays. For additional connectivity information, see Appendix B14 in the CL-GD542X technical reference manual. OVRW is reserved on the CL-GD5420.</p> |
| TWR* | I | <p>TEST LATCH LOAD ENABLE*: This pin is intended for factory testing and must be pulled-up for normal operation. It can be used in board-level testing to disable most of the CL-GD542X output pins. For additional information, see Appendix B14 in the <i>True Color VGA Family — CL-GD542X Technical Reference Manual</i>.</p> |

2.8 Power Pins

| Name | Type | Description |
|-----------|--------|---|
| VDD[7:1] | Power | PLUS FIVE (LOGIC): These seven pins are used to supply +5 volts to the core logic of the CL-GD542X. Each pin <i>must</i> be connected to the VCC rail as described in Appendixes B1–B3 of the <i>True Color VGA Family — CL-GD542X Technical Reference Manual</i> . Each pin <i>must</i> be bypassed with a 0.1- μ F capacitor with proper high-frequency characteristics, placed as closely to the pin as possible. If a multi-layer board is used, each VDD pin <i>must</i> be connected to the power plane as outlined in Appendixes B1–B3 in the <i>True Color VGA Family — CL-GD542X Technical Reference Manual</i> . |
| VSS[13:1] | Ground | GROUND (LOGIC): These 13 pins are used to supply ground reference to the core logic of the CL-GD542X. Each pin <i>must</i> be directly connected to the GND rail. If a multi-layer board is used, each VSS pin <i>must</i> be connected to the ground plane. |
| AVDD[1] | Power | PLUS FIVE (VCLK): This pin is used to supply +5 volts to the video clock synthesizer of the CL-GD542X. This pin must be connected to the VCC rail via a 33- Ω resistor, and bypassed to AVSS4 with a 10- μ F capacitor. |
| AVSS[1] | Ground | GROUND (VCLK): This pin is used to supply ground reference to the video clock synthesizer of the CL-GD542X. This pin <i>must</i> be connected to the GND rail. |
| AVDD[4] | Power | PLUS FIVE (MCLK): This pin is used to supply +5 volts to the memory clock synthesizer of the CL-GD542X. This pin must be connected to the VCC rail through a 33- Ω resistor and bypassed to AVSS4 with a 10- μ F capacitor. |
| AVSS[4] | Ground | GROUND (MCLK): This pin is used to supply ground reference to the video clock synthesizer of the CL-GD542X. This pin <i>must</i> be connected to the GND rail. |
| AVDD[3:2] | Power | PLUS FIVE (DAC): These two pins are used to supply +5 volts to the palette DAC of the CL-GD542X. Each pin must be directly connected to the VCC rail. Each pin must be bypassed, as closely to the pin as possible, with a 0.1- μ F capacitor with proper high-frequency characteristics. If a multi-layer board is used, each VDD pin <i>must</i> be connected to the power plane. |
| AVSS[3:2] | Ground | GROUND (DAC): These two pins are used to supply the ground reference to the palette DAC of the CL-GD542X. Each pin must be connected to the GND rail. For various adapter board and motherboard solutions, see the appendixes in the <i>True Color VGA Family — CL-GD542X Technical Reference Manual</i> . |

3. FUNCTIONAL DESCRIPTION

3.1 General

The CL-GD542X family of VGA controllers offers a complete VGA-standards-compatible solution. All of the hardware necessary for CPU updates to memory, screen refresh, and DRAM refresh is included in the CL-GD542X. A complete VGA motherboard solution can be implemented with one 256K × 16 DRAM with any CL-GD542X chip.

The chip block diagram in Figure 3-1 shows the CL-GD542X connection to the host, display memory, and monitor. Each member of the CL-GD542X family of VGA controllers is pin-to-pin compatible on the system bus.

3.2 Functional Blocks

The following functional blocks have been integrated into the CL-GD542X.

CPU Interface

The CL-GD542X connects directly to the ISA bus, E-ISA bus, MicroChannel bus, or '386 and '486 bus (CL-GD5424/'26/'28/'29 only). No glue logic is required. The CL-GD542X internally decodes a 16- or 24-bit address, and responds to the applicable control lines. It executes both I/O accesses and memory accesses as either an 8- or 16-bit device.

CPU Write Buffer

The CPU Write Buffer contains a queue of CPU write accesses to display memory that have not been executed because of memory arbitration. Maintaining a queue allows the CL-GD542X to release the CPU as soon as it has recorded the address and data, and to execute the operation when display memory is available, increasing CPU performance.

Graphics Controller

The Graphics Controller is located between the CPU interface and the Memory Sequencer. It performs text manipulation, data rotation, color mapping, and other miscellaneous operations.

BitBLT

This is a unique GUI acceleration feature in the CL-GD5426/'28/'29. The BitBLT function moves data with ROPs (raster operations). This operation occurs in Packed-pixel modes with 8-, 16-, or 24-bit-per-pixel transfers. Color expansion can be used to translate monochrome images to 8- or 16-bit color. The source or destination of a BitBLT operation can be system memory.

Memory Arbitrator

The Memory Arbitrator allocates bandwidth to the four functions that compete for the limited bandwidth of display memory. These are CPU access, screen refresh, DRAM refresh, and BitBLT operations. DRAM refresh is handled invisibly by allocating a selectable number of CAS*-before-RAS* refresh cycles at the beginning of each scanline. Screen refresh and CPU/BitBLT accesses are allocated cycles according to the FIFO-control parameters, with priority given to screen refreshes.

Memory Sequencer

The Memory Sequencer generates timing for display memory. This includes RAS*, CAS* and multiplexed-address timing, as well as WE* and OE* timing. The Sequencer generates CAS*-before-RAS* refresh cycles, Random Read and Random Early Write cycles, and Fast-page mode Read and Early Write cycles. The Memory Sequencer generates multiple-CAS* or multiple-WE* signals according to the memory type used.

CRT Controller

The CRT controller generates the HSYNC and VSYNC Signals required for the monitor, as well as the BLANK* signals required by the palette DAC.

Video FIFO

The Video FIFO allows the Memory Sequencer to execute the display memory accesses needed for screen refresh at maximum memory speed rather than at the screen refresh rate. This makes it possible to collect the accesses for screen refresh near the beginning of the scanline, and to execute them in Fast-page mode rather than Random Read mode.

Attribute Controller

The Attribute Controller formats the display for the screen. Display color selection, text blinking and underlining are performed by the Attribute Controller. Alternate font selection also occurs in the Attribute Controller.

Palette DAC

The palette DAC block contains the color palette and three 8-bit digital-to-analog converters. The color palette, with 256 18-bit entries, converts a color code that specifies the color of a pixel into three 6-bit values, one each for red, green, and blue. The CL-GD5425 (only) supports YCrCb and AccuPak-to-RGB conversion.

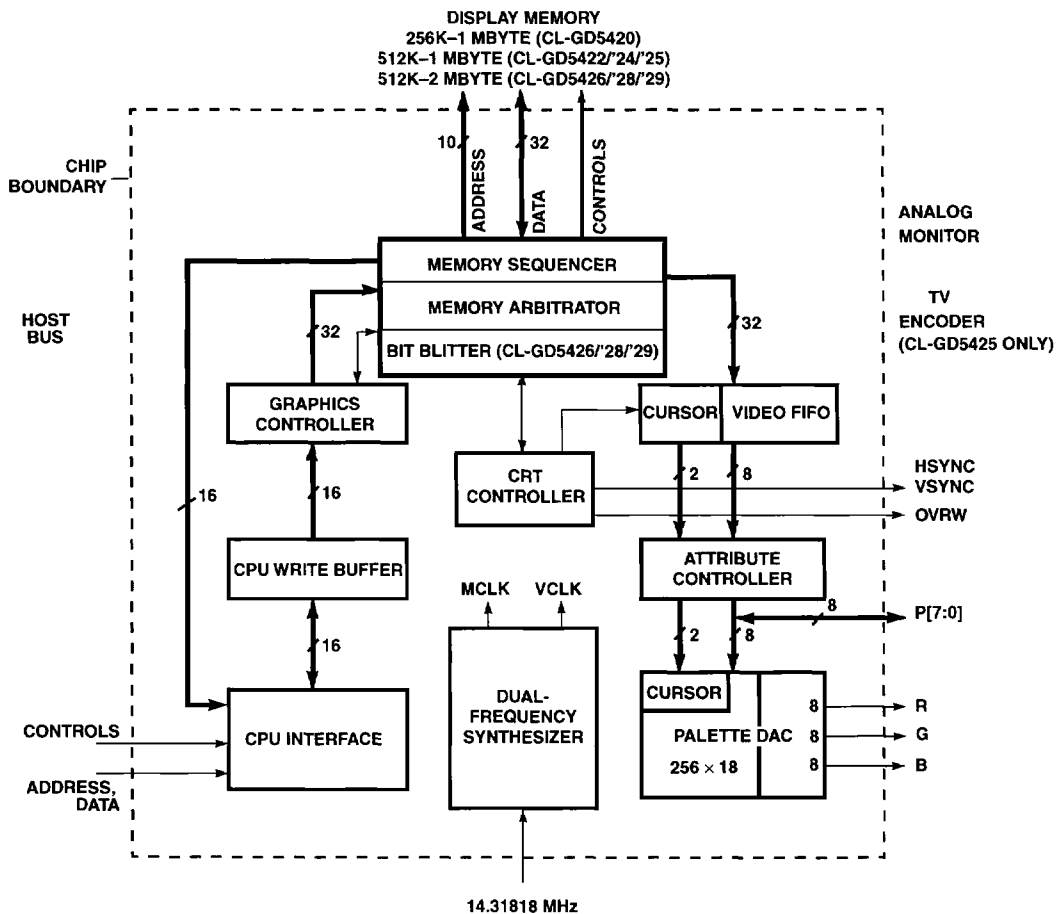

Figure 3-1. CL-GD542X Chip Block Diagram

Alternatively, the CL-GD542X (excluding the CL-GD5420) can be configured for 15-, 16-, or 24-bit pixels. This allows 32K, 65K, or 16 million simultaneous colors to be displayed on the screen. The bits are allocated as 8-8-8 for the 16 million colors, 5-6-5 for the 64K Color mode, or five to each (red, green, and blue) DAC for the 32K Color mode.

Dual-Frequency Synthesizer

The dual-frequency synthesizer generates the Memory Sequencer Clock and the Video Display Clock from a single reference frequency. The frequency of each clock is programmable. The reference frequency can be generated with an internal crystal-controlled oscillator. Alternatively, it can be supplied from an external TTL source.

VESA® Connector/VGA Pass-through Connector

The CL-GD542X is designed to connect directly to a VESA connector. It supports the three enable/disable inputs, and the Pixel bus can directly drive the connector. Through this connector, the overlay feature could be used in multimedia applications. This allows for internal DAC utilization in 16-bit-per-pixel mode. The CL-GD5425/29 supports the VAFC (VESA Advanced Feature Connector) Baseline for Video Overlay.

TV Encoder (CL-GD5425 only)

The CL-GD5425 provides integrated scaling, flicker reduction, and a glueless encoder interface that delivers high-quality TV display at the lowest possible cost without the need for additional frame or line stores.

The programmable flicker-reduction function reduces interlaced artifacts inherent in computer-generated images displayed on interlaced TV monitors. The degree of filtering is selectable by the end-user.

3.3 Functional Operation

The four major operations handled by the CL-GD542X are discussed below.

CPU Access to Registers

The host can be any processor controlling an ISA, E-ISA, MicroChannel, or '386 and '486 local bus. It accesses CL-GD542X registers by setting up 16- or 24-bit addresses and making controls such as IORD* or IOWR* active. The CL-GD542X can respond either as an 8- or 16-bit peripheral, depending on how the chip has been designed into the system.

DRAM and screen refresh occur concurrently with, and independently of, register access (unless the host is changing display parameters or has suppressed refresh). Registers are described in detail in the *True Color VGA Family — CL-GD542X Technical Reference Manual*.

CPU Access to Display Memory

All host accesses to display memory are handled by the CL-GD542X. The host first sets up certain parameters, such as color and write masks, then generates a memory access in the range where the CL-GD542X is programmed to respond.

Display Memory Refresh

The CL-GD542X automatically generates a selectable number of CAS*-before-RAS* refresh cycles during each horizontal timing period.

Screen Refresh

The CRT monitor requires a near-constant rewriting since its only memory is the phosphor persistence. This persistence is typically only a few milliseconds. The CL-GD542X fetches information from the display memory for each scanline as quickly as possible, using Fast-page mode cycles to fill the Video FIFO. This allows the maximum possible time for the host to access the display memory.

3.4 Performance

The CL-GD542X is designed with the following performance-enhancing features:

- Accelerated Microsoft Windows with BitBLT (CL-GD5426/'28/'29 only)
- 16-bit CPU interface to I/O registers for faster host access
- 16-bit CPU interface to display memory for faster host access in all modes, including Planar mode
- 32-bit display memory data bus for faster access to display memory (CL-GD5422/'24/'25/'26/'28/'29)
- DRAM Fast-page mode operations for faster access to display memory
- Zero-wait-state performance and a CPU write buffer allows faster CPU access for writes to display memory
- Video FIFO to minimize memory contention
- 32 × 32 and 64 × 64 hardware cursor to improve Microsoft Windows performance
- Increased throughput with '386 and '486 local bus interface (CL-GD5424/'25/'26/'28/'29)

3.5 Compatibility

The CL-GD542X includes all registers and data paths required for VGA controllers.

The CL-GD542X supports extensions to VGA, including 1024 × 768 × 256 interlaced and non-interlaced, and 1280 × 1024 × 256 interlaced modes. Additionally, various 132-column text modes are supported.

3.6 Board Testability

The CL-GD542X chip is testable, even when installed on a PC board. By using pin scan testing, any IC signal pins not connected to the board or shorted to a neighboring pin or trace, will be detected. The Signature Generator allows the entire system, including the display memory, to be tested at speed. For further information on pin scan testing and the Signal Generator, refer to Appendixes B11 and B13 in the *True Color VGA Family — CL-GD542X Technical Reference Manual*.

4. CL-GD542X CONFIGURATION TABLES

4.1 Video Modes

Table 4-1. Standard VGA Modes

| Mode No. | VESA® Mode No. | No. of Colors | Char. × Row | Char. Cell | Screen Format | Display Mode | Horiz. Freq. kHz | Vert. Freq. Hz |
|----------|----------------|---------------|-------------|------------|---------------|--------------|------------------|----------------|
| 00/01 | – | 16/256 | 40 × 25 | 8 × 8 | 320 × 200 | Text | 31.5 | 70 |
| 00*/01* | – | 16/256 | 40 × 25 | 8 × 14 | 320 × 350 | Text | 31.5 | 70 |
| 00+/01+ | – | 16/256 | 40 × 25 | 9 × 16 | 360 × 400 | Text | 31.5 | 70 |
| 02/03 | – | 16/256 | 80 × 25 | 8 × 8 | 640 × 200 | Text | 31.5 | 70 |
| 02*/03* | – | 16/256 | 80 × 25 | 8 × 14 | 640 × 350 | Text | 31.5 | 70 |
| 02+/03+ | – | 16/256 | 80 × 25 | 9 × 16 | 720 × 400 | Text | 31.5 | 70 |
| 04/05 | – | 4/256 | 40 × 25 | 8 × 8 | 320 × 200 | Graphics | 31.5 | 70 |
| 6 | – | 2/256 | 80 × 25 | 8 × 8 | 640 × 200 | Graphics | 31.5 | 70 |
| 07* | – | Monochrome | 80 × 25 | 9 × 14 | 720 × 350 | Text | 31.5 | 70 |
| 07+ | – | Monochrome | 80 × 25 | 9 × 16 | 720 × 400 | Text | 31.5 | 70 |
| 0D | – | 16/256 | 40 × 25 | 8 × 8 | 320 × 200 | Graphics | 31.5 | 70 |
| 0E | – | 16/256 | 80 × 25 | 8 × 8 | 640 × 200 | Graphics | 31.5 | 70 |
| 0F | – | Monochrome | 80 × 25 | 8 × 14 | 640 × 350 | Graphics | 31.5 | 70 |
| 10 | – | 16/256 | 80 × 25 | 8 × 14 | 640 × 350 | Graphics | 31.5 | 70 |
| 11 | – | 2/256 | 80 × 30 | 8 × 16 | 640 × 480 | Graphics | 31.5 | 60 |
| 11+ | – | 2/256 | 80 × 30 | 8 × 16 | 640 × 480 | Graphics | 37.9 | 72 |
| 12 | – | 16/256 | 80 × 30 | 8 × 16 | 640 × 480 | Graphics | 31.5 | 60 |
| 12+ | – | 16/256 | 80 × 30 | 8 × 16 | 640 × 480 | Graphics | 37.9 | 72 |
| 13 | – | 256/256 | 40 × 25 | 8 × 8 | 320 × 200 | Graphics | 31.5 | 70 |

Table 4-2. Cirrus Logic Extended Video Modes

| Mode No. | VESA® No. | No. of Colors | Char. × Row | Char. Cell | Screen Format | Display Mode | Pixel Freq. MHz | Horiz. Freq. kHz | Vert. Freq. Hz |
|----------|-----------|---------------|-------------|------------|---------------|--------------|-----------------|------------------|----------------|
| 14 | – | 16/256K | 132 × 25 | 8 × 16 | 1056 × 400 | Text | 41.5 | 31.5 | 70 |
| 54 | 10A | 16/256K | 132 × 43 | 8 × 8 | 1056 × 350 | Text | 41.5 | 31.5 | 70 |
| 55 | 109 | 16/256K | 132 × 25 | 8 × 14 | 1056 × 350 | Text | 41.5 | 31.5 | 70 |
| 58, 6A | 102 | 16/256K | 100 × 37 | 8 × 16 | 800 × 600 | Graphics | 36 | 35.2 | 56 |
| 58, 6A | 102 | 16/256K | 100 × 37 | 8 × 16 | 800 × 600 | Graphics | 40 | 37.8 | 60 |
| 58, 6A | 102 | 16/256K | 100 × 37 | 8 × 16 | 800 × 600 | Graphics | 50 | 48.1 | 72 |
| 58, 6A | 102 | 16/256K | 100 × 37 | 8 × 16 | 800 × 600 | Graphics | 49.5 | 46.9 | 75 |
| 5C | 103 | 256/256K | 100 × 37 | 8 × 16 | 800 × 600 | Graphics | 36 | 35.2 | 56 |
| 5C | 103 | 256/256K | 100 × 37 | 8 × 16 | 800 × 600 | Graphics | 40 | 37.9 | 60 |
| 5C | 103 | 256/256K | 100 × 37 | 8 × 16 | 800 × 600 | Graphics | 50 | 48.1 | 72 |
| 5C | 103 | 256/256K | 100 × 37 | 8 × 16 | 800 × 600 | Graphics | 49.5 | 46.9 | 75 |
| 5D† | 104 | 16/256K | 128 × 48 | 8 × 16 | 1024 × 768 | Graphics | 44.9 | 35.5 | 87† |
| 5D | 104 | 16/256K | 128 × 48 | 8 × 16 | 1024 × 768 | Graphics | 65 | 48.3 | 60 |
| 5D | 104 | 16/256K | 128 × 48 | 8 × 16 | 1024 × 768 | Graphics | 75 | 56 | 70 |
| 5D | 104 | 16/256K | 128 × 48 | 8 × 16 | 1024 × 768 | Graphics | 77 | 58 | 72 |
| 5D | 104 | 16/256K | 128 × 48 | 8 × 16 | 1024 × 768 | Graphics | 78.7 | 60 | 75 |
| 5E | 100 | 256/256K | 80 × 25 | 8 × 16 | 640 × 400 | Graphics | 25 | 31.5 | 70 |
| 5F | 101 | 256/256K | 80 × 30 | 8 × 16 | 640 × 480 | Graphics | 25 | 31.5 | 60 |
| 5F | 101 | 256/256K | 80 × 30 | 8 × 16 | 640 × 480 | Graphics | 31.5 | 37.9 | 72 |
| 60† | 105 | 256/256K | 128 × 48 | 8 × 16 | 1024 × 768 | Graphics | 44.9 | 35.5 | 87† |
| 60 | 105 | 256/256K | 128 × 48 | 8 × 16 | 1024 × 768 | Graphics | 65 | 48.3 | 60 |
| 60 | 105 | 256/256K | 128 × 48 | 8 × 16 | 1024 × 768 | Graphics | 75 | 56 | 70 |
| 60 | 105 | 256/256K | 128 × 48 | 8 × 16 | 1024 × 768 | Graphics | 77 | 58 | 72 |
| 60 | 105 | 256/256K | 128 × 48 | 8 × 16 | 1024 × 768 | Graphics | 78.7 | 60 | 75 |
| 64 | 111 | 64K | – | – | 640 × 480 | Graphics | 25 | 31.5 | 60 |
| 64 | 111 | 64K | – | – | 640 × 480 | Graphics | 31.5 | 37.9 | 72 |
| 65 | 114 | 64K | – | – | 800 × 600 | Graphics | 36 | 35.2 | 56 |
| 65 | 114 | 64K | – | – | 800 × 600 | Graphics | 40 | 37.8 | 60 |
| 65 | 114 | 64K | – | – | 800 × 600 | Graphics | 50 | 48.1 | 72 |

Table 4-2. Cirrus Logic Extended Video Modes (cont.)

| Mode No. | VESA® No. | No. of Colors | Char. × Row | Char. Cell | Screen Format | Display Mode | Pixel Freq. MHz | Horiz. Freq. kHz | Vert. Freq. Hz |
|----------|-----------|---------------|-------------|------------|---------------|--------------|-----------------|------------------|----------------|
| 66 | 110 | 32K‡ | – | – | 640 × 480 | Graphics | 25 | 31.5 | 60 |
| 66 | 110 | 32K‡ | – | – | 640 × 480 | Graphics | 31.5 | 37.9 | 72 |
| 67 | 113 | 32K‡ | – | – | 800 × 600 | Graphics | 36 | 35.2 | 56 |
| 67 | 113 | 32K‡ | – | – | 800 × 600 | Graphics | 40 | 37.8 | 60 |
| 67 | 113 | 32K‡ | – | – | 800 × 600 | Graphics | 50 | 48.1 | 72 |
| 68† | 116 | 32K‡ | – | – | 1024 × 768 | Graphics | 44.9 | 35.5 | 87† |
| 6C† | 106 | 16/256K | 160 × 64 | 8 × 16 | 1280 × 1024 | Graphics | 75 | 48 | 87† |
| 6D† | 107 | 256/256K | 160 × 64 | 8 × 16 | 1280 × 1024 | Graphics | 75 | 48 | 87† |
| 71 | 112 | 16M | – | – | 640 × 480 | Graphics | 25 | 31.5 | 60 |
| 74† | 117 | 64K | – | – | 1024 × 768 | Graphics | 44.9 | 35.5 | 87† |

NOTES:

- 1) Some modes are not supported by all CL-GD542X controllers. Refer to the CL-GD542X data book and software release kit for the list of video modes supported by the CL-GD542X BIOS.
- 2) Not all monitors support all modes. The fastest vertical refresh rate for the monitor type selected will be used automatically.
- 3) ‡ indicates 32K Direct-Color/256-color Mixed mode.
- 4) † indicates Interlaced mode.

Table 4-3. NTSC TV Video Modes (CL-GD5425 only)

| Mode No. | Colors | Screen Format | Char. × Row | Char. Cell | Display Mode | Note |
|----------|----------|---------------|-------------|------------|--------------|----------------|
| 00/01 | 16/256K | 320 × 200 | 40 × 25 | 8 × 8 | Text | – |
| 02/03 | 16/256K | 640 × 200 | 80 × 25 | 8 × 8 | Text | – |
| 04/05 | 4/256K | 320 × 200 | 40 × 25 | 8 × 8 | Graphics | Double scanned |
| 06 | 2/256K | 640 × 200 | 80 × 25 | 8 × 8 | Graphics | Double scanned |
| 0D | 16/256K | 320 × 200 | 40 × 25 | 8 × 8 | Graphics | Double scanned |
| 0E | 16/256K | 640 × 200 | 80 × 25 | 8 × 8 | Graphics | Double scanned |
| 10 | 16/256K | 640 × 350 | 80 × 25 | 8 × 14 | Graphics | 7:8 expansion |
| 11/12 | 16/256K | 640 × 480 | 80 × 30 | 8 × 16 | Graphics | 6:5 scale |
| 13 | 256/256K | 320 × 200 | 40 × 25 | 8 × 8 | Graphics | Double scanned |
| 5E | 256/256K | 640 × 400 | 80 × 25 | 8 × 16 | Graphics | – |
| 5F | 256/256K | 640 × 480 | 80 × 30 | 8 × 16 | Graphics | 6:5 scale |
| 64 | 64K | 640 × 480 | – | – | Graphics | 6:5 scale |
| 7A | 64K | 640 × 400 | – | – | Graphics | – |

Table 4-4. PAL TV Video Modes (CL-GD5425 only)

| Mode No. | Colors | Screen Format | Char. × Row | Char. Cell | Display Mode | Note |
|----------|----------|---------------|-------------|------------|--------------|---------------------------------|
| 00/01 | 16/256K | 320 × 200 | 40 × 25 | 8 × 8 | Text | 5:6 expansion |
| 02/03 | 16/256K | 640 × 200 | 80 × 25 | 8 × 8 | Text | 5:6 expansion |
| 04/05 | 4/256K | 320 × 200 | 40 × 25 | 8 × 8 | Graphics | Double Scanned 5:6 expansion |
| 06 | 2/256K | 640 × 200 | 80 × 25 | 8 × 8 | Graphics | Double Scanned 5:6 expansion |
| 0D | 16/256K | 320 × 200 | 40 × 25 | 8 × 8 | Graphics | Double scanned 5:6 expansion |
| 0E | 16/256K | 640 × 200 | 80 × 25 | 8 × 8 | Graphics | Double scanned 5:6 expansion |
| 10 | 16/256K | 640 × 350 | 80 × 25 | 8 × 14 | Graphics | 5:7 expansion 490 scanlines |
| 11/12 | 16/256K | 640 × 480 | 80 × 30 | 8 × 16 | Graphics | – |
| 13 | 256/256K | 320 × 200 | 40 × 25 | 8 × 8 | Graphics | 5:6 expansion |
| 5E | 256/256K | 640 × 400 | 80 × 25 | 8 × 16 | Graphics | 5:6 Expansion |
| 5F | 256/256K | 640 × 480 | 80 × 30 | 8 × 16 | Graphics | – |
| 64 | 64K | 640 × 480 | – | – | Graphics | – |
| 7A | 64K | 640 × 400 | – | – | Graphics | 5:6 expansion |

4.2 Configuration Register, CF1

When RESET (system power-on reset) goes active, the CL-GD542X samples the levels on several of the Display Memory Data MD[x] pins. These levels are latched into a write-only configuration register (CF1). The data bits in this register are not accessible to the host CPU. The levels on the Memory Data bus are, by default, a logic '1' during power-on reset due to internal 250-k Ω pull-up resistors. A logic '0' is achieved by installing an external 6.8-k Ω pull-down resistor on the memory data line corresponding to the appropriate bit in the Configuration register. The following table identifies the Configuration register bits and the particular VGA function enabled by the latched level on the Memory Data bus during power-on reset.

Table 4-5. Configuration Register Bits

| CF Bits | Level | Description | Memory Data Bit | Pin Number |
|----------|--|--|-----------------|--------------|
| 15 | 0 1 | Source VCLK on MCLK pin (CL-GD5425/29) Source MCLK on MCLK pin (CL-GD5425/29) | MD31 | 97 |
| 14, 7, 5 | 000 001 010 011 100 101 110 111 | Reserved '386DX local bus (CL-GD5424/25/26/28/29) '386SX local bus (CL-GD5424/25/26/28/29) '486SX/DX local bus (CL-GD5424/25/26/28) VESA® VL-Bus™ > 33 MHz (CL-GD5425/29) MicroChannel® bus VESA® VL-Bus™ (CL-GD5424/25/26/28/29) ISA bus | MD30, 23, 21 | 98, 108, 110 |
| 13 | 0 1 | Asymmetric DRAM (Not CL-GD5425) Symmetric DRAM IREF Adjust (CL-GD5425) | MD29 | 99 |
| 12 | 0 1 | CAS[3:0]*, single-WE* (Reserved in CL-GD5420/25) WE[3:0]*, single-CAS* | MD28 | 100 |
| 11 | 0 1 | 7-MCLK RAS* cycle 6-MCLK RAS* cycle | MD27 | 102 |
| 10,9 | 00 01 10 11 | 50.11363-MHz MCLK (Reserved in CL-GD5425) 44.74431-MHz MCLK 41.16477-MHz MCLK 37.58523-MHz MCLK | MD26, 25 | 103, 104 |
| 8 | 0 1 | 64K ROM BIOS @ C0000-CFFFF 32K ROM BIOS @ C0000-C7FFF | MD24 | 105 |
| 6 | 0 1 | 16-bit BIOS ROM (ISA bus only) (MCS16* generated for 64K or 32K) 8-bit BIOS ROM (CL-GD5424 does not generate MCS16*) | MD22 | 109 |
| 4 | 0 1 | External MCLK (pin 157 is an input) (Test) Internal MCLK (pin 157 is an output) | MD20 | 111 |
| 3 | 0 1 | Port 3C3h is Video System Sleep register Port 46E8h is Video System Sleep register | MD19 | 112 |
| 2 | | Reserved | MD18 | 113 |
| 1 | 0 1 0 1 | Zero wait enabled (except CL-GD5425/29) Zero wait disabled (except CL-GD5425/29) Disable NTSC Black-Level offset (CL-GD5425) Enable NTSC Black-Level offset (CL-GD5425) | MD17 | 114 |
| 0 | 0 1 | XTAL, OSC configured for two ref (CL-GD5425) XTAL, OSC configured for one ref (CL-GD5425) | MD16 | 115 |

4.3 Host Interface Signals

With the pin connections listed below, the CL-GD542X will interface directly to an ISA, MicroChannel, or local bus.

Table 4-6. Bus Connections

| CL-GD542X Pin | ISA Bus | MicroChannel® Bus | '386SX | '386DX | '486 | VESA® VL-Bus™ |
|---------------------------------|-----------|-------------------|-----------|-----------|----------|------------------|
| [45..42], [39..29] | SA[16:2] | A[16:2] | A[16:2] | A[16:2] | A[16:2] | A[16:2] |
| 28 | SA1 | A1 | A1 | BE3# | BE3# | BE3# |
| 27 | SA0 | A0 | BLE# | BE2# | BE2# | BE2# |
| [21..15] | LA[23:17] | A[23:17] | A[23:17] | A[23:17] | A[23:17] | A[23:17] |
| [11..8], [6..3] | SD[15:8] | D[15:8] | D[15:8] | D[15:8] | D[15:8]† | D[15:8]† |
| [63..62], [60..59], [57..54] | SD[7:0] | D[7:0] | D[7:0] | D[7:0] | D[7:0]† | D[7:0]† |
| 24 | SBHE* | -SBHE | BHE# | BE1# | BE1# | BE1# |
| 25 | BALE | MADE24 | ADS# | ADS# | ADS# | ADS# |
| 46 | AEN | -CD_SETUP | CPU-Reset | CPU-Reset | Ground | RDYRTN# |
| 49 | IOR* | -S1 | W/R# | W/R# | W/R# | W/R# |
| 50 | IOW* | -CMD | CLK2X | CLK2X | CLK1X | CLK1X |
| 14 | MEMR* | M-/IO | M/IO# | M/IO# | M/IO# | M/IO# |
| 13 | MEMW* | -S0 | (unused) | UADDR# | UADDR# | UADDR# |
| 41 | RESET | CHRESET | RESET | RESET | RESET | RESET |
| 48 | REFRESH | -REFRESH | (unused) | BE0# | BE0# | BE0# |
| 23 | MCS16* | -CD_DS16 | (unused) | BS16# | BS16# | BS16# |
| 51 | OWS* | (unused) | GROUND | GROUND | GROUND | GROUND |
| 52 | IRQ | -IRQ | INTR | INTR | INTR | INTR |
| 47 | IOCHRDY | CD_CHRDY | READY# | READY# | RDY# | RDY# |
| 22 | IOCS16* | -CD_SFDBK | LBA# | LBA# | LBA# | LBA# |
| 159 | OSC | OSC | OSC | OSC | OSC | OSC |
| 2 | EROM* | EROM* | EROM* | EROM* | EROM* | EROM* |

NOTES:

- 1) For ISA-bus applications, note that SA[19..17] are not found on the CL-GD542X; this means that an adapter board will only function in a 16-bit slot.
- 2) The OSC and EROM* pins are common in all configurations.
- 3) The OSC pin is an input for 14.31818 MHz.
- 4) † Data lines D[15:0] connect to external, data-steering transceiver.

5. VGA REGISTER PORT MAP

Table 5-1. VGA Register Port Map

| Address | Port |
|---------|---|
| 94 | POS 102 Access Control (3C3 sleep) |
| 102 | POS102 register |
| 3B4 | CRT Controller Index (R/W — monochrome) |
| 3B5 | CRT Controller Data (R/W — monochrome) |
| 3BA | Feature Control (W), Input Status register 1 (R — monochrome) |
| 3C0 | Attribute Controller Index/Data (Write) |
| 3C1 | Attribute Controller Index/Data (Read) |
| 3C2 | Miscellaneous Output (W), Input Status register 0 (R) |
| 3C3 | MotherBoard Sleep |
| 3C4 | Sequencer Index (R/W) |
| 3C5 | Sequencer Data (R/W) |
| 3C6 | Video DAC Pixel Mask (R/W), Hidden DAC register (R/W) |
| 3C7 | Pixel Address Read mode (W), DAC State (R) |
| 3C8 | Pixel Mask Write mode (R/W) |
| 3C9 | Pixel Data (R/W) |
| 3CA | Feature Control Readback (R) |
| 3CC | Miscellaneous Output Readback (R) |
| 3CE | Graphics Controller Index (R/W) |
| 3CF | Graphics Controller Data (R/W) |
| 3D4 | CRT Controller Index (R/W — color) |
| 3D5 | CRT Controller Data (R/W — color) |
| 3DA | Feature Control (W), Input Status register 1 (R — color) |
| 46E8 | Adapter Sleep |

6. CL-GD542X REGISTERS

Table 6-1. External/General Registers

| Abbreviation | Register Name | Index | Port |
|--------------|--|-------|--------------------------|
| 102 Access | POS 94: 102 Access Control | - | 94 |
| POS102 | POS102 | - | 102 |
| VSSM | Motherboard Sleep Address (CL-GD5424/25/26/28/29 only) | - | 3C3 |
| VSSM | Adapter Sleep | - | 46E8 |
| MISC | Miscellaneous Output | - | 3C2 (Write) |
| MISC | Miscellaneous Output | - | 3CC (Read) |
| FC | Feature Control | - | 3?A (Write) ^a |
| FC | Feature Control | - | 3CA (Read) |
| FEAT | Input Status Register 0 | - | 3C2 |
| STAT | Input Status Register 1 | - | 3?A |
| 3C6 | Pixel Mask | - | 3C6 |
| 3C7 | Pixel Address Read Mode | - | 3C7 (Write) |
| 3C7 | DAC State | - | 3C7 (Read) |
| 3C8 | Pixel Address Write Mode | - | 3C8 |
| 3C9 | Pixel Data | - | 3C9 |

^a '?' in the above register addresses is 'B' in Monochrome mode and 'D' in Color mode.

Table 6-2. VGA Sequencer Registers

| Abbreviation | Register Name | Index | Port |
|--------------|----------------------|-------|------|
| SRX | Sequencer Index | - | 3C4 |
| SR0 | Reset | 0 | 3C5 |
| SR1 | Clocking Mode | 1 | 3C5 |
| SR2 | Plane Mask | 2 | 3C5 |
| SR3 | Character Map Select | 3 | 3C5 |
| SR4 | Memory Mode | 4 | 3C5 |

Table 6-3. CRT Controller Registers

| Abbreviation | Register Name | Index | Port |
|--------------|--------------------------------------|-------|------------------|
| CRX | CRTC Index | — | 3?4 ^a |
| CR0 | Horizontal Total | 0 | 3?5 |
| CR1 | Horizontal Display End | 1 | 3?5 |
| CR2 | Horizontal Blanking Start | 2 | 3?5 |
| CR3 | Horizontal Blanking End | 3 | 3?5 |
| CR4 | Horizontal Sync Start | 4 | 3?5 |
| CR5 | Horizontal Sync End | 5 | 3?5 |
| CR6 | Vertical Total | 6 | 3?5 |
| CR7 | Overflow | 7 | 3?5 |
| CR8 | Screen A Preset Row Scan | 8 | 3?5 |
| CR9 | Character Cell Height | 9 | 3?5 |
| CRA | Text Cursor Start | A | 3?5 |
| CRB | Text Cursor End | B | 3?5 |
| CRC | Screen Start Address High | C | 3?5 |
| CRD | Screen Start Address Low | D | 3?5 |
| CRE | Text Cursor Location High | E | 3?5 |
| CRF | Text Cursor Location Low | F | 3?5 |
| CR10 | Vertical Sync Start | 10 | 3?5 |
| CR11 | Vertical Sync End | 11 | 3?5 |
| CR12 | Vertical Display End | 12 | 3?5 |
| CR13 | Offset | 13 | 3?5 |
| CR14 | Underline Row Scanline | 14 | 3?5 |
| CR15 | Vertical Blanking Start | 15 | 3?5 |
| CR16 | Vertical Blanking End | 16 | 3?5 |
| CR17 | Mode Control | 17 | 3?5 |
| CR18 | Line Compare | 18 | 3?5 |
| CR22 | Graphics Data Latches Readback | 22 | 3?5 |
| CR24 | Attribute Controller Toggle Readback | 24 | 3?5 |
| CR26 | Attribute Controller Index Readback | 26 | 3?5 |

^a '?' in the above register addresses is 'B' in Monochrome mode and 'D' in Color mode.

Table 6-4. VGA Graphics Controller Registers

| Abbreviation | Register Name | Index | Port |
|--------------|---------------------------|-------|------|
| GRX | Graphics Controller Index | – | 3CE |
| GR0 | Set/Reset | 0 | 3CF |
| GR1 | Set/Reset Enable | 1 | 3CF |
| GR2 | Color Compare | 2 | 3CF |
| GR3 | Data Rotate | 3 | 3CF |
| GR4 | Read Map Select | 4 | 3CF |
| GR5 | Mode | 5 | 3CF |
| GR6 | Miscellaneous | 6 | 3CF |
| GR7 | Color Don't Care | 7 | 3CF |
| GR8 | Bit Mask | 8 | 3CF |

Table 6-5. VGA Attribute Controller Registers

| Abbreviation | Register Name | Index | Port |
|--------------|------------------------------|-------|---------|
| ARX | Attribute Controller Index | – | 3C0/3C1 |
| AR0–ARF | Attribute Controller Palette | 0:F | 3C0/3C1 |
| AR10 | Attribute Controller Mode | 10 | 3C0/3C1 |
| AR11 | Overscan (Border) Color | 11 | 3C0/3C1 |
| AR12 | Color Plane Enable | 12 | 3C0/3C1 |
| AR13 | Pixel Panning | 13 | 3C0/3C1 |
| AR14 | Color Select | 14 | 3C0/3C1 |

Table 6-6. Extension Registers

| Abbreviation | Register Name | Index | Port |
|--------------|--|-------|------|
| SR2 | Enable Writing Pixel Extension | 2 | 3C5 |
| SR6 | Unlock ALL Extensions | 6 | 3C5 |
| SR7 | Extended Sequencer Mode | 7 | 3C5 |
| SR8 | EEPROM Control | 8 | 3C5 |
| SR9 | Scratch-Pad 0 | 9 | 3C5 |
| SRA | Scratch-Pad 1 | A | 3C5 |
| SRB | VCLK0 Numerator | B | 3C5 |
| SRC | VCLK1 Numerator | C | 3C5 |
| SRD | VCLK2 Numerator | D | 3C5 |
| SRE | VCLK3 Numerator | E | 3C5 |
| SRF | DRAM Control | F | 3C5 |
| SR10 | Graphics Cursor Y Position | 10 | 3C5 |
| SR11 | Graphics Cursor X Position | 11 | 3C5 |
| SR12 | Graphics Cursor Attributes | 12 | 3C5 |
| SR13 | Graphics Cursor Pattern Address Offset | 13 | 3C5 |
| SR14 | Scratch-Pad 2 (CL-GD5425/26/28/29 only) | 14 | 3C5 |
| SR15 | Scratch-Pad 3 (CL-GD5425/26/28/29 only) | 15 | 3C5 |
| SR16 | Performance Tuning (CL-GD5424/25/26/28/29 only) | 16 | 3C5 |
| SR17 | Configuration Readback and Extended Control (except CL-GD5420) | 17 | 3C5 |
| SR18 | Signature Generator Control (except CL-GD5420) | 18 | 3C5 |
| SR19 | Signature Generator Result Low Byte (except CL-GD5420) | 19 | 3C5 |
| SR1A | Signature Generator Result High Byte (except CL-GD5420) | 1A | 3C5 |
| SR1B | VCLK0 Denominator and Post-Scalar Value | 1B | 3C5 |
| SR1C | VCLK1 Denominator and Post-Scalar Value | 1C | 3C5 |
| SR1D | VCLK2 Denominator and Post-Scalar Value | 1D | 3C5 |
| SR1E | VCLK3 Denominator and Post-Scalar Value | 1E | 3C5 |
| SR1F | BIOS ROM Write Enable and MCLK Select | 1F | 3C5 |
| GR0 | Write Mode 5 Background Extension | 0 | 3CF |
| GR1 | Write Mode 4, 5 Foreground Extension | 1 | 3CF |
| GR9 | Offset Register 0 | 9 | 3CF |
| GRA | Offset Register 1 | A | 3CF |

Table 6-6. Extension Registers (cont.)

| Abbreviation | Register Name | Index | Port |
|--------------|--|-------|------------------|
| GRB | Graphics Controller Mode Extensions | B | 3CF |
| GRC | Color Key (CL-GD5424/25/26/28/29 only) | C | 3CF |
| GRD | Color Key Mask (CL-GD5424/25/26/28/29 only) | D | 3CF |
| GRE | Miscellaneous Control (CL-GD5425/28/29 only) | E | 3CF |
| GR10 | 16-bit Pixel BG Color High Byte (except CL-GD5420) | 10 | 3CF |
| GR11 | 16-bit Pixel FG Color High Byte (except CL-GD5420) | 11 | 3CF |
| GR18 | Extended DRAM Controls (CL-GD5429 only) | 18 | 3CF |
| CR19 | Interface End | 19 | 3?5 ^a |
| CR1A | Miscellaneous Control | 1A | 3?5 |
| CR1B | Extended Display Controls | 1B | 3?5 |
| CR1C | Sync Adjust and GENLOCK (CL-GD5425 only) | 1C | 3?5 |
| CR1D | Overlay Mode Controls (CL-GD5425/29 only) | 1D | 3?5 |
| CR25 | Part Status | 25 | 3?5 |
| CR27 | ID | 27 | 3?5 |
| CR30 | TV-Out Mode Control (CL-GD5425 only) | 30 | 3?5 |
| HDR | Hidden DAC (except CL-GD5420) | - | 3C6 |

^a '?' in the above register addresses is 'B' in Monochrome mode and 'D' in Color mode.

Table 6-7. CL-GD5426/28/29 BitBLT Registers

| Abbreviation | Register Name | Index | Port |
|--------------|----------------------------|-------|------|
| GR20 | BLT Width Low | 20 | 3CF |
| GR21 | BLT Width High | 21 | 3CF |
| GR22 | BLT Height Low | 22 | 3CF |
| GR23 | BLT Height High | 23 | 3CF |
| GR24 | BLT Destination Pitch Low | 24 | 3CF |
| GR25 | BLT Destination Pitch High | 25 | 3CF |
| GR26 | BLT Source Pitch Low | 26 | 3CF |
| GR27 | BLT Source Pitch High | 27 | 3CF |
| GR28 | BLT Destination Start Low | 28 | 3CF |
| GR29 | BLT Destination Start Mid | 29 | 3CF |
| GR2A | BLT Destination Start High | 2A | 3CF |

Table 6-7. CL-GD5426/28/29 BitBLT Registers (cont.)

| Abbreviation | Register Name | Index | Port |
|---------------------|---|--------------|-------------|
| GR2C | BLT Source Start Low | 2C | 3CF |
| GR2D | BLT Source Start Mid | 2D | 3CF |
| GR2E | BLT Source Start High | 2E | 3CF |
| GR2F | BLT Write Mask Destination (<i>CL-GD5429 only</i>) | 2F | 3CF |
| GR30 | BLT Mode | 30 | 3CF |
| GR31 | BLT Start/Status | 31 | 3CF |
| GR32 | BLT Raster Operation | 32 | 3CF |
| GR34 | Transparent Color Select Low (<i>except CL-GD5429</i>) | 34 | 3CF |
| GR35 | Transparent Color Select High (<i>except CL-GD5429</i>) | 35 | 3CF |
| GR38 | Transparent Color Mask Low (<i>except CL-GD5429</i>) | 38 | 3CF |
| GR39 | Transparent Color Mask High (<i>except CL-GD5429</i>) | 39 | 3CF |

7. ELECTRICAL SPECIFICATIONS

7.1 Absolute Maximum Ratings

| | |
|--|--|
| Ambient temperature under bias | 0° to 70° C |
| Storage temperature..... | -65° to 150° C |
| Voltage on any pin | $V_{SS} - 0.5 \text{ V}$ to $V_{CC} + 0.5 \text{ V}$ |
| Operating power dissipation | 1.5 Watts |
| Power supply voltage..... | 7 Volts |
| Injection current (latch-up testing) | 100 mA |

NOTE: Stresses above those listed may cause permanent damage to system components. These are stress ratings only. Functional operation at these or any conditions above those indicated in the operational ratings of this specification is not implied. Exposure to absolute maximum rating conditions for extended periods may affect system reliability.

7.2 DC Specifications (Digital)

($V_{CC} = 5V \pm 5\%$, $T_A = 0^\circ$ to 70° C, unless otherwise specified)

| Symbol | Parameter | MIN | MAX | Units | Test Conditions | Note |
|-----------|------------------------------|------|----------------|---------|--------------------------------|------|
| V_{CC} | Power Supply Voltage | 4.75 | 5.25 | Volts | Normal Operation | |
| V_{IL} | Input Low Voltage | 0 | 0.8 | Volts | | |
| V_{IH} | Input High Voltage | 2.0 | $V_{CC} + 0.5$ | Volts | | |
| V_{OL} | Output Low Voltage | | 0.5 | Volts | $I_{OL} = 4$ mA | 1 |
| V_{OH} | Output High Voltage | 2.4 | | Volts | $I_{OH} = 400$ μ A | 2 |
| I_{CC} | Supply Current | | | | V_{CC} Nominal | 3 |
| I_{IH} | Input High Current | | 10 | μ A | $V_{IL} = V_{DD}$ | |
| I_{IL} | Input Low Current | -10 | | μ A | $V_{DD} = 5.25$, $V_{IL} = 0$ | |
| I_{IHP} | Input High Current (pull-up) | -10 | 10 | μ A | $V_{IL} = V_{DD}$ | |
| I_{ILP} | Input Low Current (pull-up) | -45 | -12 | μ A | $V_{DD} = 5.25$, $V_{IL} = 0$ | |
| I_{OZ} | Input Leakage | -10 | 10 | μ A | $0 < V_{IN} < V_{CC}$ | |
| C_{IN} | Input Capacitance | | 10 | pF | | 4 |
| C_{OUT} | Output Capacitance | | 10 | pF | | 4 |

NOTES:

- I_{OL} is specified for a standard buffer. See the pin summary for further information.
- I_{OH} is specified for a standard buffer. See the pin summary for further information.
- I_{CC} is measured with VCLK and MCLK as indicated in the table below:

| Part Number | VCLK | MCLK | I_{CC} |
|--------------|--------|--------|----------|
| CL-GD5420 | 75 MHz | 50 MHz | 250 mA |
| CL-GD5422 | 80 MHz | 50 MHz | 260 mA |
| CL-GD5424/25 | 80 MHz | 50 MHz | 260 mA |
| CL-GD5426/28 | 80 MHz | 50 MHz | 260 mA |
| CL-GD5429 | 86 MHz | 70 MHz | 310 mA |

- This is not 100% tested, but is periodically sampled.

7.3 DC Specifications (Palette DAC)

($V_{CC} = 5V \pm 5\%$, $T_A = 0^\circ$ to 70° C, unless otherwise specified)

| Symbol | Parameter | MIN | MAX | Units | Test Conditions | Note |
|-----------|-----------------------|------|------|-------|------------------|------|
| A_{VDD} | DAC Supply Voltage | 4.75 | 5.25 | Volts | Normal Operation | |
| I_{REF} | DAC Reference Current | -3 | -10 | mA | | 1 |

NOTE: See the Detailed Pin Description for information regarding nominal I_{REF} .

7.4 DC Specifications (Frequency Synthesizer)

($V_{CC} = 5V \pm 5\%$, $T_A = 0^\circ$ to 70° C, unless otherwise specified)

| Symbol | Parameter | MIN | MAX | Units | Test Conditions | Note |
|-----------|----------------------------|------|------|-------|-----------------|------|
| A_{VDD} | Synthesizer Supply Voltage | 4.75 | 5.25 | Volts | | |

7.5 DAC Characteristics

($V_{CC} = 5\text{ V} \pm 5\%$, $T_A = 0^\circ$ to 70° C , unless otherwise specified)

| Symbol | Parameter | MIN | MAX | Units | Test Conditions | Note |
|--------|------------------------------|-----|---------|---------|-------------------|---------|
| R | Resolution | 8 | Max | Bits | | |
| IO | Output Current | 30 | Max | mA | $V_O < 1\text{V}$ | |
| TR | Analog Output Rise/Fall Time | 8 | Max | ns | | 2, 3, 4 |
| TS | Analog Output Settling Time | 15 | Max | ns | | 2, 3, 5 |
| TSK | Analog Output Skew | tbd | Max | ns | | 2, 3, 6 |
| DT | DAC-to-DAC Correlation | 2.5 | Max | % | | 6, 7 |
| GI | Glitch Impulse | | Typical | pV-sec. | | 2, 3, 6 |
| IL | Integral Linearity | 1.5 | Max | LSB | | |
| DL | Differential Linearity | 1.5 | Max | LSB | | |

NOTES:

- 1) TD is measured from the 50% point of VCLK to the 50% point of full-scale transition.
- 2) Load is $50\ \Omega$ and $30\ \text{pF}$ per analog output.
- 3) $I_{REF} = -6.67\ \text{mA}$.
- 4) TR is measured from 10% to 90% full-scale.
- 5) TS is measured from 50% of full-scale transition to the output remaining within 2% of final value.
- 6) Outputs loaded identically.
- 7) About the mid-point of the distribution of the three DACs measured at full-scale output.

7.6 List of Waveforms

| Table/Figure | Title | Page |
|---------------------|--|-------------|
| 7-1 | I/O Write Timing (ISA Bus) | 59 |
| 7-2 | I/O Read Timing (ISA Bus) | 60 |
| 7-3 | Memory Write Timing (ISA Bus) | 61 |
| 7-4 | Memory Read Timing (ISA Bus) | 62 |
| 7-5 | MCS16* Timing (ISA Bus) | 63 |
| 7-6 | IOCS16* Timing (ISA Bus) | 63 |
| 7-7 | BALE Timing (ISA Bus) | 64 |
| 7-8 | IOCHRDY for Memory Access Timing (ISA Bus) | 65 |
| 7-9 | OVS* Timing (ISA Bus) | 65 |
| 7-10 | Refresh Timing (ISA Bus) | 66 |
| 7-11 | EROM* Timing (ISA Bus) | 66 |
| 7-12 | AEN Timing (ISA Bus) | 67 |
| 7-13 | Write Timing (MicroChannel® Bus) | 68 |
| 7-14 | Read Timing (MicroChannel® Bus) | 69 |
| 7-15 | -CD_DS16 Timing (MicroChannel® Bus) | 70 |
| 7-16 | -CMD Timing MicroChannel® Bus) | 71 |
| 7-17 | CD_CHRDY Timing (MicroChannel® Bus) | 72 |
| 7-18 | -Refresh Timing (MicroChannel® Bus) | 73 |
| 7-19 | -EROM Timing (MicroChannel® Bus) | 74 |
| 7-20 | -CD_SFDBK Timing (MicroChannel® Bus) | 74 |
| 7-21 | -CD_SETUP Timing (MicroChannel® Bus) | 75 |
| 7-22 | CLK1X, CLK2X Timing (Local Bus) | 76 |
| 7-23 | RESET Timing (Local Bus) | 77 |
| 7-24 | ADS#, LBA#, BS16# Timing (Local Bus) | 78 |
| 7-25 | RDY# Delay (Local Bus) | 79 |
| 7-26 | Read Data Timing (Local Bus) | 80 |
| 7-27 | Buffer Control Timing – Read Cycle (Local Bus) | 81 |
| 7-28 | Buffer Control Timing – Write Cycle (Local Bus) | 82 |
| 7-29 | Display Memory Bus – Common Parameters | 83 |
| 7-30 | Display Memory Bus – Read Cycles | 85 |
| 7-31 | Display Memory Bus: Write Cycles | 87 |
| 7-32 | CAS*-before-RAS* Refresh Timing: Display Memory Bus | 88 |
| 7-33 | P-Bus as Inputs, 8-Bit Mode (DCLK input as reference) | 88 |
| 7-34 | Feature Bus Timing, 8-Bit Mode, Outputs (DCLK output as reference) | 89 |
| 7-35 | P-Bus as Outputs, 16-Bit Mode, (DCLK output as reference) | 90 |
| 7-36 | P-Bus as Inputs, 16-Bit Mode, Clock Mode 1 (DCLK input as reference) | 91 |
| 7-37 | P-Bus as Inputs, 16-Bit Mode, Clock Mode 2 (DCLK input as reference) | 92 |
| 7-38 | P-Bus as Inputs, 16-Bit Mode (DCLK output as reference) | 93 |
| 7-39 | DCLK as Input | 94 |
| 7-40 | Reset Timing | 95 |
| 7-41 | Horizontal Period (NTSC) (CL-GD5425 only) | 96 |
| 7-42 | NTSC Vertical Retrace (CL-GD5425 only) | 97 |
| 7-43 | NTSC Vertical Blanking Detail (CL-GD5425 only) | 98 |
| 7-44 | Horizontal Period (PAL) (CL-GD5425 only) | 99 |
| 7-45 | PAL Vertical Retrace (CL-GD5425 only) | 100 |

Table 7-1. I/O Write Timing (ISA Bus)^a

| Symbol | Parameter | MIN | MAX | Units |
|--------|--|-----|-----|-------|
| t_1 | Address, SBHE* setup to IOW* active | 5 | — | ns |
| t_2 | IOW* pulse width | 40 | — | ns |
| t_3 | Data setup to IOW* inactive | 5 | — | ns |
| t_4 | Data hold from IOW* inactive | 10 | — | ns |
| t_5 | Address, SBHE* hold from IOW* inactive | 5 | — | ns |
| t_6 | IOW* inactive to any command active | 80 | — | ns |

^a AEN must be inactive.

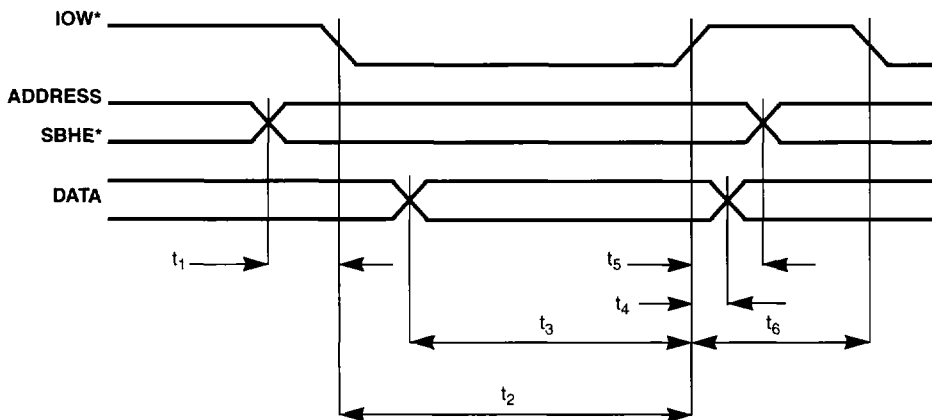

Figure 7-1. I/O Write Timing (ISA Bus)

Table 7-2. I/O Read Timing (ISA Bus)^a

| Symbol | Parameter | MIN | MAX | Units |
|--------|--|-----|-----|-------|
| t_1 | Address, SBHE* setup to IOR* active | 5 | — | ns |
| t_2 | IOR* active to low-impedance delay | 0 | — | ns |
| t_3 | Data delay from IOR* active (IOR* access time) | — | 60 | ns |
| t_4 | IOR* pulse width | 70 | — | ns |
| t_5 | Data hold from IOR* inactive | 0 | 20 | ns |
| t_6 | Address, SBHE* hold from IOR* inactive | 0 | — | ns |
| t_7 | IOR* inactive to high-impedance delay | 0 | 20 | ns |

^a AEN must be inactive.

Figure 7-2. I/O Read Timing (ISA Bus)

Table 7-3. Memory Write Timing (ISA Bus)

| Symbol | Parameter | MIN | MAX | Units |
|--------|--|-----|-----|----------------|
| t_1 | Address, SBHE* to SMEMW* active setup | 5 | – | ns |
| t_2 | SMEMW* pulse width | 3 | – | m ^a |
| t_3 | Data valid from SMEMW* active | – | 3 | m |
| t_4 | Data hold from SMEMW* inactive | 10 | – | ns |
| t_5 | Address, SBHE* hold from SMEMW* inactive | 0 | – | ns |
| t_6 | SMEMW* inactive to next SMEMW* | 3 | – | m |

^a m = MCLK period.

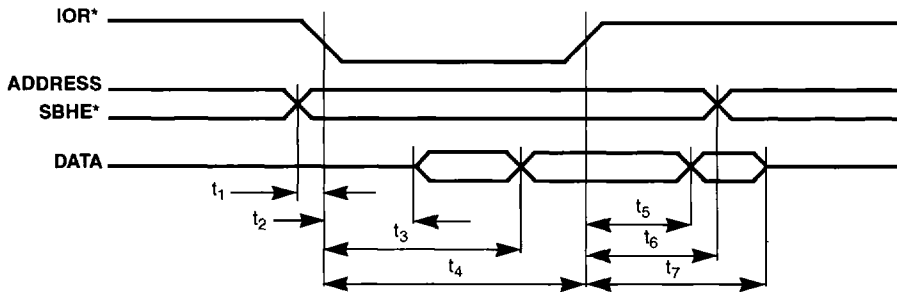
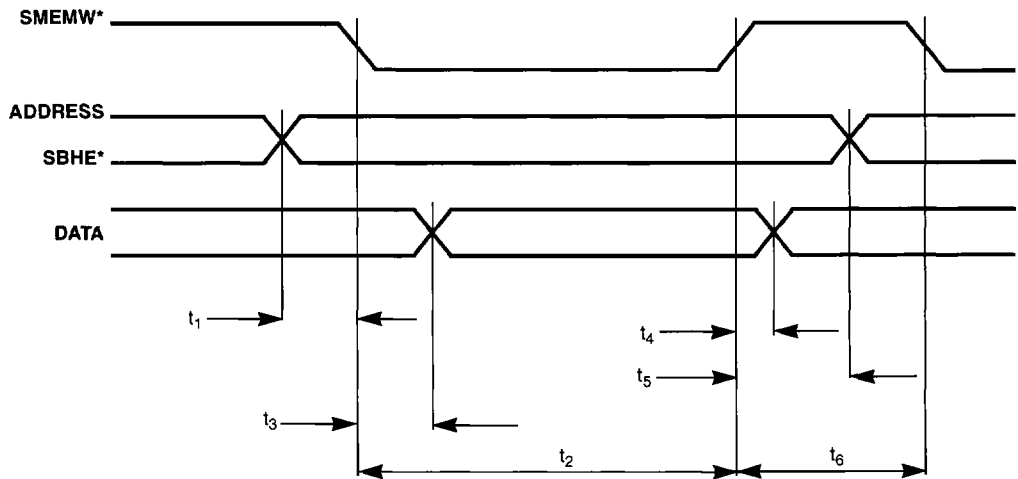

Figure 7-3. Memory Write Timing (ISA Bus)

Table 7-4. Memory Read Timing (ISA Bus)

| Symbol | Parameter | MIN | MAX | Units |
|--------|--|-----|-----|-------|
| t_1 | Address, SBHE* to SMEMR* active | 5 | – | ns |
| t_2 | SMEMR* active to low-impedance delay | 0 | – | ns |
| t_3 | Data delay from IOCHRDY active | – | 15 | ns |
| t_4 | SMEMR* pulse width | – | a | ns |
| t_5 | Data hold from SMEMR* inactive | 0 | 20 | ns |
| t_6 | Address, SBHE* hold from SMEMR* inactive | 0 | – | ns |
| t_7 | SMEMR* inactive to high-impedance delay | – | 20 | ns |

^a SMEMR* active-pulse width is determined by IOCHRDY.

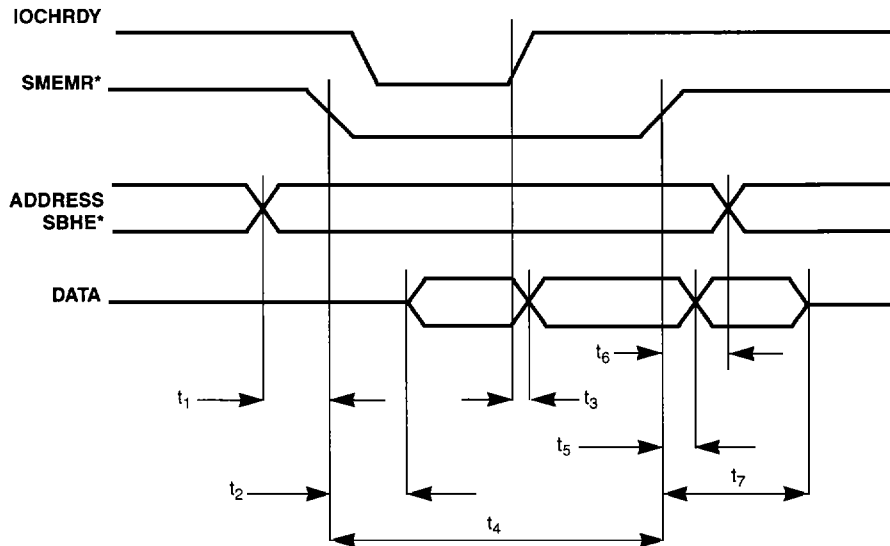

Figure 7-4. Memory Read Timing (ISA Bus)

Table 7-5. MCS16* Timing (ISA Bus)

| Symbol | Parameter | MIN | MAX | Units |
|----------|--|-----|-----|-------|
| t_{1a} | MCS16* active delay from LA[23:17] valid | - | 20 | ns |
| t_{1b} | MCS16* active delay from SA[16:15] valid | - | 14 | ns |
| t_2 | MCS16* inactive delay from address invalid | - | 25 | ns |

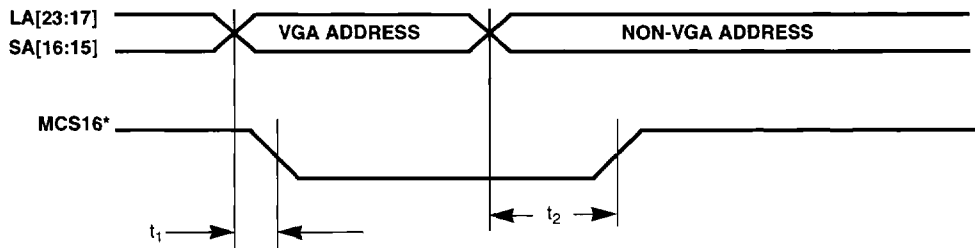

Figure 7-5. MCS16* Timing (ISA Bus)

Table 7-6. IOCS16* Timing (ISA Bus)

| Symbol | Parameter | MIN | MAX | Units |
|--------|-------------------------------------|-----|-----|-------|
| t_1 | IOCS16* active delay from address | - | 25 | ns |
| t_2 | IOCS16* inactive delay from address | - | 30 | ns |

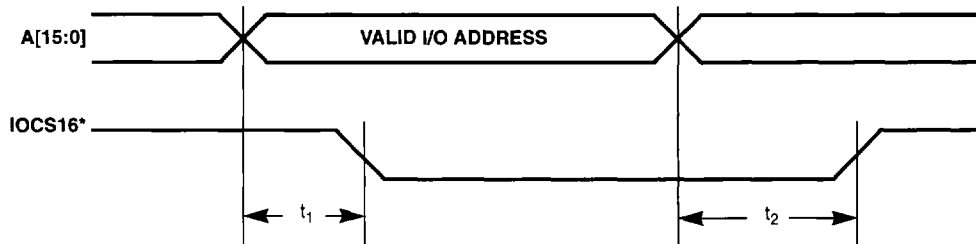

Figure 7-6. IOCS16* Timing (ISA Bus)

Table 7-7. BALE Timing (ISA Bus)

| Symbol | Parameter | MIN | MAX | Units |
|--------|--|-----|-----|-------|
| t_1 | LA[23:17] setup to BALE negative transition | 20 | — | ns |
| t_2 | SBHE* setup to BALE negative transition | 20 | — | ns |
| t_3 | LA[23:17] hold from BALE negative transition | 20 | — | ns |
| t_4 | SBHE* hold from BALE negative transition | 20 | — | ns |
| t_5 | BALE pulse width | 20 | — | ns |

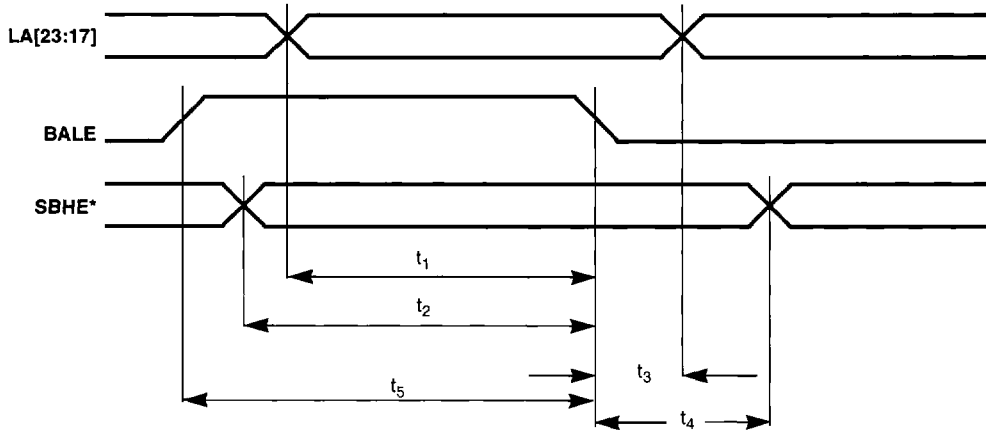

Figure 7-7. BALE Timing (ISA Bus)

Table 7-8. IOCHRDY for Memory Access Timing (ISA Bus)

| Symbol | Parameter | MIN | MAX | Units |
|--------|---|-----|-----|-------|
| t_1 | SMEMR* or SMEMW* active to IOCHRDY inactive low | - | 28 | ns |
| t_2 | IOCHRDY inactive low pulse width | 10 | a | ns |

^a Video mode dependent.

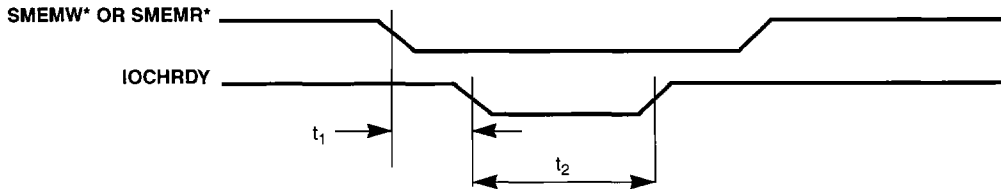

Figure 7-8. IOCHRDY for Memory Access Timing (ISA Bus)

Table 7-9. OWS* Timing (ISA Bus)

| Symbol | Parameter | MIN | MAX | Units |
|----------|--|-----|-----|-------|
| t_{1a} | OWS* active delay from SMEMR* (BIOS ACCESS) | - | 22 | ns |
| t_{1b} | OWS* active delay from SMEMW* (display memory write) | - | 18 | ns |
| t_{2a} | OWS* high-impedance delay from SMEMR* | - | 18 | ns |
| t_{2b} | OWS* high-impedance delay from SMEMW* | - | 19 | ns |

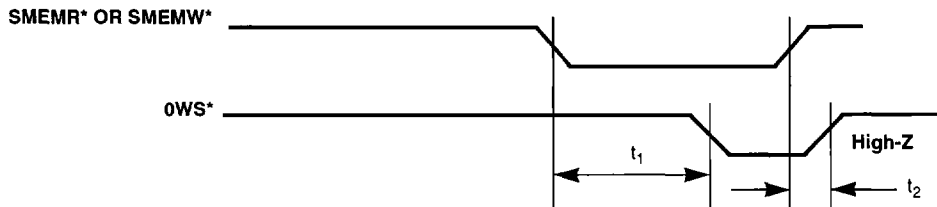
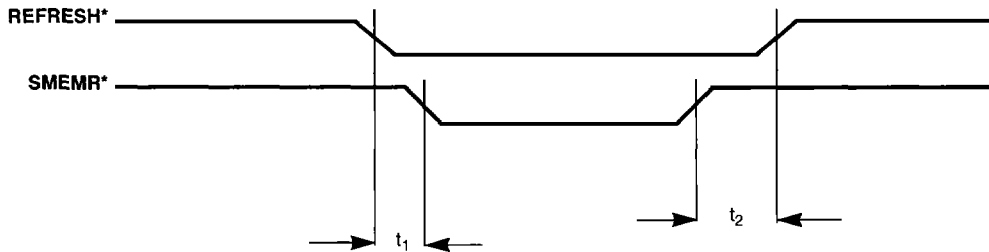

Figure 7-9. OWS* Timing (ISA Bus)

Table 7-10. Refresh Timing (ISA Bus)

| Symbol | Parameter | MIN | MAX | Units |
|--------|---|-----|-----|-------|
| t_1 | REFRESH* active setup to SMEMR* active | 20 | — | ns |
| t_2 | REFRESH* active hold from SMEMR* active | 0 | — | ns |

Figure 7-10. Refresh Timing (ISA Bus)
Table 7-11. EROM* Timing (ISA Bus)

| Symbol | Parameter | MIN | MAX | Units |
|--------|---|-----|-----|-------|
| t_1 | EROM* active delay from SMEMR* active | — | 30 | ns |
| t_2 | EROM* inactive delay from SMEMR* inactive | — | 20 | ns |

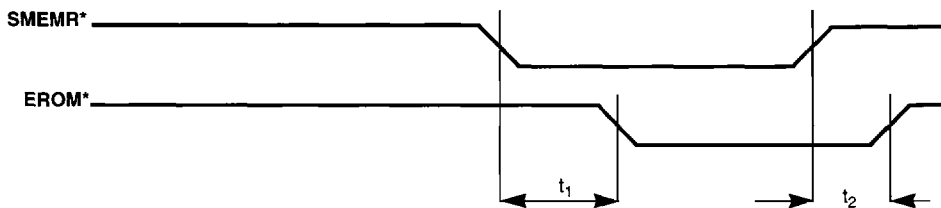

Figure 7-11. EROM* Timing (ISA Bus)

Table 7-12. AEN Timing (ISA Bus)^a

| Symbol | Parameter | MIN | MAX | Units |
|--------|-------------------------------------|-----|-----|-------|
| t_1 | AEN setup to IOR* or IOW* active | 5 | – | ns |
| t_2 | AEN hold from IOR* or IOW* inactive | 5 | – | ns |

^a AEN high, as shown below, will cause the CL-GD542X to **ignore** the I/O cycle.

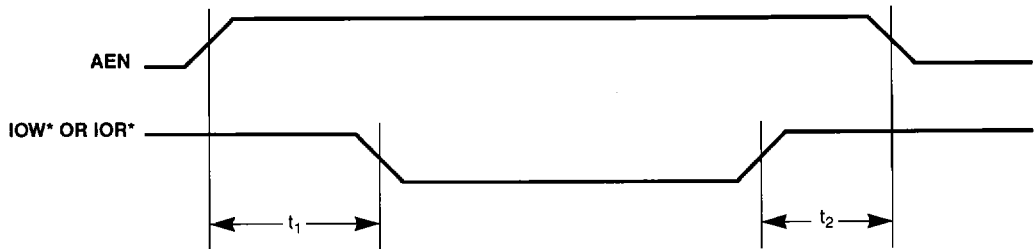

Figure 7-12. AEN Timing (ISA Bus)

Table 7-13. Write Timing (MicroChannel® Bus)

| Symbol | Parameter | MIN | MAX | Units |
|----------|--|-----|-----|-------|
| t_1 | Data to -CMD active setup | -15 | - | ns |
| t_{2a} | -CMD active pulse width (default cycle) | 90 | - | ns |
| t_{2b} | -CMD active pulse width (synchronous extended cycle) | 190 | - | ns |
| t_{2c} | -CMD active pulse width (asynchronous extended cycle) | a | a | ns |
| t_3 | Data hold from -CMD inactive | 0 | - | ns |
| t_4 | CD_CHRDY active to -CMD inactive delay | 0 | - | ns |

^a The maximum t_{2c} depends on display memory activity.

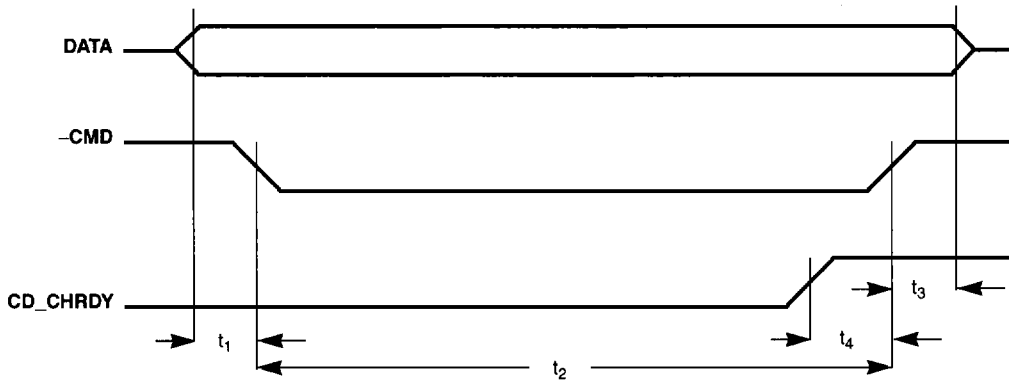

Figure 7-13. Write Timing (MicroChannel® Bus)

Table 7-14. Read Timing (MicroChannel® Bus)

| Symbol | Parameter | MIN | MAX | Units |
|--------|--|-----|-----|-------|
| t_1 | -CMD active to DATA valid delay (default cycle) (I/O read) | - | 45 | ns |
| t_2 | CD_CHRDY active to DATA valid delay (memory read cycle) | - | 45 | ns |
| t_3 | READ DATA hold from -CMD inactive | 0 | - | ns |
| t_4 | READ DATA high-impedance from -CMD inactive | - | 30 | ns |

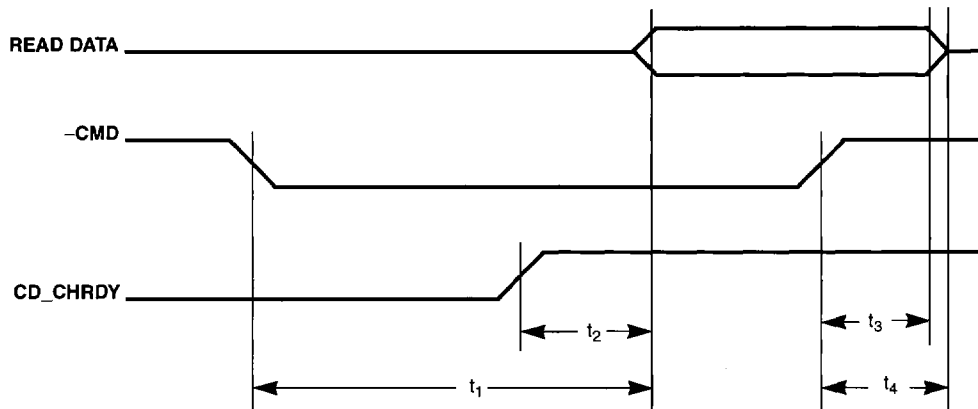

Figure 7-14. Read Timing (MicroChannel® Bus)

Table 7-15. -CD_DS16 Timing (MicroChannel® Bus)

| Symbol | Parameter | MIN | MAX | Units |
|--------|---|-----|-----|-------|
| t_1 | -CD_DS16 active from address, M-/IO, MADE24 valid | 0 | 50 | ns |

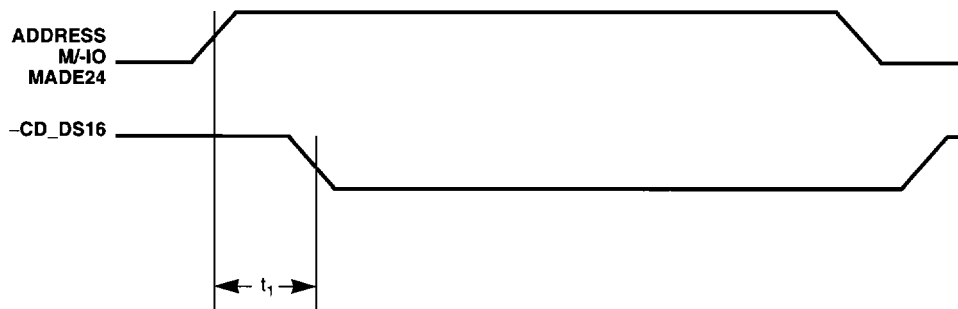

Figure 7-15. -CD_DS16 Timing (MicroChannel® Bus)

Table 7-16. -CMD Timing (MicroChannel® Bus)

| Symbol | Parameter | MIN | MAX | Units |
|--------|--------------------------------------|-----|-----|-------|
| t_1 | Address valid setup to -CMD active | 80 | — | ns |
| t_2 | Status active setup to -CMD active | 50 | — | ns |
| t_3 | -SBHE valid setup to -CMD active | 35 | — | ns |
| t_4 | -CMD pulse width | 90 | — | ns |
| t_5 | Address, -SBHE hold from -CMD active | 25 | — | ns |
| t_6 | Status hold from -CMD active | 25 | — | ns |

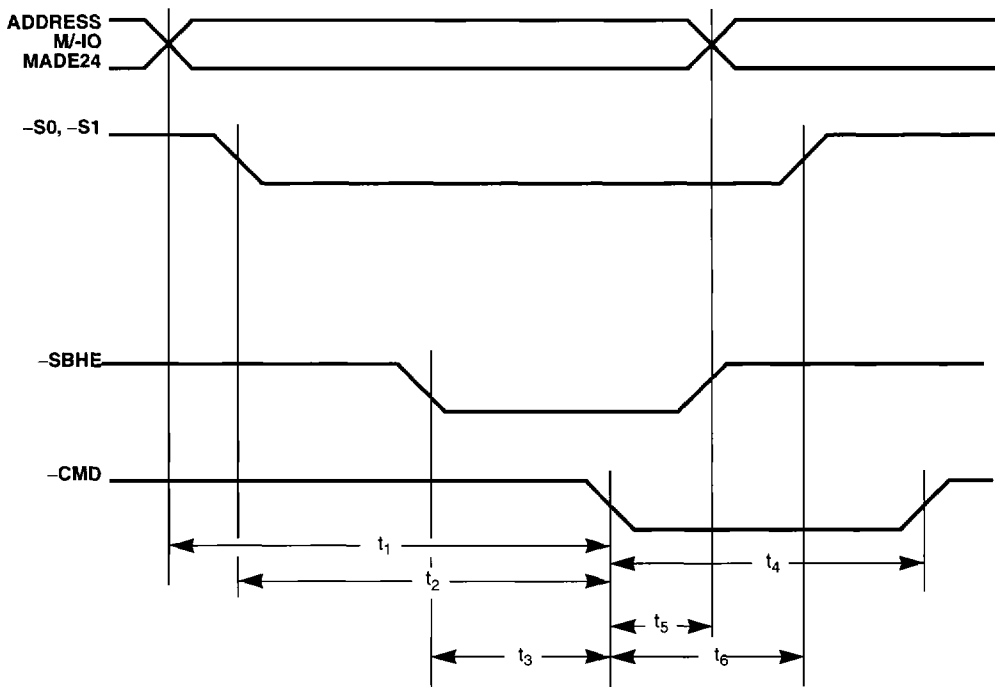

Figure 7-16. -CMD Timing (MicroChannel® Bus)

Table 7-17. CD_CHRDY Timing (MicroChannel® Bus)

| Symbol | Parameter | MIN | MAX | Units |
|--------|--|-----|-----|-------|
| t_1 | CD_CHRDY inactive (low) from Address valid | – | 50 | ns |
| t_2 | CD_CHRDY inactive (low) from Status active | – | 25 | ns |
| t_3 | CD_CHRDY inactive (low) pulse width | – | 3.5 | ms |

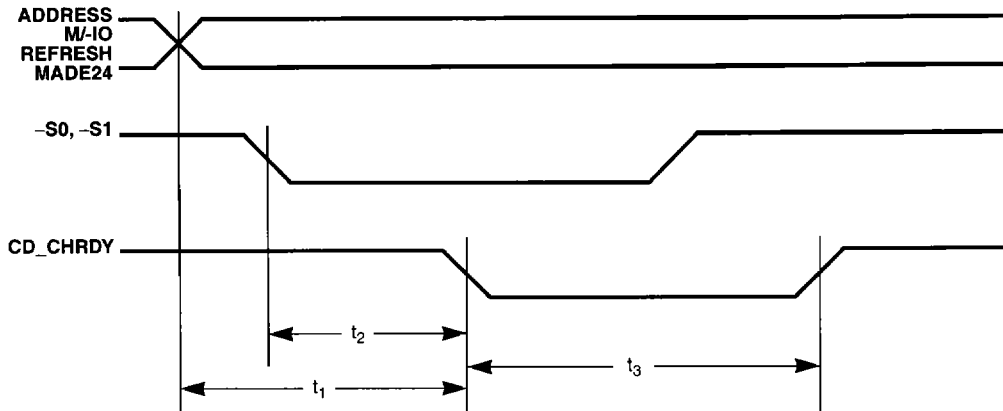

Figure 7-17. CD_CHRDY Timing (MicroChannel® Bus)

Table 7-18. -REFRESH Timing (MicroChannel® Bus)

| Symbol | Parameter | MIN | MAX | Units |
|--------|----------------------------------|-----|-----|-------|
| t_1 | -REFRESH setup to -Status active | 5 | - | ns |
| t_2 | -REFRESH setup to -CMD active | 40 | - | ns |
| t_3 | -REFRESH hold from -CMD active | 25 | - | ns |

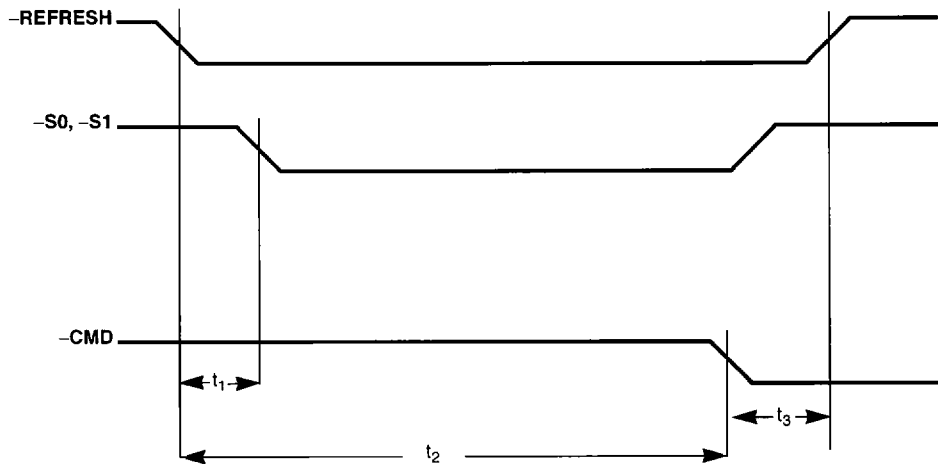
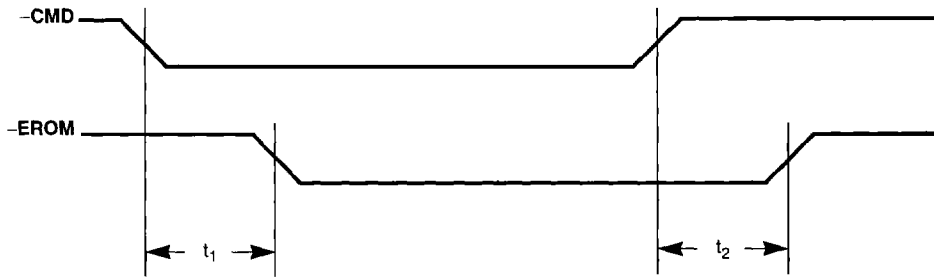

Figure 7-18. -REFRESH Timing (MicroChannel® Bus)

Table 7-19. -EROM Timing (MicroChannel® Bus)

| Symbol | Parameter | MIN | MAX | Units |
|--------|---------------------------------|-----|-----|-------|
| t_1 | -CMD active to -EROM active | - | 30 | ns |
| t_2 | -CMD inactive to -EROM inactive | 0 | 30 | ns |

Figure 7-19. -EROM Timing (MicroChannel® Bus)
Table 7-20. -CD_SFDBK Timing (MicroChannel® Bus)

| Symbol | Parameter | MIN | MAX | Units |
|--------|--|-----|-----|-------|
| t_1 | Address, M/-IO, MADE24 valid to -CD_SFDBK active delay | - | 55 | ns |
| t_2 | Address, M/-IO, MADE24 invalid to -CD_SFDBK inactive delay | 0 | - | ns |

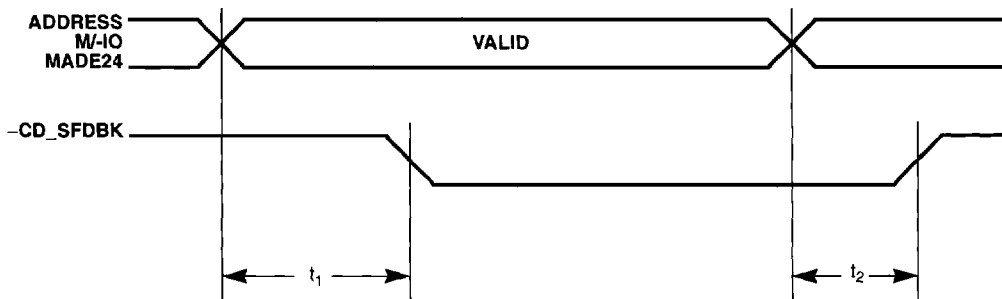

Figure 7-20. -CD_SFDBK Timing (MicroChannel® Bus)

Table 7-21. -CD_SETUP Timing (MicroChannel® Bus)

| Symbol | Parameter | MIN | MAX | Units |
|--------|--|-----|-----|-------|
| t_1 | -CD_SETUP active setup to -CMD active | 10 | - | ns |
| t_2 | -CD_SETUP delay to CD_CHRDY inactive | - | 95 | ns |
| t_3 | -CMD active to -CD_SETUP inactive hold | 25 | - | ns |

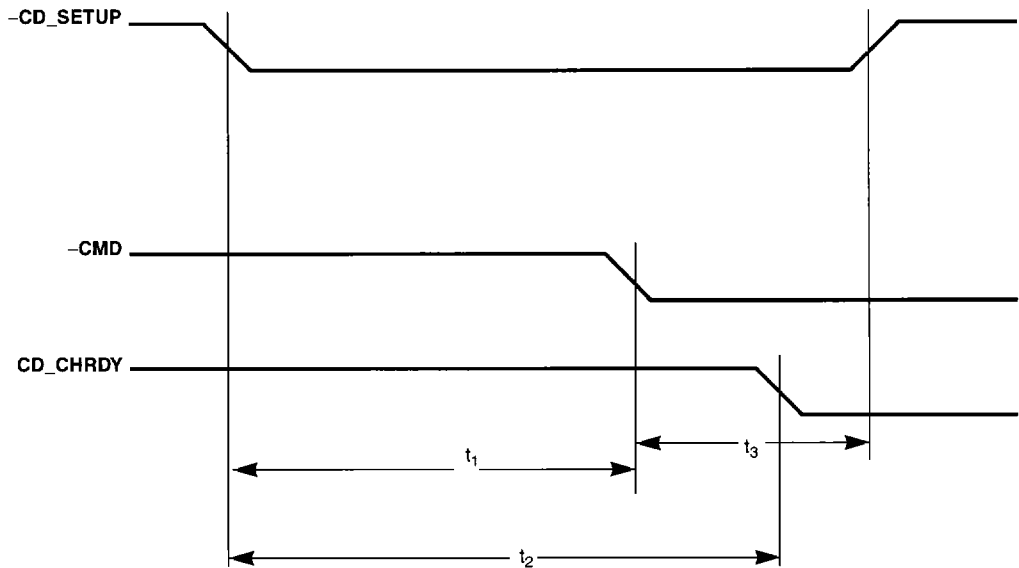

Figure 7-21. -CD_SETUP Timing (MicroChannel® Bus)

Table 7-22. CLK1X, CLK2X Timing (Local Bus)

| Symbol | Parameter | MIN | MAX | Units |
|--------|--|------|-----|---------|
| t_1 | Rise time (CLK1X) '486 ($V_{IL} - V_{IH}$) | – | 4 | ns |
| t_2 | Fall time (CLK1X) '486 ($V_{IH} - V_{IL}$) | – | 4 | ns |
| t_3 | High period (CLK1X) '486 ($V_{IH} - V_{IH}$) | 40 | 60 | % t_5 |
| t_4 | Low period (CLK1X) '486 ($V_{IL} - V_{IL}$) | 40 | 60 | % t_5 |
| t_5 | Period (CLK1X) '486 | 25 | – | ns |
| t_5 | Period (CLK1X) '486 (CL-GD5429) | 20 | – | ns |
| t_1 | Rise time (CLK2X) '386 ($V_{IL} - V_{IH}$) | – | 4 | ns |
| t_2 | Fall time (CLK2X) '386 ($V_{IH} - V_{IL}$) | – | 4 | ns |
| t_3 | High period (CLK2X) '386 ($V_{IH} - V_{IH}$) | 40 | 60 | % t_5 |
| t_4 | Low period (CLK2X) '386 ($V_{IL} - V_{IL}$) | 40 | 60 | % t_5 |
| t_5 | Period (CLK2X) '386 | 12.5 | – | ns |

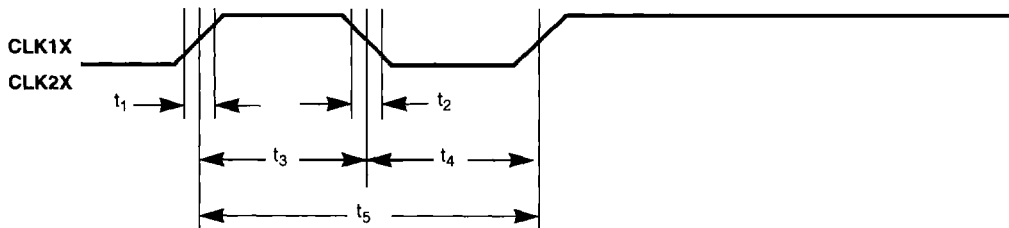

Figure 7-22. CLK1X, CLK2X Timing (Local Bus)

Table 7-23. RESET Timing (Local Bus)^a

| Symbol | Parameter | MIN | MAX | Units |
|--------|--------------------------------|-----|-----|-------|
| t_1 | CPU_RESET hold time from CLK2X | 10 | – | ns |
| t_2 | CPU_RESET setup time to CLK2X | 2 | – | ns |

^a Applies to '386 only. For '486, pin 46 must be tied to ground. For VESA VL-Bus, pin 46 must be tied to RDYRTN#.

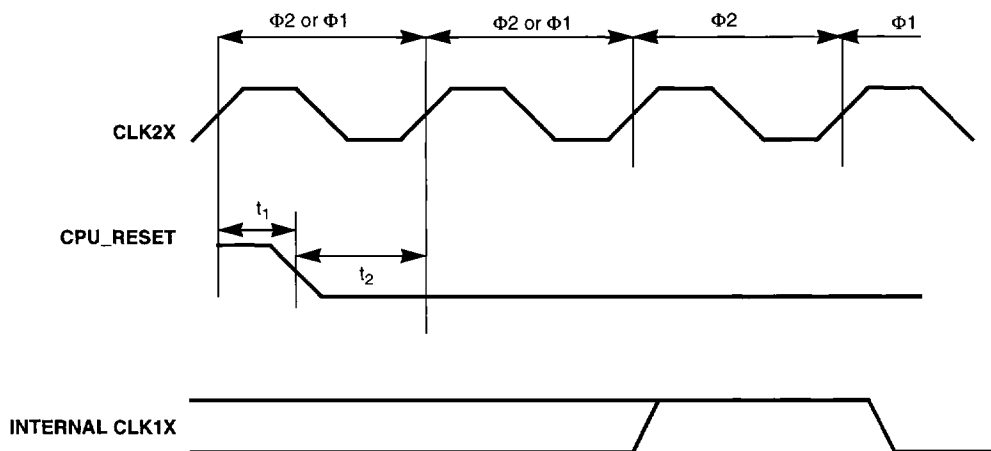

Figure 7-23. RESET Timing (Local Bus)

Table 7-24. ADS#, LBA#, BS16# Timing (Local Bus)

| Symbol | Parameter | MIN '24/'26/'28 | MAX '24/'26/'28 | MIN '29 | MAX '29 | Units |
|--------|--|--------------------|--------------------|------------|------------|-------|
| t_1 | Address, Status, ADS# setup to CLK1X | 8 | – | 4 | – | ns |
| t_2 | LBA#/LDEV# active delay from Address, Status | – | 15 | – | 15 | ns |
| t_3 | BS16# active delay CLK1X | – | 15 | – | 3 | ns |
| t_4 | LBA# inactive delay from Address, Status | – | 18 | – | 18 | ns |

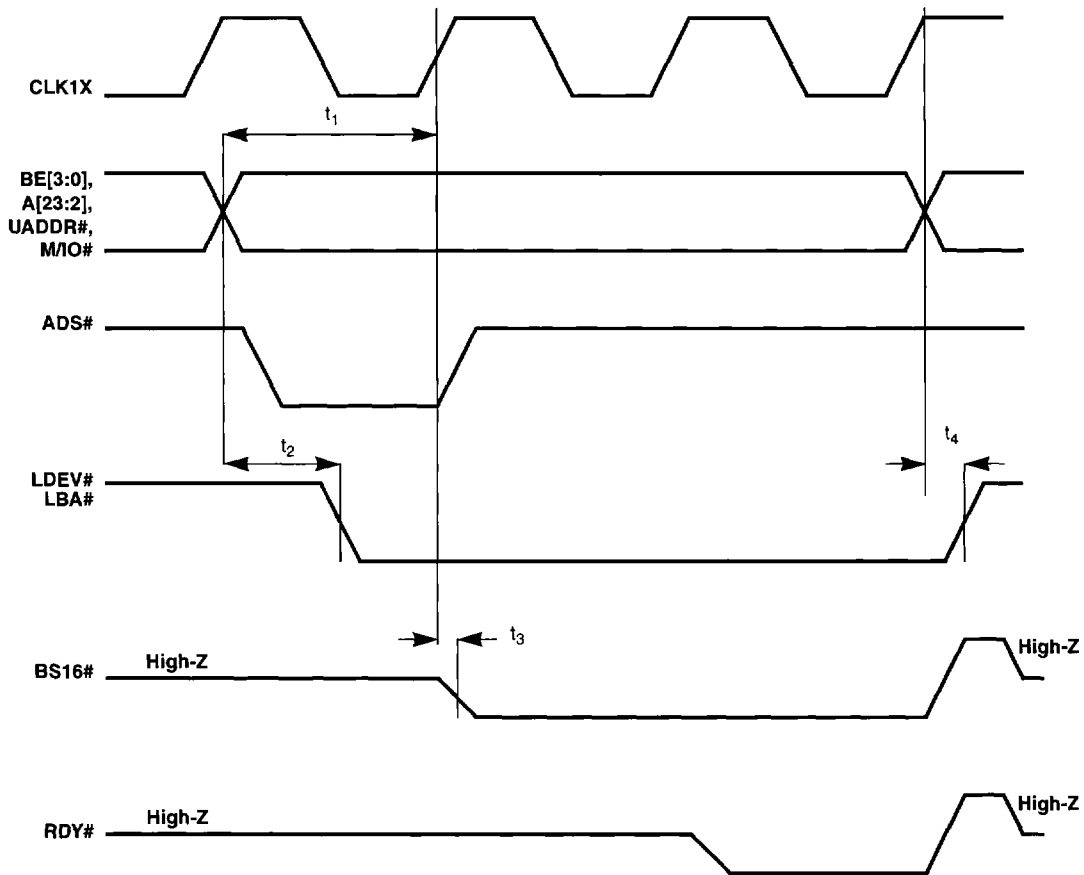

Figure 7-24. ADS#, LBA#, BS16# Timing (Local Bus)

Table 7-25. RDY# Delay (Local Bus)

| Symbol | Parameter | MIN | MAX | Units |
|--------|--------------------------------|-----|-----|-------|
| t_1 | RDY# active delay from CLK1X | 3 | 13 | ns |
| t_2 | RDY# inactive delay from CLK1X | - | 23 | ns |
| t_3 | RDY# high before High-Z | - | 1/2 | CLK1X |

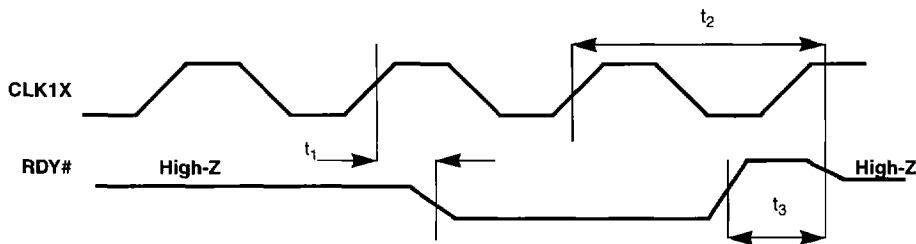

Figure 7-25. RDY# Delay (Local Bus)

Table 7-26. Read Data Timing (Local Bus)

| Symbol | Parameter | MIN '24/'26/'28 | MAX '24/'26/'28 | MIN '5429 | MAX '5429 | Units |
|--------|-----------------------------------|--------------------|--------------------|--------------|--------------|-------|
| t_1 | Read data setup to RDY# active | 0 | – | 0 | – | ns |
| t_2 | Read data hold from RDY# inactive | 12 | – | 12 | – | ns |
| t_3 | RDYRTN# setup to CLK1X | 8 | – | 5 | – | ns |
| t_4 | RDYRTN# hold from CLK1X | 5 | – | 2 | – | ns |

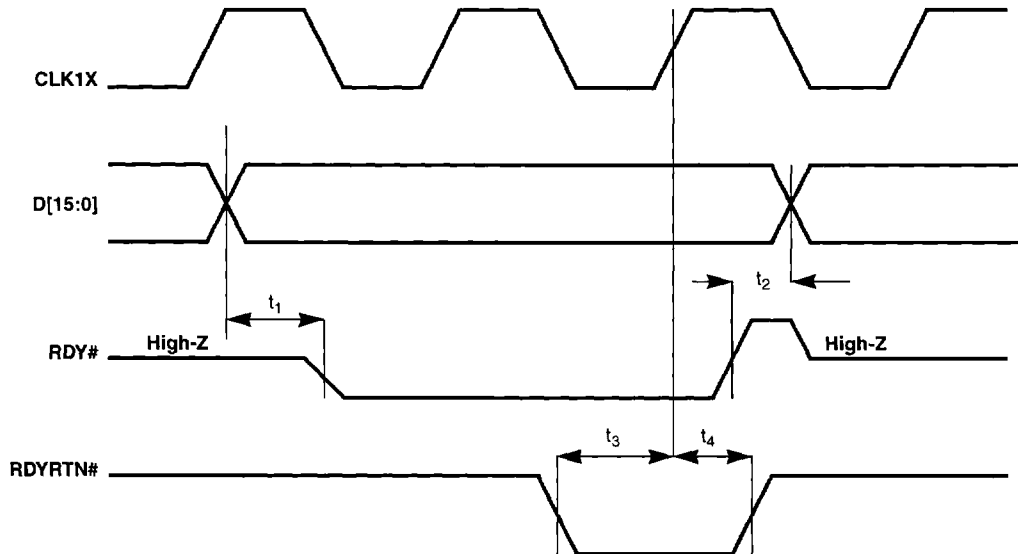
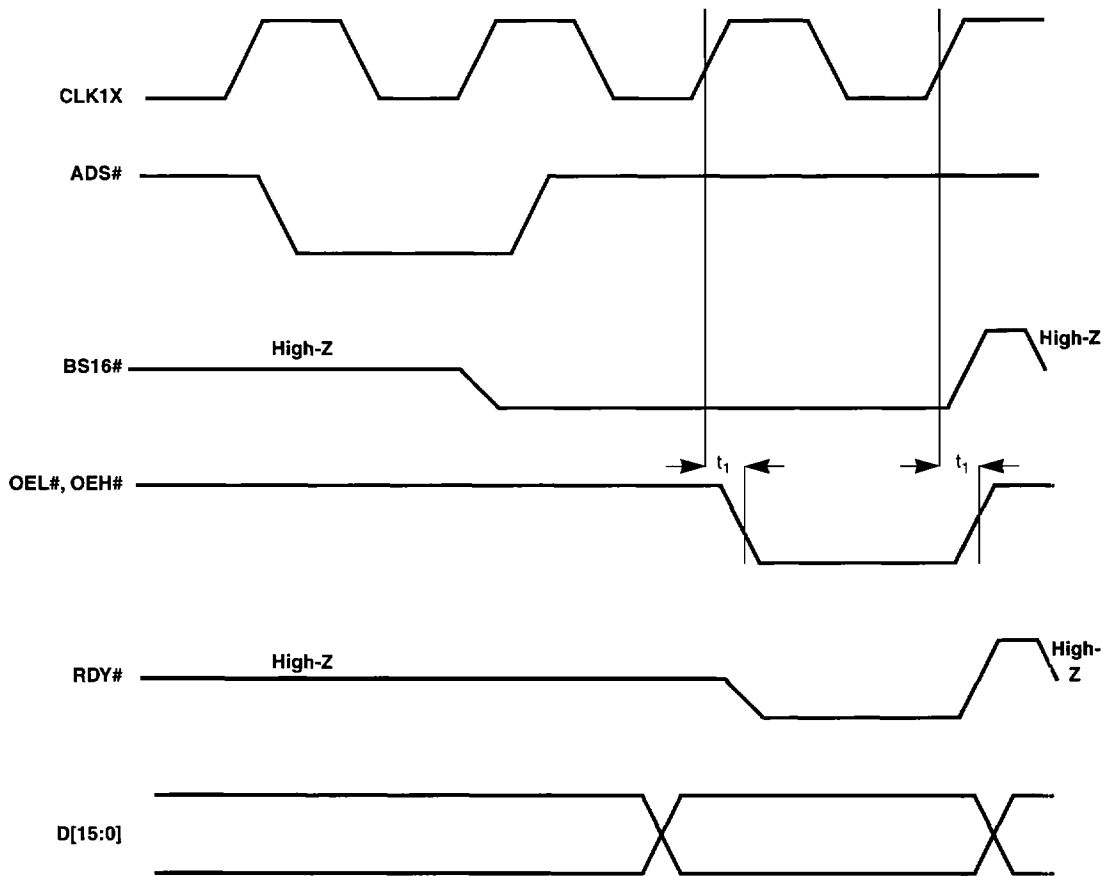

Figure 7-26. Read Data Timing (Local Bus)

Table 7-27. Buffer Control Timing – Read Cycle (Local Bus)

| Symbol | Parameter | MIN | MAX | Units |
|--------|------------------|-----|-----|-------|
| t_1 | OEL#, OEH# delay | 0 | 14 | ns |



NOTE: Both OEL# and OEH# are active for read cycles.

Figure 7-27. Buffer Control Timing – Read Cycle (Local Bus)

Table 7-28. Buffer Control Timing – Write Cycle (Local Bus)

| Symbol | Parameter | MIN | MAX | Units |
|--------|------------------|-----|-----|-------|
| t_1 | OEL#, OEH# delay | 0 | 14 | ns |

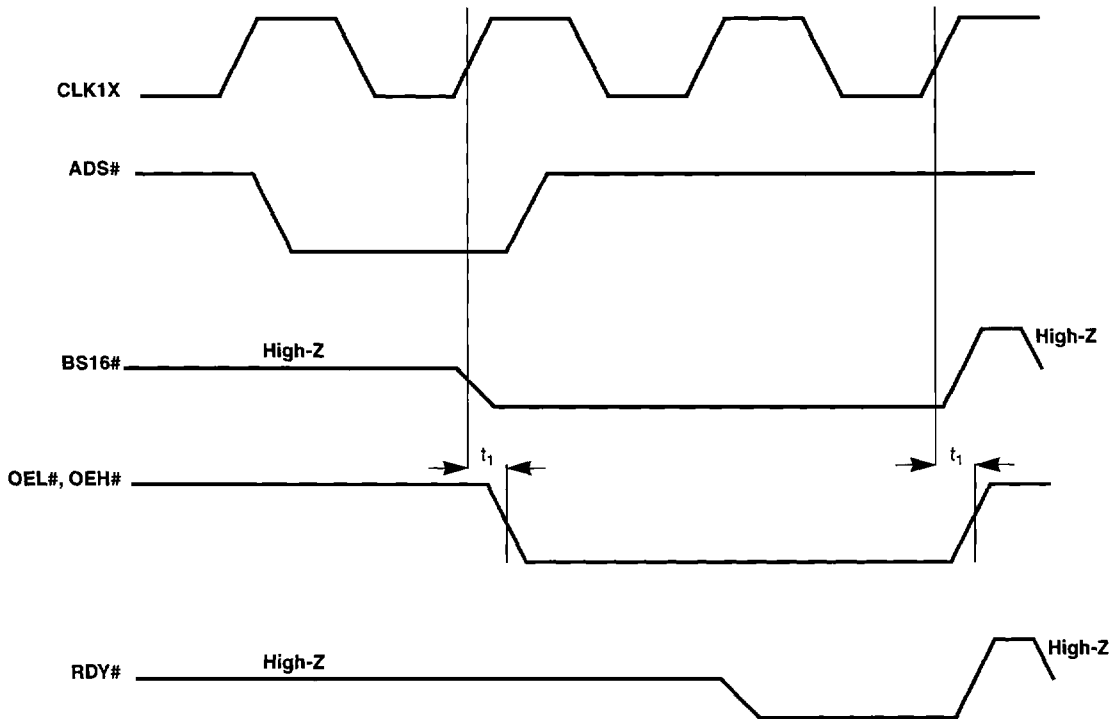

NOTE: Only one of OEL# and OEH# is active for write cycles.

Figure 7-28. Buffer Control Timing – Write Cycle (Local Bus)

Table 7-29. Display Memory Bus – Common Parameters

| Symbol | Parameter | MIN | MAX |
|-----------------|---|--------------------------|-----------|
| t ₁ | t _{ASR} : address setup to RAS* active | 1.5m ^a – 2 ns | – |
| t ₂ | t _{RAH} : row address hold from RAS* active | 1.5m | – |
| t ₃ | t _{ASC} : address setup to CAS* active | 1m – 1 ns | – |
| t ₄ | t _{CAH} : column address hold from CAS* active | 1m | – |
| t ₅ | t _{RCD} : RAS* active to CAS* active delay (standard RAS) | 2.5m – 2 ns | – |
| t ₅ | t _{RCD} : RAS* active to CAS* active delay (extended RAS) | 3m – 2 ns | – |
| t ₆ | t _{RAS} : RAS* pulse width low (standard RAS) | 3.5m | – |
| t ₆ | t _{RAS} : RAS* pulse width low (extended RAS) | 4m – 2 ns | – |
| t ₇ | t _{RP} : RAS* precharge (RAS* pulse width high — standard RAS) | 2.5 m – 2 ns | – |
| t ₇ | t _{RP} : RAS* precharge (RAS* pulse width high — extended RAS) | 3m | – |
| t ₈ | t _{CAS} : CAS* pulse width low | 1m + 3 ns | 1m + 6 ns |
| t ₉ | t _{CP} : CAS* precharge (CAS* pulse width high) | 1m – 6 ns | 1m – 3 ns |
| t ₁₀ | t _{RC} : Random cycle (standard RAS) | 6m | – |
| t ₁₀ | t _{RC} : Random cycle (extended RAS) | 7m | – |
| t ₁₁ | t _{PC} : Page mode cycle | 2m | – |

^a m = MCLK

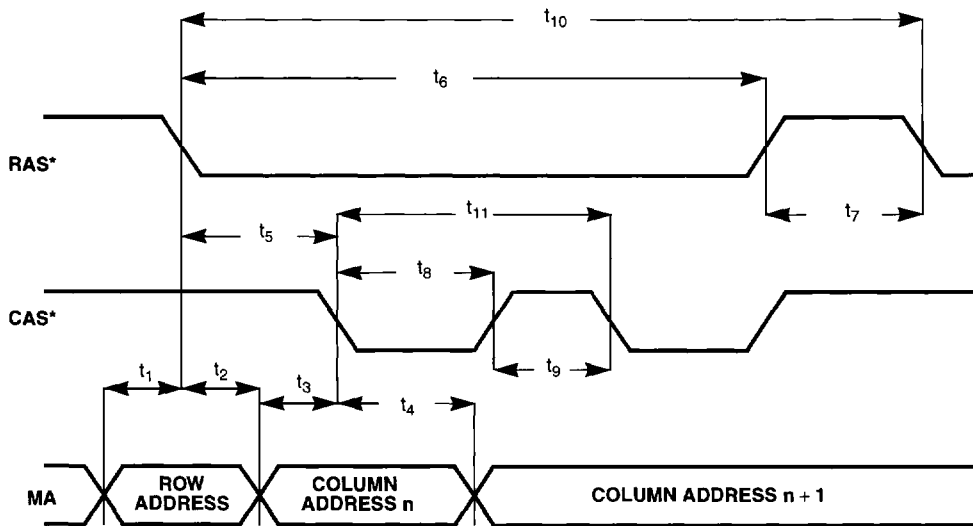

Figure 7-29. Display Memory Bus – Common Parameters

Table 7-30. Display Memory Bus – Read Cycles^a

| Symbol | Parameter | MIN | MAX |
|--------------------|--|-------|-------------|
| t_1 | Read data setup to CAS* rising edge | 0 | – |
| t_2 | Read data hold from CAS* high | 10 ns | – |
| t_3 ^b | RAS* active to first CAS* rising edge delay (standard RAS) | – | 4m – 1 ns |
| t_3 | RAS* active to first CAS* rising edge delay (extended RAS) | – | 4.5m – 1 ns |
| t_4 ^c | Column address valid to CAS* rising edge delay | – | 2m |
| t_5 ^d | CAS* active pulse width | – | 1m + 3 ns |
| t_6 ^e | CAS* period | – | 2m |

- ^a Only parameters t_1 and t_2 are defined for the device. The remaining parameters in this table are calculated from parameters in the Table 7-29. They are provided so that system designers can determine DRAM requirements.
- ^b Parameter t_3 corresponds to DRAM parameter t_{RAC} (access time from RAS*).
- ^c Parameter t_4 corresponds to DRAM parameter t_{AA} (access time from column address).
- ^d Parameter t_5 corresponds to DRAM parameter t_{CAC} (access time from CAS*).
- ^e Parameter t_6 corresponds to DRAM parameter t_{CAP} (access time from CAS* precharge).

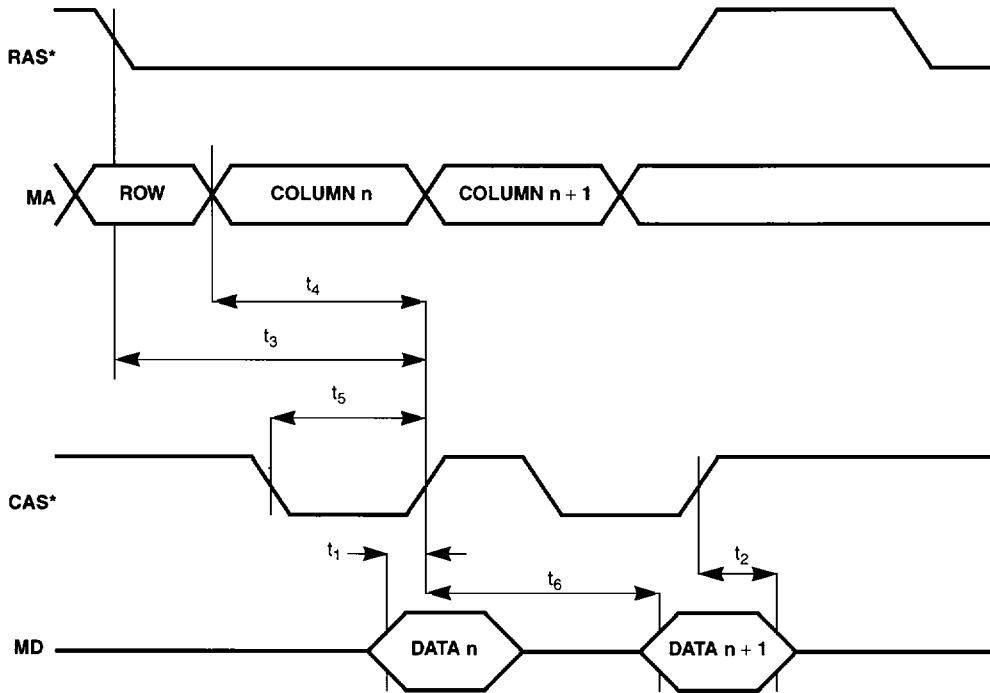

Figure 7-30. Display Memory Bus – Read Cycles

Table 7-31. Display Memory Bus – Write Cycles

| Symbol | Parameter | MIN | MAX |
|--------|---|-----------------------|---------------------|
| t_1 | t_{CWL} : WE* active setup to CAS* active | $1m^a + 2 \text{ ns}$ | – |
| t_2 | t_{DS} : Write data setup to CAS* active | $1m - 2 \text{ ns}$ | $1m + 2 \text{ ns}$ |
| t_3 | t_{DH} : write data hold from CAS* active | $1m + 1 \text{ ns}$ | – |
| t_4 | t_{WCH} : WE active hold from CAS* active | $1.5m$ | – |

^a $m = \text{MCLK}$

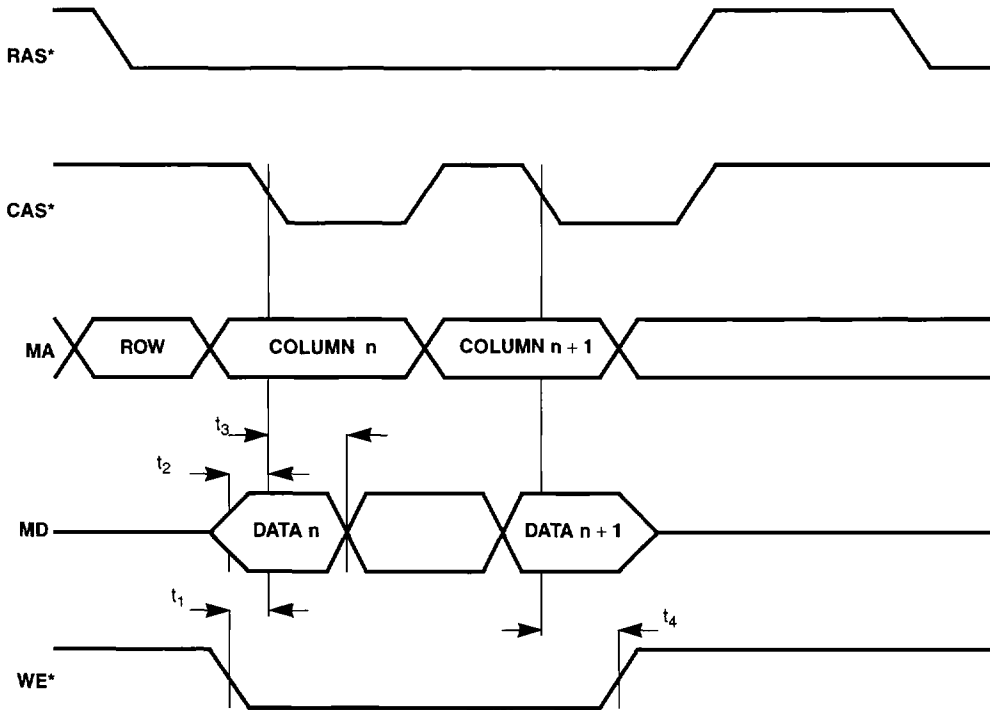

Figure 7-31. Display Memory Bus – Write Cycles

Table 7-32. CAS*-before-RAS* Refresh Timing (Display Memory Bus)^a

| Symbol | Parameter | MIN | MAX |
|--------|---|-----------------|-----|
| t_1 | t_{CSR} : CAS* active setup to RAS* active1 | 1m ^b | – |
| t_2 | t_{RAS} : RAS* low pulse width | 4m | – |
| t_3 | t_{RP} : RAS* high pulse width | 3m | – |

^a There will be either three or five RAS* pulses while CAS* remains low.

^b m = MCLK

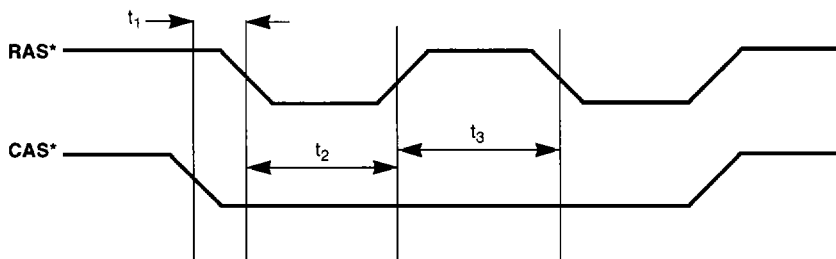
Figure 7-32. CAS*-before-RAS* Refresh Timing (Display Memory Bus)
Table 7-33. P-Bus as Inputs, 8-Bit Mode (DCLK input as reference)

| Symbol | Parameter | MIN | MAX | Units |
|--------|-------------------------------|-----|-----|-------|
| t_1 | P[7:0], BLANK* setup to DCLK | -1 | – | ns |
| t_2 | P[7:0], BLANK* hold from DCLK | 7 | – | ns |

NOTE: CL-GD542X RAMDAC driven externally

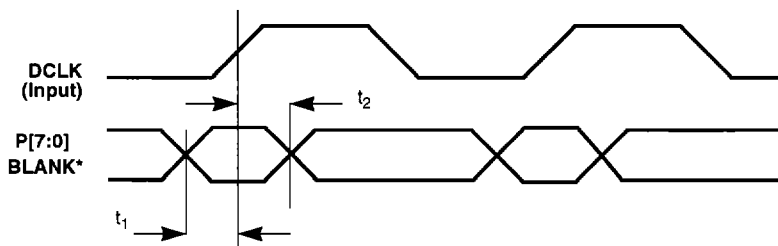

Figure 7-33. P-Bus as Inputs, 8-bit Mode (External DCLK)

Table 7-34. Feature Bus Timing, 8-Bit Mode, Outputs (DCLK output as reference)

| Symbol | Parameter | MIN | MAX | Units |
|--------|----------------------------|-----|-----|-------|
| t_1 | DCLK to BLANK* delay | -1 | 1 | ns |
| t_2 | DCLK to HSYNC, VSYNC delay | 1 | 3 | ns |
| t_3 | DCLK to P[7:0] delay | -2 | 0 | ns |
| t_4 | DCLK to OVRW delay | -1 | 1 | ns |

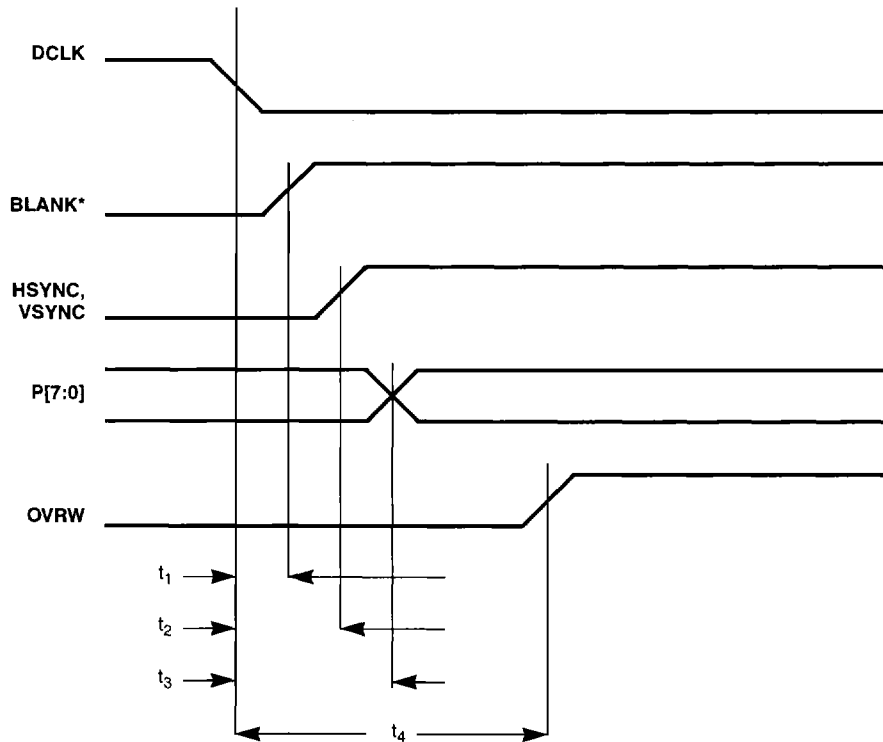

Figure 7-34. Feature Bus Timing, 8-Bit Mode, Outputs (Internal DCLK)

Table 7-35. P-Bus as Outputs, 16-bit Mode (DCLK output as reference) CL-GD5425/'28/'29 only^a

| Symbol | Parameter | MIN | MAX | Units |
|--------|-------------------------------------|-----|-----|-------|
| t_1 | DCLK (rising edge) to P[7:0] delay | -2 | 0 | ns |
| t_2 | DCLK (falling edge) to P[7:0] delay | -1 | 1 | ns |

^a SR7[2:1] is programmed to '0,1' and GRE[0] is programmed to '1'.

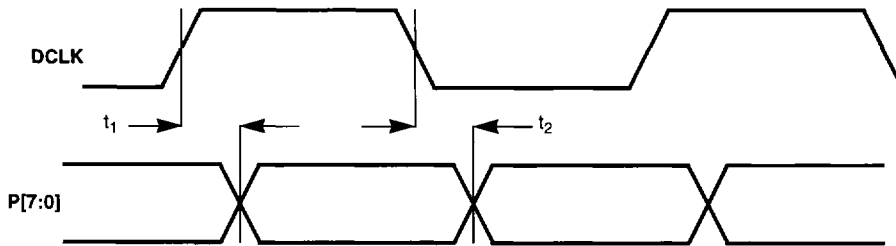

Figure 7-35. P-Bus as Outputs, 16-bit Mode (Internal DCLK) CL-GD5425/'28/'29 only

Table 7-36. P-Bus as Inputs, 16-Bit Mode, Clock Mode 1 (DCLK input as reference) ^a

| Symbol | Parameter | MIN '24/'26 | MIN '28 | MIN '25/'29 | Units |
|--------|--|-------------|---------|-------------|-------|
| t_1 | P[7:0] setup to DCLK (rising edge — external DCLK) | -1 | -1 | -3 | ns |
| t_2 | P[7:0] hold from DCLK (rising edge — external DCLK) | 5 | 5 | 7 | ns |
| t_3 | P[7:0] setup to DCLK (falling edge — external DCLK) | -1 | -1 | -3 | ns |
| t_4 | P[7:0] hold from DCLK (falling edge — external DCLK) | 5 | 5 | 7 | ns |

^a Clock mode 1 selected in Hidden DAC register (D5 programmed to '0').

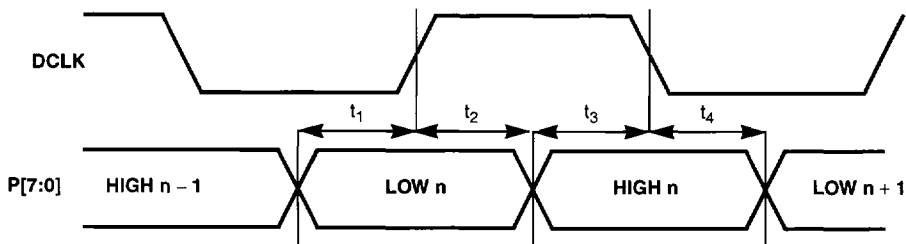

Figure 7-36. P-Bus as Inputs, 16-Bit Mode, Clock Mode 1 (External DCLK)

Table 7-37. P-Bus as Inputs, 16-Bit Mode, Clock Mode 2^a (DCLK input as reference)

| Symbol | Parameter | MIN '24/'26 | MIN '28 | MIN '25/'29 | Units |
|--------|---|----------------|------------|----------------|-------|
| t_1 | P[7:0], BLANK* ^b setup to DCLK | -1 | -2 | -2 | ns |
| t_2 | P[7:0], BLANK* hold from DCLK | 5 | 6 | 4 | ns |

^a Clock mode 2 selected in Hidden DAC register (D5 = '1').

^b The first low byte of 16-bit data input must be synchronized with BLANK* or the start of overlay window, whichever is later. The first high byte will be clocked on the next rising edge of DCLK.

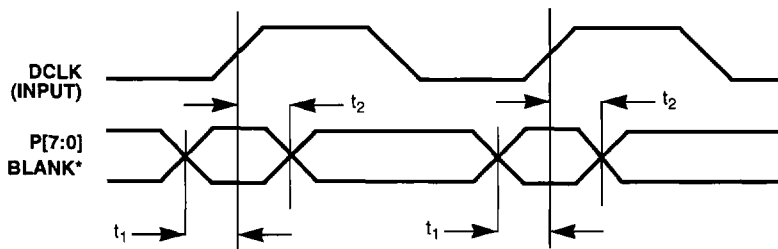

Figure 7-37. P-Bus as Inputs, 16-Bit Mode, Clock Mode 2 (External DCLK)

Table 7-38. P-Bus as Inputs, 16-Bit Mode (DCLK output as reference)^a

| Symbol | Parameter | MIN '24/'26 | MIN '28 | MIN '25/'29 | Units |
|--------|--|-------------|---------|-------------|-------|
| t_1 | P[7:0] setup to DCLK (rising edge — internal DCLK) | 3 | 2 | 3 | ns |
| t_2 | P[7:0] hold from DCLK (rising edge — internal DCLK) | 1 | 1 | 1 | ns |
| t_3 | P[7:0] setup to DCLK (falling edge — internal DCLK) | 3 | 2 | 3 | ns |
| t_4 | P[7:0] hold from DCLK (falling edge — internal DCLK) | 1 | 1 | 1 | ns |

^a Clock mode 1 selected in Hidden DAC register (D5 = '0').

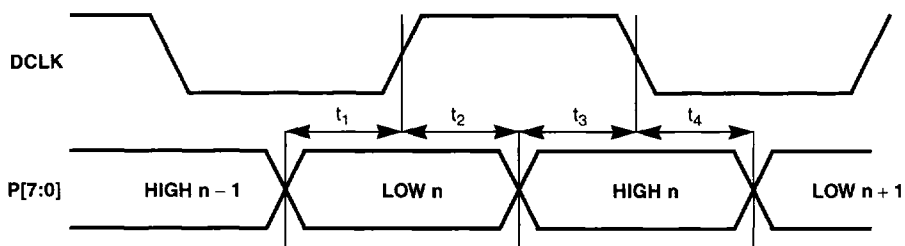

Figure 7-38. P-Bus as Inputs, 16-Bit Mode (External DCLK)

Table 7-39. DCLK as Input

| Symbol | Parameter: CL-GD5420/22/24/26/28 | MIN | MAX | Units |
|--------------------------------|----------------------------------|------|-----|------------|
| t_1 | Rise time | – | 3 | ns |
| t_2 | Fall time | – | 3 | ns |
| t_3 | High period | 40 | 60 | % of t_5 |
| t_4 | Low period | 40 | 60 | % of t_5 |
| t_5 | Period | 17 | – | ns |
| Parameter: CL-GD5425/29 | | | | |
| t_1 | Rise time | – | 3 | ns |
| t_2 | Fall time | – | 3 | ns |
| t_3 | High period: Clock mode 1 | 45 | 55 | % of t_5 |
| t_3 | High period: Clock mode 2 | 30 | 70 | % of t_5 |
| t_4 | Low period: Clock mode 1 | 45 | 55 | % of t_5 |
| t_4 | Low period: Clock mode 2 | 30 | 70 | % of t_5 |
| t_5 | Period (DCLK) | 12.5 | – | ns |

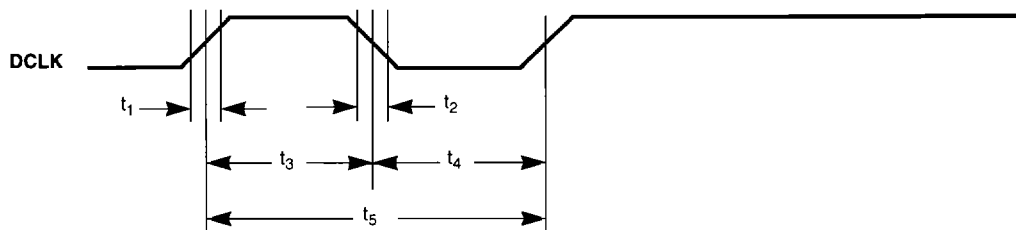

Figure 7-39. DCLK As Input

Table 7-40. RESET Timing

| Symbol | Parameter | MIN | MAX | Units |
|--------|--|-----|-----|-------|
| t_1 | RESET pulse width | 12 | – | MCLK |
| t_2 | MD[31:16] setup to RESET falling edge | 2 | – | ns |
| t_3 | MD[31:16] hold from RESET falling edge | 25 | – | ns |
| t_4 | RESET low to first IOW* | 12 | – | MCLK |

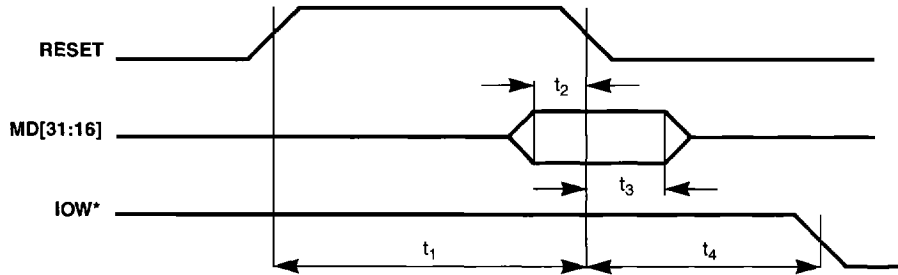

Figure 7-40. RESET Timing

Table 7-41. Horizontal Period (NTSC — CL-GD5425 only)

| Symbol | Parameter | Nominal | Units |
|--------|-------------------------|---------|------------------|
| t_1 | Horizontal period | 63.56 | $\mu\text{sec.}$ |
| t_2 | HSYNC pulse width (low) | 4.65 | $\mu\text{sec.}$ |

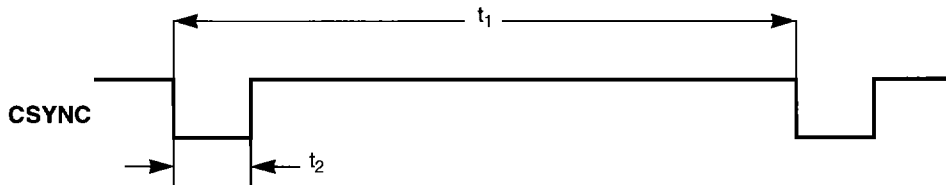

Figure 7-41. Horizontal Period (NTSC — CL-GD5425 only)

Table 7-42. NTSC Vertical Retrace (CL-GD5425 only)

| Symbol | Parameter | Nominal | Units |
|--------|--------------------------|---------|----------|
| t_1 | Vertical blanking period | 20 | H-period |

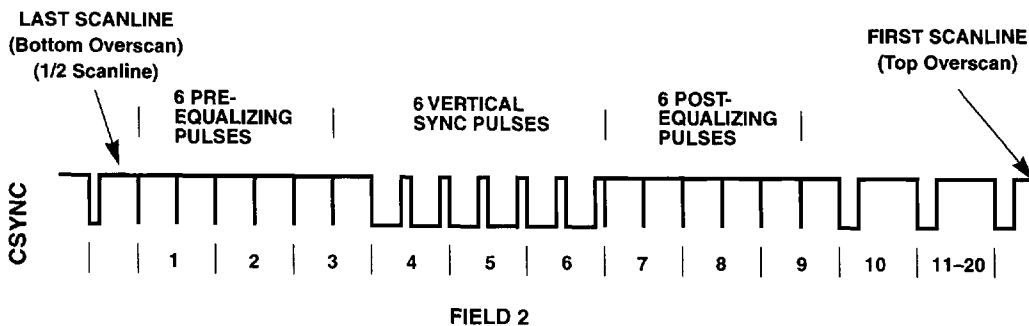
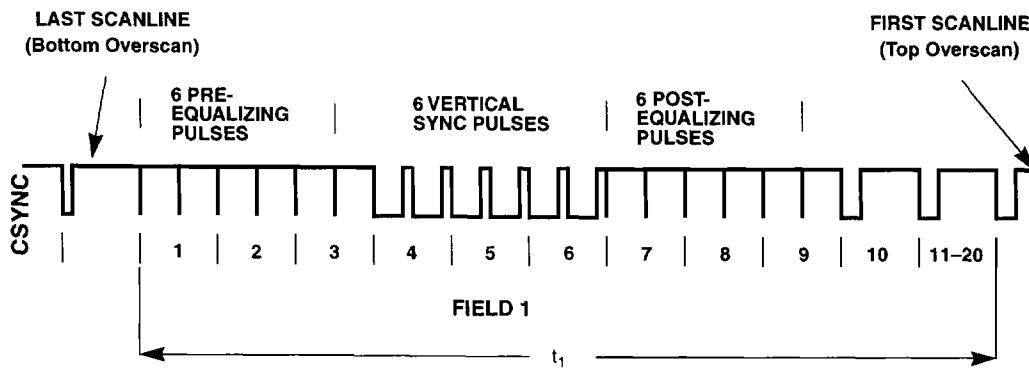

Figure 7-42. NTSC Vertical Retrace (CL-GD5425 only)

Table 7-43. NTSC Vertical Blanking Detail (CL-GD5425 only)

| Symbol | Parameter | Nominal | Units |
|--------|-------------------------------|---------|------------------|
| t_1 | Equalizing pulse width (low) | 2.32 | $\mu\text{sec.}$ |
| t_2 | Serrations pulse width (high) | 4.65 | $\mu\text{sec.}$ |
| t_3 | Equalization to serration | 1 | H-period |
| t_4 | First serration | 1/2 | H-period |

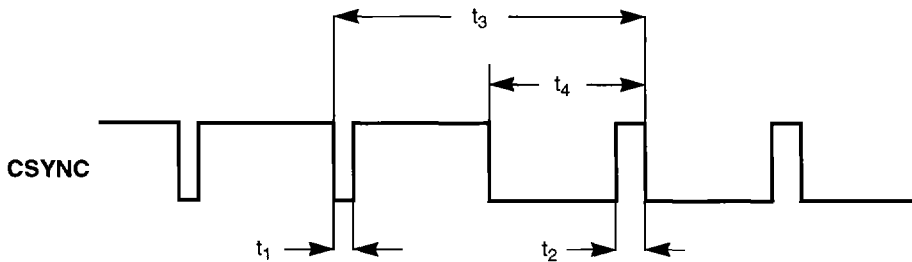

Figure 7-43. NTSC Vertical Blanking Detail (CL-GD5425 only)

Table 7-44. Horizontal Period (PAL — CL-GD5425 only)

| Symbol | Parameter | Nominal | Units |
|--------|-------------------------|---------|------------------|
| t_1 | Horizontal period | 64.00 | $\mu\text{sec.}$ |
| t_2 | HSYNC pulse width (low) | 4.65 | $\mu\text{sec.}$ |

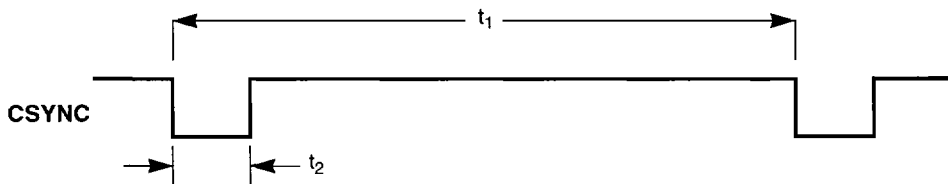
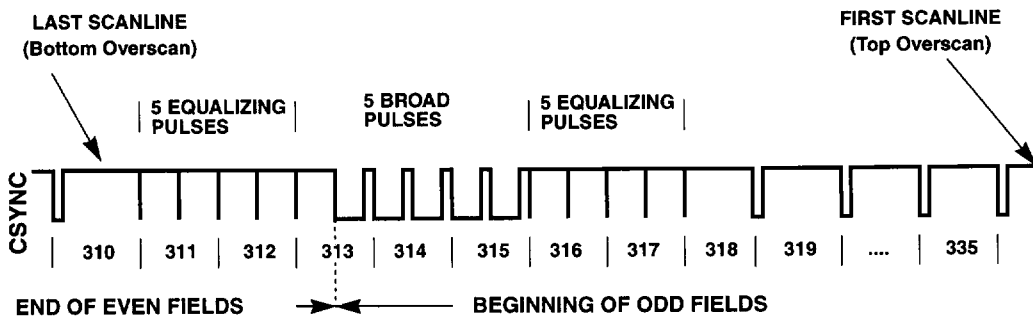
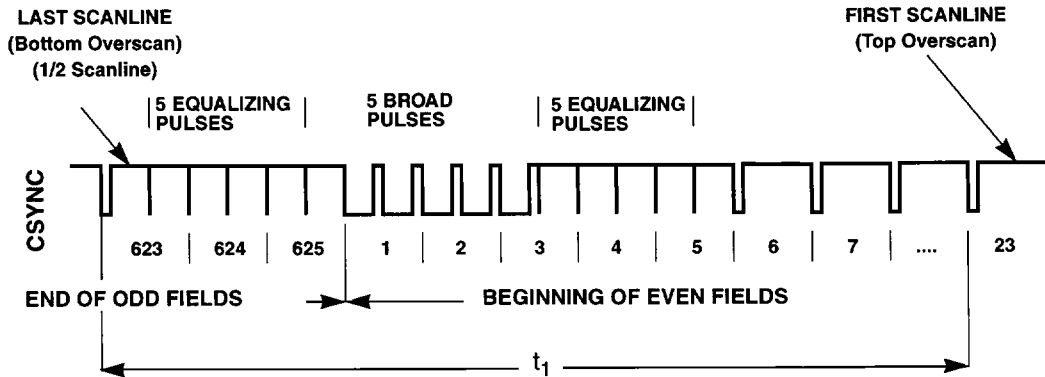

Figure 7-44. Horizontal Period (PAL — CL-GD5425 only)

Table 7-45. PAL Vertical Retrace (CL-GD5425 only)

| Symbol | Parameter | Nominal | Units |
|--------|--------------------------|---------|----------|
| t_1 | Vertical blanking period | 25 | H-period |

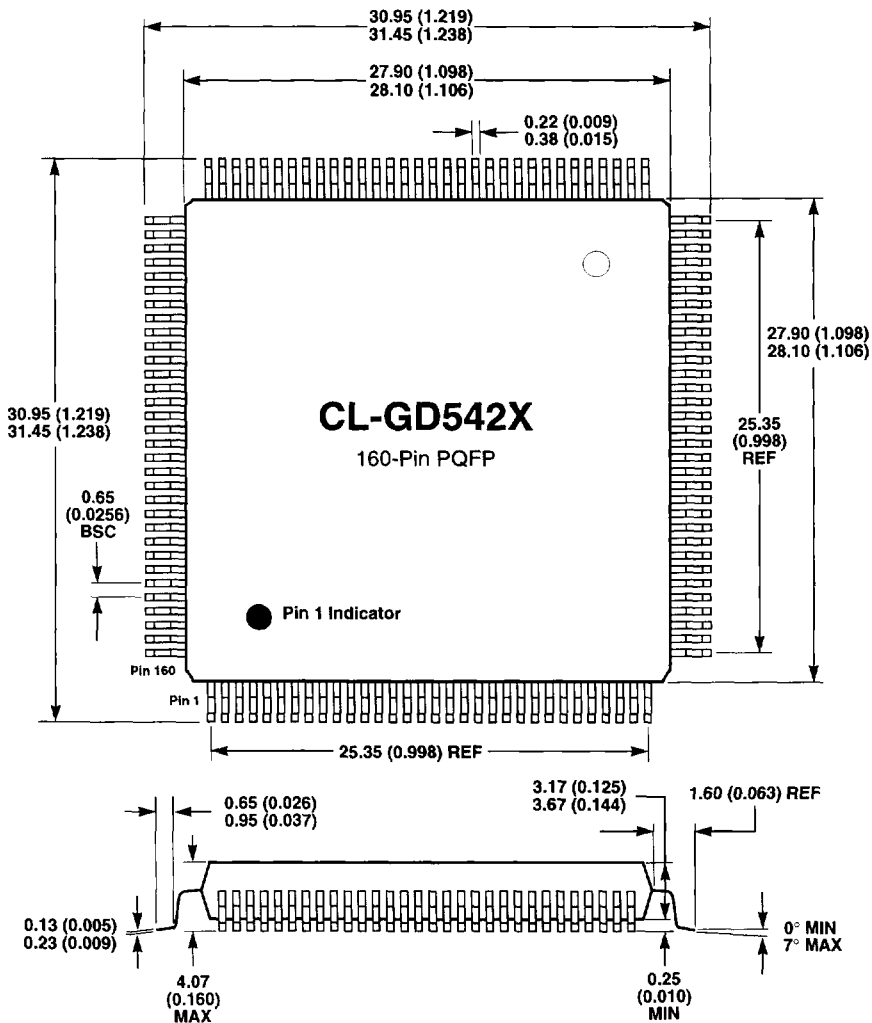
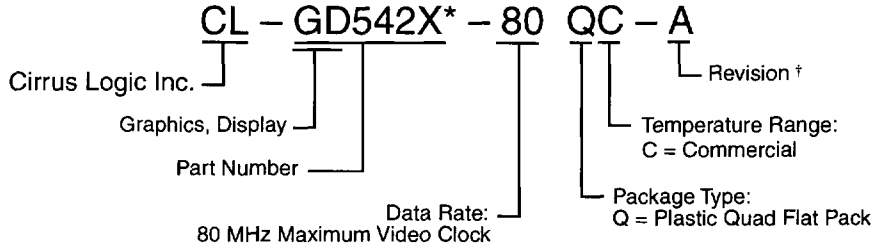

Figure 7-45. PAL Vertical Retrace (CL-GD5425 only)

8. PACKAGE DIMENSIONS



NOTES:

- 1) Dimensions are in millimeters (inches), and controlling dimension is millimeter.
- 2) Drawing above does not reflect exact package pin count.
- 3) Before beginning any new design with this device, please contact Cirrus Logic for the latest package information.

9. ORDERING INFORMATION EXAMPLES

† Contact Cirrus Logic Inc. for up-to-date information on revisions.

* '2X' represents CL-GD5420/22/24/26/28/29, respectively.

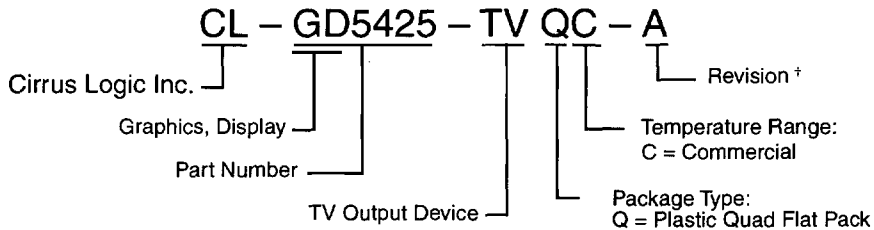

† Contact Cirrus Logic Inc. for up-to-date information on revisions.

INDEX

A

abbreviations 8
acronyms 8
attribute controller 38

B

BitBLT 37, 40
BitBLT registers. *See* registers
buffer write. *See also* CPU 37
bus
 host
 interface 13, 21, 25, 28
 interface signals 46
 ISA 10, 21, 46
 local 12, 28, 46
 local interface 40
 MicroChannel 11, 25, 46

C

CL-GD542X
 conventions 8
color key 52
Configuration register. *See* registers
conventions 8
CPU
 interface 37
 write buffer 37
CRT
 controller 37

D

DAC
 characteristics 57
DC specifications
 digital 55
 frequency synthesizer 56
 palette DAC 56
denominator 51
display memory 34, 37, 45
 interface 17
 refresh 39
dual-frequency synthesizer 31, 39, 56

E

EEPROM 51
electrical specifications, absolute maximum ratings 54
extended resolutions 2

Extended Video modes. *See* modes

F

Fast-Page mode. *See* modes

G

graphics controller 37
graphics cursor
 X position 51
 Y position 51

H

hardware cursor 40
Hidden DAC register. *See* registers

I

ISA bus. *See* bus

L

local bus. *See* bus

M

MCLK 55
memory
 arbitrator 37
 sequencer 37
MicroChannel bus. *See* bus
modes
 Extended Video modes 42
 Fast-Page 37, 39
 Video 41
monitors supported 2

N

numerator 51
numeric naming conventions 9

P

package dimensions 101
package marking numbering guide 102
palette DAC 38, 56
pin scan testing 40

R

register port map 47

registers

- BitBLT 52
- Configuration
 - CF1 45
- CRT Controller 49
- Extension 51
 - Hidden DAC register (HDR) 52
- External/General 48
- VGA 47
- VGA Attribute Controller 50
- VGA Graphics Controller 50
- VGA Sequencer 48

S

- screen refresh 39
- signature generator 40, 51
- synthesizer interface 16

T

timing

- DCLK as input 94
- display memory bus
 - CAS*-before-RAS* refresh 88
- feature bus timing (outputs) 89
- ISA bus
 - OWS* 65
 - AEN 67
 - BALE 64
 - EROM* 66
 - I/O read 60
 - I/O write 59
 - IOCHRDY for memory access 65
 - IOCS16* 63
 - MCS16* 63
 - memory read 62
 - memory write 61
 - refresh 66
- local bus
 - ADS#, LBA#, BS16# 78
 - buffer control, read cycle 81
 - buffer control, write cycle 82
 - CLK1X, CLK2X 76
 - RDY# delay 79
 - read data 80
 - RESET 77
- MicroChannel bus
 - CD_CHRDY 72
 - CD_DS16 70
 - CD_SETUP 75
 - CD_SFDBK 74
 - CMD 71
 - EROM 74

timing (cont.)

- MicroChannel bus
 - read 69
 - REFRESH 73
 - write 68
- P-bus as inputs
 - 16-bit mode 93
 - 16-bit mode – Clock mode 2 92
 - 8-bit mode 88
- RESET 95

V

- VCLK 55
- VESA
 - connector 39
- VGA registers *See* registers
- video
 - interface 16, 32
- video FIFO. *See also* FIFO 37
- Video modes. *See* modes

W

- write buffer 40

Direct Sales Offices

Domestic

N. CALIFORNIA

Fremont
 TEL: 510/623-8300
 FAX: 510/252-6020

Sacramento
 TEL: 916/933-4200
 FAX: 916/933-4211

S. CALIFORNIA

Tustin
 TEL: 714/573-9911
 FAX: 714/573-4665

Thousand Oaks
 TEL: 805/371-5381
 FAX: 805/371-5382

NORTHWESTERN AREA

Portland, OR
 TEL: 503/620-5547
 FAX: 503/624-5665

ROCKY MOUNTAIN AREA

Denver, CO
 TEL: 303/786-9696
 FAX: 303/786-9695

SOUTH CENTRAL AREA

Austin, TX
 TEL: 512/255-0080
 FAX: 512/255-0733

Dallas, TX
 TEL: 214/252-6698
 FAX: 214/252-5681

Houston, TX
 TEL: 713/379-5772
 FAX: 713/379-4341

CENTRAL AREA

Chicago, IL
 TEL: 708/981-6950
 FAX: 708/981-6846

NORTHEASTERN AREA

Andover, MA
 TEL: 508/474-9300
 FAX: 508/474-9149

Boston, MA
 TEL: 617/721-1439
 FAX: 617/721-4509

Iselin, NJ
 TEL: 908/632-2771
 FAX: 908/632-2914

Philadelphia, PA
 TEL: 215/625-0781
 FAX: 215/625-0731

SOUTHEASTERN AREA

Atlanta, GA
 TEL: 404/623-4653
 FAX: 404/497-0414

Boca Raton, FL
 TEL: 407/241-5777
 FAX: 407/241-7990

Raleigh, NC
 TEL: 919/481-9610
 FAX: 919/481-9640

International

GERMANY

Herrsching
 TEL: 49/8152-40084
 FAX: 49/8152-40077

FRANCE

Rosny sous bois
 TEL: 33/1-48-122812
 FAX: 33/1-48-122810

HONG KONG

Tsimshatsui
 TEL: 852/376-0801
 FAX: 852/375-1202

JAPAN

Tokyo
 TEL: 81/3-3340-9111
 FAX: 81/3-3340-9120

KOREA

Seoul
 TEL: 82/2-565-8561
 FAX: 82/2-565-8565

SINGAPORE

TEL: 65/353-2122
 FAX: 65/353-2166

TAIWAN

Taipei
 TEL: 886/2-718-4533
 FAX: 886/2-718-4526

UNITED KINGDOM

Hertfordshire, England
 TEL: 44/1727-872424
 FAX: 44/1727-875919

The Company

Headquartered in Fremont, California, Cirrus Logic Inc. develops innovative architectures for analog and digital system functions. The Company implements those architectures in proprietary integrated circuits and related software for applications that include user interface and multimedia (graphics, audio, and video), mass storage, communications, and data acquisition.

Key markets for Cirrus Logic's products include desktop and portable computing, workstations, telecommunications, and consumer electronics.

The Cirrus Logic formula combines innovative architectures in silicon with system design expertise. We deliver complete solutions — chips, software, evaluation boards, and manufacturing kits — on-time, to help you win in the marketplace.

Cirrus Logic's manufacturing strategy, unique in the semiconductor industry, employs a full manufacturing infrastructure to ensure maximum product quality, availability, and value for our customers.

Talk to our systems and applications specialists; see how you can benefit from a new kind of semiconductor company.

© Copyright, Cirrus Logic Inc., 1995. All rights reserved.

Preliminary product information describes products that are in production, but for which full characterization data is not yet available. Cirrus Logic Inc. has made best efforts to ensure that the information contained in this document is accurate and reliable. However, the information is subject to change without notice. No responsibility is assumed by Cirrus Logic Inc. for the use of this information, nor for infringements of patents or other rights of third parties. This document is the property of Cirrus Logic Inc. and implies no license under patents, copyrights, or trade secrets. No part of this publication may be copied, reproduced, stored in a retrieval system, or transmitted, in any form or by any means, electronic, mechanical, photographic, or otherwise, or used as the basis for manufacture or sale of any items without the prior written consent of Cirrus Logic Inc. Cirrus Logic, AutoMap, Fair Share, FeatureChips, Good Data, MediaDAC, MotionVideo, MVA, PicoPower, SimuSCAN, S/LA, SofTarget, UXART, Vision Port, WavePort, WIC, and WindowInterChip are trademarks of Cirrus Logic Inc. Other trademarks in this document belong to their respective companies. Cirrus Logic Inc. products are covered by the following U.S. patents: 4,293,783; Re. 31,287; 4,763,332; 4,777,635; 4,839,896; 4,931,946; 4,975,828; 4,979,173; 5,032,981; 5,122,783; 5,131,015; 5,140,595; 5,157,618; 5,179,292; 5,185,602; 5,220,295; 5,241,642; 5,276,856; 5,280,488; 5,287,241; 5,291,499; 5,293,159; 5,293,474; 5,297,184; 5,298,915; 5,300,835; 5,311,460; 5,313,224; 5,327,128; 5,329,554; 5,351,231; 5,359,631; 5,384,524; 5,384,786; 5,388,083; 5,396,133; 5,402,506; 5,402,513; 5,406,279; 5,406,613. Additional patents pending.

Cirrus Logic Inc. 3100 West Warren Ave. TEL: 510/623-8300
 Fremont, CA 94538 FAX: 510/252-6020

345429-007