



# IBM RS/6000 Clustered Enterprise Servers Systems Handbook

Use PSSP to manage your RS/6000 Enterprise Servers

Migrate your RS/6000 Enterprise Servers to a CES system

Upgrade your CES system to an SP system



Yoshimichi Kosuge  
Paul J. Swiatocha, Jr.

[ibm.com/redbooks](http://ibm.com/redbooks)

**Redbooks**





International Technical Support Organization

**IBM RS/6000 Clustered Enterprise Servers  
Handbook**

July 2000

**Take Note!**

Before using this information and the product it supports, be sure to read the general information in Appendix B, "Special notices" on page 93.

**First Edition (July 2000)**

This edition applies to Version 3, Release 2 of the IBM Parallel System Support Programs for AIX (PSSP) Licensed Program (product number 5765-D51).

Comments may be addressed to:

IBM Corporation, International Technical Support Organization  
Dept. JN9B Mail Station P099  
2455 South Road  
Poughkeepsie, NY 12601-5400

When you send information to IBM, you grant IBM a non-exclusive right to use or distribute the information in any way it believes appropriate without incurring any obligation to you.

**© Copyright International Business Machines Corporation 2000. All rights reserved.**

Note to U.S Government Users – Documentation related to restricted rights – Use, duplication or disclosure is subject to restrictions set forth in GSA ADP Schedule Contract with IBM Corp.

---

# Contents

<b>Preface</b> .....	v
The team that wrote this redbook .....	v
Comments welcome .....	vi
<b>Chapter 1. Introduction</b> .....	1
1.1 IBM RS/6000 Enterprise Servers .....	1
1.2 IBM RS/6000 SP-attached server .....	3
1.3 IBM RS/6000 Clustered Enterprise Servers .....	5
<b>Chapter 2. Requirements and limitations</b> .....	9
2.1 Hardware requirements and limitations .....	9
2.1.1 Feature codes .....	9
2.1.2 Hardware limitations .....	10
2.1.3 Communication adapters .....	11
2.1.4 Cable connections .....	11
2.1.5 Control workstation .....	13
2.1.6 Service Director .....	15
2.2 Software requirements and limitations .....	16
2.2.1 Software levels and feature codes .....	16
2.2.2 Software limitations .....	16
2.2.3 IPv6 network .....	17
2.2.4 Coexistence .....	17
<b>Chapter 3. PSSP enhancements</b> .....	19
3.1 SDR enhancements .....	19
3.2 Command enhancements .....	19
3.2.1 The spframe command .....	19
3.2.2 The spdelfram command .....	21
3.3 SP Perspectives enhancements .....	22
3.3.1 What is SP Perspectives? .....	22
3.3.2 SP Perspectives Launch Pad .....	23
3.3.3 Hardware Perspective .....	24
3.3.4 Event Perspective .....	31
<b>Chapter 4. Installation and migration</b> .....	37
4.1 Installing a CES system with new Enterprise Servers .....	37
4.2 Migrating existing Enterprise Servers to a CES system .....	39
4.3 Migrating an existing SP system to a CES system .....	41
<b>Chapter 5. Scaling up an existing CES system to an SP system</b> .....	45
5.1 Numbering rules .....	45

5.2	Configuring an SP system with an SP Switch . . . . .	48
5.3	Adding SP-attached servers to an SP system . . . . .	52
5.4	Adding SP frames to a CES system . . . . .	54
5.4.1	Adding SP Switch adapters . . . . .	55
5.5	Recommended expansion plan . . . . .	57
5.5.1	When a CES system has 1 to 12 Enterprise Servers . . . . .	57
5.5.2	When a CES system has 13 to 15 Enterprise Servers . . . . .	62
5.5.3	When a CES system has 16 (maximum) Enterprise Servers . . . . .	64
<b>Appendix A. Presentation kit . . . . .</b>		<b>71</b>
<b>Appendix B. Special notices . . . . .</b>		<b>93</b>
<b>Appendix C. Related publications . . . . .</b>		<b>95</b>
C.1	IBM Redbooks . . . . .	95
C.2	IBM Redbooks collections . . . . .	95
C.3	Other resources . . . . .	95
C.4	Referenced Web sites . . . . .	96
<b>How to get IBM Redbooks . . . . .</b>		<b>99</b>
IBM Redbooks fax order form . . . . .		100
<b>Index . . . . .</b>		<b>101</b>
<b>IBM Redbooks review . . . . .</b>		<b>107</b>

---

## Preface

The RS/6000 Enterprise Server was introduced to meet the rigorous demands of mission-critical enterprise applications, since then it has provided unsurpassed power, flexibility, and reliability.

Today, as business has grown, the number of RS/6000 Enterprise Servers for business has increased. This has promoted a demand for a solution that manages a number of RS/6000 Enterprise Servers, similar to the manageability that IBM's PSSP management software provides to its RS/6000 SP systems. New to the PSSP 3.2 release, you can now manage RS/6000 Enterprise Servers like SP-attached servers in an RS/6000 SP system in a configuration called RS/6000 Clustered Enterprise Servers (CES). The CES system contains only RS/6000 Enterprise Servers managed from a single point of control, called a control workstation (CWS).

This redbook provides the following information on CES systems:

- Hardware/software requirements and limitations
- PSSP enhancements to support CES systems
- Installation and migration
- Ways to scale a CES system to an SP system

For your convenience, a presentation kit is attached as an appendix.

---

### The team that wrote this redbook

This redbook was produced by a team of specialists from around the world working at the International Technical Support Organization, Poughkeepsie Center.

**Yoshimichi Kosuge** is an IBM RS/6000 SP project leader at the International Technical Support Organization, Poughkeepsie Center. Since he joined IBM, he has worked in the following areas: LSI design, S/390 CP microcode, VM, MVS, OS/2, and AIX. After joining the ITSO in 1998, he has been involved in writing redbooks and teaching IBM classes worldwide on all areas of the RS/6000 SP system.

**Paul J. Swiatocha, Jr.** is a software engineer for IBM in the UNIX System Services department of the Poughkeepsie UNIX Development Lab. Since joining IBM in 1999, he has worked on various aspects of installation and configuration for IBM's RS/6000 SP Systems. Most recently, he was part of

the development team that added support for Clustered Enterprise Servers to the PSSP management software.

Thanks to the following people for their invaluable contributions to this project:

IBM Poughkeepsie:

Christopher J. Algozzine  
Kenneth C. Briskey  
Michael Chase-Saleno  
Brian N. Croswell  
Debra A. Kessler  
Linda Mellor  
Harold Turner  
Bill Wajda

Dino Quintero  
International Technical Support Organization, Poughkeepsie Center

---

## Comments welcome

### Your comments are important to us!

We want our Redbooks to be as helpful as possible. Please send us your comments about this or other Redbooks in one of the following ways:

- Fax the evaluation form found in “IBM Redbooks review” on page 107 to the fax number shown on the form.
- Use the online evaluation form found at [ibm.com/redbooks](http://ibm.com/redbooks)
- Send your comments in an Internet note to [redbook@us.ibm.com](mailto:redbook@us.ibm.com)



---

## Chapter 1. Introduction

IBM RS/6000 servers brought 64-bit technology to the market with the introduction of the RS/6000 Enterprise Server Model S70 and AIX Version 4.3. Together, they provided the key elements of the 64-bit computing environment, both in hardware and software. This is the origin of the RS/6000 Enterprise Server.

Along with the S70, the RS/6000 Enterprise Server Model S70 Advanced was introduced with the capability to be attached to the RS/6000 SP as an SP-attached server. Using an SP Switch adapter that fits within the S70 Advanced I/O drawer, the system is capable of connecting directly into the SP Switch fabric. The system is then ideally suited, for example, to handle large database transactions while allowing the other SP nodes to act as application servers.

Introduced in September of 1999, the RS/6000 Enterprise Server Model S80 provides you unsurpassed power, flexibility, and reliability. The S80 uses up to 24 microprocessors built with IBM's innovative copper chip technology to meet the rigorous demands of mission-critical enterprise applications, such as Enterprise Resource Planning (ERP), which are rapidly evolving to Web serving. In addition to superior Web serving and ERP capabilities, the S80 excels with server consolidation, Supply Chain Management (SCM), Customer Relationship Management (CRM), On-line Transaction Processing (OLTP), and business intelligence (BI).

As business has grown, the number of RS/6000 Enterprise Servers sold to businesses has increased. This has promoted a demand for a solution that manages a number of RS/6000 Enterprise Servers, similar to the manageability that Parallel Systems Support Programs for AIX (PSSP) provides to RS/6000 SP systems. New to the PSSP 3.2 release, you can now manage RS/6000 Enterprise Servers like SP-attached servers in an RS/6000 SP system in a configuration called RS/6000 Clustered Enterprise Servers (CES). The CES system contains only RS/6000 Enterprise Servers managed from a single point of control, called a control workstation (CWS).

---

### 1.1 IBM RS/6000 Enterprise Servers

Designed for a broad range of applications serving medium to large businesses, *IBM RS/6000 Enterprise Servers*, shown in Figure 1 on page 2, come in symmetric multiprocessor (SMP) models that are well suited for mission-critical commercial, large e-business, or ERP environments. The

RS/6000 Enterprise Servers running IBM's award-winning AIX operating system provide complete 64-bit computing solutions.



Figure 1. IBM RS/6000 Enterprise Server

#### **IBM RS/6000 S70 Enterprise Server**

This product was a predecessor of the S70 Advanced Enterprise Server. It is no longer in production.

#### **IBM RS/6000 S70 Advanced Enterprise Server**

The *IBM RS/6000 S70 Advanced Enterprise Server* is a powerful 64-bit SMP system. Delivering performance, scalability, and reliability for today's critical e-business applications, it excels in OLTP, ERP, and SCM applications. Exceptional expandability is available, with up to 32 GB of main memory and 53 industry-common Peripheral Component Interconnect (PCI) adapter slots. The S70 Advanced can run both 32- and 64-bit applications concurrently.

For more information on IBM RS/6000 S70 Advanced Enterprise Server, refer to:

[http://www.rs6000.ibm.com/hardware/enterprise/s70\\_advanced.html](http://www.rs6000.ibm.com/hardware/enterprise/s70_advanced.html)

#### **IBM RS/6000 S80 Enterprise Server**

The *IBM RS/6000 S80 Enterprise Server* is RS/6000's most powerful 64-bit SMP system. It delivers outstanding performance for ERP and SCM applications, including Baan, i2 Manugistics, Oracle, PeopleSoft, SAP R/3, and more.

The S80 is the largest IBM SMP available, doubling the number of processors (to 24) and doubling the memory (up to 64 GB) of the S70 and S70 Advanced. Also, the S80 server is the first RS/6000 platform to feature the RS64 III microprocessors based on IBM's state-of-the-art copper technology. The result is faster, more reliable processors.

The S80 system delivers more power for business applications with exceptional internal memory and external I/O bandwidth that can enhance throughput and help eliminate potential bottlenecks. And, new performance enhancements in AIX 4.3.3 take full advantage of the S80's leading-edge design.

Besides ERP, the S80 excels in e-business Web serving, server consolidation, OLTP, and BI applications. The S80 can run both 32- and 64-bit applications concurrently.

For more information on IBM RS/6000 S80 Enterprise Server, refer to:

<http://www.rs6000.ibm.com/hardware/enterprise/s80.html>

---

## **1.2 IBM RS/6000 SP-attached server**

The joining of the IBM RS/6000 S70, S70 Advanced, and S80 Enterprise Servers to the RS/6000 SP satisfies the need many SP environments have for large, powerful, and memory-rich processors for their database servers and SAP R/3 applications and generally provides a single point of management for the entire system. An *IBM RS/6000 SP system with an IBM RS/6000 SP-attached server* is illustrated in Figure 2 on page 4.

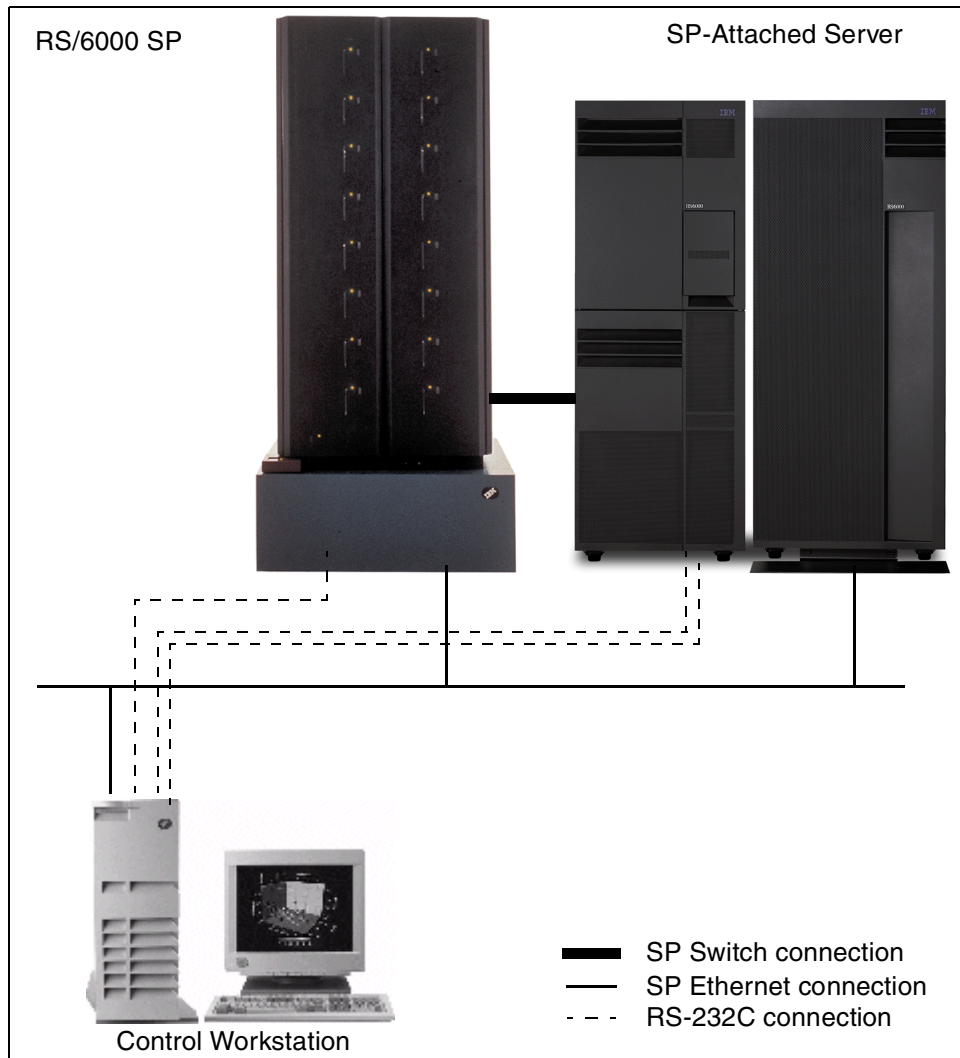

Figure 2. IBM RS/6000 SP with SP-attached server

The joining of these technologies was accomplished in the fall of 1998 with the introduction of the first SP-attached server. Since then, SP-attached servers have proven to be immensely popular and extremely stable for commercial environments. The unique characteristics of each technology are still maintained, and the differences, in some cases, are still accentuated.

Adding an additional (albeit highly powered) node to the SP system is not the only advantage brought by the SP-attached server. From the point of view of

system administration and program execution, there are other advantages. Beginning with PSSP 3.1, the administrator sees the SP-attached server as a new RS/6000 SP Perspectives icon representing a logical node contained within a logical frame to which the system administrator can apply the RS/6000 SP Perspectives tool. The SP-attached server will appear as another “node” on which licensed program products and OEM applications can be executed.

For more information on IBM RS/6000 SP systems, refer to:

<http://www.rs6000.ibm.com/hardware/largescale/SP/index.html>

For more information on SP-attached servers, refer to:

[http://www.rs6000.ibm.com/resource/technology/sp\\_attach.html](http://www.rs6000.ibm.com/resource/technology/sp_attach.html)

For information on PSSP software, refer to:

[http://www.rs6000.ibm.com/software/sp\\_products/pssp.html](http://www.rs6000.ibm.com/software/sp_products/pssp.html)

For a PSSP Web presentation, refer to:

[http://www.rs6000.ibm.com/software/sp\\_products/pssp\\_pres/pdemo\\_intro.html](http://www.rs6000.ibm.com/software/sp_products/pssp_pres/pdemo_intro.html)

---

### **1.3 IBM RS/6000 Clustered Enterprise Servers**

The RS/6000 SP-attached server is a great solution for delivering outstanding system performance and system manageability improvements to your RS/6000 SP system. However, before PSSP 3.2, you needed both the RS/6000 SP and the RS/6000 Enterprise Server to enjoy these benefits.

PSSP 3.2 provides you with similar manageability currently provided to the RS/6000 SP-attached server but without the RS/6000 SP. Now, it is possible to configure *IBM RS/6000 Clustered Enterprise Servers (CES)* as shown in Figure 3 on page 6. In addition to the Enterprise Server’s unsurpassed power, flexibility, and reliability, you can now enjoy PSSP’s superior system manageability.

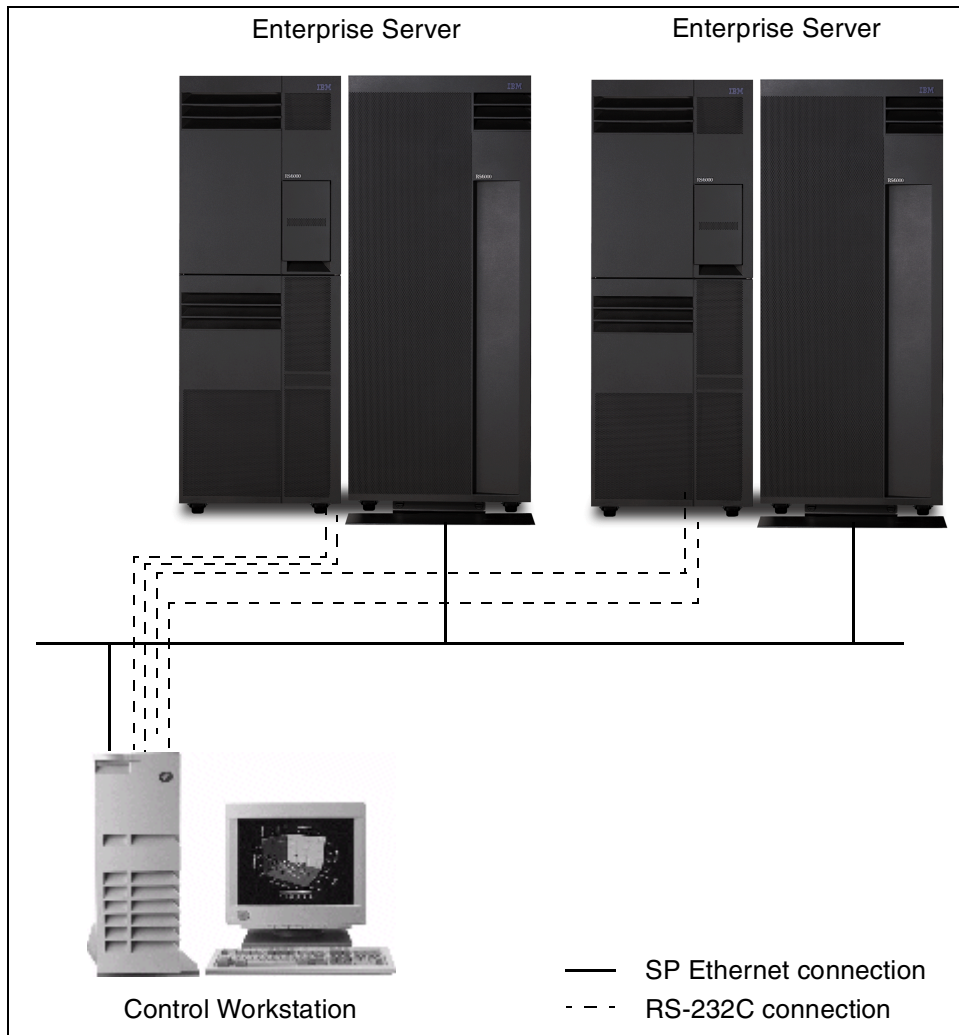

Figure 3. IBM RS/6000 Clustered Enterprise Servers

The CES system is a cluster of RS/6000 Enterprise Servers (S70, S70 Advanced, or S80), each running the PSSP software, connected to one control workstation (CWS) running PSSP 3.2, and connected to the SP Ethernet without any SP frame in the system. You are no longer required to have at least one SP frame and node in order to use the PSSP software. A maximum of sixteen Enterprise Servers are supported in one CES system. CES systems, however, are not supported with any type of SP Switch.

The following chapters and appendix describe detailed information on the CES system:

- Chapter 2, “Requirements and limitations” on page 9 provides information on hardware and software requirements and limitations when you plan your CES system.
- Chapter 3, “PSSP enhancements” on page 19 provides information on PSSP enhancements to support CES systems in addition to improving the manageability of SP systems.
- Chapter 4, “Installation and migration” on page 37 provides information you need to know when you install your CES system, migrate your existing IBM RS/6000 Enterprise Servers to a CES system, or migrate your existing SP system to a CES system.
- Chapter 5, “Scaling up an existing CES system to an SP system” on page 45 is very important if you think your CES system will be scaled up to an SP system in the future. If this is the case, you need to take many items into account when you configure your CES system. The chapter provides a suggested expansion plan which you can adjust to fit your situation.
- Appendix A, “Presentation kit” on page 71 is provided for your convenience. When you need to make a presentation on CES systems, this might help you in your preparation.

**Attention**

This document describes IBM RS/6000 Clustered Enterprise Servers and the enhancements to PSSP to support them. It is intended to help readers obtain information on CES. However, it is assumed that readers have a basic knowledge of SP hardware and PSSP software to properly understand, install, configure, and manage the CES system. For the information on SP hardware and PSSP software, refer to the publications listed in Appendix C, “Related publications” on page 95.”





---

## Chapter 2. Requirements and limitations

The Clustered Enterprise Servers (CES) system is a cluster of one to sixteen IBM RS/6000 7017 Enterprise Servers and a control workstation (CWS), all running PSSP software. CES gains many benefits from the PSSP software, including a single point of management and the scalability needed for today's e-business applications.

This chapter provides information on the hardware and software requirements and limitations you need to consider when you are planning your CES system.

### Attention

In this chapter, if otherwise specified, the term *SP frame* stands for tall model frames (Model 550) and/or tall expansion frames (F/C 1550). Also, *SP node* stands for a high node, wide node, and/or thin node.

---

## 2.1 Hardware requirements and limitations

There are several items that must be considered with respect to hardware before you can place a CES system into service:

- Feature codes
- Hardware limitations
- Communication adapters
- Cable connections
- Control workstation
- Service Director

For details on planning the hardware of CES systems, see *RS/6000 SP: Planning, Volume 1, Hardware and Physical Environment*, GA22-7280.

### 2.1.1 Feature codes

Enterprise Servers 7017-S70, S7A, and S80 use RS/6000 feature codes, not RS/6000 SP feature codes. The RS/6000 feature codes associated with the CES refer to the cable connections that attach the Enterprise Servers to the CWS. Use the following feature codes for your CES system:

**F/C 3150** S1 serial port connection with an IBM-supplied 15 m (49 ft.) custom RS-232 cable.

**F/C 3151** SAMI port connection with an IBM-supplied 15 m (49 ft.) custom RS-232 cable.

### 2.1.2 Hardware limitations

The following hardware limitations apply when you configure CES systems:

- *No SP frame is supported, such as the following:*
  - Tall frame (model 550)
  - Tall frame (F/C 1550)
  - Tall frame (F/C 2031)
  - Short frame (model 500)
  - Short frame (F/C 1500)
- *No SP node is supported, such as the following:*
  - 375 MHz POWER3 SMP high node (F/C 2058)
  - 375 MHz POWER3 SMP wide node (F/C 2057)
  - 375 MHz POWER3 SMP thin node (F/C 2056)
  - POWER3 SMP high node (F/C 2054)
  - 332 MHz SMP wide node (F/C 2051)
  - 332 MHz SMP thin node (F/C 2050)
- *No SP Switch or SP Switch2 is supported, such as the following:*
  - SP Switch (F/C 4011)
  - SP Switch (F/C 4008)
  - SP Switch2 (F/C 4012)
- *No RS/6000 SP Switch Router is supported, such as the following:*
  - RS/6000 SP Switch Router (M/T 9077 04S)
  - RS/6000 SP Switch Router (M/T 9077 16S)

**Attention**

Even though CES systems have the previous hardware limitations, they can be migrated to SP systems that do not have these limitations. For scaling up a CES system to an SP system, refer to Chapter 5, “Scaling up an existing CES system to an SP system” on page 45.

### 2.1.3 Communication adapters

Each communication adapter requires one communication adapter slot in the Enterprise Server. All communication adapters in the CES use PCI architecture.

#### PCI communication adapter restriction

Only SP system supported PCI communication adapters can be used in an Enterprise Server when it is used as a CES. Thus, if you attach an existing Enterprise Server to a CES system, you must remove any non-SP system supported PCI communication adapters.

Rules for supported PCI communication adapters, such as the following, can be found in the RS/6000 7017 Enterprise Server documentation:

- Required communication adapters (including minimum requirements)
- Maximum quantity of each communication adapter allowed
- Bus placement restrictions

For a complete listing and detailed specifications of currently supported SP system communication adapters, see Chapter 18, “PCI Communication Adapters” in *RS/6000 SP: Planning, Volume 1, Hardware and Physical Environment*, GA22-7280. If a communication adapter does not appear in the list, it is not supported for CES. If you plan to use an existing Enterprise Server, and any of its installed communication adapters do not appear in this list, they must be removed before the Enterprise Server can be attached to the CES system.

### 2.1.4 Cable connections

Each Enterprise Server of a CES requires a minimum of three cable connections with the CWS to establish a functional and safe network as follows:

1. An Ethernet cable connection to the SP Ethernet for system administration purposes.
2. One custom RS-232 cable connecting the CWS to the server SAMI port.
3. One custom RS-232 cable connecting the CWS to the s1 serial port.

### **Clustered Enterprise Server placement limitations**

The location of the Enterprise Servers of a CES is limited by the length of the IBM supplied 15 m (49 ft.) RS-232 and BNC Ethernet cables. Approximately 3 m (10 ft.) of cable is needed for the vertical portions of these cable runs. Thus, the Enterprise Servers can be no more than 12 m (40 ft.) from the CWS.

#### **2.1.4.1 SP Ethernet connection**

Three Ethernet adapters ordered with the Enterprise Servers are supported for SP Ethernet communication. These adapters are:

- Twisted-pair cable connection:
  - 10/100 Ethernet 10BaseTX adapter (F/C 2968)
  - 10 MB AUI/RJ-45 Ethernet adapter (F/C 2987)
- BNC cable connection:
  - 10 MB BNC/RJ-45 Ethernet adapter (F/C 2985)

For details on these adapters, see Chapter 18, “PCI Communication Adapters” in *RS/6000 SP: Planning, Volume 1, Hardware and Physical Environment*, GA22-7280.

#### ***SP Ethernet requirements***

The adapter you select must match the cable connection configuration of the SP Ethernet for your CES system. These adapters must be placed in the en0 position of the Enterprise Server (the lowest-numbered Ethernet bus slot in the first I/O tower).

#### ***Ethernet adapter restrictions***

If you plan to attach an existing Enterprise Server to your CES system, you must place an SP Ethernet adapter in the en0 position inside the Enterprise Server. Due to the fact that the Ethernet adapter in this slot must be configured for PSSP communications, any non-supported Ethernet adapter that is in the en0 slot must be removed.

Additionally, if the Ethernet adapter in slot en0 is either of F/C 2968, 2985, or 2987, the adapter must be de-configured and then reconfigured as an SP Ethernet adapter.

#### 2.1.4.2 Custom RS-232 connection

Two custom RS-232 connections must be made from the CWS to each Enterprise Server. These connections go to the following ports on the Enterprise Servers:

1. S1 serial port on the rear of the primary (first) I/O tower with an IBM-supplied 15 m (49 ft.) custom RS-232 cable (F/C 3150).
2. SAMI port in the control panel on the front of the CEC with an IBM-supplied 15 m (49 ft.) custom RS-232 cable (F/C 3151).

#### 2.1.5 Control workstation

There are many RS/6000s available for the CWS of your CES system. However, we strongly recommend you use a minimum of the following RS/6000:

- RS/6000 Model F50

For the complete listing of supported control workstations, refer to Chapter 2, “Defining the System that Fits Your Needs” in *RS/6000 SP: Planning, Volume 2, Control Workstation and Software Environment, GA22-7281*.

##### 2.1.5.1 Ethernet adapter requirements

You may need additional Ethernet adapters in the CWS. For additional PCI Ethernet adapters, select from the following feature codes:

- F/C 2968** IBM 10/100 Mbps Ethernet PCI adapter
- F/C 2985** PCI Ethernet BNC/RJ-45 adapter
- F/C 2987** PCI Ethernet AUI/RJ-45 adapter
- F/C 4224** Ethernet 10Base2 transceiver

For additional MCA Ethernet adapters, select from the following feature codes:

- F/C 2980** Ethernet high performance LAN adapter
- F/C 2992** Ethernet twisted pair (TP) adapter
- F/C 2993** Ethernet BNC/AUI adapter
- F/C 4224** Ethernet 10Base2 transceiver

##### 2.1.5.2 Serial port adapter requirements

Since the CES requires multiple RS-232 connections, you must use a multi-port asynchronous adapter in the CWS.

All PCI control workstations require a minimum of one additional asynchronous adapter. For additional PCI serial ports, select from the following feature codes:

**8-PORT PCI adapters:**

- F/C 2931** 8-port asynchronous adapter ISA BUS EIA-232 (withdrawn 12/97)
- F/C 2932** 8-port asynchronous adapter ISA BUS EIA-232/422A (withdrawn 12/97)
- F/C 2943** 8-port asynchronous adapter PCI BUS EIA-232/RS-422

**128-PORT PCI adapters:**

- F/C 2933** 128-port asynchronous controller ISA bus (withdrawn 12/97)
- F/C 2944** 128-port asynchronous controller PCI bus
- F/C 8130** 1.2 MB/sec remote asynchronous node (RAN) 16-port EIA-232 (US)
- F/C 8131** 128-port asynchronous controller cable, 4.5 m (1.2 MB/sec transfers)
- F/C 8132** 128-port asynchronous controller cable, 23 cm (1.2 MB/sec transfers)
- F/C 8133** RJ-45 to DB-25 converter cable
- F/C 8134** World Trade version of F/C 8130
- F/C 8136** 1.2 MB/sec rack-mountable remote asynchronous node (RAN) 16-port EIA-232
- F/C 8137** 2.4 MB/sec enhanced remote asynchronous node (RAN) 16-port EIA-232
- F/C 8138** 2.4 MB/sec enhanced remote asynchronous node (RAN) 16-port RS-422
- F/C 2934** Asynchronous terminal/printer cable, EIA-232 (2.4 MB/sec transfers)
- F/C 3124** Serial port to serial port cable for drawer-to-drawer connections (2.4 MB/sec transfers)
- F/C 3125** Serial port to serial port cable for rack-to-rack connections (2.4 MB/sec transfers)

For additional MCA serial ports, select from the following feature codes.

**8-PORT MCA adapters:**

**F/C 2930** 8-port asynchronous adapter

**F/C 2995** Multiport interface cable

**16-PORT MCA adapters:**

**F/C 2996** Multiport interface cable

**Note**

The 16-port asynchronous adapter (F/C 2955) used in an MCA-type CWS is not compatible with the CES system.

### 2.1.6 Service Director

Service Director is a set of IBM software applications that monitor the “health” of your CES system. When a system fault is detected, the severity of the fault is analyzed, and, if required, Service Director will notify the IBM support center. In addition to notifying the IBM support center, you can also configure Service Director to send an automated e-mail message containing the fault information to your system administrator (requires mail to be active on each Enterprise Server). Upon receiving the fault notification, IBM will automatically dispatch a service engineer (with parts if needed) to correct the problem.

In a typical Enterprise Server installation, Service Director transmits reports through a modem supplied with the unit. However, when the Enterprise Server is used in a CES, the modem supplied with the Enterprise Server is not used. In this installation, the Enterprise Server acts like a system node and forwards its Service Director messages to the CES system. When the CES system receives messages from the Enterprise Server, the messages are transmitted through the Service Director modem of the CES system.

To configure Service Director for the CES, you must perform the following:

1. Configure the CES as a Machine Type 7017 in Service Director. You must do this manually.
2. Configure Service Director on each Enterprise Server to forward messages to the system. The modem supplied with the Enterprise Server is not used.
3. Configure Service Director on the CES system to forward messages received from the Enterprise Servers. The Service Director modem for the CES system is attached to the CWS.

---

## 2.2 Software requirements and limitations

There are several items you must consider regarding software before you can place a CES system into service:

- Software levels and feature codes
- PSSP limitations
- IPv6 network
- Coexistence

For details on planning the software of CES systems, see *RS/6000 SP: Planning, Volume 2, Control Workstation and Software Environment*, GA22-7281.

### 2.2.1 Software levels and feature codes

The CES system requires the following software levels on the CWS:

- PSSP 3.2 (or later)
- AIX 4.3.3 (or later)

The Enterprise Servers can have older levels of PSSP and AIX. For information on coexistence, refer to 2.2.4, “Coexistence” on page 17.

Each Enterprise Server in a CES system requires its own PSSP license. PSSP software is available in the following formats:

- F/C 5800 (4 mm tape)
- F/C 5801 (8 mm tape)
- F/C 5802 (CD-ROM)

### 2.2.2 Software limitations

PSSP provides the CES with system manageability similar to that for the SP system. The following considerations are significant when planning PSSP software on a CES:

- Since an Enterprise Server has no SP frame supervisor or SP node supervisor, there is limited control and monitoring of the server from the CWS. It is otherwise treated functionally by PSSP as if it is in an SP node in an SP frame.
- No type of SP switch is supported in a CES configuration. This means that functions that depend on the SP Switch are also not available in this



system environment, such as the General Parallel File System (GPFS) and the Parallel Environment (PE) user space jobs.

- 64-bit processing is not exploited by PSSP, but you can run 64-bit applications on an Enterprise Server that does not require any PSSP services.
- System partitioning is not supported. Therefore, there is only one system partition in a CES system.
- Virtual Shared Disk (VSD) is not supported.
  - HACWS is not supported.

**Attention**

Even though CES systems have the previous software limitations, they can be migrated to SP systems that do not have these limitations. For scaling up a CES system to an SP system, refer to Chapter 5, “Scaling up an existing CES system to an SP system” on page 45.

### 2.2.3 IPv6 network

IPv6 is not supported for use by the PSSP components. It cannot be used with SP adapters and is incompatible with the Reliable Scalable Cluster Technology (RSCT) components. If you are going to use a CES system, be sure that the Enterprise Servers in the system do not use IPv6.

If an Enterprise Server to be managed as part of a CES system is already in use and connected to an IPv6 network, you must remove it from the IPv6 network before integrating the Enterprise Server into the CES system.

Some PSSP components tolerate IPv6 aliases for the IPv4 network addresses, but not when you used with the Distributed Computing Environment (DCE), High Availability Cluster Multi-Processing for AIX (HACMP), or an SP Switch. For information about SP systems tolerating IPv6 aliases for IPv4 network addresses, see Appendix G, “Tolerating IPv6 Alias Addresses” in *IBM Parallel System Support Programs for AIX: Administration Guide*, SA22-7348.

### 2.2.4 Coexistence

A CES system can support multiple levels of AIX and PSSP in the same system partition (CES has only one system partition). However, only certain combinations of PSSP and AIX are supported.

Coexistence is supported for Enterprise Servers running any combination of:

- PSSP 3.2 and AIX 4.3.3
- PSSP 3.1.1 and AIX 4.3.3

**Note**

The CWS must have a minimum of PSSP 3.2 and AIX 4.3.3 installed on it. In addition, the PSSP and AIX levels installed on the CWS must be equal to or greater than the levels of PSSP and AIX installed on the individual Enterprise Servers in the CES.

In general, any combination of the PSSP and AIX levels listed here can coexist. However, some PSSP components and related LPPs have some limitations. Also, many software products have PSSP and AIX dependencies — you must ensure that the proper release levels of these products are used on Enterprise Servers running the coordinating supported PSSP and AIX levels. For the information on products or components of PSSP that have notable exceptions that might limit your coexistence options, see Chapter 12, “Planning for Migration” in *RS/6000 SP: Planning, Volume 2, Control Workstation and Software Environment*, GA22-7281.

---

## Chapter 3. PSSP enhancements

To support CES, PSSP 3.2 has made some enhancements to the SDR, various commands, and SP Perspectives. The following sections discuss these enhancements.

---

### 3.1 SDR enhancements

To provide support for CES, a new system-wide boolean attribute is created in the *SP* class of the System Data Repository (SDR) called *IsPartitionable*.

This attribute is set to the value of “false” for SP Switch2 systems and CES systems. It is set to the value of “true” for all other SP systems that have SP frames whether or not these frames are switched or switchless.

The *IsPartitionable* attribute is set by the PSSP software based on the system configuration. There is no interface provided to the user to set this value.

---

### 3.2 Command enhancements

There are two commands enhanced due to support CES system. They are:

- The `spframe` command
- The `spdelfram` command

The `spframe` command has been enhanced for the administrator who has no knowledge of a switch port number in SP systems. The `spdelfram` command has been enhanced to support in migration from SP systems to CES systems.

For details on these and other commands, see *IBM Parallel System Support Programs for AIX: Command and Technical Reference, SA22-7351*.

#### 3.2.1 The `spframe` command

The `spframe` command is used to enter configuration data for a frame or a series of frames and, optionally, to set up the initial System Data Repository (SDR).

The `-n` flag for the `spframe` command has been made optional for CES systems. If the flag is not used, `SDR_config` dynamically assigns switch port numbers for these Enterprise Servers.

The following is a summary of the `spframe` command for a CES system:

## Syntax

```
spframe -p SAMI [-n starting_switch_port] [-s {s1tty}] [-r yes | no]
start_frame frame_count starting_tty_port
```

## Flags

**-p**

This flag must be *SAMI* for CES systems.

**-n starting\_switch\_port**

Indicates the *switch port number* that is assigned to the Enterprise Server. This flag is optional on CES systems only. Note that *switch port number* is also known as *switch node number*.

**-s s1tty**

Indicates the *s1 tty port* for the single Enterprise Server. This flag is optional, but if it is used, the *s1tty* must be specified as a fully qualified special device file name (such as */dev/tty2*). The default value of the *s1tty* port is one plus the *starting\_tty\_port* operand.

**-r no | yes**

Indicates whether you want to initialize the SDR. If this is the last or only time you are invoking this command during installation, specify *-r yes*. If *-r yes* is specified, the */spdata/sys1/spmon/hmacfs* file has the default entries created. The default is *-r no*.

## Operands

**start\_frame**

Specifies the frame number of the Enterprise Server to be used in this operation. Specify a value between 1 and 128 inclusive.

**frame\_count**

Specifies the number of Enterprise Servers being added with this operation. The *tty* and *s1tty* port values are assigned sequentially beginning with the *starting\_tty\_port* operand. If the *-s* flag is specified, this operand must be one (1).

**starting\_tty\_port**

Specifies the device special file name of the *tty* port to be assigned to the Enterprise Server on this operation. Specify the full path of a valid *tty* special device file name (such as */dev/tty1*).

### Attention

When using the `spframe` command with the `-s` flag to specify the s1 tty port, you can only add one frame at a time.

The following command example is allowed:

```
spframe -p SAMI -s /dev/tty10 1 1 /dev/tty0
```

However, the following command example is not allowed:

```
spframe -p SAMI -s /dev/tty10 1 2 /dev/tty0
```

## 3.2.2 The `spdelfram` command

The `spdelfram` command is used to remove configuration data for a frame or a series of frames from the System Data Repository (SDR).

The command has been enhanced to provide a new `-l` flag to specify a list of frame numbers to be deleted instead of using the `start_frame` and `frame_count` values. This list option can be used to delete all SP frames in a single operation to reconfigure an SP system directly to a CES system. Also, a second new option, the `-c` flag, has been added. This flag allows you to indicate that the system is being reconfigured to a CES system and that switch port number checking should be bypassed.

The following is a summary of the `spdelfram` command for a CES system:

### Syntax

```
spdelfram [-c] {start_frame frame_count | -l frame_list}
```

### Flags

**-c**

Specifies that switch port number verification should be bypassed. Use this flag when reconfiguring your existing SP system to a CES system.

**-l frame\_list**

Specifies a list of frames to be used for this operation. *frame\_list* is a comma-delimited list of frame numbers. If you use this flag, do not use the *start\_frame* and *frame\_count* operands.

### **Operands**

#### **start\_frame**

Specifies the *frame number* of first node to be deleted in this operation. Specify a value between 1 and 128, inclusive. If you are using the -1 flag, do not use this operand.

#### **frame\_count**

Specifies the *number of frames* to be deleted in this operation. Specify a value between 1 and 128 inclusive. If you are using the -1 flag, do not use this operand.

---

## **3.3 SP Perspectives enhancements**

To make SP Perspectives more user friendly, one icon has been added to the SP Launch Pad. It starts the Hardware Perspective with the new profile.

Because SP Perspectives is one of the easy system management functions that PSSP provides on CES systems, this section discusses an introduction to SP Perspectives.

For more details on SP Perspectives, refer to *SP Perspectives: A New View of Your SP System*, SG24-5180.

### **3.3.1 What is SP Perspectives?**

SP Perspectives is a graphical user interface (GUI) that enables you to perform system management tasks for your CES through direct manipulation of system objects represented by icons.

You simply select one or more Enterprise Server system objects (managed CES system resources, such as a frames or nodes) by clicking on them with a mouse and then selecting an action to perform on those system objects from the menu or tool bar. You can use this pattern of selecting one or more system objects and then selecting an action to perform on these system objects to accomplish numerous system management tasks with the SP Perspectives.

SP Perspectives provides function for hardware control and system object monitoring. For example, you can use SP Perspectives to power on and off or reset Enterprise Servers. Some configuration functions are also provided by SP Perspectives (for example, the ability to group Enterprise Servers into node groups).

### 3.3.2 SP Perspectives Launch Pad

SP Perspectives is a suite of five SP Perspective applications: The Hardware Perspective, the Event Perspective, the VSD Perspective, the System Partitioning Aid Perspective, and the Performance Monitor Perspective. You can utilize the following SP Perspective applications to perform the system management tasks for your CES system:

#### Hardware Perspective

Monitor and control Enterprise Servers.

#### Event Perspective

Create and monitor system events.

#### Performance Monitor Perspective

Set up performance and monitoring hierarchies and archiving.

You can access these SP Perspective applications from the *SP Perspectives Launch Pad*, shown in Figure 4 on page 23, or from the command line.

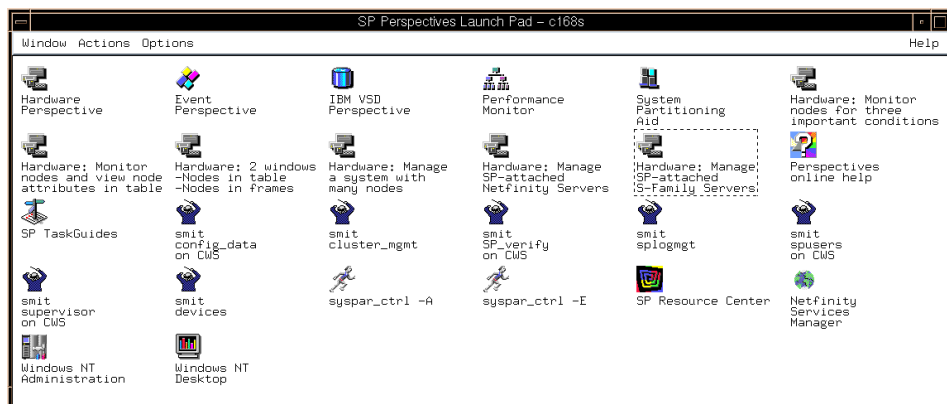

Figure 4. *SP Perspectives Launch Pad*

The SP Perspectives Launch Pad also provides access to system management tools, such as SMIT menus. In addition, you can create your own applications and make them accessible from the SP Perspectives Launch Pad.

To launch Hardware Perspectives, click on the icon named **Hardware Perspective**:



To launch Event Perspectives, click on the icon named **Event Perspective**:



### 3.3.3 Hardware Perspective

The Hardware Perspective icon launches the *Hardware Perspective* with a default profile. In the SP Perspectives Launch Pad, there are six Hardware Perspective icons available. The profiles are customized for variety of cases. For the case of CES, there is an icon named Hardware: Manage SP-attached S-Family Servers:



To see how the Hardware Perspective looks, click on this icon. It launches the Hardware Perspective window shown in Figure 5 on page 25.



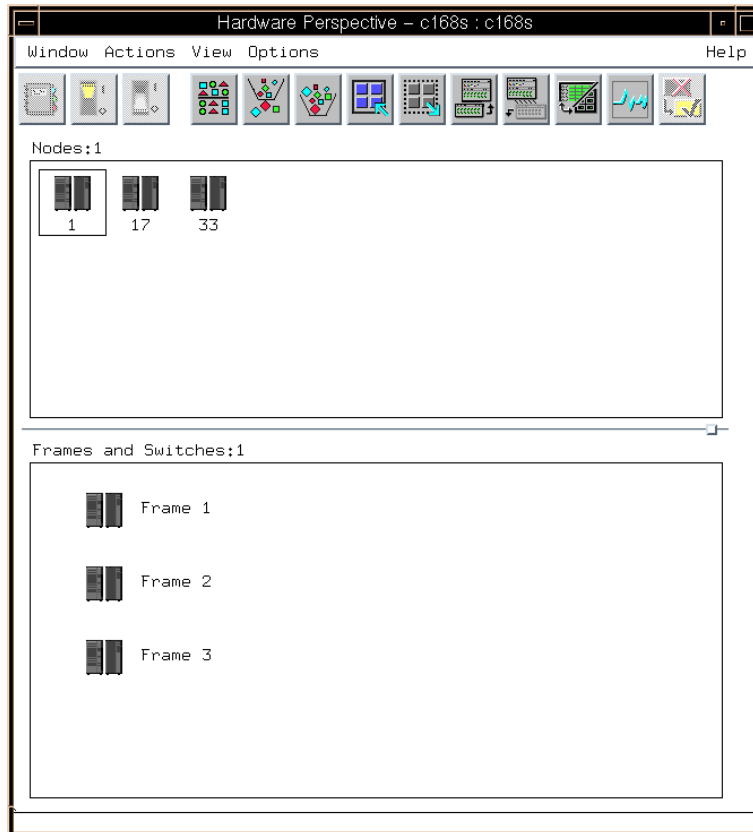

Figure 5. Hardware Perspective

In this example, a CES system has three Enterprise Servers. Each Enterprise Server has both frame and node personalities; therefore, it shows both the Nodes pane (Nodes:1) and Frames and Switches pane (Frames and Switches:1). The Nodes pane is displayed in the icon view, and the Frames and Switches pane is displayed in the tree view.

### 3.3.3.1 Checking information and controlling hardware

To check for frame related Enterprise Server configuration information, click on one of the Frame icons in the Frames and Switches pane. Then click on the **Notebook** icon:



This opens the “View or Modify Properties Frame” notebook shown in Figure 6 on page 26:

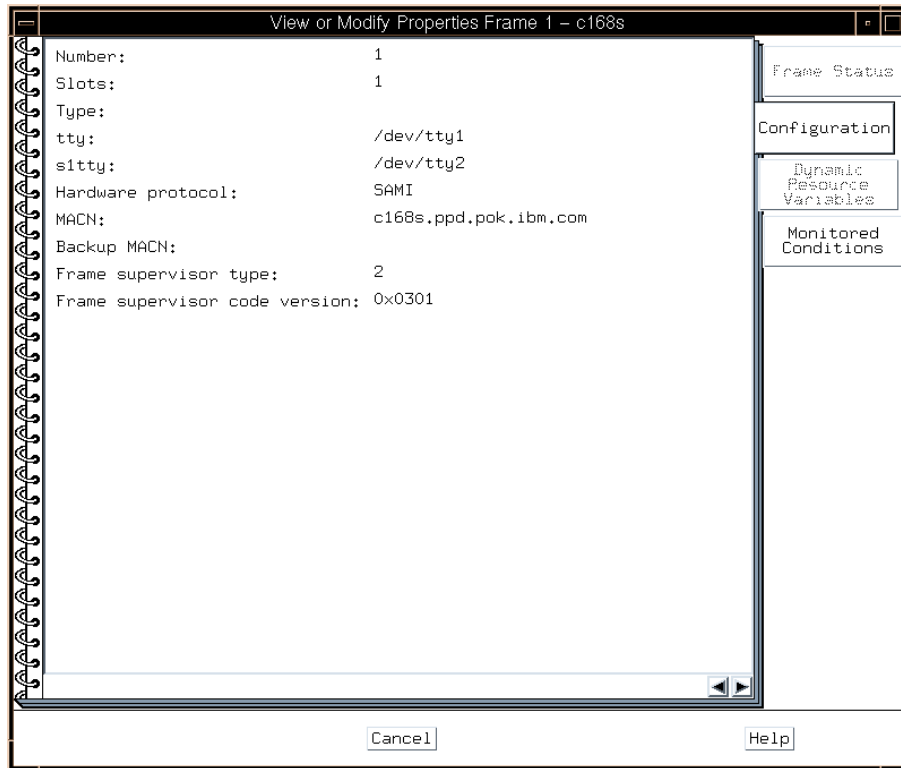

Figure 6. View or Modify Properties Frame notebook

In this example, it shows the configuration information on the first Enterprise Server (frame 1). You can read information from this page. This Enterprise Server uses the control workstation’s /dev/tty1 for SAMI connection and /dev/tty2 for S1 serial connection. The hostname of the control workstation (MACN) is c168s.ppd.pok.ibm.com.

To check for node related Enterprise Server information or to control the Enterprise Server hardware, click on one of the Node icons in the Nodes pane. Then click on the **Notebook** icon:



This opens the “View or Modify Properties Node” notebook shown in Figure 7 on page 27.

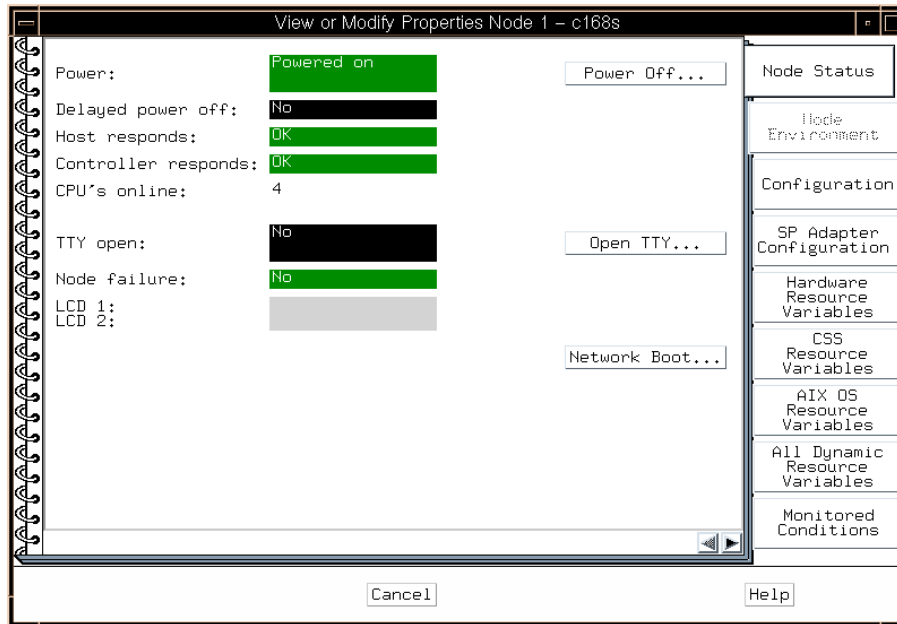

Figure 7. View or Modify Properties Node notebook (Node Status)

This example shows the “View or Modify Properties Node” notebook for the first Enterprise Server (node 1).

The Node Status page provides you with the following information on this Enterprise Server: The power is on, the node is up and running, four CPUs are online, and so on. In addition to providing the information, this page allows you to control the Enterprise Server. You can perform the following operations for this Enterprise Server: Power it off, open its TTY, and network boot it.

The “View or Modify Properties Node” notebook has more pages than the “View or Modify Properties Frame” notebook. To see the specific page, click on the **page** tab on the notebook.

The Configuration page shown in Figure 8 on page 28 is similar to the Configuration page provided by the “View or Modify Properties Frame” notebook (Figure 6 on page 26).

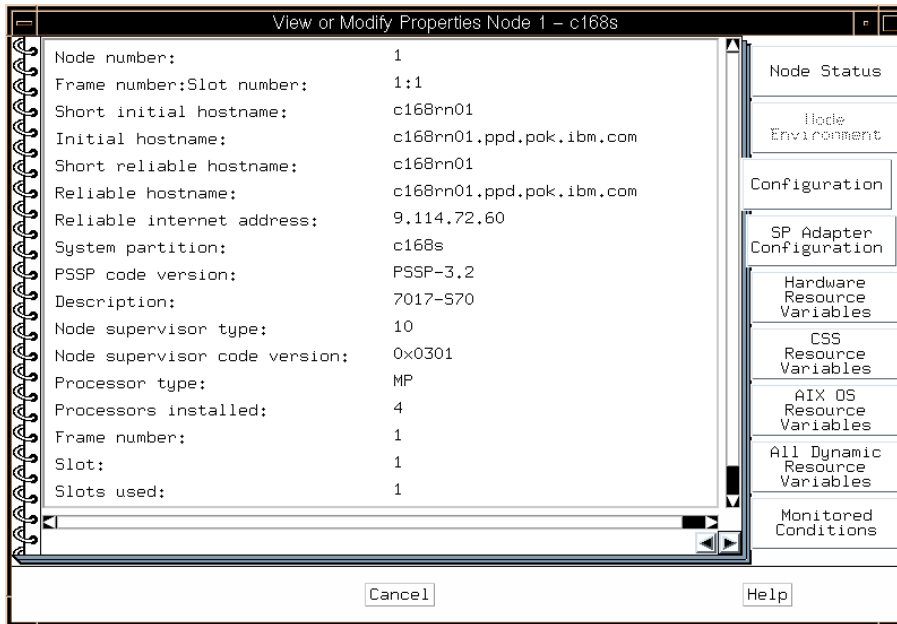

Figure 8. View or Modify Properties Node notebook (Configuration)

In general, the “View or Modify Properties Frame” notebook provides information on relationships between the Enterprise Server and the CWS. On the other hand, the “View or Modify Properties Node” notebook provides information on the Enterprise Server itself.

From the Configuration page, you can find the following information on the Enterprise Server: The hostname is c168rn01.ppd.pok.ibm.com, the IP address is 9.114.72.60, it is running PSSP 3.2, and so on.

### 3.3.3.2 Monitoring system conditions

Other than checking configuration information and controlling hardware, the Hardware Perspective provides you with the ability to monitor system conditions on the Enterprise Servers.

You can monitor multiple conditions in one pane and see the aggregate monitoring state. The pane shows you a visual indication of what you are monitoring. To monitor system conditions, click on one of the Node icons in the Nodes pane. Then click on the **Monitor** icon:



You will see the “Set Monitoring for Nodes” notebook shown in Figure 9 on page 29.

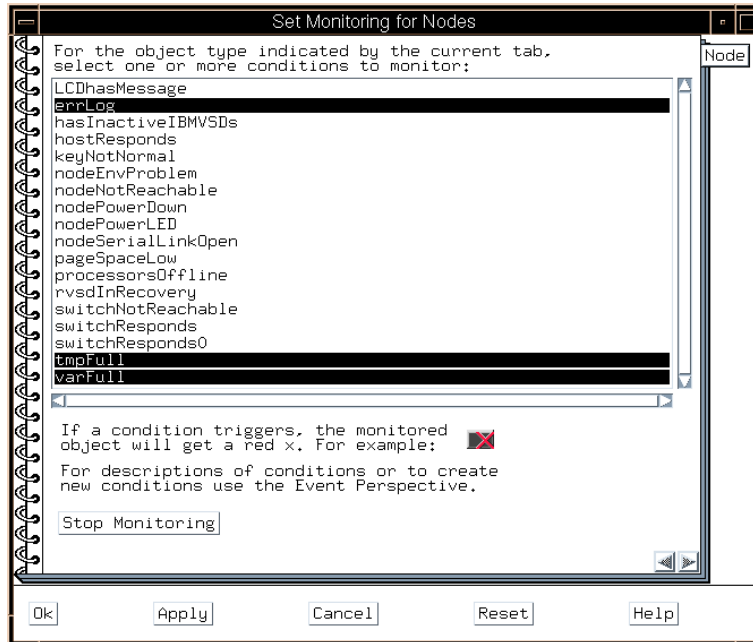

Figure 9. Set Monitoring for Nodes notebook

You can monitor as many conditions as you want. To monitor the AIX Error Log, the /tmp file system, and the /var file system, for example, select these three conditions. Then click on the **Apply** button.

Figure 10 on page 30 shows an example of the aggregate state of each Enterprise Server for the conditions you are monitoring.

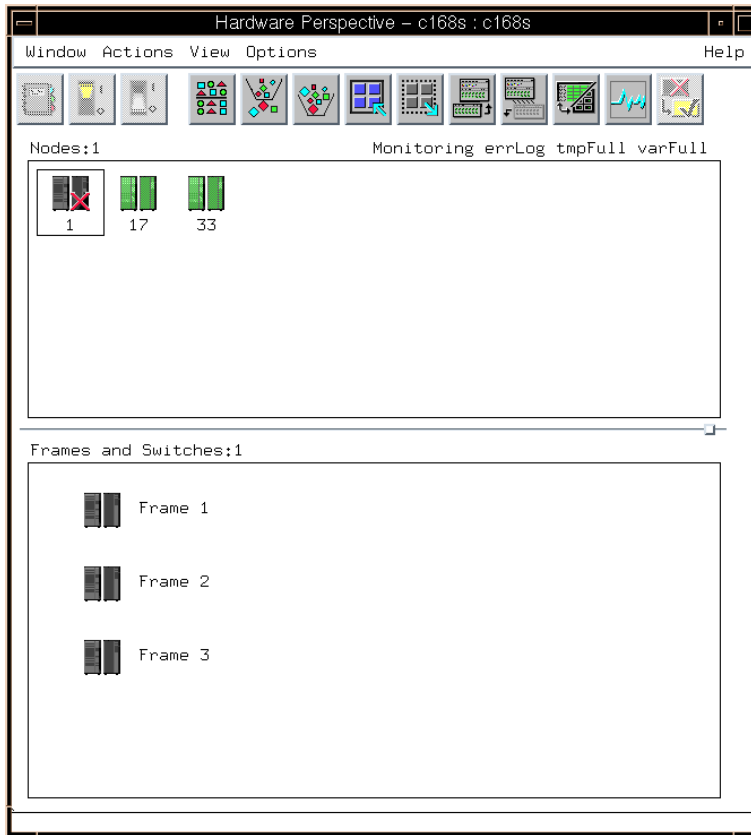

Figure 10. Monitoring system conditions

In this example, there is one red X on the first Enterprise Server (node 1). This means at least one of the selected conditions have been triggered on this Enterprise Server. If you would like to see which one has been triggered, double-click the **Node** icon to bring up the Monitored Conditions page of the "View or Modify Properties Node" notebook. This page is shown in Figure 11 on page 31.

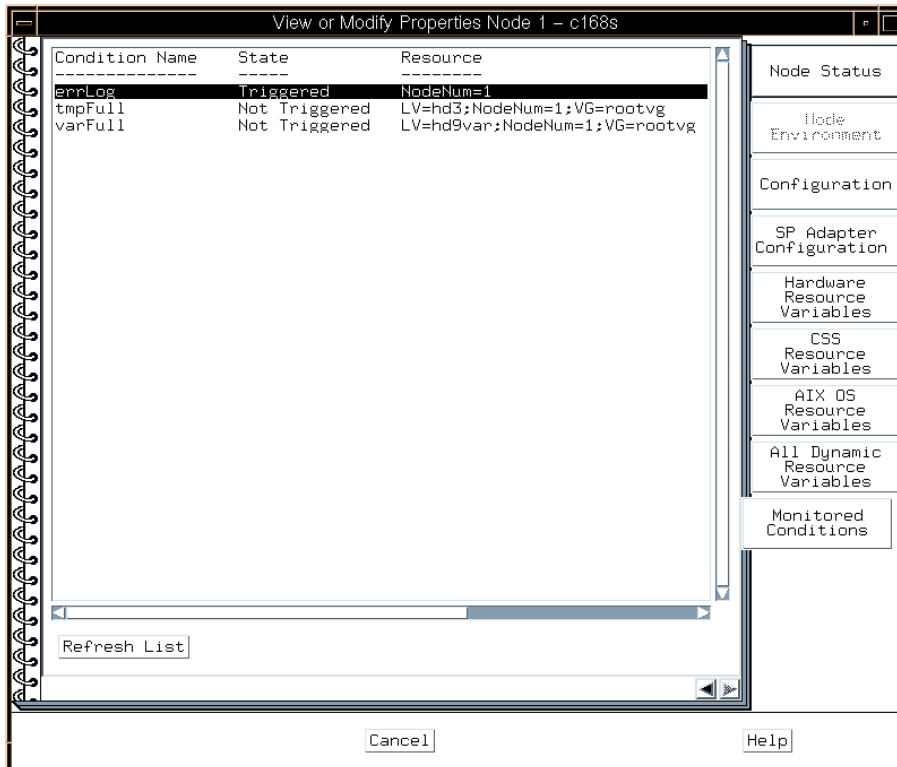

Figure 11. View or Modify Properties Node notebook (Monitored Conditions)

You can see here that the AIX Error Log on this Enterprise Server has triggered the condition.

### 3.3.4 Event Perspective

Using the *Event Perspective*, you can create event definitions that let you know automatically when resource changes that are important to you have occurred in your CES system. An event is the result of a change in the state of a resource on your CES system. Examples of resources include Enterprise Servers, disk drives, memory, software applications, and file systems.

Using the Event Perspective, you can be notified when an Enterprise Server goes down or becomes unreachable, or when the operating system is close to running out of paging space, or when there is something else wrong. More importantly, you can know these things have occurred without having the Event Perspective running.

When you double-click on the **Event Perspective** icon in the SP Perspectives Launch Pad shown in Figure 4 on page 23, the Event Perspective window shown in Figure 12 on page 32 shows up.

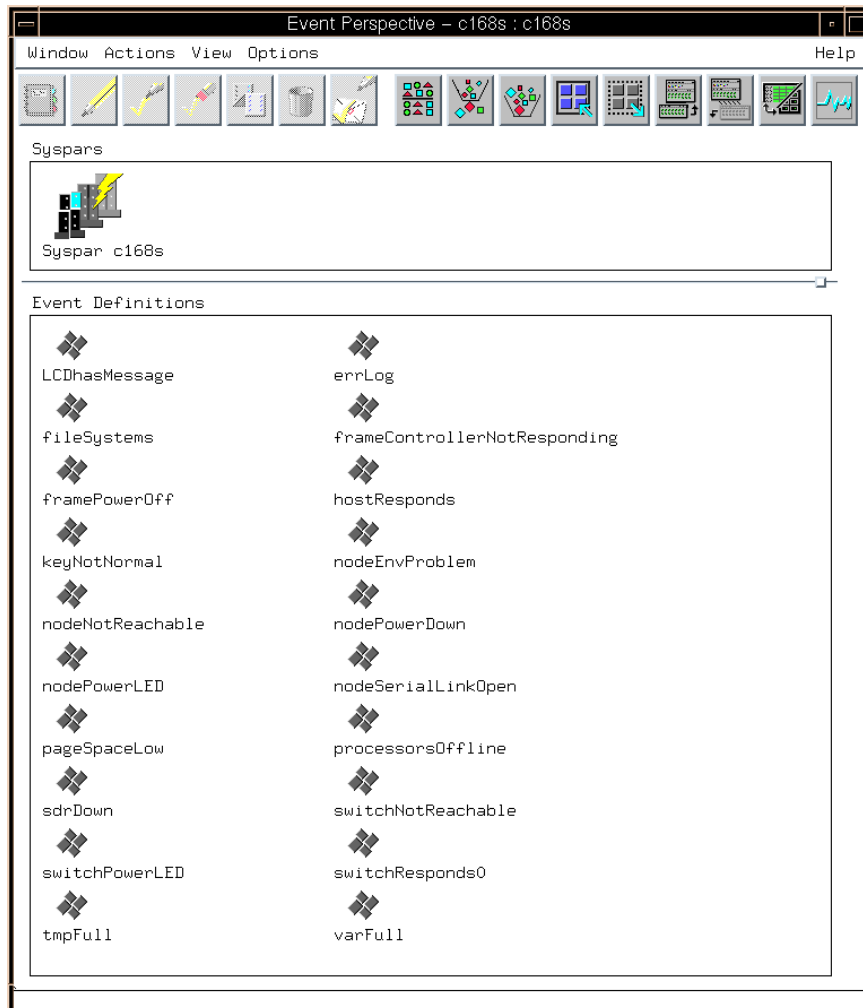

Figure 12. Event Perspective

There are 20 default event definitions provided. They are:

**LCDhasMessage**

The Enterprise Server's LED or LCD contains a message.

**errLog**

A permanent error entry has been added to the AIX Error Log.



**fileSystems**

One of the file systems is over 90 percent full.

**frameControllerNotResponding**

The frame controller is not responding.

**framePowerOff**

The power to the frame has been turned off.

**hostResponds**

The node is not responding.

**keyNotNormal**

The key mode switch on a node was taken out of the Normal position.

**nodeEnvProblem**

The environment indicator LED on the node is illuminated. A hardware problem has been detected.

**nodeNotReachable**

Group Services has found no way to communicate with the node. The node is presumed to be down.

**nodePowerDown**

The power to the node is off.

**nodePowerLED**

Node power is off (power LED != 1).

**nodeSerialLinkOpen**

The serial link to the node (TTY) is open.

**pageSpaceLow**

The paging space utilized on the node exceeds 85 percent.

**processorsOffline**

One or more processors may have been taken off-line.

**sdrDown**

The sdr daemon on the control workstation has died.

**switchNotReachable**

The switch adaptor on the node is not responding or the node is isolated.

**switchPowerLED**

Switch power is off.

**switchResponds0**

The switch adapter, CSS0-port 0, on the node is not responding, or the node is isolated.

### **tmpFull**

The file system for LV=hd3 and VG=rootvg is over 90 percent full.

### **varFull**

The file system for LV=hd9var and VG=rootvg is over 90 percent full.

Because of hardware limitations of CES systems, the following default definitions are not useful:

- framePowerOff
- keyNotNormal
- nodeEnvProblem
- nodePowerLED
- switchNotReachable
- switchPowerLED
- switchResponds0

#### **3.3.4.1 Registering an event definition**

If you are interested in some of these event definitions, you can use them by registering them.

For example, you are interested in monitoring that all the Enterprise Servers in your CES system are up and running. If this is the case, you can use the `hostResponds` event definition.

To register the `hostResponds` event definition, click the **hostResponds** event definition icon in the Event Definitions pane:



Then click the **Register** icon on the tool bar:



The `hostResponds` event definition icon changes into one with four colors:



That is all you need to do to register an event definition. Now, what you need to do is just wait for the events.

### 3.3.4.2 Checking event notification

When the event occurs, the event definition icon changes into an envelope icon:



At the same time, the Global View of Event Notification Log window, as shown in Figure 13, will pop up.

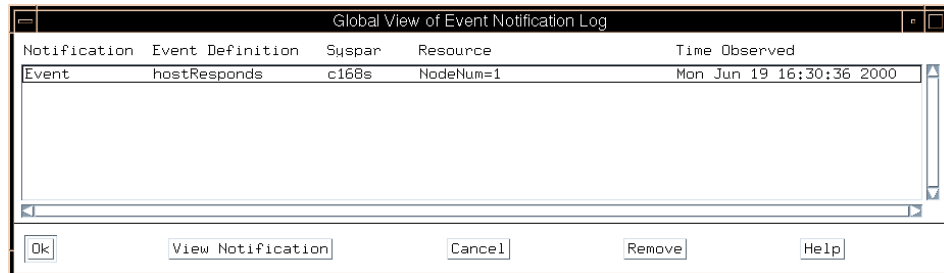

Figure 13. Global View of Event Notification Log window

You can see that the first Enterprise Server (node 1) lost its response on Mon Jun 19 16:30:36 2000.

### 3.3.4.3 Unregistering event definition

When you do not need to manage the event definition that you selected, you can unregister the event definition. Click the **hostResponds** event definition icon in the Event Definitions pane:



Then click the **Unregister** icon on the tool bar:



The icon changes back to grey:



You will not be notified if the event occurs.

---

## Chapter 4. Installation and migration

This chapter discusses three scenarios of building your CES system. They are:

- Installing a CES system with new Enterprise Servers

This is the case when you install your CES system from scratch. In this case, your Enterprise Servers are newly obtained, or you do not care about the software previously installed to them.

- Migrating existing Enterprise Servers to a CES system

This is the case when you have Enterprise Servers that are currently used for your business. You want to manage them from the single point of control. Therefore, you add a CWS to your Enterprise Servers and install PSSP on all of them.

- Migrating an existing SP system to a CES system

This is the case when you have an SP system with SP-attached servers. You want use all of your SP frames for other SP systems. Therefore, you remove all of your SP frames from your SP system and manage it as a CES system.

For details on installation and migration, see *IBM Parallel System Support Programs for AIX: Installation and Migration Guide, GA22-7347*.

---

### 4.1 Installing a CES system with new Enterprise Servers

In this case, you install your CES system from scratch. Your Enterprise Servers are either newly obtained or you do not care about the software previously installed to them. Use the steps described in Chapter 2, "Installing and Configuring a New RS/6000 SP System" in *IBM Parallel System Support Programs for AIX: Installation and Migration Guide, GA22-7347* to install this type of system.

For example, the installation of a CES system with one CWS and two Enterprise Servers is shown in Figure 14 on page 38.

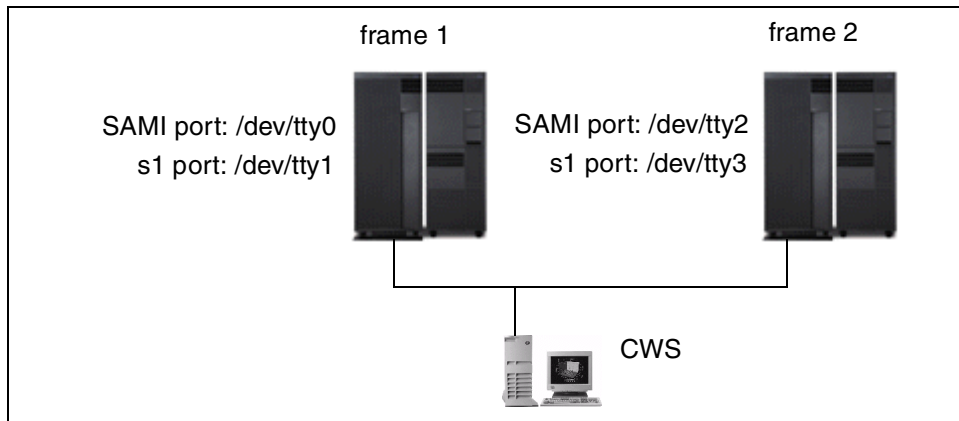

Figure 14. Installing a CES system with new Enterprise Servers

For “Step 29: Enter Frame Information and Reinitialize the SDR” described in Chapter 2, “Installing and Configuring a New RS/6000 SP System” of the *IBM Parallel System Support Programs for AIX: Installation and Migration Guide*, GA22-7347, you would use the `spframe` command for our example as follows:

```
# spframe -p SAMI -r yes 1 2 /dev/tty0
```

With this command, you added two Enterprise Servers as frames 1 and 2 and initialized the SDR. Frame 1 uses /dev/tty0 for the SAMI connection and /dev/tty1 for the s1 connection. Frame 2 uses /dev/tty2 for the SAMI connection and /dev/tty3 for the s1 connection.

You can assign any frame number to a frame as long as the number is between 1 and 128, inclusively. It is not necessary to start from frame 1. Also, the sequence of frame number assignment does not matter. For example, if you have three Enterprise Servers, you can add them to your CES system one by one in any order. You could add frame 28 first, frame 9 second, and then frame 57 third.

Instead of using the `spframe` command, you can use SMIT menus for these operations. For more information on the `spframe` command, refer to 3.2.1, “The `spframe` command” on page 19.

If you are considering migrating your CES system to a SP system in the future, you have to consider switch port numbers. This is discussed in Chapter 5, “Scaling up an existing CES system to an SP system” on page 45.

## 4.2 Migrating existing Enterprise Servers to a CES system

In this case, you have Enterprise Servers that are currently used for your business. You want to manage them from a single point of control. Therefore, you add a CWS to your Enterprise Servers and install PSSP to all of them as shown in Figure 15 on page 39.

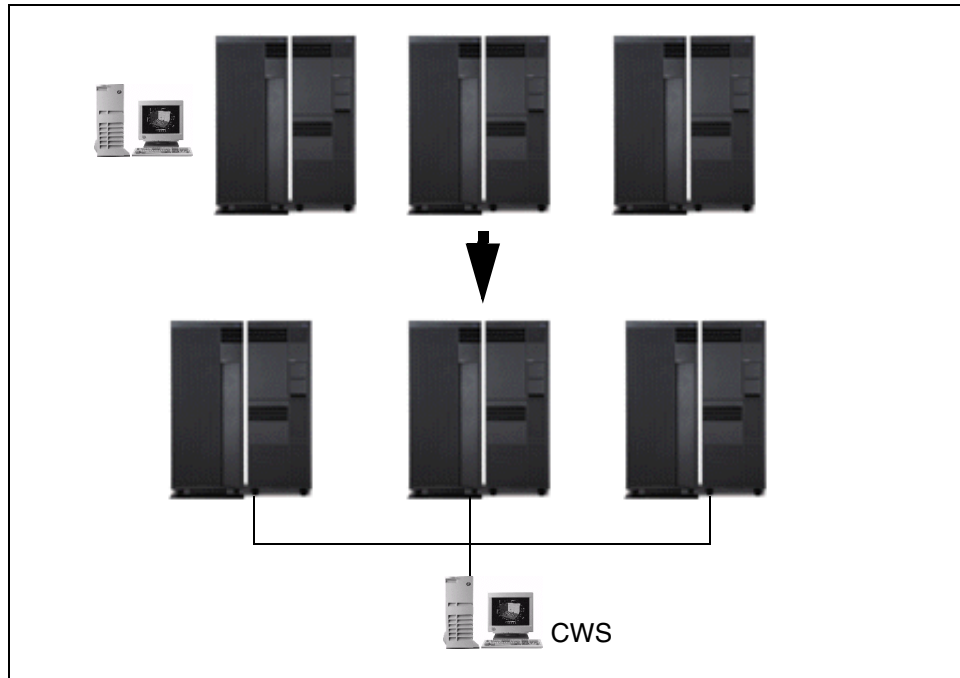

Figure 15. Migrating existing Enterprise Servers to a CES system

Performing the steps described in Chapter 6, “Reconfiguring the RS/6000 SP system” in *IBM Parallel System Support Programs for AIX: Installation and Migration Guide*, GA22-7347, you can migrate your Enterprise Servers to a CES system without reinstalling their software. These steps preserve your existing software environment.

The following steps are excerpted from the *IBM Parallel System Support Programs for AIX: Installation and Migration Guide*, GA22-7347 (section “Adding Nodes” in Chapter 6). These are the steps that you have to pay special attention to:

### **Step 9: Set up nodes to be installed**

In this step, you must set the node to “customize” instead of “install.” For example:

```
spbootins -r customize -l 33
```

### **Step 18: Network boot optional boot/install servers**

In this step, you must proceed with the following operations:

#### **Step 18.1: Upgrade AIX:**

If your Enterprise Server is not at AIX 4.3.3, you must first upgrade to that level of AIX before proceeding.

#### **Step 18.2: Set up name resolution of the enterprise server:**

In order to execute a PSSP customization, the following must be resolvable on the Enterprise Server:

- The CWS host name.
- The name of the boot/install server's interface that is attached to the Enterprise Server's en0 interface.

#### **Step 18.3: Set up routing to the CWS host name:**

If you have a default route set up on the Enterprise Server, you will have to delete it. If you do not remove the route, customization will fail when it tries to set up the default route defined in the SDR. In order for customization to occur, you must define a static route to the CWS's host name. For example, if the CWS's host name is its token ring address, such as 9.114.73.76, and your gateway is 9.114.73.256, execute the following:

```
route add -host 9.114.73.76 9.114.73.256
```

#### **Step 18.4: FTP the SDR\_dest\_info file:**

During customization, certain information will be read from the SDR. In order to get to the SDR, you must FTP the /etc/SDR\_dest\_info file from the CWS to the /etc/SDR\_dest\_info file on the Enterprise Server and check the mode and ownership of the file.

#### **Step 18.5: Verify perfagent:**

Ensure that perfagent.tools 2.2.32.x is installed on the Enterprise Server.

#### **Step 18.6: Mount the pssplpp directory:**

Mount the /spdata/sys1/install/pssplpp directory on the boot/install server from the Enterprise Server. For example, issue:

```
mount k3n1:/spdata/sys1/install/pssplpp /mnt
```

#### **Step 18.7: Install ssp.basic:**

Install ssp.basic and its prerequisites onto the Enterprise Server. For example, issue:

```
installp -aXgd/mnt/PSSP-3.2 ssp.basic 2>&1 | tee /tmp/install.log
```



**Step 18.8: Unmount the pssplpp directory:**

Unmount the /spdata/sys1/install/pssplpp directory on the boot/install server from the Enterprise Server. For example, issue:

```
umount /mnt
```

**Step 18.9: Run pssp\_script:**

Run the pssp\_script by issuing:

```
/usr/lpp/ssp/install/bin/pssp_script
```

**Step 18.10: Reboot:**

Perform a reboot. For example:

```
shutdown -Fr
```

**Planning consideration**

By migrating your Enterprise Servers to a CES system, you can manage them effectively and easily. However, you need to consider other factors that will influence your migration plans:

- A CWS must run AIX 4.3.3 and PSSP 3.2.
- All the Enterprise Servers in a CES system must be installed with one of the combinations of AIX and PSSP that are supported for coexistence described in 2.2.4, “Coexistence” on page 17.

If you are thinking of scaling up your CES system to an SP system in the future, you have to consider switch port numbers. This is discussed in Chapter 5, “Scaling up an existing CES system to an SP system” on page 45.

---

**4.3 Migrating an existing SP system to a CES system**

This is the case when you have an SP system with SP-attached servers and you want to use all of your SP frames for other SP systems. Therefore, you remove all of your SP frames from your SP system and manage the remaining SP-attached servers as a CES system.

Assume your SP system has three SP frames (frames 1, 4, and 6) and three SP-attached servers (frames 2, 3, and 5). You would like to remove all of the SP frames from your SP system and create a CES system with all of the SP-attached servers. This process is illustrated in Figure 16 on page 42.

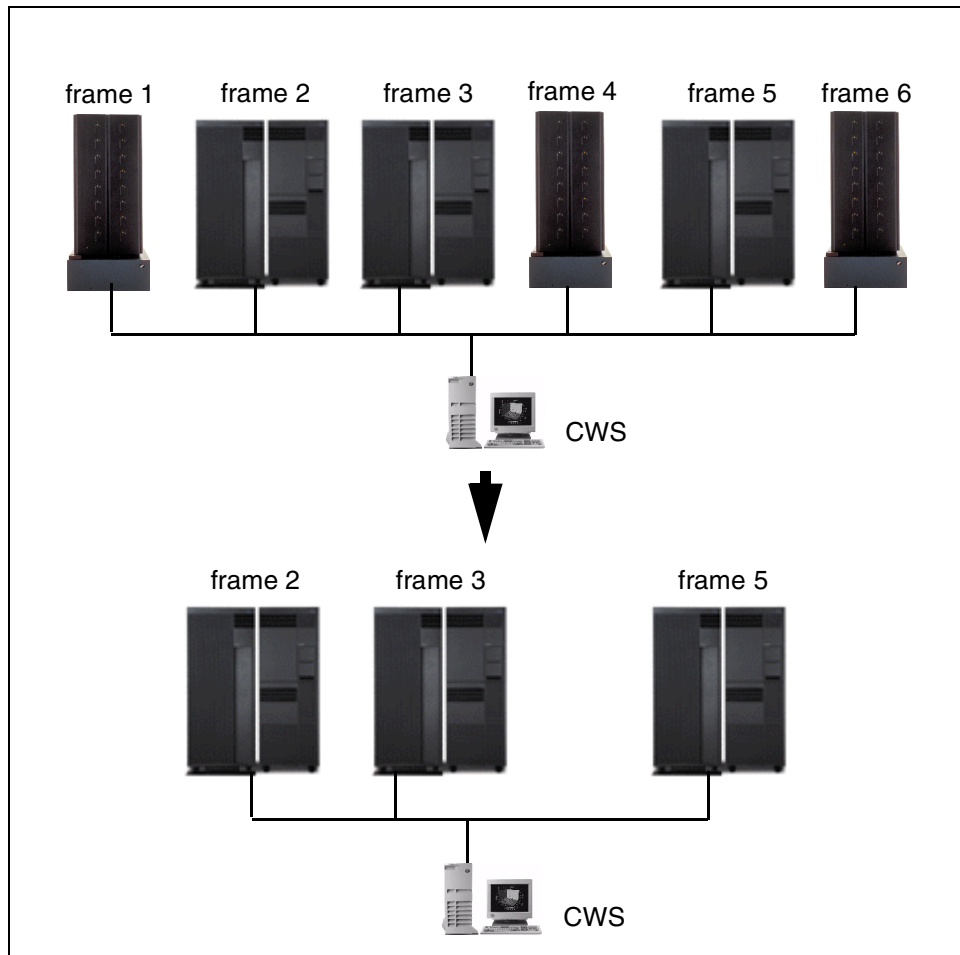

Figure 16. Migrating an existing SP system to a CES system

An important point to know here is that you have to remove all the SP frames at the same time. You are not allowed to remove them one by one. To remove all the SP frames from your SP system at the same time, use the `spdelfram` command with the `-l` flag as follows:

```
# spdelfram -c -l 1,4,6
```

In this example, you removed the SP frames (frames 1, 4, and 6) at the same time. For more information on the `spdelfram` command, refer to 3.2.2, “The `spdelfram` command” on page 21.

### **Planning consideration**

By migrating your SP system to a CES system, you can manage your Enterprise Servers effectively and easily. However, you need to consider other factors that will influence your migration plans:

- A CWS must be migrated to AIX 4.3.3 and PSSP 3.2 before you do this migration.
- Each of the Enterprise Servers in the CES system must have one of the PSSP and AIX software combinations that are supported for coexistence installed on them as described in 2.2.4, “Coexistence” on page 17.
- You need to consider the dependencies and limitations that exist between applications. For example, if you currently run General Parallel File System (GPFS), IBM Virtual Shared Disk (VSD), Recoverable Virtual Shared Disk (RVSD), and/or any applications that are dependent on these applications, they are not supported with CES systems and must be removed. For more information on limitations of CES systems, refer to 2.2.2, “Software limitations” on page 16.



---

## Chapter 5. Scaling up an existing CES system to an SP system

Note that while planning your CES system, it can become a larger scale SP system in the future. No type of SP Switch is supported in a CES system configuration. However, with future growth, you might eventually add SP frames to your CES system to make it an SP system. Your system will then be subject to all the rules of an SP system, and your Enterprise Servers will become SP-attached servers. In addition, SP Switches are supported for this SP configuration. If this sounds like a possibility for your CES system, plan your CES system with appropriate frame numbers and switch port numbers as if you are planning for SP-attached servers with SP frames so that you can migrate to an upscaled SP system in the future without having to totally reconfigure your existing CES system.

If you already understand SP system configurations, skip to 5.4, “Adding SP frames to a CES system” on page 54.

### Attention

All the configuration rules described in this chapter apply only for the SP Switch. They do not apply for the SP Switch2. At this time, SP-attached servers are not supported on the SP Switch2.

---

### 5.1 Numbering rules

Before starting a discussion on frame numbers and switch port numbers, you need to have clear idea about the numbering rules for SP systems. In particular, you have to know that switch port numbers are assigned differently in switched SP systems and switchless SP systems.

#### **Frame number**

The administrator establishes the frame numbers when the system is installed. Each frame is referenced by the tty port to which the frame supervisor is attached and is assigned a numeric identifier by the user. The order in which the frames are numbered determines the sequence in which they are examined during the configuration process. This is a system-wide number. You can choose any number for a frame as long as it is between 1 and 128, inclusively:

```
1 =< frame_number =< 128
```

**Slot number**

Each tall SP frame contains eight drawers that have two slots each for a total of 16 slots. When viewing a tall SP frame from the front, the 16 slots are numbered sequentially from bottom left to top right as shown in Figure 17. The slot number is a frame-wide number. The numbering of slots is the same for frames with or without an SP Switch. Therefore, the number is always between 1 and 16, inclusively:

$$1 \leq \text{slot\_number} \leq 16$$

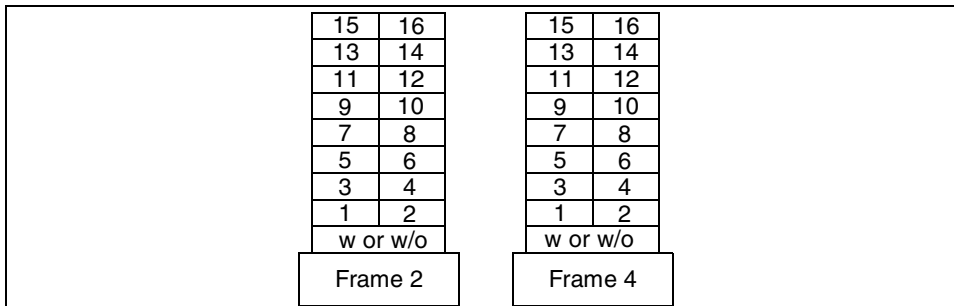

Figure 17. Slot number example

**Node number**

The node number is the primary means by which an administrator can reference a specific node in the system. Node numbers are assigned for all nodes regardless of node or frame type. This is the system-wide number. The numbering of nodes is the same for frames with or without an SP Switch. The number is calculated by the following formula:

$$\text{node\_number} = ((\text{frame\_number} - 1) \times 16) + \text{slot\_number}$$

An example of how to calculate node numbers based on frame numbers and slot numbers can be seen in Figure 18.

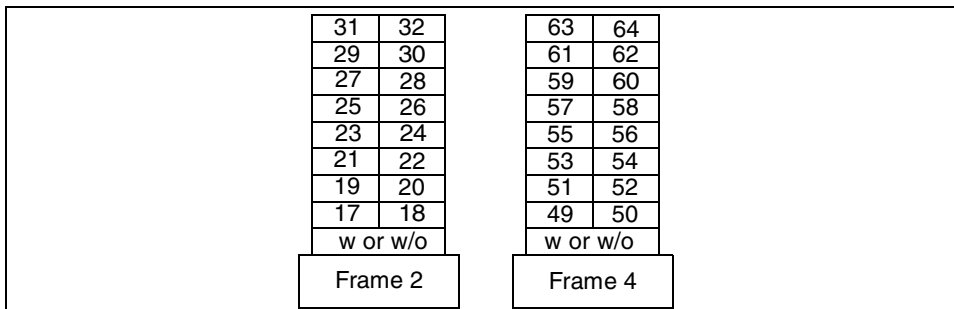

Figure 18. Node number example

In the previous example, all of the nodes in the frames are thin nodes, and each occupy one slot. An SP system may also contain wide nodes, each of which occupy two slots (one drawer), and high nodes, each of which occupy four slots (two drawers). To calculate node numbers for these nodes, use the previous formula with the lowest slot number that the node occupies.

The SP system can have anywhere between one and 128 processor nodes<sup>1</sup>. However, each node can be assigned node numbers from one to 2048 based on its location since a system can have frame numbers up to 128. For example, the node in slot 16 of frame 128 would have a node number of 2048.

### **Switch number**

Each SP Switch board has a switch number. SP Switch boards are numbered sequentially starting with 1 for the first SP Switch board added to the system. Each additional SP Switch board added to the system is assigned the next sequential value. This is a system-wide number:

```
1 =< switch_number
```

### **Port number**

Each full switch board contains a range of 16 ports to connect to nodes. These ports have sequentially assigned switch board-wide numbers between 0 and 15, inclusively:

```
0 =< port_number =< 15
```

### **Switch port number (also known as switch node number)**

As already mentioned, each full switch board contains a range of 16 ports to connect to nodes. A unique switch port number exists for each of these port numbers of each SP Switch board. These numbers are system-wide numbers.

If an SP system has an SP Switch, as shown in Figure 19 on page 48, a switch port number is calculated with the following formula:

```
switch_port_number = ((switch_number - 1) x 16) + port_number
```

<sup>1</sup> SP systems with more than 128 processor nodes are available on a special order basis.

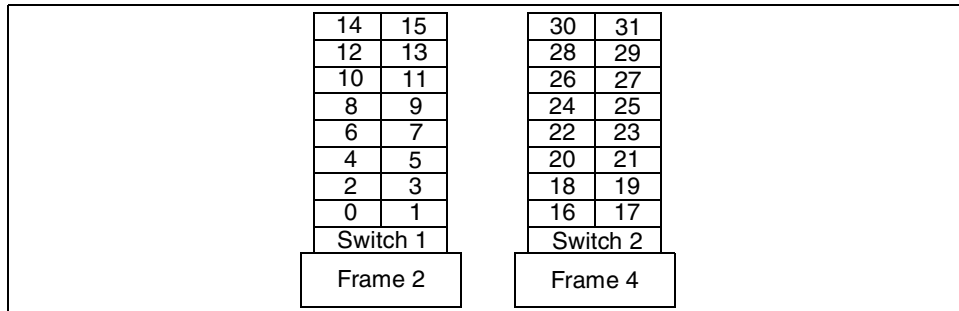

Figure 19. Switch port number example for a switched SP system

In the previous example, frame 2 contains switch port numbers 0 through 15, and frame 4 contains switch port numbers 16 through 31.

If an SP system does not have an SP Switch, as shown in Figure 20, the PSSP software still assigns switch port numbers. These switch port numbers are evaluated using frame numbers and slot numbers with the following formula:

$$\text{switch\_port\_number} = ((\text{frame\_number} - 1) \times 16) + \text{slot\_number} - 1$$

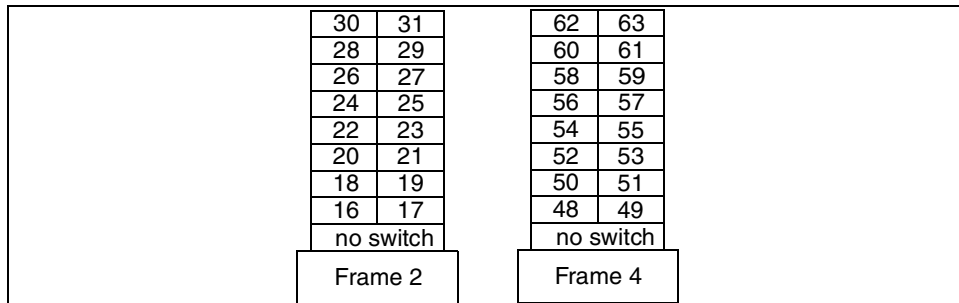

Figure 20. Switch port number example for a switchless SP system

In the previous example, frame 2 contains switch port numbers 16 through 31, and frame 4 contains switch port numbers 48 through 63.

---

## 5.2 Configuring an SP system with an SP Switch

In order to properly plan an SP system with an SP Switch, you must understand the supported frame and switch configurations and the distribution of the switch port number assignments in each of the supported configurations.



**Note**

An SP system with SP Switch2 switches has a different configuration from an SP system with SP Switches.

The SP system with the SP Switch supports the four possible frame and switch configurations shown in Figure 21 on page 50. The numbers in the frames are the switch port numbers. Think of each configuration as a *switch capsule* that is comprised of a *switched frame* and its possible companion *non-switched expansion frames*. A non-switched expansion frame is a successor frame within the switch capsule that has SP nodes using the switch ports of the switched frame that comes before it.

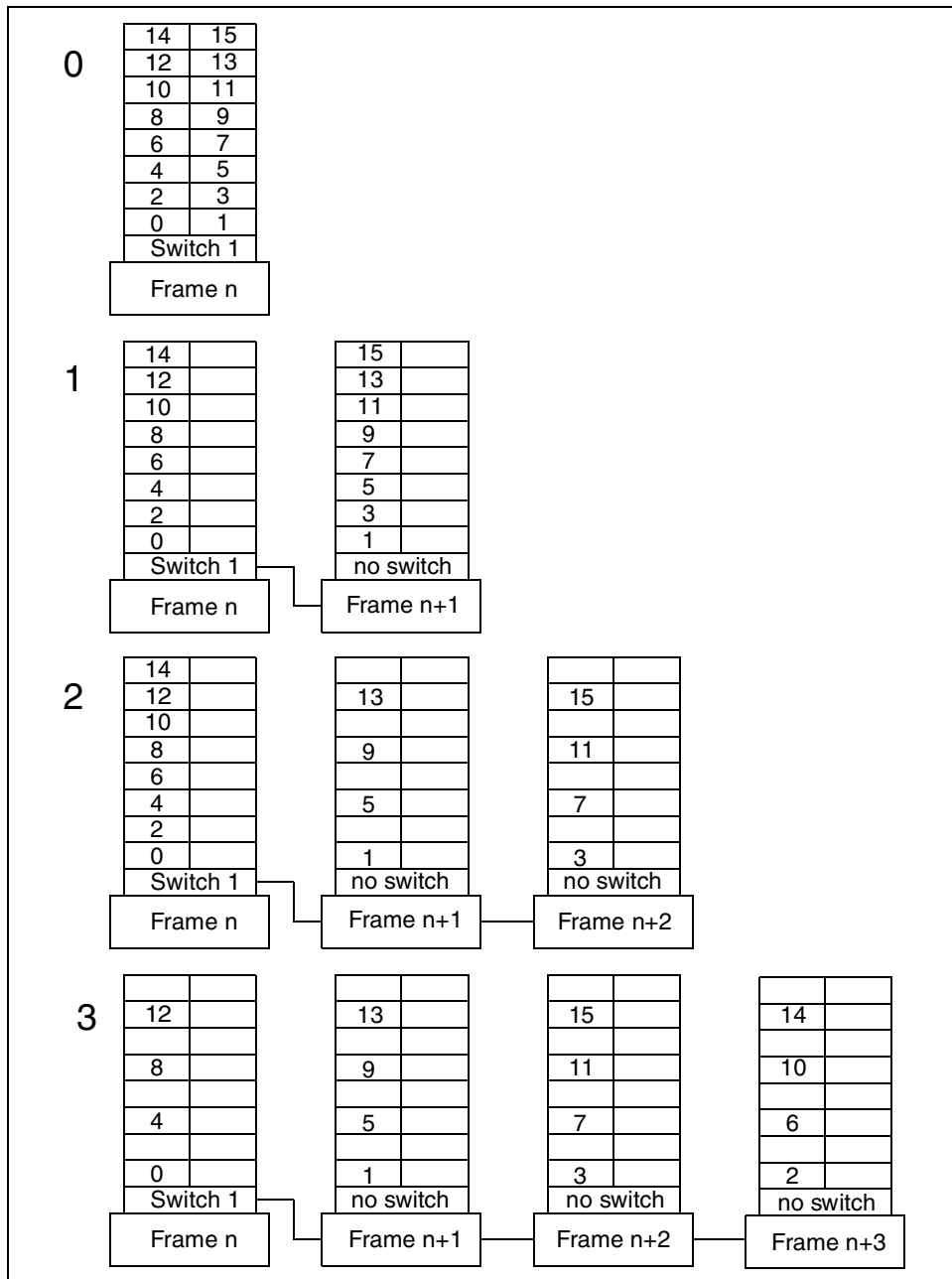

Figure 21. Four possible frame and switch configurations

Figure 21 on page 50 illustrates the four switch capsule configurations that are supported and the switch port number assignments in each:

**Configuration 0**

A switched frame without any non-switched expansion frames can be populated as you please.

**Configuration 1**

A switched frame with one non-switched expansion frame has eight valid node placement slots in each frame.

**Configuration 2**

A switched frame with two non-switched expansion frames has eight valid node placement slots in the first frame and only four in each of the other two.

**Configuration 3**

A switched frame with three non-switched expansion frames has four valid node placement slots in each frame.

In Figure 21, the switch port numbers (this figure uses switch number 1) indicate a valid slot in which a node can be placed. The absence of a switch port number indicates that a node cannot be placed in that slot.

For nodes which occupy multiple slots (wide nodes and high nodes), the lowest slot that the node occupies (and only that slot) in the frame must have a valid unused switch port number associated with it.

The four switch capsule configurations can be repeated and mixed throughout your SP system. For example, consider an SP system with a switched frame followed by two non-switched expansion frames. They, in turn, might be followed by another switched frame and one more non-switched expansion frames. This SP system is, therefore, comprised of one switch capsule matching configuration 2 followed by another switch capsule matching configuration 1. This SP system is illustrated in Figure on page 52. The SP

frame number must satisfy the following conditions:  $1 \leq A$ ,  $A+2 < B$ ,  $B+1 \leq 128$

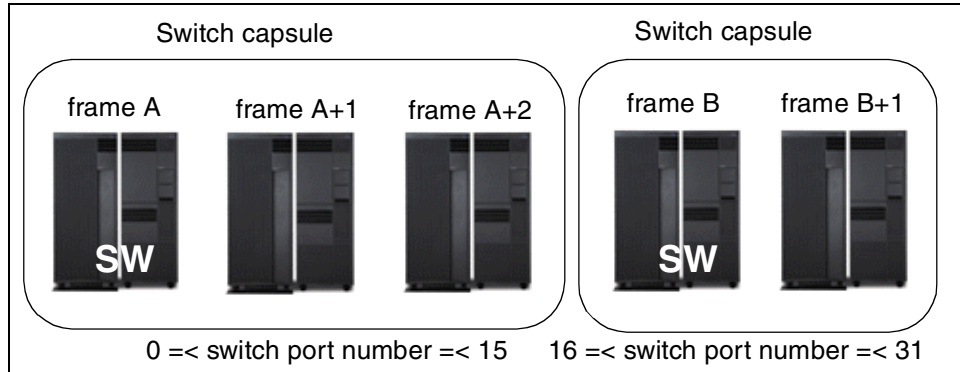

Figure 22. SP system with two capsules

In each capsule, the switch port numbers assigned to the capsule increment based on the capsule's switch number. In the previous example, the frames in the first switch capsule (matching configuration 2) are assigned switch port numbers 0 through 15, and the frames in the second switch capsule (matching configuration 1) are assigned switch port numbers 16 through 31.

Keep in mind that any non-switched expansion frames must have frame numbers that immediately follow their associated switched frame without any gaps. For instance, if a system has a switched frame numbered 1, and two non-switched expansion frames attached to the switch on frame 1, the non-switched expansion frames must be numbered 2 and 3.

Frame numbers can be skipped between switched frames, and we suggest you skip numbers to allow for future expansion. For example, consider a system that has a switched frame with four high nodes and another switched frame with 16 thin nodes. To accommodate future expansion, it would be wise to assign number 1 to the high node frame and number 5 to the thin node frame. This allows for the future addition of up to three non-switched expansion frames to the high node frame without disrupting the system. If the thin node frame had been numbered frame 2, the addition of a non-switched expansion frame would require you to reconfigure the thin node frame and all of its nodes.

---

### 5.3 Adding SP-attached servers to an SP system

An SP-attached server is managed by the PSSP software as though it is a node in a frame of its own. However, it is treated differently than an SP frame. It has the following characteristics:

- It is the only node in its frame. It begins in slot number 1 and occupies the full 16 slots in the frame, using slot number 1 to calculate its node number. Therefore, 16 is added to that node number to derive the next available node number.
- It connects to an available switch port number of an existing SP frame. An available switch port number is defined as a switch port number not used by any other node. Note that the switch port number associated with a slot may still be available if the slot is occupied by a node. For example, a high node occupies four slots but only uses the switch port number associated with the lowest slot it occupies. Any switch port number associated with the other three slots is available.
- It cannot be within a switch capsule (between a switched frame and any non-switched expansion frame within a capsule). Give it a frame number that fits before, between, or after switch capsules.
- It is not supported with the SP Switch2.

If you want to add one SP-attached server to the SP system, as shown in Figure on page 52, there are three possible positions that you can place the SP-attached server in. These positions are illustrated in Figure 23 on page 54 as follows:

- Before frame A ( $1 \leq C < A$ )
- Between frame A+2 and frame B ( $A+2 < C < B$ )
- After frame B+1 ( $B+1 < C \leq 128$ )

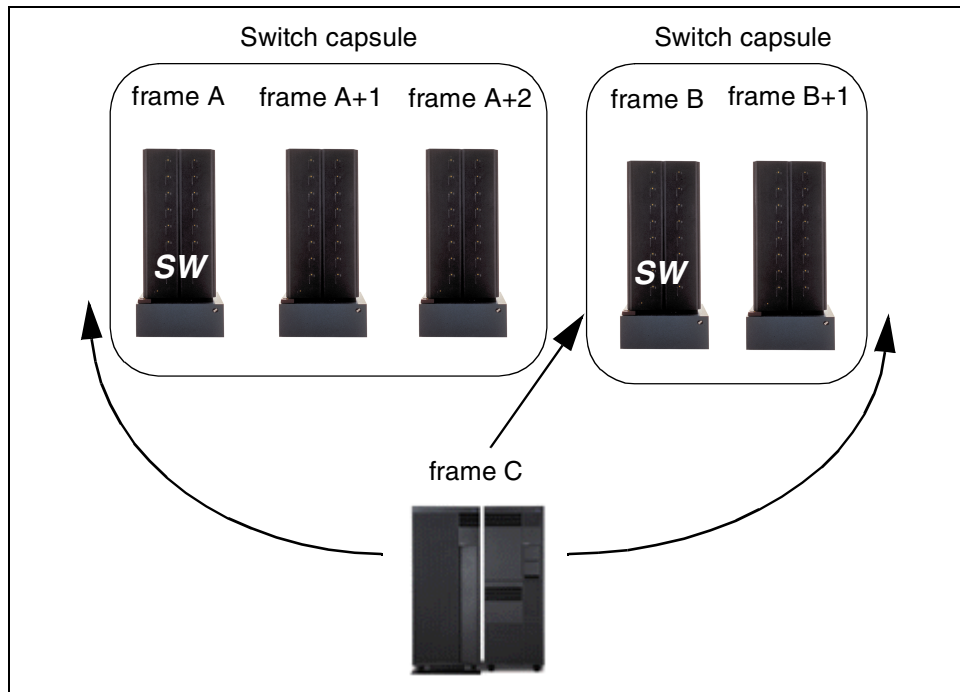

Figure 23. Adding SP-attached servers

The SP-attached server that you add can connect to any available switch port of an existing SP frame. In this example, the SP-attached server can connect to an SP Switch board in either frame A or frame B. It is not dependent on where you have placed the SP-attached server.

#### 5.4 Adding SP frames to a CES system

This section discusses upgrading an existing CES system to an SP system. The previous section discusses the case where you add SP-attached servers to an SP system. There are similar conditions when you add SP frames to a CES system. Remember, when you add SP frames to a CES system, the system is no longer a CES system. It is an SP system.

Assume your CES system has two Enterprise Servers, and you want to add one SP frame with an SP Switch and one non-switched expansion frame that is in the same switch capsule. In this case, there are three possible positions that you can place the SP frames (one switch capsule) in. These positions are illustrated in Figure 24 on page 55:

- Before frame A ( $1 \leq C, C+1 < A$ )

- Between frame A and frame B ( $A < C$ ,  $C+1 < B$ )
- After frame B ( $B < C$ ,  $C+1 \leq 128$ )

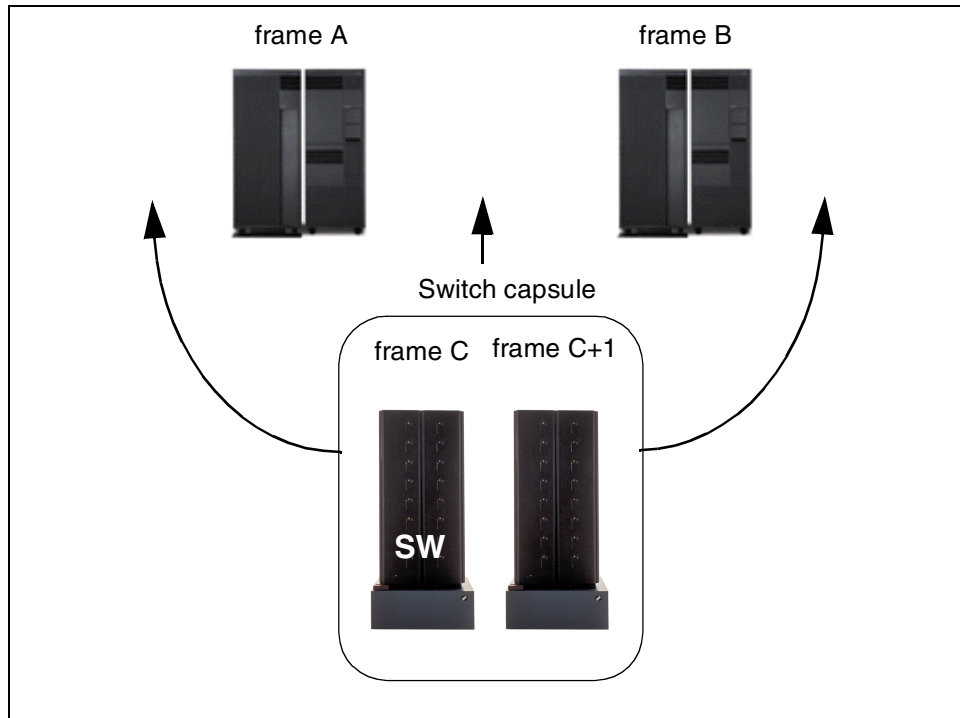

Figure 24. Adding SP frames

The SP-attached servers can each connect to any available switch port of an existing SP frame. In this case, SP-attached servers can connect to the SP Switch board in frame C. It does not matter where you have placed the SP frames.

#### 5.4.1 Adding SP Switch adapters

When adding SP Switch adapters using the `spadaptrs` command with the `-n yes` flag (this is the default), the starting IP address may not necessarily be the lowest IP address in the system due to the new configurations allowed in an SP system from the addition of CES support to PSSP. Be sure to use the IP address of the lowest numbered node in the system as opposed to the lowest IP address in the system.

Assume your SP system has two SP-attached servers (frame 1 and 2) and one SP frame with an SP Switch (frame 3). The two SP-attached servers use

switch port numbers 11 and 15. One high node is placed in slot 1 and uses switch port number 0. This is illustrated in Figure 25 on page 56.

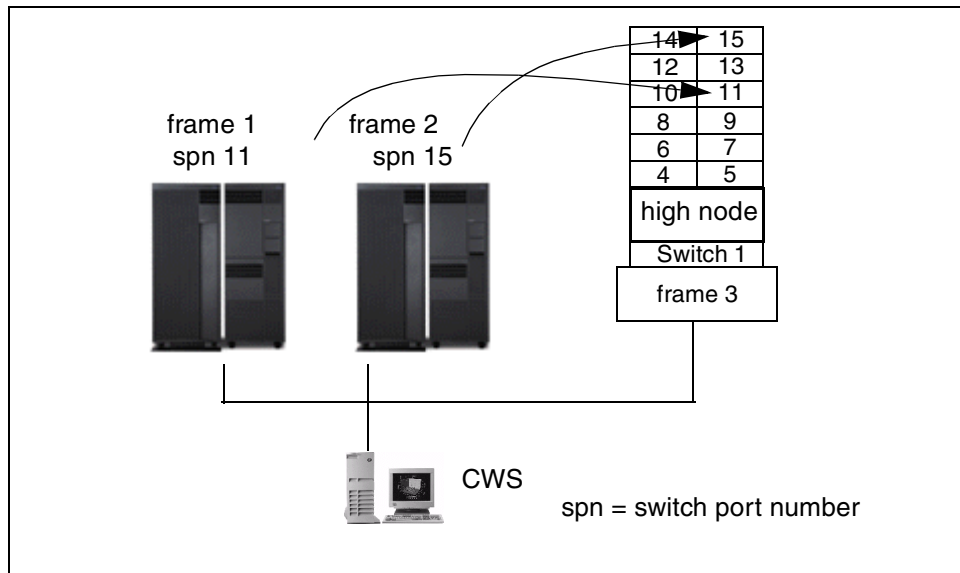

Figure 25. Adding SP Switch adapters

Now, you want to assign IP addresses to the SP Switch adapters as shown in Table 1.

Table 1. Node number and IP address

Node number	IP address	Netmask
1	129.33.34.11	255.255.255.0
17	129.33.34.15	255.255.255.0
33 (high node)	129.33.34.0	255.255.255.0

In this case, the lowest IP address is node 33 (high node). However, you can not assign IP addresses to SP Switch adapters as follows:

```
spadptrs 3 1 3 css0 129.33.34.0 255.255.255.0
```

Instead, use the IP address of the node with the lowest node number as follows:

```
spadptrs 1 1 3 css0 129.33.34.11 255.255.255.0
```



---

## 5.5 Recommended expansion plan

The previous section described the basic rules that you have to keep when you add SP frames to a CES system. However, if you are thinking of scaling up your CES system to an SP system in the future, you have to plan out appropriate frame numbers and switch port numbers for your Enterprise Servers so that they will still be valid when you add SP frames at a later time.

There can be many expansion plans. The following section is one example plan we recommend. It can be used as a general plan. After understanding it, you can modify it according to your situation.

### Attention

You have to plan the appropriate frame and switch port numbers that will work in an SP system with SP frames when you first install your CES system. This way you can migrate to an SP system without having to reconfigure your Enterprise Servers that are already installed.

### 5.5.1 When a CES system has 1 to 12 Enterprise Servers

When a CES system has 1 to 12 Enterprise Servers, assign them frame numbers 5 through 16 as shown in Figure 26.

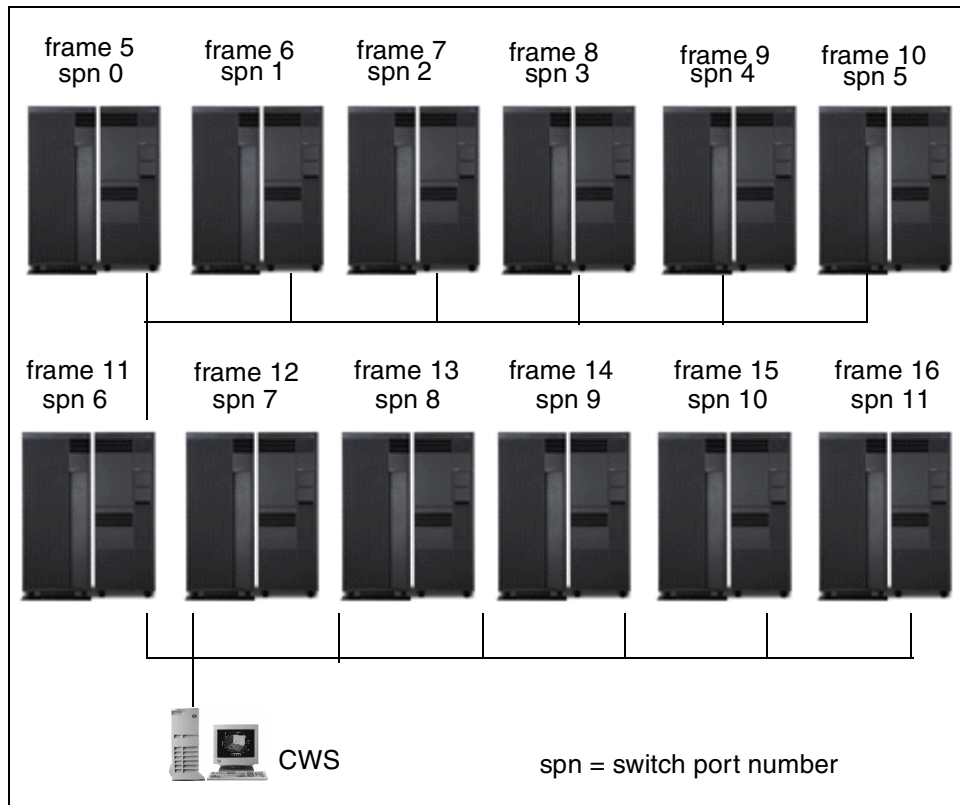

Figure 26. A CES system with 1 to 12 Enterprise Servers

You can add them to your system by using the `spframe` command as follows:

```
spframe -p SAMI -r yes 5 12 /dev/tty0
```

By this operation, switch port numbers 0 to 11 are automatically assigned as shown in Figure 26 on page 58.

**Why do you need to start with frame number 5?**

Assume your CES system has two Enterprise Servers. You may add them by using the `spframe` command as follows:

```
spframe -p SAMI -r yes 1 2 /dev/tty0
```

By this operation, you assigned frame numbers 1 and 2 to the Enterprise Servers. Switch port numbers 0 and 1 are automatically assigned to them as shown in Figure 27.

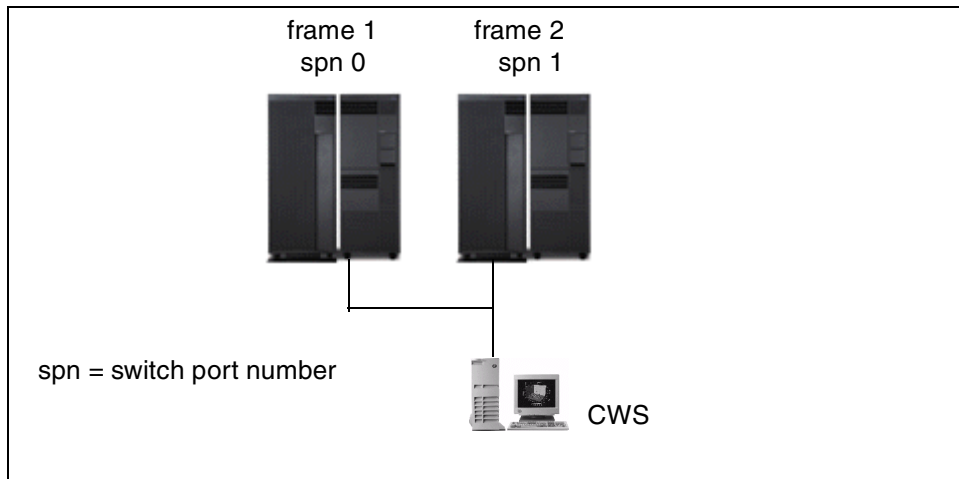

Figure 27. A CES system with two Enterprise Servers (frame 1 and 2)

Later, you decide to add an SP frame *with an SP Switch* to your CES system. Due to the fact that a frame number cannot be 0 (zero), you add it as frame 3 as follows:

```
spframe -r yes 3 1 /dev/tty4
```

As long as you do not place an SP node in either slot 1 or 2 (switch port number 0 or 1), there is no problem. Your frames 1 and 2 use switch port numbers 0 and 1 of the SP frames as shown in Figure 28 on page 60.

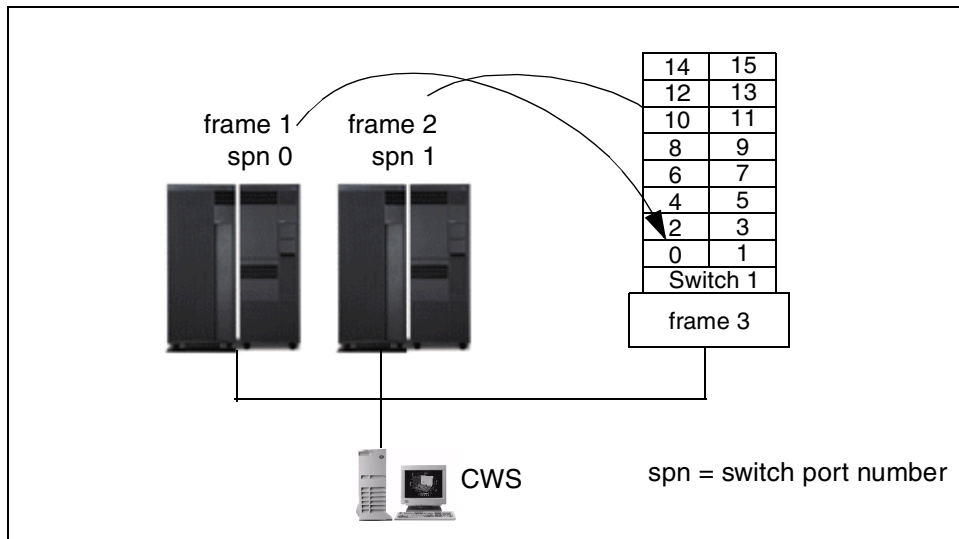

Figure 28. An SP system with two SP-attached servers and one switched SP frame

However, if you decide to add an SP frame *without an SP Switch* to your CES system, this will be a problem. Since the frame number cannot be 0 (zero), you add it as frame 3 as follows:

```
spframe -r yes 3 1 /dev/tty4
```

Since frame 3 does not have an SP Switch, switch port numbers 32 through 47 are assigned to frame 3 as shown in Figure 29 on page 61. Refer to 5.1, "Numbering rules" on page 45 for the switch port number formula. Remember, if you add SP frames to your CES system, it is no longer a CES system. It is now an SP system. Therefore, your Enterprise Servers become SP-attached servers which require switch port numbers available in an SP frame, which in this case are switch port numbers 0 and 1. Unfortunately, there is no switch port 0 or 1 available in this system. Switch port numbers 0 and 1 do not even exist in this system.

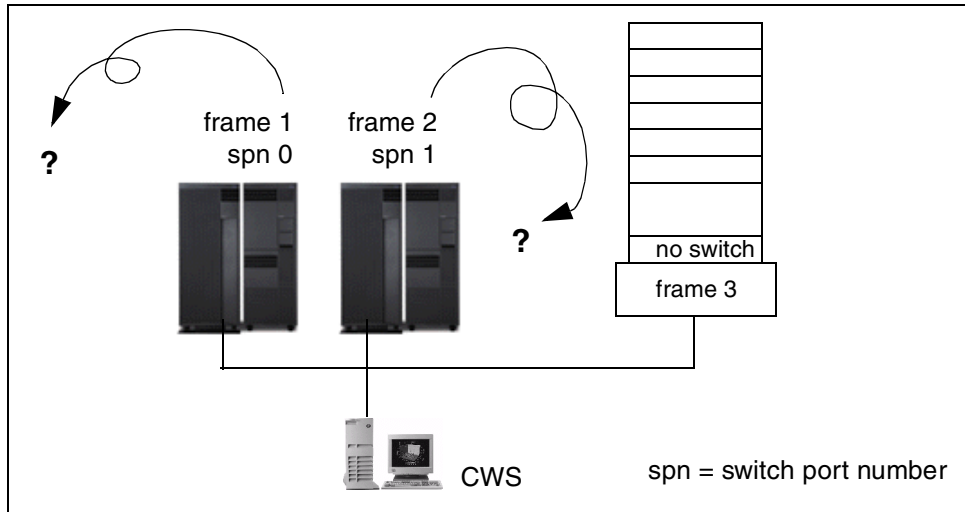

Figure 29. An SP system with two SP-attached servers and one switchless SP frame

To avoid this problem, assign your Enterprise Servers frame numbers 2 and 3, for example, when you install your CES system. You can add them by using the `spframe` command as follows:

```
spframe -p SAMI -r yes 2 2 /dev/tty0
```

By this operation, switch port numbers 0 and 1 are automatically assigned to them as shown in Figure 30.

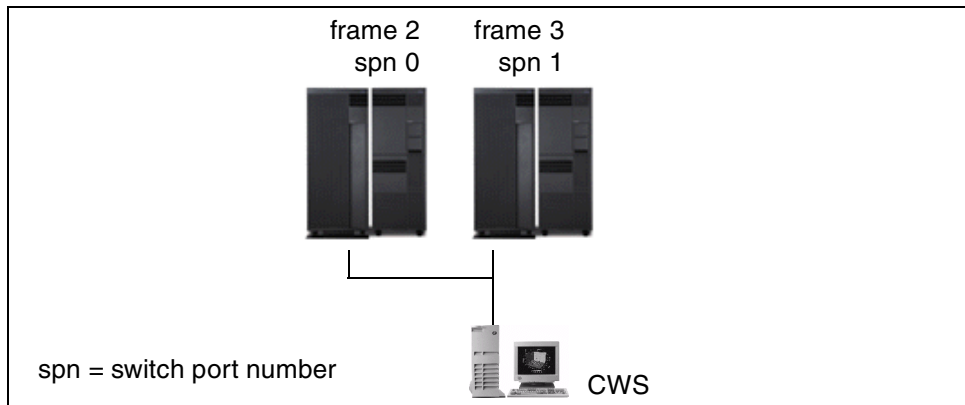

Figure 30. A CES system with two Enterprise Servers (frame 2 and 3)

Then, you decide to add an SP frame *with or without an SP Switch* to your CES system. Because frame number 1 is available, add an SP frame as frame 1 by using the `spframe` command as follows:

```
spframe -r yes 1 1 /dev/tty4
```

Either with or without an SP Switch, frame 1 is assigned switch port numbers 0 through 15. As long as you do not place an SP node in either slot 1 or 2 (switch port number 0 or 1), there is no problem. Your frame 2 and 3 use switch port numbers 0 and 1 of frame 1 as shown in Figure 31.

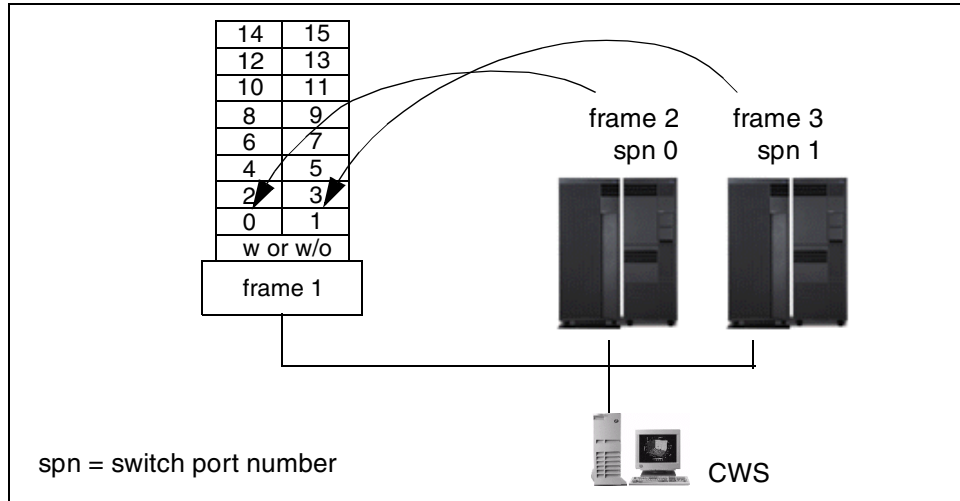

Figure 31. An SP system with two SP-attached servers and one SP frame

As long as your SP system does not have an SP Switch, or frame 1 remains as switch capsule configuration 0 (refer to Figure 21 on page 50), there is no problem. However, once you decided to expand this switch capsule (frame 1) to configuration 1, 2, or 3, you will have a problem. The switch capsule requires up to four frame numbers. Therefore, it is a good idea to have your lowest Enterprise Server have frame number 5.

In a rare case, it might be better to start assigning frame numbers with 6 instead of 5. This is discussed in 5.5.3, “When a CES system has 16 (maximum) Enterprise Servers” on page 64.

### 5.5.2 When a CES system has 13 to 15 Enterprise Servers

When a CES system has 13 to 15 Enterprise Servers, specify the switch port numbers manually for the thirteenth through fifteenth Enterprise Servers. Use the switch port numbers 13 through 15 as shown in Figure 32 on page 63.

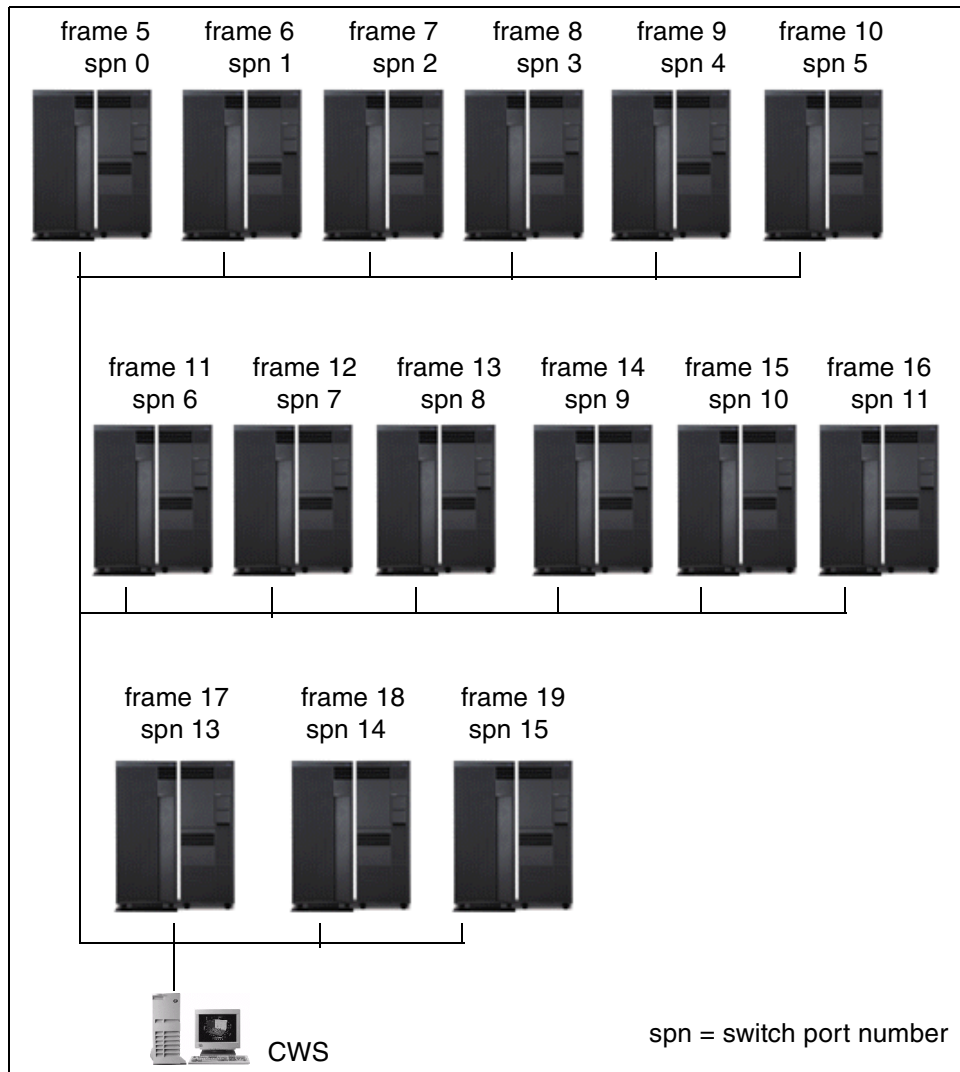

Figure 32. A CES system with 13 to 15 Enterprise Servers

You can add them by using the `spframe` command as follows:

```
spframe -p SAMI -n 13 -r yes 17 3 /dev/tty24
```

By this operation, switch port numbers 13 through 15 are manually assigned as shown in Figure 32. Switch port number 12 is skipped.

### ***Why do you need to skip switch port number 12?***

Assume you added your 15 Enterprise Servers with switch port numbers 0 through 14 (without skipping switch port number 12) with the following command:

```
spframe -p SAMI -r yes 5 15 /dev/tty0
```

If you later want to add an SP frame to this system as frame 1, it will have only one available switch port number, switch port number 15, since switch port numbers 0 through 14 are used by the Enterprise Servers. Since the SP frame must contain at least one node, the node must begin in slot 16, the slot associated with the only available switch port number left in the frame, switch port number 15. This means you can only place a thin node in the SP frame with this configuration. If, instead, you left switch port number 12 open as in Figure 32 on page 63, you could put a thin, wide, or high node in the frame since each of these types of nodes can begin in slot 13, the slot associated with switch port number 12.

At this point, since you might not know what type of SP node you will need in the future, it is wise to skip switch port number 12.

### **5.5.3 When a CES system has 16 (maximum) Enterprise Servers**

When a CES system has 16 Enterprise Servers (the maximum number for a CES system), specify the switch port number manually for the sixteenth (the last) Enterprise Server. Use switch port number 31 as shown in Figure 33 on page 65.



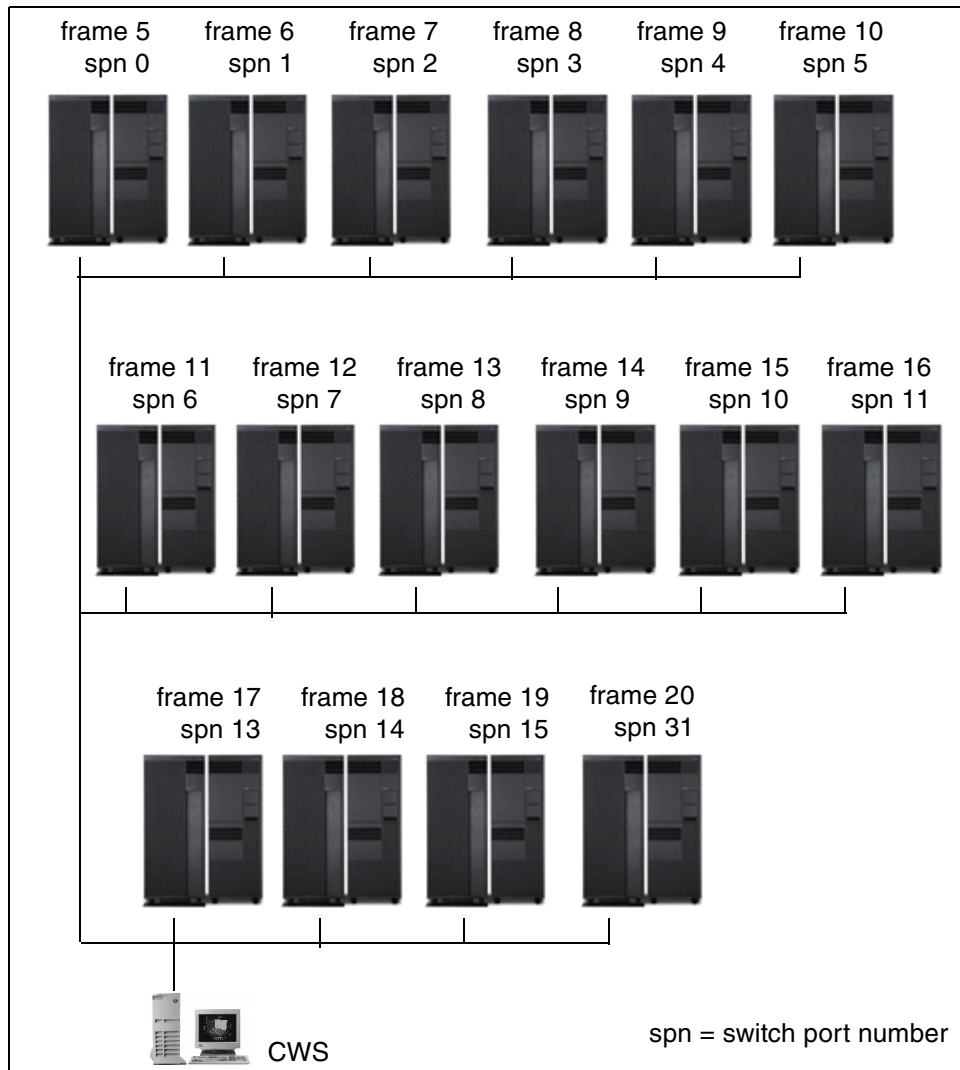

Figure 33. A CES system with 16 Enterprise Servers

You can add it by using the `spframe` command as follows:

```
spframe -p SAMI -n 31 -r yes 20 1 /dev/tty30
```

By this operation, switch port number 31 is manually assigned as shown in Figure 33 on page 65.

### ***Why do you need to use switch port number 31?***

Instead of using switch port number 31, say you use switch port number 12 for the last Enterprise Server. In this configuration, switch port numbers 0 through 15 are unavailable. Since the addition of either a switchless or switched SP frame would allocate switch port numbers 0 through 15 to that SP frame, there are no switch port numbers available for the node that is required in the SP frame. Therefore, you can not add any SP frames to your CES system.

Now, instead of using switch port number 31, say you use switch port number 16 for the last Enterprise Server. You decide to add SP frames to your CES to migrate to an SP system. To do this, you need to add two SP frames. One SP frame is not enough. Remember that one SP frame has 16 switch port numbers. You need at least 17 switch port numbers since (1) you already have 16 Enterprise Servers, each using one switch port number, and (2) you can only add an SP frame to the system if it has at least one node, which requires one additional switch port number. Therefore, this can only be accomplished by adding two SP frames.

The first SP frame must have one node beginning in slot 13 (either a thin, wide, or high node) to use the only available switch port number in that frame, switch port number 12. The remaining switch port numbers in this SP frame will be used by your first 15 Enterprise Servers (frames 5 through 19). The second SP frame must be added with one node in any slot other than slot 1 since the switch port number associated with this slot (switch port number 16) is being used by your last Enterprise Server. This places restrictions on where you can place thin, wide, and high nodes in the second frame since none of the nodes can occupy slot 1 in this configuration. This is because slot 1's switch port number is not available.

However, now consider the case where you assign the last Enterprise Server in you CES system to switch port number 31. When you add the second SP frame to the system, the node required in this frame can occupy any slot other than slot 16. Since nodes are only assigned the switch port number associated with the lowest slot that they occupy, the only restriction you now have is that you can not place a thin node in slot 16. You are free to place wide and high nodes wherever you choose in the frame.

Therefore, assigning switch port number 31 to the last Enterprise Server guarantees you greater flexibility if you migrate your CES system to an SP system.

If neither of these SP frames have an SP Switch (your SP system is a switchless SP system), you have to assign them frame numbers 1 and 2.

If both of these SP frames have an SP Switch (your SP system is a switched SP system), you can assign them any available frame numbers<sup>2</sup>. However, you need to consider switch capsule configurations. Configuration 3 requires four consecutive frame numbers. If you want to configure the second SP frame used by frame 20 as configuration 3 in the future, you must assign this frame a frame number of 21 or greater since, otherwise, the capsule will not fit between frame 1 and the first Enterprise Server (frame 5).

<sup>2</sup> In this configuration, it is not possible for one SP frame to have an SP Switch and for the other not to have an SP Switch.

Table 2 summarizes the recommended expansion plan from a CES system to a switchless SP system.

Table 2. Recommended upscale planning (switchless SP system)

Size of CES	Frame/Node type	Frame number	Node number	Switch port number
N/A	SP <sup>1</sup>	1	1 - 16	12
	SP-EX <sup>2</sup>	2	17 - 32	16 - 30
	SP-EX	3	33 - 48	32 - 47
	SP-EX	4	49 - 64	48 - 63
1 through 12 Enterprise Servers	ES <sup>3</sup>	5	65	0
	ES	6	81	1
	ES	7	97	2
	ES	8	113	3
	ES	9	129	4
	ES	10	145	5
	ES	11	161	6
	ES	12	177	7
	ES	13	193	8
	ES	14	209	9
	ES	15	225	10
	ES	16	241	11
13 through 15 Enterprise Servers	ES	17	257	13
	ES	18	273	14
	ES	19	289	15
16 Enterprise Servers	ES	20	305	31
1. SP model fame with SP nodes 2. SP expansion frame with SP nodes 3. Enterprise Server				

Table 3 summarizes this recommended expansion plan from a CES system to a switched SP system.

Table 3. Recommended upscale planning (switched SP system)

Size of CES	Frame/Node type	Frame number	Node number	Switch port number
N/A	SP <sup>1</sup>	1	1 - 16	12
1 through 12 Enterprise Servers	ES <sup>2</sup>	5	65	0
	ES	6	81	1
	ES	7	97	2
	ES	8	113	3
	ES	9	129	4
	ES	10	145	5
	ES	11	161	6
	ES	12	177	7
	ES	13	193	8
	ES	14	209	9
	ES	15	225	10
	ES	16	241	11
13 through 15 Enterprise Servers	ES	17	257	13
	ES	18	273	14
	ES	19	289	15
16 Enterprise Servers	ES	20	305	31
N/A	SP	21	321 - 336	16 - 30
1. Switched SP frame with SP nodes 2. Enterprise Server				



---

## **Appendix A. Presentation kit**

This appendix contains the CES presentation kit used as part of the ITSO PSSP 3.2 announcement workshop.

# PSSP 3.2 Announcement Workshop

## Clustered Enterprise Servers

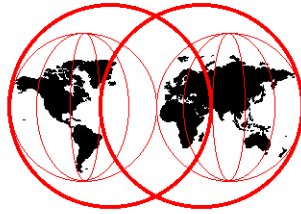

© 2000 IBM Corporation

Note:

---

---

---

---

---

---

---

---

---

---



# Current SP Software Switchless Attach Rules

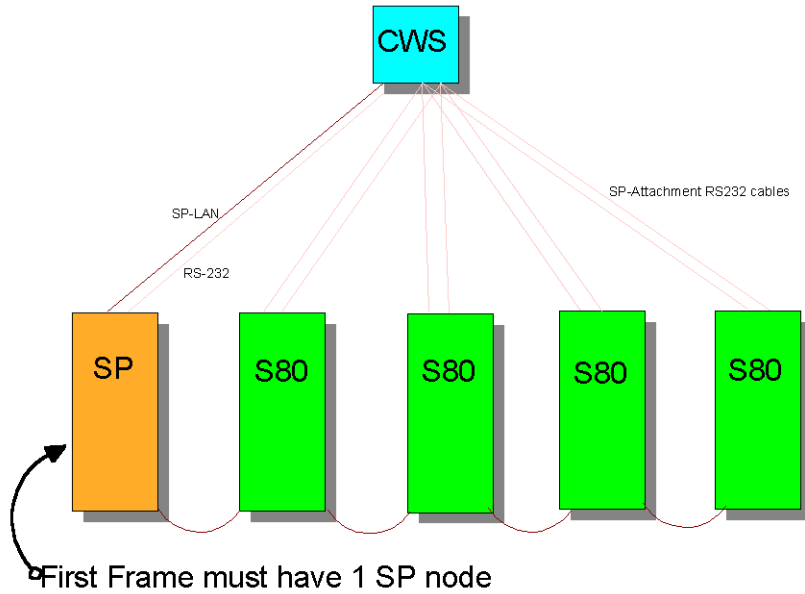

First Frame must have 1 SP node

© 2000 IBM Corporation

Note:

---

---

---

---

---

---

---

---

---

---

# PSSP 3.2 Relaxes Switchless Rule 7/00

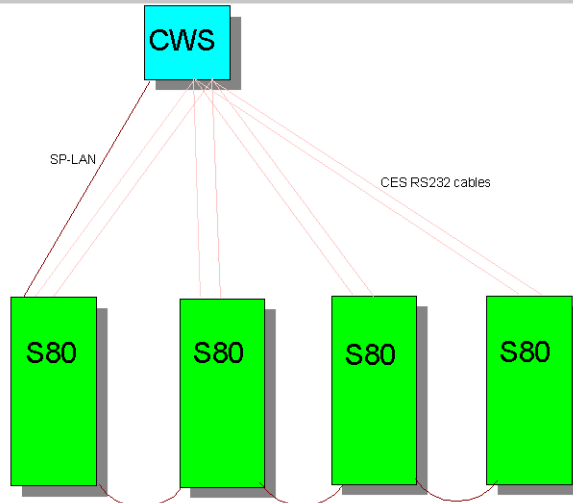

- Clustered Enterprise System can be all S70/S7A/S80
- System runs PSSP software
- System has no SP serial number
- Only S-series Enterprise Servers (S70/S7A/S80) supported as CES.

© 2000 IBM Corporation

Note:

---

---

---

---

---

---

---

---

---

---

## Clustered Enterprise Servers



- Available 7/00
- 1-16 Condor 7017-S80 and/or predecessors 7017-S7A, 7017-S70
- 1 PSSP 3.2 Control Workstation (F50 or 170)
  - Provides single point of control
- **NO** SP Frame, Node or Switch
- **NO** SP system partitioning permitted
- **NO** VSD, GPFS, PE user space supported
- **NO** HACWS support

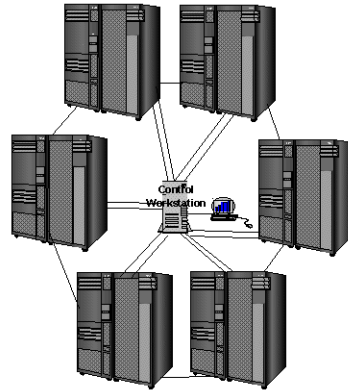

© 2000 IBM Corporation

Note:

---

---

---

---

---

---

---

---









---

---

## Attachment requirements



### RS/6000 Features

-  Feature 3150 Cable Assembly (S1 Port)
-  Feature 3151 Cable Assembly (SAMI Console)
-  Ethernet for Dedicated System LAN (Slot 5)
  -  Feature 2968 10/100 Ethernet 10Base TX Adapter
  -  Feature 2987 10 MB AUI/RJ-45 Ethernet Adapter
  -  Feature 2985 10 MB BNC/RJ-45 Ethernet Adapter
  -  Customer-supplied Ethernet cables (1 per CES)
-  PSSP 3.2 Software (5735-D51 FC 4012)
-  1 license per Clustered Server

© 2000 IBM Corporation

Note:

---

---

---

---

---

---

---

---

---

---

## Benefits of Clustered Enterprise Servers



### Same Benefits of a Switchless SP system:

- Systems management support and single point of control for multiple servers
- Parallel Network Installs
- Hardware Monitoring and Control
- Resource Monitoring
  - Logical Volumes, File Systems, CPUs, I/O, Operating System Stats, Network Monitoring, Network Adapter Health
- Event Monitoring and Problem Management
- Kerberos and DCE Security
- Parallel Commands Support
- Perspectives GUI

---

© 2000 IBM Corporation

Note:

---

---

---

---

---

---

---

---

---

---

## Service Issues



- **Hardware**
  - Manual and Automatic Calls will be routed through the SP path for immediate level2 attention
  - Details of automated configuration are being finalized at this time for Service Agent, Service Director
    - ▶ How the CES gets registered
    - ▶ Contents of the PMH
  - Dual Dispatch
    - ▶ SP dual dispatches only during weekends and off-shifts for customer calls
    - ▶ SP always dual dispatches for Service Director generated call
    - ▶ Strategy for CES: Same as SP
  
- **Software**
  - All software issues are handled the same as SP software issues

---

© 2000 IBM Corporation

Note:

---

---

---

---

---

---

---

---

---

---

## Differences Between Switchless SP-Attach and Clustered Enterprise Server Systems



Feature	SP-Attached Switchless	Clustered Enterprise Servers
SAMI Port Connect	Yes	Yes
S1 Port Connect	Yes	Yes
PSSP License per Server	Yes	Yes
SP-LAN	Yes	Yes
EN0 Ethernet in Slot 5	Yes	Yes
Limit 16 in Cluster	Yes	Yes
S-series only (S80...)	Yes	Yes
SP Frame, Node Req'd	Yes	<b>No</b>
SP Serial Number	Yes	<b>No</b>
System Partitioning	Yes	<b>No</b>
VSD support	<b>NO</b>	<b>No</b>

© 2000 IBM Corporation

Note:

---



---



---



---



---



---



---



---



---

## Potential Customer Problems (1 of 5)



- If a customer does not plan on migrating to an SP System when installing their CES (do not use **spframe -n**), they could have possible migration problems when adding a physical SP Frame to their CES

---

© 2000 IBM Corporation

Note:

---

---

---

---

---

---

---

---

---

---



Potential Customer Problems (1 of 5) (continued)

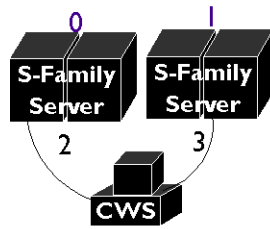

`spframe -p SAMI -r yes 2 2 /dev/tty1`

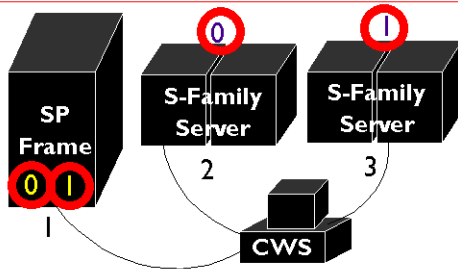

`spframe -r yes 1 1 /dev/tty0`

switch\_node\_number

frame\_number

© 2000 IBM Corporation

Note:

---

---

---

---

---

---

---

---

Potential Customer Problems (1 of 5) (continued)

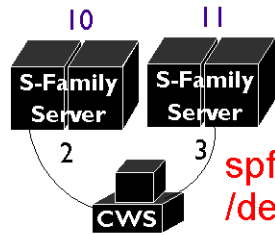

`spframe -p SAMI -n 10 -r yes 2 2  
/dev/tty1`

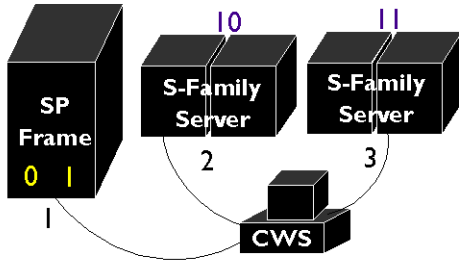

`spframe -r yes 1 1  
/dev/tty0`



switch\_node\_number

frame\_number

© 2000 IBM Corporation

Note:

---

---

---

---

---

---

---

---

## Potential Customer Problems (2 of 5)



- Customer may have migration problems when migrating from an SP System to a CES if they do not use **spdelfram** with both the **-c** and **-l** options

---

© 2000 IBM Corporation

Note:

---

---

---

---

---

---

---

---

---

Potential Customer Problems (2 of 5) (continued)

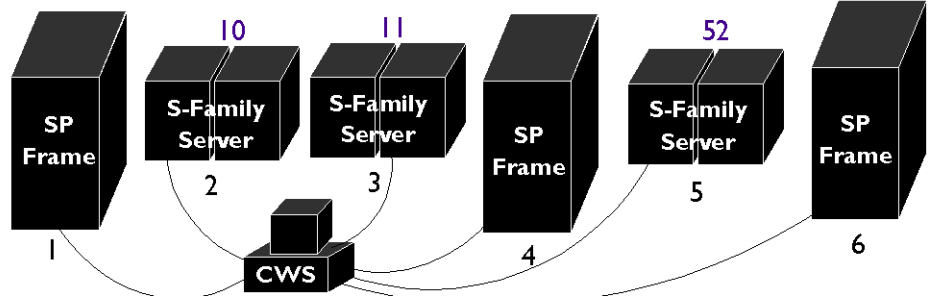

`spdelfram -c -l 1,4,6`

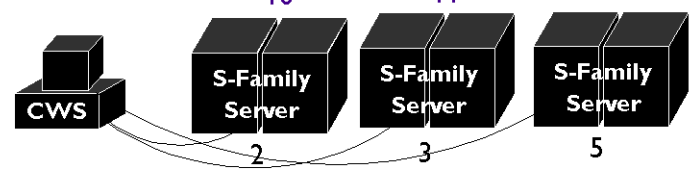

switch\_node\_number

frame\_number

© 2000 IBM Corporation

Note:

---

---

---

---

---

---

---

---

---

---

## Potential Customer Problems (3 of 5)



- When adding SP Attached Servers to a CES or an SP System and using the **-s** flag on **spframe** to specify the s1 tty port, the frame count *must* be 1

`spframe -p SAMI -n 5 -s /dev/tty1 -r yes 1 1 /dev/tty0`



`spframe -p SAMI -n 5 -s /dev/tty1 -r yes 1 5 /dev/tty0`



© 2000 IBM Corporation

Note:

---

---

---

---

---

---

---

---

---

---

## Potential Customer Problems (4 of 5)



- Due to the dropped restriction that the first frame in the system needs to be an SP Frame, the following can be a valid system configuration:

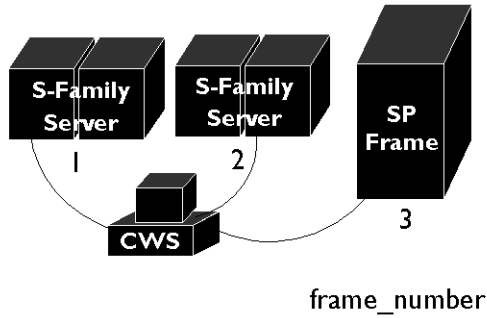

© 2000 IBM Corporation

Note:

---

---

---

---

---

---

---

---

---

---

Potential Customer Problems (4 of 5) (continued)



- When adding css adapters using the **spadaptrs** command with the **-n** flag (assigns IP addresses by using switch node numbers), the starting IP address, defined as the IP address of the first node on the network, may not necessarily be the lowest IP address. Use the IP address of the lowest numbered node.

---

© 2000 IBM Corporation

Note:

---

---

---

---

---

---

---

---

---

---

Potential Customer Problems (4 of 5) (continued)

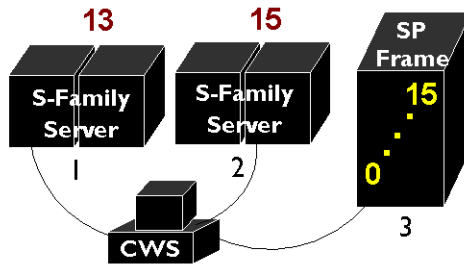

spadaptrs 1 1 8 css0 c58sn14 255.255.255.192

frame\_number

switch\_node\_number

© 2000 IBM Corporation

Note:

---

---

---

---

---

---

---

---

---

---



## Potential Customer Problems (5 of 5)



- On a migration from a CES to an SP System, customer needs to be cautious of switch node numbering even if they have no switch in the frame they are adding

---

© 2000 IBM Corporation

Note:

---

---

---

---

---

---

---

---

---

---

Potential Customer Problems (5 of 5) (continued)

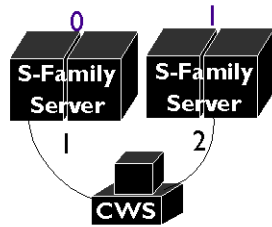

`spframe -p SAMI -r yes 1 2 /dev/tty1`

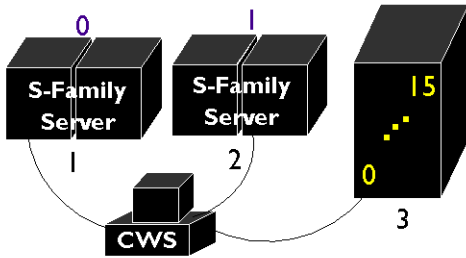

Switched SP Frame

`spframe -r yes 3 1 /dev/tty0`



Okay as long as there are no nodes starting in slot 1 or 2

switch\_node\_number

frame\_number

© 2000 IBM Corporation

Note:

---

---

---

---

---

---

---

---

---

---

Potential Customer Problems (5 of 5) (continued)

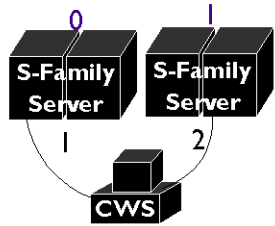

`spframe -p SAMI -r yes 1 2 /dev/tty1`

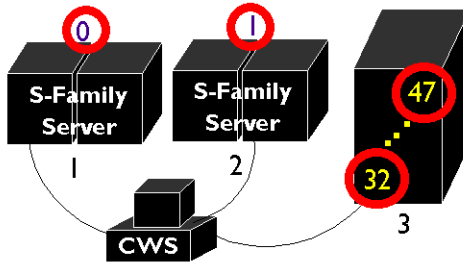

Switchless  
SP  
Frame



`spframe -r yes 3 1 /dev/tty0`

18 switch node numbers  
for 1 "switch"

switch\_node\_number

frame\_number

© 2000 IBM Corporation

Note:

---

---

---

---

---

---

---

---

---

---



---

## Appendix B. Special notices

This publication is intended to help IBM customers, IBM business partners, IBM sales professionals, and IBM I/T specialists wishing to obtain a reference for IBM RS/6000 Clustered Enterprise Servers hardware and software offerings and planning. The information in this publication is not intended as the specification of any programming interfaces that are provided by RS/6000 hardware, AIX software, or PSSP software. See the PUBLICATIONS section of the IBM Programming Announcement for RS/6000 and AIX LPPs for more information about what publications are considered to be product documentation.

References in this publication to IBM products, programs or services do not imply that IBM intends to make these available in all countries in which IBM operates. Any reference to an IBM product, program, or service is not intended to state or imply that only IBM's product, program, or service may be used. Any functionally equivalent program that does not infringe any of IBM's intellectual property rights may be used instead of the IBM product, program or service.

Information in this book was developed in conjunction with use of the equipment specified, and is limited in application to those specific hardware and software products and levels.

IBM may have patents or pending patent applications covering subject matter in this document. The furnishing of this document does not give you any license to these patents. You can send license inquiries, in writing, to the IBM Director of Licensing, IBM Corporation, North Castle Drive, Armonk, NY 10504-1785.

Licensees of this program who wish to have information about it for the purpose of enabling: (i) the exchange of information between independently created programs and other programs (including this one) and (ii) the mutual use of the information which has been exchanged, should contact IBM Corporation, Dept. 600A, Mail Drop 1329, Somers, NY 10589 USA.

Such information may be available, subject to appropriate terms and conditions, including in some cases, payment of a fee.

The information contained in this document has not been submitted to any formal IBM test and is distributed AS IS. The use of this information or the implementation of any of these techniques is a customer responsibility and depends on the customer's ability to evaluate and integrate them into the customer's operational environment. While each item may have been

reviewed by IBM for accuracy in a specific situation, there is no guarantee that the same or similar results will be obtained elsewhere. Customers attempting to adapt these techniques to their own environments do so at their own risk.

Any pointers in this publication to external Web sites are provided for convenience only and do not in any manner serve as an endorsement of these Web sites.

The following terms are trademarks of the International Business Machines Corporation in the United States and/or other countries:

AIX	AS/400
IBM	Netfinity
OS/2	RS/6000
Service Director	SP
System/390	400

The following terms are trademarks of other companies:

C-bus is a trademark of Corollary, Inc. in the United States and/or other countries.

Java and all Java-based trademarks and logos are trademarks or registered trademarks of Sun Microsystems, Inc. in the United States and/or other countries.

Microsoft, Windows, Windows NT, and the Windows logo are trademarks of Microsoft Corporation in the United States and/or other countries.

PC Direct is a trademark of Ziff Communications Company in the United States and/or other countries and is used by IBM Corporation under license.

ActionMedia, LANDesk, MMX, Pentium and ProShare are trademarks of Intel Corporation in the United States and/or other countries.

UNIX is a registered trademark in the United States and other countries licensed exclusively through The Open Group.

SET, SET Secure Electronic Transaction, and the SET Logo are trademarks owned by SET Secure Electronic Transaction LLC.

Other company, product, and service names may be trademarks or service marks of others.

---

## Appendix C. Related publications

The publications listed in this section are considered particularly suitable for a more detailed discussion of the topics covered in this redbook.

---

### C.1 IBM Redbooks

For information on ordering these publications see “How to get IBM Redbooks” on page 99.

- *RS/6000 SP System Management: Power Recipes for PSSP 3.1*, SG24-5628
- *SP Perspectives: A New View of Your SP System*, SG24-5180

---

### C.2 IBM Redbooks collections

Redbooks are also available on the following CD-ROMs. Click the CD-ROMs button at [ibm.com/redbooks](http://ibm.com/redbooks) for information about all the CD-ROMs offered, updates and formats.

CD-ROM Title	Collection Kit Number
IBM System/390 Redbooks Collection	SK2T-2177
IBM Networking Redbooks Collection	SK2T-6022
IBM Transaction Processing and Data Management Redbooks Collection	SK2T-8038
IBM Lotus Redbooks Collection	SK2T-8039
Tivoli Redbooks Collection	SK2T-8044
IBM AS/400 Redbooks Collection	SK2T-2849
IBM Netfinity Hardware and Software Redbooks Collection	SK2T-8046
IBM RS/6000 Redbooks Collection	SK2T-8043
IBM Application Development Redbooks Collection	SK2T-8037
IBM Enterprise Storage and Systems Management Solutions	SK3T-3694

---

### C.3 Other resources

These publications are also relevant as further information sources:

- *RS/6000 SP: Planning, Volume 1, Hardware and Physical Environment*, GA22-7280
- *RS/6000 SP: Planning, Volume 2, Control Workstation and Software Environment*, GA22-7281
- *RS/6000 SP: Installation and Relocation*, GA22-7441
- *RS/6000 SP: System Service Guide*, GA22-7442

- *RS/6000 SP: SP Switch Service Guide*, GA22-7443
- *RS/6000 SP: SP Switch2 Service Guide*, GA22-7444
- *RS/6000 SP: Uniprocessor Thin and Wide Node Service Guide*, GA22-7445
- *RS/6000 SP: 604 and 604e SMP High Node Service Guide*, GA22-7446
- *RS/6000 SP: SMP Thin and Wide Node Service Guide*, GA22-7447
- *RS/6000 SP: POWER3 SMP High Node Service Guide*, GA22-7448
- *IBM Parallel System Support Programs for AIX: Installation and Migration Guide*, GA22-7347
- *IBM Parallel System Support Programs for AIX: Administration Guide*, SA22-7348
- *IBM Parallel System Support Programs for AIX: Managing Shared Disks*, SA22-7349
- *IBM Parallel System Support Programs for AIX: Performance Monitoring Guide and Reference*, SA22-7353
- *IBM Parallel System Support Programs for AIX: Diagnosis Guide*, GA22-7350
- *IBM Parallel System Support Programs for AIX: Command and Technical Reference*, SA22-7351
- *IBM Parallel System Support Programs for AIX: Message Reference*, GA22-7352
- *RS/6000 Cluster Technology: Event Management Programming Guide and Reference*, SA22-7354
- *RS/6000 Cluster Technology: Group Service Programming Guide and Reference*, SA22-7355

---

#### **C.4 Referenced Web sites**

These Web sites are also relevant as further information sources:

- <http://www.rs6000.ibm.com/>  
The RS/6000 SP hardware and software books
- [http://www.rs6000.ibm.com/resource/aix\\_resource/sp\\_books/](http://www.rs6000.ibm.com/resource/aix_resource/sp_books/)  
RS/6000 SP Product Document Library
- [http://www.rs6000.ibm.com/hardware/enterprise/s70\\_advanced.html](http://www.rs6000.ibm.com/hardware/enterprise/s70_advanced.html)  
RS/6000 Model S70 Advanced Server



- <http://www.rs6000.ibm.com/hardware/enterprise/s80.html>  
RS/6000 Model S80
- [http://www.rs6000.ibm.com/resource/technology/sp\\_attach.html](http://www.rs6000.ibm.com/resource/technology/sp_attach.html)  
SP-attached server
- [http://www.rs6000.ibm.com/software/sp\\_products/pssp.html](http://www.rs6000.ibm.com/software/sp_products/pssp.html)  
PSSP software
- [http://www.rs6000.ibm.com/software/sp\\_products/pssp\\_pres/pdemo\\_intro.htm](http://www.rs6000.ibm.com/software/sp_products/pssp_pres/pdemo_intro.htm)  
1  
PSSP Web presentation



---

## How to get IBM Redbooks

This section explains how both customers and IBM employees can find out about IBM Redbooks, redpieces, and CD-ROMs. A form for ordering books and CD-ROMs by fax or e-mail is also provided.

- **Redbooks Web Site** [ibm.com/redbooks](http://ibm.com/redbooks)

Search for, view, download, or order hardcopy/CD-ROM Redbooks from the Redbooks Web site. Also read redpieces and download additional materials (code samples or diskette/CD-ROM images) from this Redbooks site.

Redpieces are Redbooks in progress; not all Redbooks become redpieces and sometimes just a few chapters will be published this way. The intent is to get the information out much quicker than the formal publishing process allows.

- **E-mail Orders**

Send orders by e-mail including information from the IBM Redbooks fax order form to:

	<b>e-mail address</b>
In United States or Canada	<a href="mailto:pubscan@us.ibm.com">pubscan@us.ibm.com</a>
Outside North America	Contact information is in the "How to Order" section at this site: <a href="http://www.elink.ibm.com/pbl/pbl">http://www.elink.ibm.com/pbl/pbl</a>

- **Telephone Orders**

United States (toll free)	1-800-879-2755
Canada (toll free)	1-800-IBM-4YOU
Outside North America	Country coordinator phone number is in the "How to Order" section at this site: <a href="http://www.elink.ibm.com/pbl/pbl">http://www.elink.ibm.com/pbl/pbl</a>

- **Fax Orders**

United States (toll free)	1-800-445-9269
Canada	1-403-267-4455
Outside North America	Fax phone number is in the "How to Order" section at this site: <a href="http://www.elink.ibm.com/pbl/pbl">http://www.elink.ibm.com/pbl/pbl</a>

This information was current at the time of publication, but is continually subject to change. The latest information may be found at the Redbooks Web site.

### IBM Intranet for Employees

IBM employees may register for information on workshops, residencies, and Redbooks by accessing the IBM Intranet Web site at <http://w3.itso.ibm.com/> and clicking the ITSO Mailing List button. Look in the Materials repository for workshops, presentations, papers, and Web pages developed and written by the ITSO technical professionals; click the Additional Materials button. Employees may access MyNews at <http://w3.ibm.com/> for redbook, residency, and workshop announcements.

---

## IBM Redbooks fax order form

Please send me the following:

Title	Order Number	Quantity
_____	_____	_____
_____	_____	_____
_____	_____	_____
_____	_____	_____
_____	_____	_____
_____	_____	_____
_____	_____	_____
_____	_____	_____
_____	_____	_____

---

First name \_\_\_\_\_ Last name \_\_\_\_\_

---

Company \_\_\_\_\_

---

Address \_\_\_\_\_

---

City \_\_\_\_\_ Postal code \_\_\_\_\_ Country \_\_\_\_\_

---

Telephone number \_\_\_\_\_ Telefax number \_\_\_\_\_ VAT number \_\_\_\_\_

Invoice to customer number \_\_\_\_\_

Credit card number \_\_\_\_\_

---

Credit card expiration date \_\_\_\_\_ Card issued to \_\_\_\_\_ Signature \_\_\_\_\_

**We accept American Express, Diners, Eurocard, Master Card, and Visa. Payment by credit card not available in all countries. Signature mandatory for credit card payment.**

---

## Index

### Symbols

/etc/SDR\_dest\_info 40  
/mnt 40  
/spdata/sys1/install/pssplpp 40  
/tmp 29  
/usr/lpp/ssp/install/bin/pssp\_script 41  
/var 29

### Numerics

332 MHz SMP thin node 10  
332 MHz SMP wide node 10  
375 MHz POWER3 SMP high node 10  
375 MHz POWER3 SMP thin node 10  
375 MHz POWER3 SMP wide node 10  
64-bit application 17  
64-bit computing 2  
64-bit processing 17

### A

aggregate monitoring state 28  
AIX  
    4.3.3 18  
AIX Error Log 29, 32

### B

BI 1  
boot/install server 40  
business intelligence 1

### C

CES 5  
coexistence 18  
command  
    installp 40  
    mount 40  
    route 40  
    shutdown 41  
    spadaptrs 55  
        -n yes 55  
    spbootins 40  
    spdelfram 21  
        -c 21  
        frame\_count 22  
        -l frame\_list 21

    start\_frame 22  
spframe 19  
    -n starting\_switch\_port 20  
    -r no | yes 20  
    -s s1tty 20  
    frame\_count 20  
    -p 20  
    start\_frame 20  
    starting\_tty\_port 20  
    umount 41

Configuration page 27  
control workstation 13  
CRM 1  
CSS0-port 0 33  
custom RS-232 cable 9, 10, 11, 13  
custom RS-232 connection 13  
Customer Relationship Management 1  
customize 39  
CWS 13

### D

DCE 17  
directory  
    /mnt 40  
    /spdata/sys1/install/pssplpp 40  
Distributed Computing Environment 17  
drawer 46

### E

e-business 1  
E-mail message 15  
en0 position 12  
Enterprise Resource Planning 1  
envelope icon 35  
environment indicator 33  
ERP 1  
Ethernet adapter  
    MCA 13  
    PCI 13  
Ethernet cable 11  
event 31  
event definition 31  
    errLog 32  
    fileSystems 33  
    frameControllerNotResponding 33  
    framePowerOff 33, 34

- hostResponds 33, 34
- keyNotNormal 33, 34
- LCDhasMessage 32
- nodeEnvProblem 33, 34
- nodeNotReachable 33
- nodePowerDown 33
- nodePowerLED 33, 34
- nodeSerialLinkOpen 33
- pageSpaceLow 33
- processorsOffline 33
- sdrDown 33
- switchNotReachable 33, 34
- switchPowerLED 33, 34
- switchResponds0 33, 34
- tmpFull 34
- unregister 35
- varFull 34
- Event Definitions pane 34, 35
- event notification 35
- Event Perspective 23, 31

## F

- feature code
  - 1500 10
  - 1550 9, 10
  - 2031 10
  - 2050 10
  - 2051 10
  - 2054 10
  - 2056 10
  - 2057 10
  - 2058 10
  - 2930 15
  - 2931 14
  - 2932 14
  - 2933 14
  - 2934 14
  - 2943 14
  - 2944 14
  - 2955 15
  - 2968 12, 13
  - 2980 13
  - 2985 12, 13
  - 2987 12, 13
  - 2992 13
  - 2993 13
  - 2995 15
  - 2996 15

- 3124 14
- 3125 14
- 3150 9, 13
- 3151 10, 13
- 4008 10
- 4011 10
- 4012 10
- 4224 13
- 5800 16
- 5801 16
- 5802 16
- 8130 14
- 8131 14
- 8132 14
- 8133 14
- 8134 14
- 8136 14
- 8137 14
- 8138 14
- file
  - /etc/SDR\_dest\_info 40
- file system 33
- formula
  - node number 46
  - switch port number
    - switched system 47
    - switchless system 48
- frame 46
- frame controller 33
- frame number 38, 45, 52, 57
- frame supervisor 45
- Frames and Switches pane 25

## G

- General Parallel File System 17, 43
- Global Event Notification Log window 35
- GPFS 17, 43
- graphical user interface 22
- Group Services 33
- GUI 22

## H

- HACMP 17
- HACWS 17
- Hardware Perspective 23, 24
- hd3 34
- hd9var 34
- health 15

High Availability Cluster Multi-Processing for AIX  
17  
hostResponds 34, 35

## I

IBM support center 15  
IBM Virtual Shared Disk 43  
icon  
    Event Perspective 24  
    Hardware  
        Manage SP-attached S-Family Servers 24  
    Hardware Perspective 24  
    hostResponds 34  
    Notebook 25, 26  
    Register 34  
    Unregister 35  
icon view 25  
initialize SDR 38  
installation 37  
installp 40  
IPv4 network 17  
IPv6 17  
IPv6 network 17  
IsPartitionable attribute 19

## K

key mode switch 33

## L

LCD 32  
LED 32  
lowest IP address 56  
lowest node number 56

## M

machine type  
    7017 11, 15  
    9077 04S 10  
    9077 16S 10  
MACN 26  
menu 22  
migration  
    existing Enterprise Servers 37, 39  
    existing SP system 37, 41  
mission-critical commercial 1  
mode 40  
model

500 10  
550 9, 10  
F50 13  
modem 15  
Monitored Conditions page 30  
monitoring system conditions 28  
mount 40  
multi-port asynchronous adapter 13  
    128-port PCI 14  
    16-port MCA 15  
    8-port MCA 15  
    8-port PCI 14

## N

name resolution 40  
node number 46  
node power 33  
Node Status page 27  
Nodes pane 25  
non-switched expansion frame 49  
notebook  
    Set Monitoring for Nodes 29  
    View or Modify Properties Frame 26, 28  
    View or Modify Properties Node 26, 28, 30  
numbering rule 45

## O

OLTP 1  
On-line Transaction Processing 1  
ownership 40

## P

page  
    Configuration 27  
    Monitored Conditions 30  
    Node Status 27  
paging space 33  
pane  
    Event Definitions 34, 35  
    Frames and Switches 25  
    Nodes 25  
Parallel Environment 17  
Parallel Systems Support Programs for AIX 1  
parts 15  
PCI architecture 11  
PE 17  
perfagent.tools 40

- Performance Monitor Perspective 23
- permanent error 32
- position
  - SP-attached server 53
- power to the frame 33
- power to the node 33
- POWER3 SMP high node 10
- preserve 39
- processor 33
- profile 24
- PSSP 1
  - 3.1.1 18
  - 3.2 18
- pssp\_script 41
- pssplpp 40

## R

- Recoverable Virtual Shared Disk 43
- Reliable Scalable Cluster Technology 17
- remove
  - SP-attached server 41
- rootvg 34
- route 40
- RS/6000 Clustered Enterprise Servers 5
- RS/6000 Enterprise Server 1
- RS/6000 S70 Advanced Enterprise Server 2
- RS/6000 S80 Enterprise Server 2
- RS/6000 SP 3
- RS/6000 SP Switch Router 10
- RS/6000 SP-attached server 3
- RSCT 17
- RVSD 43

## S

- s1 connection 38
- s1 serial port 9, 11, 13
- SAMI connection 38
- SAMI port 10, 11, 13
- scale up 45
- SCM 1
- SDR 19, 21
  - initialize 38
- sdr daemon 33
- SDR\_config 19
- SDR\_dest\_info 40
- serial link 33
- Service Director 15
  - configure 15

- service engineer 15
- Set Monitoring for Nodes notebook 29
- short frame 10
- shutdown 41
- slot 46
- slot number
  - SP-attached server 53
- slot numbers 46
- SMIT 23
- SMIT menu 38
- SMP 1
- SP class 19
- SP Ethernet communication 12
- SP frame
  - add 54
    - with or without SP Switch 62
    - with SP Switch 59
    - without SP Switch 60
- SP frame supervisor 16
- SP node supervisor 16
- SP Perspective applications 23
- SP Perspectives 5, 22
- SP Perspectives Launch Pad 23
- SP Switch 10
- SP Switch adapter
  - add 55
- SP Switch2 10
  - SP-attached server 53
- SP-attached server 41
  - add 52
- spbootins 40
  - r customize 40
- spdelfram 21, 42
- spframe 19, 38, 58, 65
- static route 40
- Supply Chain Management 1
- Switch adaptor 33
- switch board 47
- switch capsule 49
  - configuration 0 51, 62
  - configuration 1 51, 52, 62
  - configuration 2 51, 52, 62
  - configuration 3 51, 62, 67
  - SP-attached server 53
- switch node number 47
- switch port 47
  - SP-attached server 53
- switch port number 48
  - 31 65



- switch port number 12 63
- switch power 33
- switched frame 49
- switchport assigned number 47
- symmetric multiprocessor 1
- System Data Repository 19, 21
- system node 15
- system object 22
- system partition 17
- system partitioning 17
- System Partitioning Aid Perspective 23
- system resource 22

## **T**

- tall frame 10
- tool bar 22
- tree view 25
- tty port 45

## **U**

- umount 41
- Unregister icon 35
- upgrade AIX 40
- upscale 45
- user space 17

## **V**

- View or Modify Properties Frame notebook 26, 28
- View or Modify Properties Node notebook 26, 28, 30
- Virtual Shared Disk 17
- VSD 17, 43
- VSD Perspective 23

## **W**

- window
  - Event Perspective 32
  - Global Event Notification Log 35
  - Hardware Perspective 24



---

## IBM Redbooks review

Your feedback is valued by the Redbook authors. In particular we are interested in situations where a Redbook "made the difference" in a task or problem you encountered. Using one of the following methods, **please review the Redbook, addressing value, subject matter, structure, depth and quality as appropriate.**

- Use the online **Contact us** review redbook form found at [ibm.com/redbooks](http://ibm.com/redbooks)
- Fax this form to: USA International Access Code + 1 914 432 8264
- Send your comments in an Internet note to [redbook@us.ibm.com](mailto:redbook@us.ibm.com)

<b>Document Number</b>	SG24-5978-00
<b>Redbook Title</b>	IBM RS/6000 Clustered Enterprise Servers Handbook
<b>Review</b>	          
<b>What other subjects would you like to see IBM Redbooks address?</b>	   
<b>Please rate your overall satisfaction:</b>	<input type="radio"/> Very Good <input type="radio"/> Good <input type="radio"/> Average <input type="radio"/> Poor
<b>Please identify yourself as belonging to one of the following groups:</b>	<input type="radio"/> Customer <input type="radio"/> Business Partner <input type="radio"/> Solution Developer <input type="radio"/> IBM, Lotus or Tivoli Employee <input type="radio"/> None of the above
<b>Your email address:</b> The data you provide here may be used to provide you with information from IBM or our business partners about our products, services or activities.	<input type="checkbox"/> Please do not use the information collected here for future marketing or promotional contacts or other communications beyond the scope of this transaction.
<b>Questions about IBM's privacy policy?</b>	The following link explains how we protect your personal information. <a href="http://ibm.com/privacy/yourprivacy/">ibm.com/privacy/yourprivacy/</a>





**IBM RS/6000 Clustered Enterprise Servers Handbook**







# IBM RS/6000 Clustered Enterprise Servers Handbook



## **Use PSSP to manage your RS/6000 Enterprise Servers**

RS/6000 Clustered Enterprise Servers meet the rigorous demands of mission-critical enterprise applications and provide unsurpassed power, flexibility, and reliability. With the new release of PSSP 3.2, you can now manage RS/6000 Enterprise Servers like SP-attached servers in an RS/6000 SP system. This is called an RS/6000 Clustered Enterprise Server (CES). The CES systems contain only RS/6000 Enterprise Servers managed from a single point of control.

## **Migrate your RS/6000 Enterprise Servers to a CES system**

This IBM Redbook provides the following information on CES systems: Hardware and software requirements and limitations, PSSP enhancements to support CES systems, installation and migration techniques, and ways to scale a CES system to an SP system.

## **Upgrade your CES system to an SP system**

This IBM Redbook provides valuable information and examples for system programmers and administrators who want to manage multiple RS/6000 servers from a single clustered environment.

## **INTERNATIONAL TECHNICAL SUPPORT ORGANIZATION**

### **BUILDING TECHNICAL INFORMATION BASED ON PRACTICAL EXPERIENCE**

IBM Redbooks are developed by the IBM International Technical Support Organization. Experts from IBM, Customers and Partners from around the world create timely technical information based on realistic scenarios. Specific recommendations are provided to help you implement IT solutions more effectively in your environment.

**For more information:**  
[ibm.com/redbooks](http://ibm.com/redbooks)

SG24-5978-00

ISBN 0738418676