



PCI Adapter Placement Reference

Note to Printer:

No Graphic to be printed on front cover.
Delete this note before printing.

Book trim size is 7 3/8 x 9 inches

Front Cover is 10pt. Carolina stock or equivalent C1S (coated one side)



PCI Adapter Placement Reference

Fifteenth Edition (December 2001)

Before using this information and the products it supports, read the information in "Appendix. Notices" on page 191.

A reader's comment form is provided at the back of this publication. If the form has been removed, address comments to Publications Department, Internal Zip 9561, 11400 Burnet Road, Austin, Texas 78758-3493. To send comments electronically, use this commercial internet address: aix6kpub@austin.ibm.com. Any information that you supply may be used without incurring any obligation to you.

"©"International Business Machines Corporation 1996, 2001. All rights reserved.

Note to U.S. Government Users Restricted Rights--Use, duplication or disclosure restricted by GSA ADP Schedule Contract with IBM Corp.

Contents

About This Book	vii
ISO 9000	vii
Online Publications	vii
Related Publications	vii
Trademarks	vii
Chapter 1. Peripheral Component Interconnect Overview	1
System Performance	1
PCI Slots	1
Secondary PCI Bus	2
Multiple Primary PCI Buses	2
Hot Pluggable PCI Slots	3
Integrated Adapters.	3
32-Bit Versus 64-Bit PCI Slots	3
33 MHz versus 50/66 MHz 64-Bit PCI Slots.	3
Connectivity versus Performance Overview	4
Other Restrictions	5
Chapter 2. Models S70, S7A, and S80	7
Performance Limits	15
Models S70, S7A, and S80 Configuration Details	17
Chapter 3. pSeries 680 Model S85	19
Performance Limits	26
pSeries 680 Model S85 Configuration Details.	27
Chapter 4. 7024 Models E20 and E30	29
7024 Models E20 and E30 Adapter Placement Guide	30
Chapter 5. 7025 Model 6F0 and 7025 Model 6F1	33
7025 Model 6F0 and 7025 Model 6F1	34
Chapter 6. 7025 Model F30	39
7025 Model F30 Adapter Placement Guide	40
Chapter 7. 7025 Model F40	43
7025 Model F40 Adapter Placement Guide	44
7025 Model F40 Multiple Graphics Adapter Placement Guide	48
Chapter 8. 7025 Model F50	51
7025 Model F50 Adapter Placement Guide	52
Chapter 9. 7025 Model F80	59
7025 Model F80 Adapter Placement Guide	59
Chapter 10. 7026 Model 6H0 and 7026 Model 6H1	65

7026 Model 6H0 and 7026 Model 6H1 Adapter Placement Guide	66
Chapter 11. 7026 Model 6M1	71
7026 Model 6M1 Adapter Placement Guide	72
Chapter 12. 7026 Model H10	77
7026 Model H10 Adapter Placement Guide	78
Chapter 13. 7026 Model H50	81
7026 Model H50 Adapter Placement Guide	82
Chapter 14. 7026 Model H70	89
7026 Model H70 Adapter Placement Guide	90
Chapter 15. 7026 Model H80	97
7026 Model H80 Adapter Placement Guide	98
Chapter 16. 7026 Model M80	105
7026 Model M80 Adapter Placement Guide	105
Chapter 17. 7028 Models 6C1 and 6E1	113
7028 Models 6C1 and 6E1 Adapter Placement Guide	114
Chapter 18. @server pSeries Model 690	117
Logical Partition (LPAR) Considerations	117
@server pSeries Model 690 Adapter Placement Guide	118
Chapter 19. 7043 Model 140	123
7043 Model 140 Adapter Placement Guide	123
7043 Model 140 Multiple Graphics Adapter Placement Guide	129
Chapter 20. 7043 Model 150	131
7043 Model 150 Adapter Placement Guide	131
7043 Model 150 Multiple Graphics Adapter Placement Guide	137
Chapter 21. 7043 Model 240	141
7043 Model 240 Adapter Placement Guide	141
7043 Model 240 Multiple Graphics Adapter Placement Guide	144
Chapter 22. 7043 Model 260	147
7043 Model 260 Adapter Placement Guide	147
7043 Model 260 Multiple Graphics Adapter Placement Guide	152
Chapter 23. 7044 Model 170	155
7044 Model 170 Adapter Placement Guide	156
7044 Model 170 Multiple Graphics Adapter Placement Guide	161
Chapter 24. 7044 Model 270	163
7044 Model 270 Adapter Placement Guide	163

7044 Model 270 Multiple Graphics Adapter Placement Guide	168
Chapter 25. 7046 Model B50	171
7046 Model B50 Adapter Placement Guide	171
Chapter 26. pSeries 640 Model B80	175
pSeries 640 Model B80 Adapter Placement Guide	175
Chapter 27. 7248 Model 100, 120, or 132	179
7248 Model 100, 120, or 132 Adapter Placement Guide.	180
7248 Model 100, 120, or 132 Multiple Graphics Adapter Placement Guide.	181
Chapter 28. 9076 RS/6000 SP Systems.	183
Chapter 29. Digital Trunk PCI Adapter Placement Considerations	185
Chapter 30. FC 2854: POWER GXT500P (Type 1-I) and FC 2855: POWER GXT550P (Type 1-J) Support Configurations	187
Chapter 31. FC 2853: POWER GXT800P (Type 1-K) Support Configurations	189
Appendix. Notices	191

About This Book

This book outlines system-specific PCI adapter slot placement and adapter support configurations. Not all of the adapters supported in stated maximum configurations run at per adapter maximum performance.

This book identifies Peripheral Component Interconnect (PCI) protocols with a 'P' in document figures and tables. The book identifies International Standard Architecture (ISA) and Extended International Standard Architecture (EISA) with an 'I' or with an 'E,' respectively, in figures and tables.

ISO 9000

ISO 9000 registered quality systems were used in the development and manufacturing of this product.

Online Publications

RS/6000 and pSeries publications are available online. To access the online books, visit our Web site at: http://www.rs6000.ibm.com/resource/hardware_docs/

Related Publications

Use this book with your system unit documentation and with your adapter's installation and user's guide to accurately place one or more adapters in your system unit.

Adapters, Devices and Cable Information for Multiple Bus Systems, (SA38-0516) provides specific technical information about adapters. Also use the publication to identify an adapter.

The *RS/6000 SP Planning Volume 1, Hardware and Physical Environment* (GA22-7280), contains adapter slot restriction information for SP nodes.

Trademarks

The following terms are trademarks of the International Business Machines Corporation in the United States, other countries, or both:

- AIX
- IBM ARTIC960
- ESCON
- PowerPC
- pSeries
- RS/6000
- SP
- TURBOWAYS

Microsoft and Windows NT are trademarks of Microsoft Corporation in the United States, other countries, or both.

Other company, product, and service names may be trademarks or service marks of others.

Chapter 1. Peripheral Component Interconnect Overview

This chapter presents a brief overview of some factors and issues related to Peripheral Component Interconnect (PCI) bus adapter placement. The user can gain a better understanding of system configurations, adapter placement, and performance issues by using the reference. Each of the following chapters provides system-specific slot placement information.

You can install PCI adapters with the power on in some systems. These adapters are referred to as *hot-pluggable* PCI adapters. **Do not hot-plug any PCI adapter supporting the system's boot device or system console.**

Refer to your system unit documentation to determine if your system unit supports hot-plugging adapters.

If an adapter is listed as a *Type **, this adapter has not been assigned an adapter type.

System Performance

This book provides performance information related to PCI adapter placement. Understand that maximizing system performance is relative to software and hardware. Information in this book may change as new products are announced.

PCI Slots

Each PCI bus has a limit on the number of adapters it can support. Typically, this limit can range from two adapters to six adapters per bus. To overcome this limit, the system design can implement multiple PCI buses. You can use two different methods to add PCI buses to your system. These two methods are:

- Adding secondary PCI buses off the primary PCI bus
- Implementing multiple primary buses

Secondary PCI Bus

If you want to increase the number of PCI slots when designing a system, add a secondary PCI bus. A PCI-to-PCI bridge chip can connect a secondary bus to a primary bus. The following illustration shows how to use a primary PCI bus to increase the total number of PCI slots.

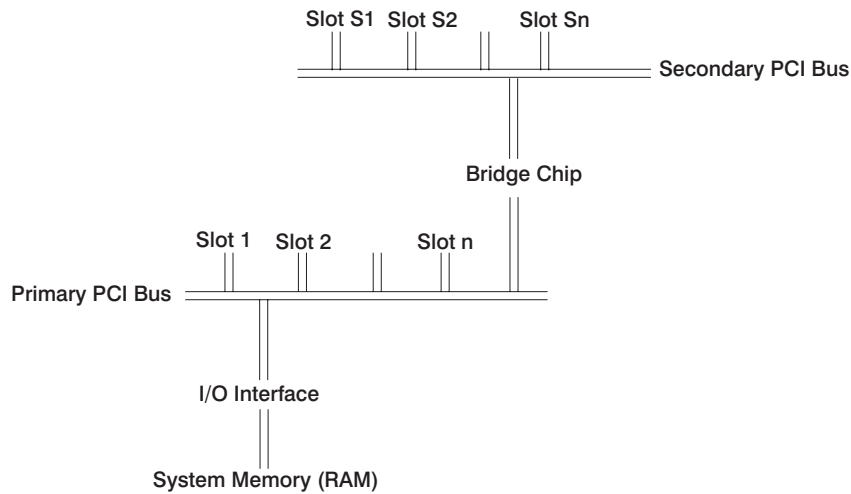

Because the slots on the secondary PCI bus must pass through the bridge chip, certain adapters on a secondary PCI bus may experience lower performance.

Some of the systems in this book implement a secondary PCI bus. On these systems, place higher-speed adapters on the primary bus to optimize performance.

Multiple Primary PCI Buses

To add more PCI slots in a different way, design the system with 2 or more primary PCI buses. This design requires a more sophisticated I/O interface with the system memory. The following illustration shows another method of increasing the number of PCI slots.

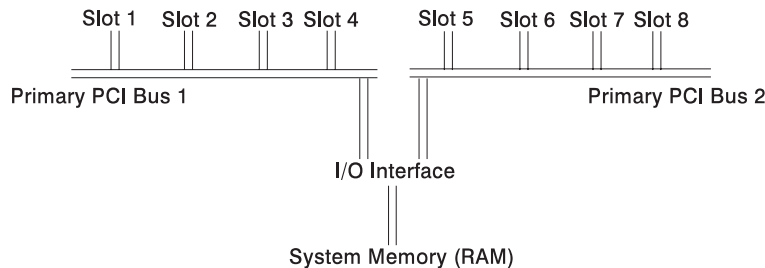

This design improves I/O performance over the secondary bus method because the I/O interface has created multiple parallel paths into the system memory.

Hot Pluggable PCI Slots

Certain newer systems contain hot-plug enabled PCI slots. These systems dedicate a PCI bus to each PCI slot, which allows the adapter to be removed or added without effecting other adapters. This architecture uses one or more PCI primary buses that are bridged to multiple PCI secondary buses. Each PCI secondary bus has a single PCI slot.

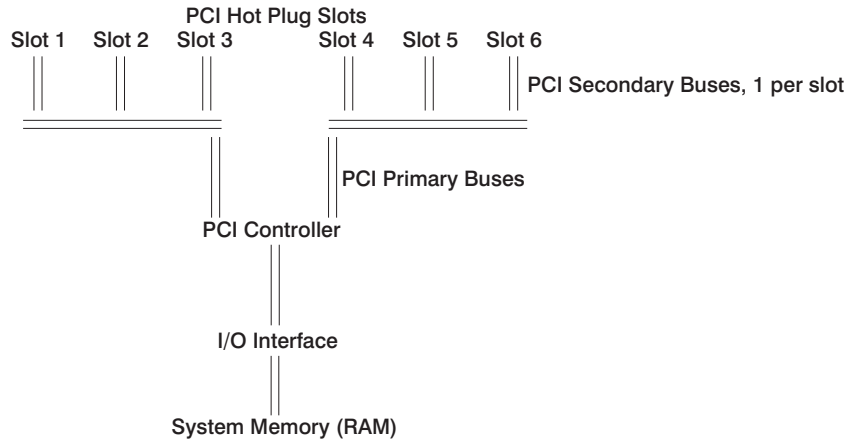

Integrated Adapters

The main processor board now integrates a number of devices, but they physically connect to one of the PCI buses. For this reason, some of the buses may only have two or three slots available to install adapters. Integrated PCI adapters include SCSI adapters and Ethernet adapters.

32-Bit Versus 64-Bit PCI Slots

Choosing between 32-bit and 64-bit slots influences slot placement and affects performance. Higher-speed adapters use 64-bit slots because they can transfer 64 bits of data for each data transfer phase.

32-bit adapters can typically function in 64-bit PCI slots; however, 32-bit adapters still operate in 32-bit mode and offer no performance advantage in a 64-bit slot. Likewise, most 64-bit adapters can operate in 32-bit PCI slots but the 64-bit adapter operates in 32-bit mode and reduces performance potential.

33 MHz versus 50/66 MHz 64-Bit PCI Slots

Some systems (for example, 7025 Model F50 and 7026 Model H50) offer 50 MHz capability on 64-bit slots. Adapters capable of functioning at 50 MHz may take advantage of this. If you plug a 33 MHz adapter into a 50 MHz 64-bit slot, the slot switches to 33 MHz and also switches the remaining slots on this PCI bus to 33 MHz. For systems with hot plug PCI slots, adapters are not affected by the clock rate of other adapters because each has its own PCI bus.

The following adapters run at 50 or 66 mhz when placed on a 50 or 66 mhz PCI bus, or 33 mhz when placed on a 33 mhz PCI bus. If you place a 33 Mhz adapter on the same 50/66 Mhz PCI bus with any of these adapters, the bus will run in 33 Mhz mode, which will reduce the performance potential of the following 50/66 MHz adapters:

- FC 2969: Gigabit Ethernet Fibre, 1000BaseT
- FC 2851: POWER GXT250P (Type 1-M)
- FC 2852: POWER GXT255P (Type 1-N)
- FC 2841: POWER GXT300P (Type1-U)
- FC 2823: POWER GXT2000P (Type 1-S)
- FC 2825: POWER GXT3000P (Type 1-R)
- FC 2946: PCI TURBOWAYS 622 PCI MMF ATM (Type A-B)
- FC 6228: Gigabit Fibre Channel Adapter, 32 or 64-bit PCI Bus (Type 4-W)
- FC 2975: Gigabit Ethernet (UTP) 1000BaseT
- FC 6205: PCI Dual Channel Ultra2 SCSI (Type 4-R)
- FC 2498: PCI 4-Channel Ultra3 SCSI RAID (Type 4-X)

Connectivity versus Performance Overview

You must consider some performance trade-offs when configuring your system. Installing the maximum number of adapters might affect system performance. The following paragraphs provide an overview of these considerations and how they are documented in later sections of this book.

Connectivity limits define how many specified adapters can be physically plugged into a system. This limit defines how many adapters the software and hardware can support. Some adapters have specific placement guidelines. Connectivity limits define the maximum number of adapters for connecting to networks or disks. In many cases, a disk or network has a low duty-cycle and the system needs additional adapters to retain the physical connection to all resources. In these cases, you should follow connectivity limits.

This book also provides suggested performance limits, established to determine how many concurrently running adapters can provide good performance. As you add adapters (with each adapter performing at close to its rated speed), additional adapters continue to provide an incremental performance increase. Once the system reaches its performance limit, adding more adapters does not provide an increase in I/O throughput.

A number of factors can determine the performance limit. Bus speed, memory speed, adapter design, or processor speed can influence performance. Quite often, the system processor's speed may limit how many adapters of a given type the system can support while maintaining maximum performance. Once a system uses 90 percent of its system processor, adding more adapters only provides a minor throughput increase.

Due to the wide variety of workloads, this book provides performance-limit guidelines only. The guidelines are based on I/O streaming of large reads or writes to a disk or network. They are not based on small I/Os, which are more transaction-rate limited.

Small I/O workloads probably use more system processor capacity and result in fewer supported adapters for maximum performance.

The book bases these guidelines on the maximum number of processors supported for multi-processor systems. If your system runs less than the maximum number of processors supported, then typically you must reduce the maximum number of adapters by the same ratio. For example, if a system with a maximum of twelve processors can support twelve ATM adapters for maximum performance, then the same system with eight processors can only support eight ATM adapters for maximum performance.

If your system uses disk and communication adapters concurrently, use a more conservative estimate of the number of supported adapters.

If your configured system runs close to its performance limits, take extra care to ensure that your system type or configuration provides the desired performance. In these cases, you may need to contact your marketing support personnel for more detailed information.

Other Restrictions

You must install some adapters in specific PCI slots in various systems. Physical size limits, I/O address considerations, thermal limitations, and other factors influence these specifications.

This book lists slot placement information for PCI adapters in system units that have specific restrictions or guidelines. However, *this book does not list all system-compatible PCI adapters.*

Chapter 2. Models S70, S7A, and S80

These systems are designed for service representatives to install adapters. Use this guide to determine if there are specific slot requirements for adapters that your service representative may be installing.

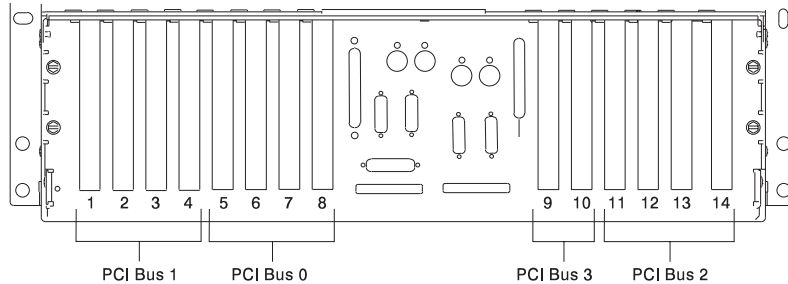

I/O Drawer Rear View with 14 Slots and 4 PCI Buses

Note: Each drawer has four PCI buses per drawer: Slots 1-4 (PCI Bus 1), 5-8 (PCI Bus 0), 9-10 (PCI Bus 3), 11-14 (PCI Bus 2). Slots 1, 5, 9, 10 and 14 are 64-bit slots. Remaining slots are 32-bit. The 32-bit adapters also function in the 64-bit slots. Each bus is considered a primary bus. All slots are 33 MHz.

Some adapters must be placed in specific I/O drawer slots to function correctly and to achieve optimum performance.

Many of the following notes refer to optimizing system performance. Read “System Performance” on page 1 for more performance-related information.

The following table shows the slot-plugging guidelines for Models S70, S7A, and S80 systems.

If two different adapters can be placed in the same slot, the highest priority adapter starts at the top of the table. The list of slot numbers represent the order that the slots should be used in a drawer.

For complete system placement, the first slot for a group of adapters is selected in the first drawer, and then the first slot is selected in the next drawer. After the first slot selection has been used for each drawer, the second slot in the list is used. This also rotates through the available drawers. If a card has already been placed in a slot, the slot is not available for future adapter placement.

If a table row lists more than one adapter, the adapters may be mixed, but the total number of adapters in the combination cannot exceed the number stated in the Maximum column.

The primary drawer referenced in the following table is the I/O drawer that has a service processor card installed in slot 8. Secondary drawers are additional I/O drawers that may be added to a Models S70, S7A, and S80 configuration. Secondary drawers do not have a service processor installed.

Table 1. Models S70, S7A, and S80

Adapter	Slot Usage	S70 Max	S7A Max	S80 Max
FC 6326: Service Processor	Primary drawer slot 8	1 per system	1 per system	1 per system
FC 8396: SP System Attachment PCI (Type 6-F) FC 8397: SP Colony Switch Attach See "Chapter 28. 9076 RS/6000 SP Systems" on page 183	Primary drawer slot 10; slots 9 and 11 must be empty	1 per system	1 per system	1 per system
FC 6310: IBM ARTIC960 RxD Quad Digital Trunk PCI (Type 6-E)	Primary drawer - slots 1, 3, 4, 2 Secondary drawer - slots 1, 3, 4, 2 See "Chapter 29. Digital Trunk PCI Adapter Placement Considerations" on page 185 and note 13 on page 15	4 per system	4 per system	4 per system
FC 6311: IBM ARTIC960 RxF PCI (Type 6-G)	Primary drawer slots 3, 2, 4 Secondary drawer slots - 3, 2, 4 See "Chapter 29. Digital Trunk PCI Adapter Placement Considerations" on page 185 and note 13 on page 15	N/A	3 per system see "Chapter 29. Digital Trunk PCI Adapter Placement Considerations" on page 185	N/A
FC 2751: S/390 ESCON Channel (Type 5-5)	Primary drawer slots 14, 10 Secondary drawer slots 14, 10 FC 2751: S/390 ESCON Channel (Type 5-5) adapters can only be installed in the primary I/O drawer and the secondary I/O drawer that are cabled in the same RIO loop. See note 11 on page 15	4 per system	4 per system	4 per system

Table 1. Models S70, S7A, and S80 (continued)

Adapter	Slot Usage	S70 Max	S7A Max	S80 Max
FC 6208: PCI SCSI-2 Single Ended Fast/Wide (Type 4-A) Factory installed to support internal media drives.	Primary drawer - slot 7 Secondary drawer - slot 8 (As required) Systems manufactured before October 23, 1998 may have this adapter installed in slot 2.	1 per drawer	N/A	N/A
FC 6206: Single-Ended Ultra SCSI Adapter (Type 4-K) Slot 7 is SCSI Media, slots 13 and 16 are SCSI drive	S7A and S80 Only Primary drawer - slot 7, 13, 6 Secondary drawer - slot 13, 6 (As required)	N/A	3 per drawer	3 per drawer
FC 6227: Gigabit Fibre Channel PCI (Type 4-S) (see note 5 on page 14)	Primary drawer - slots 10, 14, 1 Secondary drawer - slots 1, 5, 10, 14	4 per system 4 per I/O drawer	15 per system 4 per I/O drawer	15 per system 4 per I/O drawer
FC 6228: Gigabit Fibre Channel Adapter, 32 or 64-bit PCI Bus (Type 4-W)	Primary drawer - slots 10, 14, 1 Secondary drawer - slots 1, 5, 10, 14	N/A	15	15
FC 2946: PCI TURBOWAYS 622 PCI MMF ATM (Type A-B)	Primary drawer - slots 10, 14, 1, 9 Secondary drawer - slots 1, 5, 9, 14, 10, 2, 6, 11, 3, 7, 12, 4, 8, 13 (See "Performance Limits" on page 15)	N/A	19 per system, max of 4 in primary and 5 in secondary drawers	19 per system, max of 4 in primary and 5 in secondary drawers
FC 2975: Gigabit Ethernet (UTP) 1000BaseT	Primary drawer - slots 10, 1, 9, 3, 4, 2 Secondary drawer - slots 1, 5, 10, 9, 3, 7	N/A	24 per system (See "Performance Limits" on page 15 and note 14 on page 15)	24 per system (See "Performance Limits" on page 15 and note 14 on page 15)
FC 2493: PCI SCSI-2 Fast/Wide RAID (Type 4-H) (S70 only)	Primary drawer - slots 10, 14, 1 Secondary drawer - slots 1, 5, 10, 14	12	12	N/A

Table 1. Models S70, S7A, and S80 (continued)

Adapter	Slot Usage	S70 Max	S7A Max	S80 Max
FC 6215: PCI SSA Multi-Initiator/RAID EL (Type 4-N) See notes 1 on page 14 and 2 on page 14	Primary drawer - slots 3, 14, 10, 12, 1, 9 Secondary drawer - slots 1, 5, 10, 14, 3, 7, 12, 9	26 per system	26 per system	26 per system
FC 6225: Advanced SSA SerialRAID (Type 4-P) See note 2 on page 14	Primary drawer - slots 3, 14, 10, 12, 1, 9 Secondary drawer - slots 1, 5, 10, 14, 3, 7, 12, 9	26 per system	26 per system	26 per system
FC 6230: Advanced SerialRAID Plus (Type 4-P) See note 2 on page 14 FC 6230+6231: 4 Port SSA 40 w/128MB DIMM	Primary drawer - slots 3, 14, 10, 12, 1, 9 Secondary drawer - slots 1, 5, 10, 14, 3, 7, 12, 9 See note 12 on page 15	26 per system	26 per system	26 per system
FC 6205: PCI Dual Channel Ultra2 SCSI (Type 4-R) FC 6203: Dual-Channel Ultra3 SCSI (Type 4-Y) (S80 only)	Primary drawer - slots 3, 14, 10, 12, 1, 9 Secondary drawer - slots 1, 5, 10, 14, 3, 7, 12, 9	N/A	26 per system See note 10 on page 15	26 per system 11 per drawer See notes 10 on page 15 and 12 on page 15
FC 2498: PCI 4-Channel Ultra3 SCSI RAID (Type 4-X)	Primary drawer - slots 3, 14, 10, 12, 1 Secondary drawer - slots 1, 5, 10, 14, 3, 7, 12	N/A	15 per system See note 10 on page 15	15 per system See note 10 on page 15
FC 4961: 10/100 4-Port Ethernet (Type A-E) See note 15 on page 15	Primary drawer slots - 3, 10, 1, 9, 4, 2 Secondary drawer slots - 1, 5, 10, 3, 7, 9, 4 (See 16 on page 15)	N/A	N/A	19 per system

Table 1. Models S70, S7A, and S80 (continued)

Adapter	Slot Usage	S70 Max	S7A Max	S80 Max
FC 2838: POWER GXT120P (Type 1-P) See note 3 on page 14	Primary drawer - slots 1, 4 See note 12 on page 15	1 per system	1 per system	1 per system
FC 2830: POWER GXT130P (Type 1-T) See note 3 on page 14	Primary drawer - slots 1, 4 See note 12 on page 15	1 per system	1 per system	1 per system
FC 2969: Gigabit Ethernet Fibre, 1000BaseT	Primary drawer slots - 10, 1, 9, 3, 4, 2 Secondary drawer slots - 1, 5, 10, 9, 3, 7	8 See note 5 on page 14	8 See note 5 on page 14	24 per system See note 5 on page 14
FC 2963: TURBOWAYS 155 PCI UTP ATM (Type 9-J) FC 2988: TURBOWAYS 155 PCI MMF ATM (Type 9-F)	Primary drawer - slots 2, 4, 9, 11, 13, 3, 10, 12, 6, 1, 5, 7 Secondary drawer - slots 2, 4, 6, 8, 9, 11, 13, 3, 7, 10, 12, 14, 1, 5 See note 11 on page 15	16 per system (See note 6 on page 14)	16 per system (See note 6 on page 14)	26 per system 11 per drawer (See note 6 on page 14)
FC 4953: 64-bit/66MHz PCI ATM 155 UTP (Type A-C) (S80 only) FC 4957: 64-bit/66MHz PCI ATM 155 MMF (Type A-D) (S80 only) See note 8 on page 14	Primary drawer - slots 2, 4, 9, 11, 13, 3, 10, 12, 6, 1, 5, 7 Secondary drawer - slots 2, 4, 6, 8, 9, 11, 13, 3, 7, 10, 12, 14, 1, 5 See note 11 on page 15	Not Supported	Not Supported	Not Supported
FC 2968: 10/100 Mbps Ethernet Tx PCI (Type 9-P) FC 4962: Ethernet/LAN Encryption 10/100BaseT See note 8 on page 14	Primary drawer - slots 2, 4, 9, 11, 13, 3, 10, 12, 6, 1, 5, 7 Secondary drawer - slots 2, 4, 6, 8, 9, 11, 13, 3, 7, 10, 12, 14, 1, 5 See note 11 on page 15	26 per system (See note 6 on page 14)	26 per system (See note 6 on page 14)	26 per system 11 per drawer See note 6 on page 14)

Table 1. Models S70, S7A, and S80 (continued)

Adapter	Slot Usage	S70 Max	S7A Max	S80 Max
FC 4959: High-Speed Token Ring PCI (Type 9-Y)	Primary drawer - slots 2, 4, 9, 11, 13, 3, 10, 12, 6, 1, 5, 7 Secondary drawer - slots 2, 4, 6, 8, 9, 11, 13, 3, 7, 10, 12, 14, 1, 5	26 per system	26 per system	26 per system
FC 2743: SysKonnnect SK-NET FDDI-UP SAS PCI (Type *) FC 2742: SysKonnnect SK-NET FDDI-LP DAS PCI (Type *) FC 2741: SysKonnnect SK-NET FDDI-LP SAS PCI (Type *)	Primary drawer - slots 2, 4, 9, 11, 13, 3, 10, 12, 6, 1, 5, 7 Secondary drawer - slots 2, 4, 6, 8, 9, 11, 13, 3, 7, 10, 12, 14, 1, 5	12 per system (See note 6 on page 14)	26 per system (See note 6 on page 14)	26 per system (See note 6 on page 14)
FC 2947: IBM ARTIC960Hx 4-Port Selectable PCI (Type 9-R)	Primary drawer - slots 1, 3, 5, 10, 12, 14 Secondary drawer - slots 1, 3, 5, 7, 10, 12, 14	7 per system	14 per system	14 per system
FC 2948: IBM ARTIC960 4-Port T1/E1 PCI (Type 9-S)	Primary drawer - slots 1, 3, 5, 10, 12, 14 Secondary drawer - slots 1, 3, 5, 7, 10, 12, 14	14 per system	14 per system	N/A
FC 2943: 8-Port Asynchronous EIA-232E/RS-422A PCI (Type 3-B)	Primary drawer - slots 1, 3, 4, 11, 12, 13, 14, 10, 5, 9 Secondary drawer - slots 1, 5, 10, 11, 3, 6, 12, 14, 2, 9, 13, 4, 7	8 per system	8 per system	16 per system
FC 2944: 128-Port Async Controller PCI (Type 3-C)	Primary drawer - slots 1, 3, 4, 11, 12, 13, 14, 10, 5, 9, 7 Secondary drawer - slots 1, 5, 10, 11, 3, 6, 12, 14, 2, 9, 13, 4, 7	8 per system	16 per system	32 per system
FC 6208: PCI SCSI-2 Single Ended Fast/Wide (Type 4-A) FC 6206: Single-Ended Ultra SCSI Adapter (Type 4-K) (S7A, S80 only)	Primary drawer - slots 1, 10, 14, 3, 9, 4, 12, 11, 5, 6, 2, 7 Secondary drawer - slots 9, 2, 1, 5, 10, 11, 3, 6, 12, 4, 7, 13, 8, 14 See note 4 on page 14	40 per system (See note 4 on page 14)	40 per system (See note 4 on page 14)	40 per system (See note 4 on page 14)

Table 1. Models S70, S7A, and S80 (continued)

Adapter	Slot Usage	S70 Max	S7A Max	S80 Max
FC 6209: PCI SCSI-2 Differential Fast/Wide (Type 4-B)	Primary drawer - slots 1, 10, 14, 3, 13, 4, 12, 11, 5, 6, 7	40 per system	40 per system	40 per system
FC 6207: PCI Differential Ultra SCSI (Type 4-L)	Secondary drawer - slots 1, 5, 10, 11, 3, 6, 12, 4, 7, 13, 8, 14	(See note 4 on page 14)	(See note 4 on page 14)	(See note 4 on page 14)
FC 6204: PCI Universal Differential Ultra SCSI (Type 4-U) (S80 Only)				
FC 2708: ISDN Basic Rate PCI (Type 9-N)	Primary drawer - slots 10, 14, 3, 13, 4, 12, 11, 5, 9, 1, 2, 5	1 per system	1 per system	1 per system
	Secondary drawer - slots 1, 5, 10, 11, 3, 6, 12, 4, 7, 13, 8, 14, 9, 2			
FC 2920: 16Mbps PCI Token-Ring (Type 9-0)	Primary drawer - slots 10, 14, 3, 13, 4, 12, 11, 5, 9, 1, 2	9 per drawer	9 per drawer	9 per drawer
	Secondary drawer - slots 1, 5, 10, 11, 3, 6, 12, 4, 7, 13, 8, 14, 9, 2	24 per system	24 per system	24 per system
FC 2962: 2-Port Multiprotocol PCI (Types 9-L and 9-V)	Primary drawer - slots 10, 14, 3, 13, 4, 12, 11, 5, 9, 1, 2	9 per drawer	18 per system	18 per system
	Secondary drawer - slots 1, 5, 10, 11, 3, 6, 12, 4, 7, 13, 8, 14, 9, 2	18 per system		
FC 2986: 10/100 Mbps PCI Fast Etherlink XL (Type *)	Primary drawer - slots 10, 14, 3, 13, 4, 12, 11, 5, 9, 1, 2	4 per drawer	4 per drawer	4 per drawer
	Secondary drawer - slots 1, 5, 10, 11, 3, 6, 12, 4, 7, 13, 8, 14, 9, 2	12 per system	12 per system	12 per system
		(See note 6 on page 14)	(See note 6 on page 14)	(See note 6 on page 14)
FC 2979: PCI Auto LANstreamer Token Ring (Type 8-T)	Primary drawer - slots 10, 14, 3, 13, 4, 12, 11, 5, 9, 1, 2	24 per system	24 per system	24 per system
	Secondary drawer - slots 1, 5, 10, 11, 3, 6, 12, 4, 7, 13, 8, 14, 9, 2			
FC 2985: Ethernet 10base2 PCI (Type 8-Y)	Primary drawer - slots 10, 14, 3, 13, 4, 12, 11, 5, 9, 1, 2	24 per system	24 per system	24 per system
See note 7 on page 14	Secondary drawer - slots 1, 5, 10, 11, 3, 6, 12, 4, 7, 13, 8, 14, 9, 2			

Table 1. Models S70, S7A, and S80 (continued)

Adapter	Slot Usage	S70 Max	S7A Max	S80 Max
FC 4960: IBM Cryptographic Accelerator (Type 6-J)	Primary drawer - slots 10, 14, 3, 13, 4, 12, 11, 5, 9, 1, 2	N/A	N/A	8 per system
	Secondary drawer - slots 1, 5, 10, 11, 3, 6, 12, 4, 7, 13, 8, 14, 9, 2			4 per drawer 4 per drawer
FC 2987: Ethernet 10base5 PCI (Type 8-Z)	Primary drawer - slots 10, 14, 3, 13, 4, 12, 11, 5, 9, 1, 2	24 per system	24 per system	24 per system
	Secondary drawer - slots 1, 5, 10, 11, 3, 6, 12, 4, 7, 13, 8, 14, 9, 2			

Notes:

- The use of the FC 6215: PCI SSA Multi-Initiator/RAID EL (Type 4-N) in the S70 I/O drawer limits the system usage to a 28°C (82°F) environment maximum.
If installing a FC 6215: PCI SSA Multi-Initiator/RAID EL (Type 4-N) adapter, remove the screws from the blue plastic adapter guide and remove the guide before you install it in your S70 (save the guide and screws if you plan to install this adapter in a different system later).
For maximum system performance, use a maximum of 16 adapters per system. Use 1 adapter per bus and 4 adapters per drawer.
- Remove handle from the FC 6215: PCI SSA Multi-Initiator/RAID EL (Type 4-N) adapter before installation.
- The manufacturer strongly recommends you locate the FC 2838: POWER GXT120P (Type 1-P) and FC 2830: POWER GXT130P (Type 1-T) adapters in the primary I/O drawer. This placement provides you with the maximum amount of diagnostic feedback if your system encounters errors. *Do not* use the FC 2830: POWER GXT130P (Type 1-T) in I/O drawers 3 or 4.
- When using a non-Ultra2/LVD SCSI adapter, use a maximum of 40 storage adapters per system and 10 storage adapters per I/O drawer. See “Performance Limits” on page 15 for more performance-related system information.
- Contact your marketing representative for information about this adapter. For performance-related information, see “Performance Limits” on page 15.
- See “Performance Limits” on page 15 for more performance-related system information.
- For optimum system performance, the FC 2968: 10/100 Mbps Ethernet Tx PCI (Type 9-P) adapter or FC 2986: 10/100 Mbps PCI Fast Etherlink XL (Type *) adapters are recommended instead of this adapter.
- For optimum system performance, models S70, S7A and S80 support any combination of the following adapters, but the maximum combination varies according to your system. See “Performance Limits” on page 15 for more information.
 - 155 TURBOWAYS ATM PCI MMF, when used in LAN emulation (LANE) mode
 - 155 TURBOWAYS ATM PCI UTP, when used in LAN emulation (LANE) mode

- 10/100 Mbps Ethernet PCI, when used in 100 Mbps mode
9. See “Performance Limits” for performance-related information. Because only three adapters are recommended per bus, limit placement to 11 adapters per drawer for optimum performance.
 10. For optimum system performance, install a maximum of two FC 6205: PCI Dual Channel Ultra2 SCSI (Type 4-R) and/or FC 6203: Dual-Channel Ultra3 SCSI (Type 4-Y) adapters per bus, 7 per drawer and 26 per system.
 11. Do not install the following adapters in the slot to the right (looking from the rear) of the FC 2751: S/390 ESCON Channel (Type 5-5) adapter.
 - FC 2988: TURBOWAYS 155 PCI MMF ATM (Type 9-F)
 - FC 2968: 10/100 Mbps Ethernet Tx PCI (Type 9-P)
 - FC 2733: Serial HIPPI, Long-Wave Optics
 12. Do not install an FC 6205: PCI Dual Channel Ultra2 SCSI (Type 4-R) or FC 6203: Dual-Channel Ultra3 SCSI (Type 4-Y) adapter in the same PCI bus as a FC 2830: POWER GXT130P (Type 1-T) or FC 2838: POWER GXT120P (Type 1-P).
 13. Do not install more than a combination of six FC 6310: IBM ARTIC960 RxD Quad Digital Trunk PCI (Type 6-E)s and FC 6311: IBM ARTIC960 RxF PCI (Type 6-G) s in this system.
 14. This placement is for connectivity, and not all adapters will run at rated throughput. There are certain applications where it is advantageous to have one LAN adapter per processor. This placement supports a 24 way with this configuration.
 15. For optimum system performance, do not use more than 2 of the 4 ports on the FC 4961: 10/100 4-Port Ethernet (Type A-E).
 16. For optimum performance using the FC 4961: 10/100 4-Port Ethernet (Type A-E) adapter, use only two ports per adapter, two adapters per I/O drawer, and eight per system. Install the adapters on separate PCI buses.

Performance Limits

This section contains system maximum suggestions for certain adapters. Apply these suggestions for optimum system performance and use the table above for specific slot-plugging guidelines. For more performance-related information, see “System Performance” on page 1.

The quantity of installed processors affects the performance of installed adapters. The table below provides some guidelines that compare performance characteristics of certain adapters. These performance characteristics vary according to the number of installed processors in a system.

The following table provides adapter maximum information for running up to 12 processors (12-way) in the Models S70, S7A, and S80 systems. It also provides adapter maximum information for running up to 24 processors (24-way) in the S80 system only.

Table 2. Models S70, S7A, and S80 Performance Limits

Adapter	S70 Max 12 Way 125 mhz	S7A Max 12 Way 262 mhz	S80Max 12 Way 450 mhz	S80 Max 24 Way 450 mhz
FC 2969: Gigabit Ethernet Fibre, 1000BaseT				
MTU 1500	Not Tested	2	6	8
MTU 9000 (Jumbo)	Not Tested	4	7	8
See note 3 on page 17			(see note 1 on page 17)	(see note 1 on page 17)
FC 2975: Gigabit Ethernet (UTP) 1000BaseT				
MTU 1500	Not Tested	2	6	8
MTU 9000 (Jumbo)	Not Tested	4	7	8
See note 3 on page 17			(see note 1 on page 17)	(see note 1 on page 17)
FC 2968: 10/100 Mbps Ethernet Tx PCI (Type 9-P)				
10 Mbs FDX	26	26	26	26
100 Mbs FDX	5	10	15	22
See note 3 on page 17				
TURBOWAYS 155 PCI MMF/UTP ATM				
MTU 1500	5	10	15	18
MTU 9180	10	14	22	26
See note 3 on page 17.				
FDDI SK-NET	6	12	20	26
See notes 2 on page 17 and 3 on page 17				
FC 2946: PCI TURBOWAYS 622 PCI MMF ATM (Type A-B)				
MTU 1500	Not tested	8	16	16
MTU 9180	Not tested	4	8	8
			See note 4 on page 17	See note 4 on page 17

Notes:

1. For maximum performance, install only two FC 2969: Gigabit Ethernet Fibre, 1000BaseT or two FC 2975: Gigabit Ethernet (UTP) 1000BaseT adapters (or one of each) per I/O drawer, 1 per bus.
2. This includes the following adapters:
 - FC 2743: SysKonnnect SK-NET FDDI-UP SAS PCI (Type *)
 - FC 2742: SysKonnnect SK-NET FDDI-LP DAS PCI (Type *)
 - FC 2741: SysKonnnect SK-NET FDDI-LP SAS PCI (Type *)
3. For maximum performance, limit these adapters to 8 per drawer, 2 per bus.\
4. For best performance, limit FC 2946: PCI TURBOWAYS 622 PCI MMF ATM (Type A-B) to 4 adapters per I/O drawer, and 1 adapter per PCI bus.

Models S70, S7A, and S80 Configuration Details

- The recommended location for the boot device (SCSI or Network) and graphics adapter is within the primary I/O drawer (Drawer 0). This configuration provides service personnel with the maximum amount of diagnostic information if your system encounters errors in the boot sequence.
- Consider placing the AIX rootvg volume group in the primary I/O drawer. This allows AIX to boot if other I/O drawers are found offline during boot.
- The default Boot Drive is in the center disk bay's lowest slot in the S70. In the S7A and S80, the default Boot Drive is also in the center disk's bay's lowest slot if only one backplane is installed. If two backplanes are installed in the S7A and S80, the default Boot Drive resides in the lowest slot in the righthand bay.
- SCSI-2 disk bays in an I/O drawer are connected and driven by a single SCSI adapter, installed in **slot 9** or **slot 13**. Ultra SCSI disk bays (in S7A and S80) are driven by separate Ultra SCSI adapters. Slot 13 drives the center bay, and slot 6 drives the righthand bay (if present). These adapters are optional on secondary I/O drawers.
- SCSI-2 media bays in the i/o drawers are driven by a single scsi adapter in either **slot 2** or **slot 7** depending on manufacture date of the system. Systems manufactured before November 1998 will have this adapter in **slot 2**, all others in **slot 7**. Ultra systems have the media bay driven from **slot 7**. This adapter is optional on secondary I/O drawers.
- The Service Processor must occupy **slot 8** of the primary I/O drawer.
- The FC 2493: PCI SCSI-2 Fast/Wide RAID (Type 4-H) adapter installed in the primary SCSI I/O drawer can only be connected to external devices. The SCSI RAID Adapter installed in secondary I/O drawers can be connected to internal disk bays.
- When possible, place the FC 6215: PCI SSA Multi-Initiator/RAID EL (Type 4-N), the FC 6225: Advanced SSA SerialRAID (Type 4-P) , the FC 6230: Advanced SerialRAID Plus (Type 4-P), and the FC 2493: PCI SCSI-2 Fast/Wide RAID (Type 4-H) on their own buses.
- Maximum limitations exist on adapters and devices that are specific to the adapter or device and are not interaction limits with others. This information can be found in the product sales manual.
- I/O slot 9 does not support any long PCI adapter with backside components.

Chapter 3. pSeries 680 Model S85

These systems are designed for service representatives to install adapters. Use this guide to determine if there are specific slot requirements for adapters that your service representative may be installing.

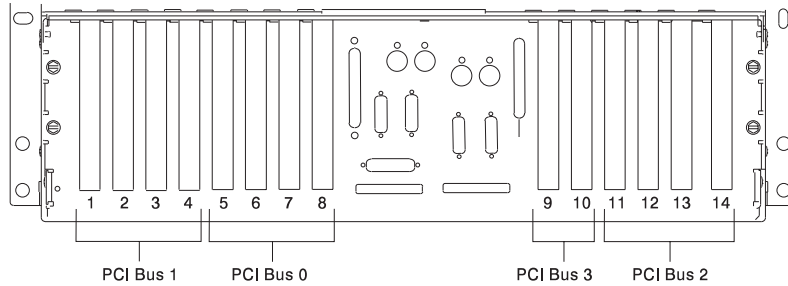

I/O Drawer Rear View with 14 Slots and 4 PCI Buses

Note: Each drawer has four PCI buses per drawer: Slots 1-4 (PCI Bus 1), 5-8 (PCI Bus 0), 9-10 (PCI Bus 3), 11-14 (PCI Bus 2). Slots 1, 5, 9, 10 and 14 are 64-bit slots. Remaining slots are 32-bit. The 32-bit adapters also function in the 64-bit slots. Each bus is considered a primary bus. All slots are 33 MHz.

Some adapters must be placed in specific I/O drawer slots to function correctly and to achieve optimum performance.

Many of the following notes refer to optimizing system performance. Read “System Performance” on page 1 for more performance-related information.

The following table shows the slot-plugging guidelines for pSeries 680 Model S85 systems.

If two different adapters can be placed in the same slot, the highest priority adapter starts at the top of the table. The list of slot numbers represent the order that the slots should be used in a drawer.

For complete system placement, the first slot for a group of adapters is selected in the first drawer, and then the first slot is selected in the next drawer. After the first slot selection has been used for each drawer, the second slot in the list is used. This also rotates through the available drawers. If a card has already been placed in a slot, the slot is not available for future adapter placement.

If a table row lists more than one adapter, the adapters may be mixed, but the total number of adapters in the combination cannot exceed the number stated in the Maximum column.

The primary drawer referenced in the following table is the I/O drawer that has a service processor card installed in slot 8. Secondary drawers are additional I/O drawers that may be added to a pSeries 680 Model S85 configuration. Secondary drawers do not have a service processor installed.

Table 3. pSeries 680 Model S85

Adapter	Slot Usage	Max
FC 6326: Service Processor	Primary drawer slot 8	1 per system
FC 8396: SP System Attachment PCI (Type 6-F) FC 8397: SP Colony Switch Attach See "Chapter 28. 9076 RS/6000 SP Systems" on page 183	Primary drawer slot 10; slots 9 and 11 must be empty	1 per system
FC 2751: S/390 ESCON Channel (Type 5-5)	Primary drawer slots 14, 10 Secondary drawer slots 14, 10 FC 2751: S/390 ESCON Channel (Type 5-5) adapters can only be installed in the primary I/O drawer and the secondary I/O drawer that are cabled in the same RIO loop. See note 10 on page 24	4 per system
FC 6206: Single-Ended Ultra SCSI Adapter (Type 4-K) Slot 7 is SCSI Media, slots 13 and 6 are SCSI drive	Primary drawer - slot 7, 13, 6 Secondary drawer - slot 8 (As required) See note 16	3 per drawer
FC 6227: Gigabit Fibre Channel PCI (Type 4-S) (see note 4 on page 24)	Primary drawer - slots 10, 14, 1 Secondary drawer - slots 1, 5, 10, 14	15 per system 4 per I/O drawer

Table 3. pSeries 680 Model S85 (continued)

Adapter	Slot Usage	Max
FC 2946: PCI TURBOWAYS 622 PCI MMF ATM (Type A-B)	Primary drawer - slots 10, 14, 1, 9 Secondary drawer - slots 1, 5, 9, 14, 10, 2, 6, 11, 3, 7, 12, 4, 8, 13	19 per system, max of 4 in primary and 5 in secondary drawers (see note "Performance Limits" on page 26)
FC 6228: Gigabit Fibre Channel Adapter, 32 or 64-bit PCI Bus (Type 4-W)	Primary drawer - slots 10, 14, 1 Secondary drawer - slots 1, 5, 10, 14	15 per system, 4 per I/O drawer
FC 6230: Advanced SerialRAID Plus (Type 4-P) See note 1 on page 24 FC 6230+6231: 4 Port SSA 40 w/128MB DIMM	Primary drawer - slots 3, 14, 10, 12, 1, 9 Secondary drawer - slots 1, 5, 10, 14, 3, 7, 12 See note 11 on page 25	26 per system
FC 6205: PCI Dual Channel Ultra2 SCSI (Type 4-R) FC 6203: Dual-Channel Ultra3 SCSI (Type 4-Y)	Primary drawer slots - 3, 14, 10, 12, 1, 9 Secondary drawer slots - 1, 5, 10, 14, 3, 7, 12, 9	26 per system 11 per drawer See notes 9 on page 24 and 11 on page 25
FC 2498: PCI 4-Channel Ultra3 SCSI RAID (Type 4-X)	Primary drawer slots - 3, 14, 10, 12, 1, 9 Secondary drawer slots - 1, 5, 10, 14, 3, 7, 12, 9	15 per system
FC 4961: 10/100 4-Port Ethernet (Type A-E)	Primary drawer slots - 3, 10, 1, 9, 4, 2 Secondary drawer slots - 1, 5, 10, 3, 7, 9, 4	19 per system (See note 18 on page 25)
FC 2830: POWER GXT130P (Type 1-T) See note 2 on page 24	Primary drawer - slots 1, 4 See note 11 on page 25	1 per system
FC 2969: Gigabit Ethernet Fibre, 1000BaseT	Primary drawer slots - 10, 1, 9, 3, 4, 2 Secondary drawer slots - 1, 5, 10, 9, 3, 7	24 per system See note 17 and "Performance Limits" on page 26

Table 3. pSeries 680 Model S85 (continued)

Adapter	Slot Usage	Max
FC 2975: Gigabit Ethernet (UTP) 1000BaseT	Primary drawer slots - 10, 1, 9, 3, 4, 2 Secondary drawer slots - 1, 5, 10, 9, 3, 7	24 per system See note 17 and "Performance Limits" on page 26)
FC 2963: TURBOWAYS 155 PCI UTP ATM (Type 9-J) FC 2988: TURBOWAYS 155 PCI MMF ATM (Type 9-F) FC 4953: 64-bit/66MHz PCI ATM 155 UTP (Type A-C) FC 4957: 64-bit/66MHz PCI ATM 155 MMF (Type A-D) See note 7 on page 24	Primary drawer - slots 2, 4, 9, 11, 13, 3, 10, 12, 6, 1, 5, 7 Secondary drawer - slots 2, 4, 6, 8, 9, 11, 13, 3, 7, 10, 12, 14, 1, 5 See note 10 on page 24	26 per system, 11 per drawer (See note 5 on page 24)
FC 2968: 10/100 Mbps Ethernet Tx PCI (Type 9-P) FC 4962: Ethernet/LAN Encryption 10/100BaseT See note 7 on page 24	Primary drawer - slots 2, 4, 9, 11, 13, 3, 10, 12, 6, 1, 5, 7 Secondary drawer - slots 2, 4, 6, 8, 9, 11, 13, 3, 7, 10, 12, 14, 1, 5 See note 10 on page 24	26 per system, 11 per drawer (See note 5 on page 24)
FC 4959: High-Speed Token Ring PCI (Type 9-Y)	Primary drawer - slots 2, 4, 9, 11, 13, 3, 10, 12, 6, 1, 5, 7 Secondary drawer - slots 2, 4, 6, 8, 9, 11, 13, 3, 7, 10, 12, 14, 1, 5	26 per system

Table 3. pSeries 680 Model S85 (continued)

Adapter	Slot Usage	Max
FC 2743: SysKonnnect SK-NET FDDI-UP SAS PCI (Type *) FC 2742: SysKonnnect SK-NET FDDI-LP DAS PCI (Type *) FC 2741: SysKonnnect SK-NET FDDI-LP SAS PCI (Type *)	Primary drawer - slots 2, 4, 9, 11, 13, 3, 10, 12, 6, 1, 5, 7 Secondary drawer - slots 2, 4, 6, 8, 9, 11, 13, 3, 7, 10, 12, 14, 1, 5	26 per system (See note 5 on page 24)
FC 2947: IBM ARTIC960Hx 4-Port Selectable PCI (Type 9-R)	Primary drawer - slots 1, 3, 5, 10, 12, 14, 7 Secondary drawer - slots 1, 3, 5, 7, 10, 12, 14	14 per system
FC 2943: 8-Port Asynchronous EIA-232E/RS-422A PCI (Type 3-B)	Primary drawer - slots 1, 3, 4, 11, 12, 13, 14, 10, 5, 9, 7 Secondary drawer - slots 1, 5, 10, 11, 3, 6, 12, 14, 2, 9, 13, 4, 7	16 per system
FC 2944: 128-Port Async Controller PCI (Type 3-C)	Primary drawer - slots 1, 3, 4, 11, 12, 13, 14, 10, 5, 9, 7 Secondary drawer - slots 1, 5, 10, 11, 3, 6, 12, 14, 2, 9, 13, 4, 7	32 per system
FC 6206: Single-Ended Ultra SCSI Adapter (Type 4-K)	Primary drawer - slots 1, 10, 14, 3, 9, 4, 12, 11, 5, 6, 2, 7 Secondary drawer - slots 9, 2, 1, 5, 10, 11, 3, 6, 12, 4, 7, 13, 8, 14	40 per system (See note 3 on page 24)
FC 6204: PCI Universal Differential Ultra SCSI (Type 4-U)	Primary drawer - slots 1, 10, 14, 3, 13, 4, 12, 11, 5, 6, 9, 2, 7 Secondary drawer - slots 1, 5, 10, 11, 3, 6, 12, 4, 7, 13, 8, 14, 9, 2	40 per system (See note 3 on page 24)
FC 2962: 2-Port Multiprotocol PCI (Types 9-L and 9-V)	Primary drawer - slots 10, 14, 3, 13, 4, 12, 11, 5, 9, 1, 2, 7 Secondary drawer - slots 1, 5, 10, 11, 3, 6, 12, 4, 7, 13, 8, 14, 9, 2	18 per system 9 per drawer

Table 3. pSeries 680 Model S85 (continued)

Adapter	Slot Usage	Max
FC 2985: Ethernet 10base2 PCI (Type 8-Y) See note 6	Primary drawer - slots 10, 14, 3, 13, 4, 12, 11, 5, 9, 1, 2 Secondary drawer - slots 1, 5, 10, 11, 3, 6, 12, 4, 7, 13, 8, 14, 9, 2	24 per system
FC 4960: IBM Cryptographic Accelerator (Type 6-J)	Primary drawer - slots 10, 14, 3, 13, 4, 12, 11, 5, 9, 1, 2 Secondary drawer - slots 1, 5, 10, 11, 3, 6, 12, 4, 7, 13, 8, 14, 9, 2	8 per system 4 per drawer

Notes:

1. Remove the handle from your SSA adapter after you have installed it.
2. The manufacturer strongly recommends you locate FC 2830: POWER GXT130P (Type 1-T) in the primary I/O drawer. This placement provides you with the maximum amount of diagnostic feedback if your system encounters errors. *Do not* use the FC 2830: POWER GXT130P (Type 1-T) in I/O drawers 3 or 4.
3. When using a non-Ultra2/LVD SCSI adapter, use a maximum of 40 storage adapters per system and 10 storage adapters per I/O drawer. See “Performance Limits” on page 26 for more performance-related system information.
4. Contact your marketing representative for information about this adapter. For performance-related information, see “Performance Limits” on page 26.
5. See “Performance Limits” on page 26 for more performance-related system information.
6. For optimum system performance, the FC 2968: 10/100 Mbps Ethernet Tx PCI (Type 9-P) adapter is recommended instead of this adapter.
7. For optimum system performance, this model supports any combination of the following adapters, but the maximum combination varies according to your system. See “Performance Limits” on page 26 for more information.
 - 155 TURBOWAYS ATM PCI MMF, when used in LAN emulation (LANE) mode
 - 155 TURBOWAYS ATM PCI UTP, when used in LAN emulation (LANE) mode
 - 10/100 Mbps Ethernet PCI, when used in 100 Mbps mode
8. See “Performance Limits” on page 26 for performance-related information. Because only three adapters are recommended per bus, limit placement to 11 adapters per drawer for optimum performance.
9. For optimum system performance, install a maximum of two FC 6205: PCI Dual Channel Ultra2 SCSI (Type 4-R) and/or FC 6203: Dual-Channel Ultra3 SCSI (Type 4-Y) adapters per bus, 7 per drawer and 26 per system.
10. Do not install the following adapters in the slot to the right (looking from the rear) of the FC 2751: S/390 ESCON Channel (Type 5-5) adapter:
 - FC 2988: TURBOWAYS 155 PCI MMF ATM (Type 9-F)
 - FC 2968: 10/100 Mbps Ethernet Tx PCI (Type 9-P)

- FC 4962: Ethernet/LAN Encryption 10/100BaseT
11. Do not install an FC 6205: PCI Dual Channel Ultra2 SCSI (Type 4-R) or FC 6203: Dual-Channel Ultra3 SCSI (Type 4-Y) adapter in the same PCI bus as a POWER GXT 130P.
 12. Install a maximum of three adapters per primary I/O drawer and four adapters per secondary I/O drawer in this system.
 13. If there is more than one FC 6310: IBM ARTIC960 RxD Quad Digital Trunk PCI (Type 6-E), there must be a second I/O Drawer, and the adapter must be placed in slots 1-4 (1-8 with an 8 drop cable) of that drawer.
 14. Because of the local bus cable, FC 6310: IBM ARTIC960 RxD Quad Digital Trunk PCI (Type 6-E) must be within range of a cable that can reach four adjacent slots.
 15. If there are insufficient FC 6206: Single-Ended Ultra SCSI Adapter (Type 4-K) adapters to connect all the internal Media/DASD, then any FC 6206 adapters should be used first for media.
 16. If there is no other single-ended SCSI adapters other than FC 6205: PCI Dual Channel Ultra2 SCSI (Type 4-R), it is assumed the customer intent is to use FC 6205 to save slots on the internal Media/DASD. FC 6205 plugs into slot 13 when used for this purpose, but this practice is no longer recommended. The rules for 7/drawer and 26/system for FC 6205 are not altered by this use.
 17. This placement is for connectivity, and not all adapters will run at rated throughput. In certain applications, it is advantageous to have one LAN adapter per processor. This placement supports a 24-way with this configuration.
 18. For optimum system performance, do not use more than 2 of the 4 ports on the FC 4961: 10/100 4-Port Ethernet (Type A-E). Limit adapter placement to two per I/O drawer on separate PCI buses, and a total of 8 per system.

Performance Limits

This section contains system maximum suggestions for certain adapters. Apply these suggestions for optimum system performance and use the table above for specific slot-plugging guidelines. For more performance-related information, see “System Performance” on page 1.

The quantity of installed processors affects the performance of installed adapters. The table below provides some guidelines that compare performance characteristics of certain adapters. These performance characteristics vary according to the number of installed processors in a system.

The following table provides adapter maximum information for running up to 24 processors (24-way) in the pSeries 680 Model S85 system.

Table 4. pSeries 680 Model S85 Performance Limits

Adapter	S85 Max 12 Way 600 mhz	S85 Max 24 Way 600 mhz
FC 2969: Gigabit Ethernet Fibre, 1000BaseT		
MTU 1500	6	8
MTU 9000 (Jumbo)	7	8
See note 3 on page 27	(see note 1 on page 27)	(see note 1 on page 27)
FC 2975: Gigabit Ethernet (UTP) 1000BaseT		
MTU 1500	6	8
MTU 9000 (Jumbo)	7	8
See note 3 on page 27	(see note 1 on page 27)	(see note 1 on page 27)
FC 2968: 10/100 Mbps Ethernet Tx PCI (Type 9-P)		
10 Mbs FDX	26	26
100 Mbs FDX	15	22
See note 3 on page 27		
TURBOWAYS 155 PCI MMF/UTP ATM		
MTU 1500	15	18
MTU 9180	22	26
See note 3 on page 27.		
FDDI SK-NET	20	26
See notes 2 on page 27 and 3 on page 27		
FC 2946: PCI TURBOWAYS 622 PCI MMF ATM (Type A-B)		
MTU 1500	8	16

Table 4. pSeries 680 Model S85 Performance Limits (continued)

Adapter	S85 Max 12 Way 600 mhz	S85 Max 24 Way 600 mhz
MTU 9180	4	8 See note4

Notes:

1. For maximum performance, install only two FC 2969: Gigabit Ethernet Fibre, 1000BaseT or two FC 2975: Gigabit Ethernet (UTP) 1000BaseT adapters (or one of each) per I/O drawer, 1 per bus.
2. This includes the following adapters:
 - FC 2743: SysKonnnect SK-NET FDDI-UP SAS PCI (Type *)
 - FC 2742: SysKonnnect SK-NET FDDI-LP DAS PCI (Type *)
 - FC 2741: SysKonnnect SK-NET FDDI-LP SAS PCI (Type *)
3. For maximum performance, limit these adapters to 8 per drawer, 2 per bus.
4. For optimum performance, limit FC 2946: PCI TURBOWAYS 622 PCI MMF ATM (Type A-B) to 4 per I/O drawer, one per PCI bus.

pSeries 680 Model S85 Configuration Details

- The recommended location for the boot device (SCSI or Network) and graphics adapter is within the primary I/O drawer (Drawer 0). This configuration provides service personnel with the maximum amount of diagnostic information if your system encounters errors in the boot sequence.
- Consider placing the AIX rootvg volume group in the primary I/O drawer. This allows AIX to boot if other I/O drawers are found offline during boot.
- The default Boot Drive is in the lowest location in the center bay six-pack of the primary SCSI I/O drawer. Manufacturing installs the SCSI boot adapter in **slot 9**. If a boot source other than the internal SCSI disk is configured, the supporting SCSI adapter must also be in the primary I/O drawer.
- SCSI-2 disk bays in an I/O drawer are connected and driven by a single SCSI adapter, installed in **slot 9** or **slot 13**. Ultra SCSI disk bays can each be driven from separate Ultra SCSI adapters. In this configuration, slot 13 drives the default boot device and slot 6 drives the second Ultra SCSI disk bay. These adapters are optional on secondary I/O drawers.
- SCSI-2 Media bays in an I/O drawer are connected and driven by a single SCSI adapter, installed in **slot 2**. Ultra systems have the media bay driven from Slot 7. This adapter is optional on secondary I/O drawers.
- The Service Processor must occupy **slot 8** of the primary I/O drawer.
- The FC 2493: PCI SCSI-2 Fast/Wide RAID (Type 4-H) adapter installed in the primary SCSI I/O drawer can only be connected to external devices. The SCSI RAID Adapter installed in secondary I/O drawers can be connected to internal disk bays.
- When possible, place the FC 6230: Advanced SerialRAID Plus (Type 4-P) and the FC 2493: PCI SCSI-2 Fast/Wide RAID (Type 4-H) on their own buses.

- Maximum limitations exist on adapters and devices that are specific to the adapter or device and are not interaction limits with others. This information can be found in the product sales manual.
- I/O slot 9 does not support any long PCI adapter with backside components.

Chapter 4. 7024 Models E20 and E30

Customers can install adapters on this system. Use this guide to determine specific adapter slot requirements.

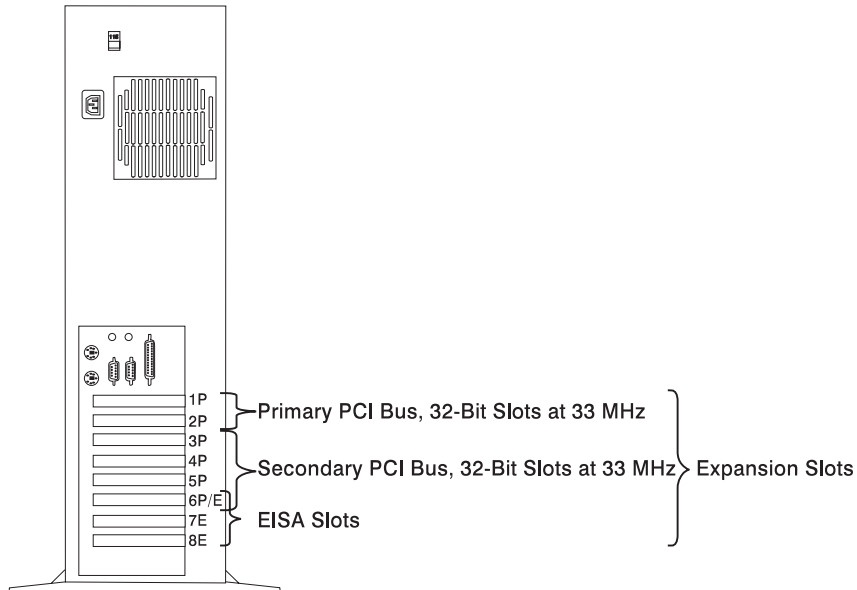

System Unit Rear View with Numbered Slots

You must place some adapters in specific system unit slots for them to function correctly and to achieve optimum performance. Use the table under “7024 Models E20 and E30 Adapter Placement Guide” on page 30 to determine where to install an adapter in your 7024 Model E20 or E30.

Many of the following notes refer to optimizing system performance. Read “System Performance” on page 1 for more performance-related information.

If you are running AIX on your system unit, the 7024 Models E20 and E30 support configurations with 0, 1, or 2 graphics adapters for FC 2839: POWER GXT110P (Type *) , FC 2851: POWER GXT250P (Type 1-M), or FC 2657: S15 Graphics Adapter (Type *). Windows NT (PowerPC Edition) only supports configurations with one graphics adapter.

Use the rear-view diagram above to identify slot locations described in the following table.

7024 Models E20 and E30 Adapter Placement Guide

Table 5. 7024 Models E20 and E30

Adapter	AIX	Windows NT
FC 2986: 10/100 Mbps PCI Fast Etherlink XL (Type *)	Slots 3P - 6P See the notes following this table.	
FC 2839: POWER GXT110P (Type *)	Slots 1P - 2P See the notes following this table.	Slots 1P - 2P
FC 2851: POWER GXT250P (Type 1-M)	Slots 1P - 5P, 6P/E See the notes following this table. Max. 4 per system	Slots 1P - 5P, 6P/E
FC 6215: PCI SSA Multi-Initiator/RAID EL (Type 4-N)	Slots 3P - 5P, 6P/E Max. 3 per system. See the notes following this table.	
FC 2657: S15 Graphics Adapter (Type *)	Slots 1P - 5P, 6P/E See the notes following this table.	Slots 1P - 5P, 6P/E
FC 6218: PCI SSA 4-Port RAID (Type 4-J)	Slots 3P - 5P, 6P/E Max. 3 per system. See the notes following this table.	
FC 2988: TURBOWAYS 155 PCI MMF ATM (Type 9-F)	See the notes following this table.	
FC 2963: TURBOWAYS 155 PCI UTP ATM (Type 9-J)	See the notes following this table.	
FC 2968: 10/100 Mbps Ethernet Tx PCI (Type 9-P)	See the notes following this table.	
FC 2493: PCI SCSI-2 Fast/Wide RAID (Type 4-H)	See the notes following this table.	
FC 2742: SysKonnnect SK-NET FDDI-LP DAS PCI (Type *)	See the notes following this table.	
FC 2741: SysKonnnect SK-NET FDDI-LP SAS PCI (Type *)	See the notes following this table.	
FC 2743: SysKonnnect SK-NET FDDI-UP SAS PCI (Type *)	See the notes following this table.	

Notes:

1. AIX supports any combination of two FC 2839: POWER GXT110P (Type *) , FC 2851: POWER GXT250P (Type 1-M), or FC 2657: S15 Graphics Adapter (Type *) on the 7024 Models E20 and E30. Follow the same slot guidelines outlined for single installations.
2. **Connectivity Notes:** For connectivity purposes, the 7024 Model E20 or E30 supports any combination of the following adapters, but that *combination* cannot exceed a total of four:
 - FC 2988: TURBOWAYS 155 PCI MMF ATM (Type 9-F)
 - FC 2963: TURBOWAYS 155 PCI UTP ATM (Type 9-J)
 - FC 2986: 10/100 Mbps PCI Fast Etherlink XL (Type *)
 - FC 2968: 10/100 Mbps Ethernet Tx PCI (Type 9-P)
 - FC 2493: PCI SCSI-2 Fast/Wide RAID (Type 4-H)
 - FC 2742: SysKonnnect SK-NET FDDI-LP DAS PCI (Type *)
 - FC 2741: SysKonnnect SK-NET FDDI-LP SAS PCI (Type *)
 - FC 2743: SysKonnnect SK-NET FDDI-UP SAS PCI (Type *)

Performance Notes: For optimum performance, follow the guidelines below.

Install a maximum of one of the following adapters in a Primary PCI slot of a 7024 Model E20 or E30:

- FC 2988: TURBOWAYS 155 PCI MMF ATM (Type 9-F)
- FC 2963: TURBOWAYS 155 PCI UTP ATM (Type 9-J)

Install a maximum of one of the following adapters in any PCI slot of a 7024 Model E20 or E30:

- FC 2986: 10/100 Mbps PCI Fast Etherlink XL (Type *)
- FC 2968: 10/100 Mbps Ethernet Tx PCI (Type 9-P)
- FC 2742: SysKonnnect SK-NET FDDI-LP DAS PCI (Type *)
- FC 2741: SysKonnnect SK-NET FDDI-LP SAS PCI (Type *)
- FC 2743: SysKonnnect SK-NET FDDI-UP SAS PCI (Type *)

3. The 7024 Model E20 or E30 supports a maximum of three FC 6218: PCI SSA 4-Port RAID (Type 4-J) or three FC 6215: PCI SSA Multi-Initiator/RAID EL (Type 4-N) adapters. If you choose to install both of these adapters in your 7024 Model E20 or E30, the combined total for both adapters must not exceed three.

Chapter 5. 7025 Model 6F0 and 7025 Model 6F1

This system is designed for service representatives to install adapters. Use this guide to determine if there are specific slot requirements for adapters that your service representative may be installing.

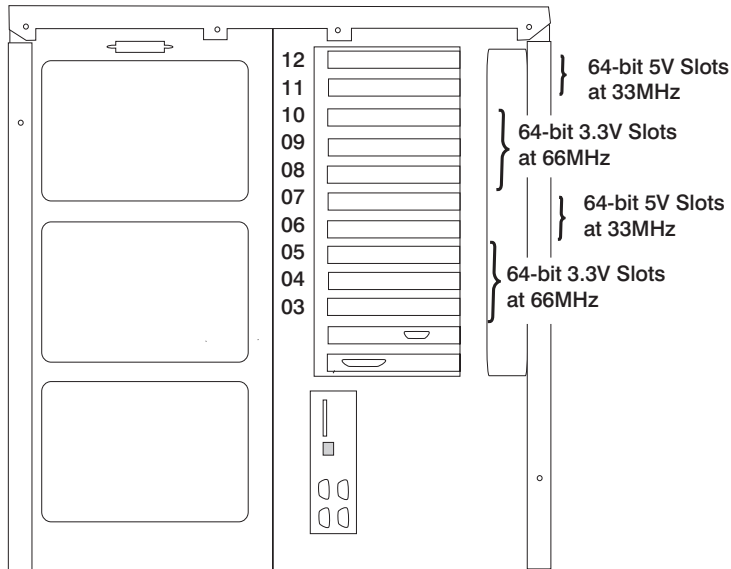

System Unit Rear View with Numbered Slots

The 7025 Model 6F0 or 7025 Model 6F1 can accommodate up to 10 feature adapters based on the PCI bus. All slots are 64 bit with slots 6, 7, 11 and 12 supplying +5v and running at 33Mhz. The remaining slots are 3.3v slots capable of running at 66 Mhz. The slots are numbered 3-12 (C03-C12) starting from the bottom of the machine.

Adapter cards that require +5v supply to operate must be plugged into slots 6, 7, 11 or 12. Adapter cards requiring +3.3v supply must be plugged into slots 3, 4, 5, 8, 9, or 10. Adapter cards that are universal (that is, they run on either voltage) can be plugged into any of the 10 slots.

Some adapters must be placed in specific system unit slots to function correctly at optimum performance. Use the table under "7025 Model 6F0 and 7025 Model 6F1" on page 34 to determine where to install these adapters in your 7025 Model 6F0 or 7025 Model 6F1.

Many of the following notes refer to optimizing system performance. Read "System Performance" on page 1 for more performance-related information.

Use the rear-view diagram above to identify slot locations described in the following tables.

7025 Model 6F0 and 7025 Model 6F1

Use the following table to identify adapter slot location options for the following adapters in your 7025 Model 6F0 or 7025 Model 6F1.

Table 6. 7025 Model 6F0 and 7025 Model 6F1

Adapter	Slot Usage	System Maximum	Hot-Pluggable?
FC 2830: POWER GXT130P (Type 1-T)	6, 11, 7, 12	1	N
FC 2848: GXT135P Graphics Adapter (Type 1-X)	9, 8, 3, 4, 10, 5, 6, 11, 7, 12	1	N
FC 2969: Gigabit Ethernet Fibre, 1000BaseT	9, 8, 3, 4, 10, 5, 6, 11, 7, 12	6 (see notes 5 on page 37 and 9 on page 37)	Y
FC 2975: Gigabit Ethernet (UTP) 1000BaseT	9, 8, 3, 4, 10, 5, 6, 11, 7, 12	6 (see notes 5 on page 37 and 9 on page 37)	Y
FC 6310: IBM ARTIC960 RxD Quad Digital Trunk PCI (Type 6-E)	9, 8, 3, 4, 10, 5, 6, 11, 7, 12 (see note 4 on page 37)	4	See note 1 on page 37
FC 2498: PCI 4-Channel Ultra3 SCSI RAID (Type 4-X)	9, 8, 3, 4, 10, 5, 6, 11, 7, 12	6	Y
FC 2708: ISDN Basic Rate PCI (Type 9-N)	6, 11, 7, 12	1	Y
FC 6227: Gigabit Fibre Channel PCI (Type 4-S)	9, 8, 3, 4, 10, 5, 6, 11, 7, 12	6	Y
FC 6228: Gigabit Fibre Channel Adapter, 32 or 64-bit PCI Bus (Type 4-W)	9, 8, 3, 4, 10, 5, 6, 11, 7, 12	6	Y
FC 6230: Advanced SerialRAID Plus (Type 4-P) FC 6235: Fast Write Cache Option for FC 6230 FC 6230+6231: 4 Port SSA 40 w/128MB DIMM	9, 8, 3, 4, 10, 5, 6, 11, 7, 12 (see notes 3 on page 37 and 2 on page 37)	6	Y

Table 6. 7025 Model 6F0 and 7025 Model 6F1 (continued)

Adapter	Slot Usage	System Maximum	Hot-Pluggable?
FC 2947: IBM ARTIC960Hx 4-Port Selectable PCI (Type 9-R)	9, 8, 3, 4, 10, 5, 6, 11, 7, 12	4	N
FC 2943: 8-Port Asynchronous EIA-232E/RS-422A PCI (Type 3-B)	9, 8, 3, 4, 10, 5, 6, 11, 7, 12	10	Y
FC 2944: 128-Port Async Controller PCI (Type 3-C)	9, 8, 3, 4, 10, 5, 6, 11, 7, 12	10	Y
FC 4961: 10/100 4-Port Ethernet (Type A-E)	9, 8, 3, 4, 10, 5, 6, 11, 7, 12	6 (see notes 8 on page 37 and 9 on page 37)	Y
FC 2962: 2-Port Multiprotocol PCI (Types 9-L and 9-V)	6, 11, 7, 12	4	N
FC 2963: TURBOWAYS 155 PCI UTP ATM (Type 9-J)	9, 8, 3, 4, 10, 5, 6, 11, 7, 12	4 (see note 9 on page 37)	Y
FC 4953: 64-bit/66MHz PCI ATM 155 UTP (Type A-C)	9, 8, 3, 4, 10, 5, 6, 11, 7, 12	4 (see note 9 on page 37)	Y
FC 2988: TURBOWAYS 155 PCI MMF ATM (Type 9-F)	9, 8, 3, 4, 10, 5, 6, 11, 7, 12	4 (see note 9 on page 37)	Y
FC 4957: 64-bit/66MHz PCI ATM 155 MMF (Type A-D)	9, 8, 3, 4, 10, 5, 6, 11, 7, 12	4 (see note 9 on page 37)	Y
FC 2946: PCI TURBOWAYS 622 PCI MMF ATM (Type A-B)	9, 8, 3, 4, 10, 5, 6, 11, 7, 12	4 (see note 11 on page 38)	Y
FC 2742: SysKonnnect SK-NET FDDI-LP DAS PCI (Type *)	9, 8, 3, 4, 10, 5, 6, 11, 7, 12	4 (see notes 6 on page 37 and 9 on page 37)	Y

Table 6. 7025 Model 6F0 and 7025 Model 6F1 (continued)

Adapter	Slot Usage	System Maximum	Hot-Pluggable?
FC 2741: SysKonnnect SK-NET FDDI-LP SAS PCI (Type *)	9, 8, 3, 4, 10, 5, 6, 11, 7, 12	4 (see notes 6 on page 37 and 9 on page 37)	Y
FC 2743: SysKonnnect SK-NET FDDI-UP SAS PCI (Type *)	9, 8, 3, 4, 10, 5, 6, 11, 7, 12	4 (see notes 6 on page 37 and 9 on page 37)	Y
FC 2751: S/390 ESCON Channel (Type 5-5)	6, 11, 7, 12	3	N
FC 6205: PCI Dual Channel Ultra2 SCSI (Type 4-R)	9, 8, 3, 4, 10, 5, 6, 11, 7, 12	6	Y
FC 6203: Dual-Channel Ultra3 SCSI (Type 4-Y)	9, 8, 3, 4, 10, 5, 6, 11, 7, 12	6	Y
FC 4959: High-Speed Token Ring PCI (Type 9-Y)	9, 8, 3, 4, 10, 5, 6, 11, 7, 12	9	Y
FC 6206: Single-Ended Ultra SCSI Adapter (Type 4-K)	6, 11, 7, 12	4	Y
FC 6204: PCI Universal Differential Ultra SCSI (Type 4-U)	9, 8, 3, 4, 10, 5, 6, 11, 7, 12	10	Y
FC 2968: 10/100 Mbps Ethernet Tx PCI (Type 9-P)	9, 8, 3, 4, 10, 5, 6, 11, 7, 12	10 (see notes 7 on page 37 and 9 on page 37)	Y
FC 4962: Ethernet/LAN Encryption 10/100BaseT	9, 8, 3, 4, 10, 5, 6, 11, 7, 12	10 (see notes 7 on page 37 and 9 on page 37)	Y
FC 2985: Ethernet 10base2 PCI (Type 8-Y)	6, 11, 7, 12	4	Y
FC 2987: Ethernet 10base5 PCI (Type 8-Z)	6, 11, 7, 12	4	Y

Table 6. 7025 Model 6F0 and 7025 Model 6F1 (continued)

Adapter	Slot Usage	System Maximum	Hot-Pluggable?
FC 6311: IBM ARTIC960 RxF PCI (Type 6-G)	9, 8, 3, 4, 10, 5, 6, 11, 7, 12 (see note 4)	4	N
FC 4958: Cryptographic Coprocessor	9, 8, 3, 4, 10, 5, 6, 11, 7, 12	4 (see note 10 on page 38)	Y
FC 4962: Ethernet/LAN Encryption 10/100BaseT	9, 8, 3, 4, 10, 5, 6, 11, 7, 12	4	Y
FC 4960: IBM Cryptographic Accelerator (Type 6-J)	9, 8, 3, 4, 10, 5, 6, 11, 7, 12	4	Y

Notes:

1. This adapter is hot-pluggable if it is not cabled to another card internally.
2. FC 6231: 128 MB DIMM for FC 6230 is 128 MB memory dimm option for the FC 6225: Advanced SSA SerialRAID (Type 4-P) adapter and can only be selected along with FC 6230: Advanced SerialRAID Plus (Type 4-P) (max 1 per 6230)
3. FC 6235: Fast Write Cache Option for FC 6230 is a RAID cache upgrade for the FC 6225: Advanced SSA SerialRAID (Type 4-P) adapter and can only be selected along with FC 6230: Advanced SerialRAID Plus (Type 4-P) (max 1 per 6230).
4. If multiple FC 6310s and FC 6311s are on the order, FC 2877 (Quad DTA, H.100, 4-Drop Cable) or FC 4353 (Cable, Internal H.100 BUS, 8-Position) must be used to connect FC 6310: IBM ARTIC960 RxD Quad Digital Trunk PCI (Type 6-E) and FC 6311: IBM ARTIC960 RxF PCI (Type 6-G) .
5. For optimum system performance, a maximum of two FC 2969: Gigabit Ethernet Fibre, 1000BaseT or FC 2975: Gigabit Ethernet (UTP) 1000BaseT adapters per system is recommended.
6. For optimum system performance, a maximum of 14 FC 2741: SysKconnect SK-NET FDDI-LP SAS PCI (Type *), FC 2742: SysKconnect SK-NET FDDI-LP DAS PCI (Type *), and FC 2743: SysKconnect SK-NET FDDI-UP SAS PCI (Type *) adapters per system and a maximum of seven FC 2741, FC 2742, and FC 2743 adapters per I/O drawer is recommended.
7. For optimum system performance, a maximum of eight FC 2968: 10/100 Mbps Ethernet Tx PCI (Type 9-P) or FC 4962: Ethernet/LAN Encryption 10/100BaseT adapters per system.
8. For optimum system performance using the FC 4961: 10/100 4-Port Ethernet (Type A-E) on this system, use only 2 of the 4 ports if the ports will all be running at media speed. Use a maximum of six ports per system (that is, three adapters running 2 ports each). Limit adapters to two per I/O drawer in 64-bit slots.
9. For optimum system performance, the combination of FC 2969: Gigabit Ethernet Fibre, 1000BaseT, FC 2741: SysKconnect SK-NET FDDI-LP SAS PCI (Type *), FC 2742: SysKconnect SK-NET FDDI-LP DAS PCI (Type *), FC 2743: SysKconnect

SK-NET FDDI-UP SAS PCI (Type *), FC 2968: 10/100 Mbps Ethernet Tx PCI (Type 9-P), FC 4951: 10/100 4-Port Ethernet (Type 9-Z), FC 2963: TURBOWAYS 155 PCI UTP ATM (Type 9-J), FC 2988: TURBOWAYS 155 PCI MMF ATM (Type 9-F), FC 4953: 64-bit/66MHz PCI ATM 155 UTP (Type A-C), FC 4957: 64-bit/66MHz PCI ATM 155 MMF (Type A-D), FC 4962: Ethernet/LAN Encryption 10/100BaseT, and FC 2975: Gigabit Ethernet (UTP) 1000BaseT adapters cannot exceed 7 adapters per system.

10. A combined maximum of four FC 4958: Cryptographic Coprocessor and RPQ 8A1162: Cryptographic Coprocessor adapters are allowed per system.
11. For optimum performance using FC 2946: PCI TURBOWAYS 622 PCI MMF ATM (Type A-B), limit adapters to the following:
 - MTU 1500: 1 per drawer, 2 per system
 - MTU 9180: 2 per drawer, 3 per system

Chapter 6. 7025 Model F30

This system is designed for customers to install adapters. Use this guide to determine if there are specific slot requirements for adapters that you may be installing.

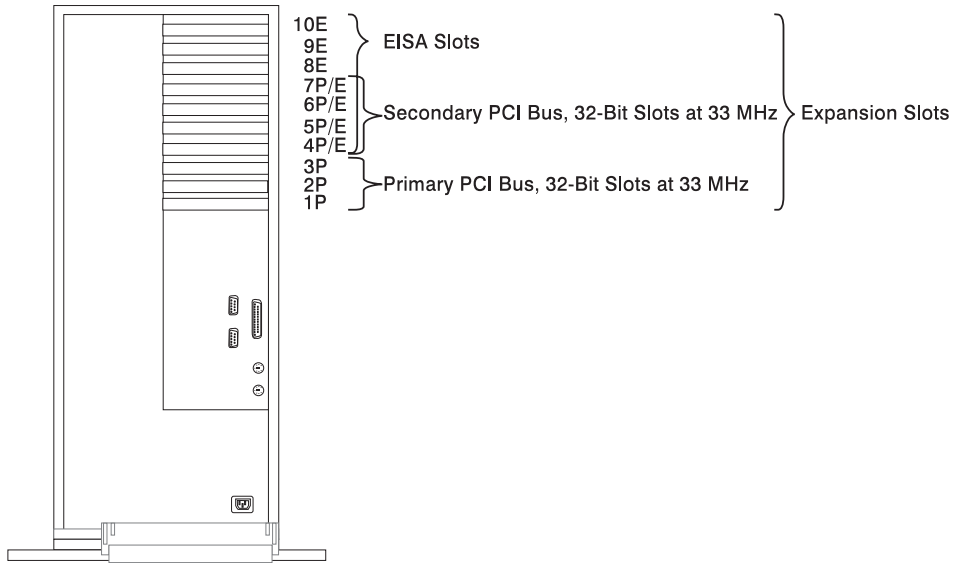

System Unit Rear View with Numbered Slots

Some adapters must be placed in specific system unit slots to function correctly and to achieve optimum performance. Use the table under “7025 Model F30 Adapter Placement Guide” on page 40 to determine where to install an adapter in your 7025 Model F30.

Many of the following notes refer to optimizing system performance. Read “System Performance” on page 1 for more performance-related information.

If you are running AIX on your system unit, the 7025 Model F30 supports configurations with 0, 1, or 2 graphics adapters for FC 2839: POWER GXT110P (Type *) and FC 2657: S15 Graphics Adapter (Type *). Systems running Windows NT (PowerPC Edition) only support configurations with one graphics adapter.

Use the rear-view diagram above to identify slot locations described in the following table.

7025 Model F30 Adapter Placement Guide

Table 7. 7025 Model F30

Adapter	AIX	Windows NT
FC 2986: 10/100 Mbps PCI Fast Etherlink XL (Type *)	Slots 4P - 7P See the notes following this table.	
FC 2839: POWER GXT110P (Type *)	Slots 1P - 3P See the notes following this table.	Slots 1P - 3P
FC 2851: POWER GXT250P (Type 1-M)	Slots 1P - 7P/E Max. 4 per system. See the notes following this table.	Slots 1P - 7P/E
FC 6215: PCI SSA Multi-Initiator/RAID EL (Type 4-N)	Slots 4P/E - 7P/E Max. 4 per system. See the notes following this table.	
FC 2657: S15 Graphics Adapter (Type *)	Slots 1P - 7P/E See the notes following this table.	Slots 1P - 7P/E
FC 6218: PCI SSA 4-Port RAID (Type 4-J)	Slots 4P/E - 7P/E Max. 3 per system. See the notes following this table.	
FC 2949: IBM ARTIC960 Hx DSP Resource PCI (Type 9-T)	Slots 7P/E - 1P If available, install first adapter in slot 7P/E. Install in descending order from 7P/E to slot 1P.	
FC 2493: PCI SCSI-2 Fast/Wide RAID (Type 4-H)	Max. 2 per system	
FC 2988: TURBOWAYS 155 PCI MMF ATM (Type 9-F)	See the notes following this table.	
FC 2963: TURBOWAYS 155 PCI UTP ATM (Type 9-J)	See the notes following this table.	
FC 2968: 10/100 Mbps Ethernet Tx PCI (Type 9-P)	See the notes following this table.	
FC 2742: SysKonnnect SK-NET FDDI-LP DAS PCI (Type *)	See the notes following this table.	

Table 7. 7025 Model F30 (continued)

Adapter	AIX	Windows NT
FC 2741: SysKonnnect SK-NET FDDI-LP SAS PCI (Type *)	See the notes following this table.	
FC 2743: SysKonnnect SK-NET FDDI-UP SAS PCI (Type *)	See the notes following this table.	

Notes:

1. If you are running AIX, any combination of two FC 2839: POWER GXT110P (Type *) , FC 2851: POWER GXT250P (Type 1-M), or FC 2657: S15 Graphics Adapter (Type *) is supported on your 7025 Model F30. Follow the same slot guidelines outlined for single installations.
2. **Connectivity Notes:** For connectivity purposes, the 7025 Model F30 supports any combination of the following adapters, but that *combination* cannot exceed a total of four:
 - FC 2988: TURBOWAYS 155 PCI MMF ATM (Type 9-F)
 - FC 2963: TURBOWAYS 155 PCI UTP ATM (Type 9-J)
 - FC 2986: 10/100 Mbps PCI Fast Etherlink XL (Type *)
 - FC 2968: 10/100 Mbps Ethernet Tx PCI (Type 9-P)
 - FC 2493: PCI SCSI-2 Fast/Wide RAID (Type 4-H)
 - FC 2742: SysKonnnect SK-NET FDDI-LP DAS PCI (Type *)
 - FC 2741: SysKonnnect SK-NET FDDI-LP SAS PCI (Type *)
 - FC 2743: SysKonnnect SK-NET FDDI-UP SAS PCI (Type *)

Performance Notes: For optimum performance, follow the guidelines below.

A maximum of one of the following adapters installed in a Primary PCI slot of a 7025 Model F30.

- FC 2988: TURBOWAYS 155 PCI MMF ATM (Type 9-F)
- FC 2963: TURBOWAYS 155 PCI UTP ATM (Type 9-J)

A maximum of one of the following adapters installed in any PCI slot of a 7025 Model F30.

- FC 2986: 10/100 Mbps PCI Fast Etherlink XL (Type *)
- FC 2968: 10/100 Mbps Ethernet Tx PCI (Type 9-P)
- FC 2742: SysKonnnect SK-NET FDDI-LP DAS PCI (Type *)
- FC 2741: SysKonnnect SK-NET FDDI-LP SAS PCI (Type *)
- FC 2743: SysKonnnect SK-NET FDDI-UP SAS PCI (Type *)

3. The 7025 Model F30 supports a maximum of three FC 6218: PCI SSA 4-Port RAID (Type 4-J) or three FC 6215: PCI SSA Multi-Initiator/RAID EL (Type 4-N) adapters. If you choose to install both of these adapters in your 7025 Model F30, the combined total for both adapters must not exceed three.

Chapter 7. 7025 Model F40

This system is designed for customers to install adapters. Use this guide to determine if there are specific slot requirements for adapters that you may be installing.

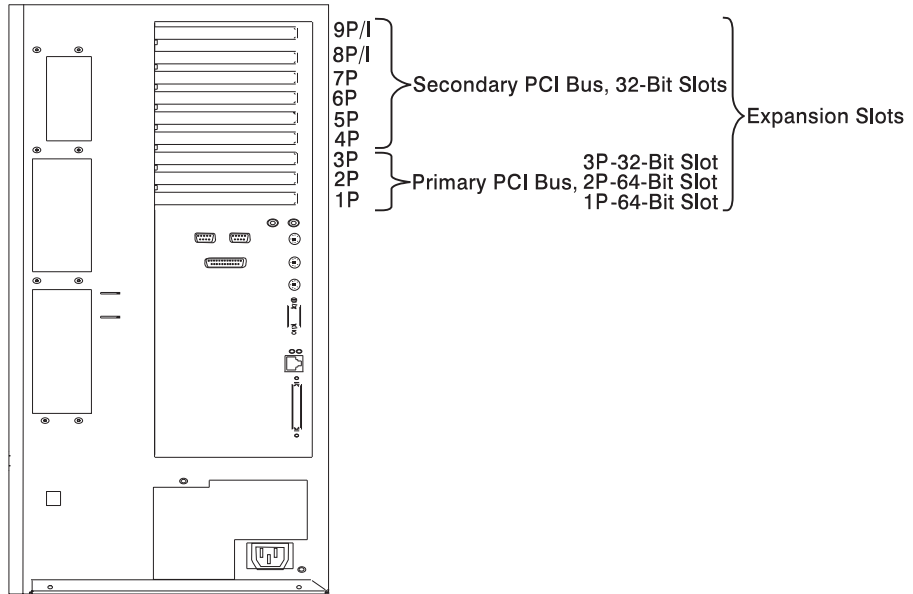

System Unit Rear View with Numbered Slots

Some adapters must be placed in specific system unit slots to function correctly at optimum performance. Use the table under “7025 Model F40 Adapter Placement Guide” on page 44 to determine where to install an adapter in your 7025 Model F40.

Many of the following notes refer to optimizing system performance. Read “System Performance” on page 1 for more performance-related information.

If you are running AIX on your system unit, refer to “7025 Model F40 Multiple Graphics Adapter Placement Guide” on page 48 to configure two or more adapters in your 7025 Model F40. Windows NT (PowerPC Edition) does not support more than one graphics adapter in a system unit.

Use the rear-view diagram above to identify slot locations described in the following tables.

7025 Model F40 Adapter Placement Guide

Use the following table to identify adapter slot location options for these adapters in your 7025 Model F40.

Table 8. 7025 Model F40.

Adapter	AIX	Windows NT
FC 2947: IBM ARTIC960Hx 4-Port Selectable PCI (Type 9-R)	Slot 3P - 9P/I (see note 7)	
FC 2948: IBM ARTIC960 4-Port T1/E1 PCI (Type 9-S)	Slot 3P - 9P/I (see note 7)	
FC 2949: IBM ARTIC960 Hx DSP Resource PCI (Type 9-T)	Slot 3P - 9P/I (see note 7)	
FC 2839: POWER GXT110P (Type *)	Slot 3P	Slot 3P
FC 2838: POWER GXT120P (Type 1-P)	Slots 1P - 9P/I (see note 9)	
FC 2830: POWER GXT130P (Type 1-T)	Slots 1P - 9P/I (see note 9)	
FC 2851: POWER GXT250P (Type 1-M) or FC 2852: POWER GXT255P (Type 1-N)	Slots 1P - 9P/I (1P - 2P Best)	Slots 1P - 9P/I
FC 2854: POWER GXT500P (Type 1-I) or FC 2855: POWER GXT550P (Type 1-J)	Slots 1P - 3P (1P - 2P Best)	
FC 2853: POWER GXT800P (Type 1-K)	Slots 2P - 3P (2P Best) See note 3	
FC 2856: POWER GXT1000 (Type 1-H)	Slots 1P - 3P	
FC 2639: Ultimedia Video Capture (Type 7-9)	Slots 1P - 9P/I Max. 1 per system, see notes 4 and 10	
FC 6309: Digital Trunk Quad PCI (Type 6-B)	Max. 3 per system in any slot (see note 7)	
FC 6205: PCI Dual Channel Ultra2 SCSI (Type 4-R)	Any slot Max. 9 per system, see notes 2 and 9	

Table 8. 7025 Model F40. (continued)

Adapter	AIX	Windows NT
FC 6215: PCI SSA Multi-Initiator/RAID EL (Type 4-N)	Max. of 1 in slot 1P or 2P Max. of 1 in slot 3P Max. of 1 in slot 4P, or 5P, or 6P, or 7P, 8P/I, or 9P/I Max. 3 Per Machine, see note 6	
FC 6225: Advanced SSA SerialRAID (Type 4-P)	Max. of 1 in slot 1P or 2P Max. of 1 in slot 3P Max. of 1 in slot 4P, or 5P, or 6P, or 7P, 8P/I, or 9P/I Max. 3 Per Machine, see note 6	
FC 6230: Advanced SerialRAID Plus (Type 4-P)	Max. of 1 in slot 1P or 2P Max. of 1 in slot 3P Max. of 1 in slot 4P, or 5P, or 6P, or 7P, 8P/I, or 9P/I Max. 3 Per Machine, see note 6	
FC 4959: High-Speed Token Ring PCI (Type 9-Y)	Any slot	
FC 2493: PCI SCSI-2 Fast/Wide RAID (Type 4-H)	Any slot Max. 2 per system, see note 5	
FC 2494: PCI 3-Channel Ultra2 SCSI RAID (Type 4-T)	Any slot Max. 2 per system, see note 10	
FC 2988: TURBOWAYS 155 PCI MMF ATM (Type 9-F)	See notes 5 and 8	
FC 2963: TURBOWAYS 155 PCI UTP ATM (Type 9-J)	See note 5	
FC 2986: 10/100 Mbps PCI Fast Etherlink XL (Type *)	See note 5	
FC 2968: 10/100 Mbps Ethernet Tx PCI (Type 9-P)	See notes 5 and 8	
FC 2742: SysKonnnect SK-NET FDDI-LP DAS PCI (Type *)	See note 5	
FC 2741: SysKonnnect SK-NET FDDI-LP SAS PCI (Type *)	See note 5	
FC 2743: SysKonnnect SK-NET FDDI-UP SAS PCI (Type *)	See note 5	

Table 8. 7025 Model F40. (continued)

Adapter	AIX	Windows NT
FC 2751: S/390 ESCON Channel (Type 5-5)	See notes 7 and 8	

Notes:

1. "Best" means optimum performance achieved if installed in this slot.
2. For optimum system performance, install a maximum of 3 FC 6205: PCI Dual Channel Ultra2 SCSI (Type 4-R) adapters. Place them in slots 1P, 2P, and 3P.
3. The FC 2853: POWER GXT800P (Type 1-K) takes the physical space of up to four adapters in the 7025 Model F40.
4. Only one FC 2639: Ultimedia Video Capture (Type 7-9) adapter is supported per machine.
5. The 7025 Model F40 supports any combination of the following adapters, but that *combination* cannot exceed a total of four. For optimum performance, a maximum of one of any of the following adapters installed in a primary PCI bus slot is recommended: (This restriction does not apply if the FC 2968: 10/100 Mbps Ethernet Tx PCI (Type 9-P) adapter is used in 10 Mbps mode.)
 - FC 2988: TURBOWAYS 155 PCI MMF ATM (Type 9-F)
 - FC 2963: TURBOWAYS 155 PCI UTP ATM (Type 9-J)
 - FC 2986: 10/100 Mbps PCI Fast Etherlink XL (Type *)
 - FC 2968: 10/100 Mbps Ethernet Tx PCI (Type 9-P)
 - FC 2493: PCI SCSI-2 Fast/Wide RAID (Type 4-H)
 - FC 2742: SysKonnnect SK-NET FDDI-LP DAS PCI (Type *)
 - FC 2741: SysKonnnect SK-NET FDDI-LP SAS PCI (Type *)
 - FC 2743: SysKonnnect SK-NET FDDI-UP SAS PCI (Type *)
6. The 7025 Model F40 supports any combination of the following adapters, but that *combination* cannot exceed a total of three:
 - FC 6218: PCI SSA 4-Port RAID (Type 4-J)
 - FC 6215: PCI SSA Multi-Initiator/RAID EL (Type 4-N)
 - FC 6225: Advanced SSA SerialRAID (Type 4-P)
 - FC 6230: Advanced SerialRAID Plus (Type 4-P)
7. The 7025 Model F40 supports any combination of the following adapters, but that *combination* cannot exceed a total of seven:
 - FC 2947: IBM ARTIC960Hx 4-Port Selectable PCI (Type 9-R)
 - FC 2948: IBM ARTIC960 4-Port T1/E1 PCI (Type 9-S)
 - FC 2949: IBM ARTIC960 Hx DSP Resource PCI (Type 9-T)
 - FC 2751: S/390 ESCON Channel (Type 5-5)
 - FC 6309: Digital Trunk Quad PCI (Type 6-B)
8. Do not install an FC 2988: TURBOWAYS 155 PCI MMF ATM (Type 9-F) or FC 2968: 10/100 Mbps Ethernet Tx PCI (Type 9-P) adapter in the slot to the right (looking from the rear) of the FC 2751: S/390 ESCON Channel (Type 5-5) adapter.
9. Do not install an FC 6205: PCI Dual Channel Ultra2 SCSI (Type 4-R) adapter in the same PCI bus as a FC 2838: POWER GXT120P (Type 1-P) or a FC 2830: POWER GXT130P (Type 1-T)

10. Do not install an FC 2494: PCI 3-Channel Ultra2 SCSI RAID (Type 4-T) and a FC 2639: Ultimedia Video Capture (Type 7-9) adapter on the same PCI bus.

7025 Model F40 Multiple Graphics Adapter Placement Guide

Use the following table to identify slot location combination options for the following adapters in your 7025 Model F40.

Do not install more than four graphics adapters in your 7025 Model F40.

Table 9. 7025 Model F40

Adapter	Slot
FC 2839: POWER GXT110P (Type *) with a	Slot 3P
FC 2838: POWER GXT120P (Type 1-P) or FC 2830: POWER GXT130P (Type 1-T) or FC 2851: POWER GXT250P (Type 1-M) or FC 2852: POWER GXT255P (Type 1-N)	Slot 1P - 2P
FC 2839: POWER GXT110P (Type *) with a	Slot 3P
FC 2854: POWER GXT500P (Type 1-I) or FC 2855: POWER GXT550P (Type 1-J)	Slot 1P - 2P
FC 2839: POWER GXT110P (Type *) with a	Slot 3P
FC 2853: POWER GXT800P (Type 1-K)	Slot 2P
FC 2839: POWER GXT110P (Type *) with a	Slot 3P
FC 2856: POWER GXT1000 (Type 1-H)	Any slot
FC 2838: POWER GXT120P (Type 1-P) or FC 2830: POWER GXT130P (Type 1-T) or FC 2851: POWER GXT250P (Type 1-M) or FC 2852: POWER GXT255P (Type 1-N) with a	Any slot
FC 2838: POWER GXT120P (Type 1-P) or FC 2830: POWER GXT130P (Type 1-T) or FC 2851: POWER GXT250P (Type 1-M) or FC 2852: POWER GXT255P (Type 1-N)	Any slot (1P - 2P Best)
FC 2838: POWER GXT120P (Type 1-P) or FC 2830: POWER GXT130P (Type 1-T) or FC 2851: POWER GXT250P (Type 1-M) or FC 2852: POWER GXT255P (Type 1-N) with a	Any slot (1P - 2P Best)
FC 2854: POWER GXT500P (Type 1-I) or FC 2855: POWER GXT550P (Type 1-J)	Slots 1P - 3P (1P - 2P Best)

Table 10. 7025 Model F40

Adapter	Slot
FC 2838: POWER GXT120P (Type 1-P) or FC 2830: POWER GXT130P (Type 1-T) or FC 2851: POWER GXT250P (Type 1-M) or FC 2852: POWER GXT255P (Type 1-N) with a FC 2853: POWER GXT800P (Type 1-K)	Slots 3P - 9P/I Slot 4P - 9P/I <p style="text-align: center;">OR</p> Slot 2P only (Best) Slot 3P only
FC 2838: POWER GXT120P (Type 1-P) or FC 2830: POWER GXT130P (Type 1-T) or FC 2851: POWER GXT250P (Type 1-M) or FC 2852: POWER GXT255P (Type 1-N) with a FC 2856: POWER GXT1000 (Type 1-H)	Any slot (1P - 2P Best) Any slot

Notes:

1. "Best" means optimum performance achieved if installed in this slot.
2. Up to four FC 2851: POWER GXT250P (Type 1-M) adapters or FC 2852: POWER GXT255P (Type 1-N) adapters are supported in any combination.

Chapter 8. 7025 Model F50

This system is designed for customers to install adapters. Use this guide to determine if there are specific slot requirements for adapters that you may be installing.

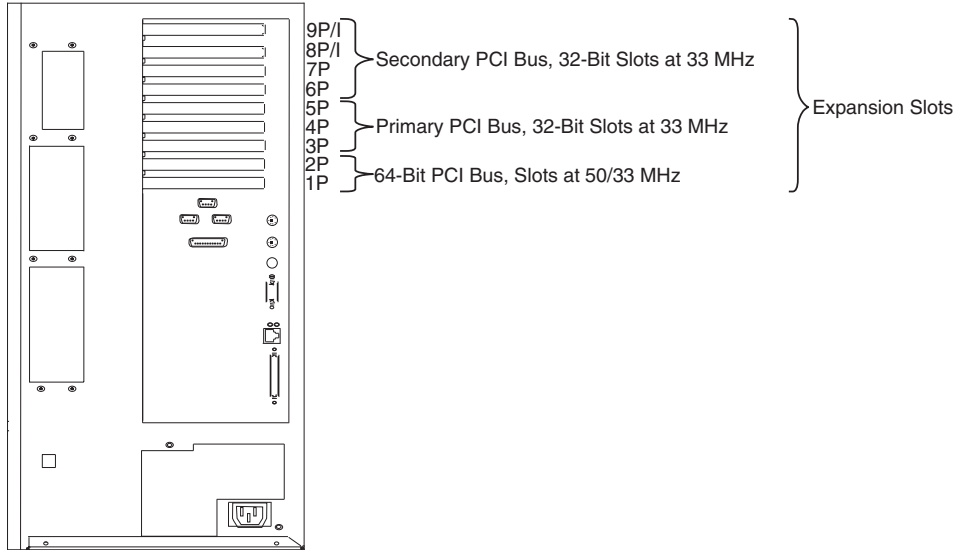

System Unit Rear View with Numbered Slots

Note: The 7025 Model F50 has three PCI buses, with Slots 1 - 2 on one bus, Slots 3 - 5 on a bus, and Slots 6 - 9 on a bus.

Some adapters must be placed in specific system unit slots to function correctly at optimum performance. Use the table under “7025 Model F50 Adapter Placement Guide” on page 52 to determine where to install these adapters in your 7025 Model F50.

Many of the following notes refer to optimizing system performance. Read “System Performance” on page 1 for more performance-related information.

Use the rear-view diagram above to identify slot locations described in the following table.

7025 Model F50 Adapter Placement Guide

Use the following table to identify adapter slot locations for these adapters in your 7025 Model F50.

Table 11. 7025 Model F50

Adapter	Usage
FC 2853: POWER GXT800P (Type 1-K)	Slot 3P Max. 1 per system, see note 1 Slots 1P, 2P, and 4P cannot be used when a FC 2853: POWER GXT800P (Type 1-K) is installed in slot 3P.
FC 2859: GXT800P 3-slot Graphics (Type 1-K)	Slot 3P Max. 1 per system Slots 1P, 2P, and 4P cannot be used when FC 2859: GXT800P 3-slot Graphics (Type 1-K) is installed in slot 3P. Only one FC 2859: GXT800P 3-slot Graphics (Type 1-K) graphics adapter is supported per system.
FC 2839: POWER GXT110P (Type *)	Slot 3P, 4P, or 5P Max. 2 per system, see note 1
FC 6228: Gigabit Fibre Channel Adapter, 32 or 64-bit PCI Bus (Type 4-W)	Max. 3 per system
FC 6227: Gigabit Fibre Channel PCI (Type 4-S)	Max. 3 per system, 1 per bus
FC 6230: Advanced SerialRAID Plus (Type 4-P)	Max. 4 per system, 2 per bus see notes 5 on page 57 and 7 on page 57
FC 6230+6231: 4 Port SSA 40 w/128MB DIMM	Max 4 per system
FC 6225: Advanced SSA SerialRAID (Type 4-P)	Max. 4 per system, 2 per bus see notes 5 on page 57 and 7 on page 57
FC 6235: Fast Write Cache Option for FC 6230	Plugs into FC 6225 or FC 6230
FC 6215: PCI SSA Multi-Initiator/RAID EL (Type 4-N)	Max. 4 per system, 2 per bus see notes 5 on page 57 and 7 on page 57
FC 6222: 4-Port, SSA-RAID1 Fast Write Cache Option (Type 4-N)	Plugs into Campbell adapter (FC 6215)

Table 11. 7025 Model F50 (continued)

Adapter	Usage
FC 2751: S/390 ESCON Channel (Type 5-5)	<p>see "Chapter 29. Digital Trunk PCI Adapter Placement Considerations" on page 185 If less than 2GB of system memory is installed, a maximum of 3 adapters combined total per system.</p> <p>Max. of 3 in slots 1P, 2P, 3P, 4P, or 5P</p> <p>Max. of 2 in slots 6P, 7P, 8P/I, or 9P/I.</p> <p>If more than 2GB of system memory is installed, a maximum of 3 adapters combined total per system:</p> <p>Max. of 1 in slots 1P or 2P</p> <p>Max. of 2 in slots 3P, 4P, or 5P</p> <p>Max. of 1 in slots 6P, 7P, 8P/I, or 9P/I</p> <p>See notes 3, 4, and 10</p>
FC 2830: POWER GXT130P (Type 1-T)	<p>Any slot</p> <p>Max. 2 per system, see notes 1 and 11</p>
FC 2838: POWER GXT120P (Type 1-P)	<p>Any slot</p> <p>Max. 2 per system, see notes 1 and 11</p>
FC 6309: Digital Trunk Quad PCI (Type 6-B)	<p>see "Chapter 29. Digital Trunk PCI Adapter Placement Considerations" on page 185 If less than 2GB of system memory is installed, a maximum of 3 adapters combined total per system.</p> <p>Max. of 3 in slots 1P, 2P, 3P, 4P, or 5P</p> <p>Max. of 2 in slots 6P, 7P, 8P/I, or 9P/I.</p> <p>If more than 2GB of system memory is installed, a maximum of 3 adapters combined total per system:</p> <p>Max. of 1 in slots 1P or 2P</p> <p>Max. of 2 in slots 3P, 4P, or 5P</p> <p>Max. of 1 in slots 6P, 7P, 8P/I, or 9P/I</p> <p>See notes 3, 4, and 10</p>
FC 6310: IBM ARTIC960 RxD Quad Digital Trunk PCI (Type 6-E)	<p>Any slot</p> <p>Max. 4 per system</p> <p>see "Chapter 29. Digital Trunk PCI Adapter Placement Considerations" on page 185 and note 12 on page 57</p>

Table 11. 7025 Model F50 (continued)

Adapter	Usage
FC 6311: IBM ARTIC960 RxF PCI (Type 6-G)	Any slot see "Chapter 29. Digital Trunk PCI Adapter Placement Considerations" on page 185 and note 12 on page 57
FC 2969: Gigabit Ethernet Fibre, 1000BaseT	- Max. of 1 in slots 1P, 2P, 3P, 4P, or 5P - Max. of 1 in slots 6P, 7P, 8P/I, or 9P/I. (see notes 5 on page 57, 6 on page 57 and 13 on page 57)
FC 2975: Gigabit Ethernet (UTP) 1000BaseT	Max. of 1 in slots 1P, 2P, 3P, 4P, or 5P Max. of 1 in slots 6P, 7P, 8P/I, or 9P/I (see notes 5 and 13)
FC 2732, 2733: Serial HIPPI PCI (Types 9-W and 9-X)	Max. 1 per bus, 2 per system see note 5
FC 2494: PCI 3-Channel Ultra2 SCSI RAID (Type 4-T)	Any slot Max. 3 per system, see notes 5 and 9
FC 2498: PCI 4-Channel Ultra3 SCSI RAID (Type 4-X)	Any slot (Max. 3, see note 5 on page 57)
FC 4951: 10/100 4-Port Ethernet (Type 9-Z)	Max 9 per system. Install first adapter in Slots 6P, 7P, 8P, 9P. Install second adapter in slots 3P, 4P, 5P (see note 15 on page 58)
FC 4958: Cryptographic Coprocessor	Max 4 per system. Install first adapter into Slots 6P, 7P, 8P, 9P. Install subsequent adapters as required. Do not install in slots 3, 4 or 5. See note 18 on page 58
FC 4963: Cryptographic Coprocessor, FIPS-4	See note 18 on page 58
FC 4960: IBM Cryptographic Accelerator (Type 6-J)	Max 4 per system
FC 6205: PCI Dual Channel Ultra2 SCSI (Type 4-R)	Any slot Max. 9 per system, see notes 8 and 11 See notes 8 on page 57 and 11 on page 57
FC 6203: Dual-Channel Ultra3 SCSI (Type 4-Y)	Any slot Max. 9 per system, see notes 8 and 11 See notes 8 on page 57 and 11 on page 57
FC 6206: Single-Ended Ultra SCSI Adapter (Type 4-K)	Max 9 per system
FC 6208: PCI SCSI-2 Single Ended Fast/Wide (Type 4-A)	Max 9 per system

Table 11. 7025 Model F50 (continued)

Adapter	Usage
FC 2968: 10/100 Mbps Ethernet Tx PCI (Type 9-P)	Max 8 per system for connectivity, see note 2
FC 4962: Ethernet/LAN Encryption 10/100BaseT	Max 8 per system See note 2
FC 2742: SysKonnnect SK-NET FDDI-LP DAS PCI (Type *)	See notes 2 on page 56 and 17 on page 58
FC 2741: SysKonnnect SK-NET FDDI-LP SAS PCI (Type *)	See notes 2 on page 56 and 17 on page 58
FC 2743: SysKonnnect SK-NET FDDI-UP SAS PCI (Type *)	See notes 2 on page 56 and 17 on page 58
FC 2988: TURBOWAYS 155 PCI MMF ATM (Type 9-F)	Max 4 per system (see notes 2 on page 56, 10 on page 57, and 17 on page 58)
FC 4957: 64-bit/66MHz PCI ATM 155 MMF (Type A-D)	Max 4 per system. (see notes 2 on page 56, 10 on page 57, and 17 on page 58)
FC 2946: PCI TURBOWAYS 622 PCI MMF ATM (Type A-B)	Max. of 1 in slots 1P, 2P, 3P, 6P, 4P, 7P, 5P, 8P/I, 9P/I (see notes 5 on page 57 and 14 on page 58)
FC 2963: TURBOWAYS 155 PCI UTP ATM (Type 9-J)	Max 4 per system (see note 2)
FC 4953: 64-bit/66MHz PCI ATM 155 UTP (Type A-C)	Max 4 per system (see notes 2 on page 56, and 10 on page 57)
FC 2987: Ethernet 10base5 PCI (Type 8-Z)	Max 9 per system
FC 2985: Ethernet 10base2 PCI (Type 8-Y)	Max 9 per system
FC 4959: High-Speed Token Ring PCI (Type 9-Y)	Any slot
FC 2979: PCI Auto LANstreamer Token Ring (Type 8-T)	Max 9 per system
FC 2920: 16Mbps PCI Token-Ring (Type 9-0)	Max 9 per system
FC 2962: 2-Port Multiprotocol PCI (Types 9-L and 9-V)	Max 9 per system
FC 3131: RAID INT Port to EXT Connector Cable	See note 16 on page 58
FC 2944: 128-Port Async Controller PCI (Type 3-C)	Max 9 per system
FC 2708: ISDN Basic Rate PCI (Type 9-N)	Max 9 per system
FC 2998: TURBOWAYS 25 ATM PCI (Type *)	Max 9 per system
FC 2943: 8-Port Asynchronous EIA-232E/RS-422A PCI (Type 3-B)	Max 8 per system

Table 11. 7025 Model F50 (continued)

Adapter	Usage
FC 6207: PCI Differential Ultra SCSI (Type 4-L)	Max 9 per system
FC 6209: PCI SCSI-2 Differential Fast/Wide (Type 4-B)	Max 9 per system
FC 2947: IBM ARTIC960Hx 4-Port Selectable PCI (Type 9-R)	See note 3
FC 2948: IBM ARTIC960 4-Port T1/E1 PCI (Type 9-S)	See note 3
FC 2949: IBM ARTIC960 Hx DSP Resource PCI (Type 9-T)	See note 3
FC 2493: PCI SCSI-2 Fast/Wide RAID (Type 4-H)	Any slot. Max. 3 per system, see note 2
FC 2986: 10/100 Mbps PCI Fast Etherlink XL (Type *)	See notes 2 and 10

Notes:

- The 7025 Model F50 supports combinations of the FC 2839: POWER GXT110P (Type *) , FC 2838: POWER GXT120P (Type 1-P), FC 2830: POWER GXT130P (Type 1-T), and the FC 2853: POWER GXT800P (Type 1-K) adapters up to a maximum of two adapters total per system.
- For optimum system performance, the 7025 Model F50 supports any combination of the following adapters, but that combination cannot exceed a total of four per system. The combination should not exceed two per PCI bus:
 - FC 2988: TURBOWAYS 155 PCI MMF ATM (Type 9-F)
 - FC 4957: 64-bit/66MHz PCI ATM 155 MMF (Type A-D)
 - FC 2963: TURBOWAYS 155 PCI UTP ATM (Type 9-J)
 - FC 4953: 64-bit/66MHz PCI ATM 155 UTP (Type A-C)
 - FC 2986: 10/100 Mbps PCI Fast Etherlink XL (Type *)
 - FC 2493: PCI SCSI-2 Fast/Wide RAID (Type 4-H)
 - FC 2968: 10/100 Mbps Ethernet Tx PCI (Type 9-P)
 - FC 4962: Ethernet/LAN Encryption 10/100BaseT
 - FC 2742: SysKonnnect SK-NET FDDI-LP DAS PCI (Type *)
 - FC 2741: SysKonnnect SK-NET FDDI-LP SAS PCI (Type *)
 - FC 2743: SysKonnnect SK-NET FDDI-UP SAS PCI (Type *)
 - FC 4951: 10/100 4-Port Ethernet (Type 9-Z) (when in 100 Mbps mode)
 - FC 2975: Gigabit Ethernet (UTP) 1000BaseT (when in 100 Mbps mode)
- The 7025 Model F50 supports any combination of the following adapters, but that *combination* cannot exceed a total of seven:
 - FC 2947: IBM ARTIC960Hx 4-Port Selectable PCI (Type 9-R)
 - FC 2948: IBM ARTIC960 4-Port T1/E1 PCI (Type 9-S)
 - FC 2949: IBM ARTIC960 Hx DSP Resource PCI (Type 9-T)
 - FC 2751: S/390 ESCON Channel (Type 5-5)
 - FC 6309: Digital Trunk Quad PCI (Type 6-B)

4. The 7025 Model F50 supports any combination of the following adapters, but that *combination* cannot exceed a total of three:
 - FC 6309: Digital Trunk Quad PCI (Type 6-B)
 - FC 2751: S/390 ESCON Channel (Type 5-5)
5. For optimum system performance, the combination of the following adapters should not exceed a maximum of one adapter per bus:
 - FC 6215: PCI SSA Multi-Initiator/RAID EL (Type 4-N)
 - FC 6225: Advanced SSA SerialRAID (Type 4-P)
 - FC 6230: Advanced SerialRAID Plus (Type 4-P)
 - FC 2494: PCI 3-Channel Ultra2 SCSI RAID (Type 4-T)
 - FC 2969: Gigabit Ethernet Fibre, 1000BaseT
 - FC 2732, 2733: Serial HIPPI PCI (Types 9-W and 9-X)
 - FC 2975: Gigabit Ethernet (UTP) 1000BaseT
 - FC 2498: PCI 4-Channel Ultra3 SCSI RAID (Type 4-X)
 - FC 2946: PCI TURBOWAYS 622 PCI MMF ATM (Type A-B)
6. For optimum system performance, a maximum of one FC 2969: Gigabit Ethernet Fibre, 1000BaseT adapter per system is recommended. Use slots 1 or 2 if available.
7. The 7025 Model F50 supports combinations of the following adapters but that *combination* cannot exceed a total of four:
 - FC 6215: PCI SSA Multi-Initiator/RAID EL (Type 4-N)
 - FC 6225: Advanced SSA SerialRAID (Type 4-P)
 - FC 6230: Advanced SerialRAID Plus (Type 4-P)
8. For optimum system performance, a maximum of 4 FC 6205: PCI Dual Channel Ultra2 SCSI (Type 4-R) or FC 6203: Dual-Channel Ultra3 SCSI (Type 4-Y) adapters is recommended.
9. Do not install the FC 2494: PCI 3-Channel Ultra2 SCSI RAID (Type 4-T) adapter on the PCI Bus with the Service Processor card.
10. Do not install an FC 2988: TURBOWAYS 155 PCI MMF ATM (Type 9-F), FC 2986: 10/100 Mbps PCI Fast Etherlink XL (Type *), FC 4953: 64-bit/66MHz PCI ATM 155 UTP (Type A-C), FC 4957: 64-bit/66MHz PCI ATM 155 MMF (Type A-D), FC 2963: TURBOWAYS 155 PCI UTP ATM (Type 9-J), or FC 2968: 10/100 Mbps Ethernet Tx PCI (Type 9-P) adapter in the slot to the right (higher numbered slot) of the FC 2751: S/390 ESCON Channel (Type 5-5) adapter.
11. Do not install an FC 6205: PCI Dual Channel Ultra2 SCSI (Type 4-R) or FC 6203: Dual-Channel Ultra3 SCSI (Type 4-Y) adapter on the same PCI bus as a FC 2838: POWER GXT120P (Type 1-P) or a FC 2830: POWER GXT130P (Type 1-T).
12. Install FC 6310: IBM ARTIC960 RxD Quad Digital Trunk PCI (Type 6-E) and FC 6311: IBM ARTIC960 RxF PCI (Type 6-G) starting at the bottom-most available slot, with FC 6310: IBM ARTIC960 RxD Quad Digital Trunk PCI (Type 6-E) being installed in the lower numbered slots first. Do not install more than a combination of six FC 6310: IBM ARTIC960 RxD Quad Digital Trunk PCI (Type 6-E) and FC 6311: IBM ARTIC960 RxF PCI (Type 6-G) adapters.
13. For optimum system performance, install a maximum of one FC 2969: Gigabit Ethernet Fibre, 1000BaseT or one FC 2975: Gigabit Ethernet (UTP) 1000BaseT (when configured to run at 1000 Mbps) adapter per system. If one of each or two of either are installed, a maximum of one adapter per bus is recommended.

14. For optimum system performance, a maximum of one FC 2946: PCI TURBOWAYS 622 PCI MMF ATM (Type A-B) per system is recommended.
15. For optimum system performance using the FC 4951: 10/100 4-Port Ethernet (Type 9-Z) adapter in 100 Mbps mode, use only two of the four ports. Install a maximum of two adapters per system, putting each on its own PCI bus.
16. FC 3131: RAID INT Port to EXT Connector Cable placements may extend beyond the one slot used by FC 2493: PCI SCSI-2 Fast/Wide RAID (Type 4-H) to two additional slots in that order. The FC 3131 Connector Cables are not actual adapters; however, they do occupy one slot for each placement.
17. Any combination of the following adapters may be installed, provided that the combined number installed does not exceed four (4) total per system: FC 2741, FC 2742, FC 2743, FC 2986, FC 2988, FC 4962, FC 4957.
18. A combined maximum of four FC 4958: Cryptographic Coprocessor and FC 4963: Cryptographic Coprocessor, FIPS-4 adapters are allowed per system.

Chapter 9. 7025 Model F80

This system is designed for customers to install adapters. Use this guide to determine if there are specific slot requirements for adapters that you may be installing.

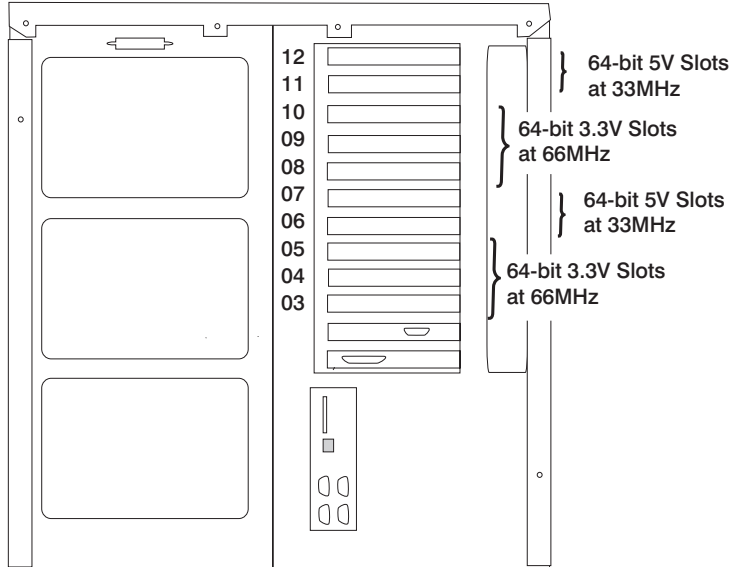

System Unit Rear View with Numbered Slots

Some adapters must be placed in specific system unit slots to function correctly at optimum performance. Use the table under “7025 Model F80 Adapter Placement Guide” to determine where to install an adapter in your system unit.

Many of the following notes refer to optimizing system performance. Read Chapter 1 of the *PCI Adapter Placement Reference* for more performance-related information.

Use the rear-view diagram above to identify slot locations described in the following table.

7025 Model F80 Adapter Placement Guide

Use the following table to identify specific slot location options for the following adapters in your 7025 Model F80 system.

Note: The adapters with the highest slot placement priority are listed at the top of the table. The slot numbers in the Slot Usage column represent slot location priorities. Use the first numbered slot first. If an adapter has already filled the first slot in the list, go to the next number in the list.

Table 12. 7025 Model F80

Adapter	Slot Usage	System Maximum	Hot-Pluggable?
FC 2830: POWER GXT130P (Type 1-T)	6, 11, 7, 12	1	N
FC 2848: GXT135P Graphics Adapter (Type 1-X)	9, 8, 3, 4, 10, 5, 6, 11, 7, 12	1	N
FC 2969: Gigabit Ethernet Fibre, 1000BaseT	9, 8, 3, 4, 10, 5, 6, 11, 7, 12	6 (see notes 5 on page 63 and 9 on page 63)	Y
FC 2975: Gigabit Ethernet (UTP) 1000BaseT	9, 8, 3, 4, 10, 5, 6, 11, 7, 12	6 (see notes 5 on page 63 and 9 on page 63)	Y
FC 6310: IBM ARTIC960 RxD Quad Digital Trunk PCI (Type 6-E)	9, 8, 3, 4, 10, 5, 6, 11, 7, 12 (see note 4 on page 63)	4	See note 1 on page 63
FC 2498: PCI 4-Channel Ultra3 SCSI RAID (Type 4-X)	9, 8, 3, 4, 10, 5, 6, 11, 7, 12	6	Y
FC 2708: ISDN Basic Rate PCI (Type 9-N)	6, 11, 7, 12	1	Y
FC 6227: Gigabit Fibre Channel PCI (Type 4-S)	9, 8, 3, 4, 10, 5, 6, 11, 7, 12	6	Y
FC 6228: Gigabit Fibre Channel Adapter, 32 or 64-bit PCI Bus (Type 4-W)	9, 8, 3, 4, 10, 5, 6, 11, 7, 12	6	Y
FC 6230: Advanced SerialRAID Plus (Type 4-P) FC 6235: Fast Write Cache Option for FC 6230 FC 6230+6231: 4 Port SSA 40 w/128MB DIMM	9, 8, 3, 4, 10, 5, 6, 11, 7, 12 (see notes 3 on page 63 and 2 on page 63)	6	Y
FC 2947: IBM ARTIC960Hx 4-Port Selectable PCI (Type 9-R)	9, 8, 3, 4, 10, 5, 6, 11, 7, 12	4	N

Table 12. 7025 Model F80 (continued)

Adapter	Slot Usage	System Maximum	Hot-Pluggable?
FC 2943: 8-Port Asynchronous EIA-232E/RS-422A PCI (Type 3-B)	9, 8, 3, 4, 10, 5, 6, 11, 7, 12	10	Y
FC 2944: 128-Port Async Controller PCI (Type 3-C)	9, 8, 3, 4, 10, 5, 6, 11, 7, 12	10	Y
FC 4961: 10/100 4-Port Ethernet (Type A-E)	9, 8, 3, 4, 10, 5, 6, 11, 7, 12	6 (see notes 8 on page 63 and 9 on page 63)	Y
FC 2962: 2-Port Multiprotocol PCI (Types 9-L and 9-V)	6, 11, 7, 12	4	Y
FC 2963: TURBOWAYS 155 PCI UTP ATM (Type 9-J)	9, 8, 3, 4, 10, 5, 6, 11, 7, 12	4 (see note 9 on page 63)	Y
FC 4953: 64-bit/66MHz PCI ATM 155 UTP (Type A-C)	9, 8, 3, 4, 10, 5, 6, 11, 7, 12	4 (see note 9 on page 63)	Y
FC 2988: TURBOWAYS 155 PCI MMF ATM (Type 9-F)	9, 8, 3, 4, 10, 5, 6, 11, 7, 12	4 (see note 9 on page 63)	Y
FC 4957: 64-bit/66MHz PCI ATM 155 MMF (Type A-D)	9, 8, 3, 4, 10, 5, 6, 11, 7, 12	4 (see note 9 on page 63)	Y
FC 2946: PCI TURBOWAYS 622 PCI MMF ATM (Type A-B)	6, 12, 7, 11 (see note11 on page 64)	4	Y
FC 2742: SysKonnnect SK-NET FDDI-LP DAS PCI (Type *)	9, 8, 3, 4, 10, 5, 6, 11, 7, 12	4 (see notes6 on page 63 and 9 on page 63)	Y
FC 2741: SysKonnnect SK-NET FDDI-LP SAS PCI (Type *)	9, 8, 3, 4, 10, 5, 6, 11, 7, 12	4 (see notes 6 on page 63 and 9 on page 63)	Y

Table 12. 7025 Model F80 (continued)

Adapter	Slot Usage	System Maximum	Hot-Pluggable?
FC 2743: SysKonnnect SK-NET FDDI-UP SAS PCI (Type *)	9, 8, 3, 4, 10, 5, 6, 11, 7, 12	4 (see notes 6 on page 63 and 9 on page 63)	Y
FC 2751: S/390 ESCON Channel (Type 5-5)	6, 11, 7, 12	3	N
FC 6207: PCI Differential Ultra SCSI (Type 4-L)	6, 11, 7, 12	4	Y
FC 6205: PCI Dual Channel Ultra2 SCSI (Type 4-R)	9, 8, 3, 4, 10, 5, 6, 11, 7, 12	6	Y
FC 6203: Dual-Channel Ultra3 SCSI (Type 4-Y)	9, 8, 3, 4, 10, 5, 6, 11, 7, 12	6	Y
FC 4959: High-Speed Token Ring PCI (Type 9-Y)	9, 8, 3, 4, 10, 5, 6, 11, 7, 12	9	Y
FC 6206: Single-Ended Ultra SCSI Adapter (Type 4-K)	6, 11, 7, 12	4	Y
FC 6204: PCI Universal Differential Ultra SCSI (Type 4-U)	9, 8, 3, 4, 10, 5, 6, 11, 7, 12	10	Y
FC 2968: 10/100 Mbps Ethernet Tx PCI (Type 9-P)	9, 8, 3, 4, 10, 5, 6, 11, 7, 12	10 (see notes 7 on page 63 and 9 on page 63)	Y
FC 4962: Ethernet/LAN Encryption 10/100BaseT	9, 8, 3, 4, 10, 5, 6, 11, 7, 12	10 (see notes 7 on page 63 and 9 on page 63)	Y
FC 4951: 10/100 4-Port Ethernet (Type 9-Z)	9, 8, 3, 4, 10, 5, 6, 11, 7, 12	10	Y
FC 2985: Ethernet 10base2 PCI (Type 8-Y)	6, 11, 7, 12	4	Y
FC 2987: Ethernet 10base5 PCI (Type 8-Z)	6, 11, 7, 12	4	Y

Table 12. 7025 Model F80 (continued)

Adapter	Slot Usage	System Maximum	Hot-Pluggable?
FC 6311: IBM ARTIC960 RxF PCI (Type 6-G)	9, 8, 3, 4, 10, 5, 6, 11, 7, 12 (see note4)	4	N
FC 4958: Cryptographic Coprocessor	9, 8, 3, 4, 10, 5, 6, 11, 7, 12	4	Y
FC 4960: IBM Cryptographic Accelerator (Type 6-J)	9, 8, 3, 4, 10, 5, 6, 11, 7, 12	4 (see note10 on page 64)	Y

Notes:

1. This adapter is hot-pluggable if it is not cabled to another card internally.
2. FC 6231: 128 MB DIMM for FC 6230 is 128 MB memory dimm option for the FC 6225: Advanced SSA SerialRAID (Type 4-P) adapter and can only be selected along with FC 6230: Advanced SerialRAID Plus (Type 4-P) (max 1 per 6230).
3. FC 6235: Fast Write Cache Option for FC 6230 is a RAID cache upgrade for the FC 6225: Advanced SSA SerialRAID (Type 4-P) adapter and can only be selected along with FC 6230: Advanced SerialRAID Plus (Type 4-P) (max 1 per 6230).
4. If multiple FC 6310s and FC 6311s are on the order, FC 2877 (Quad DTA, H.100, 4-Drop Cable) or FC 4353 (Cable, Internal H.100 BUS, 8-Position) must be used to connect FC 6310: IBM ARTIC960 RxD Quad Digital Trunk PCI (Type 6-E) and FC 6311: IBM ARTIC960 RxF PCI (Type 6-G) .
5. For optimum system performance, a maximum of two FC 2969: Gigabit Ethernet Fibre, 1000BaseT or FC 2975: Gigabit Ethernet (UTP) 1000BaseT adapters per system is recommended.
6. For optimum system performance, a maximum of 14 FC 2741: SysKonnnect SK-NET FDDI-LP SAS PCI (Type *), FC 2742: SysKonnnect SK-NET FDDI-LP DAS PCI (Type *), and FC 2743: SysKonnnect SK-NET FDDI-UP SAS PCI (Type *) adapters per system and a maximum of seven FC 2741, FC 2742, and FC 2743 adapters per I/O drawer is recommended.
7. For optimum system performance, a maximum of eight FC 2968: 10/100 Mbps Ethernet Tx PCI (Type 9-P) or FC 4962: Ethernet/LAN Encryption 10/100BaseT adapters per system.
8. For optimum system performance using the FC 4961: 10/100 4-Port Ethernet (Type A-E) on this system, use only 2 of the 4 ports if the ports will all be running at media speed. Use a maximum of six ports per system (that is, three adapters running 2 ports each). Limit adapters to two per I/O drawer in 64-bit slots.
9. For optimum system performance, the combination of FC 2969: Gigabit Ethernet Fibre, 1000BaseT, FC 2741: SysKonnnect SK-NET FDDI-LP SAS PCI (Type *), FC 2742: SysKonnnect SK-NET FDDI-LP DAS PCI (Type *), FC 2743: SysKonnnect SK-NET FDDI-UP SAS PCI (Type *), FC 2968: 10/100 Mbps Ethernet Tx PCI (Type 9-P), FC 4951: 10/100 4-Port Ethernet (Type 9-Z), FC 2963: TURBOWAYS 155 PCI UTP ATM (Type 9-J), FC 4953: 64-bit/66MHz PCI ATM 155 UTP (Type A-C), FC 4957: 64-bit/66MHz PCI ATM 155 MMF (Type A-D), FC 4962:

Ethernet/LAN Encryption 10/100BaseT, FC 2975: Gigabit Ethernet (UTP) 1000BaseT, and FC 2988: TURBOWAYS 155 PCI MMF ATM (Type 9-F) adapters cannot exceed 7 adapters per system.

10. A combined maximum of four FC 4958: Cryptographic Coprocessor and RPQ 8A1162: Cryptographic Coprocessor adapters are allowed per system.
11. For optimum performance using FC 2946: PCI TURBOWAYS 622 PCI MMF ATM (Type A-B), limit adapters to the following:
 - MTU 1500: 1 per drawer, 2 per system
 - MTU 9180: 2 per drawer, 3 per system

Chapter 10. 7026 Model 6H0 and 7026 Model 6H1

This system is designed for service representatives to install adapters. Use this guide to determine if there are specific slot requirements for adapters that your service representative may be installing.

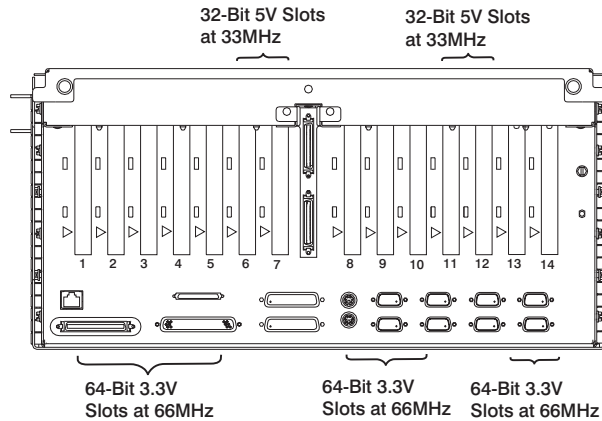

System Unit Rear View with Numbered Slots

Note: The 7026 Model 6H0 or 7026 Model 6H1 has three PCI buses, with Slots 1-4 on a bus, Slots 5-9 on a bus, and Slots 10-14 on a bus.

Some adapters must be placed in specific system unit slots to function correctly at optimum performance. Use the table under “7026 Model 6H0 and 7026 Model 6H1 Adapter Placement Guide” on page 66 to determine where to install these adapters in your 7026 Model 6H0 or 7026 Model 6H1. For best performance when using two drawers, space adapter usage evenly between the drawers.

Many of the following notes refer to optimizing system performance. Read “System Performance” on page 1 for more performance-related information.

Use the rear-view diagram above to identify slot locations described in the following tables. The “Slot Usage” column refers to preferred card placement order in both the system’s Primary and Secondary (if used) I/O drawers. For any one type of adapter card the placement should alternate between the Primary and Secondary drawers when possible.

If a table row lists more than one adapter, the adapters may be mixed, but the total number of adapters in the combination cannot exceed the number stated in the Maximum column.

7026 Model 6H0 and 7026 Model 6H1 Adapter Placement Guide

Use the following table to identify adapter slot location options for the following adapters in your 7026 Model 6H0 or 7026 Model 6H1.

Table 13. 7026 Model 6H0 or 7026 Model 6H1

Adapter	Slot Usage	Maximum per Drawer/System	Hot-Pluggable?
FC 6310: IBM ARTIC960 RxD Quad Digital Trunk PCI (Type 6-E)	9, 11, 10, 12	4/4	N (see notes 1 on page 69, and 4 on page 69)
FC 6311: IBM ARTIC960 RxF PCI (Type 6-G)	9, 11, 10, 12	3/3 see "Chapter 29. Digital Trunk PCI Adapter Placement Considerations" on page 185	N (see notes 1 on page 69, and 4 on page 69)
FC 8396: SP System Attachment (Type 6-F)	Primary 6 only	1/1 (see note 3 on page 69)	N
FC 8397: SP Colony Switch Attach	5 and 3	2/2 (see note 11 on page 70)	N
FC 2946: PCI TURBOWAYS 622 PCI MMF ATM (Type A-B)	1, 5, 10, 2, 8, 4, 13, 3, 9, 14, 6, 11, 7, 12	10/20 (see note 12 on page 70)	Y
FC 6228: Gigabit Fibre Channel Adapter, 32 or 64-bit PCI Bus (Type 4-W)	1, 5, 10, 2, 8, 4, 13, 3, 9, 14, 6, 11, 7, 12	8/16 (see note 10 on page 70)	Y
FC 2975: Gigabit Ethernet (UTP) 1000BaseT	1, 5, 10, 2, 8, 4, 13, 3, 9, 14, 6, 11, 7, 12	10/20 (see note 6 on page 69)	Y
FC 2969: Gigabit Ethernet Fibre, 1000BaseT	1, 5, 10, 2, 8, 4, 13, 3, 9, 14, 6, 11, 7, 12	10/20 (see note 6 on page 69)	Y

Table 13. 7026 Model 6H0 or 7026 Model 6H1 (continued)

Adapter	Slot Usage	Maximum per Drawer/System	Hot-Pluggable?
FC 6205: PCI Dual Channel Ultra2 SCSI (Type 4-R) FC 6203: Dual-Channel Ultra3 SCSI (Type 4-Y) FC 2498: PCI 4-Channel Ultra3 SCSI RAID (Type 4-X)	1, 5, 10, 2, 8, 4, 13, 3, 9, 14, 6, 11, 7, 12	10/20	Y
FC 4958: Cryptographic Coprocessor RPQ 8A1162: Cryptographic Coprocessor	1, 5, 10, 2, 8, 4, 13, 3, 9, 14, 6, 11, 7, 12	4/4 (see note 5 on page 69)	Y
FC 4960: IBM Cryptographic Accelerator (Type 6-J)	1, 5, 10, 2, 8, 4, 13, 3, 9, 14, 6, 11, 7, 12	4/4	Y
FC 6204: PCI Universal Differential Ultra SCSI (Type 4-U)	1, 5, 10, 2, 8, 4, 13, 3, 9, 14, 6, 11, 7, 12	10/20	Y
FC 6227: Gigabit Fibre Channel PCI (Type 4-S)	1, 5, 10, 2, 8, 4, 13, 3, 9, 14, 6, 11, 7, 12	8/16	Y
FC 4961: 10/100 4-Port Ethernet (Types A-E and 9-Z)	1, 5, 10, 2, 8, 4, 13, 3, 9, 14, 6, 11, 7, 12	10/20 (see note 9 on page 69)	Y
FC 6230: Advanced SerialRAID Plus (Type 4-P) FC 6230+6231: 4 Port SSA 40 w/128MB DIMM FC 6235: Fast Write Cache Option for FC 6230	1, 5, 10, 2, 8, 4, 13, 3, 9, 14, 6, 11, 7, 12	8/16	Y

Table 13. 7026 Model 6H0 or 7026 Model 6H1 (continued)

Adapter	Slot Usage	Maximum per Drawer/System	Hot-Pluggable?
FC 2741: SysKonnnect SK-NET FDDI-LP SAS PCI (Type *) FC 2742: SysKonnnect SK-NET FDDI-LP DAS PCI (Type *) FC 2743: SysKonnnect SK-NET FDDI-UP SAS PCI (Type *)	1, 5, 10, 2, 8, 4, 13, 3, 9, 14, 6, 11, 7, 12	14/28 (see note 7 on page 69)	Y
FC 2848: GXT135P Graphics Adapter (Type 1-X)	1, 5, 10, 2, 8, 4, 13, 3, 9, 14, 6, 11, 7, 12	1/1	N
FC 2943: 8-Port Asynchronous EIA-232E/RS-422A PCI (Type 3-B)	1, 5, 10, 2, 8, 4, 13, 3, 9, 14, 6, 11, 7, 12	14/28	Y
FC 2944: 128-Port Async Controller PCI (Type 3-C)	1, 5, 10, 2, 8, 4, 13, 3, 9, 14, 6, 11, 7, 12	14/28	Y
FC 2947: IBM ARTIC960Hx 4-Port Selectable PCI (Type 9-R)	1, 5, 10, 2, 8, 4, 13, 3, 9, 14, 6, 11, 7, 12	14/14	Y
FC 2962: 2-Port Multiprotocol PCI (Types 9-L and 9-V)	1, 5, 10, 2, 8, 4, 13, 3, 9, 14, 6, 11, 7, 12	5/10 see note 2 on page 69	N
FC 2963: TURBOWAYS 155 PCI UTP ATM (Type 9-J) FC 2988: TURBOWAYS 155 PCI MMF ATM (Type 9-F)	1, 5, 10, 2, 8, 4, 13, 3, 9, 14, 6, 11, 7, 12	7/7	Y
FC 2968: 10/100 Mbps Ethernet Tx PCI (Type 9-P)	1, 5, 10, 2, 8, 4, 13, 3, 9, 14, 6, 11, 7, 12	14/28 (see note 8 on page 69)	Y
FC 4962: Ethernet/LAN Encryption 10/100BaseT	1, 5, 10, 2, 8, 4, 13, 3, 9, 14, 6, 11, 7, 12	14/28 (see note 8 on page 69)	Y
FC 4959: High-Speed Token Ring PCI (Type 9-Y)	1, 5, 10, 2, 8, 4, 13, 3, 9, 14, 6, 11, 7, 12	14/28	Y

Table 13. 7026 Model 6H0 or 7026 Model 6H1 (continued)

Adapter	Slot Usage	Maximum per Drawer/System	Hot-Pluggable?
FC 4953: 64-bit/66MHz PCI ATM 155 UTP (Type A-C) FC 4957: 64-bit/66MHz PCI ATM 155 MMF (Type A-D)	1, 5, 10, 2, 8, 4, 13, 3, 9, 14, 6, 11, 7, 12	14/28	Y
FC 3154 Internal Attachment Card	7, 9, 2, 3, 4, 5, 8, 10, 13, 14, 11, 12	1/1 (see note 3)	N
FC 2751: S/390 ESCON Channel (Type 5-5)	6, 11, 7, 12	2/4	Y
FC 2830: POWER GXT130P (Type 1-T)	6, 11, 7, 12	1/1	N

Notes:

- FC 6311: IBM ARTIC960 RxF PCI (Type 6-G) requires FC 6310: IBM ARTIC960 RxD Quad Digital Trunk PCI (Type 6-E) to function.
- Adapter migration may require the use of a 5V slot.
- FC 3154 Internal Attachment Card must have FC 2968: 10/100 Mbps Ethernet Tx PCI (Type 9-P) installed in primary slot 1 in the system. FC 8396: SP System Attachment (Type 6-F) must have FC 3154 Internal Attachment Card installed in the system. FC 8396 must be placed in slot 6, FC 3154 in slot 7, and FC 2968 in slot 1 (see respective adapter instructions). The FC 8396 and FC 3154 adapters are not recognized without PSSP software, except by HTX.
- One FC 2877 (Quad DTXA, H.100, 4-Drop Cable) or FC 4353 (8-Drop Cable) is required to connect FC 6310 and/or FC 6311 if more than one is ordered. FC 6311 or additional FC 6310 adapters must be interconnected for proper operation. When connected, FC 6310 is not hot-pluggable.
- A combined maximum of four FC 4958: Cryptographic Coprocessor and RPQ 8A1162: Cryptographic Coprocessor adapters are allowed per system.
- For optimum system performance, a maximum of two FC 2969: Gigabit Ethernet Fibre, 1000BaseT or FC 2975: Gigabit Ethernet (UTP) 1000BaseT adapters per system is recommended.
- A combined adapter maximum of 7 FC 2741: SysKonnnect SK-NET FDDI-LP SAS PCI (Type *), FC 2742: SysKonnnect SK-NET FDDI-LP DAS PCI (Type *), and FC 2743: SysKonnnect SK-NET FDDI-UP SAS PCI (Type *) adapters are allowed per system.
- For optimum system performance, a maximum of eight FC 2968: 10/100 Mbps Ethernet Tx PCI (Type 9-P) or FC 4962: Ethernet/LAN Encryption 10/100BaseT adapters per system and a maximum of seven per I/O drawer is recommended.
- For optimum system performance using the FC 4961: 10/100 4-Port Ethernet (Type A-E) on this system, use only 2 of the 4 ports if the ports will all be running

at media speed. Use a maximum of six ports per system (i.e., 3 adapters running 2 ports each). Limit adapters to two per I/O drawer in 64-bit slots.

10. If attaching a device or switch with an SC type fiber connector(s), use of an LC-SC Fiber Channel Conversion Cable (FC 2456) is required.
11. Installation of FC 8397: SP Colony Switch Attach in slot 5 or 3 requires the removal of the adjacent plastic air guide in slot 6 or 4 respectively. The first FC 8397 must be installed in slot 5, FC 3154 Internal Attachment Card installed in slot 6, and FC 2968: 10/100 Mbps Ethernet Tx PCI (Type 9-P) installed in slot 1 (see respective adapter instructions). FC 8397 and FC 3154 are not recognized without PSSP software installed.
12. For optimum performance using FC 2946: PCI TURBOWAYS 622 PCI MMF ATM (Type A-B), limit adapters to the following:
 - MTU 1500: 1 per drawer, 2 per system
 - MTU 9180: 2 per drawer, 3 per system

Chapter 11. 7026 Model 6M1

This system is designed for service representatives to install adapters. Use this guide to determine if there are specific slot requirements for adapters that your service representative may be installing.

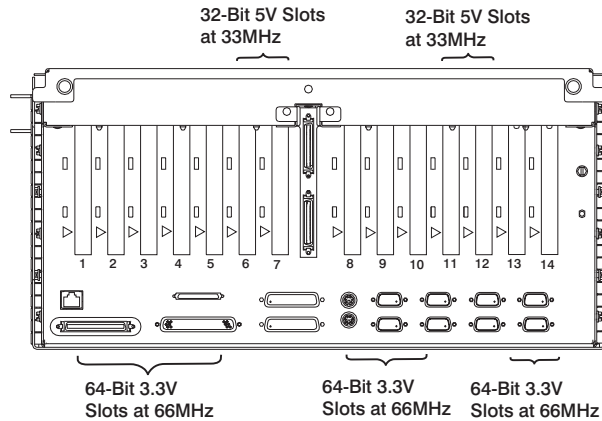

System Unit Rear View with Numbered Slots

Note: The 7026 Model 6M1 has three PCI buses, with Slots 1 - 4 on one bus, Slots 5 - 9 on a bus, and Slots 10 - 14 on a bus.

Some adapters must be placed in specific system unit slots to function correctly at optimum performance. Use the table under "7026 Model 6M1 Adapter Placement Guide" on page 72 to determine where to install these adapters in your 7026 Model 6M1. For best performance when using two drawers, space adapter usage evenly between the drawers.

Many of the following notes refer to optimizing system performance. Read "System Performance" on page 1 for more performance-related information.

Use the rear-view diagram above to identify slot locations described in the following tables. The "Slot Usage" column refers to preferred card placement order in both the system's Primary and Secondary (if used) I/O drawers. For any one type of adapter card the placement should alternate between the Primary and Secondary drawers when possible.

If a table row lists more than one adapter, the adapters may be mixed, but the total number of adapters in the combination cannot exceed the number stated in the Maximum column.

7026 Model 6M1 Adapter Placement Guide

Use the following table to identify adapter slot location options for the following adapters in your 7026 Model 6M1.

Table 14. 7026 Model 6M1

Adapter	Slot Usage	Maximum per Drawer/System	Hot-Pluggable?
FC 6310: IBM ARTIC960 RxD Quad Digital Trunk PCI (Type 6-E)	9, 11, 10, 12	4/4	N (see notes 1 on page 75, and 4 on page 75)
FC 6311: IBM ARTIC960 RxF PCI (Type 6-G)	9, 11, 10, 12	3/3 see "Chapter 29. Digital Trunk PCI Adapter Placement Considerations" on page 185	N (see notes 1 on page 75, and 4 on page 75)
FC 8396: SP System Attachment (Type 6-F)	Primary 6 only	1/1 (see note 3 on page 75)	N
FC 8397: SP Colony Switch Attach	5 and 3	2/2 (see note 11 on page 76)	N
FC 2946: PCI TURBOWAYS 622 PCI MMF ATM (Type A-B)	1, 5, 10, 2, 8, 4, 13, 3, 9, 14, 6, 11, 7, 12	10/20 (see note 12 on page 76)	Y
FC 6228: Gigabit Fibre Channel Adapter, 32 or 64-bit PCI Bus (Type 4-W)	1, 5, 10, 2, 8, 4, 13, 3, 9, 14, 6, 11, 7, 12	8/16 (see note 10 on page 76)	Y
FC 2975: Gigabit Ethernet (UTP) 1000BaseT	1, 5, 10, 2, 8, 4, 13, 3, 9, 14, 6, 11, 7, 12	10/20 (see note 6 on page 75)	Y
FC 2969: Gigabit Ethernet Fibre, 1000BaseT	1, 5, 10, 2, 8, 4, 13, 3, 9, 14, 6, 11, 7, 12	10/20 (see note 6 on page 75)	Y

Table 14. 7026 Model 6M1 (continued)

Adapter	Slot Usage	Maximum per Drawer/System	Hot-Pluggable?
FC 6205: PCI Dual Channel Ultra2 SCSI (Type 4-R) FC 6203: Dual-Channel Ultra3 SCSI (Type 4-Y) FC 2498: PCI 4-Channel Ultra3 SCSI RAID (Type 4-X)	1, 5, 10, 2, 8, 4, 13, 3, 9, 14, 6, 11, 7, 12	10/20	Y
FC 4961: 10/100 4-Port Ethernet (Types A-E and 9-Z)	1, 5, 10, 2, 8, 4, 13, 3, 9, 14, 6, 11, 7, 12	10/20 (see note 9 on page 75)	Y
FC 2751: S/390 ESCON Channel (Type 5-5)	6, 11, 7, 12	2/4	Y
FC 4958: Cryptographic Coprocessor RPQ 8A1162: Cryptographic Coprocessor	1, 5, 10, 2, 8, 4, 13, 3, 9, 14, 6, 11, 7, 12	4/4 (see note 5 on page 75)	Y
FC 4960: IBM Cryptographic Accelerator (Type 6-J)	1, 5, 10, 2, 8, 4, 13, 3, 9, 14, 6, 11, 7, 12	4/8	Y
FC 6204: PCI Universal Differential Ultra SCSI (Type 4-U)	1, 5, 10, 2, 8, 4, 13, 3, 9, 14, 6, 11, 7, 12	10/20	Y
FC 6227: Gigabit Fibre Channel PCI (Type 4-S)	1, 5, 10, 2, 8, 4, 13, 3, 9, 14, 6, 11, 7, 12	8/16	Y
FC 6230: Advanced SerialRAID Plus (Type 4-P) FC 6230+6231: 4 Port SSA 40 w/128MB DIMM FC 6235: Fast Write Cache Option for FC 6230	1, 5, 10, 2, 8, 4, 13, 3, 9, 14, 6, 11, 7, 12	8/16	Y

Table 14. 7026 Model 6M1 (continued)

Adapter	Slot Usage	Maximum per Drawer/System	Hot-Pluggable?
FC 2741: SysKonnnect SK-NET FDDI-LP SAS PCI (Type *) FC 2742: SysKonnnect SK-NET FDDI-LP DAS PCI (Type *) FC 2743: SysKonnnect SK-NET FDDI-UP SAS PCI (Type *)	1, 5, 10, 2, 8, 4, 13, 3, 9, 14, 6, 11, 7, 12	14/28 (see note 7 on page 75)	Y
FC 2848: GXT135P Graphics Adapter (Type 1-X)	1, 5, 10, 2, 8, 4, 13, 3, 9, 14, 6, 11, 7, 12	1/1	N
FC 2943: 8-Port Asynchronous EIA-232E/RS-422A PCI (Type 3-B)	1, 5, 10, 2, 8, 4, 13, 3, 9, 14, 6, 11, 7, 12	14/28	Y
FC 2944: 128-Port Async Controller PCI (Type 3-C)	1, 5, 10, 2, 8, 4, 13, 3, 9, 14, 6, 11, 7, 12	14/28	Y
FC 2947: IBM ARTIC960Hx 4-Port Selectable PCI (Type 9-R)	1, 5, 10, 2, 8, 4, 13, 3, 9, 14, 6, 11, 7, 12	14/14	Y
FC 2962: 2-Port Multiprotocol PCI (Types 9-L and 9-V)	1, 5, 10, 2, 8, 4, 13, 3, 9, 14, 6, 11, 7, 12 see note 2 on page 75	5/10	N
FC 2963: TURBOWAYS 155 PCI UTP ATM (Type 9-J) FC 2988: TURBOWAYS 155 PCI MMF ATM (Type 9-F)	1, 5, 10, 2, 8, 4, 13, 3, 9, 14, 6, 11, 7, 12	7/7	Y
FC 4953: 64-bit/66MHz PCI ATM 155 UTP (Type A-C) FC 4957: 64-bit/66MHz PCI ATM 155 MMF (Type A-D)	1, 5, 10, 2, 8, 4, 13, 3, 9, 14, 6, 11, 7, 12	14/28	Y
FC 2968: 10/100 Mbps Ethernet Tx PCI (Type 9-P)	1, 5, 10, 2, 8, 4, 13, 3, 9, 14, 6, 11, 7, 12	14/28 (see note 8 on page 75)	Y

Table 14. 7026 Model 6M1 (continued)

Adapter	Slot Usage	Maximum per Drawer/System	Hot-Pluggable?
FC 4962: Ethernet/LAN Encryption 10/100BaseT	1, 5, 10, 2, 8, 4, 13, 3, 9, 14, 6, 11, 7, 12	14/28 (see note 8)	Y
FC 4959: High-Speed Token Ring PCI (Type 9-Y)	1, 5, 10, 2, 8, 4, 13, 3, 9, 14, 6, 11, 7, 12	14/28	Y
FC 3154 Internal Attachment Card	7, 9, 2, 3, 4, 5, 8, 10, 13, 14, 11, 12	1/1 (see note 3)	N
FC 2830: POWER GXT130P (Type 1-T)	6, 11, 7, 12	1/1	N

Notes:

- FC 6311: IBM ARTIC960 RxF PCI (Type 6-G) requires FC 6310: IBM ARTIC960 RxD Quad Digital Trunk PCI (Type 6-E) to function.
- Adapter migration may require the use of a 5V slot.
- Adapter FC 3154 Internal Attachment Card must have a FC 2968: 10/100 Mbps Ethernet Tx PCI (Type 9-P) adapter installed in slot 1 in the system. FC 8396: SP System Attachment (Type 6-F) must have 3154 Internal Attachment Card installed in the system. FC 8396 must be placed in slot 6, FC 3154 in slot 7, and FC 2698 in slot 1 (see respective adapter instructions). The FC 8396 and FC 3154 adapters are *not* recognized without PSSP software, except by HTX.
- One FC 2877 (Quad DTXA, H.100, 4-Drop Cable) or FC 4353 (8-Drop Cable) is required to connect FC 6310 and/or FC 6311 if more than one is ordered. FC 6311 or additional FC 6310 adapters must be interconnected for proper operation. When connected, FC 6310 is not hot-pluggable.
- A combined maximum of four FC 4958: Cryptographic Coprocessor and RPQ 8A1162: Cryptographic Coprocessor adapters are allowed per system.
- For optimum system performance, a maximum of four FC 2969: Gigabit Ethernet Fibre, 1000BaseT or FC 2975: Gigabit Ethernet (UTP) 1000BaseT adapters per system, two per I/O drawer, is recommended.
- A combined adapter maximum of 7 FC 2741: SysKonnnect SK-NET FDDI-LP SAS PCI (Type *), FC 2742: SysKonnnect SK-NET FDDI-LP DAS PCI (Type *), and FC 2743: SysKonnnect SK-NET FDDI-UP SAS PCI (Type *) adapters are allowed per system.
- For optimum system performance, a maximum of eight FC 2968: 10/100 Mbps Ethernet Tx PCI (Type 9-P) or FC 4962: Ethernet/LAN Encryption 10/100BaseT adapters per system and a maximum of seven per I/O drawer is recommended.
- For optimum system performance using the FC 4961: 10/100 4-Port Ethernet (Type A-E) on this system, use only 2 of the 4 ports if the ports will all be running at media speed. Use a maximum of six ports per system (i.e., 3 adapters running 2 ports each). Limit adapters to two per I/O drawer in 64-bit slots.

10. If attaching a device or switch with an SC type fiber connector(s), use of an LC-SC Fiber Channel Conversion Cable (FC 2456) is required.
11. Installation of FC 8397: SP Colony Switch Attach in slot 5 or 3 requires the removal of the adjacent plastic air guide in slot 6 or 4 respectively. The first FC 8397 must be installed in slot 5, FC 3154 Internal Attachment Card installed in slot 6, and FC 2968: 10/100 Mbps Ethernet Tx PCI (Type 9-P) installed in slot 1 (see respective adapter instructions). FC 8397 and FC 3154 are not recognized without PSSP software installed.
12. For optimum performance using FC 2946: PCI TURBOWAYS 622 PCI MMF ATM (Type A-B), limit adapters to the following:
 - MTU 1500: 2 per drawer, 4 per system
 - MTU 9180: 3 per drawer, 6 per system

Chapter 12. 7026 Model H10

This system is designed for service representatives to install adapters. Use this guide to determine if there are specific slot requirements for adapters that your service representative may be installing.

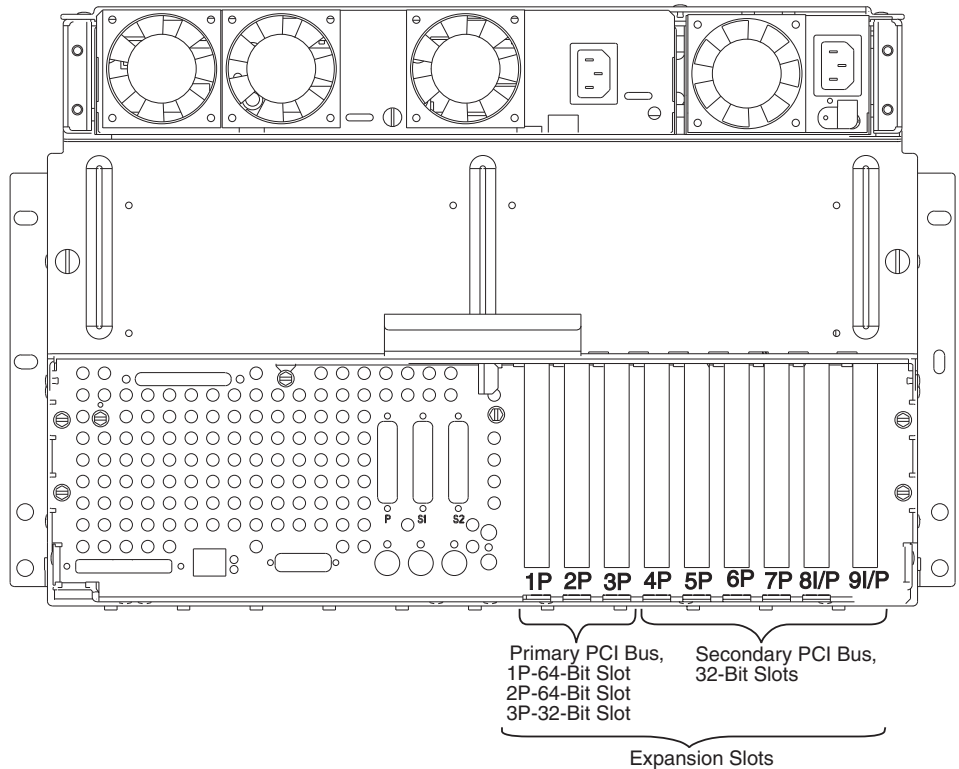

System Unit Rear View with Numbered Slots

Some adapters must be placed in specific system unit slots to function correctly at optimum performance. Use the table under “7026 Model H10 Adapter Placement Guide” on page 78 to determine where to install an adapter in your 7026 Model H10.

Many of the following notes refer to optimizing system performance. Read “System Performance” on page 1 for more performance-related information.

Use the rear-view diagram above to identify slot locations described in the following tables.

7026 Model H10 Adapter Placement Guide

Use the following table to identify adapter slot location options for the following adapters in your 7026 Model H10.

Table 15. 7026 Model H10

Adapter	Usage
FC 2839: POWER GXT110P (Type *)	Slot 3P
FC 2838: POWER GXT120P (Type 1-P)	Slots 1P - 9P
FC 2830: POWER GXT130P (Type 1-T)	Slots 1P - 9P
FC 6215: PCI SSA Multi-Initiator/RAID EL (Type 4-N)	Max. of 1 in slots 1P or 2P Max. of 1 in slot 3P Max. of 1 in slots 4P, or 5P, or 7P, or 8I/P, or 9I/P Max. 3 per Machine, see the notes following this section.
FC 6218: PCI SSA 4-Port RAID (Type 4-J)	Max. of 1 in slots 1P or 2P Max. of 1 in slot 3P Max. of 1 in slots 4P, or 5P, or 6P, or 7P, or 8I/P, or 9I/P Max. 3 per Machine, see the notes following this section.
FC 2988: TURBOWAYS 155 PCI MMF ATM (Type 9-F)	See the notes following this section.
FC 2963: TURBOWAYS 155 PCI UTP ATM (Type 9-J)	See the notes following this section.
FC 2986: 10/100 Mbps PCI Fast Etherlink XL (Type *)	See the notes following this section.
FC 2968: 10/100 Mbps Ethernet Tx PCI (Type 9-P)	See the notes following this section.
FC 2493: PCI SCSI-2 Fast/Wide RAID (Type 4-H)	See the notes following this section.
FC 2742: SysKonnnect SK-NET FDDI-LP DAS PCI (Type *)	See the notes following this section.
FC 2741: SysKonnnect SK-NET FDDI-LP SAS PCI (Type *)	See the notes following this section.
FC 2743: SysKonnnect SK-NET FDDI-UP SAS PCI (Type *)	See the notes following this section.

Notes:

1. **Connectivity Note:** The 7026 Model H10 supports any combination of the following adapters, but that *combination* cannot exceed a total of four:
 - FC 2988: TURBOWAYS 155 PCI MMF ATM (Type 9-F)

- FC 2963: TURBOWAYS 155 PCI UTP ATM (Type 9-J)
- FC 2986: 10/100 Mbps PCI Fast Etherlink XL (Type *)
- FC 2968: 10/100 Mbps Ethernet Tx PCI (Type 9-P)
- FC 2493: PCI SCSI-2 Fast/Wide RAID (Type 4-H)
- FC 2742: SysKonnnect SK-NET FDDI-LP DAS PCI (Type *)
- FC 2741: SysKonnnect SK-NET FDDI-LP SAS PCI (Type *)
- FC 2743: SysKonnnect SK-NET FDDI-UP SAS PCI (Type *)

Performance Note: For optimum system performance, a maximum of one of the following adapters is recommended. Also, these adapters should be placed in a primary PCI bus slot (slots 1-3) of this system unit. (This restriction does not apply if the FC 2968: 10/100 Mbps Ethernet Tx PCI (Type 9-P) adapter is used in 10 Mbps mode.)

- FC 2988: TURBOWAYS 155 PCI MMF ATM (Type 9-F)
 - FC 2963: TURBOWAYS 155 PCI UTP ATM (Type 9-J)
 - FC 2986: 10/100 Mbps PCI Fast Etherlink XL (Type *)
 - FC 2968: 10/100 Mbps Ethernet Tx PCI (Type 9-P)
 - FC 2493: PCI SCSI-2 Fast/Wide RAID (Type 4-H)
 - FC 2742: SysKonnnect SK-NET FDDI-LP DAS PCI (Type *)
 - FC 2741: SysKonnnect SK-NET FDDI-LP SAS PCI (Type *)
 - FC 2743: SysKonnnect SK-NET FDDI-UP SAS PCI (Type *)
2. The 7026 Model H10 supports a maximum of three FC 6218: PCI SSA 4-Port RAID (Type 4-J) or three FC 6215: PCI SSA Multi-Initiator/RAID EL (Type 4-N) adapters. If you choose to install both of these adapters in your 7026 Model H10, the combined total for both adapters must not exceed three.

Chapter 13. 7026 Model H50

This system is designed for service representatives to install adapters. Use this guide to determine if there are specific slot requirements for adapters that your service representative may be installing.

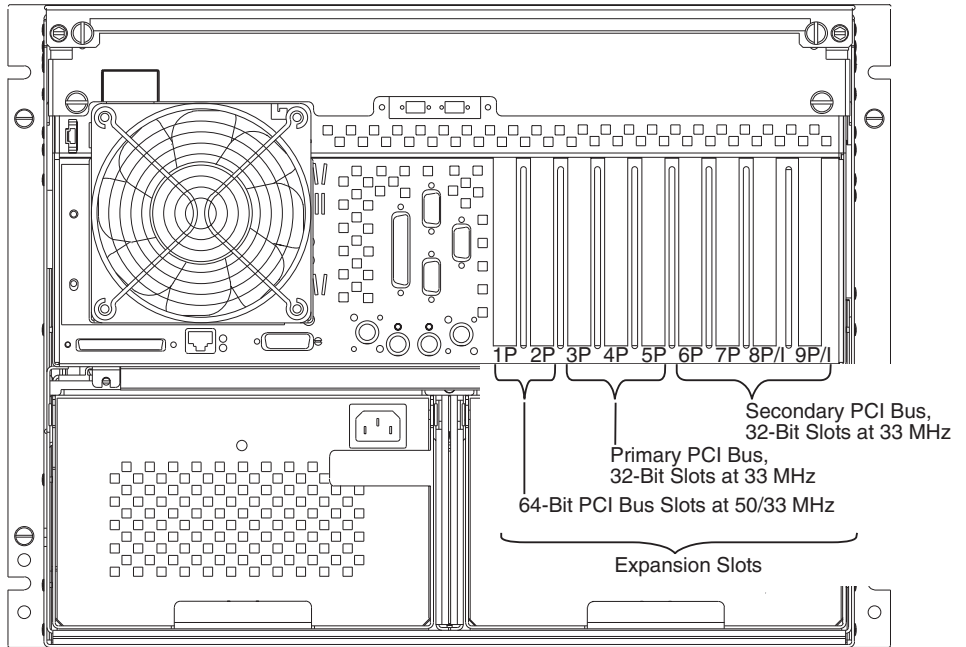

System Unit Rear View with Numbered Slots

Note: The 7026 Model H50 has three PCI buses, with Slots 1 - 2 on one bus, Slots 3 - 5 on a bus, and Slots 6 - 9 on a bus.

Some adapters must be placed in specific system unit slots to function correctly at optimum performance. Use the table under “7026 Model H50 Adapter Placement Guide” on page 82 to determine where to install these adapters in your 7026 Model H50.

Many of the following notes refer to optimizing system performance. Read “System Performance” on page 1 for more performance-related information.

Use the rear-view diagram above to identify slot locations described in the following tables.

7026 Model H50 Adapter Placement Guide

Use the following table to identify adapter slot location options for the following adapters in your 7026 Model H50.

Table 16. 7026 Model H50

Adapter	Usage
FC 2853: POWER GXT800P (Type 1-K)	Slot 3P only Max. 1 per system
FC 2859: GXT800P 3-slot Graphics (Type 1-K)	Slot 3P only Max. 1 per system
FC 2839: POWER GXT110P (Type *)	Slots 3P, 4P, and 5P Max. 2 per system
FC 6227: Gigabit Fibre Channel PCI (Type 4-S)	Slots 1P or 2P see note 10
FC 6228: Gigabit Fibre Channel Adapter, 32 or 64-bit PCI Bus (Type 4-W)	Slots 1P or 2P Max. 3 per system
FC 6230: Advanced SerialRAID Plus (Type 4-P) FC 6230+6231: 4 Port SSA 40 w/128MB DIMM FC 6235: Fast Write Cache Option for FC 6230	Any slot Max. 4 per system, 2 per bus See note 5
FC 6225: Advanced SSA SerialRAID (Type 4-P)	Any slot Max. 4 per system, 2 per bus See note 5
FC 6215: PCI SSA Multi-Initiator/RAID EL (Type 4-N)	Slots 1P, 4P, 7P, 9P/I see notes 5 and 1
FC 6222: 4-Port, SSA-RAID1 Fast Write Cache Option (Type 4-N)	Any slot

Table 16. 7026 Model H50 (continued)

Adapter	Usage
FC 2751: S/390 ESCON Channel (Type 5-5)	<p>See "Chapter 29. Digital Trunk PCI Adapter Placement Considerations" on page 185 If less than 2GB of system memory is installed, a maximum of 3 adapters combined per system.</p> <p>Max. of 3 in slots 1P, 2P, 3P, 4P, or 5P</p> <p>Max. of 2 in slots 6P, 7P, 8P/I, or 9P/I</p> <p>If more than 2GB of system memory is installed, a maximum of 3 adapters combined per system:</p> <p>Max. of 1 in slots 1 or 2</p> <p>Max. of 2 in slots 3, 4, or 5</p> <p>Max. of 1 in slots 6, 7, 8, or 9</p> <p>see notes 3, 4, and 9</p>
FC 2838: POWER GXT120P (Type 1-P) FC 2830: POWER GXT130P (Type 1-T)	<p>Any slot</p> <p>Max. 2 per system, see note 11</p>
FC 6309: Digital Trunk Quad PCI (Type 6-B)	<p>See "Chapter 29. Digital Trunk PCI Adapter Placement Considerations" on page 185 If less than 2GB of system memory is installed, a maximum of 3 adapters combined per system.</p> <p>Max. of 3 in slots 1P, 2P, 3P, 4P, or 5P</p> <p>Max. of 2 in slots 6P, 7P, 8P/I, or 9P/I</p> <p>If more than 2GB of system memory is installed, a maximum of 3 adapters combined per system:</p> <p>Max. of 1 in slots 1 or 2</p> <p>Max. of 2 in slots 3, 4, or 5</p> <p>Max. of 1 in slots 6, 7, 8, or 9</p> <p>see notes 3, 4, and 9</p>
FC 6310: IBM ARTIC960 RxD Quad Digital Trunk PCI (Type 6-E)	<p>Any slot</p> <p>Max. 4 per system</p> <p>See "Chapter 29. Digital Trunk PCI Adapter Placement Considerations" on page 185</p>

Table 16. 7026 Model H50 (continued)

Adapter	Usage
FC 6311: IBM ARTIC960 RxF PCI (Type 6-G)	Any slot See "Chapter 29. Digital Trunk PCI Adapter Placement Considerations" on page 185
FC 2969: Gigabit Ethernet Fibre, 1000BaseT	Max. of 1 in slots 1P, 2P, 3P, 4P, or 5P Max. of 1 in slots 6P, 7P, 8P/I, or 9P/I See notes 5 and 6
FC 2975: Gigabit Ethernet (UTP) 1000BaseT	Max. of 1 in slots 1P, 2P, 3P, 4P, or 5P Max. of 1 in slots 6P, 7P, 8P/I, or 9P/I See notes 5 on page 87 and 6 on page 87
FC 2732, 2733: Serial HIPPI PCI (Types 9-W and 9-X)	1 per bus, 2 per system See note 5
FC 2733: Serial HIPPI, Long-Wave Optics	Slots 1P, 2P (max. 1) Slots 3P, 4P, 5P (max 1)
FC 2494: PCI 3-Channel Ultra2 SCSI RAID (Type 4-T)	Any slot Max. 4 per system, see notes 8 and 5
FC 2498: PCI 4-Channel Ultra3 SCSI RAID (Type 4-X)	Max. of 4 in any slot
FC 4951: 10/100 4-Port Ethernet (Type 9-Z)	Max. of 9 in slots 6P, 7P, 8P, 9P Second adapter into Slots 3P, 4P, 5P See note 13 on page 87
FC 4958: Cryptographic Coprocessor	First adapter - Slots 6P, 7P, 8P, 9P Do not install in Slots 3, 4, and 5 Subsequent adapters as required
FC 6205: PCI Dual Channel Ultra2 SCSI (Type 4-R)	Any slot Max. 9 per system, see notes 7, 11, 12 See note 12 on page 87
FC 6206: Single-Ended Ultra SCSI Adapter (Type 4-K)	Any slot Max. 9 per system
FC 6208: PCI SCSI-2 Single Ended Fast/Wide (Type 4-A)	Any slot Max. 9 per system
FC 2968: 10/100 Mbps Ethernet Tx PCI (Type 9-P)	Max 8 per system for connectivity, see note 2

Table 16. 7026 Model H50 (continued)

Adapter	Usage
FC 2742: SysKonnnect SK-NET FDDI-LP DAS PCI (Type *)	See note 2
FC 2741: SysKonnnect SK-NET FDDI-LP SAS PCI (Type *)	See note 2
FC 2743: SysKonnnect SK-NET FDDI-UP SAS PCI (Type *)	Any slot Max. 4 per system
FC 2988: TURBOWAYS 155 PCI MMF ATM (Type 9-F)	See notes 2 and 9
FC 2946: PCI TURBOWAYS 622 PCI MMF ATM (Type A-B)	Max. of 9 in slots 1P, 2P, 3P, 6P, 4P, 7P,5P, 8P/I, 9P/I (see notes 5 on page 87 and 6 on page 87)
FC 2963: TURBOWAYS 155 PCI UTP ATM (Type 9-J)	Max 4, see note 2
FC 2987: Ethernet 10base5 PCI (Type 8-Z)	Any slot Max. 9 per system
FC 2985: Ethernet 10base2 PCI (Type 8-Y)	Any slot Max. 9 per system
FC 4959: High-Speed Token Ring PCI (Type 9-Y)	Any slot
FC 2979: PCI Auto LANstreamer Token Ring (Type 8-T)	Any slot Max. 9 per system
FC 2920: 16Mbps PCI Token-Ring (Type 9-0)	Any slot Max. 9 per system
FC 2962: 2-Port Multiprotocol PCI (Types 9-L and 9-V)	Any slot Max. 9 per system
FC 2493: PCI SCSI-2 Fast/Wide RAID (Type 4-H)	Any slot Max. 3 per system
FC 3131: RAID INT Port to EXT Connector Cable	Any slot
FC 2944: 128-Port Async Controller PCI (Type 3-C)	Any slot Max. 9 per system
FC 2708: ISDN Basic Rate PCI (Type 9-N)	Any slot Max. 9 per system
FC 2998: TURBOWAYS 25 ATM PCI (Type *)	Any slot Max. 9 per system

Table 16. 7026 Model H50 (continued)

Adapter	Usage
FC 2943: 8-Port Asynchronous EIA-232E/RS-422A PCI (Type 3-B)	Any slot Max. 8 per system
FC 6207: PCI Differential Ultra SCSI (Type 4-L)	Any slot Max. 9 per system
FC 6208 + 2445: EB+,SE SCSI (w/int.drives)	Any slot Max. 9 per system
FC 2947: IBM ARTIC960Hx 4-Port Selectable PCI (Type 9-R)	Any slot Max. 7 per system
FC 2948: IBM ARTIC960 4-Port T1/E1 PCI (Type 9-S)	Any slot Max. 7 per system
FC 2949: IBM ARTIC960 Hx DSP Resource PCI (Type 9-T)	Any slot Max. 7 per system
FC 2741: SysKonnnect SK-NET FDDI-LP SAS PCI (Type *)	See note 2

Notes:

1. A FC 6215: PCI SSA Multi-Initiator/RAID EL (Type 4-N) adapter *cannot* be plugged into a slot adjacent to a slot occupied by a full length adapter.
2. For optimum system performance, the 7026 Model H50 supports any combination of the following adapters, but that *combination* cannot exceed a total of four per system. The *combination* should not exceed two of these adapters per PCI bus.
 - FC 2988: TURBOWAYS 155 PCI MMF ATM (Type 9-F)
 - FC 2963: TURBOWAYS 155 PCI UTP ATM (Type 9-J)
 - FC 2986: 10/100 Mbps PCI Fast Etherlink XL (Type *)
 - FC 2968: 10/100 Mbps Ethernet Tx PCI (Type 9-P)
 - FC 2493: PCI SCSI-2 Fast/Wide RAID (Type 4-H)
 - FC 2742: SysKonnnect SK-NET FDDI-LP DAS PCI (Type *)
 - FC 2741: SysKonnnect SK-NET FDDI-LP SAS PCI (Type *)
 - FC 2743: SysKonnnect SK-NET FDDI-UP SAS PCI (Type *)
3. The 7026 Model H50 supports any combination of the following adapters, but that *combination* cannot exceed a total of seven:
 - FC 2947: IBM ARTIC960Hx 4-Port Selectable PCI (Type 9-R)
 - FC 2948: IBM ARTIC960 4-Port T1/E1 PCI (Type 9-S)
 - FC 2949: IBM ARTIC960 Hx DSP Resource PCI (Type 9-T)
 - FC 2751: S/390 ESCON Channel (Type 5-5)
 - FC 6309: Digital Trunk Quad PCI (Type 6-B)
4. The 7026 Model H50 supports any combination of the following adapters, but that *combination* cannot exceed a total of three:
 - FC 6309: Digital Trunk Quad PCI (Type 6-B)
 - FC 2751: S/390 ESCON Channel (Type 5-5)

5. For optimum system performance, the combination of the following adapters should not exceed a maximum of one adapter per bus:
 - FC 6215: PCI SSA Multi-Initiator/RAID EL (Type 4-N)
 - FC 6225: Advanced SSA SerialRAID (Type 4-P)
 - FC 6230: Advanced SerialRAID Plus (Type 4-P)
 - FC 2494: PCI 3-Channel Ultra2 SCSI RAID (Type 4-T)
 - FC 2969: Gigabit Ethernet Fibre, 1000BaseT
 - FC 2732, 2733: Serial HIPPI PCI (Types 9-W and 9-X)
 - FC 2975: Gigabit Ethernet (UTP) 1000BaseT
 - FC 2946: PCI TURBOWAYS 622 PCI MMF ATM (Type A-B)
6. For optimum system performance, a *combination* of the following adapters should not exceed a maximum of one adapter per system:
 - FC 2969: Gigabit Ethernet Fibre, 1000BaseT
 - FC 2975: Gigabit Ethernet (UTP) 1000BaseT
 - FC 2946: PCI TURBOWAYS 622 PCI MMF ATM (Type A-B)
7. For optimum system performance, a maximum of 4 FC 6205: PCI Dual Channel Ultra2 SCSI (Type 4-R) adapters is recommended.
8. Do not install the FC 2494: PCI 3-Channel Ultra2 SCSI RAID (Type 4-T) adapter on the PCI Bus with the Service Processor card.
9. Do not install a FC 2988: TURBOWAYS 155 PCI MMF ATM (Type 9-F) or FC 2968: 10/100 Mbps Ethernet Tx PCI (Type 9-P) adapter in the slot to the right (looking from the rear) of the FC 2751: S/390 ESCON Channel (Type 5-5) adapter.
10. If you install an additional FC 6227: Gigabit Fibre Channel PCI (Type 4-S), put it in slots 3P, 4P, or 5P. Install a third FC 6227: Gigabit Fibre Channel PCI (Type 4-S) in slot 8P, making sure that slot 7P is not occupied.
11. Do not install a FC 6205: PCI Dual Channel Ultra2 SCSI (Type 4-R) Adapter on the same PCI bus as a FC 2838: POWER GXT120P (Type 1-P) or FC 2830: POWER GXT130P (Type 1-T).
12. The FC 6205: PCI Dual Channel Ultra2 SCSI (Type 4-R) provides two (2) internal SCSI (P-Type) connectors, which allow it to drive two (2) internal SCSI 6-pack backplanes. This attachment will require the use of two (2) SCSI cables (FC 2447 / FBM 40H0036) from the Ultra-2 SCSI adapter to each of the two 6-pack backplanes.
13. For optimum system performance using the FC 4951: 10/100 4-Port Ethernet (Type 9-Z) adapter in 100 Mbps mode, use only two of the four ports. Install a maximum of two adapters per system, putting each on its own PCI bus.

Chapter 14. 7026 Model H70

This system is designed for service representatives to install adapters. Use this guide to determine if there are specific slot requirements for adapters that your service representative may be installing.

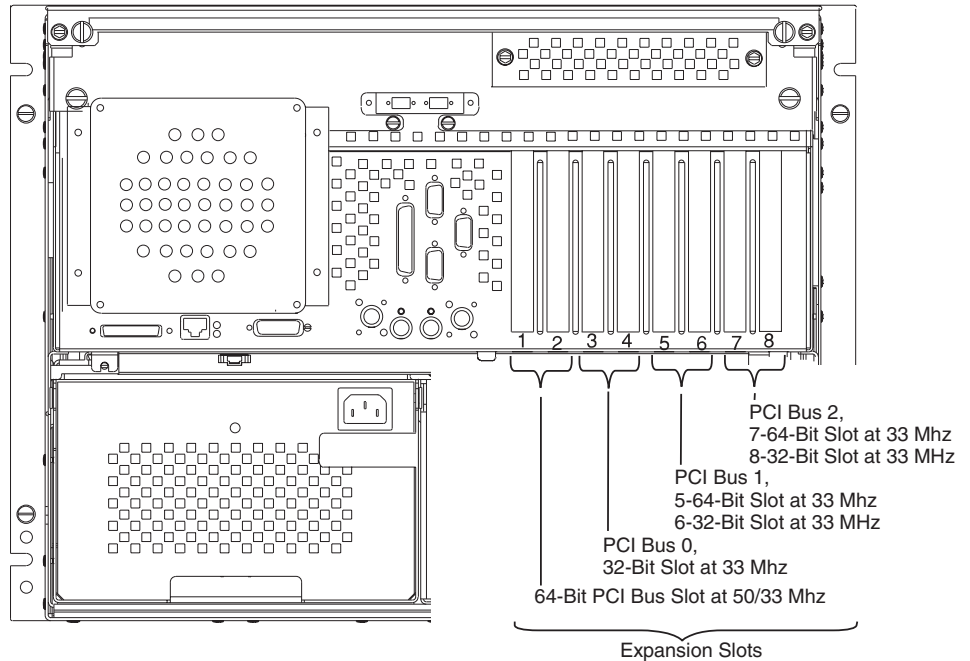

System Unit Rear View with Numbered Slots

Some adapters must be placed in specific system unit slots to function correctly at optimum performance. Use the table under “7026 Model H70 Adapter Placement Guide” on page 90 to determine where to install an adapter in your system unit.

Many of the following notes refer to optimizing system performance. Read “System Performance” on page 1 for more performance-related information.

Use the rear-view diagram above to identify slot locations described in the following tables.

7026 Model H70 Adapter Placement Guide

Use the following table to identify specific slot location options for the following adapters in your 7026 Model H70 system.

Table 17. 7026 Model H70

Adapter	Slot Usage	System Maximum
FC 2969: Gigabit Ethernet Fibre, 1000BaseT	Slots 1, 5, 2, 7	4 (see notes 3, 6, 13, 15, and 16)
FC 2975: Gigabit Ethernet (UTP) 1000BaseT	Slots 1, 5, 2, 7	4 (see notes 1 on page 93, 3 on page 94, 6 on page 94, and 13 on page 95)
FC 6230: Advanced SerialRAID Plus (Type 4-P) FC 6230+6231: 4 Port SSA 40 w/128MB DIMM FC 6235: Fast Write Cache Option for FC 6230	Any slot	4 (see note 3 and 16)
FC 6225: Advanced SSA SerialRAID (Type 4-P)	Any slot	4 (see note 3 and 16)
FC 6231: 128 MB DIMM for FC 6230	Plugs into FC 6225 or 6230	1
FC 6215: PCI SSA Multi-Initiator/RAID EL (Type 4-N)	Any slot (see notes 5 and 3)	4
FC 6222: 4-Port, SSA-RAID1 Fast Write Cache Option (Type 4-N)	Plugs into FC 6215	1
FC 6227: Gigabit Fibre Channel PCI (Type 4-S)	Slot 3 or 4 (see notes 10 and 16)	4
FC 6228: Gigabit Fibre Channel Adapter, 32 or 64-bit PCI Bus (Type 4-W)	Slot 3 or 4	4
FC 2732, 2733: Serial HIPPI PCI (Types 9-W and 9-X)	Any slot (see note 3)	2
FC 2494: PCI 3-Channel Ultra2 SCSI RAID (Type 4-T)	Any slot (see notes 3, 8, and 16)	4

Table 17. 7026 Model H70 (continued)

Adapter	Slot Usage	System Maximum
FC 2498: PCI 4-Channel Ultra3 SCSI RAID (Type 4-X)	Any slot	4
FC 4958: Cryptographic Coprocessor	Do not install in slots 3 or 4	4
FC 4951: 10/100 4-Port Ethernet (Type 9-Z)	1, 5, 7, 3	8 (see note 19 on page 96)
FC 2968: 10/100 Mbps Ethernet Tx PCI (Type 9-P)	Any slot	8 (see note 1)
FC 4962: Ethernet/LAN Encryption 10/100BaseT	Any slot	8 (see note 1 on page 93 and note 9 on page 94)
FC 2742: SysKonnnect SK-NET FDDI-LP DAS PCI (Type *)	Any slot	8
FC 2741: SysKonnnect SK-NET FDDI-LP SAS PCI (Type *)	Any slot	8
FC 2743: SysKonnnect SK-NET FDDI-UP SAS PCI (Type *)	Any slot	8
FC 2988: TURBOWAYS 155 PCI MMF ATM (Type 9-F)	Any slot	8 (see notes 1 and 9)
FC 4957: 64-bit/66MHz PCI ATM 155 MMF (Type A-D)	Any slot	8 (see notes 1 and 9)
FC 2946: PCI TURBOWAYS 622 PCI MMF ATM (Type A-B)	Slots 1, 5, 7, 2, 3, 6, 8, 4	8 (see notes 3 on page 94, 12 on page 95, and 6 on page 94)
FC 2963: TURBOWAYS 155 PCI UTP ATM (Type 9-J)	Any slot	8 (see note 1 and 9)
FC 4953: 64-bit/66MHz PCI ATM 155 UTP (Type A-C)	Any slot	8 (see notes 1 and 9)
FC 2751: S/390 ESCON Channel (Type 5-5)	Any slot (see notes 4 and 9)	3 (see note 2)
FC 2947: IBM ARTIC960Hx 4-Port Selectable PCI (Type 9-R)	Any slot	7 (see note 2)

Table 17. 7026 Model H70 (continued)

Adapter	Slot Usage	System Maximum
FC 2948: IBM ARTIC960 4-Port T1/E1 PCI (Type 9-S)	Any slot	7 (see note 2)
FC 2949: IBM ARTIC960 Hx DSP Resource PCI (Type 9-T)	Any slot	7 (see note 2)
FC 2830: POWER GXT130P (Type 1-T) or FC 2838: POWER GXT120P (Type 1-P)	Any slot (see notes 3 and 11)	2
FC 6207: PCI Differential Ultra SCSI (Type 4-L)	Any slot	8
FC 6205: PCI Dual Channel Ultra2 SCSI (Type 4-R)	Any slot (see note 11 and 18)	8 (see note 7)
FC 6203: Dual-Channel Ultra3 SCSI (Type 4-Y)	Any slot	8 (see note 7)
FC 6206: Single-Ended Ultra SCSI Adapter (Type 4-K)	Any slot	8
FC 4959: High-Speed Token Ring PCI (Type 9-Y)	Any slot	8
FC 2920: 16Mbps PCI Token-Ring (Type 9-0)	Any slot	8
FC 2962: 2-Port Multiprotocol PCI (Types 9-L and 9-V)	Any slot	8
FC 2944: 128-Port Async Controller PCI (Type 3-C)	Any slot	8
FC 2708: ISDN Basic Rate PCI (Type 9-N)	Any slot	1
FC 2943: 8-Port Asynchronous EIA-232E/RS-422A PCI (Type 3-B)	Any slot	8
FC 6310: IBM ARTIC960 RxD Quad Digital Trunk PCI (Type 6-E)	Any slot see "Chapter 29. Digital Trunk PCI Adapter Placement Considerations" on page 185 and note 17	4
FC 6208: PCI SCSI-2 Single Ended Fast/Wide (Type 4-A)	Any slot	8

Table 17. 7026 Model H70 (continued)

Adapter	Slot Usage	System Maximum
FC 6209: PCI SCSI-2 Differential Fast/Wide (Type 4-B)	Any slot	8
FC 2979: PCI Auto LANstreamer Token Ring (Type 8-T)	Any slot	8
FC 2985: Ethernet 10base2 PCI (Type 8-Y)	Any slot	8
FC 2987: Ethernet 10base5 PCI (Type 8-Z)	Any slot	8
FC 2988: TURBOWAYS 155 PCI MMF ATM (Type 9-F)	Any slot	8
FC 6309: Digital Trunk Quad PCI (Type 6-B)	Any slot	3 (see note 2)

Notes:

- For optimum performance the 7026 Model H70 supports any combination of the following adapters, but that *combination* should not exceed a total of six per system:
 - FC 2988: TURBOWAYS 155 PCI MMF ATM (Type 9-F), when used in LAN emulation (LANE) mode.
 - FC 2963: TURBOWAYS 155 PCI UTP ATM (Type 9-J), when used in LAN emulation (LANE) mode.
 - FC 4953: 64-bit/66MHz PCI ATM 155 UTP (Type A-C), when used in LAN emulation (LANE) mode.
 - FC 4957: 64-bit/66MHz PCI ATM 155 MMF (Type A-D), when used in LAN emulation (LANE) mode.
 - FC 2975: Gigabit Ethernet (UTP) 1000BaseT, when used in 100 Mbps mode
 - FC 2968: 10/100 Mbps Ethernet Tx PCI (Type 9-P), when used in 100 Mbps mode. If the integrated 10/100 Mbps controller is also being used at 100 Mbps, then the number of FC 2968: 10/100 Mbps Ethernet Tx PCI (Type 9-P) should be limited to five.
 - FC 4962: Ethernet/LAN Encryption 10/100BaseT, when used in 100 Mbps mode. If the integrated 10/100 Mbps controller is also being used at 100 Mbps, then the number of FC 4962: Ethernet/LAN Encryption 10/100BaseT should be limited to five.
- The 7026 Model H70 supports any combination of the following adapters, but that *combination* cannot exceed a total of seven:
 - FC 2948: IBM ARTIC960 4-Port T1/E1 PCI (Type 9-S)
 - FC 2969: Gigabit Ethernet Fibre, 1000BaseT
 - FC 6225: Advanced SSA SerialRAID (Type 4-P)
 - FC 6230: Advanced SerialRAID Plus (Type 4-P)
 - FC 6227: Gigabit Fibre Channel PCI (Type 4-S)
 - FC 2494: PCI 3-Channel Ultra2 SCSI RAID (Type 4-T)
 - FC 2947: IBM ARTIC960Hx 4-Port Selectable PCI (Type 9-R)

- FC 2949: IBM ARTIC960 Hx DSP Resource PCI (Type 9-T)
 - FC 2751: S/390 ESCON Channel (Type 5-5)
 - FC 6309: Digital Trunk Quad PCI (Type 6-B)
3. For optimum performance, the combination of the following adapters should not exceed one per PCI bus:
 - FC 2969: Gigabit Ethernet Fibre, 1000BaseT
 - FC 6225: Advanced SSA SerialRAID (Type 4-P)
 - FC 6230: Advanced SerialRAID Plus (Type 4-P)
 - FC 2494: PCI 3-Channel Ultra2 SCSI RAID (Type 4-T)
 - FC 6215: PCI SSA Multi-Initiator/RAID EL (Type 4-N)
 - FC 2732, 2733: Serial HIPPI PCI (Types 9-W and 9-X)
 - FC 2975: Gigabit Ethernet (UTP) 1000BaseT
 - FC 2946: PCI TURBOWAYS 622 PCI MMF ATM (Type A-B)
 - FC 2830: POWER GXT130P (Type 1-T)
 - FC 2838: POWER GXT120P (Type 1-P)
 4. The 7026 Model H70 supports any combination of the following adapters, but only one of these adapters can be installed in slots 5 and 6.
 - FC 2751: S/390 ESCON Channel (Type 5-5)
 - FC 6309: Digital Trunk Quad PCI (Type 6-B)
 5. A FC 6215: PCI SSA Multi-Initiator/RAID EL (Type 4-N) adapter *cannot* be plugged into a slot adjacent to a slot occupied by a full length adapter.
 6. For optimum system performance, a *combination* of the following adapters should not exceed a maximum of two adapters per system:
 - FC 2969: Gigabit Ethernet Fibre, 1000BaseT
 - FC 2975: Gigabit Ethernet (UTP) 1000BaseT
 - FC 2946: PCI TURBOWAYS 622 PCI MMF ATM (Type A-B)
 7. For optimum system performance a maximum of 4 FC 6205: PCI Dual Channel Ultra2 SCSI (Type 4-R) or FC 6203: Dual-Channel Ultra3 SCSI (Type 4-Y) adapters is recommended.
 8. Do not install the FC 2494: PCI 3-Channel Ultra2 SCSI RAID (Type 4-T) adapter on the PCI Bus with the Service Processor card.
 9. Do not install the following adapters in the slot to the right (looking from the rear) of the FC 2751: S/390 ESCON Channel (Type 5-5) adapter:
 - FC 2988: TURBOWAYS 155 PCI MMF ATM (Type 9-F)
 - FC 2968: 10/100 Mbps Ethernet Tx PCI (Type 9-P)
 - FC 4953: 64-bit/66MHz PCI ATM 155 UTP (Type A-C)
 - FC 4957: 64-bit/66MHz PCI ATM 155 MMF (Type A-D)
 - FC 2963: TURBOWAYS 155 PCI UTP ATM (Type 9-J)
 - FC 4962: Ethernet/LAN Encryption 10/100BaseT
 10. Install a second FC 6227: Gigabit Fibre Channel PCI (Type 4-S) in slots 1 or 2. Put a third FC 6227: Gigabit Fibre Channel PCI (Type 4-S) in slot 5. Install a fourth FC 6227: Gigabit Fibre Channel PCI (Type 4-S) in slot 8, making sure that slot 7 is not occupied.

11. Do not install a FC 6205: PCI Dual Channel Ultra2 SCSI (Type 4-R) Adapter in the same PCI bus as a FC 2838: POWER GXT120P (Type 1-P) or a FC 2830: POWER GXT130P (Type 1-T).
12. For optimum system performance, a maximum of one FC 2946: PCI TURBOWAYS 622 PCI MMF ATM (Type A-B) adapter per bus is recommended, and should be placed in 64-bit slots.
13. For optimum system performance, a maximum of one FC 2975: Gigabit Ethernet (UTP) 1000BaseT adapter per system is recommended when configured to run at 1000 Mbps. If available, install in slots 1, 5, 2, or 7 (in that order).
If your adapter is configured for 100 Mbps mode, use up to six adapters for optimum performance.
14. For optimum system performance, install up to six FC 2968: 10/100 Mbps Ethernet Tx PCI (Type 9-P) adapters in 100 Mbps mode.
15. If there are less than 8 total adapters, place the first FC 2969: Gigabit Ethernet Fibre, 1000BaseT in slot 1 and leave slot 2 empty. If there are 8 total adapters and there are multiple FC 2969, place the FC 2969 adapters in slot 1 and slot 2.
16. For optimum system performance, a *combination* of the following adapters should not exceed a maximum of four adapters per system:
 - FC 2969: Gigabit Ethernet Fibre, 1000BaseT
 - FC 6225: Advanced SSA SerialRAID (Type 4-P)
 - FC 6230: Advanced SerialRAID Plus (Type 4-P)
 - FC 6227: Gigabit Fibre Channel PCI (Type 4-S)
 - FC 2494: PCI 3-Channel Ultra2 SCSI RAID (Type 4-T)These adapters should be placed one per bus, if possible.
17. If multiple FC 6310: IBM ARTIC960 RxD Quad Digital Trunk PCI (Type 6-E) and FC 6311: IBM ARTIC960 RxF PCI (Type 6-G) adapters are on the order, FC 2877: Quad DTA, H.100, 4-Drop Cable or FC 4353: Internal H100 BUS, 8-Position Cable must be used to connect FC 6310 and FC 6311.

18. The FC 6205: PCI Dual Channel Ultra2 SCSI (Type 4-R) provides two (2) internal SCSI (P-Type) connectors, which allow it to drive two (2) internal SCSI 6-pack backplanes. This attachment will require the use of two (2) SCSI cables (FC 2447 / FBM 40H0036) from the FC 6205 adapter to each of the two 6-pack backplanes.
19. For optimum system performance using the FC 4951: 10/100 4-Port Ethernet (Type 9-Z) adapter, use only 2 of the 4 ports and a maximum of 2 adapters per system. Install on separate PCI buses.

Chapter 15. 7026 Model H80

This system is designed for customers to install adapters. Use this guide to determine if there are specific slot requirements for adapters that you may be installing.

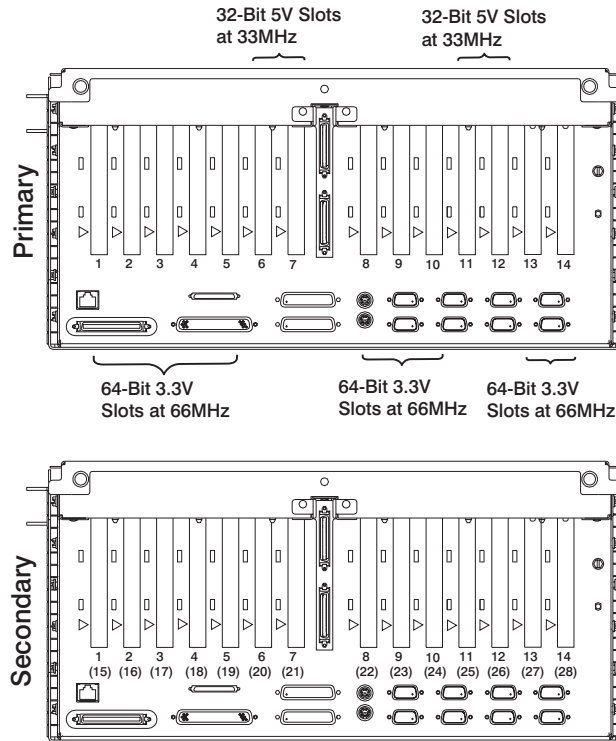

System Unit Rear View with Numbered Slots

Note: The 7026 Model H80 has three PCI buses, with Slots 1-4 on a bus, Slots 5-9 on a bus, and Slots 10-14 on a bus.

Some adapters must be placed in specific system unit slots to function correctly at optimum performance. Use the table under "7026 Model H80 Adapter Placement Guide" on page 98 to determine where to install an adapter in your system unit.

Many of the following notes refer to optimizing system performance.

Use the rear-view diagram above to identify slot locations described in the following tables.

7026 Model H80 Adapter Placement Guide

Use the following table to identify specific slot location options for the following adapters in your 7026 Model H80 system. The slot placement is handled as if the slots were numbered 1 - 28 with 1 - 14 primary and 15 - 28 secondary. The slot labeled 1 in the secondary will be labeled 15 for this table. This is necessary to place more High Performance adapters in the secondary drawer when present. This is a performance issue unique to the H80 system.

If a table row lists more than one adapter, the adapters may be mixed, but the total number of adapters in the combination cannot exceed the number stated in the Maximum column.

Note: The adapters with the highest slot placement priority are listed at the top of the table. The slot numbers in the Slot Usage column represent slot-location priorities. Use the first numbered slot first. If an adapter has already filled the first slot in the list, go to the next number in the list.

Note: Adapters listed as "(Supported)" may be incorporated from MES upgrades. They will operate in the H80 system but have lower performance characteristics than newer adapters.

Table 18. 7026 Model H80

Adapter	Slot Usage	Maximum per Drawer/System	Hot-Pluggable?
FC 6310: IBM ARTIC960 RxD Quad Digital Trunk PCI (Type 6-E)	9, 11, 10, 12	4/4	N (see notes 1 on page 102 and 4 on page 103)
FC 6311: IBM ARTIC960 RxF PCI (Type 6-G)	9, 11, 10, 12	3/3 see "Chapter 29. Digital Trunk PCI Adapter Placement Considerations" on page 185	N (see notes 1 on page 102 and 4 on page 103)
FC 8396: SP System Attachment (Type 6-F)	Primary 6 only	1/1 (see note 3 on page 102)	N
FC 8397: SP Colony Switch Attach	5 and 3	2/2 (see note 13 on page 103)	N
FC 2946: PCI TURBOWAYS 622 PCI MMF ATM (Type A-B)	15, 19, 1, 24, 16, 5, 22, 18, 10, 27, 17, 2, 23, 28, 8, 4, 13, 3, 9, 14, 20, 25, 21, 26, 6, 11, 7, 12	10/20 (see note 14 on page 103)	Y

Table 18. 7026 Model H80 (continued)

Adapter	Slot Usage	Maximum per Drawer/System	Hot-Pluggable?
FC 6228: Gigabit Fibre Channel Adapter, 32 or 64-bit PCI Bus (Type 4-W)	15, 19, 1, 24, 16, 5, 22, 18, 10, 27, 17, 2, 23, 28, 8, 4, 13, 3, 9, 14, 20, 25, 21, 26, 6, 11, 7, 12	8/16	Y
FC 2975: Gigabit Ethernet (UTP) 1000BaseT	15, 19, 1, 24, 16, 5, 22, 18, 10, 27, 17, 2, 23, 28, 8, 4, 13, 3, 9, 14, 20, 25, 21, 26, 6, 11, 7, 12	10/20 (see notes 7 on page 103 and 11 on page 103)	Y
FC 2969: Gigabit Ethernet Fibre, 1000BaseT	15, 19, 1, 24, 16, 5, 22, 18, 10, 27, 17, 2, 23, 28, 8, 4, 13, 3, 9, 14, 20, 25, 21, 26, 6, 11, 7, 12	10/20 (see notes 7 on page 103 and 11 on page 103)	Y
FC 6205: PCI Dual Channel Ultra2 SCSI (Type 4-R) FC 6203: Dual-Channel Ultra3 SCSI (Type 4-Y) FC 2498: PCI 4-Channel Ultra3 SCSI RAID (Type 4-X)	15, 19, 1, 24, 16, 5, 22, 18, 10, 27, 17, 2, 23, 28, 8, 4, 13, 3, 9, 14, 20, 25, 21, 26, 6, 11, 7, 12	10/20	Y
FC 4958: Cryptographic Coprocessor RPQ 8A1162: Cryptographic Coprocessor	15, 19, 1, 24, 16, 5, 22, 18, 10, 27, 17, 2, 23, 28, 8, 4, 13, 3, 9, 14, 20, 25, 21, 26, 6, 11, 7, 12	4/4 (see note 5 on page 103)	Y
FC 4960: IBM Cryptographic Accelerator (Type 6-J)	15, 19, 1, 24, 16, 5, 22, 18, 10, 27, 17, 2, 23, 28, 8, 4, 13, 3, 9, 14, 20, 25, 21, 26, 6, 11, 7, 12	4/4	Y
FC 6204: PCI Universal Differential Ultra SCSI (Type 4-U)	15, 19, 1, 24, 16, 5, 22, 18, 10, 27, 17, 2, 23, 28, 8, 4, 13, 3, 9, 14, 20, 25, 21, 26, 6, 11, 7, 12	10/20	Y
FC 6227: Gigabit Fibre Channel PCI (Type 4-S)	15, 19, 1, 24, 16, 5, 22, 18, 10, 27, 17, 2, 23, 28, 8, 4, 13, 3, 9, 14, 20, 25, 21, 26, 6, 11, 7, 12	8/16	Y

Table 18. 7026 Model H80 (continued)

Adapter	Slot Usage	Maximum per Drawer/System	Hot-Pluggable?
FC 4961: 10/100 4-Port Ethernet (Type A-E)	15, 19, 1, 24, 16, 5, 22, 18, 10, 27, 17, 2, 23, 28, 8, 4, 13, 3, 9, 14, 20, 25, 21, 26, 6, 11, 7, 12	10/20 (see notes 10 on page 103 and 11 on page 103)	Y
FC 6230: Advanced SerialRAID Plus (Type 4-P) FC 6230+6231: 4 Port SSA 40 w/128MB DIMM FC 6235: Fast Write Cache Option for FC 6230	15, 19, 1, 24, 16, 5, 22, 18, 10, 27, 17, 2, 23, 28, 8, 4, 13, 3, 9, 14, 20, 25, 21, 26, 6, 11, 7, 12	8/16	Y
FC 6225: Advanced SSA SerialRAID (Type 4-P) (Supported)	15, 19, 1, 24, 16, 5, 22, 18, 10, 27, 17, 2, 23, 28, 8, 4, 13, 3, 9, 14, 20, 25, 21, 26, 6, 11, 7, 12	4/4	N
FC 2741: SysKonnnect SK-NET FDDI-LP SAS PCI (Type *) FC 2742: SysKonnnect SK-NET FDDI-LP DAS PCI (Type *) FC 2743: SysKonnnect SK-NET FDDI-UP SAS PCI (Type *)	15, 19, 1, 24, 16, 5, 22, 18, 10, 27, 17, 2, 23, 28, 8, 4, 13, 3, 9, 14, 20, 25, 21, 26, 6, 11, 7, 12	14/28 (see notes 8 on page 103 and 11 on page 103)	Y
FC 2848: GXT135P Graphics Adapter (Type 1-X)	15, 19, 1, 24, 16, 5, 22, 18, 10, 27, 17, 2, 23, 28, 8, 4, 13, 3, 9, 14, 20, 25, 21, 26, 6, 11, 7, 12	1/1	N
FC 2943: 8-Port Asynchronous EIA-232E/RS-422A PCI (Type 3-B)	15, 19, 1, 24, 16, 5, 22, 18, 10, 27, 17, 2, 23, 28, 8, 4, 13, 3, 9, 14, 20, 25, 21, 26, 6, 11, 7, 12	14/28	Y
FC 2944: 128-Port Async Controller PCI (Type 3-C)	15, 19, 1, 24, 16, 5, 22, 18, 10, 27, 17, 2, 23, 28, 8, 4, 13, 3, 9, 14, 20, 25, 21, 26, 6, 11, 7, 12	14/28	Y

Table 18. 7026 Model H80 (continued)

Adapter	Slot Usage	Maximum per Drawer/System	Hot-Pluggable?
FC 2947: IBM ARTIC960Hx 4-Port Selectable PCI (Type 9-R)	15, 19, 1, 24, 16, 5, 22, 18, 10, 27, 17, 2, 23, 28, 8, 4, 13, 3, 9, 14, 20, 25, 21, 26, 6, 11, 7, 12	14/14	Y
FC 2962: 2-Port Multiprotocol PCI (Types 9-L and 9-V)	15, 19, 1, 24, 16, 5, 22, 18, 10, 27, 17, 2, 23, 28, 8, 4, 13, 3, 9, 14, 20, 25, 21, 26, 6, 11, 7, 12 see note 2 on page 102	5/10	N
FC 2963: TURBOWAYS 155 PCI UTP ATM (Type 9-J) FC 2988: TURBOWAYS 155 PCI MMF ATM (Type 9-F)	15, 19, 1, 24, 16, 5, 22, 18, 10, 27, 17, 2, 23, 28, 8, 4, 13, 3, 9, 14, 20, 25, 21, 26, 6, 11, 7, 12	7/7 (see notes 6 on page 103 and 11 on page 103)	Y
FC 4953: 64-bit/66MHz PCI ATM 155 UTP (Type A-C) FC 4957: 64-bit/66MHz PCI ATM 155 MMF (Type A-D)	15, 19, 1, 24, 16, 5, 22, 18, 10, 27, 17, 2, 23, 28, 8, 4, 13, 3, 9, 14, 20, 25, 21, 26, 6, 11, 7, 12	14/7 (see notes 6 on page 103 and 11 on page 103)	Y
FC 2968: 10/100 Mbps Ethernet Tx PCI (Type 9-P)	15, 19, 1, 24, 16, 5, 22, 18, 10, 27, 17, 2, 23, 28, 8, 4, 13, 3, 9, 14, 20, 25, 21, 26, 6, 11, 7, 12	14/14 (see notes 9 on page 103 and 11 on page 103)	Y
FC 4962: Ethernet/LAN Encryption 10/100BaseT	15, 19, 1, 24, 16, 5, 22, 18, 10, 27, 17, 2, 23, 28, 8, 4, 13, 3, 9, 14, 20, 25, 21, 26, 6, 11, 7, 12	14/14 (see notes 9 on page 103 and 11 on page 103)	Y
FC 4959: High-Speed Token Ring PCI (Type 9-Y)	15, 19, 1, 24, 16, 5, 22, 18, 10, 27, 17, 2, 23, 28, 8, 4, 13, 3, 9, 14, 20, 25, 21, 26, 6, 11, 7, 12	14/28	Y
FC 3154 Internal Attachment Card	7, 9, 2, 3, 4, 5, 8, 10, 13, 14, 11, 12	1/1 (see note 3 on page 102)	N

Table 18. 7026 Model H80 (continued)

Adapter	Slot Usage	Maximum per Drawer/System	Hot-Pluggable?
FC 2920: 16Mbps PCI Token-Ring (Type 9-0) (Supported)	15, 19, 1, 24, 16, 5, 22, 18, 10, 27, 17, 2, 23, 28, 8, 4, 13, 3, 9, 14, 20, 25, 21, 26, 6, 11, 7, 12	8/8	N
FC 2979: PCI Auto LANstreamer Token Ring (Type 8-T) (Supported)	15, 19, 1, 24, 16, 5, 22, 18, 10, 27, 17, 2, 23, 28, 8, 4, 13, 3, 9, 14, 20, 25, 21, 26, 6, 11, 7, 12	8/8	N
FC 2494: PCI 3-Channel Ultra2 SCSI RAID (Type 4-T)	6, 11, 7, 12, 20, 25, 21, 26	4/8	Y
FC 6215: PCI SSA Multi-Initiator/RAID EL (Type 4-N) (Supported)	6, 11, 7, 12, 20, 25, 21, 26	4/4	N
FC 2838: POWER GXT120P (Type 1-P) (Supported)	20, 25, 21, 26, 6, 11, 7, 12	1/1	N
FC 6206: Single-Ended Ultra SCSI Adapter (Type 4-K) (Supported)	6, 11, 7, 12, 20, 25, 21, 2	4/8	Y
FC 6207: PCI Differential Ultra SCSI (Type 4-L) (Supported)	6, 11, 7, 12, 20, 25, 21, 26	4/8 (see note 12 on page 103)	Y
FC 2708: ISDN Basic Rate PCI (Type 9-N)	6, 11, 7, 12, 20, 25, 21, 26	1/1	Y
FC 2751: S/390 ESCON Channel (Type 5-5)	6, 11, 7, 12, 20, 25, 21, 26	2/4	Y
FC 2830: POWER GXT130P (Type 1-T)	6, 11, 7, 12, 20, 25, 21, 26	1/1	N

Notes:

1. FC 6311: IBM ARTIC960 RxF PCI (Type 6-G) requires FC 6310: IBM ARTIC960 RxD Quad Digital Trunk PCI (Type 6-E) to function.
2. Adapter migration may require the use of a 5V slot.
3. FC 3154 Internal Attachment Card must have FC 2968: 10/100 Mbps Ethernet Tx PCI (Type 9-P) installed in primary slot 1 in the system. FC 8396: SP System Attachment (Type 6-F) must have FC 3154 Internal Attachment Card installed in the system. FC 8396 must be placed in slot 6, FC 3154 in slot 7, and FC 2968 in slot 1 (see respective adapter instructions). The FC 8396 and FC 3154 adapters are not recognized without PSSP software, except by HTX.

4. One FC 2877 (Quad DTXA, H.100, 4-Drop Cable) or FC 4353 (8-Drop Cable) is required to connect FC 6310 and/or FC 6311 if more than one is ordered. FC 6311 or additional FC 6310 adapters must be interconnected for proper operation. When connected, FC 6310 is not hot-pluggable.
5. A combined maximum of four FC 4958: Cryptographic Coprocessor and RPQ 8A1162: Cryptographic Coprocessor adapters are allowed per system.
6. A combined maximum of seven FC 2963: TURBOWAYS 155 PCI UTP ATM (Type 9-J), FC 2988: TURBOWAYS 155 PCI MMF ATM (Type 9-F), FC 4953: 64-bit/66MHz PCI ATM 155 UTP (Type A-C), and FC 4957: 64-bit/66MHz PCI ATM 155 MMF (Type A-D) adapters are allowed per system.
7. For optimum system performance, a maximum of two FC 2969: Gigabit Ethernet Fibre, 1000BaseT or FC 2975: Gigabit Ethernet (UTP) 1000BaseT adapters per system is recommended.
8. For optimum system performance, a maximum of 14 FC 2741: SysKconnect SK-NET FDDI-LP SAS PCI (Type *), FC 2742: SysKconnect SK-NET FDDI-LP DAS PCI (Type *), and FC 2743: SysKconnect SK-NET FDDI-UP SAS PCI (Type *) adapters per system and a maximum of seven FC 2741, FC 2742, and FC 2743 adapters per I/O drawer is recommended.
9. For optimum system performance, a maximum of eight FC 2968: 10/100 Mbps Ethernet Tx PCI (Type 9-P) or FC 4962: Ethernet/LAN Encryption 10/100BaseT adapters per system and a maximum of seven per I/O drawer is recommended.
10. For optimum system performance using the FC 4961: 10/100 4-Port Ethernet (Type A-E) on this system, use only 2 of the 4 ports if the ports will all be running at media speed. Use a maximum of six ports per system (i.e., 3 adapters running 2 ports each). Limit adapters to two per I/O drawer in 64-bit slots.
11. For optimum system performance, the combination of FC 2969: Gigabit Ethernet Fibre, 1000BaseT, FC 2741: SysKconnect SK-NET FDDI-LP SAS PCI (Type *), FC 2742: SysKconnect SK-NET FDDI-LP DAS PCI (Type *), FC 2743: SysKconnect SK-NET FDDI-UP SAS PCI (Type *), FC 2968: 10/100 Mbps Ethernet Tx PCI (Type 9-P), FC 4951: 10/100 4-Port Ethernet (Type 9-Z), FC 2963: TURBOWAYS 155 PCI UTP ATM (Type 9-J), FC 2988: TURBOWAYS 155 PCI MMF ATM (Type 9-F), FC 4953: 64-bit/66MHz PCI ATM 155 UTP (Type A-C), FC 4957: 64-bit/66MHz PCI ATM 155 MMF (Type A-D), FC 4962: Ethernet/LAN Encryption 10/100BaseT, and FC 2975: Gigabit Ethernet (UTP) 1000BaseT adapters cannot exceed 7 adapters per IO drawer.
12. The FC 6207: PCI Differential Ultra SCSI (Type 4-L) adapter is available on a platform system upgrade only. The adapter is not supported if the system is shipped as a new build or ordered as an MES.
13. Installation of FC 8397: SP Colony Switch Attach in slot 5 or 3 requires the removal of the adjacent plastic air guide in slot 6 or 4 respectively. The first FC 8397 must be installed in slot 5, FC 3154 Internal Attachment Card installed in slot 6, and FC 2968: 10/100 Mbps Ethernet Tx PCI (Type 9-P) installed in slot 1 (see respective adapter instructions). FC 8397 and FC 3154 are not recognized without PSSP software installed.
14. For optimum performance using FC 2946: PCI TURBOWAYS 622 PCI MMF ATM (Type A-B), limit adapters to the following:
 - MTU 1500: 1 per drawer, 2 per system

- MTU 9180: 2 per drawer, 3 per system

Chapter 16. 7026 Model M80

This system is designed for customers to install adapters. Use this guide to determine if there are specific slot requirements for adapters that you may be installing.

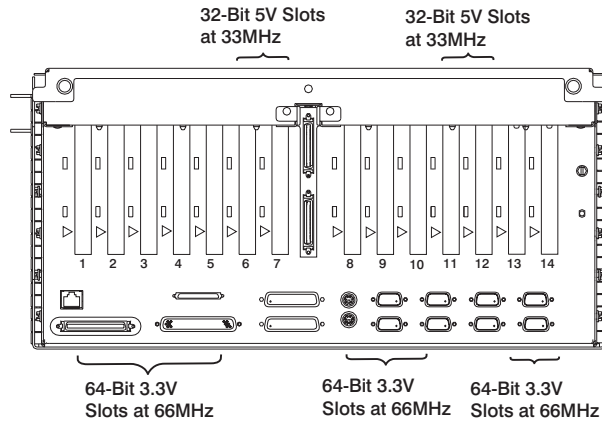

System Unit Rear View with Numbered Slots

Some adapters must be placed in specific system unit slots to function correctly at optimum performance. Use the table under "7026 Model M80 Adapter Placement Guide" to determine where to install an adapter in your system unit.

Use the rear-view diagram above to identify slot locations described in the following tables.

7026 Model M80 Adapter Placement Guide

Note: The 7026 Model M80 has three PCI buses, with Slots 1-4 on a bus, Slots 5-9 on a bus, and Slots 10-14 on a bus.

Use the following table to identify specific slot location options for the following adapters in your 7026 Model M80 system.

If a table row lists more than one adapter, the adapters may be mixed, but the total number of adapters in the combination cannot exceed the number stated in the Maximum column.

Note: The adapters with the highest slot placement priority are listed at the top of the table. The slot numbers in the Slot Usage column represent slot location priorities. Use the first numbered slot in the primary drawer first, then go to the secondary drawer(s) for the next adapter, spreading the adapters evenly across the drawers. If an adapter has already filled the first slot in the list, go to the next number in the list.

Note: Adapters listed as "(Supported)" may be incorporated from MES upgrades. They will operate in the M80 system but have lower performance characteristics than newer adapters.

Table 19. 7026 Model M80

Adapter	Slot Usage	Drawer/System Maximums	Hot-Pluggable?
FC 6310: IBM ARTIC960 RxD Quad Digital Trunk PCI (Type 6-E)	Primary 9, 11, 10, 12 Secondary 9, 11, 10, 12	4/4	N (see notes 1 on page 110 and 6 on page 111)
FC 6311: IBM ARTIC960 RxF PCI (Type 6-G)	Primary 9, 11, 10, 12 Secondary 9, 11, 10, 12	3/3 see "Chapter 29. Digital Trunk PCI Adapter Placement Considerations" on page 185	N (see notes 1 on page 110 and 6 on page 111)
FC 8396: SP System Attachment (Type 6-F)	Primary 6 only	1/1 (see note 3 on page 110)	N
FC 8397: SP Colony Switch Attach	5 and 3 (see note 14 on page 111)	2/2	N
FC 2946: PCI TURBOWAYS 622 PCI MMF ATM (Type A-B)	Primary 1, 5, 10, 2, 8, 4, 13, 3, 9, 14, 6, 11, 7, 12 Secondary 1, 5, 10, 2, 8, 4, 13, 3, 9, 14, 6, 11, 7, 12	10/20	Y
FC 6228: Gigabit Fibre Channel Adapter, 32 or 64-bit PCI Bus (Type 4-W)	Primary 1, 5, 10, 2, 8, 4, 13, 3, 9, 14, 6, 11, 7, 12 Secondary 1, 5, 10, 2, 8, 4, 13, 3, 9, 14, 6, 11, 7, 12	8/32 (see note 13 on page 111)	Y
FC 2975: Gigabit Ethernet (UTP) 1000BaseT	Primary 1, 5, 10, 2, 8, 4, 13, 3, 9, 14, 6, 11, 7, 12 Secondary 1, 5, 10, 2, 8, 4, 13, 3, 9, 14, 6, 11, 7, 12	10/20 (see notes 8 on page 111 and 12 on page 111)	Y

Table 19. 7026 Model M80 (continued)

Adapter	Slot Usage	Drawer/System Maximums	Hot-Pluggable?
FC 2969: Gigabit Ethernet Fibre, 1000BaseT	Primary 1, 5, 10, 2, 8, 4, 13, 3, 9, 14, 6, 11, 7, 12 Secondary 1, 5, 10, 2, 8, 4, 13, 3, 9, 14, 6, 11, 7, 12	10/20 (see notes 8 on page 111 and 12 on page 111)	Y
FC 2498: PCI 4-Channel Ultra3 SCSI RAID (Type 4-X) FC 6205: PCI Dual Channel Ultra2 SCSI (Type 4-R) FC 6203: Dual-Channel Ultra3 SCSI (Type 4-Y)	Primary 1, 5, 10, 2, 8, 4, 13, 3, 9, 14, 6, 11, 7, 12 Secondary 1, 5, 10, 2, 8, 4, 13, 3, 9, 14, 6, 11, 7, 12	10/20	Y
FC 4958: Cryptographic Coprocessor RPQ 8A1162: Cryptographic Coprocessor	Primary 1, 5, 10, 2, 8, 4, 13, 3, 9, 14, 6, 11, 7, 12 Secondary 1, 5, 10, 2, 8, 4, 13, 3, 9, 14, 6, 11, 7, 12	4/4 (see note 7 on page 111)	N
FC 4960: IBM Cryptographic Accelerator (Type 6-J)	Primary 1, 5, 10, 2, 8, 4, 13, 3, 9, 14, 6, 11, 7, 12 Secondary 1, 5, 10, 2, 8, 4, 13, 3, 9, 14, 6, 11, 7, 12	4/8	N
FC 6204: PCI Universal Differential Ultra SCSI (Type 4-U)	Primary 1, 5, 10, 2, 8, 4, 13, 3, 9, 14, 6, 11, 7, 12 Secondary 1, 5, 10, 2, 8, 4, 13, 3, 9, 14, 6, 11, 7, 12	10/40	Y
FC 6227: Gigabit Fibre Channel PCI (Type 4-S)	Primary 1, 5, 10, 2, 8, 4, 13, 3, 9, 14, 6, 11, 7, 12 Secondary 1, 5, 10, 2, 8, 4, 13, 3, 9, 14, 6, 11, 7, 12	8/32	Y

Table 19. 7026 Model M80 (continued)

Adapter	Slot Usage	Drawer/System Maximums	Hot-Pluggable?
FC 4961: 10/100 4-Port Ethernet (Type A-E)	Primary 1, 5, 10, 2, 8, 4, 13, 3, 9, 14, 6, 11, 7, 12 Secondary 1, 5, 10, 2, 8, 4, 13, 3, 9, 14, 6, 11, 7, 12	10/20 (see notes 11 on page 111 and 12 on page 111)	Y
FC 6230: Advanced SerialRAID Plus (Type 4-P) FC 6230+6231: 4 Port SSA 40 w/128MB DIMM FC 6235: Fast Write Cache Option for FC 6230	Primary 1, 5, 10, 2, 8, 4, 13, 3, 9, 14, 6, 11, 7, 12 Secondary 1, 5, 10, 2, 8, 4, 13, 3, 9, 14, 6, 11, 7, 12	8/32	Y
FC 2741: SysKonnnect SK-NET FDDI-LP SAS PCI (Type *) FC 2742: SysKonnnect SK-NET FDDI-LP DAS PCI (Type *) FC 2743: SysKonnnect SK-NET FDDI-UP SAS PCI (Type *)	Primary 1, 5, 10, 2, 8, 4, 13, 3, 9, 14, 6, 11, 7, 12 Secondary 1, 5, 10, 2, 8, 4, 13, 3, 9, 14, 6, 11, 7, 12	14/28 (see notes 9 on page 111 and 12 on page 111)	Y
FC 2848: GXT135P Graphics Adapter (Type 1-X)	Primary 1, 5, 10, 2, 8, 4, 13, 3, 9, 14, 6, 11, 7, 12 Secondary 1, 5, 10, 2, 8, 4, 13, 3, 9, 14, 6, 11, 7, 12	1/1	N
FC 2943: 8-Port Asynchronous EIA-232E/RS-422A PCI (Type 3-B)	Primary 1, 5, 10, 2, 8, 4, 13, 3, 9, 14, 6, 11, 7, 12 Secondary 1, 5, 10, 2, 8, 4, 13, 3, 9, 14, 6, 11, 7, 12	14/32 (see note 5 on page 111)	Y

Table 19. 7026 Model M80 (continued)

Adapter	Slot Usage	Drawer/System Maximums	Hot-Pluggable?
FC 2944: 128-Port Async Controller PCI (Type 3-C)	Primary 1, 5, 10, 2, 8, 4, 13, 3, 9, 14, 6, 11, 7, 12 Secondary 1, 5, 10, 2, 8, 4, 13, 3, 9, 14, 6, 11, 7, 12	14/32 (see note 5 on page 111)	Y
FC 2947: IBM ARTIC960Hx 4-Port Selectable PCI (Type 9-R)	Primary 1, 5, 10, 2, 8, 4, 13, 3, 9, 14, 6, 11, 7, 12 Secondary 1, 5, 10, 2, 8, 4, 13, 3, 9, 14, 6, 11, 7, 12	14/14	Y
FC 2962: 2-Port Multiprotocol PCI (Types 9-L and 9-V)	Primary 1, 5, 10, 2, 8, 4, 13, 3, 9, 14, 6, 11, 7, 12 Secondary 1, 5, 10, 2, 8, 4, 13, 3, 9, 14, 6, 11, 7, 12	5/20	N
FC 2963: TURBOWAYS 155 PCI UTP ATM (Type 9-J)	Primary 1, 5, 10, 2, 8, 4, 13, 3, 9, 14, 6, 11, 7, 12	7/7 (see notes 4 on page 110 and 12 on page 111)	Y
FC 2988: TURBOWAYS 155 PCI MMF ATM (Type 9-F)	Secondary 1, 5, 10, 2, 8, 4, 13, 3, 9, 14, 6, 11, 7, 12		
FC 4953: 64-bit/66MHz PCI ATM 155 UTP (Type A-C)	Primary 1, 5, 10, 2, 8, 4, 13, 3, 9, 14, 6, 11, 7, 12	14/28 (see notes 4 on page 110 and 12 on page 111)	Y
FC 4957: 64-bit/66MHz PCI ATM 155 MMF (Type A-D)	Secondary 1, 5, 10, 2, 8, 4, 13, 3, 9, 14, 6, 11, 7, 12		
FC 2968: 10/100 Mbps Ethernet Tx PCI (Type 9-P)	Primary 1, 5, 10, 2, 8, 4, 13, 3, 9, 14, 6, 11, 7, 12 Secondary 1, 5, 10, 2, 8, 4, 13, 3, 9, 14, 6, 11, 7, 12	14/28 (see notes 10 on page 111 and 12 on page 111)	Y
FC 4962: Ethernet/LAN Encryption 10/100BaseT	Primary 1, 5, 10, 2, 8, 4, 13, 3, 9, 14, 6, 11, 7, 12 Secondary 1, 5, 10, 2, 8, 4, 13, 3, 9, 14, 6, 11, 7, 12	14/28 (see notes 10 on page 111 and 12 on page 111)	Y

Table 19. 7026 Model M80 (continued)

Adapter	Slot Usage	Drawer/System Maximums	Hot-Pluggable?
FC 4959: High-Speed Token Ring PCI (Type 9-Y)	Primary 1, 5, 10, 2, 8, 4, 13, 3, 9, 14, 6, 11, 7, 12 Secondary 1, 5, 10, 2, 8, 4, 13, 3, 9, 14, 6, 11, 7, 12	14/28	Y
FC 3154 Internal Attachment Card	Primary 7, 9, 2, 3, 4, 5, 8, 10, 13, 14, 11, 12	1/1 (see note 3)	N
FC 2494: PCI 3-Channel Ultra2 SCSI RAID (Type 4-T)	Primary 6, 11, 7, 12 Secondary 6, 11, 7, 12	4/8	Y
FC 2708: ISDN Basic Rate PCI (Type 9-N)	Primary 6, 11, 7, 12 Secondary 6, 11, 7, 12	1/1	Y
FC 2751: S/390 ESCON Channel (Type 5-5)	Primary 6, 11, 7, 12 Secondary 6, 11, 7, 12 (see note 2)	2/4	Y
FC 2830: POWER GXT130P (Type 1-T)	Primary 6, 11, 7, 12 Secondary 6, 11, 7, 12	1/1	N
FC 6225: Advanced SSA SerialRAID (Type 4-P) (Supported)	Primary 1, 5, 10, 2, 8, 4, 13, 3, 9, 14, 6, 11, 7, 12 Secondary 1, 5, 10, 2, 8, 4, 13, 3, 9, 14, 6, 11, 7, 12	4/4	N

Notes:

1. FC 6311: IBM ARTIC960 RxF PCI (Type 6-G) requires FC 6310: IBM ARTIC960 RxD Quad Digital Trunk PCI (Type 6-E) to function.
2. If you have more than two drawers, do not install the FC 2751: S/390 ESCON Channel (Type 5-5) in drawer three or higher.
3. FC 3154 Internal Attachment Card must have FC 2968: 10/100 Mbps Ethernet Tx PCI (Type 9-P) installed in primary slot 1 in the system. FC 8396: SP System Attachment (Type 6-F) must have FC 3154 Internal Attachment Card installed in the system. FC 8396 must be placed in slot 6, FC 3154 in slot 7, and FC 2968 in slot 1 (see respective adapter instructions). The FC 8396 and FC 3154 adapters are not recognized without PSSP software, except by HTX.
4. A combined maximum of seven FC 2963: TURBOWAYS 155 PCI UTP ATM (Type 9-J), FC 2988: TURBOWAYS 155 PCI MMF ATM (Type 9-F), FC 4953: 64-bit/66MHz PCI ATM 155 UTP (Type A-C), and FC 4957: 64-bit/66MHz PCI ATM 155 MMF (Type A-D) adapters are allowed per system.

5. A combined maximum of 32 FC 2943 and FC 2944 adapters allowed per system.
6. One FC 2877 (Quad DTXA, H.100, 4-Drop Cable) or FC 4353 (8-Drop Cable) is required to connect FC 6310 and/or FC 6311 if more than one is ordered. FC 6311 or additional FC 6310 adapters must be interconnected for proper operation. When connected, FC 6310 is not hot-pluggable.
7. A combined maximum of four FC 4958: Cryptographic Coprocessor and RPQ 8A1162: Cryptographic Coprocessor adapters are allowed per system. These adapters must remain in special packaging at all times until unpacked and installed by the customer or CE at installation.
8. For optimum system performance, a maximum of four FC 2969: Gigabit Ethernet Fibre, 1000BaseT or FC 2975: Gigabit Ethernet (UTP) 1000BaseT adapters per system and two per I/O drawer is recommended.
9. For optimum system performance, a maximum of 20 FC 2741: SysKconnect SK-NET FDDI-LP SAS PCI (Type *), FC 2742: SysKconnect SK-NET FDDI-LP DAS PCI (Type *), and FC 2743: SysKconnect SK-NET FDDI-UP SAS PCI (Type *) adapters per system and a maximum of seven FC 2741, FC 2742, and FC 2743 adapters per I/O drawer is recommended.
10. For optimum system performance, a maximum of 12 FC 2968: 10/100 Mbps Ethernet Tx PCI (Type 9-P) or FC 4962: Ethernet/LAN Encryption 10/100BaseT adapters per system and a maximum of seven per I/O drawer is recommended.
11. For optimum performance using the FC 4961: 10/100 4-Port Ethernet (Type A-E) adapter on this system, use only 2 of the 4 ports if the ports will all be running at media speed. There is a maximum of 10 ports per system (i.e., 5 adapters running 2 ports each). Limit adapters to 2 per I/O drawer, in 64-bit slots.
12. For optimum system performance, the combination of FC 2969: Gigabit Ethernet Fibre, 1000BaseT, FC 2741: SysKconnect SK-NET FDDI-LP SAS PCI (Type *), FC 2742: SysKconnect SK-NET FDDI-LP DAS PCI (Type *), FC 2743: SysKconnect SK-NET FDDI-UP SAS PCI (Type *), FC 2968: 10/100 Mbps Ethernet Tx PCI (Type 9-P), FC 4951: 10/100 4-Port Ethernet (Type 9-Z), FC 2963: TURBOWAYS 155 PCI UTP ATM (Type 9-J), FC 2988: TURBOWAYS 155 PCI MMF ATM (Type 9-F), FC 4953: 64-bit/66MHz PCI ATM 155 UTP (Type A-C), FC 4957: 64-bit/66MHz PCI ATM 155 MMF (Type A-D), FC 4962: Ethernet/LAN Encryption 10/100BaseT, and FC 2975: Gigabit Ethernet (UTP) 1000BaseT adapters cannot exceed 7 adapters per IO drawer.
13. If attaching a device or switch with an SC type fiber connector(s), use of an LC-SC Fibre Channel Conversion Cable (FC 2456) is required.
14. Installation of FC 8397: SP Colony Switch Attach in slot 5 or 3 requires the removal of the adjacent plastic air guide in slot 6 or 4 respectively. The first FC 8397 must be installed in slot 5, FC 3154 Internal Attachment Card installed in slot 6, and FC 2968: 10/100 Mbps Ethernet Tx PCI (Type 9-P) installed in slot 1 (see respective adapter instructions). FC 8397 and FC 3154 are not recognized without PSSP software installed.

15. For optimum performance using FC 2946: PCI TURBOWAYS 622 PCI MMF ATM (Type A-B), limit adapters to the following:
 - MTU 1500: 2 per drawer, 4 per system
 - MTU 9180: 3 per drawer, 6 per system

Chapter 17. 7028 Models 6C1 and 6E1

This system is designed for customers to install adapters. Use this guide to determine if there are specific slot requirements for adapters that you may be installing.

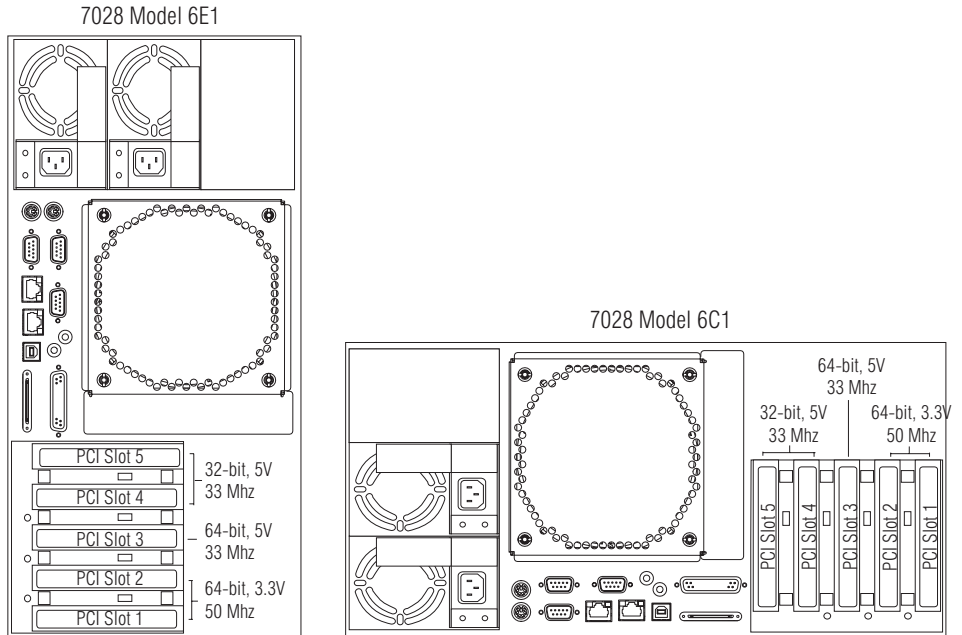

System Unit Rear View with Numbered Slots

Some adapters must be placed in specific system unit slots to function correctly at optimum performance. Use the table under “7028 Models 6C1 and 6E1 Adapter Placement Guide” on page 114 to determine where to install an adapter in your system unit.

Many of the following notes refer to optimizing system performance. Read “System Performance” on page 1 for more performance-related information.

Use the rear-view diagram above to identify slot locations described in the following tables.

7028 Models 6C1 and 6E1 Adapter Placement Guide

Use the following table to identify specific slot location options for the following adapters in your 7028 Models 6C1 and 6E1 system.

Table 20. 7028 Models 6C1 and 6E1

Adapter	Slot Usage	System Maximum
FC 6227: Gigabit Fibre Channel PCI (Type 4-S)	Slots 5, 4, 3, 2, 1 (see note 3 on page 115)	2
FC 6228: Gigabit Fibre Channel Adapter, 32 or 64-bit PCI Bus (Type 4-W)	Slots 5, 4, 3, 2, 1	2
FC 2969: Gigabit Ethernet Fibre, 1000BaseT	Slots 1, 2, 3, 4, 5	5 (see note 4 on page 115)
FC 2975: Gigabit Ethernet (UTP) 1000BaseT	Slots 1, 2, 3, 4, 5	5 (see note 4 on page 115)
FC 2848: GXT135P Graphics Adapter (Type 1-X)	Slots 1, 2, 3, 4, 5	2
FC 2962: 2-Port Multiprotocol PCI (Types 9-L and 9-V)	Slots 5, 4, 3, 2, 1	2
FC 2498: PCI 4-Channel Ultra3 SCSI RAID (Type 4-X)	Slots 1, 2, 3, 4, 5	5
FC 6203: Dual-Channel Ultra3 SCSI (Type 4-Y)	Slots 1, 2, 3, 4, 5	5
FC 6230: Advanced SerialRAID Plus (Type 4-P) FC 6230+6231: 4 Port SSA 40 w/128MB DIMM FC 6235: Fast Write Cache Option for FC 6230	Slots 1, 2, 3, 4, 5	2 (see notes 1 on page 115 and 2 on page 115)
FC 4960: IBM Cryptographic Accelerator (Type 6-J)	Slots 5, 4, 3, 2, 1	4
FC 4961: 10/100 4-Port Ethernet (Type A-E)	Slots 5, 4, 3, 2, 1	5 (see notes 5 on page 115 and 7 on page 115)
FC 2943: 8-Port Asynchronous EIA-232E/RS-422A PCI (Type 3-B)	Slots 5, 4, 3, 2, 1	5
FC 2944: 128-Port Async Controller PCI (Type 3-C)	Slots 5, 4, 3, 2, 1	5
FC 4959: High-Speed Token Ring PCI (Type 9-Y)	Slots 5, 4, 3, 2, 1	4

Table 20. 7028 Models 6C1 and 6E1 (continued)

Adapter	Slot Usage	System Maximum
FC 4962: Ethernet/LAN Encryption 10/100BaseT	Slots 5, 4, 3, 2, 1	5 (see note 6)
FC 6204: PCI Universal Differential Ultra SCSI (Type 4-U)	Slots 5, 4, 3, 2, 1	5
FC 6206: Single-Ended Ultra SCSI Adapter (Type 4-K)	Slots 5, 4, 3, 2, 1	2
FC 4953: 64-bit/66MHz PCI ATM 155 UTP (Type A-C)	Slots 5, 4, 3, 2, 1	5 (see note 5)
FC 4957: 64-bit/66MHz PCI ATM 155 MMF (Type A-D)	Slots 5, 4, 3, 2, 1	5 (see note 5)
FC 2946: PCI TURBOWAYS 622 PCI MMF ATM (Type A-B)	Slots 1, 2, 3, 4, 5	5 (see note 4)

Notes:

- FC 6230: Advanced SerialRAID Plus (Type 4-P) or FC 6230+6231: 4 Port SSA 40 w/128MB DIMM can be selected with or without the cache upgrade (FC 6235: Fast Write Cache Option for FC 6230).
- FC 6235: Fast Write Cache Option for FC 6230 is a cache upgrade for the FC 6230+6231: 4 Port SSA 40 w/128MB DIMM adapter and can only be selected along with FC 6230: Advanced SerialRAID Plus (Type 4-P) or FC 6230+6231: 4 Port SSA 40 w/128MB DIMM (max 1 per FC 6230/FC 6230+6231).
- FC 6227: Gigabit Fibre Channel PCI (Type 4-S) is restricted to only one adapter in slot 1 or 2 and/or one adapter in slot 3, 4 or 5.
- For optimum system performance, a *combination* of the following adapters should not exceed a maximum of one adapter per system:
 - FC 2969: Gigabit Ethernet Fibre, 1000BaseT
 - FC 2975: Gigabit Ethernet (UTP) 1000BaseT
 - FC 2946: PCI TURBOWAYS 622 PCI MMF ATM (Type A-B)

Use 64-bit slots (1, 2, or 3) if available.

- For optimum system performance, install up to 5 FC 4953: 64-bit/66MHz PCI ATM 155 UTP (Type A-C), or FC 4957: 64-bit/66MHz PCI ATM 155 MMF (Type A-D) adapters. Install up to 3 of these adapters if you are in MTU 1500 mode. Use 64-bit slots (1, 2, or 3) if available.
- For optimum system performance, install up to three FC 4962: Ethernet/LAN Encryption 10/100BaseT adapters in this system.
- For optimum system performance, a maximum of one FC 4961: 10/100 4-Port Ethernet (Type A-E) adapter per system (with a maximum of three ports) is recommended.

Chapter 18. @server pSeries Model 690

Adapter cards for the @server pSeries Model 690 plug into PCI adapter slots in the left or right side in the I/O subsystem. Each drawer is capable of handling up to 20 PCI adapters. Most of the PCI slots are capable of 32-bit or 64-bit interface with interface speed of 33 MHz or 66 MHz. Three slots/Planar Six/Drawer (8, 9, 10, 18, 19, 20) are restricted to 5 V dc, 33 MHz adapters.

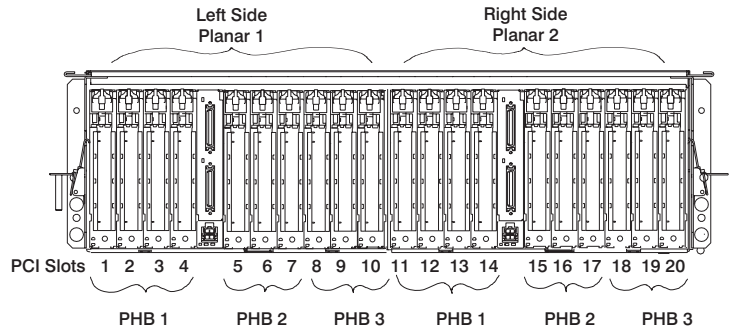

PHB 1	PHB 2	PHB 3	PHB 1	PHB 2	PHB 3
Loc. Codes Ux.y-P1-11 Ux.y-P1-12 Ux.y-P1-13 Ux.y-P1-14	Loc. Codes Ux.y-P1-15 Ux.y-P1-16 Ux.y-P1-17	Loc. Codes Ux.y-P1-18 Ux.y-P1-19 Ux.y-P1-10 Ux.y-P1-10	Loc. Codes Ux.y-P2-111 Ux.y-P2-112 Ux.y-P2-113 Ux.y-P2-114	Loc. Codes Ux.y-P2-15 Ux.y-P2-16 Ux.y-P2-17	Loc. Codes Ux.y-P2-18 Ux.y-P2-19 Ux.y-P2-10
64-bit 3.3V 33/66 MHz	64-bit 3.3V 33/66 MHz	64-bit 5V 33MHz	64-bit 3.3V 33/66MHz	64-bit 3.3V 33/66 MHz	64-bit 5V 33MHz

Ux.y - HMC location code reference wherein x = rack location and y = drawer position.

System Unit Rear View with Numbered Slots

Use the preceding illustration to identify slot locations described in the following table. The first adapter from an adapter group is placed in the first slot (per the table) in the drawer. After the first slot selection has been used, use the second slot in the list. If a designated slot is filled, move to the next available slot.

Logical Partition (LPAR) Considerations

Place redundant devices in separate I/O drawers for best availability performance. Place non-redundant devices in the same I/O drawer. If you place non-redundant devices in one drawer, the system is less exposed to other-drawer failures.

Some devices do not have enhanced error handling (EEH) capabilities built in to their device drivers. If these devices fail, the PCI Host Bridge (PHB) they are placed in will be affected. As such, it is strongly recommended that you place all adapters without EEH capabilities on their own PHB. For information on PHB locations on the I/O subsystem, refer to the preceding illustration. To determine if your adapter has EEH capabilities, refer to the following table.

@server pSeries Model 690 Adapter Placement Guide

Use the following table to identify specific slot locations for the following adapters in your @server pSeries Model 690. The slots listed refer to the HMC (Hardware Management Console) location codes detailed in the preceding illustration.

Table 21. @server pSeries Model 690

Adapter	Slot Usage	Maximum per Planar	Maximum per Drawer	Maximum per LPAR	Maximum per System	Enhanced Error Handling
FC 6206: Single-Ended Ultra SCSI Adapter (Type 4-K)	10, 20	1	2	2	2 (See notes 4 on page 121, 10 on page 121, and 11 on page 121)	Yes
FC 2751: S/390 ESCON Channel (Type 5-5)	8, 18, 9, 19, 10, 20	2	4	4	4	Yes
FC 6230: Advanced SerialRAID Plus (Type 4-P) FC 6230+6231: 4 Port SSA 40 w/128MB DIMM FC 6235: Fast Write Cache Option for FC 6230	1, 11, 3, 13, 4, 14, 5, 15, 7, 17, 9, 19 (See notes 1 on page 121 and 2 on page 121)	6	12	48	48	Yes
FC 6228: Gigabit Fibre Channel Adapter, 32 or 64-bit PCI Bus (Type 4-W)	1, 11, 3, 13, 5, 15, 7, 17, 9, 19	5	10	40	40	Yes
FC 2969: Gigabit Ethernet Fibre, 1000BaseT	1, 11, 3, 13, 5, 15, 7, 17, 9, 19	5	10	40	40 (See note 3 on page 121)	Yes
FC 2975: Gigabit Ethernet (UTP) 1000BaseT	1, 11, 3, 13, 5, 15, 7, 17, 9, 19	5	10	40	40 (See note 3 on page 121)	Yes

Table 21. @server pSeries Model 690 (continued)

Adapter	Slot Usage	Maximum per Planar	Maximum per Drawer	Maximum per LPAR	Maximum per System	Enhanced Error Handling
FC 6203: Dual-Channel Ultra3 SCSI (Type 4-Y)	1, 11, 3, 13, 5, 15, 7, 17, 9, 19	5	10	20	20 (See notes 4 on page 121 and 11 on page 121)	Yes
FC 2946: PCI TURBOWAYS 622 PCI MMF ATM (Type A-B)	1, 11, 3, 13, 5, 15, 7, 17, 9, 19	5	10	40	40 (See note 5 on page 121)	Yes
FC 2848: GXT135P Graphics Adapter (Type 1-X) FC 2737: 4-Port USB Adapter	Both in (5,6,7); (15,16,17); (1,2,3,4); (11,12,13,14); (8,9,10); (18,19,20)	2	4	1	8 (See note 6 on page 121)	No
FC 2733: Serial HIPPI, Long-Wave Optics	1, 11, 2, 12, 3, 13, 4, 14, 5, 15, 6, 16, 7, 17, 8, 18, 9, 19, 10, 20	2	2	2	2 (See note 7 on page 121)	Yes
FC 2732: Serial HIPPI, Short-Wave Optics (Type 9-W)	1, 11, 2, 12, 3, 13, 4, 14, 5, 15, 6, 16, 7, 17, 8, 18, 9, 19, 10, 20	2	2	2	2 (See note 7 on page 121)	Yes
FC 4962: Ethernet/LAN Encryption 10/100BaseT	1, 11, 2, 12, 3, 13, 4, 14, 5, 15, 6, 16, 7, 17, 8, 18, 9, 19, 10, 20	10	10	40	40	Yes
FC 2944: 128-Port Async Controller PCI (Type 3-C)	10, 20, 9, 19, 8, 18, 7, 17, 6, 16, 5, 15, 4, 14, 3, 13, 2, 12, 1, 11	10	20	32	32 (See note 8 on page 121)	Yes
FC 2943: 8-Port Asynchronous EIA-232E/RS-422A PCI (Type 3-B)	10, 20, 9, 19, 8, 18, 7, 17, 6, 16, 5, 15, 4, 14, 3, 13, 2, 12, 1, 11	8	16	16	16 (See note 8 on page 121)	Yes

Table 21. @server pSeries Model 690 (continued)

Adapter	Slot Usage	Maximum per Planar	Maximum per Drawer	Maximum per LPAR	Maximum per System	Enhanced Error Handling
FC 4957: 64-bit/66MHz PCI ATM 155 MMF (Type A-D)	10, 20, 9, 19, 8, 18, 7, 17, 6, 16, 5, 15, 4, 14, 3, 13, 2, 12, 1, 11	10	20	40	40 (See note 5 on page 121)	Yes
FC 4953: 64-bit/66MHz PCI ATM 155 UTP (Type A-C)	10, 20, 9, 19, 8, 18, 7, 17, 6, 16, 5, 15, 4, 14, 3, 13, 2, 12, 1, 11	10	20	40	40 (See note 5 on page 121)	Yes
FC 4959: High-Speed Token Ring PCI (Type 9-Y)	10, 20, 9, 19, 8, 18, 7, 17, 6, 16, 5, 15, 4, 14, 3, 13, 2, 12, 1, 11	10	20	40	40	Yes
FC 2742: SysKonnnect SK-NET FDDI-LP DAS PCI (Type *)	10, 20, 9, 19, 8, 18, 7, 17, 6, 16, 5, 15, 4, 14, 3, 13, 2, 12, 1, 11	8	8	8	8 (See note 9 on page 121)	No
FC 2741: SysKonnnect SK-NET FDDI-LP SAS PCI (Type *)	10, 20, 9, 19, 8, 18, 7, 17, 6, 16, 5, 15, 4, 14, 3, 13, 2, 12, 1, 11	8	8	8	8 (See note 9 on page 121)	No
FC 2743: SysKonnnect SK-NET FDDI-UP SAS PCI (Type *)	10, 20, 9, 19, 8, 18, 7, 17, 6, 16, 5, 15, 4, 14, 3, 13, 2, 12, 1, 11	8	8	8	8 (See note 9 on page 121)	No
FC 2962: 2-Port Multiprotocol PCI (Types 9-L and 9-V)	10, 20, 9, 19, 8, 18, 7, 17, 6, 16, 5, 15, 4, 14, 3, 13, 2, 12, 1, 11	10	20	20	20	Yes
FC 4958: Cryptographic Coprocessor	10, 20, 9, 19, 8, 18, 7, 17, 6, 16, 5, 15, 4, 14, 3, 13, 2, 12, 1, 11	4	4	4	4	No
FC 4960: IBM Cryptographic Accelerator (Type 6-J)	10, 20, 9, 19, 8, 18, 7, 17, 6, 16, 5, 15, 4, 14, 3, 13, 2, 12, 1, 11	4	4	24	24	No
FC 4963: Cryptographic Coprocessor, FIPS-4	10, 20, 9, 19, 8, 18, 7, 17, 6, 16, 5, 15, 4, 14, 3, 13, 2, 12, 1, 11	4	4	4	4	No

Table 21. @server pSeries Model 690 (continued)

Adapter	Slot Usage	Maximum per Planar	Maximum per Drawer	Maximum per LPAR	Maximum per System	Enhanced Error Handling
FC 6204: PCI Universal Differential Ultra SCSI (Type 4-U)	10, 20, 9, 19, 8, 18, 7, 17, 6, 16, 5, 15, 4, 14, 3, 13, 2, 12, 1, 11	10	10	20	20 (See note 10)	Yes

Notes:

- FC 6231: 128 MB DIMM for FC 6230 is a 128 MB memory dimm option for the FC 6225: Advanced SSA SerialRAID (Type 4-P) adapter and can only be selected along with FC 6230: Advanced SerialRAID Plus (Type 4-P) (max 1 per 6230).
- FC 6235: Fast Write Cache Option for FC 6230 is a RAID cache upgrade for the FC 6225: Advanced SSA SerialRAID (Type 4-P) adapter and can only be selected along with FC 6230: Advanced SerialRAID Plus (Type 4-P) (max 1 per 6230).
- A combined maximum of 40 FC 2969: Gigabit Ethernet Fibre, 1000BaseT and FC 2975: Gigabit Ethernet (UTP) 1000BaseT adapters is allowed per system.
- FC 6203: Dual-Channel Ultra3 SCSI (Type 4-Y) with FC 2118 or FC 6206: Single-Ended Ultra SCSI Adapter (Type 4-K) is required with FC 4609 to drive the media subsystem with up to two media devices. FC 6206 has first priority. If FC 6203 is used, then FC 2118 will be placed with the drawer.
- A combined maximum of 40 FC 4957: 64-bit/66MHz PCI ATM 155 MMF (Type A-D), FC 4953: 64-bit/66MHz PCI ATM 155 UTP (Type A-C), and FC 2946: PCI TURBOWAYS 622 PCI MMF ATM (Type A-B) adapters is allowed per system.
- FC 2848: GXT135P Graphics Adapter (Type 1-X) and FC 2737: 4-Port USB Adapter must be placed on the same PHB. All other adapters on that PHB must be on the same LPAR.
- A combined maximum of 2 FC 2732: Serial HIPPI, Short-Wave Optics (Type 9-W) and FC 2733: Serial HIPPI, Long-Wave Optics adapters is allowed per system.
- A combined maximum of 32 FC 2943: 8-Port Asynchronous EIA-232E/RS-422A PCI (Type 3-B) and FC 2944: 128-Port Async Controller PCI (Type 3-C) adapters is allowed per system.
- A combined maximum of 8 FC 2741: SysKonnnect SK-NET FDDI-LP SAS PCI (Type *), FC 2742: SysKonnnect SK-NET FDDI-LP DAS PCI (Type *), and FC 2743: SysKonnnect SK-NET FDDI-UP SAS PCI (Type *) adapters is allowed per system.
- A maximum of 20 FC 6204: PCI Universal Differential Ultra SCSI (Type 4-U) and FC 6206: Single-Ended Ultra SCSI Adapter (Type 4-K) adapters is allowed per system.
- FC 6206: Single-Ended Ultra SCSI (Type 4-K) may be utilized to connect media devices located in the media subsystem. If no FC 6206 is present in the system, FC 6203: Dual-Channel Ultra3 SCSI (Type 4-Y) may be used to connect the media devices in the media subsystem.

Chapter 19. 7043 Model 140

This system is designed for customers to install adapters. Use this guide to determine if there are specific slot requirements for adapters that you may be installing.

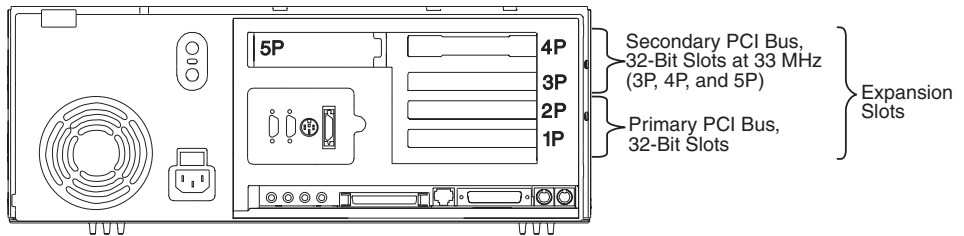

System Unit Rear View with Numbered Slots

Some adapters must be placed in specific system unit slots to function correctly at optimum performance. Use the table under “7043 Model 140 Adapter Placement Guide” to determine where to install an adapter in your system unit.

Many of the following notes refer to optimizing system performance. Read “System Performance” on page 1 for more performance-related information.

If you are running AIX, refer to “7043 Model 140 Multiple Graphics Adapter Placement Guide” on page 129 to install two or more adapters in your 7043 Model 140. Windows NT (PowerPC Edition) does not support more than one graphics adapter in a system unit.

Use the rear-view diagram above to identify slot locations described in the following tables.

7043 Model 140 Adapter Placement Guide

Use the following table to identify specific slot locations for the following adapters in your 7043 Model 140.

Table 22. 7043 Model 140

Adapter	AIX	Windows NT
FC 4951: 10/100 4-Port Ethernet (Type 9-Z)	Slots 2P Max. 1 per system, see note 4 and 9 on page 128	
FC 2859: GXT800P 3-slot Graphics (Type 1-K)	Slot 2P see notes 5 on page 128 and 6 on page 128	

Table 22. 7043 Model 140 (continued)

Adapter	AIX	Windows NT
FC 2853: POWER GXT800P (Type 1-K)	Slot 2P see notes 5 on page 128, 6 on page 128, and 11 on page 128	
FC 2854: POWER GXT500P (Type 1-I)	Slot 2P	
FC 2855: POWER GXT550P (Type 1-J)	Slot 2P	
FC 2856: POWER GXT1000 (Type 1-H)	Slots 1P - 2P One max.	
FC 2837: Dual S3	Slot 2P see note 8 on page 128	
FC 2638: Stream	Slots 2P, 3P, 4P Max. 1 per system see note 11 on page 128	
FC 2639: Ultimedia Video Capture (Type 7-9)	Slots 2P, 3P, 4P Max. 1 per system see note 11 on page 128	
FC 2823: POWER GXT2000P (Type 1-S)	Slots 2P, 3P, 1P, 4P Max. 4 per system see note 9 on page 128	
FC 2841: POWER GXT300P (Type1-U)	Slots 2P, 3P, 1P, 4P Max. 4 per system see note 9 on page 128	
FC 2830: POWER GXT130P (Type 1-T)	Slots 1P - 5P Max. 4 per system	
FC 2851: POWER GXT250P (Type 1-M)	Slots 1P - 5P Max. 4 per system see notes 7 on page 128, 8 on page 128, and 9 on page 128	Slots 1P - 2P

Table 22. 7043 Model 140 (continued)

Adapter	AIX	Windows NT
FC 2852: POWER GXT255P (Type 1-N)	Slots 1P - 5P Max. 4 per system. See notes 7 on page 128, 8 on page 128, and 9 on page 128	
FC 2838: POWER GXT120P (Type 1-P)	Slots 1P - 5P Max. 4 per system	
FC 2839: POWER GXT110P (Type *)	Slots 1P - 2P Max. 2 per system see note 7 on page 128	Slots 1P - 2P
FC 2933: 128-port RS232 (Type 3-9)	Slots 3P, 2P (two max.)	
FC 2931: 8-port RS232 (Type 3-8)	Slots 3P, 2P (two max.)	
FC 2932: 8-port (Type 3-A)	Slots 3P, 2P (two max.)	
FC 2961: X.25, SDLC C1X	Slots 3P, 2P (two max.)	
FC 2701: 4-port SDLC	Slots 3P, 2P (two max.)	
FC 6230: Advanced SerialRAID Plus (Type 4-P) FC 6230+6231: 4 Port SSA 40 w/128MB DIMM FC 6235: Fast Write Cache Option for FC 6230	Slot 2P only	
FC 6215: PCI SSA Multi-Initiator/RAID EL (Type 4-N)	Slot 2P see notes 12 on page 128 and 13 on page 128	
FC 6222: 4-Port, SSA-RAID1 Fast Write Cache Option (Type 4-N)	N/A see note 13 on page 128	
FC 6310: IBM ARTIC960 RxD Quad Digital Trunk PCI (Type 6-E)	Slots 2P, 3P, 4P Max. 3 per system see "Chapter 29. Digital Trunk PCI Adapter Placement Considerations" on page 185 and note 3 on page 128	

Table 22. 7043 Model 140 (continued)

Adapter	AIX	Windows NT
FC 6311: IBM ARTIC960 RxF PCI (Type 6-G)	Slots 2P, 3P, 4P Max. 3 per system see "Chapter 29. Digital Trunk PCI Adapter Placement Considerations" on page 185 and note 3 on page 128	
FC 2949: IBM ARTIC960 Hx DSP Resource PCI (Type 9-T)	Slots 2P, 3P, 4P Max. 3 per system	
FC 2948: IBM ARTIC960 4-Port T1/E1 PCI (Type 9-S)	Slots 2P, 3P, 4P Max. 3 per system	
FC 2947: IBM ARTIC960Hx 4-Port Selectable PCI (Type 9-R)	Slots 2P, 3P, 4P Max. 3 per system	
FC 6206: Single-Ended Ultra SCSI Adapter (Type 4-K)	Slot 5P, 4P, 3P, 2P, 1P Max. 2 per system	
FC 2405 + 6206: Internal Ultra SCSI (requires one FC 6206)	Slot 5P	
FC 2943: 8-Port Asynchronous EIA-232E/RS-422A PCI (Type 3-B)	Slots 5P ,4P , 1P, 3P , 2P (two max.)	
FC 2944: 128-Port Async Controller PCI (Type 3-C)	Slots 5P ,4P , 1P, 3P , 2P (two max.)	
FC 6207: PCI Differential Ultra SCSI (Type 4-L)	Slots 4P , 3P , 2P , 1P, 5P (two max.)	
FC 6218: PCI SSA 4-Port RAID (Type 4-J)	Slot 2P	
FC 2962: 2-Port Multiprotocol PCI (Types 9-L and 9-V)	Slots 5P, 4P, 3P (two max.)	
FC 2963: TURBOWAYS 155 PCI UTP ATM (Type 9-J)	Slots 5P, 4P, 3P, 2P, 1P Max. 2 per system See note 2	
FC 2988: TURBOWAYS 155 PCI MMF ATM (Type 9-F)	Slots 5P, 4P, 3P, 2P, 1P Max. 4 per system See note 2	
FC 2708: ISDN Basic Rate PCI (Type 9-N)	Slots 5P, 4P, 1P, 3P, 2P (one max.)	

Table 22. 7043 Model 140 (continued)

Adapter	AIX	Windows NT
FC 2968: 10/100 Mbps Ethernet Tx PCI (Type 9-P)	Slots 5P, 4P, 3P, 2P, 1P Max. 4 per system See note 1	
FC 2998: TURBOWAYS 25 ATM PCI (Type *)	Slots 5P, 4P, 1P, 3P, 2P Max. 4 per system	
FC 6309: Digital Trunk Quad PCI (Type 6-B)	Slots 2P, 3P, 4P Max. 2 per system	
FC 2979: PCI Auto LANstreamer Token Ring (Type 8-T)	Slots 5P, 4P, 1P, 3P, 2P (4 max.)	
FC 2986: 10/100 Mbps PCI Fast Etherlink XL (Type *)	Slots 5P, 4P, 3P, 2P, 1P Max. 4 per system	
FC 2985: Ethernet 10base2 PCI (Type 8-Y)	Slots 5P, 4P, 1P, 3P, 2P (2 max.)	
FC 2987: Ethernet 10base5 PCI (Type 8-Z)	Slots 5P, 4P, 1P, 3P, 2P (2 max.)	
FC 6208: PCI SCSI-2 Single Ended Fast/Wide (Type 4-A)	Slots 5P, 4P, 1P, 3P, 2P (2 max.)	
FC 6208 + 2445: EB+,SE SCSI (w/int.drives)	Slot 5P	
FC 6209: PCI SCSI-2 Differential Fast/Wide (Type 4-B)	Slots 5P, 4P, 1P, 3P, 2P (2 max.)	
FC 2742: SysKonnnect SK-NET FDDI-LP DAS PCI (Type *)	Slots 5P, 4P, 1P, 3P, 2P (2 max.) see note 10 on page 128	
FC 2741: SysKonnnect SK-NET FDDI-LP SAS PCI (Type *)	Slots 5P, 4P, 1P, 3P, 2P (2 max.) see note 10 on page 128	
FC 2743: SysKonnnect SK-NET FDDI-UP SAS PCI (Type *)	Slots 5P, 4P, 1P, 3P, 2P (2 max.) see note 10 on page 128	
FC 4959: High-Speed Token Ring PCI (Type 9-Y)	Slots 5P, 4P, 1P, 3P, 2P (4 max.)	
FC 2920: 16Mbps PCI Token-Ring (Type 9-0)	Slots 5P, 4P, 1P, 3P, 2P (4 max.)	
FC 6227: Gigabit Fibre Channel PCI (Type 4-S)	Slots 2P, 3P, 4P	

Notes:

1. A maximum of four FC 2968: 10/100 Mbps Ethernet Tx PCI (Type 9-P) adapters can be used in the 7043 Model 140. For optimum system performance, one FC 2968: 10/100 Mbps Ethernet Tx PCI (Type 9-P) adapter operating in 100 Mbps mode is recommended.
2. For optimum system performance, when using a 155 TURBOWAYS ATM PCI MMF adapter or 155 TURBOWAYS ATM PCI UTP adapter in LAN emulation (LANE), a maximum of one adapter per system is recommended.
3. Do not install more than a combination of three FC 6310: IBM ARTIC960 RxD Quad Digital Trunk PCI (Type 6-E) and FC 6311: IBM ARTIC960 RxF PCI (Type 6-G) adapters in this system.
4. For optimum system performance, use only one 100 Mbs port per system.
5. FC 2859: GXT800P 3-slot Graphics (Type 1-K) and FC 2853: POWER GXT800P (Type 1-K) must be installed in the slot 2. In addition, slots 3 and 4 will not be available because of thermal and power requirements.
6. FC 2859: GXT800P 3-slot Graphics (Type 1-K) and FC 2853: POWER GXT800P (Type 1-K) both require a bracket assembly FBM 93H3627.
7. Only one FC 2839: POWER GXT110P (Type *) can be installed along with only one FC 2851: POWER GXT250P (Type 1-M) or FC 2852: POWER GXT255P (Type 1-N). In addition, FC 2851 and FC 2852 must be in a primary slot (1 or 2).
8. Only one FC 2837: Dual S3 can be installed along with only one FC 2851: POWER GXT250P (Type 1-M) or FC 2852: POWER GXT255P (Type 1-N). In addition, FC 2851 and FC 2852 must be in a primary slot (1 or 2).
9. When FC 4951: 10/100 4-Port Ethernet (Type 9-Z) is installed, the following adapters must be installed in slots 3, 4, or 5: FC 2823, FC 2841, FC 2851, and FC 2852.
10. Two FC 2741, FC 2742, or FC 2743 adapters are allowed in the system, but they cannot be in slots next to each other, because of EMC reasons.
11. When installed with a FC 2853: POWER GXT800P (Type 1-K), FC 2638: Stream must be installed in slot 1 with a mounting bracket (93H7863). The FC 2639: Ultimedia Video Capture (Type 7-9) doesn't require the bracket.
12. FC 6215: PCI SSA Multi-Initiator/RAID EL (Type 4-N) can be selected with or without the cache upgrade (F/C 6222).
13. FC 6222: 4-Port, SSA-RAID1 Fast Write Cache Option (Type 4-N) is a cache upgrade for the Campbell RAID adapter and can only be selected along with FC 6215.

7043 Model 140 Multiple Graphics Adapter Placement Guide

Use the following table to identify adapter location combination options for these adapters in your 7043 Model 140.

Do not install more than four graphics adapters in your 7043 Model 140.

Table 23. 7043 Model 140

Adapter	Slot
FC 2839: POWER GXT110P (Type *) with a FC 2838: POWER GXT120P (Type 1-P) or FC 2830: POWER GXT130P (Type 1-T) or FC 2851: POWER GXT250P (Type 1-M) or FC 2852: POWER GXT255P (Type 1-N)	Slot 1P Slot 2P <p style="text-align: center;">OR</p> Slot 2P Slot 1P
FC 2839: POWER GXT110P (Type *) with a FC 2854: POWER GXT500P (Type 1-I) or FC 2855: POWER GXT550P (Type 1-J) or FC 2841: POWER GXT300P (Type1-U)	Slot 1P Slot 2P
FC 2839: POWER GXT110P (Type *) with a FC 2853: POWER GXT800P (Type 1-K)	Slot 1P Slot 2P
FC 2839: POWER GXT110P (Type *) with a FC 2856: POWER GXT1000 (Type 1-H)	Slot 1P Slot 2P <p style="text-align: center;">OR</p> Slot 2P Slot 1P
FC 2838: POWER GXT120P (Type 1-P) or FC 2830: POWER GXT130P (Type 1-T) or FC 2851: POWER GXT250P (Type 1-M) or FC 2852: POWER GXT255P (Type 1-N) or FC 2823: POWER GXT2000P (Type 1-S) or FC 2841: POWER GXT300P (Type1-U) with a FC 2838: POWER GXT120P (Type 1-P) or FC 2830: POWER GXT130P (Type 1-T) or FC 2851: POWER GXT250P (Type 1-M) or FC 2852: POWER GXT255P (Type 1-N) or FC 2823: POWER GXT2000P (Type 1-S) or FC 2841: POWER GXT300P (Type1-U)	Slot 1P - 5P Slot 1P - 5P

Table 24. 7043 Model 140

Adapter	Slot
FC 2838: POWER GXT120P (Type 1-P) or FC 2830: POWER GXT130P (Type 1-T) or FC 2851: POWER GXT250P (Type 1-M) or FC 2852: POWER GXT255P (Type 1-N) or FC 2823: POWER GXT2000P (Type 1-S) or FC 2841: POWER GXT300P (Type1-U) with a FC 2853: POWER GXT800P (Type 1-K)	Slot 1P Slot 2P
FC 2639: Ultimedia Video Capture (Type 7-9) with a FC 2853: POWER GXT800P (Type 1-K)	Slot 1P Slot 2P
FC 2838: POWER GXT120P (Type 1-P) or FC 2830: POWER GXT130P (Type 1-T) or FC 2851: POWER GXT250P (Type 1-M) or FC 2852: POWER GXT255P (Type 1-N) or FC 2841: POWER GXT300P (Type1-U) with a FC 2856: POWER GXT1000 (Type 1-H)	Slot 1P Slot 2P OR Slot 2P Slot 1P
FC 2639: Ultimedia Video Capture (Type 7-9) with a FC 2823: POWER GXT2000P (Type 1-S)	Slot 1P - 4P Slot 1P - 5P
FC 2823: POWER GXT2000P (Type 1-S) with a FC 2853: POWER GXT800P (Type 1-K)	Slot 1P Slot 2P
FC 2639: Ultimedia Video Capture (Type 7-9) with a FC 2841: POWER GXT300P (Type1-U)	Slot 1P - 4P Slot 1P - 5P

Chapter 20. 7043 Model 150

This system is designed for customers to install adapters. Use this guide to determine if there are specific slot requirements for adapters that you may be installing.

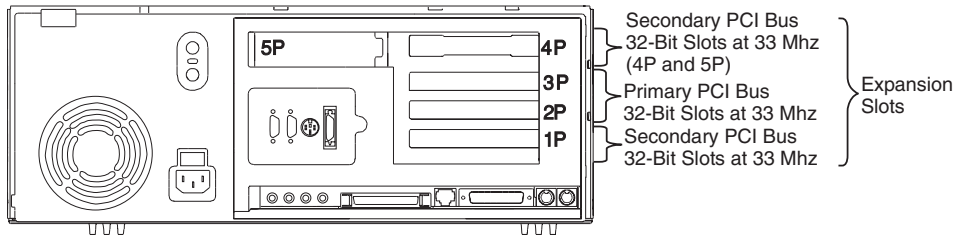

System Unit Rear View with Numbered Slots

Some adapters must be placed in specific system unit slots to function correctly at optimum performance. Use the table under “7043 Model 150 Adapter Placement Guide” to determine where to install an adapter in your system unit.

Many of the following notes refer to optimizing system performance. Read “System Performance” on page 1 for more performance-related information.

If you are running AIX, refer to “7043 Model 150 Multiple Graphics Adapter Placement Guide” on page 137 to install adapter combinations for your 7043 Model 150. Windows NT (Power PC Edition) does not support more than one graphics adapter in a system unit.

Use the rear-view diagram above to identify slot locations described in the following tables.

7043 Model 150 Adapter Placement Guide

Use the following table to identify specific slot-location options for the following adapters in your 7043 Model 150 system.

Table 25. 7043 Model 150

Adapter	Slot Usage	System Maximum
FC 4951: 10/100 4-Port Ethernet (Type 9-Z)	Slots 2P or 3P	2 (see notes 11 on page 135, 13 on page 135)
FC 2842: Power GXT4500P Graphics Adapter (Type 1-Y)	Slots 2P, 3P, 4P	3
FC 2825: POWER GXT3000P (Type 1-R)	Slot 3P (see note 1 on page 135)	1

Table 25. 7043 Model 150 (continued)

Adapter	Slot Usage	System Maximum
FC 2845: Mint 3DX (GXT550P)	Slots 2, 3	1
FC 2823: POWER GXT2000P (Type 1-S)	Slots 2P, 3P, 1P, 4P (see note 13 on page 135)	4
FC 2841: POWER GXT300P (Type1-U)	Slots 2P, 3P, 1P, 4P (see note 13 on page 135)	4 (see notes 2 on page 135, 13 on page 135)
FC 2830: POWER GXT130P (Type 1-T)	Slots 2P, 3P, 1P, 4P, 5P (see notes 2 on page 135, 7 on page 135 and 8 on page 135)	4
FC 2848: GXT135P Graphics Adapter (Type 1-X)	Slots 2P, 3P, 1P, 4P, 5P	4
FC 2852: POWER GXT255P (Type 1-N) (see note 2 on page 135)	Slots 2P, 3P, 1P, 4P, 5P (see note 13 on page 135)	4
FC 2851: POWER GXT250P (Type 1-M)	Slots 2P, 3P, 1P, 4P, 5P (see note 13 on page 135)	4
FC 2838: POWER GXT120P (Type 1-P)	Slots 2P, 3P, 1P, 4P, 5P (see notes 2 on page 135, 7 on page 135 and 8 on page 135)	4
FC 2639: Ultimedia Video Capture (Type 7-9)	Slots 1P, 2P, 3P, 4P, 5P (see note 10 on page 135 and 15 on page 136)	1
FC 4958: Cryptographic Coprocesor	Slots 3P, 4P	2
FC 6205: PCI Dual Channel Ultra2 SCSI (Type 4-R)	Slots 2P, 3P, 4P, 5P (see notes 7 on page 135, 8 on page 135, and 14 on page 136)	2
FC 6203: Dual-Channel Ultra3 SCSI (Type 4-Y)	Slots 2P, 3P, 4P, 5P (see notes 7 on page 135 and 8 on page 135)	2
FC 6206: Single-Ended Ultra SCSI Adapter (Type 4-K)	Slots 5P, 4P, 3P, 2P, 1P (see note 14 on page 136)	2
FC 6207: PCI Differential Ultra SCSI (Type 4-L)	Slots 1P, 2P, 3P, 4P, 5P	2

Table 25. 7043 Model 150 (continued)

Adapter	Slot Usage	System Maximum
FC 2494: PCI 3-Channel Ultra2 SCSI RAID (Type 4-T)	Slots 2P, 3P (see notes 10 on page 135 and 15 on page 136)	2
FC 6225: Advanced SSA SerialRAID (Type 4-P)	Slots 2P, 3P	1 (see note 6 on page 135)
FC 6230: Advanced SerialRAID Plus (Type 4-P) FC 6230+6231: 4 Port SSA 40 w/128MB DIMM FC 6235: Fast Write Cache Option for FC 6230	Slots 2P, 3P	1 (see note 6 on page 135)
FC 6215: PCI SSA Multi-Initiator/RAID EL (Type 4-N)	Slots 2P, 3P	1 (see note 6 on page 135)
FC 2498: PCI 4-Channel Ultra3 SCSI RAID (Type 4-X)	Slots 2P, 3P	2
FC 6310: IBM ARTIC960 RxD Quad Digital Trunk PCI (Type 6-E)	Slots 4P, 3P, 2P (see "Chapter 29. Digital Trunk PCI Adapter Placement Considerations" on page 185, and note 9 on page 135)	3
FC 6311: IBM ARTIC960 RxF PCI (Type 6-G)	Slots 4P, 3P, 2P (see "Chapter 29. Digital Trunk PCI Adapter Placement Considerations" on page 185, and note 9 on page 135)	2
FC 2947: IBM ARTIC960Hx 4-Port Selectable PCI (Type 9-R)	Sots 4, 3, 2	3
FC 2948: IBM ARTIC960 4-Port T1/E1 PCI (Type 9-S)	Slots 4, 3, 2	3
FC 4959: High-Speed Token Ring PCI (Type 9-Y)	Slots 1, 2, 3, 4, 5	4
FC 2920: 16Mbps PCI Token-Ring (Type 9-0)	Slots 1P, 2P, 3P, 4P, 5P	4

Table 25. 7043 Model 150 (continued)

Adapter	Slot Usage	System Maximum
FC 2968: 10/100 Mbps Ethernet Tx PCI (Type 9-P)	Slots 2P, 3P, 1P, 4P, 5P	4 (see note 4 on page 135)
FC 4962: Ethernet/LAN Encryption 10/100BaseT	Slots 2P, 3P, 1P, 4P, 5P	4 (see note 4 on page 135)
FC 2943: 8-Port Asynchronous EIA-232E/RS-422A PCI (Type 3-B)	Slots 1P, 2P, 3P, 4P, 5P	2
FC 2944: 128-Port Async Controller PCI (Type 3-C)	Slots 1P, 2P, 3P, 4P, 5P	2
FC 2962: 2-Port Multiprotocol PCI (Types 9-L and 9-V)	Slots 5P, 4P, 1P	2
FC 2963: TURBOWAYS 155 PCI UTP ATM (Type 9-J)	Slots 1P, 2P, 3P, 4P, 5P	2 (see note 5 on page 135)
FC 4953: 64-bit/66MHz PCI ATM 155 UTP (Type A-C)	Slots 1P, 2P, 3P, 4P, 5P	2 (see note 5 on page 135)
FC 2988: TURBOWAYS 155 PCI MMF ATM (Type 9-F)	Slots 1P, 2P, 3P, 4P, 5P	2 (see note 5 on page 135)
FC 4957: 64-bit/66MHz PCI ATM 155 MMF (Type A-D)	Slots 1P, 2P, 3P, 4P, 5P	2 (see note 5 on page 135)
FC 2708: ISDN Basic Rate PCI (Type 9-N)	Slots 2P, 3P	1
FC 2998: TURBOWAYS 25 ATM PCI (Type *)	Slots 1P, 2P, 3P, 4P, 5P	4
FC 2742: SysKonnnect SK-NET FDDI-LP DAS PCI (Type *)	Slots 1P, 2P, 3P, 4P, 5P (see note 3 on page 135)	2
FC 2741: SysKonnnect SK-NET FDDI-LP SAS PCI (Type *)	Slots 1P, 2P, 3P, 4P, 5P (see note 3 on page 135)	2
FC 2743: SysKonnnect SK-NET FDDI-UP SAS PCI (Type *)	Slots 1P, 2P, 3P, 4P, 5P (see note 3 on page 135)	2
FC 4960: IBM Cryptographic Accelerator (Type 6-J)	Slots 1P, 2P, 3P, 4P, 5P	4

Notes:

1. The FC 2825: POWER GXT3000P (Type 1-R) occupies the physical space of two adapters in the 7043 Model 150, and, if installed, will fill slots 1 and 2.
2. If both the FC 2838: POWER GXT120P (Type 1-P) or FC 2830: POWER GXT130P (Type 1-T) and the FC 2852: POWER GXT255P (Type 1-N) or FC 2841: POWER GXT300P (Type1-U) are installed, the FC 2852: POWER GXT255P (Type 1-N) or FC 2841: POWER GXT300P (Type1-U) must be installed in slot 2 or 3.
3. If two SysKonnnect SK-NET FDDI PCI adapters are installed, they cannot be installed in slots next to each other.
4. For optimum system performance, place FC 2968: 10/100 Mbps Ethernet Tx PCI (Type 9-P) or FC 4962: Ethernet/LAN Encryption 10/100BaseT in slots 2 and 3, with no more than 2 per system. You may have a total of 5 per system for connectivity, including integrated ethernet.
5. For optimum system performance, when using a FC 2988: TURBOWAYS 155 PCI MMF ATM (Type 9-F), FC 2963: TURBOWAYS 155 PCI UTP ATM (Type 9-J), FC 4953: 64-bit/66MHz PCI ATM 155 UTP (Type A-C), or FC 4957: 64-bit/66MHz PCI ATM 155 MMF (Type A-D) adapter in LAN Emulation (LANE) a maximum of one adapter per system is recommended.
6. Install only *one* of the following adapters:
 - FC 6215: PCI SSA Multi-Initiator/RAID EL (Type 4-N)
 - FC 6225: Advanced SSA SerialRAID (Type 4-P)
 - FC 6230: Advanced SerialRAID Plus (Type 4-P)
7. Do not install an FC 6205: PCI Dual Channel Ultra2 SCSI (Type 4-R) or FC 6203: Dual-Channel Ultra3 SCSI (Type 4-Y) adapter on the same PCI bus as a FC 2838: POWER GXT120P (Type 1-P) or older versions of the FC 2830: POWER GXT130P (Type 1-T). To determine if you have an older version of the FC 2830: POWER GXT130P (Type 1-T), remove the card and examine the bar code label on the back side. If it has a number starting with **11S94H1235**, you have an older version of the card.
8. If the FC 6205: PCI Dual Channel Ultra2 SCSI (Type 4-R) or FC 6203: Dual-Channel Ultra3 SCSI (Type 4-Y) adapter is plugged into slot 2 or 3, then the POWER GXT120P or the POWER GXT130P can only be plugged in slots 1, 4, or 5. If you plug the POWER GXT120P or the POWER GXT130P in slots 2 or 3, then you must plug the Ultra2 SCSI adapter in slots 1, 4 or 5.
9. Do not install more than a combination of three FC 6311: IBM ARTIC960 RxF PCI (Type 6-G) adapters and FC 6310: IBM ARTIC960 RxD Quad Digital Trunk PCI (Type 6-E)s in this system.
10. Do not install an FC 2494: PCI 3-Channel Ultra2 SCSI RAID (Type 4-T) and a FC 6311: IBM ARTIC960 RxF PCI (Type 6-G) adapter on the same bus.
11. For optimum system performance, use only two 100 Mbs ports per system.
12. Do not install the FC 6205: PCI Dual Channel Ultra2 SCSI (Type 4-R) adapter in slots 2 or 3 if you also have a FC 2823: POWER GXT2000P (Type 1-S) installed on this system.
13. When FC 4951: 10/100 4-Port Ethernet (Type 9-Z) is installed, the following adapters must be installed in slots 1, 4, or 5: FC 2823, FC 2841, FC 2851, and FC 2852.

14. FC 2445 is the internal SCSI cable used with FC 6206: Single-Ended Ultra SCSI Adapter (Type 4-K), or with FC 6205: PCI Dual Channel Ultra2 SCSI (Type 4-R). The SCSI adapter card (FC 6206 or FC 6205), which is to be connected to the internal drives using FC 2445, *must be installed* in Slot 5. If FC 2445 and either FC 6206 or FC 6205 are on the order, slot location placement for FC 6206 and FC 6205 is slot 5 first priority.
15. FC 2494: PCI 3-Channel Ultra2 SCSI RAID (Type 4-T) and FC 2639: Ultimedia Video Capture (Type 7-9) adapters cannot be installed together.

Table 26. 7043 Model 150 (continued)

Adapter	Slot
FC 2639: Ultimedia Video Capture (Type 7-9) with a	Slot 1P or 4P or 5P
FC 2825: POWER GXT3000P (Type 1-R)	Slot 3P

Table 27. 7043 Model 150

Adapter	Slot
FC 2639: Ultimedia Video Capture (Type 7-9) with a FC 2823: POWER GXT2000P (Type 1-S)	Slot 1P - 5P Slot 1P - 5P
FC 2639: Ultimedia Video Capture (Type 7-9) with a FC 2841: POWER GXT300P (Type1-U)	Slot 1P - 5P Slot 1P - 5P

Notes:

1. The FC 2825: POWER GXT3000P (Type 1-R) occupies the physical space of two adapters in the 7043 Model 150.

Chapter 21. 7043 Model 240

This system is designed for customers to install adapters. Use this guide to determine if there are specific slot requirements for adapters that you may be installing.

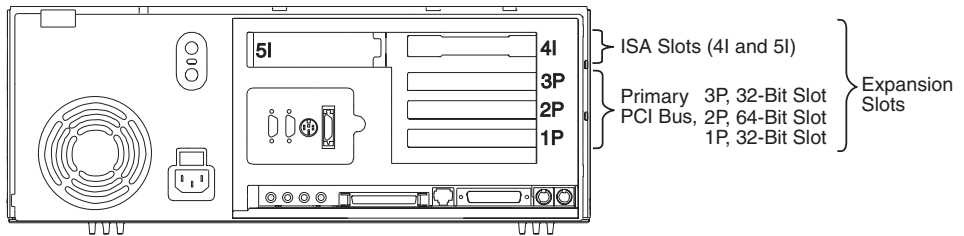

System Unit Rear View with Numbered Slots

Note: In the figure above, slots 1P and 3P are on a primary PCI bus running at 33 MHz. Slot 2P is on a separate primary PCI bus running at 50/33 MHz.

Some adapters must be placed in specific system unit slots to function correctly and to achieve optimum performance. Use the table under “7043 Model 240 Adapter Placement Guide” to determine where to install an adapter in your system unit.

Many of the following notes refer to optimizing system performance. Read “System Performance” on page 1 for more performance-related information.

If you are running AIX, refer to “7043 Model 240 Multiple Graphics Adapter Placement Guide” on page 144 to install adapter combinations for your 7043 Model 240. Windows NT (PowerPC Edition) does not support more than one graphics adapter in a system unit.

Use the rear-view diagram above to identify slot locations described in the following tables.

7043 Model 240 Adapter Placement Guide

Use the following table to identify slot-location options for the following adapters in your 7043 Model 240.

Table 28. 7043 Model 240

Adapter	AIX	Windows NT
FC 6309: Digital Trunk Quad PCI (Type 6-B)	Slot 2P, Slot 3P Max. 2 per system	
FC 2839: POWER GXT110P (Type *)	Slot 1P, Slot 3P	Slot 1P, Slot 3P
FC 2838: POWER GXT120P (Type 1-P)	Slot 1P - 3P	

Table 28. 7043 Model 240 (continued)

Adapter	AIX	Windows NT
FC 2851: POWER GXT250P (Type 1-M) or FC 2852: POWER GXT255P (Type 1-N)	Slots 1P - 3P (2P Best)	Slots 1P - 3P
FC 2854: POWER GXT500P (Type 1-I) or FC 2855: POWER GXT550P (Type 1-J)	Slot 2P (see note 4 on page 143)	
FC 2853: POWER GXT800P (Type 1-K)	Slot 2P (see note 3 on page 143)	
FC 2856: POWER GXT1000 (Type 1-H)	Slots 1P - 3P (2P Best)	
FC 6215: PCI SSA Multi-Initiator/RAID EL (Type 4-N)	Slots 2P - 3P	
FC 6218: PCI SSA 4-Port RAID (Type 4-J)	Slots 2P - 3P	
FC 2639: Ultimedia Video Capture (Type 7-9)	Slots 1P, 2P, or 3P Max. 1 per system	
FC 2988: TURBOWAYS 155 PCI MMF ATM (Type 9-F)	See note 2	
FC 2963: TURBOWAYS 155 PCI UTP ATM (Type 9-J)	See note 2	
FC 2986: 10/100 Mbps PCI Fast Etherlink XL (Type *)	See note 2	
FC 2968: 10/100 Mbps Ethernet Tx PCI (Type 9-P)	See note 2	
FC 2493: PCI SCSI-2 Fast/Wide RAID (Type 4-H)	See note 2	
FC 2742: SysKonnnect SK-NET FDDI-LP DAS PCI (Type *)	See note 2	
FC 2741: SysKonnnect SK-NET FDDI-LP SAS PCI (Type *)	See note 2	
FC 2743: SysKonnnect SK-NET FDDI-UP SAS PCI (Type *)	See note 2	

Notes:

1. "Best" means optimum performance achieved if installed in this slot.
2. **Connectivity Note:** The 7043 Model 240 supports any combination of the following adapters, but that *combination* cannot exceed a total of two:
 - FC 2988: TURBOWAYS 155 PCI MMF ATM (Type 9-F)
 - FC 2963: TURBOWAYS 155 PCI UTP ATM (Type 9-J)

- FC 2986: 10/100 Mbps PCI Fast Etherlink XL (Type *)
- FC 2968: 10/100 Mbps Ethernet Tx PCI (Type 9-P)
- FC 2493: PCI SCSI-2 Fast/Wide RAID (Type 4-H)
- FC 2742: SysKonnnect SK-NET FDDI-LP DAS PCI (Type *)
- FC 2741: SysKonnnect SK-NET FDDI-LP SAS PCI (Type *)
- FC 2743: SysKonnnect SK-NET FDDI-UP SAS PCI (Type *)

Performance Notes: For optimum system performance, a maximum of one of the following adapters is recommended. (This restriction does not apply if the FC 2968: 10/100 Mbps Ethernet Tx PCI (Type 9-P) adapter is used in 10 Mbps mode.)

- FC 2988: TURBOWAYS 155 PCI MMF ATM (Type 9-F)
 - FC 2963: TURBOWAYS 155 PCI UTP ATM (Type 9-J)
 - FC 2986: 10/100 Mbps PCI Fast Etherlink XL (Type *)
 - FC 2968: 10/100 Mbps Ethernet Tx PCI (Type 9-P)
 - FC 2493: PCI SCSI-2 Fast/Wide RAID (Type 4-H)
 - FC 2742: SysKonnnect SK-NET FDDI-LP DAS PCI (Type *)
 - FC 2741: SysKonnnect SK-NET FDDI-LP SAS PCI (Type *)
 - FC 2743: SysKonnnect SK-NET FDDI-UP SAS PCI (Type *)
3. The FC 2853: POWER GXT800P (Type 1-K) occupies the physical space of three adapters in the 7043 Model 240.
 4. When installing a FC 2855: POWER GXT550P (Type 1-J) in the 7043 Model 240, an electrical grounding tab is installed on the front of the adapter to allow connection to the 7043 Model 240 frame. Follow the instructions that are supplied with the adapter to attach the grounding tab.

7043 Model 240 Multiple Graphics Adapter Placement Guide

Use the following table to identify slot location combination options for the following adapters in your 7043 Model 240.

Do not install more than four graphics adapters in your 7043 Model 240.

Table 29. 7043 Model 240

Adapter	Slot
FC 2839: POWER GXT110P (Type *) with a FC 2838: POWER GXT120P (Type 1-P) or FC 2851: POWER GXT250P (Type 1-M) or FC 2852: POWER GXT255P (Type 1-N)	Slot 1P Slot 3P OR Slot 2P Best or 3P Slots 2P Best or 1P
FC 2839: POWER GXT110P (Type *) with a FC 2854: POWER GXT500P (Type 1-I) or FC 2855: POWER GXT550P (Type 1-J)	Slot 1P, Slot 3P Slot 2P
FC 2839: POWER GXT110P (Type *) with a FC 2853: POWER GXT800P (Type 1-K)	Slot 1P Slot 2P
FC 2839: POWER GXT110P (Type *) with a FC 2856: POWER GXT1000 (Type 1-H)	Slot 1P Slot 3P OR Slot 2P Best or 3P Slots 2P Best or 1P

Chapter 22. 7043 Model 260

This system is designed for customers to install adapters. Use this guide to determine if there are specific slot requirements for adapters that you may be installing.

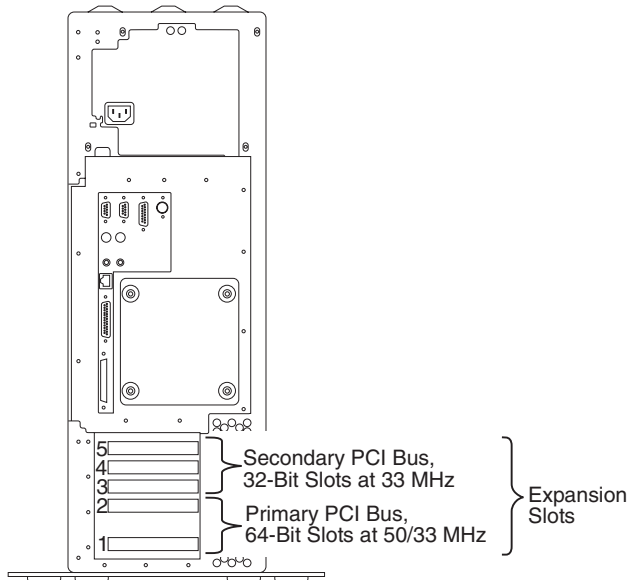

System Unit Rear View with Numbered Slots

Some adapters must be placed in specific system unit slots to function correctly at optimum performance. Use the table under “7043 Model 260 Adapter Placement Guide” to determine where to install an adapter in your system unit.

Many of the following notes refer to optimizing system performance. Read “System Performance” on page 1 for more performance-related information.

Use the rear-view diagram above to identify slot locations described in the following tables.

7043 Model 260 Adapter Placement Guide

Use the following table to identify specific slot location options for the following adapters in your 7043 Model 260 system.

If two different adapters can be placed in the same slot, the highest priority adapter starts at the top of the table. The list of slot numbers represents the order that the slots should be used.

Table 31. 7043 Model 260

Adapter	Slot Usage	System Maximum
FC 2825: POWER GXT3000P (Type 1-R)	Slot 2, 4 (see note 12 on page 151)	2
FC 2823: POWER GXT2000P (Type 1-S)	Any slot	4
FC 2851: 3MB (GXT250P) 64-BIT, 3.3 or 5V, Graphics Adapter (Type 1-M)	Any slot	4
FC 2852: 3MB (GXT255P) 64-BIT, 3.3 or 5V, Graphics Adapter (Type 1-N)	Any slot	4
FC 2841: POWER GXT300P (Type1-U)	Any slot	4
FC 2838: POWER GXT120P (Type 1-P)	Any slot (see note 6 on page 151)	4
FC 2830: POWER GXT130P (Type 1-T)	Any slot (see note 6 on page 151)	4
FC 2975: Gigabit Ethernet (UTP) 1000BaseT	Slot 1, 2	2 (see notes 9 on page 151 and 2 on page 151)
FC 2969: Gigabit Ethernet Fibre, 1000BaseT	Slot 1, 2	2 (see note 2 on page 151)
FC 6310: IBM ARTIC960 RxD Quad Digital Trunk PCI (Type 6-E)	Slots 3, 4, 5 (see "Chapter 29. Digital Trunk PCI Adapter Placement Considerations" on page 185 and note 7 on page 151)	1
FC 6311: IBM ARTIC960 RxF PCI (Type 6-G)	Slots 3, 4, 5 (see "Chapter 29. Digital Trunk PCI Adapter Placement Considerations" on page 185 and note 7 on page 151)	3
FC 2494: PCI 3-Channel Ultra2 SCSI RAID (Type 4-T)	Any slot (see note 8 on page 151)	2
FC 2708: ISDN Basic Rate PCI (Type 9-N)	Any slot	1
FC 6227: Gigabit Fibre Channel PCI (Type 4-S)	Slots 5, 4, 3, 2, 1	1

Table 31. 7043 Model 260 (continued)

Adapter	Slot Usage	System Maximum
FC 2639: Ultimedia Video Capture (Type 7-9)	Any slot (see note 8 on page 151)	1
FC 6215: PCI SSA Multi-Initiator/RAID EL (Type 4-N)	Any slot	2
FC 6222: 4-Port, SSA-RAID1 Fast Write Cache Option (Type 4-N)	N/A (see note 13 on page 151)	1
FC 6230: Advanced SerialRAID Plus (Type 4-P) FC 6230+6231: 4 Port SSA 40 w/128MB DIMM FC 6235: Fast Write Cache Option for FC 6230	Any slot	2 (see notes 4 on page 151 and 14 on page 151)
FC 6225: Advanced SSA SerialRAID (Type 4-P)	Any slot	2 (see note 4 on page 151)
FC 6231: 128 MB DIMM for FC 6230	N/A	1
FC 2947: IBM ARTIC960Hx 4-Port Selectable PCI (Type 9-R)	Any slot	2
FC 2948: IBM ARTIC960 4-Port T1/E1 PCI (Type 9-S)	Any slot	2
FC 2943: 8-Port Asynchronous EIA-232E/RS-422A PCI (Type 3-B)	Any slot	2
FC 2944: 128-Port Async Controller PCI (Type 3-C)	Any slot	2
FC 2962: 2-Port Multiprotocol PCI (Types 9-L and 9-V)	Any slot	2
FC 2946: PCI TURBOWAYS 622 PCI MMF ATM (Type A-B)	1, 2, 3, 4, 5	5 (see note 2 on page 151)
FC 2963: TURBOWAYS 155 PCI UTP ATM (Type 9-J)	Any slot	2 (see notes 3 on page 151 and 10 on page 151)

Table 31. 7043 Model 260 (continued)

Adapter	Slot Usage	System Maximum
FC 2988: TURBOWAYS 155 PCI MMF ATM (Type 9-F)	Any slot	2 (see note 3 on page 151)
FC 2742: SysKonnnect SK-NET FDDI-LP DAS PCI (Type *)	Any slot	2
FC 2741: SysKonnnect SK-NET FDDI-LP SAS PCI (Type *)	Any slot	2
FC 2743: SysKonnnect SK-NET FDDI-UP SAS PCI (Type *)	Any slot	2
FC 6205: PCI Dual Channel Ultra2 SCSI (Type 4-R)	Any slot (see notes 5 on page 151 and 6 on page 151)	2
FC 2498: PCI 4-Channel Ultra3 SCSI RAID (Type 4-X)	Any slot	2
FC 4959: High-Speed Token Ring PCI (Type 9-Y)	5, 4, 3, 2, 1	3
FC 2920: 16Mbps PCI Token-Ring (Type 9-0)	Any slot	4
FC 6206: Single-Ended Ultra SCSI Adapter (Type 4-K)	Any slot	4
FC 6207: PCI Differential Ultra SCSI (Type 4-L)	Any slot	4
FC 2968: 10/100 Mbps Ethernet Tx PCI (Type 9-P)	Any slot	4 (see note 1)
FC 2998: TURBOWAYS 25 ATM PCI (Type *)	Any slot	4
FC 4951: 10/100 4-Port Ethernet (Type 9-Z)	5, 4, 3, 2, 1	5 (see note 11 on page 151)
FC 2851: POWER GXT250P (Type 1-M)	Any slot	4
FC 2852: POWER GXT255P (Type 1-N)	Any slot	4

Notes:

1. For optimum system performance, if the FC 2968: 10/100 Mbps Ethernet Tx PCI (Type 9-P) is used in 100 Mbps mode then a maximum of three adapters is recommended per system unit.

2. For optimum system performance, a maximum of one of the following adapters is recommended per system:
 - FC 2969: Gigabit Ethernet Fibre, 1000BaseT
 - FC 2975: Gigabit Ethernet (UTP) 1000BaseT
 - FC 2946: PCI TURBOWAYS 622 PCI MMF ATM (Type A-B)
3. When in LAN emulation mode, install a maximum of three 155 TURBOWAYS ATM PCI MMFs for optimum system performance.
4. You may install any combination of FC 6225: Advanced SSA SerialRAID (Type 4-P) and FC 6230: Advanced SerialRAID Plus (Type 4-P) adapters, as long as that combination does not exceed two per system unit.
5. For optimum system performance, put the FC 6205: PCI Dual Channel Ultra2 SCSI (Type 4-R) adapters in slots 1-2.
6. Do not install a FC 6205: PCI Dual Channel Ultra2 SCSI (Type 4-R) Adapter in the same PCI bus as a FC 2838: POWER GXT120P (Type 1-P) or a FC 2830: POWER GXT130P (Type 1-T).
7. Do not install more than a combination of four FC 6311: IBM ARTIC960 RxF PCI (Type 6-G) s and FC 6310: IBM ARTIC960 RxD Quad Digital Trunk PCI (Type 6-E)s in this system.
8. The FC 2639: Ultimedia Video Capture (Type 7-9) adapter may not occupy the same PCI bus as the FC 2494: PCI 3-Channel Ultra2 SCSI RAID (Type 4-T) adapters.
9. Install a maximum of one FC 2975: Gigabit Ethernet (UTP) 1000BaseT adapter per system (if configured to run at 1000 Mbps) for optimum performance. If you have configured the adapter to run at 100 Mbps, use up to three for optimum performance.
10. Install a maximum of one FC 2963: TURBOWAYS 155 PCI UTP ATM (Type 9-J) adapter per system for optimum system performance.
11. Install a maximum of one FC 4951: 10/100 4-Port Ethernet (Type 9-Z) adapters configured to run at 100 Mbps mode per system for optimum performance.
12. If two FC 2825: POWER GXT3000P (Type 1-R) adapters are placed in slots 2 and 4, then slot 3 is covered and cannot be used.
13. FC 6222: 4-Port, SSA-RAID1 Fast Write Cache Option (Type 4-N) is a cache upgrade for the Campbell RAID adapter and can only be selected along with FC 6215: PCI SSA Multi-Initiator/RAID EL (Type 4-N) (maximum 1 per 6215).
14. FC 6235: Fast Write Cache Option for FC 6230 is a cache upgrade for the FC 6225: Advanced SSA SerialRAID (Type 4-P) adapter and can only be selected along with FC 6225 or FC 6230: Advanced SerialRAID Plus (Type 4-P) (maximum 1 per 6225/6230).

7043 Model 260 Multiple Graphics Adapter Placement Guide

Use the following table to identify adapter location combination options for these adapters in your 7043 Model 260.

Do not install more than four graphics adapters in your 7043 Model 260.

Table 32. 7043 Model 260

Adapter	AIX
FC 2838: POWER GXT120P (Type 1-P) or FC 2830: POWER GXT130P (Type 1-T) or FC 2851: POWER GXT250P (Type 1-M) or FC 2852: POWER GXT255P (Type 1-N) or FC 2823: POWER GXT2000P (Type 1-S) or FC 2841: POWER GXT300P (Type1-U) with a FC 2838: POWER GXT120P (Type 1-P) or FC 2830: POWER GXT130P (Type 1-T) or FC 2851: POWER GXT250P (Type 1-M) or FC 2852: POWER GXT255P (Type 1-N) or FC 2823: POWER GXT2000P (Type 1-S) or FC 2841: POWER GXT300P (Type1-U)	Slot 1 - 5 (see note 1)
FC 2838: POWER GXT120P (Type 1-P) or FC 2830: POWER GXT130P (Type 1-T) or FC 2851: POWER GXT250P (Type 1-M) or FC 2852: POWER GXT255P (Type 1-N) or FC 2823: POWER GXT2000P (Type 1-S) or FC 2841: POWER GXT300P (Type1-U)	Slot 1 - 5
FC 2838: POWER GXT120P (Type 1-P) or FC 2830: POWER GXT130P (Type 1-T) or FC 2851: POWER GXT250P (Type 1-M) or FC 2852: POWER GXT255P (Type 1-N) or FC 2823: POWER GXT2000P (Type 1-S) or FC 2841: POWER GXT300P (Type1-U) with a FC 2825: POWER GXT3000P (Type 1-R)	Slots 1, 3, 4, 5 (see note 1) Slot 2
FC 2639: Ultimedia Video Capture (Type 7-9) with a FC 2825: POWER GXT3000P (Type 1-R)	Slots 1, 3, 4, 5 (see note 1) Slot 2
FC 2639: Ultimedia Video Capture (Type 7-9) with a FC 2823: POWER GXT2000P (Type 1-S)	Slot 1 - 5 (see note 1) Slot 1 - 5
FC 2639: Ultimedia Video Capture (Type 7-9) with a FC 2841: POWER GXT300P (Type1-U)	Slot 1 - 5 Slot 1 - 5 (see note 1)

Notes:

1. Since slots 1 and 2 are capable of running at 50 mhz, the GXT250P, GXT255P, GXT2000P, GXT 3000P and FC 2841: POWER GXT300P (Type1-U) should be placed in these slots for optimum performance. Take care when placing the GXT120P or FC 2830: POWER GXT130P (Type 1-T) (or any other 33 Mhz PCI adapter) in slots 1 and 2, because this forces the slots to run at 33 Mhz.

Chapter 23. 7044 Model 170

This system is designed for customers to install adapters. Use this guide to determine if there are specific slot requirements for adapters that you may be installing.

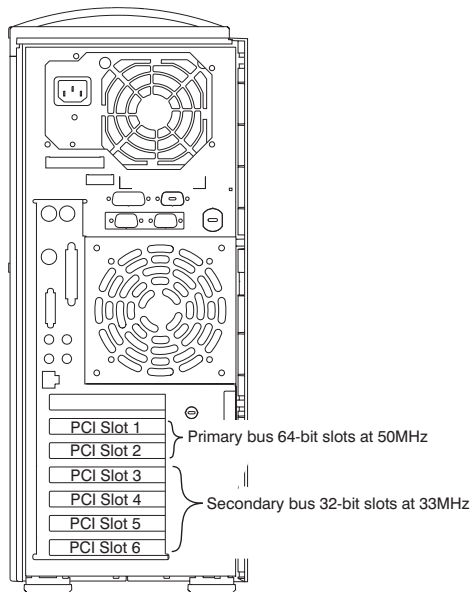

System Unit Rear View with Numbered Slots

Some adapters must be placed in specific system unit slots to function correctly at optimum performance. Use the table under “7044 Model 170 Adapter Placement Guide” on page 156 to determine where to install an adapter in your system unit.

Many of the following notes refer to optimizing system performance. Read “System Performance” on page 1 for more performance-related information.

Use the rear-view diagram above to identify slot locations described in the following tables.

7044 Model 170 Adapter Placement Guide

Use the following table to identify specific slot location options for the following adapters in your 7044 Model 170 system.

Table 33. 7044 Model 170

Adapter	Slot Usage	System Maximum
FC 2827: POWER GXT6000P (Type 1-W)	Slot 1, 2, 3, 4, 5, 6	2
FC 2843: Power GXT6500P Graphics Adapter (Type 1-Z)	Slot 1, 2, 3, 4, 5, 6	4
FC 2842: Power GXT4500P Graphics Adapter (Type 1-Y)	Slot 1, 2, 3, 4, 5, 6	2
FC 2825: POWER GXT3000P (Type 1-R)	Slot 2 (see note 11 on page 160)	1
FC 2969: Gigabit Ethernet Fibre, 1000BaseT	Slots 1, 2, 3, 4, 5, 6	6 (see note 2 on page 159)
FC 2975: Gigabit Ethernet (UTP) 1000BaseT	Slots 1, 2, 3, 4, 5, 6	6 (see notes 2 on page 159 and 6 on page 159)
FC 2826: POWER GXT4000P (Type 1-V)	Slots 1, 2, 3, 4, 5, 6	4
FC 2830: POWER GXT130P (Type 1-T)	Slots 6, 5, 4, 3	4
FC 2848: GXT135P Graphics Adapter (Type 1-X)	Slots 1, 2, 3, 4, 5, 6	4 (see note 17 on page 160)
FC 2823: POWER GXT2000P (Type 1-S)	Slots 1, 2, 3, 4, 5, 6	4
FC 2841: POWER GXT300P (Type 1-U)	Slots 1, 2, 3, 4, 5, 6	4
FC 2498: PCI 4-Channel Ultra3 SCSI RAID (Type 4-X)	Slots 1, 2, 6, 5, 4, 3	4 (see note 10 on page 159)
FC 4958: Cryptographic Coprocessor	Slots 1, 2	2
FC 4963: Cryptographic Coprocessor, FIPS-4	Slots 1, 2	2
FC 2494: PCI 3-Channel Ultra2 SCSI RAID (Type 4-T)	Slots 6, 5, 4, 3 (see note 1 on page 159)	2
FC 2943: 8-Port Asynchronous EIA-232E/RS-422A PCI (Type 3-B)	Slots 6, 5, 4, 3	2

Table 33. 7044 Model 170 (continued)

Adapter	Slot Usage	System Maximum
FC 2944: 128-Port Async Controller PCI (Type 3-C)	Slots 6, 5, 4, 3	2
FC 2962: 2-Port Multiprotocol PCI (Types 9-L and 9-V)	Slots 6, 5, 4, 3	2
FC 6206: Single-Ended Ultra SCSI Adapter (Type 4-K)	Slots 6, 5, 4, 3	4
FC 6203: Dual-Channel Ultra3 SCSI (Type 4-Y)	Slots 6, 5, 4, 3, 2, 1	4
FC 2639: Ultimedia Video Capture (Type 7-9)	Slots 6, 5, 4, 3 (see note 1 on page 159)	1
FC 4951: 10/100 4-Port Ethernet (Type 9-Z)	Slots 6, 5, 4, 3	4 (see note 13 on page 160)
FC 2985: Ethernet 10base2 PCI (Type 8-Y)	Slots 6, 5, 4, 3	4
FC 2987: Ethernet 10base5 PCI (Type 8-Z)	Slots 6, 5, 4, 3	4
FC 2968: 10/100 Mbps Ethernet Tx PCI (Type 9-P)	Slots 6, 5, 4, 3, 2, 1	4 (see note 5 on page 159)
FC 4962: Ethernet/LAN Encryption 10/100BaseT	Slots 6, 5, 4, 3, 2, 1	4 (see note 5 on page 159)
FC 4961: 10/100 4-Port Ethernet (Type A-E)	Slots 6, 5, 4, 3, 2, 1	5 (see note 13 on page 160)
FC 6227: Gigabit Fibre Channel PCI (Type 4-S)	Slots 6, 5, 4, 3, 2, 1	2 (see note 9 on page 159)
FC 6228: Gigabit Fibre Channel Adapter, 32 or 64-bit PCI Bus (Type 4-W)	Slots 6, 5, 4, 3, 2, 1	2 (see note 16 on page 160)
FC 6204: PCI Universal Differential Ultra SCSI (Type 4-U)	Slots 6, 5, 4, 3, 2, 1	4
FC 6205: PCI Dual Channel Ultra2 SCSI (Type 4-R)	Slots 6, 5, 4, 3, 2, 1	4
FC 4959: High-Speed Token Ring PCI (Type 9-Y)	Slots 6, 5, 4, 3, 2, 1	4
FC 2998: TURBOWAYS 25 ATM PCI (Type *)	Slots 6, 5, 4, 3, 2, 1	4
FC 6310: IBM ARTIC960 RxD Quad Digital Trunk PCI (Type 6-E)	Slots 6, 5, 4, 3, 2, 1	3

Table 33. 7044 Model 170 (continued)

Adapter	Slot Usage	System Maximum
FC 6311: IBM ARTIC960 RxF PCI (Type 6-G)	Slots 6, 5, 4, 3, 2, 1	2 see "Chapter 29. Digital Trunk PCI Adapter Placement Considerations" on page 185
FC 6230: Advanced SerialRAID Plus (Type 4-P) FC 6235: Fast Write Cache Option for FC 6230 FC 6230+6231: 4 Port SSA 40 w/128MB DIMM	Slots 6, 5, 4, 3, 2, 1	2 (see notes 7 on page 159 and 8 on page 159)
FC 2708: ISDN Basic Rate PCI (Type 9-N)	Slots 6, 5, 4, 3, 2, 1	1
FC 2947: IBM ARTIC960Hx 4-Port Selectable PCI (Type 9-R)	Slots 6, 5, 4, 3, 2, 1	2
FC 2946: PCI TURBOWAYS 622 PCI MMF ATM (Type A-B)	Slots 6, 5, 4, 3, 2, 1	6 (see note 2 on page 159)
FC 2963: TURBOWAYS 155 PCI UTP ATM (Type 9-J)	Slots 6, 5, 4, 3, 2, 1	6 (see notes 3 on page 159, 14 on page 160, and 15 on page 160)
FC 4953: 64-bit/66MHz PCI ATM 155 UTP (Type A-C)	Slots 6, 5, 4, 3, 2, 1	6 (see notes 3 on page 159, 14 on page 160, and 15 on page 160)
FC 2988: TURBOWAYS 155 PCI MMF ATM (Type 9-F)	Slots 6, 5, 4, 3, 2, 1	6 (see notes 3 on page 159, 14 on page 160, and 15 on page 160)
FC 4957: 64-bit/66MHz PCI ATM 155 MMF (Type A-D)	Slots 6, 5, 4, 3, 2, 1	6 (see notes 3 on page 159, 14 on page 160, and 15 on page 160)
FC 2742: SysKonnnect SK-NET FDDI-LP DAS PCI (Type *)	Slots 6, 5, 4, 3, 2, 1	6 (see notes 4 on page 159 and 12 on page 160)

Table 33. 7044 Model 170 (continued)

Adapter	Slot Usage	System Maximum
FC 2741: SysKonnnect SK-NET FDDI-LP SAS PCI (Type *)	Slots 6, 5, 4, 3, 2, 1	6 (see notes 4 and 12 on page 160)
FC 2743: SysKonnnect SK-NET FDDI-UP SAS PCI (Type *)	Slots 6, 5, 4, 3, 2, 1	6 (see notes 4 and 12 on page 160)
FC 4960: IBM Cryptographic Accelerator (Type 6-J)	Slots 6, 5, 4, 3, 2, 1	4

Notes:

- Do not install FC 2494: PCI 3-Channel Ultra2 SCSI RAID (Type 4-T) and FC 2639: Ultimedia Video Capture (Type 7-9) adapters on the same system.
- For optimum system performance, a *combination* of the following adapters should not exceed a maximum of one adapter per system:
 - FC 2969: Gigabit Ethernet Fibre, 1000BaseT
 - FC 2975: Gigabit Ethernet (UTP) 1000BaseT
 - FC 2946: PCI TURBOWAYS 622 PCI MMF ATM (Type A-B)

Use slots 1 or 2 if available.
- For optimum system performance, install up to 5 FC 2963: TURBOWAYS 155 PCI UTP ATM (Type 9-J), FC 2988: TURBOWAYS 155 PCI MMF ATM (Type 9-F), FC 4953: 64-bit/66MHz PCI ATM 155 UTP (Type A-C), or FC 4957: 64-bit/66MHz PCI ATM 155 MMF (Type A-D) adapters. Install up to 3 of these adapters if you are in MTU 1500 mode.
- For optimum system performance, install up to five SysKonnnect adapters in this system.
- For optimum system performance, install up to three FC 2968: 10/100 Mbps Ethernet Tx PCI (Type 9-P) or FC 4962: Ethernet/LAN Encryption 10/100BaseT adapters in this system.
- If your adapter is configured for 100 Mbps mode, install a maximum of two for optimum performance.
- FC 6230: Advanced SerialRAID Plus (Type 4-P) can be selected with or without the cache upgrade (FC 6235).
- FC 6235: Fast Write Cache Option for FC 6230 is a cache upgrade for the FC 6225: Advanced SSA SerialRAID (Type 4-P) adapter and can only be selected along with FC 6230 (1 maximum).
- A maximum of two FC 6227: Gigabit Fibre Channel PCI (Type 4-S) adapters are supported. One must be in slot 3, 4, 5 or 6; the second in either slot 1 or 2.
- For FC 2498: PCI 4-Channel Ultra3 SCSI RAID (Type 4-X) adapter cards shipping in 7044-170, the plastic handle on the end of the card must be replaced by a Metal Handle (PN 09P1971) and 2 screws (PN 1621170).

11. When placed in slot 2, the FC 2825: POWER GXT3000P (Type 1-R) covers both slots 2 and 3.
12. For optimum system performance, a maximum of five FC 2741: SysKonnnect SK-NET FDDI-LP SAS PCI (Type *), FC 2742: SysKonnnect SK-NET FDDI-LP DAS PCI (Type *), and FC 2743: SysKonnnect SK-NET FDDI-UP SAS PCI (Type *) adapters per system is recommended.
13. For optimum system performance, a maximum of one FC 4961: 10/100 4-Port Ethernet (Type A-E) or FC 4951: 10/100 4-Port Ethernet (Type 9-Z) adapters per system (with a maximum of three ports) is recommended.
14. For optimum system performance, a maximum of 3 is recommended for the FC 2963: TURBOWAYS 155 PCI UTP ATM (Type 9-J) and FC 4953: 64-bit/66MHz PCI ATM 155 UTP (Type A-C) MTU 1500, and FC 2988: TURBOWAYS 155 PCI MMF ATM (Type 9-F) and FC 4957: 64-bit/66MHz PCI ATM 155 MMF (Type A-D) MTU 1500 adapters.
15. For optimum system performance, a maximum of 5 per system is recommended for both the FC 2963: TURBOWAYS 155 PCI UTP ATM (Type 9-J) and FC 4953: 64-bit/66MHz PCI ATM 155 UTP (Type A-C) MTU 9180 adapters, and FC 2988: TURBOWAYS 155 PCI MMF ATM (Type 9-F) and FC 4957: 64-bit/66MHz PCI ATM 155 MMF (Type A-D) MTU 9180 adapters.
16. A maximum of two FC 6228: Gigabit Fibre Channel Adapter, 32 or 64-bit PCI Bus (Type 4-W) adapters are supported. One must be in slot 3, 4, 5 or 6; the second in either slot 1 or 2.
17. A maximum of three FC 2848: GXT135P Graphics Adapter (Type 1-X) adapters are supported in slots 3 through 6.

Table 34. 7044 Model 170 (continued)

Adapter	Slots
with a FC 2823: POWER GXT2000P (Type 1-S)	Slots 1 or 2
FC 2830: POWER GXT130P (Type 1-T) or FC 2848: GXT135P Graphics Adapter (Type 1-X) with a FC 2825: POWER GXT3000P (Type 1-R)	Slot 3, 4, 5, 6 Slot 2 (see note 1)
FC 2830: POWER GXT130P (Type 1-T) or FC 2848: GXT135P Graphics Adapter (Type 1-X) with a FC 2841: POWER GXT300P (Type1-U) or FC 2639: Ultimedia Video Capture (Type 7-9)	Slots 3 - 6 Slots 3 - 6

Notes:

1. Since slots 1 and 2 are capable of running at 50 mhz, the FC 2823: POWER GXT2000P (Type 1-S) and FC 2825: POWER GXT3000P (Type 1-R) should be placed in these slots for optimum performance. Take care when placing any 33 Mhz PCI adapter in slots 1 and 2, because this forces the slots to run at 33 Mhz.

Chapter 24. 7044 Model 270

This system is designed for customers to install adapters. Use this guide to determine if there are specific slot requirements for adapters that you may be installing.

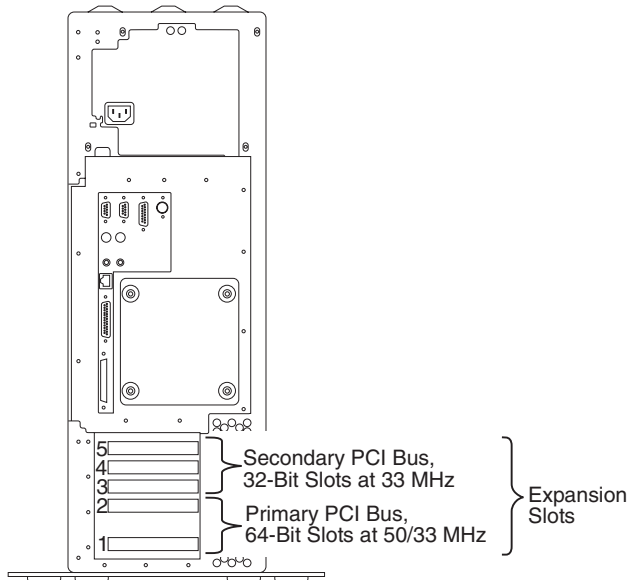

System Unit Rear View with Numbered Slots

Some adapters must be placed in specific system unit slots to function correctly at optimum performance. Use the table under “7044 Model 270 Adapter Placement Guide” to determine where to install an adapter in your system unit.

Many of the following notes refer to optimizing system performance. Read “System Performance” on page 1 for more performance-related information.

Use the rear-view diagram above to identify slot locations described in the following tables.

7044 Model 270 Adapter Placement Guide

Use the following table to identify specific slot location options for the following adapters in your 7044 Model 270 system.

If two different adapters can be placed in the same slot, the highest priority adapter starts at the top of the table. The list of slot numbers represent the order that the slots should be used.

Table 35. 7044 Model 270

Adapter	Slot Usage	System Maximum
FC 2842: Power GXT4500P Graphics Adapter (Type 1-Y)	Any slot	4
FC 2826: POWER GXT4000P (Type 1-V)	Any slot	4
FC 2843: Power GXT6500P Graphics Adapter (Type 1-Z)	Any slot	2
FC 2827: POWER GXT6000P (Type 1-W)	Slots 2, 4	2
FC 2825: POWER GXT3000P (Type 1-R)	Slots 2, 4 (see note 8 on page 167)	2
FC 2969: Gigabit Ethernet Fibre, 1000BaseT	Slots 1, 2, 3, 4, 5 (see notes 2 on page 166 and 4 on page 166)	5
FC 2975: Gigabit Ethernet (UTP) 1000BaseT	Slots 1, 2, 3, 4, 5 (see notes 2 on page 166 and 4 on page 166)	5
FC 2823: POWER GXT2000P (Type 1-S)	Any slot	4
FC 2848: GXT135P Graphics Adapter (Type 1-X)	Any slot	4
FC 2830: POWER GXT130P (Type 1-T)	Slots 5, 4, 3	3
FC 2841: POWER GXT300P (Type 1-U)	Any slot	4
FC 2708: ISDN Basic Rate PCI (Type 9-N)	Slots 5, 4, 3	1
FC 4961: 10/100 4-Port Ethernet (Type A-E)	Slots 1, 2, 3, 4, 5	5 (see note 5 on page 167)
FC 4951: 10/100 4-Port Ethernet (Type 9-Z)	Slots 5, 4, 3	3 (see note 5 on page 167)
FC 4958: Cryptographic Coprocessor	Slots 2, 1	2
FC 4963: Cryptographic Coprocessor, FIPS-4	Slots 2, 1	2
FC 2494: PCI 3-Channel Ultra2 SCSI RAID (Type 4-T)	Slots 5, 4, 3	2 (see note 1 on page 166)
FC 2639: Ultimedia Video Capture (Type 7-9)	Slots 5, 4, 3	1 (see note 1 on page 166)

Table 35. 7044 Model 270 (continued)

Adapter	Slot Usage	System Maximum
FC 2962: 2-Port Multiprotocol PCI (Types 9-L and 9-V)	Slots 5, 4, 3	2
FC 6206: Single-Ended Ultra SCSI Adapter (Type 4-K)	Slots 5, 4, 3	3
FC 6205: PCI Dual Channel Ultra2 SCSI (Type 4-R)	Any slot	2
FC 6203: Dual-Channel Ultra3 SCSI (Type 4-Y)	Any slot	2
FC 2498: PCI 4-Channel Ultra3 SCSI RAID (Type 4-X)	Any slot	4
FC 6310: IBM ARTIC960 RxD Quad Digital Trunk PCI (Type 6-E)	Slots 3, 4, 5	3
FC 6311: IBM ARTIC960 RxF PCI (Type 6-G)	Slots 3, 4, 5	3 see "Chapter 29. Digital Trunk PCI Adapter Placement Considerations" on page 185
FC 6227: Gigabit Fibre Channel PCI (Type 4-S)	Any slot (see note 9 on page 167)	2
FC 6228: Gigabit Fibre Channel Adapter, 32 or 64-bit PCI Bus (Type 4-W)	Slots 5, 4, 3, 2, 1 (see note 9 on page 167)	2
FC 6230: Advanced SerialRAID Plus (Type 4-P) FC 6230+6231: 4 Port SSA 40 w/128MB DIMM FC 6235: Fast Write Cache Option for FC 6230	Any slot	2 (see notes 6 on page 167 and 7 on page 167)
FC 2947: IBM ARTIC960Hx 4-Port Selectable PCI (Type 9-R)	Any slot	2
FC 2943: 8-Port Asynchronous EIA-232E/RS-422A PCI (Type 3-B)	Any slot	2
FC 2944: 128-Port Async Controller PCI (Type 3-C)	Any slot	2
FC 2946: PCI TURBOWAYS 622 PCI MMF ATM (Type A-B)	Slots 1, 2, 3, 4, 5	5 (see note 2 on page 166)
FC 2963: TURBOWAYS 155 PCI UTP ATM (Type 9-J)	Any slot	5

Table 35. 7044 Model 270 (continued)

Adapter	Slot Usage	System Maximum
FC 4953: 64-bit/66MHz PCI ATM 155 UTP (Type A-C)	Any slot	5
FC 2988: TURBOWAYS 155 PCI MMF ATM (Type 9-F)	Any slot	5
FC 4957: 64-bit/66MHz PCI ATM 155 MMF (Type A-D)	Any slot	5
FC 2742: SysKonnnect SK-NET FDDI-LP DAS PCI (Type *)	Any slot	5
FC 2741: SysKonnnect SK-NET FDDI-LP SAS PCI (Type *)	Any slot	5
FC 2743: SysKonnnect SK-NET FDDI-UP SAS PCI (Type *)	Any slot	5
FC 4959: High-Speed Token Ring PCI (Type 9-Y)	Any slot	4
FC 2968: 10/100 Mbps Ethernet Tx PCI (Type 9-P)	Any slot	5 (see note 3)
FC 4962: Ethernet/LAN Encryption 10/100BaseT	Any slot	5 (see note 3)
FC 2998: TURBOWAYS 25 ATM PCI (Type *)	Any slot	4
FC 6204: PCI Universal Differential Ultra SCSI (Type 4-U)	Any slot	4 (see note 2)
FC 4960: IBM Cryptographic Accelerator (Type 6-J)	Slots 5, 4, 3, 2, 1	4

1. Do not install FC 2639: Ultimedia Video Capture (Type 7-9) and FC 2494: PCI 3-Channel Ultra2 SCSI RAID (Type 4-T) adapters on the same system.
2. For optimum system performance, a *combination* of the following adapters should not exceed a maximum of two adapters per system:
 - FC 2969: Gigabit Ethernet Fibre, 1000BaseT
 - FC 2975: Gigabit Ethernet (UTP) 1000BaseT
 - FC 2946: PCI TURBOWAYS 622 PCI MMF ATM (Type A-B)

Install them in slots 1 and 2 (if available).

3. 7044 Model 270 supports up to five FC 2968: 10/100 Mbps Ethernet Tx PCI (Type 9-P) or FC 4962: Ethernet/LAN Encryption 10/100BaseT adapters per system, making the total six if you use the Integrated Ethernet port.
4. For optimum system performance, install a maximum combination of two FC 2975: Gigabit Ethernet (UTP) 1000BaseT adapters per system, or two FC 2969: Gigabit Ethernet Fibre, 1000BaseT, or one of each, when configured to run at 1000 Mbps.

If the adapter is configured for 100 Mbps mode, use up to five of these adapters (plus the integrated 100Mbps port) for optimum performance.

5. For optimum system performance, install a maximum of two FC 4951: 10/100 4-Port Ethernet (Type 9-Z) or FC 4961: 10/100 4-Port Ethernet (Type A-E) adapters in 100 Mbps mode per system.
6. FC 6230: Advanced SerialRAID Plus (Type 4-P) can be selected with or without the cache upgrade (FC 6235: Fast Write Cache Option for FC 6230).
7. FC 6235: Fast Write Cache Option for FC 6230 is a cache upgrade for the FC 6225: Advanced SSA SerialRAID (Type 4-P) adapter and can only be selected along with FC 6230: Advanced SerialRAID Plus (Type 4-P) (maximum 1 per 6230).
8. If two FC 2825: POWER GXT3000P (Type 1-R) adapters are placed in slots 2 and 4, then slot 3 is covered and cannot be used.
9. FC 6227: Gigabit Fibre Channel PCI (Type 4-S) and FC 6228: Gigabit Fibre Channel Adapter, 32 or 64-bit PCI Bus (Type 4-W) adapters are restricted to only one adapter in slot 1 or 2 and/or one adapter in slot 3 or 4 or 5.

Notes:

1. Since slots 1 and 2 are capable of running at 50 mhz, the GXT 2000P and GXT 3000P should be placed in these slots for optimum performance.
2. FC 2830: POWER GXT130P (Type 1-T) cannot be placed in either slot 1 or 2.
3. FC 2639: Ultimedia Video Capture (Type 7-9) cannot be placed in slot 1.

Chapter 25. 7046 Model B50

This system is designed for customers to install adapters. Use this guide to determine if there are specific slot requirements for adapters that you may be installing.

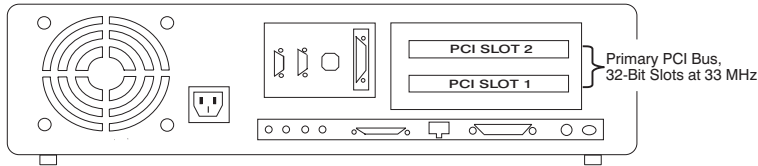

System Unit Rear View with Numbered Slots

Some adapters must be placed in specific system unit slots to function correctly at optimum performance. Use the table under “7046 Model B50 Adapter Placement Guide” to determine where to install an adapter in your system unit. Please note that PCI slot 1 can hold short cards only.

Many of the following notes refer to optimizing system performance. Read “System Performance” on page 1 for more performance-related information.

Use the rear-view diagram above to identify slot locations described in the following tables.

7046 Model B50 Adapter Placement Guide

Use the following table to identify specific slot location options for the following adapters in your 7046 Model B50 system.

Table 37. 7046 Model B50

Adapter	Slot Usage	System Maximum
FC 2830: POWER GXT130P (Type 1-T)	Slot 1 or 2	1
FC 2841: Mirage 2D(GTX300P)	Slot 1 or 2	1
FC 2848: GXT135P Graphics Adapter (Type 1-X)	Slot 1 or 2	1
FC 6206: Single-Ended Ultra SCSI Adapter (Type 4-K)	Slot 1-2	2
FC 6207: PCI Differential Ultra SCSI (Type 4-L)	Slot 1-2	2
FC 6205: PCI Dual Channel Ultra2 SCSI (Type 4-R)	Slot 2 only	1
FC 6203: Dual-Channel Ultra3 SCSI (Type 4-Y)	Slot 1-2	1

Table 37. 7046 Model B50 (continued)

Adapter	Slot Usage	System Maximum
FC 2494: PCI 3-Channel Ultra2 SCSI RAID (Type 4-T)	Slot 2	1
FC 6230: Advanced SerialRAID Plus (Type 4-P) FC 6230+6231: 4 Port SSA 40 w/128MB DIMM FC 6235: Fast Write Cache Option for FC 6230	Slot 2	1
FC 6204: PCI Universal Differential Ultra SCSI (Type 4-U)	Slot 2	1
FC 2498: PCI 4-Channel Ultra3 SCSI RAID (Type 4-X)	Slot 2	1
FC 6231: 128 MB DIMM for FC 6230	N/A	1
FC 2947: IBM ARTIC960Hx 4-Port Selectable PCI (Type 9-R)	Slot 2	1
FC 2948: IBM ARTIC960 4-Port T1/E1 PCI (Type 9-S)	Slot 2	1
FC 2968: 10/100 Mbps Ethernet Tx PCI (Type 9-P)	Slot 1-2	2 (see note 1 on page 173)
FC 4962: Ethernet/LAN Encryption 10/100BaseT	Slot 1-2	2 (see note 1 on page 173)
FC 2943: 8-Port Asynchronous EIA-232E/RS-422A PCI (Type 3-B)	Slot 1-2	2
FC 2944: 128-Port Async Controller PCI (Type 3-C)	Slot 1-2	2
FC 2962: 2-Port Multiprotocol PCI (Types 9-L and 9-V)	Slot 1-2	2
FC 2963: TURBOWAYS 155 PCI UTP ATM (Type 9-J)	Slot 1-2	2 (see note 2 on page 173)
FC 2988: TURBOWAYS 155 PCI MMF ATM (Type 9-F)	Slot 1-2	2 (see note 2 on page 173)

Table 37. 7046 Model B50 (continued)

Adapter	Slot Usage	System Maximum
FC 4953: 64-bit/66MHz PCI ATM 155 UTP (Type A-C)	Slot 1-2	2 (see note 2)
FC 4957: 64-bit/66MHz PCI ATM 155 MMF (Type A-D)	Slot 1-2	2 (see note 2)
FC 2708: ISDN Basic Rate PCI (Type 9-N)	Slot 1-2	2
FC 2742: SysKonnnect SK-NET FDDI-LP DAS PCI (Type *)	Slot 1-2	1
FC 2741: SysKonnnect SK-NET FDDI-LP SAS PCI (Type *)	Slot 1-2	1
FC 2743: SysKonnnect SK-NET FDDI-UP SAS PCI (Type *)	Slot 1-2	1
FC 4959: High-Speed Token Ring PCI (Type 9-Y)	Slot 1-2	2
FC 4951: 10/100 4-Port Ethernet (Type 9-Z)	Slot 2	1 (see note 3)
FC 4960: IBM Cryptographic Accelerator (Type 6-J)	Slots 1-2	1
FC 4961: 10/100 4-Port Ethernet (Type A-E)	Slot 2	1
FC 4963: Cryptographic Coprocessor, FIPS-4	Slot 1	1
FC 4958: Cryptographic Coprocessor	Slot 2	1
FC 6225: Advanced SSA SerialRAID (Type 4-P)	Slot 2	1

Notes:

1. For optimum system performance, if the FC 2968: 10/100 Mbps Ethernet Tx PCI (Type 9-P) or FC 4962: Ethernet/LAN Encryption 10/100BaseT is used in 100 Mbps mode, then a maximum of one adapter is recommended per system unit.
2. For optimum system performance, when using a FC 2988: TURBOWAYS 155 PCI MMF ATM (Type 9-F), FC 2963: TURBOWAYS 155 PCI UTP ATM (Type 9-J), FC 4953: 64-bit/66MHz PCI ATM 155 UTP (Type A-C), or FC 4957: 64-bit/66MHz PCI ATM 155 MMF (Type A-D) adapter in LAN Emulation (LANE), a maximum of one adapter per system is recommended.
3. For optimum system performance, use only two 100 Mbs ports per system.

Chapter 26. pSeries 640 Model B80

This system is designed for customers to install adapters. Use this guide to determine if there are specific slot requirements for adapters that you may be installing.

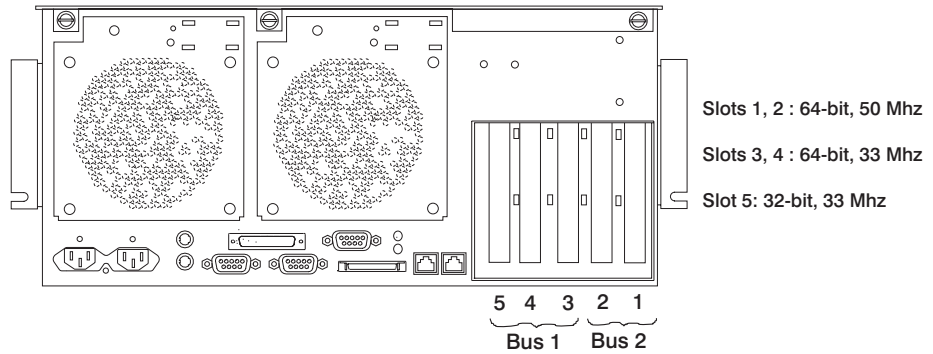

System Unit Rear View with Numbered Slots

Some adapters must be placed in specific system unit slots to function correctly at optimum performance. Use the table under “pSeries 640 Model B80 Adapter Placement Guide” to determine where to install an adapter in your system unit.

Many of the following notes refer to optimizing system performance. Read “System Performance” on page 1 for more performance-related information.

Use the rear-view diagram above to identify slot locations described in the following tables.

pSeries 640 Model B80 Adapter Placement Guide

Use the following table to identify specific slot location options for the following adapters in your pSeries 640 Model B80 system.

If two different adapters can be placed in the same slot, the highest priority adapter starts at the top of the table. The list of slot numbers represent the order that the slots should be used.

Table 38. pSeries 640 Model B80

Adapter	Slot Usage	System Maximum
FC 6227: Gigabit Fibre Channel PCI (Type 4-S)	Slots 5, 4, 3, 2, 1	2
FC 6228: Gigabit Fibre Channel Adapter, 32 or 64-bit PCI Bus (Type 4-W)	Slots 5, 4, 3, 2, 1	2

Table 38. pSeries 640 Model B80 (continued)

Adapter	Slot Usage	System Maximum
FC 4951: 10/100 4-Port Ethernet (Type 9-Z)	Slots 4, 3	2
FC 4958: Cryptographic Coprocessor	Slots 2, 1	2
FC 4963: Cryptographic Coprocessor, FIPS-4	Slots 2, 1	2
FC 2830: POWER GXT130P (Type 1-T)	Slots 5, 4, 3	1
FC 2848: GXT135P Graphics Adapter (Type 1-X)	Slots 5, 4, 3, 2, 1	1
FC 2962: 2-Port Multiprotocol PCI (Types 9-L and 9-V)	Slots 3, 4, 5	3
FC 2969: Gigabit Ethernet Fibre, 1000BaseT	Slots 5, 4, 3, 2, 1	5 (see notes 1 on page 178 and 3 on page 178)
FC 2498: PCI 4-Channel Ultra3 SCSI RAID (Type 4-X)	Slots 1, 2, 3, 4	4
FC 6205: PCI Dual Channel Ultra2 SCSI (Type 4-R)	Slots 1, 2, 3, 4	4
FC 6203: Dual-Channel Ultra3 SCSI (Type 4-Y)	Slots 1, 2, 3, 4	4
FC 6230: Advanced SerialRAID Plus (Type 4-P) FC 6230+6231: 4 Port SSA 40 w/128MB DIMM FC 6235: Fast Write Cache Option for FC 6230	Slots 4, 3, 2, 1 (see notes 5 on page 178 and 6 on page 178)	2
FC 2947: IBM ARTIC960Hx 4-Port Selectable PCI (Type 9-R)	Slots 4, 3, 2, 1	4
FC 6310: IBM ARTIC960 RxD Quad Digital Trunk PCI (Type 6-E)	Slots 4, 3, 2, 1	3
FC 6311: IBM ARTIC960 RxF PCI (Type 6-G)	Slots 4, 3, 2, 1	3 see "Chapter 29. Digital Trunk PCI Adapter Placement Considerations" on page 185
FC 4961: 10/100 4-Port Ethernet (Type A-E)	Slots 4, 3, 2, 1	4 (see notes 1 on page 178 and 4 on page 178)

Table 38. pSeries 640 Model B80 (continued)

Adapter	Slot Usage	System Maximum
FC 2943: 8-Port Asynchronous EIA-232E/RS-422A PCI (Type 3-B)	Slots 5, 4, 3, 2, 1	5
FC 2944: 128-Port Async Controller PCI (Type 3-C)	Slots 5, 4, 3, 2, 1	5
FC 2946: PCI TURBOWAYS 622 PCI MMF ATM (Type A-B)	Slots 5, 4, 3, 2, 1	5 (see note 1 on page 178)
FC 2963: TURBOWAYS 155 PCI UTP ATM (Type 9-J)	Slots 5, 4, 3, 2, 1	5
FC 4953: 64-bit/66MHz PCI ATM 155 UTP (Type A-C)	Slots 5, 4, 3, 2, 1	5
FC 2988: TURBOWAYS 155 PCI MMF ATM (Type 9-F)	Slots 5, 4, 3, 2, 1	5
FC 4957: 64-bit/66MHz PCI ATM 155 MMF (Type A-D)	Slots 5, 4, 3, 2, 1	5
FC 2742: SysKonnnect SK-NET FDDI-LP DAS PCI (Type *)	Slots 5, 4, 3, 2, 1	5
FC 2741: SysKonnnect SK-NET FDDI-LP SAS PCI (Type *)	Slots 5, 4, 3, 2, 1	5
FC 2743: SysKonnnect SK-NET FDDI-UP SAS PCI (Type *)	Slots 5, 4, 3, 2, 1	5
FC 4959: High-Speed Token Ring PCI (Type 9-Y)	Slots 5, 4, 3, 2, 1	5
FC 2968: 10/100 Mbps Ethernet Tx PCI (Type 9-P)	Slots 5, 4, 3, 2, 1	5 (see note 2 on page 178)
FC 4962: Ethernet/LAN Encryption 10/100BaseT	Slots 5, 4, 3, 2, 1	5 (see note 2 on page 178)
FC 6204: PCI Universal Differential Ultra SCSI (Type 4-U)	Slots 5, 4, 3, 2, 1	5
FC 6227: Gigabit Fibre Channel PCI (Type 4-S)	Slots 5, 4, 3, 2, 1	2 (see note 7 on page 178)
FC 6228: Gigabit Fibre Channel Adapter, 32 or 64-bit PCI Bus (Type 4-W)	Slots 5, 4, 3, 2, 1	2
FC 2975: Gigabit Ethernet (UTP) 1000BaseT	Slots 5, 4, 3, 2, 1	5 (see notes 1 on page 178 and 3 on page 178)
FC 2826: POWER GXT4000P (Type 1-V)	Slots 1, 2, 3, 4	1

Table 38. pSeries 640 Model B80 (continued)

Adapter	Slot Usage	System Maximum
FC 2827: POWER GXT6000P (Type 1-W)	Slots 1, 2, 3, 4	1
FC 4960: IBM Cryptographic Accelerator (Type 6-J)	Slots 5, 4, 3, 2, 1	4

- For optimum system performance, a *combination* of the following adapters should not exceed a maximum of two adapters per system:
 - FC 2969: Gigabit Ethernet Fibre, 1000BaseT
 - FC 2975: Gigabit Ethernet (UTP) 1000BaseT
 - FC 2946: PCI TURBOWAYS 622 PCI MMF ATM (Type A-B)

Install one in slots 1 or 2 and the other in slots 3 or 4.

- This system supports up to five FC 2968: 10/100 Mbps Ethernet Tx PCI (Type 9-P) or FC 4962: Ethernet/LAN Encryption 10/100BaseT adapters per system, making the total six if you use the Integrated Ethernet port.
- For optimum system performance, install a maximum of two FC 2975: Gigabit Ethernet (UTP) 1000BaseT or two FC 2969: Gigabit Ethernet Fibre, 1000BaseT adapters per system (or one of each), when configured to run at 1000 Mbps. If the adapter is configured for 100 Mbps mode, use up to four of these adapters (plus the two integrated 100Mbps ports) for optimum performance.
- For optimum system performance, install a maximum of two FC 4951: 10/100 4-Port Ethernet (Type 9-Z) adapters in 100 Mbps mode per system.
- FC 6230: Advanced SerialRAID Plus (Type 4-P) can be selected with or without the cache upgrade (FC 6235: Fast Write Cache Option for FC 6230).
- FC 6235: Fast Write Cache Option for FC 6230 is a cache upgrade for the FC 6225: Advanced SSA SerialRAID (Type 4-P) adapter and can only be selected along with FC 6230: Advanced SerialRAID Plus (Type 4-P) (maximum 1 per 6230).
- If two FC 6227: Gigabit Fibre Channel PCI (Type 4-S) adapters are to be used, the first must be placed in slots 1 or 2, and the second must placed in slots 3, 4, or 5.

Chapter 27. 7248 Model 100, 120, or 132

This system is designed for customers to install adapters. Use this guide to determine if there are specific slot requirements for adapters that you may be installing.

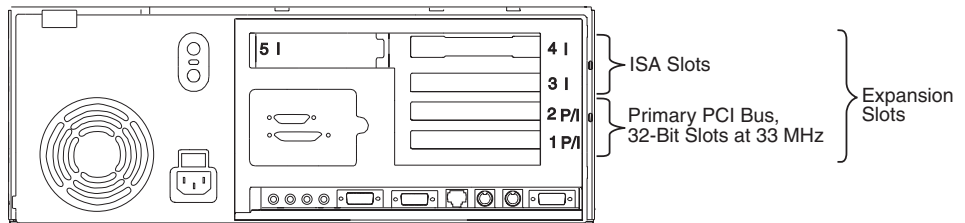

System Unit Rear View with Numbered Slots

Some adapters must be placed in specific system unit slots to function correctly at optimum performance. Use the table under “7248 Model 100, 120, or 132 Adapter Placement Guide” on page 180 to determine where to install an adapter in your 7248 Model 100, 120, or 132.

If you are running AIX, refer to “7248 Model 100, 120, or 132 Multiple Graphics Adapter Placement Guide” on page 181, to install two adapters in your 7248 Model 100, 120, or 132. Windows NT (PowerPC Edition) does not support more than one graphics adapter in a system unit.

Use the rear-view diagram above to identify slot locations described in the following tables.

7248 Model 100, 120, or 132 Adapter Placement Guide

Use the following table to identify slot locations for adapters in the 7248 Model 100, 120, or 132.

Table 39. 7248 Model 100, 120, or 132

Adapter	AIX	Windows NT
FC 2767: POWER GXT150P (Type 1-D)	Slots 1P/I - 2P/I	Slots 1P/I - 2P/I
FC 2851: POWER GXT250P (Type 1-M) or FC 2852: POWER GXT255P (Type 1-N)	Slots 1P/I - 2P/I	Slots 1P/I - 2P/I
FC 2856: POWER GXT1000 (Type 1-H)	Slots 1P/I - 2P/I	
FC 2657: S15 Graphics Adapter (Type *)	Slots 1P/I - 2P/I	Slots 1P/I - 2P/I
FC 2639: Ultimedia Video Capture (Type 7-9)	Slots 1P/I - 2P/I Max. 1 Per Machine	

7248 Model 100, 120, or 132 Multiple Graphics Adapter Placement Guide

Use the following table to identify adapter location combination options for these adapters in your 7248 Model 100, 120, or 132.

Do not install more than four graphics adapters in your 7248 Model 100, 120, or 132.

Table 40. 7248 Model 100, 120, or 132

Adapter	AIX	Windows NT
FC 2767: POWER GXT150P (Type 1-D) with a	Slot 1P	Slot 2P
FC 2851: POWER GXT250P (Type 1-M) or FC 2852: POWER GXT255P (Type 1-N)	Slot 2P	Slot 1P
FC 2657: S15 Graphics Adapter (Type *) with a	Slot 1P	Slot 2P
FC 2767: POWER GXT150P (Type 1-D)	Slot 2P	Slot 1P
FC 2657: S15 Graphics Adapter (Type *) with a	Slot 1P	Slot 2P
FC 2851: POWER GXT250P (Type 1-M) or FC 2852: POWER GXT255P (Type 1-N)	Slot 2P	Slot 1P
FC 2856: POWER GXT1000 (Type 1-H) with a	Slot 1P	Slot 2P
FC 2767: POWER GXT150P (Type 1-D)	Slot 2P	Slots 1P
FC 2856: POWER GXT1000 (Type 1-H) with a	Slot 1P	Slot 2P
FC 2851: POWER GXT250P (Type 1-M) or FC 2852: POWER GXT255P (Type 1-N)	Slot 2P	Slot 1P
FC 2856: POWER GXT1000 (Type 1-H) with an	Slot 1P	Slot 2P
FC 2657: S15 Graphics Adapter (Type *)	Slot 2P	Slot 1P

Notes:

1. This system supports two FC 2767: POWER GXT150P (Type 1-D), two FC 2851: POWER GXT250P (Type 1-M) or two FC 2852: POWER GXT255P (Type 1-N) in adapter slots 1P and 2P.

Chapter 28. 9076 RS/6000 SP Systems

These systems are designed for service representatives to install adapters. For information about specific slot requirements for adapters that your service representative may be installing, refer to *RS/6000 SP Planning Volume 1, Hardware and Physical Environment (GA22-7280)*.

The Models S70, S7A, and S80 systems can function as attached SP servers within the RS/6000 SP environment operating under control of the Parallel Systems Support Programs (PSSP) for AIX. This interconnection can be accomplished using the SP System Attachment for PCI or through an Ethernet connection. Some I/O adapters available on these systems are not supported on the SP environment and must be removed. Refer to the RS/6000 SP 9076-550 sales manual for a list of currently supported adapters.

A minimum of one Ethernet adapter is required for Models S70, S7A, and S80 systems to function as an attached servers within the IBM RS/6000 SP environment.

Chapter 29. Digital Trunk PCI Adapter Placement Considerations

To ensure optimum system performance, you must follow additional guidelines when installing these adapters:

- FC 6309: Digital Trunk Quad PCI (Type 6-B)
- FC 6310: IBM ARTIC960 RxD Quad Digital Trunk PCI (Type 6-E)
- FC 6311: IBM ARTIC960 RxF PCI (Type 6-G)

Read the following guidelines to learn more about Digital Trunk PCI adapter placement considerations.

Notes:

1. If a system has a FC 2979: PCI Auto LANstreamer Token Ring (Type 8-T) or a FC 2920: 16Mbps PCI Token-Ring (Type 9-0) installed along with either a FC 6309: Digital Trunk Quad PCI (Type 6-B) or FC 6310: IBM ARTIC960 RxD Quad Digital Trunk PCI (Type 6-E) adapter, then the FC 2979: PCI Auto LANstreamer Token Ring (Type 8-T) or FC 2920: 16Mbps PCI Token-Ring (Type 9-0) adapters must be installed in a lower slot number relative to the Digital Trunk PCI adapters.
2. Whenever multiple FC 6309: Digital Trunk Quad PCI (Type 6-B) or FC 6310: IBM ARTIC960 RxD Quad Digital Trunk PCI (Type 6-E) adapters are installed in the same system, install them in adjacent slots.
3. Do not install FC 6309: Digital Trunk Quad PCI (Type 6-B) and FC 6310: IBM ARTIC960 RxD Quad Digital Trunk PCI (Type 6-E) adapters in the same PCI bus as a POWER GXT 110P, 120P, or 130P graphics adapter.
4. FC 6309: Digital Trunk Quad PCI (Type 6-B) and FC 6310: IBM ARTIC960 RxD Quad Digital Trunk PCI (Type 6-E) adapters installed in the same system with an ISA adapter should not be installed on the same PCI bus as the ISA bridge.
5. If you install multiple FC 6310: IBM ARTIC960 RxD Quad Digital Trunk PCI (Type 6-E) and FC 6311: IBM ARTIC960 RxF PCI (Type 6-G) s in a system, you must install the adapters in adjacent slots. Install the FC 6310: IBM ARTIC960 RxD Quad Digital Trunk PCI (Type 6-E)s first in the lower numbered slots and then put the FC 6311: IBM ARTIC960 RxF PCI (Type 6-G) s in subsequent slots.
6. You may install up to three FC 6311: IBM ARTIC960 RxF PCI (Type 6-G) s per FC 6310: IBM ARTIC960 RxD Quad Digital Trunk PCI (Type 6-E), but the sum of FC 6310: IBM ARTIC960 RxD Quad Digital Trunk PCI (Type 6-E)s and FC 6311: IBM ARTIC960 RxF PCI (Type 6-G) s cannot exceed six.
7. For optimum performance, install FC 6310: IBM ARTIC960 RxD Quad Digital Trunk PCI (Type 6-E)s on their own bus.

Chapter 30. FC 2854: POWER GXT500P (Type 1-I) and FC 2855: POWER GXT550P (Type 1-J) Support Configurations

The FC 2854: POWER GXT500P (Type 1-I) and FC 2855: POWER GXT550P (Type 1-J) graphics adapters support machine types 7025 and 7043. Nevertheless, the adapters are not interchangeable within all of these machine types. If you install one of these adapters in an unsupported adapter-machine combination, it may appear to function properly. However, unsupported adapter-machine combinations experience intermittent problems. The information in this chapter guides you through a process to determine if your FC 2854: POWER GXT500P (Type 1-I) or your FC 2855: POWER GXT550P (Type 1-J) is compatible with the system unit in which you would like to install it.

Table 41. Support Configurations

System Unit	Device Specific (Z1) for FC 2854: POWER GXT500P (Type 1-I) or FC 2855: POWER GXT550P (Type 1-J)	Supported Slots
7043 Model 140	T or C	2
7043 Model 240	0 or C	2
7025 Model F40	0 or C	1, 2, 3

Find your adapter device driver name. Use this information to find the Device Specific Code (Z1) listed by machine type in the above table. Check the table to ensure that your adapter is used in your machine type and that it is in a supported slot.

Verify Adapter Placement and Part Number

- To find your adapter device name, type:

```
lsdisp
```

Your device name (for example `mint0`) appears under the heading `DEV_NAME`.

Note: You must type your specific device driver name after the `-1` in the following instruction. In this instruction, `mint0` is an example of a device driver name.

- To find your adapter part number, type:

```
lscfg -v -l mint0
```

The following is an example of data from lscfg:

```
mint0      04-02      GXT550P Graphics Adapter

Part Number .....040H7745
EC Level .....00D74509
Serial Number .....00000000
FRU Number .....040H4962
Manufacturer .....IBM97N
Device Driver Level .....00
Diagnostic Level .....00
Displayable Message .....GXT550P
Loadable Microcode Level ....0000
ROS Level and ID .....0000
Device Specific .(Z0) .....84808084C0C0C0C0
Device Specific .(Z1) .....0
```

- Find the Device Specific (Z1) row at the end of the above screen. Verify that this code (for example, 0) is consistent with your system unit as shown in Table 41 on page 187.
- Verify slot location by reading the last two digits of the header, 04-02. The 02 tells you the adapter is in slot 2. Go to Table 41 on page 187 to verify the slot location is supported.
- Refer to your adapter installation guide for additional troubleshooting measures.

Chapter 31. FC 2853: POWER GXT800P (Type 1-K) Support Configurations

The FC 2853: POWER GXT800P (Type 1-K) graphics adapters (with base memory or with base memory and texture) support machine types 7025 and 7043. Nevertheless, the adapters are not interchangeable within all of these machine types. If you install one of these adapters in an unsupported adapter-machine combination, it may appear to function properly. However, unsupported adapter-machine combinations experience intermittent problems. The information in this chapter guides you through a process to determine if your FC 2853: POWER GXT800P (Type 1-K) is compatible with the system unit in which you would like to install it.

Table 42. Support Configurations

System Unit	Device Specific (Z1) for FC 2853: POWER GXT800P (Type 1-K)	Supported Slots
7043 Model 140	T or C	2
7043 Model 240	0 or C	2
7025 Model F40	0 or C	2, 3
7025 Model F50 (see note below)	C	3

Note: The ROS level and ID of the adapter must be 0005 or greater to support installation in a 7025 Model F50. Use the following procedure to determine the ROS level and ID for your FC 2853: POWER GXT800P (Type 1-K).

Find your adapter device driver name. Use this information to find the Device Specific Code (Z1) listed by machine type in the above table. Check the table to ensure that your adapter is used in your machine type and that it is in a supported slot.

Verify Adapter Placement using Device Name

1. To find your adapter device name, type:

```
lsdisp
```

Your device name (for example `smint0`) will appear under `DEV_NAME`.

Note: You must type your specific device driver name after the `-l` in the following instruction. In this instruction, `smint0` is an example of a device driver name.

- To find your adapter device specific code, type:

```
lscfg -v -lsmint0
```

The following is an example of data from lscfg:

```
smint0      04-02      GXT800P Graphics Adapter

Part Number .....039H8699
EC Level .....00D74274
Serial Number .....00000000
FRU Number .....039H8700
Manufacturer .....XVC97N
Device Driver Level .....00
Diagnostic Level .....00
Displayable Message .....GXT800P
Loadable Microcode Level ....0000
ROS Level and ID .....0000
Device Specific .(Z0) .....84808084C0C0C0C0
Device Specific .(Z1) .....0
```

- Find the Device Specific (Z1) row at the end of the above screen. Verify that this code (for example, 0) and the slot number are consistent with your system unit as shown in Table 42 on page 189.
- Verify slot location by reading the last two digits of the header, 04-02. The 02 tells you the adapter is in slot 2. Go to Table 42 on page 189 to verify the slot location is supported.
- Refer to your adapter installation guide for additional troubleshooting measures.

Appendix. Notices

This information was developed for products and services offered in the U.S.A.

The manufacturer may not offer the products, services, or features discussed in this document in other countries. Consult the manufacturer's representative for information on the products and services currently available in your area. Any reference to the manufacturer's product, program, or service is not intended to state or imply that only that product, program, or service may be used. Any functionally equivalent product, program, or service that does not infringe any intellectual property right of the manufacturer may be used instead. However, it is the user's responsibility to evaluate and verify the operation of any product, program, or service.

The manufacturer may have patents or pending patent applications covering subject matter described in this document. The furnishing of this document does not give you any license to these patents. You can send license inquiries, in writing, to the manufacturer.

The following paragraph does not apply to the United Kingdom or any country where such provisions are inconsistent with local law: THIS MANUAL IS PROVIDED "AS IS" WITHOUT WARRANTY OF ANY KIND, EITHER EXPRESSED OR IMPLIED, INCLUDING, BUT NOT LIMITED TO, THE IMPLIED WARRANTIES OF NON-INFRINGEMENT, MERCHANTABILITY OR FITNESS FOR A PARTICULAR PURPOSE. Some states do not allow disclaimer of express or implied warranties in certain transactions; therefore, this statement may not apply to you.

This information could include technical inaccuracies or typographical errors. Changes are periodically made to the information herein; these changes will be incorporated in new editions of the publication. The manufacturer may make improvements and/or changes in the product(s) and/or the program(s) described in this publication at any time without notice.

Information concerning products made by other than the manufacturer was obtained from the suppliers of those products, their published announcements, or other publicly available sources. The manufacturer has not tested those products and cannot confirm the accuracy of performance, compatibility or any other claims related to products made by other than the manufacturer. Questions on the capabilities of products made by other than the manufacturer should be addressed to the suppliers of those products.

Readers' Comments — We'd Like to Hear from You

PCI Adapter Placement Reference

Publication No. SA38-0538-14

Overall, how satisfied are you with the information in this book?

	Very Satisfied	Satisfied	Neutral	Dissatisfied	Very Dissatisfied
Overall satisfaction	<input type="checkbox"/>	<input type="checkbox"/>	<input type="checkbox"/>	<input type="checkbox"/>	<input type="checkbox"/>

How satisfied are you that the information in this book is:

	Very Satisfied	Satisfied	Neutral	Dissatisfied	Very Dissatisfied
Accurate	<input type="checkbox"/>	<input type="checkbox"/>	<input type="checkbox"/>	<input type="checkbox"/>	<input type="checkbox"/>
Complete	<input type="checkbox"/>	<input type="checkbox"/>	<input type="checkbox"/>	<input type="checkbox"/>	<input type="checkbox"/>
Easy to find	<input type="checkbox"/>	<input type="checkbox"/>	<input type="checkbox"/>	<input type="checkbox"/>	<input type="checkbox"/>
Easy to understand	<input type="checkbox"/>	<input type="checkbox"/>	<input type="checkbox"/>	<input type="checkbox"/>	<input type="checkbox"/>
Well organized	<input type="checkbox"/>	<input type="checkbox"/>	<input type="checkbox"/>	<input type="checkbox"/>	<input type="checkbox"/>
Applicable to your tasks	<input type="checkbox"/>	<input type="checkbox"/>	<input type="checkbox"/>	<input type="checkbox"/>	<input type="checkbox"/>

Please tell us how we can improve this book:

Thank you for your responses. May we contact you? Yes No

When you send comments to IBM, you grant IBM a nonexclusive right to use or distribute your comments in any way it believes appropriate without incurring any obligation to you.

Name

Address

Company or Organization

Phone No.



Cut or Fold
Along Line

Fold and Tape

Please do not staple

Fold and Tape



NO POSTAGE
NECESSARY
IF MAILED IN THE
UNITED STATES

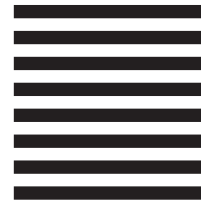

BUSINESS REPLY MAIL

FIRST-CLASS MAIL PERMIT NO. 40 ARMONK, NEW YORK

POSTAGE WILL BE PAID BY ADDRESSEE

Information Development
Department H6DS-905-6C006
11400 Burnet Road
Austin, TX 78758-3493



Fold and Tape

Please do not staple

Fold and Tape

Cut or Fold
Along Line



Part Number: 09P4390

IBM Confidential



Printed in the United States of America
on recycled paper containing 10%
recovered post-consumer fiber.

SA38-0538-14



(1P) P/N: 09P4390

