

RS/6000 Enterprise Servers S70 and S7A



User's Guide

Second Edition (October 1998)

The following paragraph does not apply to the United Kingdom or any country where such provisions are inconsistent with local law: THIS PUBLICATION IS PROVIDED "AS IS" WITHOUT WARRANTY OF ANY KIND, EITHER EXPRESS OR IMPLIED, INCLUDING, BUT NOT LIMITED TO, THE IMPLIED WARRANTIES OF MERCHANTABILITY OR FITNESS FOR A PARTICULAR PURPOSE. Some states do not allow disclaimer of express or implied warranties in certain transactions, therefore, this statement may not apply to you.

This publication could include technical inaccuracies or typographical errors. Changes are periodically made to the information herein; these changes will be incorporated in new editions of the publication. The manufacturer may make improvements and/or changes in the product(s) and/or the program(s) described in this publication at any time, without notice.

It is possible that this publication may contain reference to, or information about, products (machines and programs), programming, or services that are not announced in your country. Such references or information must not be construed to mean that these products, programming, or services will be announced in your country. Any reference to a specific licensed program in this publication is not intended to state or imply that you can use only that licensed program. You can use any functionally equivalent program instead.

Requests for technical information about products should be made to your authorized reseller or marketing representative.

© International Business Machines Corporation 1997, 1998. All rights reserved.

Note to U.S. Government Users -- Documentation related to restricted rights -- Use, duplication or disclosure is subject to restrictions set forth in GSA ADP Schedule Contract with IBM Corp.

Contents

| | |
|--|------|
| Communications Statements | xi |
| Safety Notices | xv |
| Environmental Notices | xix |
| About This Book | xxi |
| Chapter 1. System Introduction | 1-1 |
| System Rack | 1-3 |
| I/O Rack | 1-5 |
| I/O Drawers | 1-7 |
| 10 EIA Unit I/O Drawer | 1-7 |
| 7 EIA Unit I/O Drawer | 1-8 |
| Input/Output Connectors | 1-9 |
| 10 EIA Unit I/O Drawer | 1-9 |
| 7 EIA Unit I/O Drawer | 1-11 |
| Chapter 2. Using the System | 2-1 |
| Powering Off and Powering On the System or Frame | 2-1 |
| Powering On the System | 2-2 |
| Powering Off the System | 2-2 |
| Post Indicators | 2-5 |
| Function Keys | 2-7 |
| Console Strategy | 2-8 |
| Reading the System Rack Operator Panel Display | 2-9 |
| I/O Drawer Indicator Panels | 2-10 |
| 10 EIA Unit I/O Drawer Indicator Panel | 2-10 |
| 7 EIA Unit I/O Drawer Indicator Panel | 2-11 |
| Using the Keyboards | 2-13 |
| Using the Three-Button Mouse | 2-15 |
| Handling the Mouse Correctly | 2-16 |
| Care of the Mouse | 2-17 |
| Cleaning the Mouse | 2-18 |
| Using the 3.5-Inch Diskette Drive | 2-19 |
| Diskette Compatibility | 2-19 |
| Write-Protecting 3.5-Inch Diskettes | 2-19 |
| Loading and Unloading the 3.5-Inch Diskette | 2-20 |
| General Information for 5.0GB 8-mm Tape Drive | 2-21 |
| Recommendations | 2-21 |
| Types of 8-mm Tape Cartridges | 2-21 |

| | |
|---|------|
| Tape Cartridge Compatibility | 2-22 |
| Setting the Write-Protect Tab on 8-mm Tape Cartridges | 2-22 |
| Environment Considerations for 8-mm Data Cartridges | 2-23 |
| Operating in Harsh Environments | 2-24 |
| 8-mm Data Cartridge Erasure | 2-24 |
| Tape Cartridge Data Efficiency | 2-24 |
| Using the 5.0GB 8-mm Tape Drive | 2-25 |
| Status Lights | 2-25 |
| Status Light States | 2-26 |
| Loading the 8-mm Tape Cartridge | 2-27 |
| Unloading the 8-mm Tape Cartridge | 2-28 |
| Cleaning the Tape Path on the 5.0GB 8-mm Tape Drive | 2-28 |
| General Information for 4.0GB 4-mm Tape Drive | 2-30 |
| Recommendations | 2-31 |
| Types of 4-mm Tape Cartridges | 2-31 |
| Tape Cartridge Compatibility | 2-32 |
| Setting the Write-Protect Tab on 4-mm Tape Cartridges | 2-33 |
| Environmental Considerations for 4-mm Data Cartridges | 2-34 |
| Operating in Harsh Environments | 2-35 |
| 4-mm Data Cartridge Erasure | 2-35 |
| Tape Cartridge Data Capacity | 2-35 |
| Using the 4.0GB 4-mm Tape Drive | 2-36 |
| Status Lights | 2-36 |
| Status Light States | 2-37 |
| Loading the 4-mm Tape Cartridge | 2-38 |
| Unloading the 4-mm Tape Cartridge | 2-39 |
| Cleaning the Tape Path on the 4.0GB 4-mm Tape Drive | 2-39 |
| Using the CD-ROM Drive | 2-41 |
| Loading the CD-ROM Drive | 2-42 |
| Unloading the CD-ROM Drive | 2-42 |
| Cleaning the CD-ROM Drive | 2-42 |
| Emergency Eject | 2-43 |
| Using the Hot Swap Disk Drives | 2-44 |
| Relationship of AIX Prompts and Physical Drive Location | 2-44 |
| 10 EIA Unit I/O Drawer Locations | 2-44 |
| 7 EIA Unit I/O Drawer Locations | 2-45 |
| Handling Guidelines | 2-46 |
| Labels | 2-46 |
| Disk Drive Status Light States | 2-47 |
| Removing and Inserting Disk Drives | 2-48 |
| Unconfiguring or Configuring a Disk Drive | 2-48 |
| Inserting a Disk Drive into the Hot-Swap Bays | 2-50 |
| Removing Disk Drives from the Hot-Swap Bays | 2-56 |
| Ergonomic Information | 2-60 |

| | |
|---|------------|
| Using the Service Processor and Service Director Features | 2-61 |
| Service Processor | 2-61 |
| Service Director | 2-62 |
| Chapter 3. Service Processor Menus | 3-1 |
| SP Menu | 3-3 |
| How to access SP menus locally | 3-3 |
| How to access SP menus remotely | 3-3 |
| Saving and Restoring Service Processor Settings | 3-4 |
| How to return to SP menus | 3-4 |
| Menu Inactivity | 3-4 |
| General User Menus | 3-5 |
| Privileged User Menus | 3-7 |
| Main Menu | 3-7 |
| Service Processor Setup Menu | 3-9 |
| Passwords | 3-10 |
| System Power Control Menu | 3-13 |
| System Information Menu | 3-14 |
| Language Selection Menu | 3-16 |
| Call-In/Call-Out Setup Menu | 3-17 |
| Modem Configuration Menu | 3-18 |
| Serial Port Selection Menu | 3-19 |
| Serial Port Speed Setup Menu | 3-20 |
| Telephone Number Setup Menu | 3-21 |
| Call-Out Policy Setup Menu | 3-23 |
| Customer Account Setup Menu | 3-24 |
| Reboot/Restart Policy Setup Menu | 3-25 |
| Service Processor Procedures in Service Mode | 3-26 |
| Service Processor Functions | 3-27 |
| System Power-On Methods | 3-29 |
| Service Processor Call-In Security | 3-30 |
| Service Processor Reboot/Restart Recovery | 3-31 |
| Boot (IPL) Speed | 3-31 |
| Failure During Boot Process | 3-31 |
| Failure During Normal System Operation | 3-31 |
| Service Processor Reboot/Restart Policy Controls | 3-32 |
| Service Processor System Monitoring - Surveillance | 3-34 |
| System Firmware Surveillance | 3-34 |
| Operating System Surveillance | 3-34 |
| Call-Out (Call-Home) | 3-36 |
| Console Mirroring | 3-37 |
| System Configuration: | 3-37 |
| Service Processor Error Logs | 3-38 |
| System POST Errors | 3-38 |

| | |
|---|------------|
| LCD Progress Indicator Log | 3-39 |
| Chapter 4. System Management Services | 4-1 |
| Graphical System Management Services | 4-1 |
| Password | 4-4 |
| Error Log | 4-6 |
| RIPL | 4-7 |
| SCSI | 4-12 |
| Console Select | 4-15 |
| MultiBoot | 4-16 |
| Text-Based System Management Services | 4-20 |
| Console Select | 4-27 |
| MultiBoot Menu | 4-28 |
| Select Boot Devices | 4-29 |
| Select Language | 4-31 |
| Chapter 5. Using the Online and Standalone Diagnostics | 5-1 |
| Sources for the Diagnostics | 5-1 |
| Standalone and Online Diagnostics Operating Considerations | 5-1 |
| Selecting a Console Display | 5-1 |
| Identifying the Terminal Type to Diagnostics | 5-1 |
| Undefined Terminal Types | 5-2 |
| Running Standalone Diagnostics | 5-2 |
| Running Online Diagnostics | 5-2 |
| Running the Diagnostics from a TTY Terminal | 5-3 |
| General Attributes Always Required | 5-4 |
| Additional Communication Attributes | 5-6 |
| Additional Keyboard Attributes | 5-7 |
| Additional Printer Attributes | 5-8 |
| Online Diagnostics Modes of Operation | 5-9 |
| Service Mode | 5-9 |
| Running the Online Diagnostics in Service Mode | 5-9 |
| Concurrent Mode | 5-10 |
| Running the Online Diagnostics in Concurrent Mode | 5-11 |
| Maintenance Mode | 5-11 |
| Running the Online Diagnostics in Maintenance Mode | 5-11 |
| Standalone Diagnostic Operation | 5-12 |
| Running the Standalone Diagnostics | 5-12 |
| Logical and Physical Locations | 5-13 |
| Physical Location Codes | 5-13 |
| Location Code Format | 5-13 |
| AIX Location Codes | 5-15 |
| AIX and Physical Location Code Reference Tables | 5-17 |

| | |
|--|------|
| Chapter 6. Introduction to Tasks and Service Aids | 6-1 |
| Tasks | 6-2 |
| Add Resource to Resource List | 6-4 |
| AIX Shell Prompt | 6-4 |
| Analyze Adapter Internal Log | 6-4 |
| Backup and Restore Media | 6-4 |
| Certify Media | 6-5 |
| Change Hardware Vital Product Data | 6-6 |
| Configure Dials and LPFKeys | 6-6 |
| Configure Reboot Policy | 6-6 |
| Configure Remote Maintenance Policy | 6-8 |
| Configure Ring Indicate Power On Policy | 6-10 |
| Configure Surveillance Policy | 6-10 |
| Create Customized Configuration Diskette | 6-11 |
| Delete Resource from Resource List | 6-12 |
| Disk Maintenance | 6-12 |
| Disk to Disk Copy | 6-12 |
| Display/Alter Sector | 6-13 |
| Display Configuration and Resource List | 6-13 |
| Display Firmware Device Node Information | 6-13 |
| Display Hardware Error Report | 6-13 |
| Display Hardware Vital Product Data | 6-13 |
| Display Machine Check Error Log | 6-14 |
| Display Microcode Level | 6-14 |
| Display or Change Bootlist | 6-14 |
| Display or Change Diagnostic Run Time Options | 6-14 |
| Display Previous Diagnostic Results | 6-15 |
| Display Resource Attributes | 6-16 |
| Display Service Hints | 6-16 |
| Display Software Product Data | 6-16 |
| Display System Environmental Sensors | 6-16 |
| Display Test Patterns | 6-18 |
| Download Microcode | 6-18 |
| Download Microcode to PCI SCSI RAID Adapter | 6-19 |
| Download Microcode to Disk Drive Attached to a PCI SCSI RAID Adapter | 6-19 |
| Download Microcode to a PCI FC-AL Adapter | 6-19 |
| Download Microcode to Other Devices | 6-20 |
| Fibre Channel RAID Service Aids | 6-20 |
| Flash SK-NET FDDI Firmware | 6-21 |
| Format Media | 6-21 |
| Hardfile Attached to SCSI Adapter (non-RAID) | 6-21 |
| Hardfile Attached to PCI SCSI RAID Adapter | 6-23 |
| Optical Media | 6-23 |
| Diskette Format | 6-24 |

| | |
|--|------------|
| Generic Microcode Download | 6-24 |
| Local Area Network Analyzer | 6-24 |
| Periodic Diagnostics | 6-25 |
| PCI RAID Physical Disk Identify | 6-25 |
| Process Supplemental Media | 6-25 |
| Run Diagnostics | 6-26 |
| Run Error Log Analysis | 6-27 |
| Run Exercisers | 6-27 |
| Exerciser Commands (CMD) | 6-27 |
| Acronyms | 6-27 |
| Memory Exerciser | 6-28 |
| Save or Restore Hardware Management Policies | 6-28 |
| SCSI Bus Analyzer | 6-29 |
| SCSI Device Identification and Removal | 6-30 |
| SCSD Tape Drive Service Aid | 6-30 |
| Spare Sector Availability | 6-32 |
| SSA Service Aids | 6-32 |
| Update Disk Based Diagnostics | 6-32 |
| Update System or Service Processor Flash | 6-32 |
| 7135 RAIDiant Array Service Aid | 6-33 |
| 7318 Serial Communications Network Server Service Aid | 6-35 |
| | |
| Chapter 7. Using the System Verification Procedure | 7-1 |
| | |
| Chapter 8. Hardware Problem Determination | 8-1 |
| Problem Determination Using the Standalone or Online Diagnostics | 8-1 |
| Problem Determination When Unable to Load Diagnostics | 8-11 |
| Error Codes | 8-16 |
| | |
| Appendix A. System Records | A-1 |
| Record the Identification Numbers | A-1 |
| S70 or S7A System Rack | A-1 |
| S70 or S7A System Rack Memory Configuration | A-1 |
| S70 or S7A System Rack Cabling Configurations - RIO Cabling | A-3 |
| S70 or S7A System Rack Cabling Configurations - SPCN Cabling | A-4 |
| Primary I/O Drawer Device Records | A-5 |
| Additional I/O Drawer Device Records | A-10 |
| | |
| Appendix B. Supplies | B-1 |
| | |
| Appendix C. Operator Panel Functions | C-1 |
| System Rack Operator Panel | C-1 |
| Function Code Table | C-2 |
| Operator Panel Function Descriptions | C-4 |

| | |
|---|---------|
| Values for IPL Types and Speeds | C-4 |
| Function 01 - Display Selected IPL Type, Mode and Speed | C-5 |
| Function 02 - Select IPL Type, Mode and Speed | C-5 |
| Function 03 - Start IPL | C-6 |
| Function 04 - Lamp Test | C-6 |
| Function 05 - SPCN (System Power Control Network) Informational SRC | C-6 |
| Function 07 - Restore System Power and Perform Concurrent Maintenance Repair | C-7 |
| Function 08 - Fast Power Off | C-7 |
| Functions 11 to 19 - System Reference Code | C-7 |
| Appendix D. Microcode Update Procedures | D-1 |
| Determining the Microcode Versions | D-1 |
| Obtaining the Microcode Update Package | D-3 |
| Downloading Microcode Updates | D-4 |
| Update Process Overview | D-7 |
| How to Install a Microcode Update | D-8 |
| Updating from the Service Aids | D-8 |
| Updating from the AIX command line | D-9 |
| Promoting the Microcode Update | D-10 |
| Archiving the Updates | D-11 |
| Appendix E. Service Processor Setup and Test | E-1 |
| SP Setup Checklist | E-1 |
| Testing the Service Processor Setup | E-2 |
| Call-In | E-2 |
| Call-Out | E-3 |
| Serial Port Configuration | E-3 |
| Appendix F. Modem Configurations | F-1 |
| Sample Modem Configuration Files | F-1 |
| Configuration File Selection | F-2 |
| Examples For Using the Generic Sample Modem Configuration Files | F-4 |
| Customizing the Modem Configuration Files | F-4 |
| IBM 7852-400 DIP Switch Settings | F-5 |
| Terminal Emulators | F-6 |
| Recovery Procedures | F-6 |
| Seamless Transfer of a Modem Session | F-7 |
| Recovery Strategy | F-8 |
| Prevention Strategy | F-8 |
| Modem Configuration Samples | F-9 |
| Sample File modem_z.cfg | F-9 |
| Sample File modem_z0.cfg | F-11 |
| Sample File modem_f.cfg | F-13 |

| | |
|---|------------|
| Sample File modem_f0.cfg | F-16 |
| Sample File modem_f1.cfg | F-19 |
| Sample File modem_m0.cfg | F-22 |
| Sample File modem_m1.cfg | F-24 |
| Index | X-1 |
| Reader's Comments — We'd Like to Hear From You | X-3 |

Communications Statements

The following statement applies to this product. The statement for other products intended for use with this product appears in their accompanying documentation.

Federal Communications Commission (FCC) Statement

Note: This equipment has been tested and found to comply with the limits for a Class A digital device, pursuant to Part 15 of the FCC Rules. These limits are designed to provide reasonable protection against harmful interference when the equipment is operated in a commercial environment. This equipment generates, uses, and can radiate radio frequency energy and, if not installed and used in accordance with the instruction manual, may cause harmful interference to radio communications. Operation of this equipment in a residential area is likely to cause harmful interference in which case the user will be required to correct the interference at his own expense.

Properly shielded and grounded cables and connectors must be used in order to meet FCC emission limits. Neither the provider nor the manufacturer are responsible for any radio or television interference caused by using other than recommended cables and connectors or by unauthorized changes or modifications to this equipment. Unauthorized changes or modifications could void the user's authority to operate the equipment.

This device complies with Part 15 of the FCC Rules. Operation is subject to the following two conditions: (1) this device may not cause harmful interference, and (2) this device must accept any interference received, including interference that may cause undesired operation.

European Union (EU) Statement

This product is in conformity with the protection requirements of EU Council Directive 89/336/EEC on the approximation of the laws of the Member States relating to electromagnetic compatibility. The manufacturer cannot accept responsibility for any failure to satisfy the protection requirements resulting from a non-recommended modification of the product, including the fitting of option cards supplied by third parties. Consult with your dealer or sales representative for details on your specific hardware.

This product has been tested and found to comply with the limits for Class A Information Technology Equipment according to CISPR 22 / European Standard EN 55022. The limits for Class A equipment were derived for commercial and industrial environments to provide reasonable protection against interference with licensed communication equipment.

Attention: This is a Class A product. In a domestic environment this product may cause radio interference in which case the user may be required to take adequate measures.

International Electrotechnical Commission (IEC) Statement

This product has been designed and built to comply with IEC Standard 950.

United Kingdom Telecommunications Safety Requirements

This equipment is manufactured to the International Safety Standard EN60950 and as such is approved in the UK under the General Approval Number NS/G/1234/J/100003 for indirect connection to the public telecommunication network.

The network adapter interfaces housed within this equipment are approved separately, each one having its own independent approval number. These interface adapters, supplied by the manufacturer, do not use or contain excessive voltages. An excessive voltage is one which exceeds 70.7 V peak ac or 120 V dc. They interface with this equipment using Safe Extra Low Voltages only. In order to maintain the separate (independent) approval of the manufacturer's adapters, it is essential that other optional cards, not supplied by the manufacturer, do not use main voltages or any other excessive voltages. Seek advice from a competent engineer before installing other adapters not supplied by the manufacturer.

Avis de conformité aux normes du ministère des Communications du Canada

Cet appareil numérique de la classe A respecte toutes les exigences du Règlement sur le matériel brouilleur du Canada.

Canadian Department of Communications Compliance Statement

This Class A digital apparatus meets the requirements of the Canadian Interference-Causing Equipment Regulations.

VCCI Statement

この装置は、情報処理装置等電波障害自主規制協議会（VCCI）の基準に基づくクラスA情報技術装置です。この装置を家庭環境で使用すると電波妨害を引き起こすことがあります。この場合には使用者が適切な対策を講ずるよう要求されることがあります。

The following is a summary of the VCCI Japanese statement in the box above.

This is a Class A product based on the standard of the Voluntary Control Council for Interference by Information Technology Equipment (VCCI). If this equipment is used in a domestic environment, radio disturbance may arise. When such trouble occurs, the user may be required to take corrective actions.

Electromagnetic Interference (EMI) Statement - Taiwan

警告使用者:

這是甲類的資訊產品，在居住的環境中使用時，可能會造成射頻干擾，在這種情況下，使用者會被要求採取某些適當的對策。

The following is a summary of the EMI Taiwan statement above.

Warning: This is a Class A product. In a domestic environment this product may cause radio interference in which case the user will be required to take adequate measures.

Radio Protection for Germany

Dieses Gerät ist berechtigt in Übereinstimmung mit Dem deutschen EMVG vom 9.Nov.92 das EG–Konformitätszeichen zu führen.

Der Aussteller der Konformitätserklärung ist die IBM Germany.

Dieses Gerät erfüllt die Bedingungen der EN 55022 Klasse A. Für diese von Geräten gilt folgende Bestimmung nach dem EMVG:

Geräte dürfen an Orten, für die sie nicht ausreichend entstört sind, nur mit besonderer Genehmigung des Bundesministers für Post und Telekommunikation oder des Bundesamtes für Post und Telekommunikation betrieben werden. Die Genehmigung wird erteilt, wenn keine elektromagnetischen Störungen zu erwarten sind.

(Auszug aus dem EMVG vom 9.Nov.92, Para.3, Abs.4)

Hinweis

Dieses Genehmigungsverfahren ist von der Deutschen Bundespost noch nicht veröffentlicht worden.

Safety Notices

A *danger* notice indicates the presence of a hazard that has the potential of causing death or serious personal injury.

A *caution* notice indicates the presence of a hazard that has the potential of causing moderate or minor personal injury.

Electrical Safety

Observe the following safety instructions any time you are connecting or disconnecting devices attached to the workstation.

DANGER

An electrical outlet that is not correctly wired could place hazardous voltage on metal parts of the system or the devices that attach to the system. It is the responsibility of the customer to ensure that the outlet is correctly wired and grounded to prevent an electrical shock.

Before installing or removing signal cables, ensure that the power cables for the system unit and all attached devices are unplugged.

When adding or removing any additional devices to or from the system, ensure that the power cables for those devices are unplugged before the signal cables are connected. If possible, disconnect all power cables from the existing system before you add a device.

Use one hand, when possible, to connect or disconnect signal cables to prevent a possible shock from touching two surfaces with different electrical potentials.

During an electrical storm, do not connect cables for display stations, printers, telephones, or station protectors for communication lines.

CAUTION:

This product is equipped with a three-wire power cable and plug for the user's safety. Use this power cable with a properly grounded electrical outlet to avoid electrical shock.

DANGER

To prevent electrical shock hazard, disconnect the power cable from the electrical outlet before relocating the system.

CAUTION:

This unit has more than one power supply cord. To reduce the risk of electrical shock, disconnect two power supply cords before servicing.

Laser Safety Information

The optical drive in this system unit is a laser product. The optical drive has a label that identifies its classification. The label, located on the drive, is shown below.

| |
|---|
| CLASS 1 LASER PRODUCT LASER KLASSE 1 LUOKAN 1 LASERLAITE APPAREIL À LASER DE CLASSE 1 IEC 825:1984 CENELEC EN 60 825:1991 |
|---|

The optical drive in this system unit is certified in the U.S. to conform to the requirements of the Department of Health and Human Services 21 Code of Federal Regulations (DHHS 21 CFR) Subchapter J for Class 1 laser products. Elsewhere, the drive is certified to conform to the requirements of the International Electrotechnical Commission (IEC) 825 (1st edition 1984) and CENELEC EN 60 825:1991 for Class 1 laser products.



CAUTION:

A class 3 laser is contained in the device. Do not attempt to operate the drive while it is disassembled. Do not attempt to open the covers of the drive as it is not serviceable and is to be replaced as a unit.

Class 1 laser products are not considered to be hazardous. The optical drive contains internally a Class 3B gallium-arsenide laser that is nominally 0.14 milliwatts at 765 to 815 nanometers. The design incorporates a combination of enclosures, electronics, and redundant interlocks such that there is no exposure to laser radiation above a Class 1 level during normal operation, user maintenance, or servicing conditions.

Environmental Notices

Product Recycling and Disposal

Components of the system unit, such as structural parts and circuit cards, can be recycled where recycling facilities exist. Companies are available to disassemble, reutilize, recycle, or dispose of electronic products. Contact your account representative for more information. This system unit contains batteries and circuit boards with lead solder. Before you dispose of this unit, these batteries and circuit boards must be removed and discarded according to local regulations or recycled where facilities exist. This book contains specific information on each battery type where applicable.

Battery Return Program

In the United States, IBM has established a collection process for reuse, recycling, or proper disposal of used IBM batteries and battery packs. For information on proper disposal of the batteries in this unit, please contact IBM at 1-800-426-4333. Please have the IBM part number that is listed on the battery available when you make your call. For information on battery disposal outside the United States, contact your local waste disposal facility.

Environmental Design

The environmental efforts that have gone into the design of this system signifies IBM's commitment to improve the quality of its products and processes. Some of these accomplishments include the elimination of the use of Class I ozone-depleting chemicals in the manufacturing process and reductions in manufacturing wastes. For more information, contact an IBM account representative.

Unit Emissions

The unit-related emission value is equal to or lower than 70dB(A).

Der Geräuschpegel der Einheit ist kleiner oder gleich 70 db(A).

About This Book

This book provides information on how to install and remove options, use the system, use diagnostics, use service aids, and verify system operation. This book also provides information to help you solve some of the simpler problems that might occur.

ISO 9000

ISO 9000 registered quality systems were used in the development and manufacturing of this product.

Related Publications

The following publications are available:

- The *RS/6000 Enterprise Servers S70 and S7A and Installation and Service Guide* (SA38-0548), contains reference information, maintenance analysis procedures (MAPs), error codes, removal and replacement procedures, and a parts catalog.
- The *RS/6000 Diagnostic Information for Multiple Bus Systems* (SA38-0509), contains diagnostic information, service request numbers (SRNs), and failing function codes (FFCs).
- The *RS/6000 Adapters, Devices, and Cable Information for Multiple Bus Systems* (SA38-0516), contains information about adapters, devices, and cables for your system. This manual is intended to supplement the service information found in the *RS/6000 Diagnostic Information for Multiple Bus Systems*.
- The *Site and Hardware Planning Information* (SA38-0508), contains specifications to help you do space and environmental planning before your system is installed.
- The *PCI Adapter Placement Reference* (SA38-0538), contains information about slot requirements for installing PCI adapters. This book is intended to be used to help plan and install PCI adapters for maximum performance from your system.

Trademarks

- AIX is a registered trademark of the International Business Machines Corporation.
- Velcro is a trademark of Velcro Industries.

Chapter 1. System Introduction

Thank you for selecting an S70 or S7A system!

The RS/6000 Enterprise Servers S70 and S7A and &rs6ks7a. systems are the first of a new generation of 64-bit, symmetric multiprocessing (SMP) enterprise servers. The S70 or S7A provide the power, capacity and expandability to support evolution of your business into the 64 bit computing environment while still supporting the existing 32 bit applications. The I/O subsystem supports both 32-bit and 64-bit standard PCI adapters.

The S70 or S7A systems are exclusively multi-processor, multi-bus systems packaged in two different rack types. The processor and memory are packaged in the System Rack. A separate I/O rack contains the DASD and I/O devices in drawers. The basic system consists of one System Rack and one I/O Drawer in a separate rack. The S70 or S7A are expandable to one System Rack and 4 I/O Drawers. See the figure on page 1-2 for an example of the basic system.

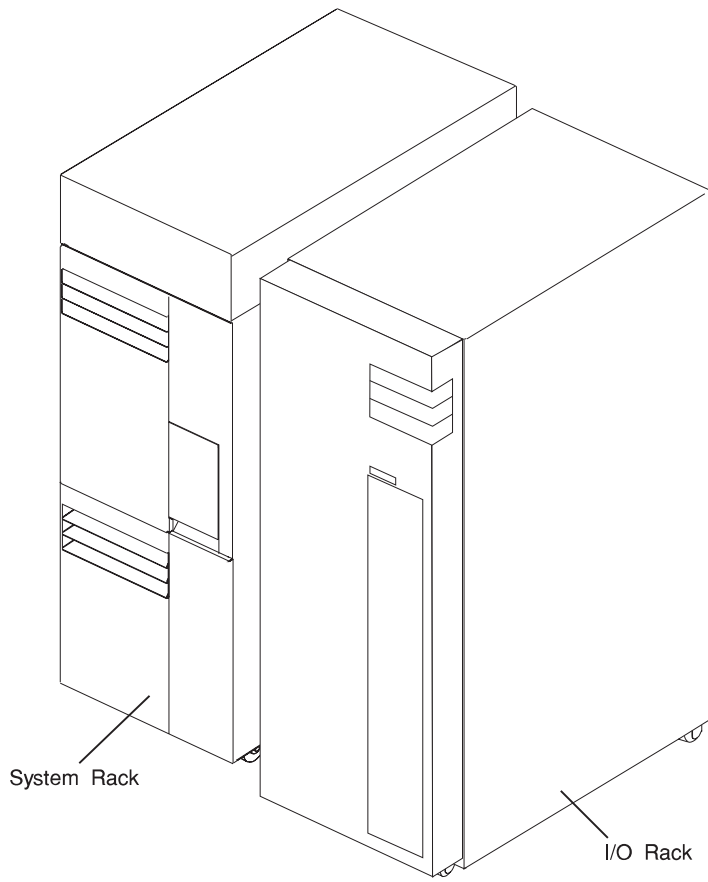

System Rack

The System Rack supports a minimum of one processor card and a maximum of three processor cards. Each processor card has four 64 bit processors operating at 125 Mhz or 262 Mhz depending on the type of processor boards installed. A maximum of 12 processors may be installed in the system which shares a common system memory. The system memory is controlled through a multi-port controller which supports up to 20 memory slots. The total memory available to users is dependent on the memory feature card installed and the number of memory cards. All system memory is contained in the system rack.

Also contained in the System Rack is the operator panel which provides diagnostic support in addition to controlling powering up and down the entire system. The operator panel is shown in the figure on page 1-4. The System Rack is powered by 200 - 240 V ac, or an optional -48 V dc source (-48 V dc power is only supported on Model S70).

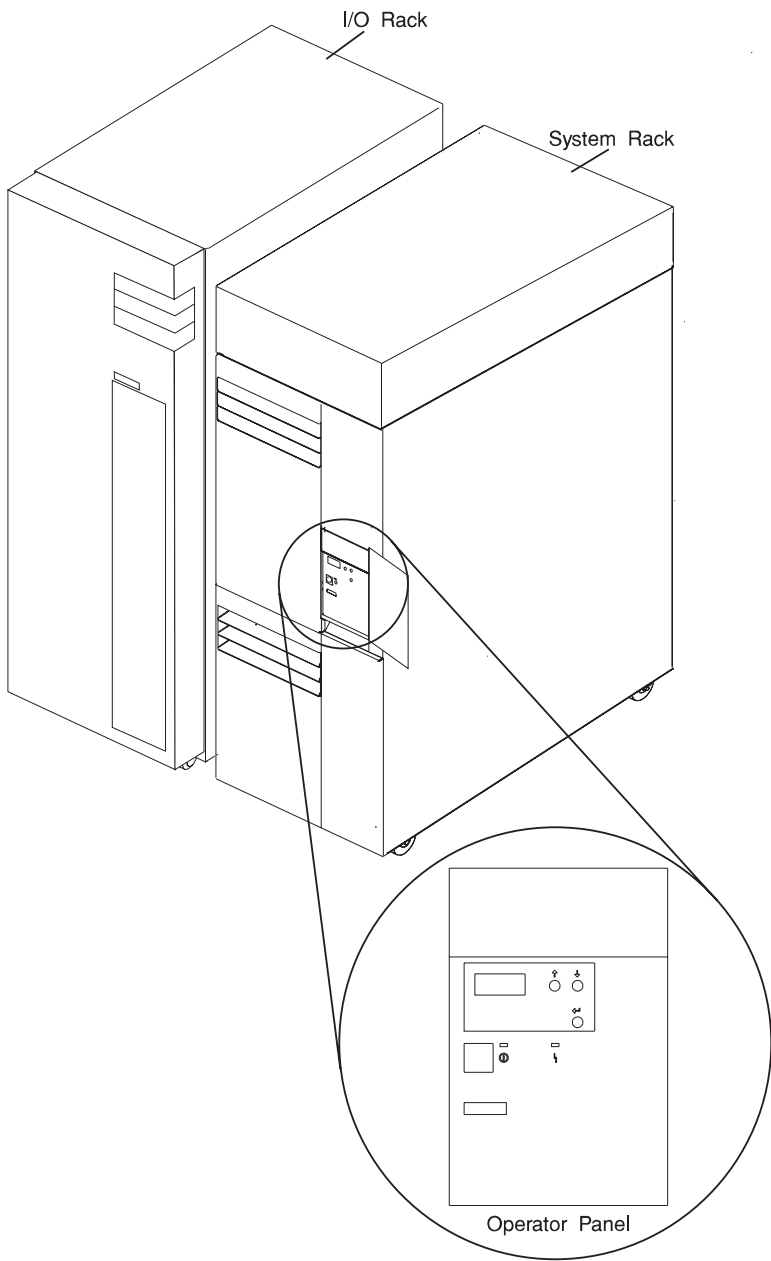

I/O Rack

Each I/O rack holds up to two I/O Drawers. Each I/O Drawer provides up to 14 PCI adapters per drawer. The primary I/O Drawer (Drawer 0) reserves slots for support of system media, Service Processor and hot-pluggable DASD bays resident in the drawer. For information about PCI adapter slot placement, see *PCI Adapter Placement Reference*, (SA38-0538). These slots are available in subsequent I/O Drawers 1 through 3 for any supported PCI adapter use. A fully configured system consisting of four I/O Drawers (with a maximum of two I/O Drawers per I/O rack) and one System Rack provides support for up to 55 33Mhz PCI adapters, 48 hot-pluggable SCSI disk bays and up to 12 media bays (S70), or 8 media bays (S7A). The PCI bus supported is 33Mhz with both 32 and 64 bit adapters supported on a per slot basis. Slots 1, 5, 9, 10 and 14 support either 32 or 64 bit PCI adapters. The remaining slots are 32 bits.

The Service Processor (SP), resident in slot 8 of the primary I/O Drawer, provides extended service support. The SP provides facilities for system management, error data collection, remote call-in, remote call-out including surveillance, and numerous other features including password support. The Input/output Rack is powered by 200 - 240 V ac or an optional -48 V dc source. (-48 V dc power is only supported on Model S70).

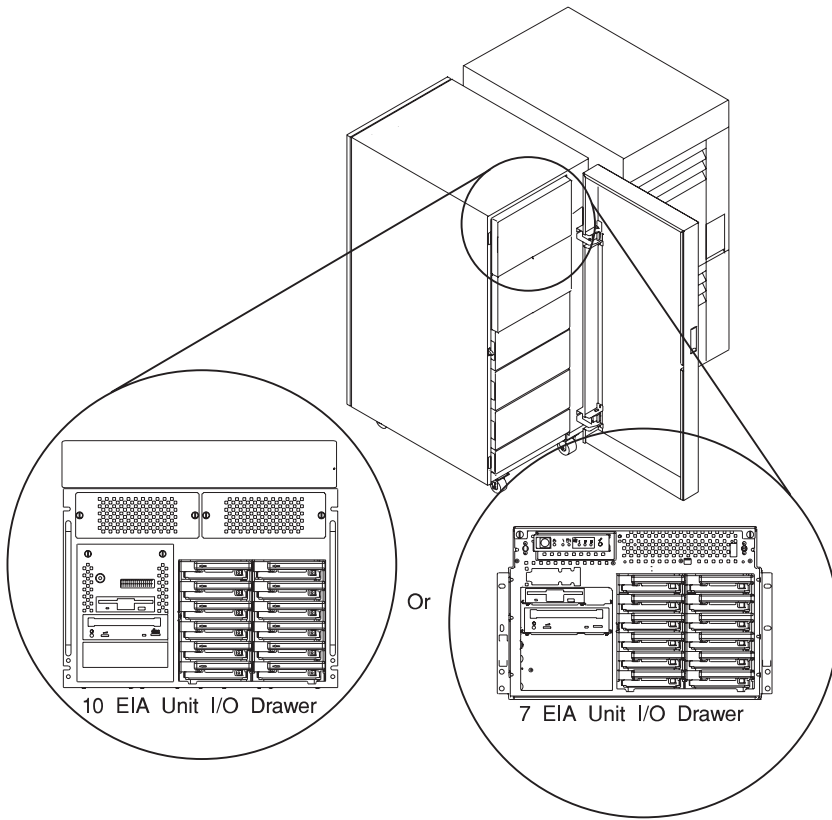

I/O Drawers

Your S70 or S7A system may have a 10 EIA Unit I/O Drawer or a 7 EIA Unit I/O Drawer. Both drawers are described below.

10 EIA Unit I/O Drawer

The 10 EIA Unit I/O Drawer features hot-pluggable disk drive banks shown in the following figure. Disk drive banks allow system users to insert and remove disk drives without performing a power down of the system which increases the availability of the S70 or S7A server. The 10 EIA Unit I/O Drawer is powered by 200 - 240 V ac.

The disk drive banks are each able to hold up to six one-inch by 3.5-inch form factor drives, or three 1.6-inch drives.

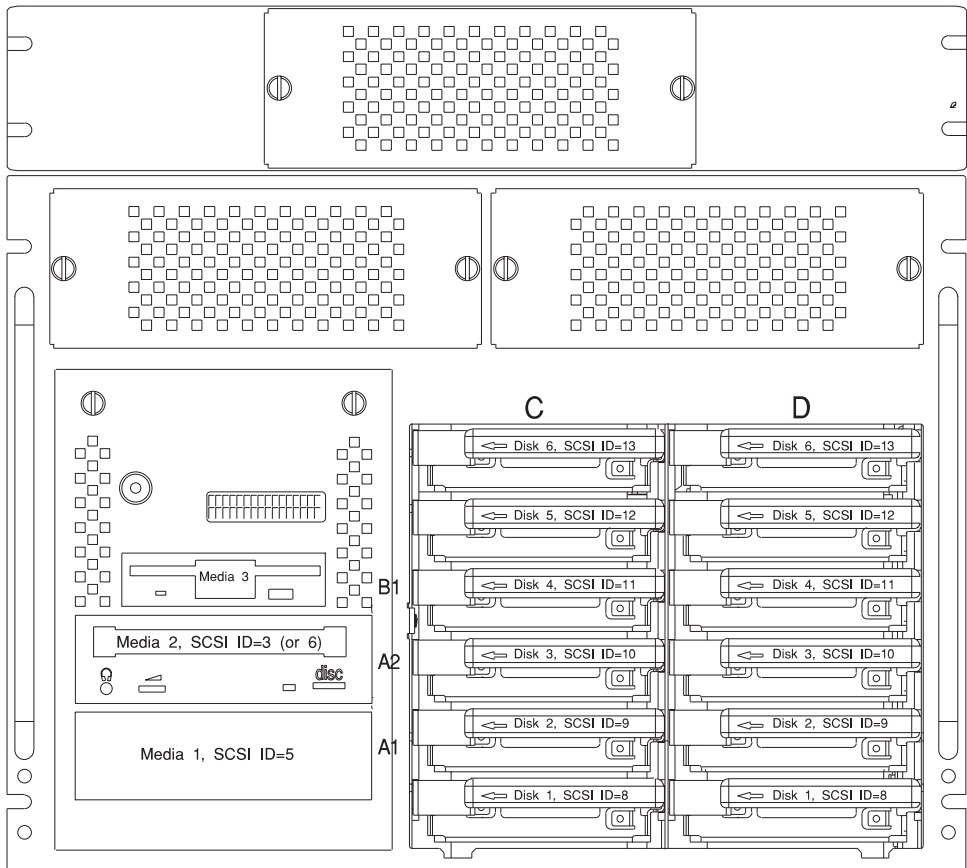

When the drawer has the maximum configuration, it holds up to 12 one-inch by 3.5-inch form factor 16 bit disk drives mounted on carriers and 2 media devices. If the drawer is fully populated with 1.6-inch disk drives, it holds only 6 disk drives. The disk drives are mounted in carriers that are auto docking, auto addressing, and hot swappable.

7 EIA Unit I/O Drawer

The 7 EIA Unit I/O Drawer features hot-pluggable SCSI banks shown in the following figure. Disk drive banks allow system users to insert and remove DASD without performing a power down of the system which increases the availability of the S70 or S7A server. The I/O Drawer is powered by 200 - 240 V ac or an optional -48 VDC source.

The disk drive banks are each able to hold up to six one-inch by 3.5-inch form factor drives, or three 1.6-inch drives.

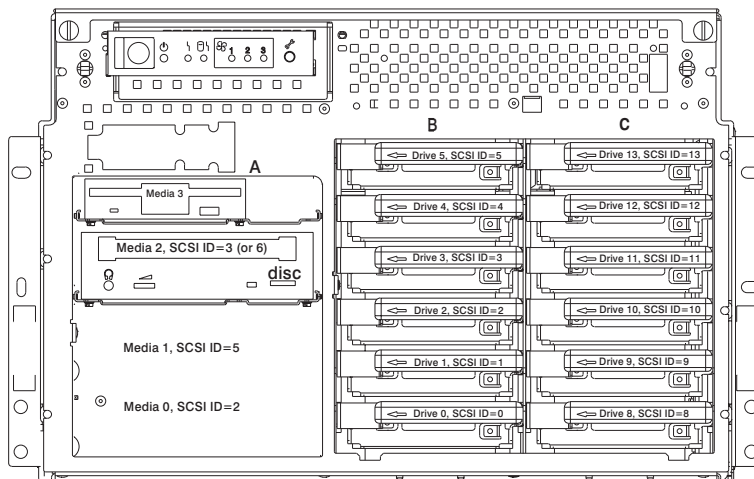

When the drawer has the maximum configuration, it holds up to 12 one-inch by 3.5-inch form factor 16 bit disk drives mounted on carriers and 3 media devices. If the drawer is fully populated with 1.6-inch disk drives, it holds only 6 disk drives. The disk drives are mounted in carriers that are auto docking, auto addressing, and hot swappable.

Input/Output Connectors

10 EIA Unit I/O Drawer

The 10 EIA Unit I/O Drawer Input/Output connectors are shown in the following figure.

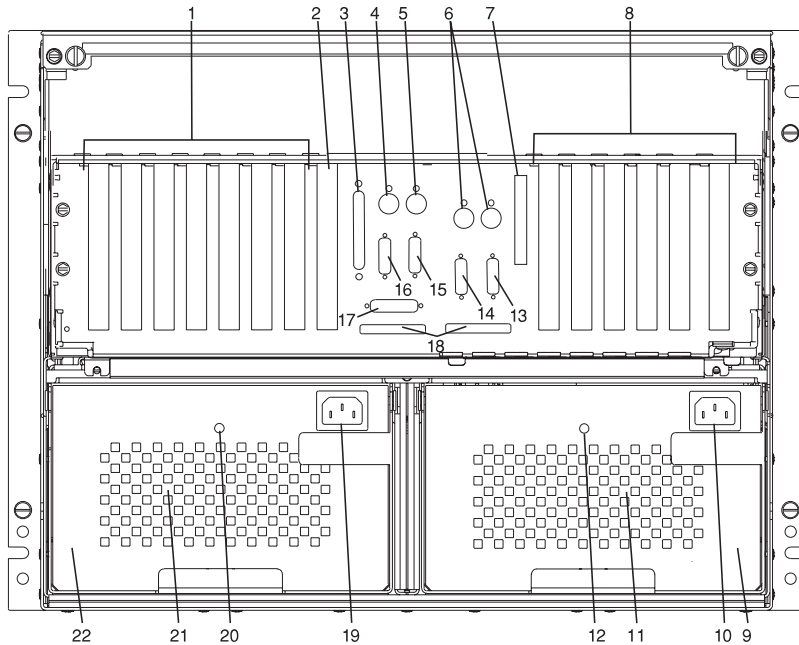

1. PCI adapter slots (1 - 7)
2. PCI adapter slot 8, service processor card and JTAG cable in primary I/O drawer (drawer 0)
3. Parallel connector
4. Keyboard connector
5. Mouse connector
6. Reserved
7. SCSI Redrive card (if installed)
8. PCI adapter slots (9 - 14)
9. Right power supply
10. Power cord connector for right power supply
11. Fans (mounted on front end of right power supply)
12. Right power supply, power good LED
13. SPCN2 connector
14. SPCN1 connector
15. Serial port S2
16. Serial port S1

17. Operator panel (OP) connector
18. RIO 0 and RIO 1 connectors
19. Power cord connector for left power supply
20. Left power supply, power good LED
21. Fans (mounted on front end of left power supply)
22. Left power supply.

7 EIA Unit I/O Drawer

The 7 EIA Unit I/O Drawer Input/Output connectors are shown in the following figure.

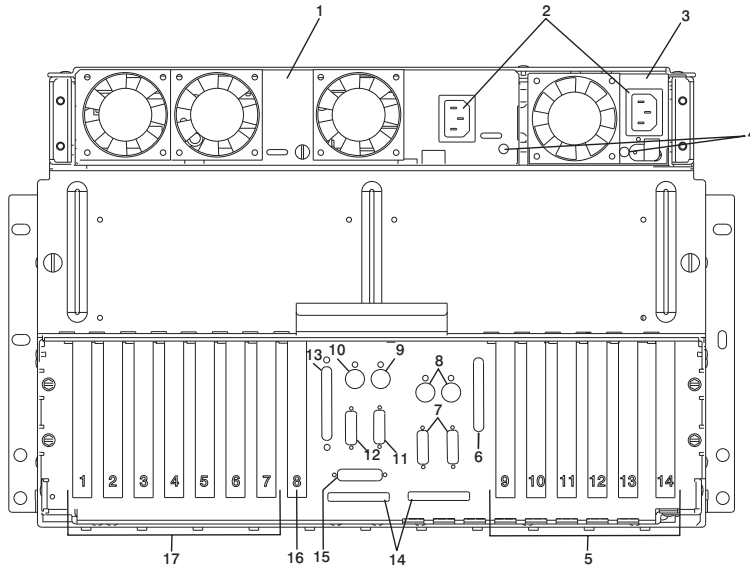

1. 3/4 power supply
2. Power cord connectors
3. 1/4 power supply
4. Power good LEDs for the three quarter and 1 quarter power supplies
5. PCI adapter slots (9 - 14)
6. DASD connector
7. SPCN 1 (left) SPCN2 (right) connectors
8. Reserved
9. Mouse connector
10. Keyboard Connector
11. Serial Port S2
12. Serial Port S1
13. Parallel Connector
14. RIO 0 and RIO 1
15. Operator panel (OP) connector
16. PCI adapter slot (8) service processor card connector (JTAG)
17. PCI adapter slots (1 - 7)

Chapter 2. Using the System

Powering Off and Powering On the System or Frame

The following diagram shows the locations of the operator panel display and the operator panel.

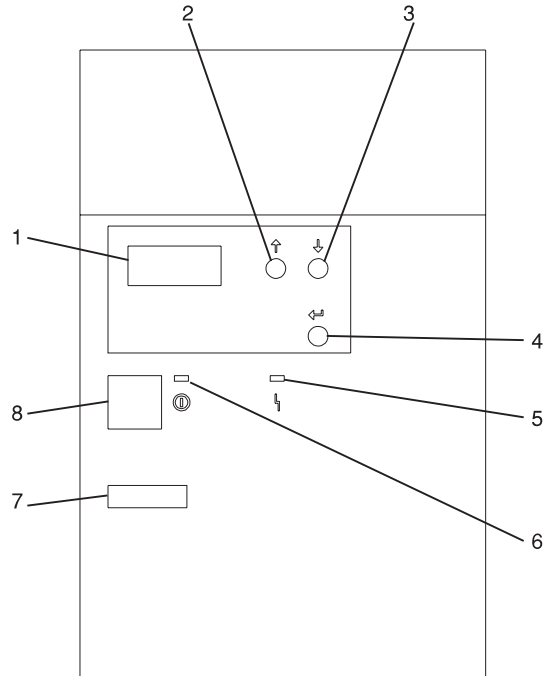

- 1 Operator Panel Display
- 2 Scroll Up Pushbutton
- 3 Scroll Down Pushbutton
- 4 Enter Pushbutton
- 5 Attention LED
- 6 Power On LED
- 7 Serial Number
- 8 Power Pushbutton

For more information on operator panel functions, see Appendix C on page C-1.

Powering On the System

Perform the following steps to power on your system rack and I/O Drawer(s):

1. Open the operator panel cover on the system rack.
2. Press the Power (white) pushbutton on the operator panel.
3. The Power On light on the operator panel starts blinking as the system is powered on. The light stops blinking and stays on when power on is complete. Likewise, the green LED on the I/O Drawer(s) starts blinking as the system is powered on. The light stops blinking and stays on when power on is complete.

For more information, see “System Power-On Methods” on page 3-29.

Powering Off the System

If the system is operating under AIX, enter the shutdown -F command to power off the system.

If you cannot use this method, you can power off the system by using the following operator panel power Pushbutton procedure.

Attention: Using the operator panel Power pushbutton to power off the system without first shutting down the operating system may cause unpredictable results in the data files, and the next IPL takes longer to complete.

1. Open the operator panel cover.
2. Press the Power pushbutton (white) on the operator panel.

The Data/Function display shows **⓪ ?** (the international power-off symbol) with the **?** blinking.

3. Press the Power pushbutton (white) on the operator panel again to confirm.

Note: To cancel the power-off operation, do not press the Power pushbutton a second time. Instead, press any other operator panel pushbutton.

4. The operator panel Power On light starts blinking as the system powers off. The operator panel light stops blinking and stays off when the power-off operation is complete. The green LED on the I/O Drawer(s) goes to a slow blink, indicating the I/O Drawer power is now on standby.

Does the system power off successfully?

No



Yes

This ends the procedure.

5. Perform the following:

- a. Press the ↑ or the ↓ pushbutton until function 08 is shown in the operator panel display.
- b. Press the Enter pushbutton.
- c. SRC A100 8008 is shown on the Data display.

6. Press the Power pushbutton (white) on the operator panel.

The operator panel display shows **08** **ⓘ ?** (the international power-off symbol) with the **?** blinking.

7. Press the Power pushbutton (white) on the operator panel again.

The system powers off, and the Power On light on the system rack operator panel display goes off and remains off. The green LED on the I/O Drawer(s) goes to a slow blink, indicating the I/O Drawer power is now on standby.

Note: To cancel the power-off operation, do not select function 08. Instead, press any other operator panel pushbutton.

For additional information on Function 08 - Fast Power Off, see page C-7

Post Indicators

During the power-on sequence (if a graphics terminal is attached) a series of ICONs appear on the display. When the POST is finished, the following screen is displayed.

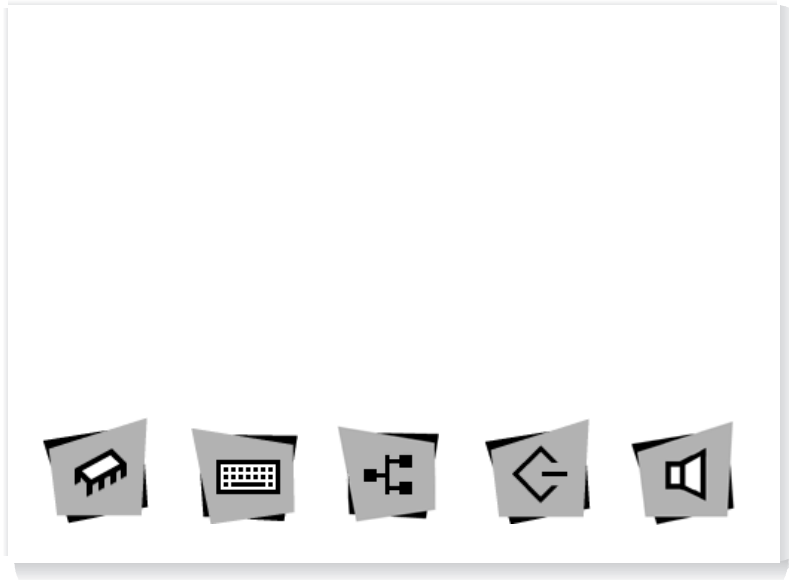

This section describes the meaning of each of the displayed icons.

The POST screen displays the following objects.



Memory Module: Memory test.



Keyboard: Initialize the keyboard and mouse. The window for pressing the function keys is now open. See “Function Keys” on page 2-7 for more information.



Network: Self-test on network adapters.



SCSI: Adapters are being initialized.



Speaker: Sounds an audible tone at the end of POST.

If using an ASCII terminal, the following text is displayed.

- Memory
- Keyboard
- Network
- SCSI
- Speaker

Function Keys

PF1 Key

- PF1, when operated from a directly attached keyboard, invokes the System Management Services (SMS) GUI interface.
- Numerical **1 key** is the equivalent key on an ASCII terminal.

PF5 Key

- The default boot list, located in firmware, is used.
- Numerical **5 key** is the equivalent key on an ASCII terminal.

This mode attempts to boot from the first device of each type found in the list. It does not search for other bootable devices of that type if the first device is not bootable. Instead, it continues to the next device type in the list. The firmware supports up to five entries in the boot list.

The default boot order is:

1. Diskette
2. CD ROM
3. Hard File
4. Tape Drive
5. Network
 - a. Token Ring
 - b. Ethernet

PF6 key: PF6 works like PF5 with some exceptions

- Firmware looks for a boot record according to the custom bootlist that was setup by System Management Services.
- Numerical **6 key** is the equivalent key on an ASCII terminal.

PF8 key: To enter the Open Firmware command line, you must press the **F8** key *after the keyboard icon appears* and before the last icon (the speaker icon) appears during the startup power-on sequence. After pressing **F8**, the remaining icons display until initialization completes.

When initialization and power-on self test (POST) are complete, the Open Firmware command line (an "OK" prompt) appears.

The Open Firmware command line is used to set up adapters that are not configurable with the System Management Services. Your adapter documentation directs you to use this option if it is needed.

To exit from the Open Firmware command enter `reset-all` or power the system down and reboot.

Console Strategy

If a console has not yet been selected, a previous console selection sequence timed out, or a change in the system configuration affecting the console (keyboard installed/removed, mouse installed/removed, graphics adapter installed/removed or moved to another PCI slot), the firmware invokes a console selection sequence at system boot time. The console selection sequence allows the selection (from the appropriate input device) of any one of all the available console devices. If no console is selected within approximately 60 seconds, serial port 1 (com1) is selected as the console and the selection sequence times out.

Once a console has been selected, the console selection sequence is only invoked at boot time if there is a change in the system configuration (as described above), or the contents of the system's non-volatile memory (nvram) is lost.

Note: Moving an ASCII terminal from one serial port to another (from com1 to com2) is not detectable by the firmware so it does not constitute a configuration change.

A system console selection sequence can also be initiated from the SMS menus.

Reading the System Rack Operator Panel Display

The operator panel display is used to:

- Track the progress of the system unit self tests and configuration program.
- Display codes when the operating system comes to an abnormal end.
- Display system messages.

During power-on self-test (POST), 4 and 8 characters display indicating the progress of the testing. If an error is detected that requires attention, the system unit halts with up to a 72-digit number shown 8 digits at a time on the operator panel. This number identifies the error (see *RS/6000 Enterprise Servers S70 and S7A and Installation and Service Guide* for a listing of the error codes). The attention light turns on to indicate an error condition.

4-digit progress codes (checkpoints) are in the form of Ennn, where E is the first character and n is alphabetic or numeric characters.

8-digit progress codes (checkpoints) are in the form of Cnnn nnnn, where C is 'C' and n is alphabetic or numeric.

The diagram on page 2-1 shows the locations of the operator panel display and the operator panel. For details about the operator panel functions and descriptions, see Appendix C on page C-1.

I/O Drawer Indicator Panels

The 10 EIA Unit I/O Drawer and 7 EIA Unit I/O Drawer have different indicator panels. This section describes the two types of indicator panels.

10 EIA Unit I/O Drawer Indicator Panel

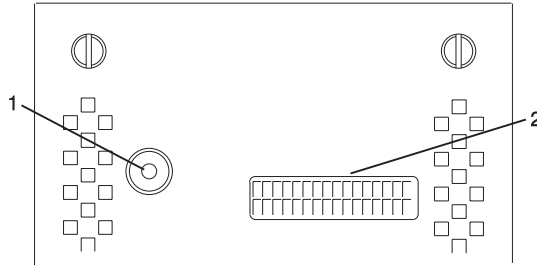

- 1 Power On LED
- 2 Drawer Indicator Panel Display

10 EIA Unit I/O Drawer and Power Supply LED Status

| State of LED | Operator Panel LED | Right Power Supply LED | Left Power Supply LED |
|--------------------|---------------------------------------|---------------------------------------|---------------------------------------|
| Off | No power connected | No power connected | No power connected |
| On, blinking green | System power connected, not turned on | System power connected, not turned on | System power connected, not turned on |
| On, steady green | System power connected and turned on | System power connected and turned on | System power connected and turned on |

10 EIA Unit I/O Drawer Indicator Panel Status

| Drawer State | LED | Drawer Indicator Panel |
|---|----------|-------------------------|
| After Connecting AC Power | | |
| Standby | Blinking | Blinking location U?.? |
| System power | On solid | Blinking location U?.? |
| Receive Firmware Command | On solid | On solid location Ux.y# |
| Thereafter | On solid | On solid location Ux.y# |
| After Power is Removed Because of a Shutdown | | |
| Standby | Blinking | Blinking location Ux.y |
| System power | Solid | Blinking location Ux.y |
| Receive Firmware Command | Solid | Solid location Ux.y# |
| Thereafter | Solid | Solid location Ux.y# |
| # represents a blinking asterisk (*) | | |

7 EIA Unit I/O Drawer Indicator Panel

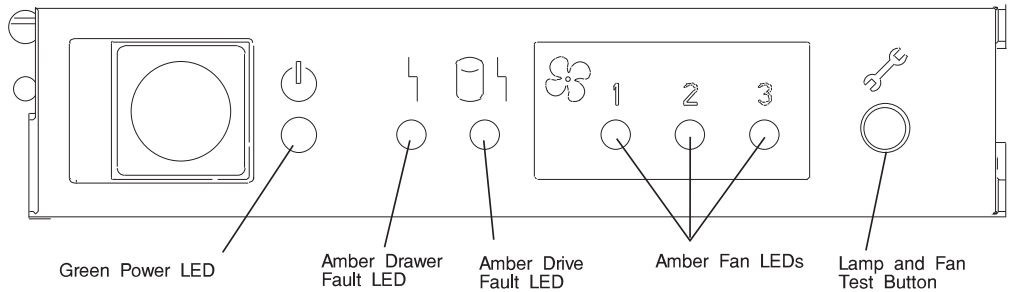

External indicators on the front indicator panel indicate status for functions in the I/O Drawer and they are visible with the rack door open. They are:

1. A green POWER LED to indicate that distribution DC voltage is present in the I/O Drawer (Power Good).
 - a. ON if power good (power levels are within operating range).
 - b. OFF if power bad (power levels are outside of operating range) or off.
 - c. Slowly blinking if system is plugged into wall outlet but the power sequence has not been applied.
2. Two amber CHECK LEDs
 - a. Drawer Fault
 1. When a Power supply fails (check power good LED on rear of I/O Drawer power supplies).
 2. When a fan fails.
 - b. Drive Fault

| | |
|-------------------|---|
| OFF | No drive fault and no drive is in the identify state. |
| ON | One or more backplanes have a SCSI reset fault. |
| SLOW FLASH | One or more backplanes have a power or cooling fault. The drawer fault LED is also on. The LEDs on all drives on any affected backplane are flashing. |
| FAST FLASH | One or more backplanes are in the identify for remove state (the green LED is flashing on one or more carriers). |

3. Three amber FAN LEDs

All three are off when the fans are operational. The corresponding LED is turned on if a fan fails.

4. Lamp/Fan test button

If the I/O drawer power is up, pressing this button causes all the LEDs on the indicator panel to light, and the three cooling fans in the I/O Drawer to go to high speed.

Using the Keyboards

There are several keyboards available for the system unit. The keyboards have various keys that enter data and control the cursor location. The keyboards can be engraved for the languages of different countries.

The functions of each keyboard depend on the software used. The character sets for the keyboards are contained and explained in the information for your operating system.

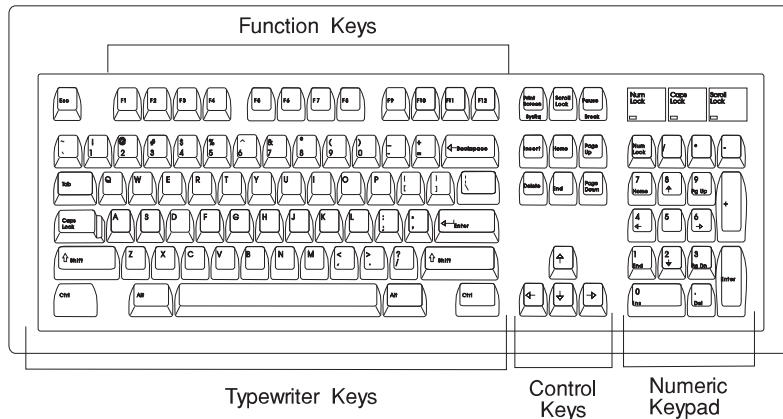

The keyboard is divided into four sections:

- Function keys are multipurpose keys and their function is controlled by the operating system.
- Typewriter keys are similar to a standard typewriter. Their function is controlled by the software.
- Control keys move the cursor on the screen and do programmed control functions. The movement and functions depend upon the application used.
- Numeric keypad is arranged like a calculator to help when typing numbers.

On all of the keyboards, you can adjust the tilt position for typing comfort. To tilt the keyboard, pull out on the keyboard legs. The legs snap into position. To decrease the tilt of the keyboard, rotate the keyboard legs until they snap into the bottom of the keyboard case.

The keyboard cable plugs into the keyboard connector at the rear of the system unit.

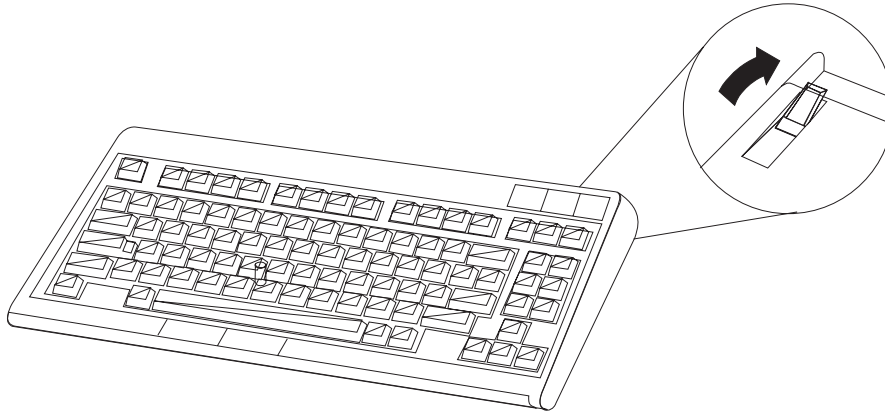

Using the Three-Button Mouse

The mouse is a hand-operated locating device. A three-button mouse is available for use with the system unit.

Consult your application publication for the exact use of the three-button mouse.

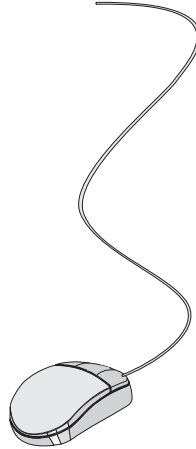

You can use the mouse to perform such functions as positioning a cursor, selecting items from a menu, or moving around in your document much easier and faster than if you used only the keyboard. The cursor moves exactly as you move the mouse on a flat surface, such as a desktop.

When you move the mouse around on a flat surface as shown in this illustration, the cursor moves on the display screen; the movement changes the position of the cursor.

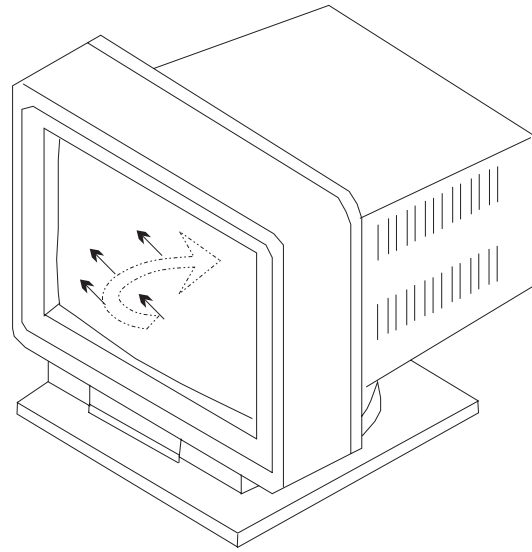
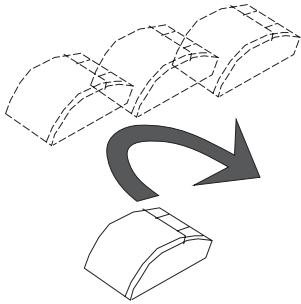

With the mouse buttons, you can perform functions such as selecting and deselecting options, extending your selection, or choosing a command. The precise function of your mouse depends on the software you are using.

The mouse has a cable that plugs into the mouse connector at the rear of the system unit.

Handling the Mouse Correctly

For best operation, handle the mouse with care. Incorrect handling can damage the mouse.

Do not:

- Operate the mouse on cloth, unfinished wood, newspaper, or carpet.
- Drop or hit the mouse.
- Carry the mouse by holding onto the cable.
- Expose the mouse to extreme temperatures or direct sunlight.
- Place the mouse in liquid spills.

Care of the Mouse

The operating surface for the mouse should be smooth, clean, and flat. For example, you can operate the mouse on the following surfaces:

- Finished wood
- Glass
- Enamel
- Plastic
- Paper (except newspaper)
- Metal

Rough surfaces collect contaminants that can be transferred to the interior of the mouse by the ball. The surface you use should be free from spills, dirt, dust, lint, wax, eraser dust, and other foreign matter. Rough surfaces can also cause the pads located on the bottom of the mouse to prematurely wear. A deeply pitted surface could cause erratic operation of the mouse.

- Inspect the work surface for spills or other contaminants.
- Dust the work surface.
- If you are using a paper pad, inspect it for wear and replace it if necessary.

Cleaning the Mouse

1. Remove the retaining ring by turning it counterclockwise, in the direction of the arrow as shown in the illustration.

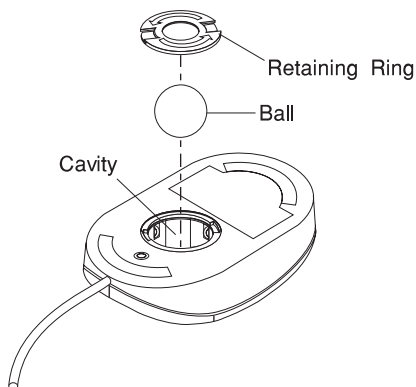

2. Remove the ball.
3. Inspect the ball for contaminants. Wipe it clean with a dry, lint-free cloth.
4. If the ball is dirty, wash it in warm, soapy water. Rinse and wipe the ball with a lint-free cloth until dry.
5. Inspect the ball cavity in the mouse for foreign materials. If there are any foreign materials, remove them.
6. Replace the ball.
7. Replace the retaining ring on the mouse and align it with the open slots in the ball cavity.
8. Turn the retaining ring clockwise until the open slots are covered and you hear the ring snap into place.

Using the 3.5-Inch Diskette Drive

Diskette Compatibility

The system unit has a 1.44MB diskette drive installed.

The 1.44MB diskette drive can format, read, and write diskettes compatible with the following diskette drives:

- 1.0MB diskettes with 720KB formatted data capacity.
- 2.0MB diskettes with 1.44MB formatted data capacity (HD).

Format the diskette according to its specified capacity.

Write-Protecting 3.5-Inch Diskettes

Write-protecting diskettes is necessary so that important information is not accidentally lost.

When diskettes are write-protected, you can read information from the diskettes, but you cannot write information on to them.

There is a write-protect tab on the 3.5-inch diskette.

To locate the write-protect tab, turn the diskette over with the label facing down.

- To prevent writing onto a diskette, slide the write-protect tab, to open the protect slot.

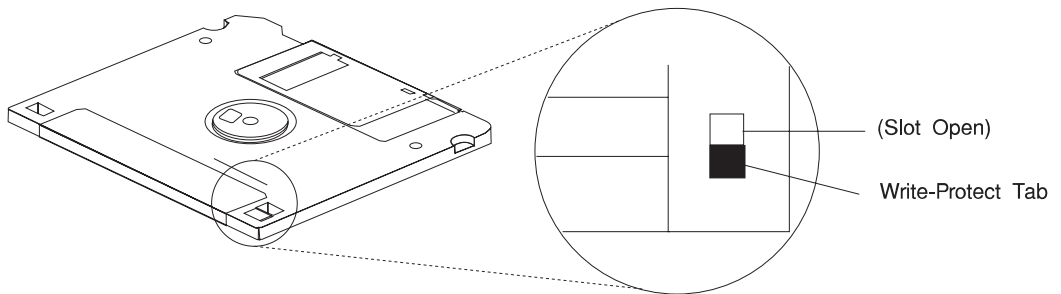

- To allow writing onto a diskette, slide the write-protect tab to cover the protect slot.

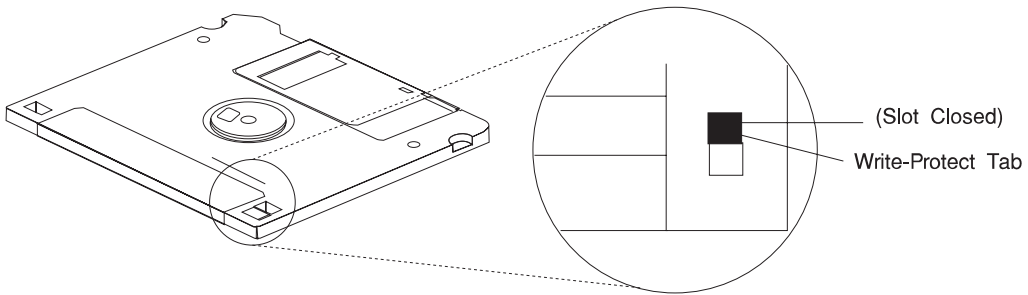

Loading and Unloading the 3.5-Inch Diskette

To load a diskette into the drive, insert the diskette in the diskette drive with the labeled metal shutter first. Push the diskette into the drive until you hear a click. The click indicates that the diskette is securely in position in the drive.

To unload the diskette, push the diskette-unload button. The diskette unloads partially from the drive. Pull the diskette out.

General Information for 5.0GB 8-mm Tape Drive

Recommendations

- Use only Data Grade 8-mm tape cartridges. These cartridges are identified by either a Data, D, or D8 marking on the data cartridge. Use of video grade cartridges can damage the 8-mm tape drive and can void the warranty of your 8-mm tape drive, and data written on these tapes may be lost over a short period of time.
- Remove the tape cartridge from the tape drive when it is not in use, and store the cartridge in the cartridge case.
- Do not open the door on the data tape cartridge. This door covers and protects the magnetic tape material from dirt, dust, and damage.
- Avoid touching the tape since this can cause loss of data.
- Keep the tape drive door closed except when loading or unloading a tape cartridge.
- Back up and then discard any tape cartridge that repeatedly produces error messages. The error information is in the system error log.
- Clean the tape path regularly according to the cleaning procedure of the 8-mm tape drive. Use only recommended cleaning cartridges; other cleaning cartridges can permanently damage your 8-mm tape drive.

Attention: Do not use video grade cartridges in the 8-mm tape drive. Video grade tapes may be unreliable and may cause permanent damage to the 8-mm tape drive.

Types of 8-mm Tape Cartridges

- **Test Tape Cartridge:** This is a specially labeled tape cartridge that is in the media kit with the 8-mm tape drive. Use this cartridge only when checking the operation of the drive or running diagnostics; do not use it to save programs or data.
- **Data Tape Cartridge:** This is a non-labeled blank tape cartridge that is in the media kit. Use this cartridge for saving your programs or data. The same data tape cartridge can be used in either a 2.3GB 8-mm tape drive or a 5.0GB 8-mm tape drive.
- **Cleaning Tape Cartridge:** Use this cartridge for cleaning the 8-mm tape path. For more information, see “Cleaning the Tape Path on the 5.0GB 8-mm Tape Drive” on page 2-28.

Tape Cartridge Compatibility

The 8-mm tape drive is compatible with existing 8-mm tape subsystems that comply to the American National Standard (ANSI) X3B5/89-136, Helical-scan Digital Computer Tape Cartridge, 8-mm for Information Exchange. Data compression effectively increases the cartridge capacity and data transfer rate for the 5.0GB tape cartridges.

Note: 160 meter cartridges are not processed and are automatically ejected by the drive.

| Format Modes (C=compression mode) | | | | |
|-----------------------------------|------------|-----------|------------|------------|
| 8-mm Tape Drive | 2.3GB | 2.3GB (C) | 5.0GB | 5.0GB (C) |
| 2.3GB | Read/Write | | | |
| 5.0GB | Read/Write | Read only | Read/Write | Read/Write |

Setting the Write-Protect Tab on 8-mm Tape Cartridges

Setting the write-protect tab on a tape cartridge is necessary so that information is not accidentally lost. When the write-protect tab of a tape cartridge is set (window open), information can be read from the tape, but cannot be written to it.

The window on the tape cartridge controls write-protection.

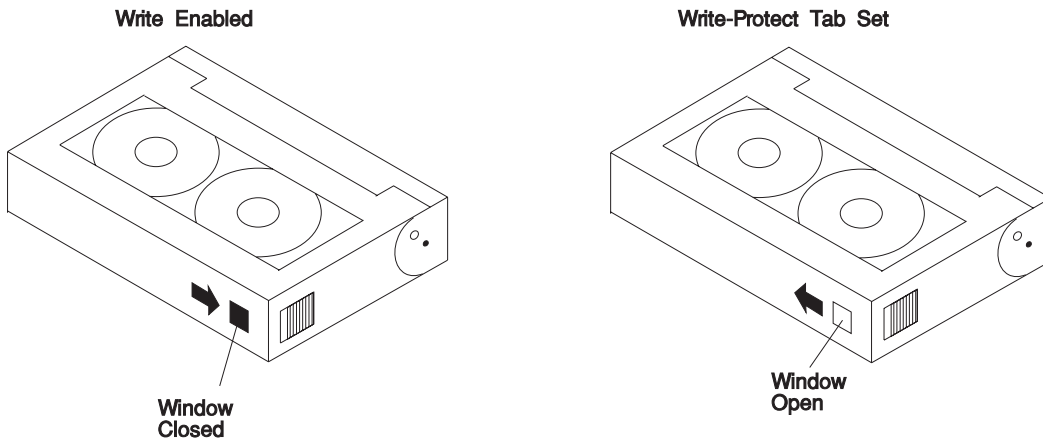

Environment Considerations for 8-mm Data Cartridges

Information in this section describes operating and storage conditions including temperature, relative humidity, and maximum wet bulb data.

Attention: The manufacturer has specified a set of temperature and humidity ranges in which the 8-mm data cartridge can operate with ease. Only regular cleaning procedures are required when operating the cartridge within this range. The risk of possible data loss is increased if 8-mm tape cartridges are operated, stored, or shipped outside the temperature or humidity ranges shown in the following table.

Before using a cartridge, always let it adjust (acclimate) to the operating environment. Do this by placing the cartridge with its container in the operating environment for as long as it has been away from this environment or for 24 hours, whichever is less.

Acclimation is necessary for any data cartridge that has been exposed to a different humidity environment or a temperature change of 11°C or 20°F or more.

| | Operating Ranges | Storage | Shipping |
|---------------------------------------|--------------------------------|-------------------------------|-----------------------------------|
| Temperature | 16°C to 32°C (60°F to 90°F) | 5°C to 32°C (40°F to 90°F) | -40°C to 52°C (-40°F to 125°F) |
| Relative Humidity (non-condensing) | 20 to 80% | 20 to 80% | 5 to 80% |
| Maximum Wet Bulb | 26°C (79°F) | 26°C (79°F) | 26°C (79°F) |

Operating in Harsh Environments

The 8-mm tape drive is ideally suited to streaming operations, as opposed to tape movement operations involving multiple stop/starts and random searches. When the tape is used for frequent stop and start operations, streaming movement is beneficial and should be used whenever possible. This can be accomplished by ensuring that any save or restore operation is the only active operation performed by a device connected to this SCSI I/O controller.

Any tape that has been used outside the ranges specified in the table on 2-23 for an extended period of time (50 passes in 40 hours of nonstop operation) should not be used as an archival tape. Exposure to the environment deteriorates the magnetic and physical strength of the tape. Do not store important data on a tape that has been used outside the specified ranges; transfer the data to a new tape for reliable archiving.

8-mm Data Cartridge Erasure

Most bulk eraser devices do not have the capability to erase 8-mm data cartridges. To properly erase an 8-mm data cartridge with a bulk eraser device, the erasure rating must be at least 1500 oersted.

The 2.3GB and the 5.0GB 8-mm tape drives erase residual data before writing new data on the data tape.

Tape Cartridge Data Efficiency

The 8-mm tape cartridge efficiency is defined as the amount of data that can be stored on the cartridge. The following variables affect the amount of data that can be stored on a tape cartridge:

- Size of the data file
- Number of file marks per file
- File mark size used
- Compatibility mode (2.3GB or 5.0GB)
- Media rewrites.

Using the 5.0GB 8-mm Tape Drive

The optional 5.0GB 8-mm tape drive is a half-height device.

Status Lights

The 5.0GB 8-mm tape drive has two green status lights and one amber status light. The on and off combinations of the status lights indicate the conditions of the 8-mm tape drive.

Each of the International Organization for Standards (ISO) symbols located next to a status light indicates a specific condition of the tape drive as follows:

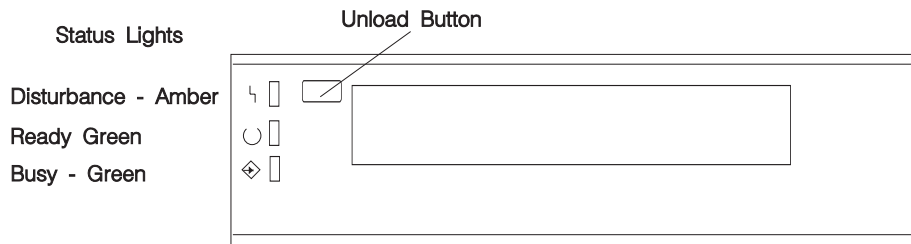

Status Light States

The following table explains the meaning of the green and amber status lights.

| Status Lights on the 5.0GB 8-mm Tape Drive | | | |
|--|---------------|-----------------|---------------------|
| Status | Ready (green) | Busy (green) | Disturbance (amber) |
| The power-on self-test (POST) is running or the system has issued a Reset to the drive. | On | On | On |
| One of the following has occurred: <ul style="list-style-type: none">The power is off.The POST has completed successfully, but no tape cartridge has been inserted. | Off | Off | Off or On |
| A tape cartridge has been inserted and the 8-mm tape drive is ready to receive commands from the system. | On | Off | Off or On |
| A tape cartridge has been inserted and the 8-mm tape drive is performing a tape load or unload operation. | Off | Flashing | Off or On |
| The tape is in motion and the 8-mm tape drive is busy running a device operation. | On | Flashing | Off or On |
| The 8-mm tape drive has detected an internal fault that requires corrective action. If this occurs, see the following note. | Off | Off | Flashing |
| The tape path requires cleaning. Refer to "Cleaning the Tape Path on the 5.0GB 8-mm Tape Drive" on page 2-28. | Off or On | Off or Flashing | On |

Note: If a fault or an error condition occurs, first try to recover by pressing the unload button. If this does not correct the fault, switch off the power to the 8-mm tape drive and then switch on the power to the drive. If the condition continues, call your service representative.

Loading the 8-mm Tape Cartridge

Before loading the tape cartridge, make sure the power is on and the write-protect tab on the tape cartridge is properly set. Refer to “Setting the Write-Protect Tab on 8-mm Tape Cartridges” on page 2-22. The tape drive loads the tape from the cartridge and prepares it for reading and writing.

To load the 8-mm tape cartridge, do the following:

1. Grasp the edges of the 8-mm tape cartridge with the write-protect tab toward you and the window side of the cartridge facing up.
2. Slide the tape cartridge into the opening on the front of the 8-mm tape drive until the loading mechanism pulls the cartridge into the drive and the drive door closes. The ready status light (green) goes on if the load operation was successful.

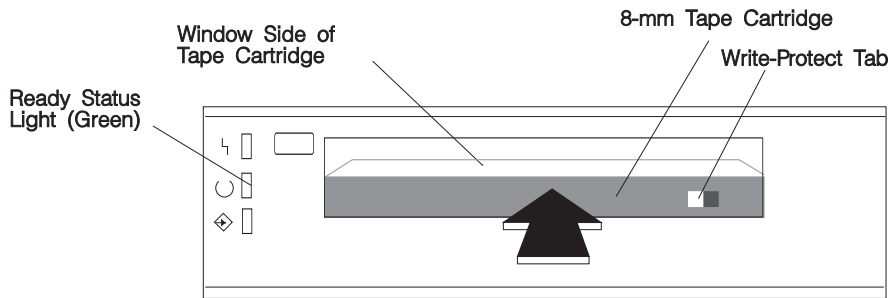

The 8-mm tape drive is ready for data operations when the tape cartridge is inserted. After the cartridge is inserted into the tape drive, the tape takes about 25 seconds to load; this does not interfere with beginning the data operations.

Commands can be entered while the tape is loading. Any commands to the tape drive start running once the tape has finished loading. Commands not requiring the tape cartridge are run immediately.

Unloading the 8-mm Tape Cartridge

Before performing the unload operation, make sure the power to the 8-mm tape drive is on.

To unload and eject the tape cartridge, press the unload button. The 8-mm tape drive rewinds the tape and then ejects the tape cartridge from the tape drive.

After pressing the unload button, the following occurs:

1. The ready status light goes off.
2. The busy status light flashes during the unload operation.
3. The busy status light goes off when the cartridge is ejected from the tape drive.

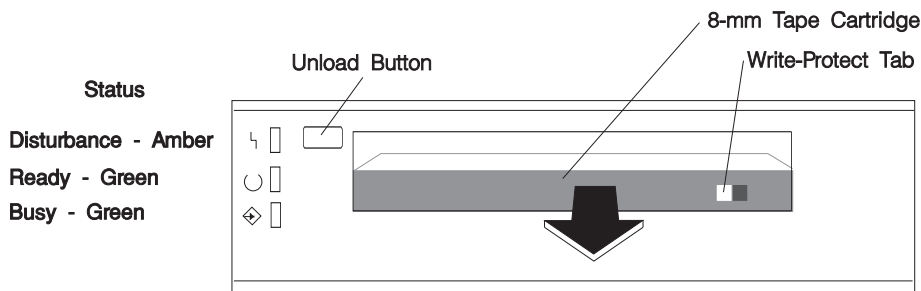

The time required for a tape to rewind and unload is between 18 seconds and 3 minutes, depending on the position of the tape when the unload button is pushed.

If the tape cartridge cannot unload and has to be removed manually from the drive, contact your service representative.

Cleaning the Tape Path on the 5.0GB 8-mm Tape Drive

Attention: Do not use video cleaning cartridges in the 8-mm tape drive. Video cleaning cartridges can damage the 8-mm tape drive.

The 8-mm tape path should be cleaned either approximately every 30 hours of tape motion or once a month, whichever occurs first. The 5.0GB 8-mm tape drive counts the number of hours of tape motion and indicates when the tape path requires cleaning when the lighted disturbance status light (amber) is on.

More frequent cleaning may be required if the drive is operated in a dusty environment or in humid conditions. If the dust is allowed to accumulate, the drive has to perform more reads and writes. This can cause data loss, and may be prevented by regularly scheduled cleaning of the drive.

The cleaning cartridge cleans the 8-mm tape drive. If you attempt to use an 8-mm cleaning cartridge more times than allowed, the tape drive automatically detects the error and ejects the cleaning cartridge. The disturbance status light (amber) remains on if it was on prior to the cleaning operation being attempted.

Some video cleaning cartridges are extremely abrasive. An 8-mm tape drive may be permanently damaged after only a few cleaning operations using an abrasive-type cleaning cartridge.

Before loading the cleaning cartridge, make sure the power to the 8-mm tape drive is on.

To load the 8-mm cleaning cartridge, do the following:

1. Grasp the edges of the 8-mm cleaning cartridge with the window side of the cartridge facing up.
2. Slide the cleaning cartridge into the opening on the front of the 8-mm tape drive until the loading mechanism pulls the cartridge into the drive.

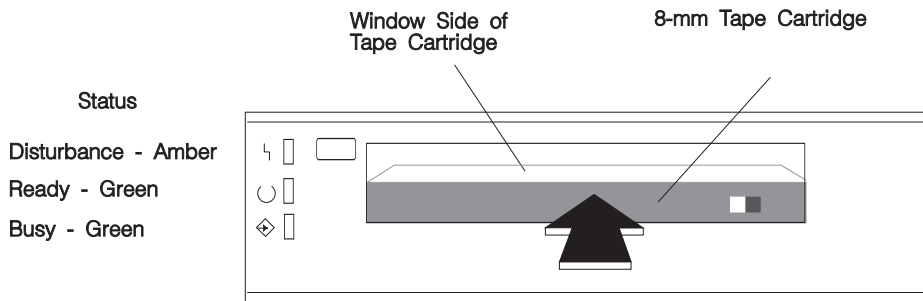

After the 8-mm cleaning cartridge has been fully inserted into the 8-mm tape drive, the following cleaning operations are performed automatically:

1. The cleaning tape is loaded into the tape path.
2. The drive is cleaned by moving the cleaning tape forward for approximately two minutes.
3. The tape is unloaded and the cleaning cartridge is ejected from the tape drive when the cleaning operation is complete.
4. A successful cleaning operation is indicated when the disturbance status light (amber) goes off.

General Information for 4.0GB 4-mm Tape Drive

The 4.0GB 4-mm tape drive is a streaming tape drive that is used to:

- Save and restore system data files.
- Archive important records.
- Distribute operating system software upgrades.

The 4-mm tape drive can be attached to any system using a single-ended interface meeting the Small Computer System Interface II (SCSI-II) Standard ANSI X3.131-199X Rev. 10h.

The 4-mm tape drive has the following features:

- Capacity of 4.0 GB per cartridge. 8 GB is typical with data compression and with DDS2 data cartridges.

The actual capacity per cartridge varies depending on the application and the type of data cartridge being used.

- Data transfer rate is 400 KBps. 800 KBps is typical with data compression.

Note: Data compression activated is the default setting from the factory. Data compression is usually controlled by the application software.

- Read and write of DDS|||| tape cartridges in 2.0 GB per cartridge format.
- A status light that indicates when it is time to clean the tape path.
- Internal diagnostics that are activated when the 4 mm Diagnostic Cartridge is inserted and loaded into the drive.
- Media recognition system: only data grade media can be written with this tape drive.

The 4-mm tape drive uses a 4-mm data cartridge for saving and restoring your system data. The 4-mm tape drive writes and reads only 4-mm Digital Data Storage (DDS|||| or DDS2) cartridges.

Recommendations

Attention: Tape cartridges that do not carry the proper DDS symbol cannot be written to and their use may cause the 4-mm tape drive to report an error.

- Use only 4-mm Digital Data Storage (DDS|||| or DDS2) cartridges.
Attention: Use of other than recommended cleaning cartridges can damage your tape drive and voids the drive warranty.
- Clean the tape path by using the recommended cleaning cartridge. Follow the instructions on the cartridge.
- Back up and then discard any tape cartridge that repeatedly produces error messages. The error information is in the system error log.
- Do not open the door on the data cartridge that covers the tape. This door protects the magnetic tape material from dirt, dust, and damage.
- Do not operate in a dusty environment.
- Do not touch the tape material. Any substance transferred to the tape by touching it could cause loss of data.

Types of 4-mm Tape Cartridges

The 4-mm tape drive is shipped with three 4-mm cartridges to help start your tape operations immediately.

- | | |
|-----------------------------------|---|
| 4-mm Data Cartridge: | Use this non-labeled cartridge for saving or restoring your programs or data. Additional data cartridges can be ordered. |
| 4-mm Diagnostic Cartridge: | Use this specially labeled cartridge to perform diagnostics on the drive. Do not use it to save or restore programs or data. |
| Cleaning Cartridge: | Use this cartridge for cleaning the 4-mm tape path. For more information, see “Cleaning the Tape Path on the 4.0GB 4-mm Tape Drive” on page 2-39. |

Tape Cartridge Compatibility

The 4-mm Tape Drive is compatible with existing 4mm tape subsystems that are designed to operate with Digital Data Storage approved media, which meet the following standards:

- For DDS||||
 - American National Standard (ANSI) standard, X3.203-191, Helical-scan Digital Computer Tape Cartridge, 3.81mm.
 - European Computer Manufacturers Association (EMCA) standard, EMCA-150, 3.81mm Wide Magnetic Tape Cartridge and DDS|||| format.
- For DDS2
 - European Computer Manufacturers Association (EMCA) standard, EMCA/TC17/93/20, 3.81mm Wide Magnetic Tape Cartridge for Information Interchange Helical Scan Recording, DDS2 format.

You cannot change the density setting of the drive, because the device reconfigures itself automatically, depending on the media type installed, as follows:

| Media Type | Device Configuration |
|-------------------|---|
| Non-DDS | Read-only |
| DDS | Read/write in 2.0GB mode only |
| DDS2 | Read in either density; write in 4.0GB mode only. |

Setting the Write-Protect Tab on 4-mm Tape Cartridges

The window on the tape cartridge controls write-protection. When the write-protect tab of a tape cartridge is set (window open), information can be read from the tape, but cannot be written to it. When the write-protect tab of a tape cartridge is not set (window closed), information can be both written to and read from the tape. Trying to write to a 4-mm data cartridge with the window open causes an error.

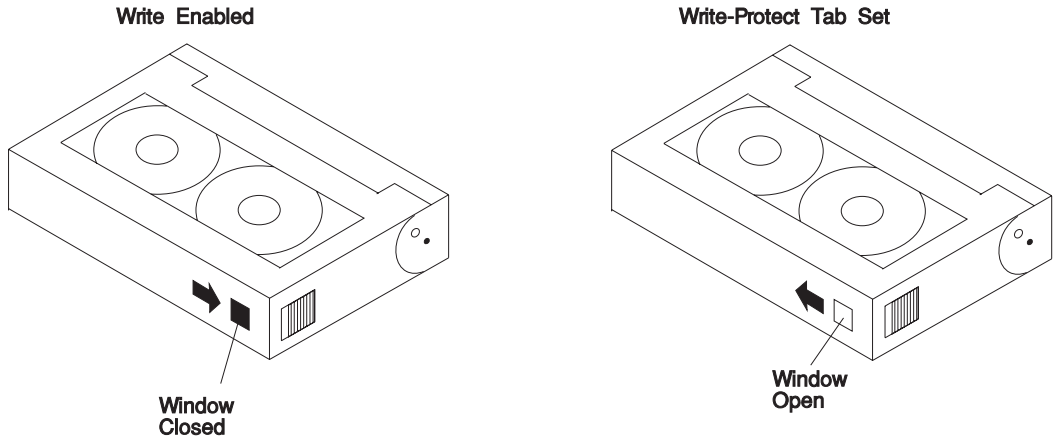

Environmental Considerations for 4-mm Data Cartridges

Information in this section describes operating and storage conditions including temperature, relative humidity, and maximum wet bulb data.

Attention: The manufacturer has specified a set of temperature and humidity ranges in which the 4-mm data cartridge can operate with ease. Only regular cleaning procedures, as described in “Cleaning the Tape Path on the 4.0GB 4-mm Tape Drive” on page 2-39 are required when operating the cartridge within this range. The risk of possible data loss is increased if 4-mm tape cartridges are operated, stored, or shipped outside the temperature or humidity ranges shown in the following table.

Before using a cartridge, always let it adjust (acclimate) to the operating environment. Do this by placing the cartridge with its container in the operating environment for as long as it has been away from this environment or for 24 hours, whichever is less.

Acclimation is necessary for any data cartridge that has been exposed to a different humidity environment or a temperature change of 11°C or 20°F or more.

| | Operating Ranges | Storage | Shipping |
|---------------------------------------|--------------------------------|-------------------------------|-----------------------------------|
| Temperature | 16°C to 32°C (60°F to 90°F) | 5°C to 32°C (40°F to 90°F) | -40°C to 52°C (-40°F to 125°F) |
| Relative Humidity (non-condensing) | 20 to 80% | 20 to 80% | 5 to 80% |
| Maximum Wet Bulb | 26°C (79°F) | 26°C (79°F) | 26°C (79°F) |

Operating in Harsh Environments

The 4-mm tape drive is ideally suited to streaming operations, as opposed to tape movement operations involving multiple stop/starts and random searches. When the tape is used for frequent stop and start operations, streaming movement is beneficial and should be used whenever possible. This can be accomplished by ensuring that any save or restore operation is the only active operation performed by a device connected to this SCSI I/O controller.

Any tape that has been used outside the ranges specified in the previous table for an extended period of time (50 passes in 40 hours of nonstop operation) should not be used as an archival tape. Exposure to the environment deteriorates the magnetic and physical strength of the tape. Do not store important data on a tape that has been used outside the specified ranges; transfer the data to a new tape for reliable archiving.

4-mm Data Cartridge Erasure

Most bulk eraser devices do not have the capability to erase 4-mm data cartridges. To properly erase an 4-mm data cartridge with a bulk eraser device, the erasure rating must be at least 2000 oersted.

The 4-mm tape drive erases residual data before writing new data on the data tape.

Tape Cartridge Data Capacity

The 4-mm tape cartridge capacity is defined as the amount of data that can be stored on the cartridge. The following variables affect the amount of data that can be stored on a tape cartridge:

- Size of the data file
- Number of file marks per file
- Compatibility mode (2GB or 4GB)
- Media rewrites.

Using the 4.0GB 4-mm Tape Drive

The optional 4.0GB 4-mm tape drive is a half-high device.

Status Lights

The 4.0GB 4-mm tape drive has two green status lights and one amber status light. The on and off combinations of the status lights indicate the conditions of the 4-mm tape drive.

Each of the International Organization for Standards (ISO) symbols located over a status light indicates a specific condition of the tape drive as follows:

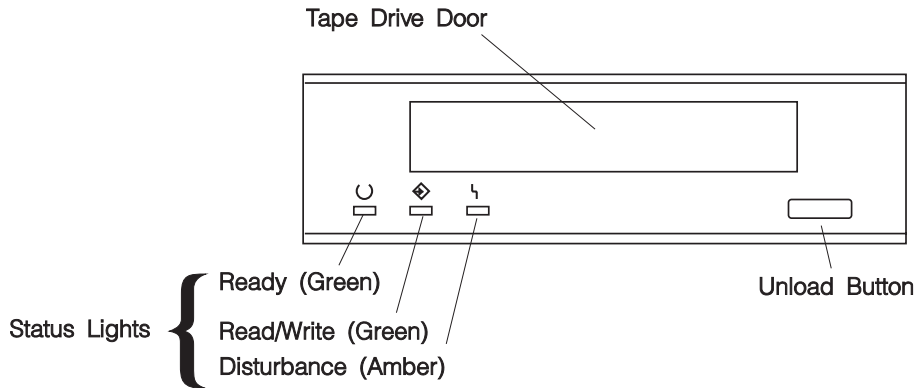

Status Light States

The following tables explain the meaning of the green and amber status lights.

| | Ready (green) | Read-Write (green) | Disturbance (amber) |
|----------|---|-----------------------------|---------------------------------|
| Off | No cartridge installed or error condition | No cartridge or no activity | No error condition |
| Steady | Cartridge installed or loading/unloading | | Cleaning required or worn media |
| Flashing | Power-on self- test in progress | Cartridge activity | Error condition |

| Status Lights on the 4.0GB 4-mm Tape Drive | | | |
|--|--------------------------|--------------------------|--------------------------|
| Status | Ready (green) | Read-Write (green) | Disturbance (amber) |
| LED test | On 2 seconds at power on | On 2 seconds at power on | On 2 seconds at power on |
| The power-on self-test (POST) is running or the Diagnostic Cartridge is running. | Flashing | Off | Off |
| One of the following has occurred: <ul style="list-style-type: none"> The power is off. The POST has completed successfully, but no tape cartridge has been loaded. | Off | Off | Off or On |
| A tape cartridge has been inserted and the 4-mm Tape Drive is Ready to receive commands from the system. | On | Off | Off or ON |
| The tape is in motion and the 4-mm Tape Drive is running a device operation or cleaning. | On | Flashing | Off or On |
| The 4-mm Tape Drive has detected an internal error that requires corrective action such as tape cartridge failure, high humidity, or no SCSI terminator. Refer to the service guide or contact your service representative (see note below). | Off | Off | Flashing |
| The tape path requires cleaning or a poor quality tape cartridge is being used. See "Cleaning the Tape Path on the 4.0GB 4-mm Tape Drive" on page 2-39. | Off or On | Off or Flashing | On |

Note: If an error condition occurs, first try to recover by pressing the unload button. If this does not correct the error, switch off the power to the 4-mm tape drive and then switch on the power to the drive. If the condition continues, call your service representative.

Loading the 4-mm Tape Cartridge

Before loading the tape cartridge, make sure the power is on and the write-protect switch on the tape cartridge is properly set. Refer to “Setting the Write-Protect Tab on 4-mm Tape Cartridges” on page 2-33. The tape drive loads the tape from the cartridge and prepares it for reading and writing.

To load the 4-mm tape cartridge, do the following:

1. Grasp the edges of the 4-mm tape cartridge with the write-protect tab towards you and the window side of the cartridge facing up.
2. Slide the tape cartridge into the opening on the front of the 4-mm tape drive until the loading mechanism pulls the cartridge into the drive and the drive door closes. The ready status light (green) goes on if the load operation was successful.

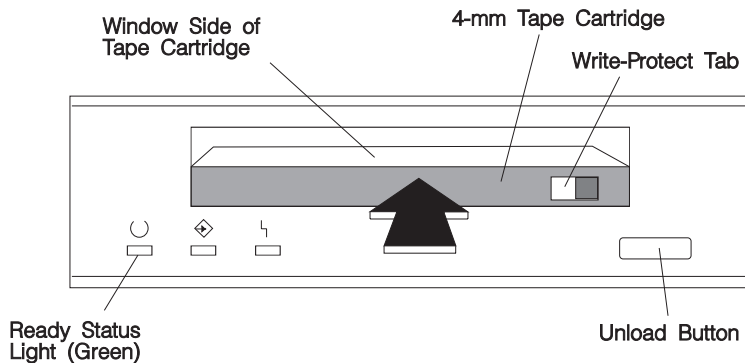

The 4-mm tape drive is ready for data operations when the tape cartridge is inserted. After the cartridge is inserted into the tape drive, the tape takes about 15 seconds to load.

Unloading the 4-mm Tape Cartridge

Before performing the unload operation, make sure the power to the 4-mm tape drive is on.

To unload and eject the tape cartridge, press the unload button. The 4-mm tape drive rewinds the tape and then ejects the tape cartridge from the tape drive.

After pressing the unload button, the following occurs:

1. The Read-Write status light flashes during the unload operation.
2. The Ready status light and the Read-Write status light turns off when the cartridge is ejected from the tape drive.

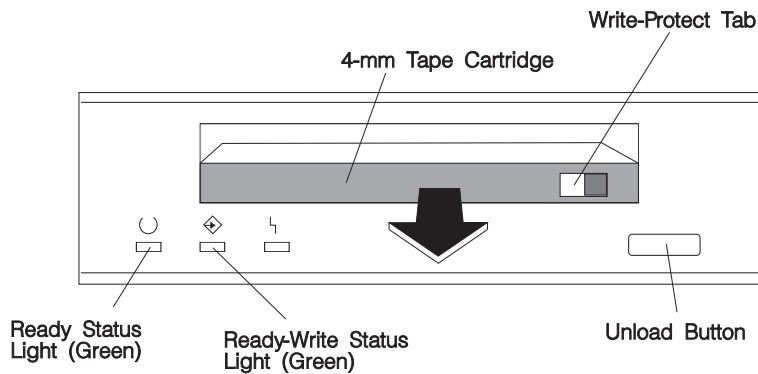

The time required for a tape to rewind and unload is between 10 seconds and 1.5 minutes, depending on the position of the tape when the unload button is pushed.

If the tape cartridge cannot unload and has to be removed manually from the drive, contact your service representative.

Cleaning the Tape Path on the 4.0GB 4-mm Tape Drive

The 4-mm tape path should be cleaned either approximately every 30 hours of tape motion or once a month, whichever occurs first. The 4-mm tape drive monitors the recording quality of the tape cartridge and indicates that the tape path requires cleaning when the disturbance status light (amber) is on.

More frequent cleaning may be required if the drive is operated in a dusty environment or in humid conditions. If the dust is allowed to accumulate, the drive has to perform more reads and writes. This can cause data loss, and may be prevented by regularly scheduled cleaning of the drive.

The cleaning cartridge cleans the 4-mm tape drive 50 times before it needs to be discarded. If you attempt to use a 4-mm cleaning cartridge more than 50 times, the tape drive automatically detects the error and ejects the cleaning cartridge with the disturbance status light (amber) remaining on.

Before loading the cleaning cartridge, make sure the power to the 4-mm tape drive is on.

To load the 4-mm cleaning cartridge, do the following:

1. Grasp the edges of the 4-mm cleaning cartridge with the window side of the cartridge facing up.
2. Slide the cleaning cartridge into the opening on the front of the 4-mm tape drive until the loading mechanism pulls the cartridge into the drive.

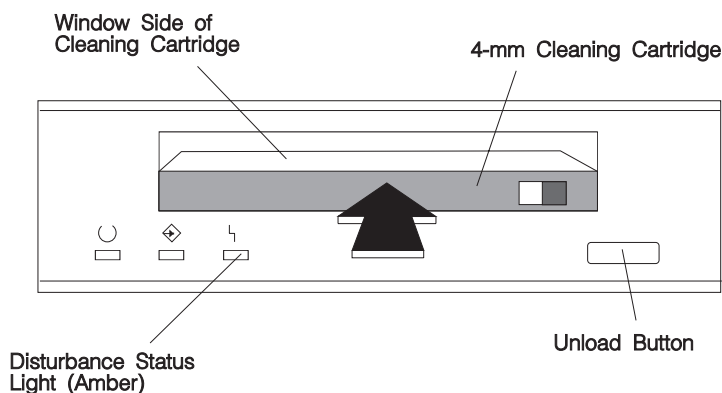

After the 4-mm cleaning cartridge has been fully inserted into the 4-mm tape drive, the following cleaning operations are performed automatically:

1. The cleaning tape is loaded into the tape path.
2. The drive is cleaned by moving the cleaning tape forward for approximately 30 seconds.
3. The tape is unloaded and the cleaning cartridge is ejected from the tape drive when the cleaning operation is complete.
4. A successful cleaning operation is indicated when the disturbance status light (amber) goes off (if it was activated before the cleaning operation).

If the cleaning cartridge has been used more than 50 times the disturbance status light (Amber) flashes.

Using the CD-ROM Drive

CAUTION:

A Class 3 laser is contained in the device. Do not attempt to operate the device while it is disassembled. Do not attempt to open the covers of the device, as it is not serviceable and is to be replaced as a unit.

The CD-ROM is located in bay A of the I/O Drawer. Your CD-ROM drive looks like the one shown in the illustration, and the controls are located as indicated.

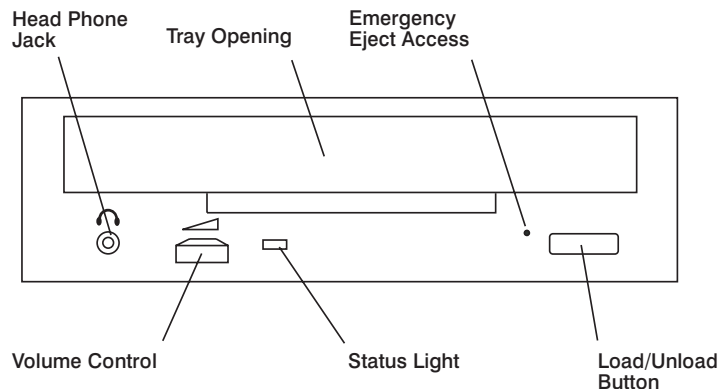

When the CD-ROM is set to On, the status light indicates one of several conditions. The following are status light states and the respective conditions of the CD-ROM drive:

- Off during standby with the tray loaded or unloaded.
- Blinks from insertion of the tray to completion of initialization.
- Blinks slowly when either the lens or disc is dusty (lens should be cleaned by running the cleaning disc).
- Blinks fast when in the audio mode.
- Lights during data transfer operations.
- Lights steady when:
 - No disc is in the tray.
 - The disc is in the tray upside down.
 - Some condition exists that should be checked. If this occurs, contact your service representative.

Loading the CD-ROM Drive

Press the unload button to open the tray. Place the disc, with the printed side away from the tray, into the tray. Push gently on the load/unload button. The drive automatically pulls the tray into the drive and prepares the disc for reading.

Unloading the CD-ROM Drive

Push and hold the unload button until the drawer comes out and then remove the disc.

Cleaning the CD-ROM Drive

This CD-ROM drive has an internal head-cleaning mechanism, and therefore does not require an external cleaning device. The internal cleaning mechanism cleans the head every time the tray is operated.

Always handle discs carefully by the edges to avoid leaving fingerprints or scratching the disc. (This helps the disc to maintain good readability.) Discs can be wiped with a soft, lint-free cloth or lens tissue. Always wipe in a straight line from the inner hub to the outer rim.

Emergency Eject

Note: Execute the following procedure only in an emergency. For example, the caddy does not eject when pressing the unload button.

1. Insert a small diameter rod, such as a straightened paper clip, into the emergency eject hole. (Refer to the illustration below for the location of the emergency eject hole.)
2. Push the tool in until some resistance is felt.
3. Maintain a small amount of pressure on the rod while pulling on the tray with your finger nail.
4. Pull the tray open and remove the disc.

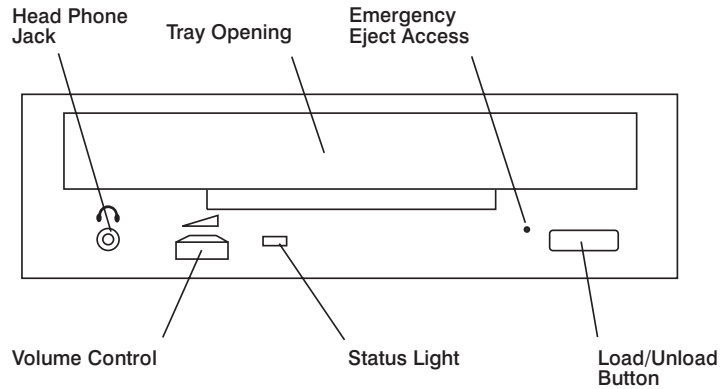

Note: Normally the tray makes a ratcheting sound when pulling it open using the above procedure.

Using the Hot Swap Disk Drives

- For information on inserting a SCSI disk drive, go to page 2-50.
- For information on removing a SCSI disk drive, go to page 2-48.

Relationship of AIX Prompts and Physical Drive Location

A SCSI adapter and a SCSI drive address can be displayed on a user display. The AIX command **lsdev -C** returns the attached devices on the system display. For more information, see the documentation for the operating system that controls the system unit. The following diagrams show the physical locations of the drives.

10 EIA Unit I/O Drawer Locations

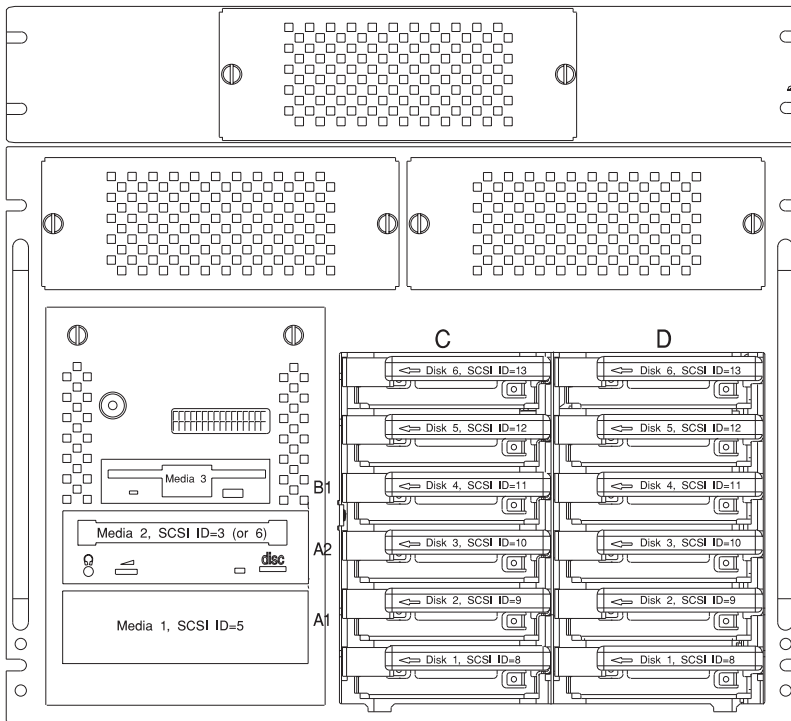

7 EIA Unit I/O Drawer Locations

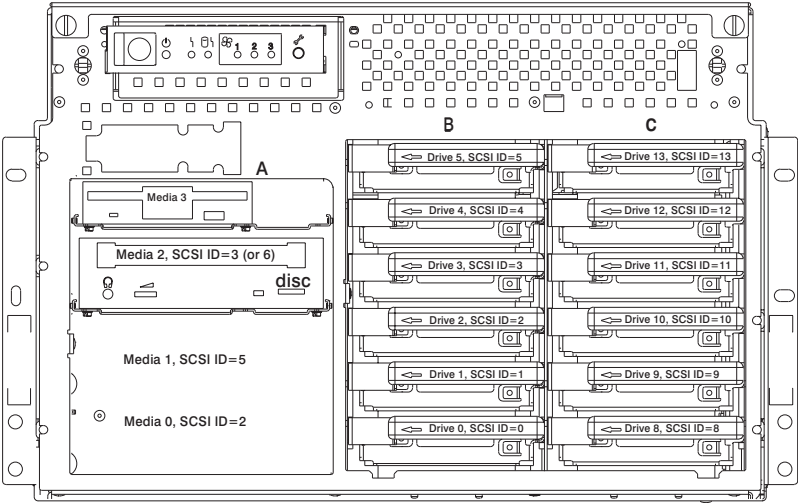

Handling Guidelines

The hot-swap disk drive is a sensitive device. Handle the hot-swap carrier and disk drive with care.

- Do not drop the disk drive or subject the drive to excessive shock.
- Do not expose the disk drive to temperatures lower than -40° F (-40° C) or higher than 158 ° F (70° C).
- If drive temperature changes, allow approximately one hour of temperature acclimatization for every 18° F (10° C) of temperature change.
- Never allow moisture to condense on the drive.
- Static electricity can damage your equipment. Take these precautions to avoid static electricity damage:
 - If you have an antistatic wrist strap available, use it while handling the device.
 - Always handle your disk drive carefully.
 - Handle the drive by the edges and never touch any exposed circuitry.
 - Prevent others from touching the drive.
- Store the hot-swap disk drive in a protective container such as an instrument case or in a protected area.
- Failure to observe these precautions may lead to product failure, damage, and invalidation of all warranties.

Labels

Several labels are included in your system ship group which may be attached to the handle of the hot-swap drive. The labels may be marked in any way that the user can easily identify the drive for removal or installation.

Disk Drive Status Light States

SCSI Disk Drives: The following table explains the meaning of the green and amber status lights and spin down button.

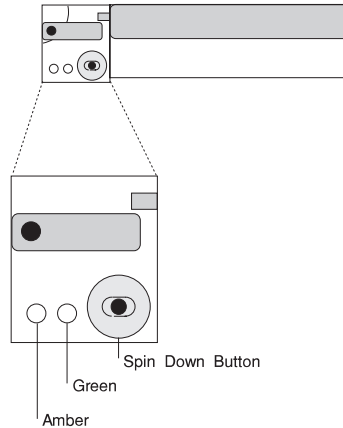

| SCSI Disk Drive Status Lights | | |
|-------------------------------|-----------|----------------------------------|
| Light or Button | Status | Definition |
| Amber | On | Drive spinning |
| | Off | Drive not spinning |
| Green | On | Power On |
| | Off | Power Off |
| | Blinking | Power Off/Drive identify |
| Spin down | Depressed | Spin down drive and remove power |

Removing and Inserting Disk Drives

This section provides instructions to help you remove or insert disk drives into hot-swap bays.

Unconfiguring or Configuring a Disk Drive

This procedure applies to SCSI hot swap disk drives.

Note: You do not have to power down the system to remove a hot-swappable assembly from the 10 EIA Unit I/O Drawer. Before you perform these procedures, take the appropriate actions to backup the data for the drive you are removing, and that the drive has been removed from the configuration. Physically removing a hot swap drive from the 10 EIA Unit I/O Drawer before it has been removed from the system configuration, may cause unrecoverable data corruption.

Unconfiguring (Removing) or Configuring a Disk Drive: There are three conditions where you need to use these procedures:

- You are removing or installing a drive while the system power is turned on.
- You are installing a new drive.
- You are removing a drive from the system.

Unconfiguring: To unconfigure (remove) a disk drive:

1. Login as root.
2. Enter the **smit** command.
3. Select **Devices**.
4. **SCSI Hot Swap Disk Drives:**
 - a. Select **Fixed Disk**.
 - b. Select **Remove a Fixed Disk**.
 - c. Select the disk you want to remove from the list on the screen.
 - d. When you get to the Keep Definition option, select **Yes**. This retains the details of the drive in the device configuration database.
 - e. Select the **Do** option to remove the drive.
 - f. The drive can now be removed from the drawer, return to the procedure that directed you here.

Configuring

1. Login as root.
2. Enter the **smit** command.
3. Select **Devices**.
4. Select the type of drive you want to configure.
5. **SCSI Hot Swap Disk Drives**
 - a. Select **Add** for the type of drive you are configuring, then select the type of drive you are adding.
 - b. The drive is ready to use.

Inserting a Disk Drive into the Hot-Swap Bays

This procedure describes how to insert disk drives into a hot-swap bay while the I/O Drawer is powered on.

Attention: Caution should be used when handling all hard drives. Drives are more likely to be damaged during installation and service. Bumping or handling drives roughly causes latent failures. Don't stack drives and always use appropriate ESD practices. A drop of as little as 1/4 inch can cause latent failures. Media can take 30 seconds to spin down, so ensure at least a 30 second delay after switching off the hot-swappable drives for removal.

Notes:

1. Disk drive banks support hot-swappable disk drives only.
2. This procedure is similar for any hot-swap disk drive that is supported by this drawer. interchangeable.
3. For additional information regarding the operation of the hot-swap disk drives see the installation and user's guide that came with the drives.
4. Remember that each 1.6 inch SCSI disk drive takes two bays.

This section gives the instructions for inserting hot-swap disk drives into the disk drive banks.

1. To insert a hot-swap disk drive, remove the front bezel by grasping each side and gently pulling the bezel toward you (this applies only to 7 EIA Unit I/O Drawers).

Note: Rack is shown with the door and hinges removed.

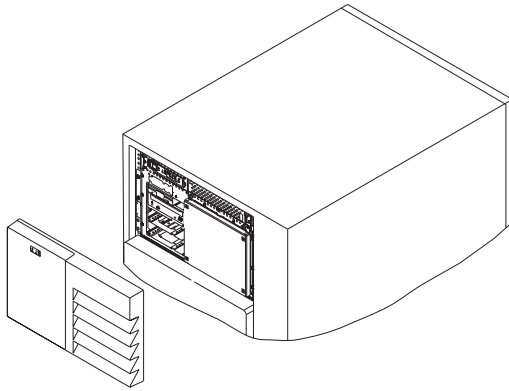

2. Loosen the screws that hold the disk drive cover to the drawer and remove the disk drive cover from the drawer, storing it in a safe place.

Note: Rack is shown with the door and hinges removed.

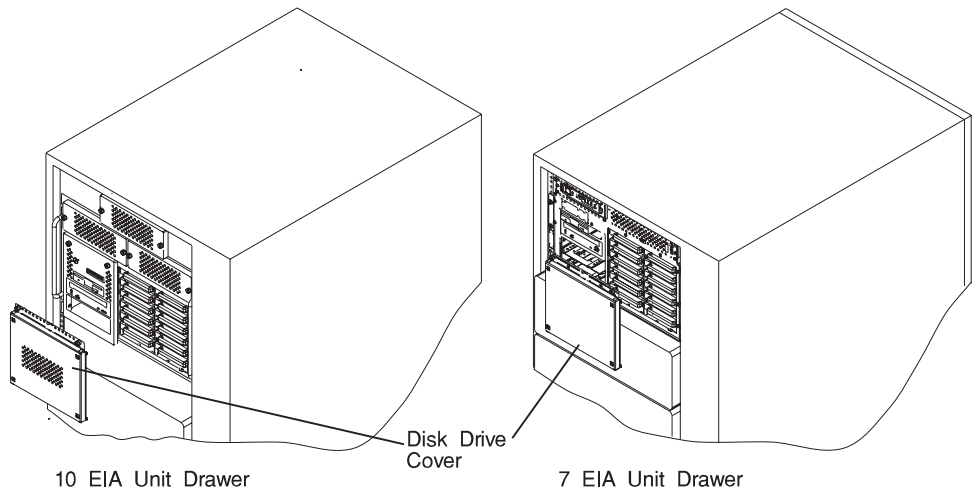

3. Each hot-swap disk drive must have a hot-swap disk drive carrier attached.

Attention: Handle the hot-swap disk drive with care as it is very fragile and can be easily damaged if exposed to shock, electrostatic discharge, or rough handling.

4. It is recommended that you insert the hot-swap disk drive in the next unused position of the disk drive banks, going from bottom to top.

Attention: Attaching SCSI address jumpers on the hot swap disk drive rather than using the automatic ID furnished by the backplane is not advised. Attaching jumpers can cause service problems, multiple drives at the same address, or confusion locating the correct drive.

- a. Rotate the carrier latch to the open position.

SCSI Disk Drives

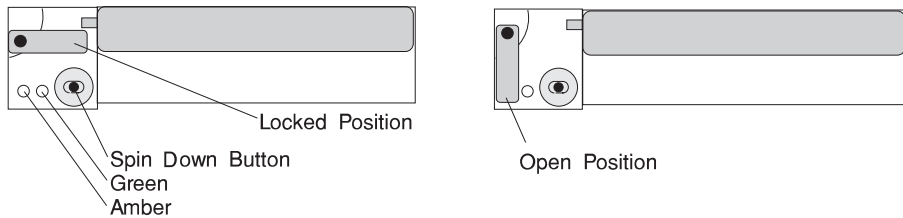

- b. Position the drive carrier assembly horizontally, with the connector facing into the bay.

- c. Align the side of the carrier with the raised guides on the left of the bay.
- d. Slide the carrier into the bay gently to keep from damaging the hot swap disk drive. Slide the carrier to the rear of the bay until it is seated into the connector.

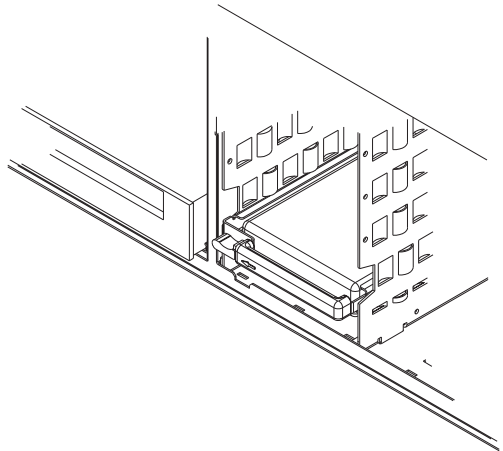
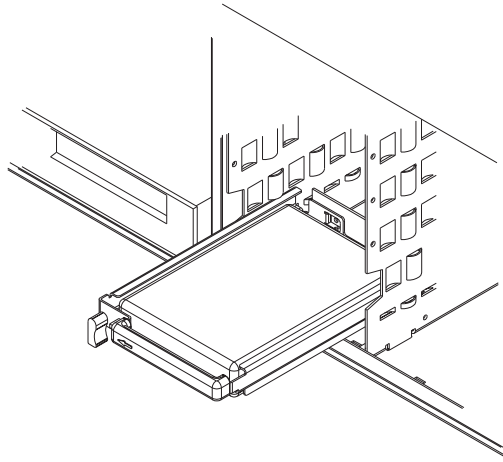

- e. Move the carrier latch to the locked position. If the carrier does not lock, check that the drive carrier is fully seated in the backplane. When the drive carrier is fully seated and power is turned on, the green LED on the drive carrier illuminates.

SCSI Disk Drives

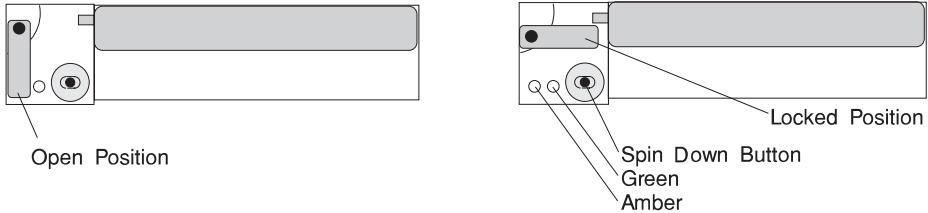

The following table explains the meaning of the green and amber status LEDs and spin down button on a SCSI disk drive.

| Status LEDs | | |
|---------------|-----------|----------------------------------|
| LED or Button | Status | Definition |
| Amber | On | Drive spinning |
| | Off | Drive not spinning |
| Green | On | Power On |
| | Off | Power Off |
| | Blinking | Power Off/Drive identify |
| Spin down | Depressed | Spin down drive and remove power |

5. Go to Appendix A on page A-1 to record the drive location and the ID assigned to the drive; then return here to determine your next step.
6. If you have other hot-swap disk drives to insert, go to page 2-52.
7. If you do not have any other procedures to perform, replace the cover that you removed in step 2 on page 2-51.
8. Reinstall the bezel by aligning the two metal guides on the bezel to the guide receptacles on the drawer. Push the bezel in place taking care to insure the Velcro loops on the bezel align to the Velcro hooks on the drawer (this applies to 7 EIA Unit I/O Drawer only).
9. Go to “Unconfiguring or Configuring a Disk Drive” on page 2-48 and configure the disk drive unit you just inserted.

Removing Disk Drives from the Hot-Swap Bays

This procedure describes how to remove hot-swap disk drives from a hot swap bay while the I/O Drawer is powered on.

If you remove a hot-swap disk drive when the I/O Drawer power is off, steps 4 on page 2-57 and 5 on page 2-58 do not apply.

Attention: Caution should be used when handling all hard disk drives. Drives are more likely to be damaged during installation and service. Bumping or handling drives roughly causes latent failures. Do not stack drives and always use appropriate ESD (Electro-Static Discharge) practices. A drop of as little as 6.5 mm (.25 inches) can cause latent failures. Media can take 30 seconds to spin down, so ensure at least a 30 second delay has passed after switching off hot-swappable drives for removal.

1. Go to “Unconfiguring or Configuring a Disk Drive” on page 2-48 and unconfigure the disk drive unit you are removing.
2. Remove the front bezel by grasping each side and gently pulling the bezel towards you (this only applies to 7 EIA Unit I/O Drawers).

Note: Rack is shown with the door and hinges removed.

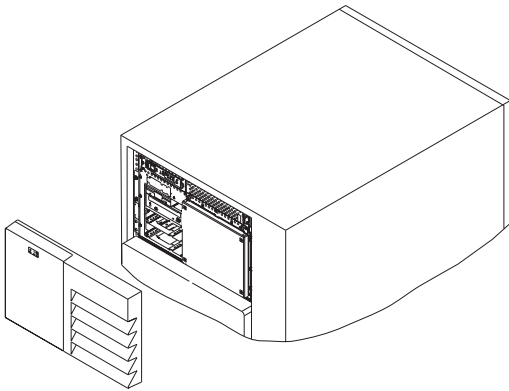

3. Loosen the screws that hold the disk drive cover to the drawer and remove the disk drive cover from the drawer, storing it in a safe place.

Note: Rack is shown with the door and hinges removed.

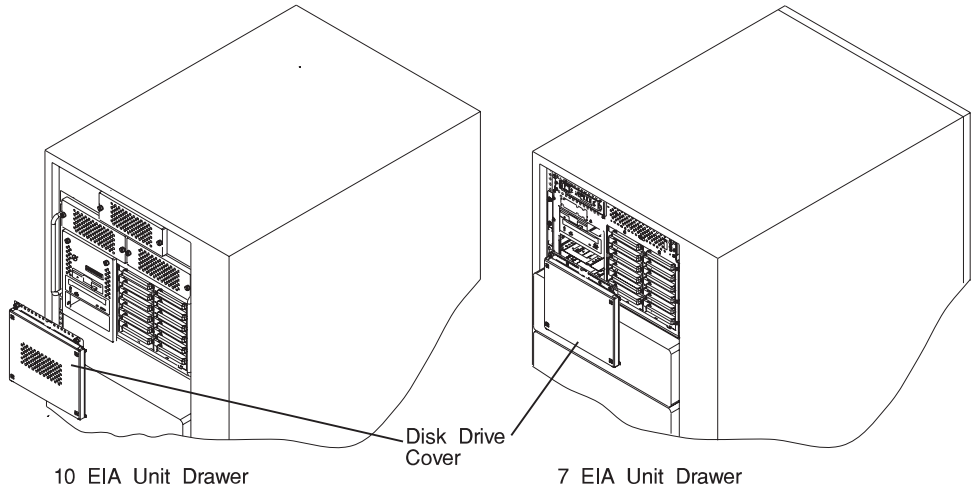

Attention: Physically removing a hot-swap drive from the I/O Drawer before it has been removed from the system configuration, may cause unrecoverable data corruption.

4. Verify that the device has been removed from the system configuration; the yellow LED on the hot-swap disk drive should be off.

5. For SCSI disk drives, press the spin down button on the hot swap disk drive; observe the green flashing LED.
6. Unlock the drive by turning the carrier latch 90 degrees clockwise to the open position.

SCSI Disk Drives

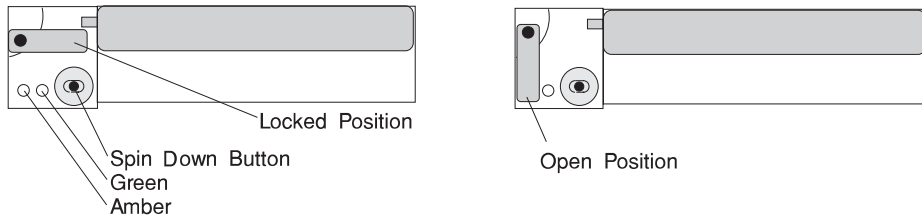

7. Disconnect the drive from the connector on the backplane by grasping the handle on the drive carrier and carefully pulling the drive out of the server.

Attention: Do not open the drive; no user adjustments or serviceable parts are inside.

8. Place the hot-swap disk drive in a protective container.
9. Replace the disk drive cover that you removed earlier.

10. Reinstall the bezel by aligning the two metal guides on the bezel to the guide receptacles on the drawer. Push the bezel in place taking care to insure the Velcro loops on the bezel align to the Velcro hooks on the drawer (this applies to 7 EIA Unit I/O Drawers only).

Note: Rack is shown with the door and hinges removed.

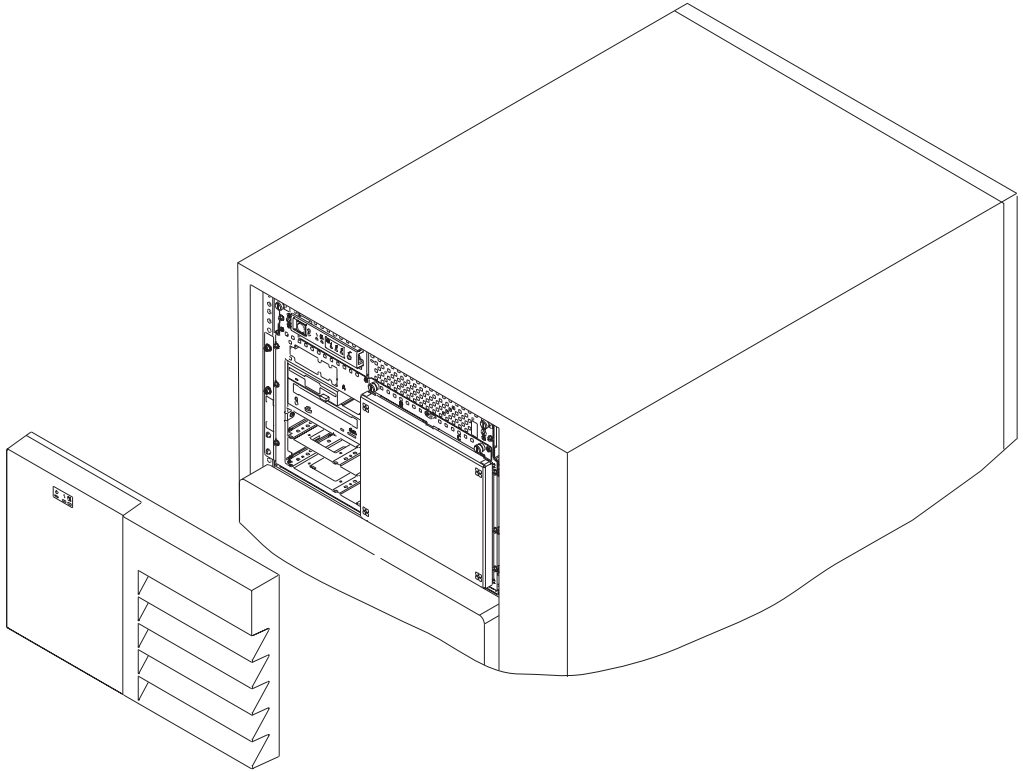

Ergonomic Information

Once you have setup your system, we encourage you to visit the Healthy Computing web site. Good ergonomic practice is important to get the most from your workstation and to avoid discomfort. This means that the equipment and the workplace should be arranged to suit your individual needs and the kind of work you do.

This web site gives ergonomic guidelines to help you understand the ergonomic considerations that you should know about in working at a computer workstation. The address is:

<http://www.us.pc.ibm.com/healthycomputing>

Using the Service Processor and Service Director Features

The Service Processor and Service Director features protect users against unnecessary system downtime by keeping support personnel (both internal and external) aware of any unexpected changes in the system environment. In combination, the two features provide a flexible solution to automated system maintenance.

Service Processor

The Service Processor runs on its own power boundary and continually monitors hardware attributes, the AIX Operating System, and the environmental conditions within the system at all times. Any system failure which prevents the system from coming back to an operational state (a fully functional AIX Operating System) is reported by the Service Processor. The Service Processor is controlled by firmware and does not require the AIX Operating System to be operational to perform its tasks. If any system failures are detected, the Service Processor has the ability to take pre-determined corrective actions. The methods of corrective actions are:

- Surveillance
- Call Home
- AIX Operating System Monitoring

Surveillance is a function in which the Service Processor monitors the system through heartbeat communication with the system firmware. During system startup, the firmware surveillance monitor is automatically enabled to check for heartbeats from the firmware. If a heartbeat is not detected within a default period, the Service Processor cycles the system power and attempts to restart until the system either restarts successfully, or a pre-determined retry threshold is reached. In the event the Service Processor is unsuccessful in bringing the system on-line (or in the event that the user asked to be alerted to any Service Processor assisted restarts), the system can call home to report the error.

The Call Home function can be initialized to call either a service center telephone number, a customer administration center, or a digital pager telephone number. The Service Processor can be configured to stop at the first successful call to any of the numbers listed, or can be configured to call every number provided. If connected to the service center, the Service Processor transmits the relevant system information (the system's serial number and model type) and Service Request Number (SRN). If connected to a digital pager service, the Service Processor inputs a Customer Voice Telephone Number defined by the customer. An established sequence of digits or the telephone number to a phone near the failed system could be used to signal a system administrator to a potential system failure.

During normal operations, the Service Processor can also be configured to monitor the AIX Operating System. If AIX does not respond to the Service Processor heartbeat, the Service Processor assumes the Operating System is hung. The Service Processor can automatically initiate a restart and, if enabled, initiate the call home function to alert the appropriate people to the system hang. Enabling Operating System Surveillance also affords AIX the means to detect any Service Processor failures and report those failures to the Service Director application.

Unlike the Service Director, the Service Processor cannot be configured in a client/server environment where one system can be used to manage all dial-out functionally for a set of systems.

Prior to installing the Service Processor feature, you need to ensure that you have latest levels of Service Processor microcode and system firmware. You also need a properly configured modem. For more information on configuring a modem, see "Modem Configuration Menu" on page 3-18.

Service Director

The Service Director is a software extension to the AIX Operating System that monitors the system while the AIX Operating System is running. The Service Director monitors and analyzes all recoverable system failures, and, if needed, can automatically place a service call to a service center (without user intervention).

The service center receives the machine type/serial number, host name, SRN, and a problem description. The service center analyzes the problem report and, if warranted, dispatches a service person to the customer site. The service center also determines if any hardware components need to be ordered prior to the service person's arrival.

The Service Director code also gives the user the option to establish a single system as the problem reporting server. A single system, accessible over the user network, can be used as the central server for all the other systems on the Local Area Network (LAN) who are running the Service Director application. If the Service Director application on a remote client decides a service request needs to be placed, the client forwards the information to the Service Director server who dials the service center telephone number from its locally attached modem. In this scenario, the user only needs to maintain a single analog line for providing call-out capabilities for a large set of servers.

When utilized in a Scalable Parallel (SP) environment, a client/server type implementation is configured. The Service Director client code runs on each of the SP nodes. The server component runs on the Control Workstation. In the event of any system failures, the relevant information is transmitted to the Control Workstation through the

integrated Ethernet. Once alerted to the system failure, the Control Workstation initiates actions to prepare and send the service request.

A modem is required for enabling automated problem reporting to the IBM service center. Configuration files for several types of modems are included as part of the Service Director package. Refer to “Modem Configuration Menu” on page 3-18 for more information on configuring your modem.

Chapter 3. Service Processor Menus

The Service Processor menus make it possible for you to configure SP options, as well as enable and disable functions.

Service Processor menus are available using an ASCII terminal while the system is powering on or when the Service Processor has detected a server problem (such as a surveillance failure).

For a summary of the Service Processor functions and the methods used to invoke them, see Table 3-1 on page 3-2.

Table 3-1. SP Functions

| Service Processor Functions | Service Processor Menus (ASCII terminals) | Service Processor Service Aids (ASCII or graphics terminals) | SMS (ASCII or graphics terminals) |
|--|--|---|--|
| Read VPD image from last system boot | Y ³ | | |
| Read System POST Errors | Y ³ | | |
| Read Service Processor Error Logs | Y ³ | | |
| View Progress Indicators from last Boot | Y ³ | | |
| Power-off System | Y ² | | |
| Read NVRAM | Y ² | | |
| Start Talk Mode | Y ² | | |
| Enable/Disable Console Mirroring | Y ² | | |
| Setup Reboot/Restart Policy | Y ² | Y ¹ | |
| Enable/Disable Modem | Y ² | Y ¹ | |
| Setup Modem Configuration | Y ² | Y ¹ | |
| Setup Dial-out Phone Numbers | Y ² | Y ¹ | |
| Setup Surveillance | Y ² | Y ¹ | |
| Select Modem Line Speed | Y ² | Y ¹ | |
| Update Service Processor Flash EPROM | | Y ¹ | |
| Save/Restore Hardware Maintenance Policies | | Y ¹ | |
| Change General Access Password | Y ² | | |
| Change Privileged Access Password | Y ² | | Y ² |
| Select Language | Y ² | | Y ² |
| Enable/Disable Unattended Start Mode | Y ² | Y ¹ | Y ² |

Passwords required (if set):

- ¹ Operating system root password
- ² Privileged access password
- ³ General access (power-on) password

SP Menus

The Service Processor (SP) menus are divided into two groups:

- General user menus - the user must know the general access password.
- Privileged user menus - the user must know the privileged access password.

The following section describes these two groups of menus, how to access them, and the functions associated with each option.

If the server is powered on, the SP menus may be accessed locally or remotely as described below.

How to access SP menus locally

SP menus may be accessed locally by connecting an ASCII terminal to either serial port 1 or 2. Because the presence of the ASCII terminal cannot be confirmed by the SP, you must press a key (any key) on the ASCII terminal to confirm its presence. The key on the ASCII terminal must be pressed during the time when the operator panel display shows the code E07A.

You can recognize when the SP menu access time begins in the following ways:

- The checkpoint prior to the access checkpoint is E043.
- The system beeps three times as it enters checkpoint E07A.

When you gain access, the SP prompts you for a password (if set), and when verified, displays the SP menus.

The SP menu prompt, represented by 1> or 2> indicates the serial port to which the terminal is connected. A 1> indicates serial port 1, and 2> indicates serial port 2.

How to access SP menus remotely

If your system has a modem connected and configured for call-in (see "Modem Configuration Menu" on page 3-18), SP menus can be accessed remotely as follows:

1. With the system powered off, call in from a remote terminal. Wait for at least two rings and hang up. The system powers on upon detecting ring-indicate, and pauses for a return call if call-in is enabled.
2. Wait five minutes and call-in again. The SP prompts you for a password (if set). When verified, the SP menus display remotely.

Saving and Restoring Service Processor Settings

All the settings you make (except language) from the service processor menus can be backed up either for recovering from a fault that may corrupt these settings, or for replicating these settings to other servers that include a service processor.

The service aid, Save or Restore Hardware Management Policies, can be used to save your settings after initial setup or whenever the settings must be changed for system operation purposes.

It is strongly recommended that this service aid is used for backing up service processor settings to protect the usefulness of the service processor, and the availability of the server. Refer to "Save or Restore Hardware Management Policies" on page 6-28 for information about this service aid.

How to return to SP menus

When exiting SP menus using option "99", there is a 10 second delay before the system continues its boot procedure. During that 10 seconds, you may strike a key on the ASCII terminal to return to the menus and select other options.

During the 10 second delay, an information message appears on the display. After the 10 second delay, SP menus are no longer available until either the next system boot or the SP regains control due to a system failure.

Menu Inactivity

To prevent loss of control due to power loss or power surges, SP attempts to leave menu mode after 10 minutes of inactivity by simulating the option 99 selection. This attempt is successful on menus containing the "99" option. On the other menus, the attempt is unsuccessful and the following message displays with each attempt:

```
Illegal value entered  
Press Return to continue
```

If for some reason you want to hold the server in menu mode, select one of the menus that do not have the "99" option. Boot activity cannot continue if SP is in menu mode, and power losses or surges could result in unpredictable server responses.

General User Menus

The menu options presented to the General user are a subset of the options available to the Privileged user. The user must know the General Access Password, if set, in order to access these menus.

```
GENERAL USER MENU

1. Continue System Boot
2. Read VPD Image from Last System Boot
3. Read Progress Indicators from Last System Boot
4. Read Service Processor Error Logs
5. Read System POST Errors
99. Exit from Menus

1>
```

- **Continue System Boot**

Allows the user to continue with and monitor the system boot already in progress using the current ASCII terminal as the active console.

Make this selection if you wish to monitor the IPL progress messages on your terminal. If you do not wish to monitor the IPL progress messages, select option **99. Exit from Menus**.

- **Read VPD Image from Last System Boot**

Displays manufacturer vital product data, such as serial numbers, part numbers, etc., that were stored from the system boot prior to the one in progress now.

- **Read Progress Indicators from Last System Boot**

Displays the boot progress indicators (check points), up to a maximum of 100, from the system boot prior to the one in progress now. This historical information may be useful to help diagnose system faults.

The progress indicators are displayed in two sections. Above the dashed line are the progress indicators (latest) from the boot that produced the current sessions. Below the dashed line are progress indicators (oldest) from the boot preceding the one that produced the current sessions.

The progress indication codes are listed top (latest) to bottom (oldest). The dashed line merely represents the point where the latest boot started. For an example, refer to “LCD Progress Indicator Log” on page 3-39.

- **Read Service Processor Error Logs**

Displays the SP error logs. For an example, refer to “Service Processor Error Logs” on page 3-38.

- **Read System POST Errors**

Displays the results of the System Firmware POST (Power-On Self Test). Your server may be able to start in the presence of POST errors if there is sufficient working system resources. If POST errors occur during start-up, this error log when used with the diagnostics helps to isolate faults. For an example, refer to “Service Processor Error Logs” on page 3-38.

- **Exit from Menus**

Allows the user to continue with the system boot already in progress using the current ASCII terminal as the active console. Make this selection if you **do not** wish to monitor the IPL progress messages on your terminal. Exiting from the menus causes the modems to disconnect, but the boot process continues.

Privileged User Menus

The following menus are available to privileged users only. The user must know the Privileged Access Password, if set, to access these menus.

Main Menu

At the top of the MAIN Menu is a listing containing:

- Your Service Processor's current firmware version
- The firmware copyright notice
- The System Name given to your server during setup

You need the firmware version for reference when you either update or repair the functions of your service processor.

The System Name, an optional field, is the name your server reports in problem messages. This name helps your support team, (for example, your system administrator, network administrator, or service representative) to more quickly identify the location, configuration, and history of your server. The System Name is set from the Main Menu using option 6.

Note: The information under the Service Processor Firmware heading in the Main Menu illustration that follows is example information only.

```
Service Processor Firmware
VERSION: 19970814
Copyright 1997, IBM Corporation
SYSTEM NAME
```

MAIN MENU

1. Service Processor Setup Menu
2. System Power Control Menu
3. System Information Menu
4. Language Selection Menu
5. Call-In/Call-Out Setup Menu
6. Set System Name
99. Exit from Menus

1>

Service Processor Setup Menu

SERVICE PROCESSOR SETUP MENU

1. Change Privileged Access Password
 2. Change General Access Password
 3. Enable/Disable Console Mirroring:
 Currently Enabled
 4. Start Talk Mode
 5. OS Surveillance Setup Menu
 98. Return to Previous Menu
 99. Exit from Menus
- 1>

Note: Unless otherwise stated in menu responses, settings become effective when a menu is exited using option 98 or 99.

Passwords

Passwords can be any combination of up to 8 alphanumeric characters. You can enter longer passwords, but the entries are truncated to include only the first 8 characters. Privileged Access Password can be set from Service Processor menus or from System Management Services (SMS) utilities (see Chapter 4 on page 4-1). General Access Password can be set only from Service Processor menus.

For security purposes, Service Processor counts the number of attempts to enter correct passwords. The results of not recognizing a correct password within this error threshold are different, depending on whether the attempts are being made locally (at the server) or remotely (via a modem). The error threshold is 3.

If the error threshold is reached by someone entering passwords at the server, Service Processor commands IPL to resume. This action is taken based on the assumption that the server is in an adequately secure location with only authorized users having access. Such users must still successfully enter a login password to access AIX.

If the error threshold is reached by someone entering passwords remotely, Service Processor commands the server to power down to prevent potential security attacks on the server by unauthorized remote users. The following illustrates what you can access with the Privileged Access Password and the General Access Password.

| Privileged Access Password | General Access Password | Resulting Menu |
|----------------------------|-------------------------|---|
| None | None | SP MAIN MENU displayed |
| None | Set | Users with the password see the GENERAL USER MENU. Users without the password see SP MAIN MENU. |
| Set | None | Users with the password see the SP MAIN MENU. Users without password see the GENERAL USER MENU. |
| Set | Set | Users see menus associated with the entered password |

- **Change Privileged Access Password**

Set or change the Privileged Access Password. It provides the user with the capability to access all SP functions. This password is usually used by the system administrator or **root** user.

- **Change General Access Password**

Set or change the General Access Password. It provides limited access to SP menus, and is usually available to all users who are allowed to power-on the server, especially remotely.

Note: The General Access Password can only be set or changed while the Privileged Access Password is set.

- **Enable/Disable Console Mirroring**

When Console Mirroring is enabled, the SP sends information to both serial ports. This capability may be enabled by local or remote users. This provides local users the capability to monitor remote sessions. Console mirroring may be enabled for the current session only. For more information, see “Console Mirroring” on page 3-37.

- **Start Talk Mode**

In a console mirroring session, it is useful for those that are monitoring the session to be able to communicate with each other. Selecting this menu item activates the keyboards and displays for such communications while console mirroring is established. This is a full duplex link, so message interference is possible. Alternating messages between users works best.

- **OS Surveillance Setup Menu**

This option may be used to setup operating system (OS) surveillance.

```
OS Surveillance Setup Menu
1. Surveillance:
  Currently Enabled
2. Surveillance Time Interval:
  2 minutes
3. Surveillance Delay:
  2 minutes

98. Return to Previous Menu

1>
```

- **Surveillance**

May be set to Enabled or Disabled.

- **Surveillance Time Interval:**

May be set to any number from 2 through 255.

- **Surveillance Delay:**

May be set to any number from 0 through 255.

Refer to “Service Processor System Monitoring - Surveillance” on page 3-34 for more information about surveillance.

System Power Control Menu

```
SYSTEM POWER CONTROL MENU

1. Enable/Disable Unattended Start Mode:
   Currently Enabled

2. Reboot/Restart Policy Setup Menu

3. Continue System Boot

4. Power-Off System

98. Return to Previous Menu

99. Exit from Menus

1>
```

- **Enable/Disable Unattended Start Mode**

This option may be used to instruct SP to restore the power-state of the server after a temporary power failure. Unattended Start Mode can also be set via SMS Menus. It is intended to be used on servers that require automatic power-on after a power failure. For more information, see “System Power-On Methods” on page 3-29.

- **Reboot/Restart Policy Setup Menu**

See “Reboot/Restart Policy Setup Menu” on page 3-25.

- **Continue System Boot**

Allows the user to continue with and monitor the system boot already in progress using the current ASCII terminal as the active console.

Make this selection if you wish to monitor the IPL progress messages on your terminal. If you do not wish to monitor the IPL progress messages, select option **99. Exit from Menus**.

- **Power-off System**

Allows the user to power-off the server.

System Information Menu

SYSTEM INFORMATION MENU

1. Read VPD Image from Last System Boot
 2. Read Progress Indicators from Last System Boot
 3. Read Service Processor Error Logs
 4. Read System POST Errors
 5. Read NVRAM
 6. Read Service Processor Configuration
 7. Processor Configuration/Deconfiguration Menu
 98. Return to Previous Menu
 99. Exit from Menus
- 1>

- **Read VPD Image from Last System Boot**

Displays manufacturer's vital product data (VPD), such as serial numbers, part numbers, etc., that was stored from the system boot prior to the one in progress now.

- **Read Progress Indicators from Last System Boot**

Displays the boot progress indicators (check points), up to a maximum of 100, from the system boot prior to the one in progress now. This historical information may be useful to help diagnose system faults.

The progress indicators are displayed in two sections. Above the dashed line are the progress indicators (latest) from the boot that produced the current sessions. Below the dashed line are progress indicators (oldest) from the boot preceding the one that produced the current sessions.

The progress indication codes are listed top (latest) to bottom (oldest). The dashed line merely represents the point where the latest boot started. For an example, refer to “LCD Progress Indicator Log” on page 3-39.

- **Read Service Processor Error Logs**

Displays error conditions detected by the SP. Refer to “Service Processor Error Logs” on page 3-38 for an example of this error log.

- **Read System POST Errors**

Selecting this item lets you review the results of the POST (Power-On Self Test). Your server may be able to start in the presence of POST errors if there are sufficient working system resources. If POST errors occur during start-up, this error log when used with the diagnostics helps to isolate faults. Refer to “System POST Errors” on page 3-38 for an example of this error log.

- **Read NVRAM**

Displays Non-Volatile Random Access Memory (NVRAM) content.

- **Read Service Processor Configuration**

Displays current service processor configuration.

- **Processor Configuration/Deconfiguration Menu**

This menu allows the user to change the system processor configuration. If it is necessary to take one of the processors offline, this menu allows you to deconfigure a processor, and then reconfigure the processor at a later time. An example of this menu is shown below:

```
PROCESSOR CONFIGURATION/DECONFIGURATION MENU

To change the configuration, select the processor number:

0. Configured (0x00) 1. Configured (0xFF) 2. Deconfigured (0x81)
3. Deconfigured (0x21) 4. Deconfigured (0x41) 5.
6.
7.

80. Commit the configuration changes
98. Return to Previous Menu

1>
```

To change the processor configuration, select the processor number first. It will change the processor state from Configured to Deconfigured or from Deconfigured to Configured.

In the above screen, the four character codes shown are defined as:

- 0x00** Processor configured by system
- 0xFF** Processor configured by system
- 0x81** Processor has been deconfigured manually
- 0x41** Processor has been deconfigured by system due to exceeded of recoverable runtime errors
- 0x21** Processor has been deconfigured due to repeated fatal internal errors.

Once the configuration has been changed, commit the configuration changes by selecting option 80. The system will reboot after option 80 has been selected.

Language Selection Menu

LANGUAGE SELECTION MENU

- 1. English
 - 2. Francais
 - 3. Deutsch
 - 4. Italiano
 - 5. Espanol
 - 6. Svenska
 - 98. Return to Previous Menu
 - 99. Exit from Menus
- 1>

Note: Your ASCII terminal must support the ISO-8859 character set in order to properly display languages other than English.

This menu allows selecting languages in which SP and system firmware menus and messages are displayed.

Call-In/Call-Out Setup Menu

CALL-IN/CALL-OUT SETUP MENU

1. Modem Configuration Menu
 2. Serial Port Selection Menu
 3. Serial Port Speed Setup Menu
 4. Telephone Number Setup Menu
 5. Call-Out Policy Setup Menu
 6. Customer Account Setup Menu
 7. Call-Out Test
 98. Return to Previous Menu
 99. Exit from Menus
- 1>

- **Modem Configuration Menu**, see “Modem Configuration Menu” on page 3-18.
- **Serial Port Selection Menu**, see “Serial Port Selection Menu” on page 3-19.
- **Serial Port Speed Setup Menu**, see “Serial Port Speed Setup Menu” on page 3-20.
- **Telephone Number Setup Menu**, see “Telephone Number Setup Menu” on page 3-21.
- **Call-Out Policy Setup Menu**, see “Call-Out Policy Setup Menu” on page 3-23.
- **Customer Account Setup Menu**, see “Customer Account Setup Menu” on page 3-24.

Modem Configuration Menu

The first two lines of the Modem Configuration Menu are status lines showing the current selections. Selections are made in the two sections labeled Modem Ports and Modem Configuration File Name. Select the serial port that you want to activate and then select the modem configuration file for the modem on the port. If you want to set up both serial ports with modems, make your selections one port at a time.

```
Modem Configuration Menu

Port 1 Modem Configuration File Name:
Port 2 Modem Configuration File Name: modem_m0_sp

To make changes, First select the port and then the configuration file name

Modem Ports:
 1. Serial port 1
 2. Serial port 2

Modem Configuration File Name:
 3. none
 4. modem_f_sp           9. modem_m0_sp
 5. modem_f0_sp          10. modem_m1_sp
 6. modem_f1_sp
 7. modem_z_sp
 8. modem_z0_sp

30. Save configuration to NVRAM and Configure modem
98. Return to Previous Menu

1>
```

For information on choosing a modem configuration file, see “Sample Modem Configuration Files” on page F-1, and “Seamless Transfer of a Modem Session” on page F-7.

Serial Port Selection Menu

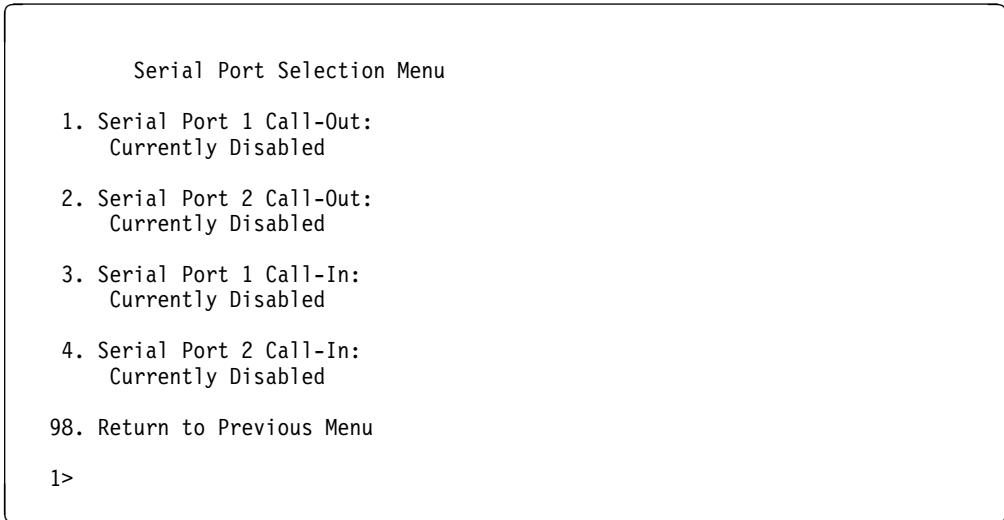

You may enable and/or disable the call-in and call-out functions of each serial port in any combination.

Note: For security, if the service processor detects an operator panel battery failure, the Serial Port Dial-In capability becomes disabled. See “Service Processor Call-In Security” on page 3-30 for more information.

Serial Port Speed Setup Menu

Serial Port Speed Setup Menu

1. Serial Port 1 Speed:
Currently 9600
 2. Serial Port 2 Speed:
Currently 9600
 98. Return to Previous Menu
- 1>

Serial port speed can be set for terminal performance or to accommodate modem capabilities. A speed of 9600 baud or higher is recommended. Valid serial port speeds are shown below:

| | | |
|-----|------|--------|
| 50 | 600 | 4800 |
| 75 | 1200 | 7200 |
| 110 | 1800 | 9600 |
| 134 | 2000 | 19200 |
| 150 | 2400 | 38000 |
| 300 | 3600 | 57600 |
| | | 115200 |

Telephone Number Setup Menu

This menu may be used to set or change the telephone numbers for reporting a system failure. SP allows setting or changing telephone numbers for:

- **Service Center Telephone Number** - The telephone number of the maintenance provider's computer.
- **Customer Administration Center Telephone Number** - The telephone number of the local system support provider's computer.
- **Digital Pager Telephone Number** - The telephone number of the digital pager used by the person responsible for problem calls.
- **Customer Voice Telephone Number** - The telephone number service personnel use to reach the system user.
- **Customer System Telephone Number** - The telephone number to which the server's modem is connected.

Telephone Number Setup Menu

1. Service Center Telephone Number:
Currently Unassigned
 2. Customer Administration Center Telephone Number:
Currently Unassigned
 3. Digital Pager Telephone Number:
Currently Unassigned
 4. Customer Voice Telephone Number:
Currently Unassigned
 5. Customer System Telephone Number:
Currently Unassigned
 98. Return to Previous Menu
- 1>

- **Service Center Telephone Number** is the number of the service center computer. The service center usually includes a computer that takes calls from servers with call-out capability. This computer is referred to as "the catcher." The catcher expects messages in a specific format to which SP conforms. For more information about the format and catcher computers, refer to the README file in the AIX `/usr/samples/syscatch` directory. Contact your service provider for the correct telephone number to enter here. Until you have that number, leave this field unassigned.
- **Customer Administration Center Telephone Number** is the number of the System Administration Center computer (catcher) that receives problem calls from servers. Contact your system administrator for the correct telephone number to enter here. Until you have that number, leave this field unassigned.
- **Digital Pager Telephone Number** is the number for a numeric pager carried by someone who responds to problem calls from your server. Contact your administration center representative for the correct telephone number to enter here. For test purposes, enter your telephone number here. You can change it later when testing is complete. See note on page 3-36.
- **Customer Voice Telephone Number** is the telephone number of a phone near the server or answered by someone responsible for the server. This is the telephone number left on the pager for callback. For test purposes, enter your telephone number here. You can change it after testing is completed.
- **Customer System Telephone Number** is the telephone number to which your server's modem is connected. The service or administration center representatives need this number to make direct contact with your server for problem investigation. This is also referred to as the **call-in** phone number.

Call-Out Policy Setup Menu

```
CALL-OUT POLICY SETUP MENU

1. Call-Out policy (First/All):
   Currently First

2. Remote timeout, (in seconds):
   Currently 120

3. Remote latency, (in seconds):
   Currently 2

4. Number of retries:
   Currently 2

98. Return to Previous Menu

1>
```

- **Call-Out policy** may be set to 'first' or 'all'. If call-out policy is set to 'first', the SP stops at the **first successful** call-out to one of the following numbers in the order listed:

1. Service Center
2. Customer Admin Center
3. Pager

If call-out policy is set to 'all', the SP attempts a call-out to **all** the following numbers in the order listed:

1. Service Center
2. Customer Admin Center
3. Pager

Remote timeout and **Remote latency** are functions of your service provider's catcher computer. You should take the defaults or contact your service provider for recommended settings.

Number of retries is the number of times you want the server to retry calls that failed to complete.

Customer Account Setup Menu

Customer Account Setup Menu

1. Customer Account Number:
Currently Unassigned
 2. Customer RETAIN Login userid:
Currently Unassigned
 3. Customer RETAIN login password:
Currently Unassigned
 98. Return to Previous Menu
- 1>

- **Customer Account Number** is assigned by your service provider for record keeping and billing. If you have an account number, enter it here. Otherwise, leave this field unassigned.
- **Customer RETAIN Login UserID** and **Customer RETAIN Login Password** apply to a service function to which your service provider may or may not have access. Leave these fields unassigned if your service provider does not use RETAIN.

Reboot/Restart Policy Setup Menu

```
Reboot/Restart Policy Setup Menu

1. Number of reboot attempts:
   Currently 1

2. Use OS-Defined restart policy?
   Currently Yes

3. Enable supplemental restart policy?
   Currently No

4. Call-Out before restart:
   Currently Disabled

98. Return to Previous Menu

1>
```

Reboot is the process of bringing up the system hardware. For example, from a system reset or power on. **Restart** is activating the operating system after the system hardware is re-initialized. Restart must follow a successful reboot.

- **Number of reboot attempts** - If the server fails to successfully complete the boot process, it attempts to reboot the number of times specified. Entry values equal to or greater than 0 are valid. Only successive failed reboot/restart attempts count.
- **Use OS-Defined restart policy** - Allows the SP react or not react the same way as the operating system to major system faults by reading the setting of the operating system parameter **Automatically Restart/Reboot After a System Crash**. This parameter may or may not be defined depending on the operating system or its version/level. If the operating system automatic restart setting is defined, then it may be set to respond to a major fault by restarting or by not restarting. See your operating system documentation for details on setting up operating systems automatic restarts. The default value is YES.

- **Enable supplemental restart policy** - The default setting is NO. If set to YES, the SP restarts the system when the system loses control as detected by SP surveillance, and either:

1. The **Use OS-Defined restart policy** is set to NO

OR

2. The **Use OS-Defined restart policy** is set to YES and the operating system has NO automatic restart policy.

Refer to “Service Processor Reboot/Restart Recovery” on page 3-31.

- **Call-Out before restart (Enabled/Disabled)** If a restart is necessary due to a system fault, you can enable the SP to call out and report the event. This item is valuable if the number of these events becomes excessive, signalling a bigger problem.

Service Processor Procedures in Service Mode

When the system is in service mode, the following service processor parameters are suspended.

- Unattended Start Mode
- Reboot/Restart Policy
- Call-Out
- Surveillance

When service mode is exited, the service processor parameters revert back to the customer settings.

Service Processor Functions

The following section discusses some of the Service Processor features in greater detail.

The S70 Service Processor supports the following functions:

| | | |
|---------------------|-----------------------------------|--|
| Built-in Functions | Initialization and Test | SP Basic Instructions Test (BIST) |
| | | System Chip Initialization |
| | Error Data Collection | BIST/POST errors and status |
| | | Isolation to Field Replaceable Unit (FRU) on fail. |
| | Configuration | CPU Complex validation |
| | | VPD Collection |
| | System Management | Reset and Reboot on System Firmware fails |
| | | Reboot on system failure |
| Local User Function | User Interface | Local async console |
| | | Text based menus with NLS |
| | | Operator Panel messages |
| | Power and Miscellaneous | Power On/Off |
| | | Configurable Reboot Policy |
| | Status and Data Access | VPD |
| | | Error data (SP) |
| | | Error data (system) |
| | Service Processor Setup Utilities | Passwords |
| | | Phone numbers |
| | | Language (NLS) selection |
| | | Call-In/Call-Out enable/disable |
| | | System Name |
| | Modem Configuration | |

| | | |
|-----------------------|--------------------------------|----------------------------|
| Remote User Functions | Call-Out (Call Home) Reporting | OS termination |
| | | Boot failure |
| | | Surveillance failure |
| | | Checkstop |
| | | Machine check |
| | | Identify system by name |
| | Call-In | Power-on via ring-indicate |
| | | Password/security check |
| | | Console mirroring |

System Power-On Methods

- Power-on Switch - see "Powering On the System" on page 2-2.
- Remote Power-on via Ring-Indicate Signal

The server automatically powers on when it detects a "ring indicate" signal from a modem attached to one of the integrated serial ports.

A remote user can call the server to activate ring detection by the modem.

Listen for a few more rings than the threshold number for starting the system and then hang up. The default threshold is one ring.

Wait 5 minutes for the server to initialize and then call again using an ASCII terminal. The server responds by requesting a password, if set, or presenting the SP menus. The remote user now has control of the server.

Note: For security, if the system is powered on by the remote power-on via ring indicate signal and the service processor detects an operator panel battery failure, the service processor causes the system to power off. See "Service Processor Call-In Security" on page 3-30 for more information.

- Unattended start mode - refer to **Enable/Disable Unattended Start Mode** on page 3-13.

The Service Processor can be enabled to recover from the loss of AC power (see Enable/Disable Unattended Power-On Mode in the SYSTEM POWER CONTROL MENU). When AC power is restored, the system returns to the then current power state at the time AC loss occurred. For example, if the system was powered-on when AC loss occurred, it reboots/restarts when power is restored. If the system was powered-off when AC loss occurred, it remains off when power is restored.

It is recommended that the system rack and I/O rack both receive their AC power from the same building circuit on the same circuit breaker, if not the same electrical outlet box, in such a way that primary power cannot be lost to one rack separately from the other. If such a condition occurs, Unattended Start Mode may not be able to restart system operation when a primary power interruption is restored.

- Timed power-on - refer to the shutdown -t command on servers using AIX.

Working in conjunction with AIX, the Service Processor in your server can operate a timer, much like the wake-up timer on your clock radio. You can set the timer so that your server powers on at a certain time after shutting down. The timer is battery operated, so power interruptions occurring while the server is off do not affect its accuracy. Refer to the shutdown -t command of AIX for details on setting the timer.

Note: If an AC power loss is in progress when the Timed Power-On attempt occurs, the server is not be able to power on when AC power is restored.

- Follow-up to a Failed Boot Attempt

The SP initiates a power-on sequence upon detection of a failed boot attempt (due to a hardware or software failure).

- Fast/Slow Boot (IPL) Capabilities

Using the operator panel functions, you can select the IPL type, mode and speed of your boot capabilities. For more information, refer to operator panel functions 01 and 02 in “Operator Panel Function Descriptions” on page C-4.

ATTENTION: Selecting fast IPL results in several diagnostic tests being skipped.

Service Processor Call-In Security

If the service processor detects bad battery-powered storage (indicating that the battery in the Operator Panel has failed or is disconnected), it maintains server security by disabling the call-in capability to both serial ports.

When call-in is disabled, the system can still be powered on by using the ring-indicator signal, but the service processor then causes the system to power down, preventing access to any system facilities or AIX.

Once battery power is restored, the password(s) must be reset and the call-in function(s) enabled. Both of these operations can be performed from Service Processor menus. See “Service Processor Setup Menu” on page 3-9 and “Serial Port Selection Menu” on page 3-19.

Service Processor Reboot/Restart Recovery

Reboot describes bringing the system hardware back up. For example, from a system reset or power on. The boot process ends when control passes to the operating system process.

Restart describes activating the operating system after the system hardware is reinitialized. Restart must follow a successful reboot.

Boot (IPL) Speed

When the server enters reboot recovery, slow IPL is automatically invoked. This is to give the POST an opportunity to locate and report any problems that may otherwise be untested. For more information on IPL speed, refer to “Values for IPL Types and Speeds” on page C-4.

Failure During Boot Process

During the boot process, either initially after system power-on or upon reboot after a system failure, the Service Processor monitors the boot progress. If progress stops, the Service Processor can reinitiate the boot process (reboot) if enabled to do so. Service Processor can re-attempt this process according to the number of retries selected in the Reboot/Restart Policy Setup Menu.

Failure During Normal System Operation

When the boot process completes and control transfers to the operating system (OS), the Service Processor can monitor operating system activity (see the SERVICE PROCESSOR SETUP MENU item Set Surveillance Parameters). If OS activity stops due to a hardware or software induced failure, the Service Processor can initiate a reboot/restart process based on the settings in the Service Processor Reboot/Restart Policy Setup Menu and the OS automatic restart settings (see OS documentation).

If the operating system is AIX, the menu item under SMIT for setting the restart policy is Automatically Reboot After Crash (True/False), and the default is False. When the setting is True, and if the Service Processor parameter "Use OS-Defined Restart Policy" is Yes (the default), SP takes over for AIX to reboot/restart after a hardware or Surveillance failure.

Service Processor Reboot/Restart Policy Controls

The operating system's automatic restart policy (see operating system documentation) indicates the OS response to a system crash. The Service Processor can be instructed to refer to that policy, or not, by the Use OS-Defined Restart Policy menu item.

If the operating system has no automatic restart policy, or if it is disabled, then the Service Processor restart policy can be controlled from the Service Processor Menus by using the Enable Supplemental Restart Policy selection.

Use OS-Defined restart policy - The default setting is YES. This causes the Service Processor to refer to the OS Automatic Restart Policy setting and take action; the same action the OS would take if it could have responded to the problem causing the restart.

When this setting is NO, or if the OS did not set a policy, the SP refers to Enable supplemental restart policy for its action.

Enable supplemental restart policy - The default setting is NO. If set to YES, the SP restarts the server when the OS loses control and either:

1. The **Use OS-Defined restart policy** is set to NO
- OR
2. The **Use OS-Defined restart policy** is set to YES and the operating system has NO automatic restart policy.

Refer to "Service Processor Reboot/Restart Recovery" on page 3-31.

The following provides a more thorough understanding of the relations among the OS and Service Processor restart controls:

| OS Automatic reboot/restart after crash setting | Service Processor to use OS-Defined restart policy? | Service Processor Enable supplemental restart policy? | System response |
|--|--|--|------------------------|
| None | No | No ¹ | |
| None | No | Yes | Restarts |
| None | Yes ¹ | No ¹ | |
| None | Yes ¹ | Yes | Restarts |
| False ² | No | No ¹ | |
| False ² | No | Yes | Restarts |
| False ² | Yes ¹ | No ¹ | |
| False ² | Yes ¹ | Yes | |
| True | No | No ¹ | |
| True | No | Yes | Restarts |
| True | Yes ¹ | No ¹ | Restarts |
| True | Yes ¹ | Yes | Restarts |

¹ Service Processor default

² AIX default

Service Processor System Monitoring - Surveillance

Surveillance is a function in which the Service Processor (SP) monitors the system, and the system monitors the SP. This monitoring is accomplished by periodic samplings called heartbeats.

Surveillance is available during two phases:

1. System firmware bringup (automatic) and
2. Operating system runtime (optional).

System Firmware Surveillance

Provides the SP with a means to detect boot failures while the system firmware is running.

System firmware surveillance is automatically enabled during system power-on. It cannot be disabled via a user selectable option.

If the SP detects no heartbeats during system IPL (for 7 minutes), it cycles the system power to attempt a reboot. The maximum number of retries is set from the SP menus. If the fail condition persists, the SP leaves the machine powered on, logs an error and offers menus to the user. If Call-out is enabled, the SP calls to report the failure and displays the operating system surveillance failure code on the operator panel.

Operating System Surveillance

Provides the SP with a means to detect hang conditions, hardware or software failures while the operating system is running. It also provides the operating system with a means to detect SP failure by the lack of a return heartbeat.

Operating system surveillance is not enabled by default. This is to allow the user to run operating systems that do not support this SP option.

Operating system surveillance can be enabled and disabled via:

- SP Menus
- SP Service Aids

Three parameters must be set for operating system surveillance:

1. Surveillance enable/disable
2. Surveillance interval

This is the maximum time SP should wait for a heartbeat from the operating system before timeout.

3. Surveillance delay

This is the length of time to wait from when the operating system is started to when the first heartbeat is expected.

Surveillance does not take effect until the next time the operating system is started after setting the parameters.

If operating system surveillance is enabled (and system firmware has passed control to the operating system), and SP does not detect any heartbeats from the operating system, the SP assumes the system is hung and takes action according to the reboot/restart policy settings. See “Service Processor Reboot/Restart Recovery” on page 3-31.

Call-Out (Call-Home)

The SP can call-out (Call-Home) when it detects one of the following conditions:

- System firmware surveillance failure
- Operating system surveillance failure (if supported by Operating System)
- Restarts
- Critical hardware failure
- Abnormal OS termination

To enable the call-out feature, you need to do the following:

- Have a modem connected to serial port 1 or 2.
- Set up the following using the Service Processor Menus or Diagnostic Service Aids:
 - Enable call-out for the serial port where the modem is connected.
 - Enter the modem configuration filename.
 - Set up site specific parameters (i.e. phone numbers for call-out, call-out policy, number of call-out retries, etc.).
- To Call-Out before restart, set "**call-out before restart**" to ENABLED from the Reboot/Restart Policy Setup menu.

Note: Some modems, such as IBM 7857-017, are not designed for the paging function. Although they can be used for paging, they will return an error message when they do not get the expected response from another modem. Therefore, even though the paging was successful, the error message will cause the Service Processor to retry, continuing to place pager calls for the number of retries specified in the Call-Out Policy Setup Menu. These retries result in redundant pages.

Console Mirroring

Console mirroring allows a person on a local ASCII terminal to monitor the SP activities of a remote user. Console mirroring ends when SP releases control of the serial ports to the system firmware.

System Configuration:

- Service Processor
- Modem connected to one serial port and enabled for incoming calls
- Local ASCII terminal connected to the other serial port. This local terminal may be connected directly to your server or connected through another modem.

There are two scenarios in which console mirroring can be invoked:

1. Remote session first, then local session added:
 - a. Remote session already in progress.
 - b. Remote user uses SP menus to enable console mirroring, allowing both consoles to be active.
2. Local session first, then remote session added:
 - a. Local session is already in progress.
 - b. The SP receives a call from the remote user.
 - c. The local user selects the option to enable console mirroring. SP immediately begins mirroring SP menus.

Service Processor Error Logs

The Service Processor error logs contain error conditions detected by the SP.

```

                                Error Log

19970626223337  0. Error detected..
                  4B00F010
                  B455440004B0071070000137000000000000000007420A400010000000
00000000000000

Press "C" to clear error log, any other key to continue. >
```

Note: The time stamp in this error log is Coordinated Universal Time (CUT) which is also referred to as Greenwich Mean Time (GMT). AIX error logs have more information available and can time stamp with local time.

System POST Errors

If POST (Power-On Self Test) errors occur during start-up, this error log helps isolate faults when used with the diagnostics.

```

                                Read System POST Errors

Version : 1
Severity : 2
Disposition : 0
Initiator : 0
Event being reported : 0
Extended Error Log Data:
c2 00 84 09 20 09 06 00
19 97 09 03 00 00 49 42
4d 2c 73 70 00 00 00 00
00 00 2b a0 00 13 00 01
00 00 00 00 00 00 00 00
49 42 4d 00 55 30 2e 31
2d 50 31 2d 58 31 00

                                (Press Return to Continue)
```

LCD Progress Indicator Log

The following is an example of the LCD progress indicator log.

The progress indicators (check points) are displayed in two sections. Above the dashed line are the progress indicators from the boot that produced the current sessions. Below the dashed line are progress indicators from the boot preceding the one that produced the current sessions.

The progress indication codes are chronological from bottom to top. The dashed line merely represents the point where the latest boot started.

```
                                LCD Progress Indicator Log
C33744FE
C33644FE
C33544FE
C33444FE
C33344FE
C33244FE
C33144FE
C33044FE
C1022001
C13F2090
C13F2060
C13F2050
C1012001
C1002001
C100D500
C100806E
-----
E075
E07A
E075

Press Return to continue, or 'x' to return to menu. >
```

Chapter 4. System Management Services

The System Management Services (SMS) make it possible for you to view information about your system and to perform such tasks as setting the password and changing device configurations.

If you have chosen a graphical display as your system console, you can use the graphical System Management Services described below. If you are using an ASCII display as your system console, see “Text-Based System Management Services” on page 4-20.

Graphical System Management Services

To start the Open Firmware command line or graphical System Management Services, turn on or restart the system.

Note: The graphical user interface for System Management Services is only available if a graphics adapter is installed in the system.

After the logo is displayed, initialization icons (post indicators) appear across the bottom of the screen. For more information on these icons, refer to “Post Indicators” on page 2-5.

To enter the graphical System Management Services instead of the Open Firmware command line, you must press the **F1** key *after the keyboard icon appears* during startup and before the last icon (the speaker icon) appears during startup.

You can use the mouse to select an icon. The left mouse button acts as the Enter key.

After the System Management Services starts, the following screen appears.

System Management Services



Password



Error Log



RIPL

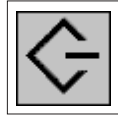

SCSI



Console

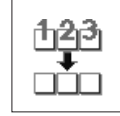

MultiBoot



Exit

You may also press F8 here to enter the OK> prompt.

The System Management Services screen contains the following choices.

The following describes the choices available on this screen.

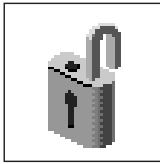

Password: Enables you to set password protection for using system administration tools. This password can be set here or in the Service Processor. Unattended Start Mode can also be set here.

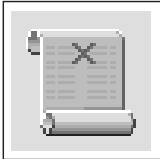

Error Log: Enables you to view and clear system firmware-detected error log information for your system.

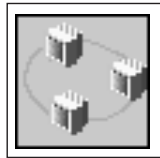

RIPL (Remote Initial Program Load): Allows you to select a remote system from which to load programs via a network adapter when your system unit is first turned on. This option also allows you to configure network adapters which require setup.

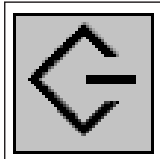

SCSI Utilities: Allow you to set SCSI hard disk spin up delay times and to set SCSI IDs for SCSI controllers installed in the S70 or S7A.

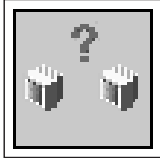

Console: If you have more than one display attached to your system unit, or if you have an ASCII terminal attached to your system unit in addition to a keyboard and display, this tool allows you to define which one is active.

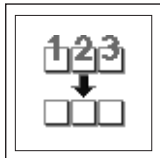

MultiBoot: Invokes the Multiboot menu which provides several functions:

- Which operating system to boot
- Default operating system
- Install from a list of devices
- Select boot sequence
- Go to Command Prompt
- Power up to Multiboot menu.

Password



When you select this icon, the following screen is displayed.

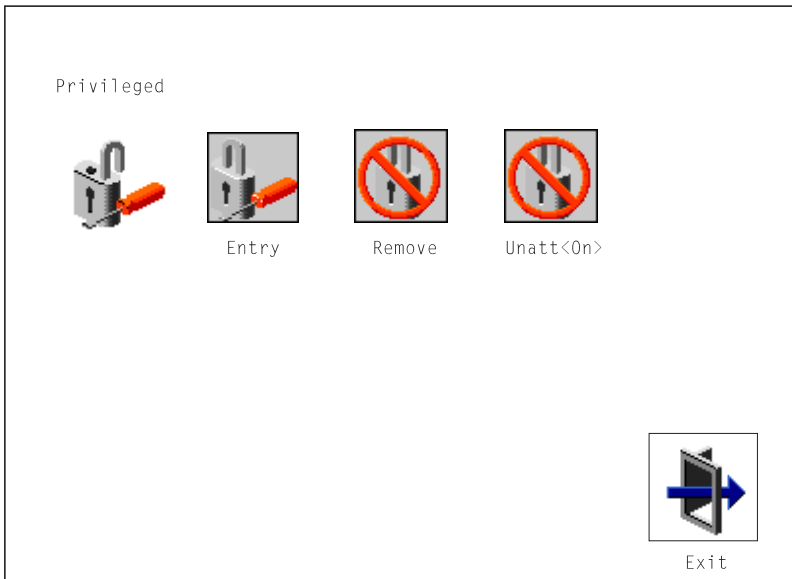

Privileged-Access Password: The privileged-access password protects against the unauthorized starting of the system programs.

Both the Service Processor and System Management Services use this password. If the password is set in System Management Services, the Service Processor automatically uses the same password. The Privileged-Access Password can also be set and removed from the Service Processor menus. See Chapter 3 on page 3-1 for more information.

Entry: When you select the **Entry** icon, a screen with 8 empty boxes appears. Type your password in these boxes. You can use any combination of up to eight characters (A–Z, a–z, and 0–9) for your password. As you type a character, a key appears in the box.

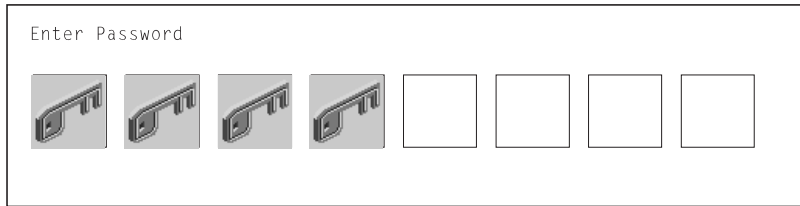

Press **Enter** when you are finished; you are required to type the password again for verification.

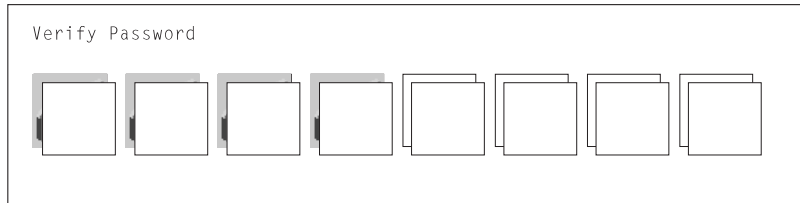

If you make a mistake, press the **Esc** key and start again.

After you have entered and verified the password, the privileged-access password icon flashes and changes to the locked position to indicate that your system now requires the password you just entered before running system programs.

Remove: If you previously had set a privileged-access password and want to remove it, select the **Remove** icon.

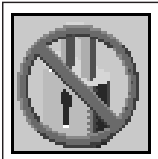

Unatt<On>: This icon is used to enable/disable Unattended Start Mode. This option is used to instruct the Service Processor to restore the power-state of the server after a temporary power failure. It is intended to be used on servers that require automatic power-on after a power failure. The default setting is ON.

Error Log

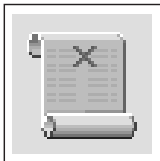

Selecting this icon displays the log of errors your system has encountered during operations.

System Error Log

1. 10/04/96 02:15:35 25a80011 00-00
2. No entry



Clear



Exit

Selecting the **Clear** icon erases the entries in this log.

Note: The time stamp in this error log is Coordinated Universal Time (CUT) which is also referred to as Greenwich Mean Time (GMT). AIX error logs have more information available and can time stamp with local time.

RIPL

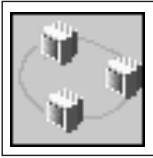

Selecting the **RIPL** (Remote Initial Program Load) icon above gives you access to the following selections.

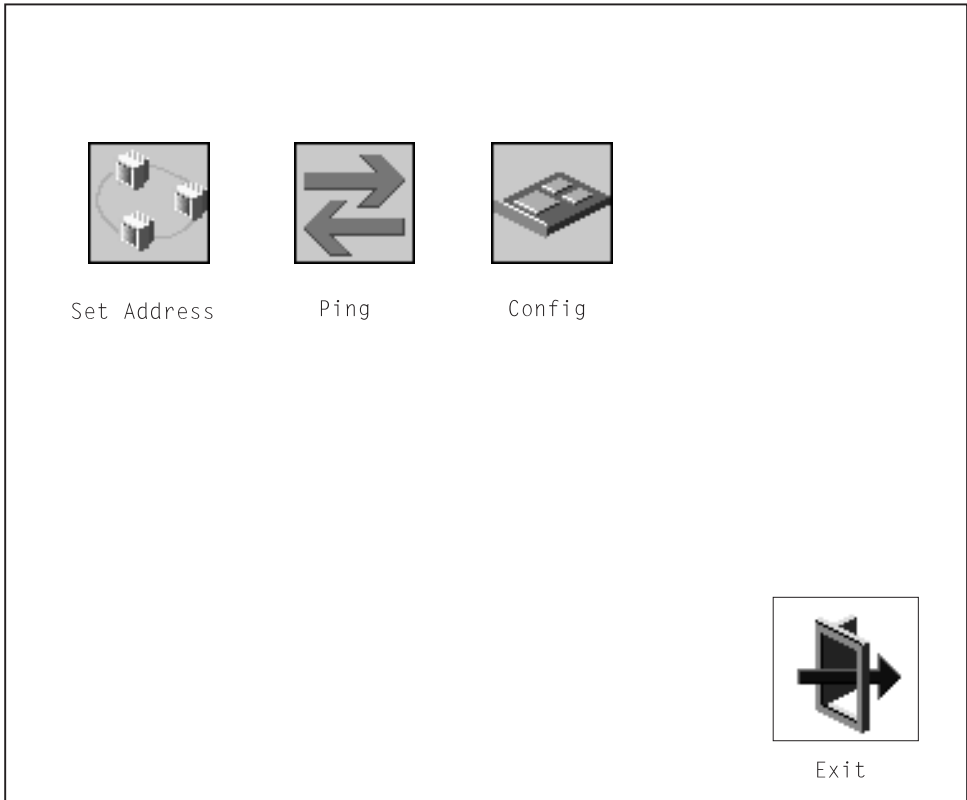

Set Address

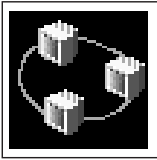

The **Set Address** icon allows you to define addresses from which your system can receive RIPL code.

Remote IPL Setup

| | |
|--------------|-----------------|
| Client Addr | 000.000.000.000 |
| Server Addr | 000.000.000.000 |
| Gateway Addr | 000.000.000.000 |
| Subnet Mask | 000.000.000.000 |



Save



Exit

Notes:

1. Some applications may require that IP addresses contain leading zeroes for numbers less than 100. For example, 129.132.4.20 may need to be entered as 123.132.004.020.

If any of the addresses are incomplete or contain a number other than 0 to 255, an error message is displayed when you select the Save icon. To clear this error, change the improper address and select Save again.

Note: You should save a copy of your changes in case of battery backup failure.

Ping

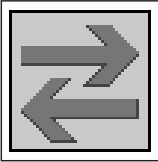

The **Ping** icon allows you to confirm that a specified address is valid by sending a test transmission to that address.

After choosing the Ping option, you may be asked to indicate which communications adapter (Token Ring or Ethernet) should be used to send the test transmission.

Ping

| | |
|--------------|-----------------|
| Client Addr | 000.000.000.000 |
| Server Addr | 000.000.000.000 |
| Gateway Addr | 000.000.000.000 |
| Subnet Mask | 000.000.000.000 |

Integrated Ethernet
Token Ring Slot=1



Ping

Exit

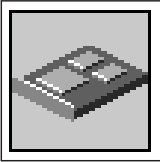
Config

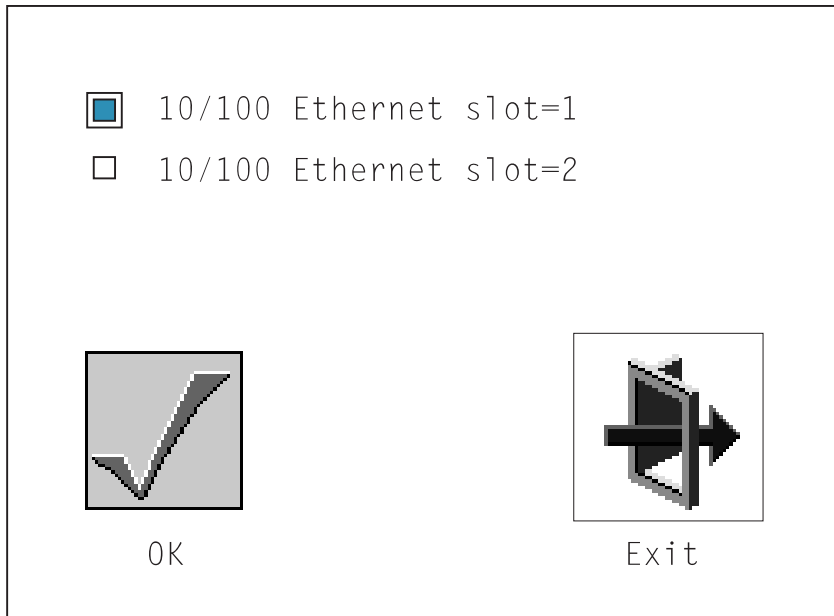

The **Config** icon allows you to configure network adapters which are recognized by the system as requiring setup. Selecting the Config icon presents a list of the adapters requiring configuration. Use the arrow keys to highlight an adapter, press the spacebar to select the adapter, then highlight the **OK** icon and press the Enter key.



The next screen allows you to select the configuration of the adapter you have just chosen (or allow the system to select the configuration automatically).

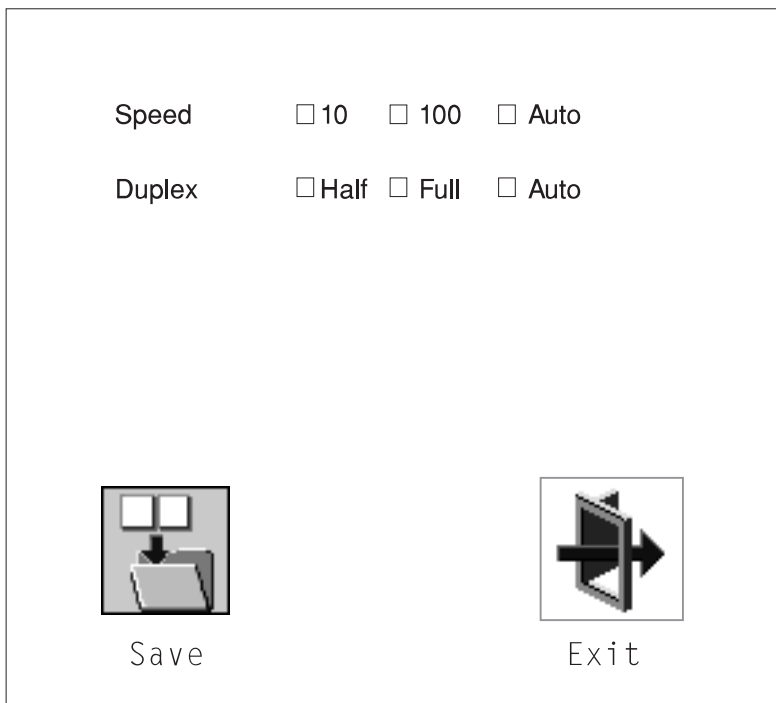

As on the previous screen, use the arrow keys to highlight, press the space bar to select, then highlight the **Save** icon and press enter. The defaults are highlighted the first time you enter this screen.

SCSI

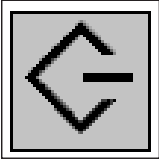

This selection is for available SCSI utilities. The first is the hard disk spin up delay used by the AIX operating system. The second selection changes the SCSI ID for SCSI controllers that are found in the S70 or S7A.

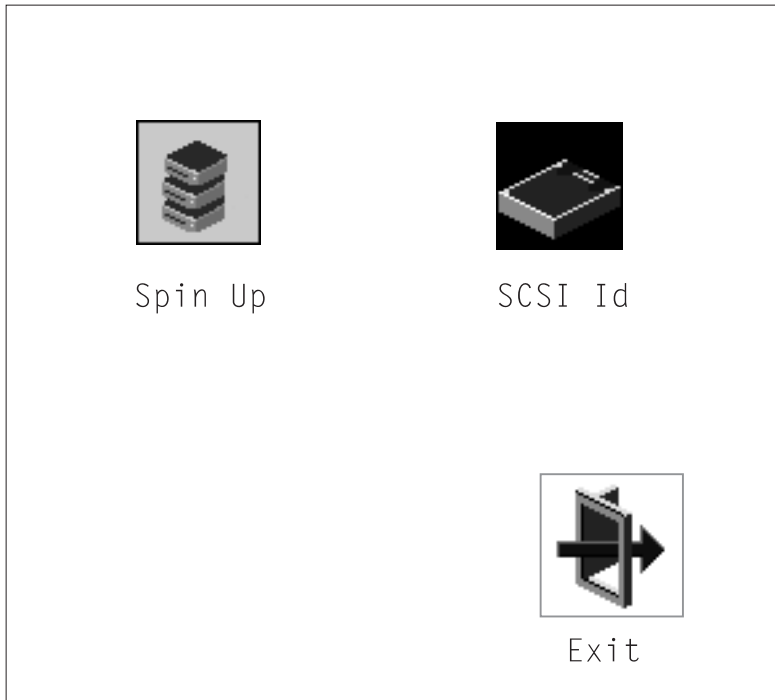

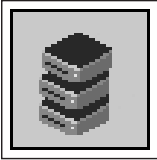

Hard Disk Spin Up Delay



This selection allows you to change the spin up delay for SCSI hard disk drives attached to your system. Spin up delay values can be entered manually or a default setting can be used. All values are measured in seconds. The default is two seconds. After you have entered the new Spin up delay values, use the arrow keys to highlight the **Save** icon and press the Enter key.

Harddisk Spin Up Delay
Current Spin Up Value - 112233
Enter New Value - ___111___ (secs)

 Save  Default  Exit

SCSI ID

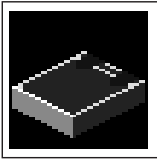



This selection allows you to view and change the addresses (IDs) of the SCSI controllers attached to your system unit. To change an ID, highlight the entry by moving the arrow keys, then use the spacebar to scroll through the available IDs for the controller. After you have entered the new address, use the arrow keys to highlight the **Save** icon and press the Enter key.

At any time in this process, you can select the **Default** icon to change the SCSI IDs to the default values of 7.

Change SCSI ID

| Type | Slot | ID | Max ID |
|-----------|------|----|--------|
| Fast | 5 | 7 | 7 |
| Fast/Wide | 7 | 7 | 15 |

| | | |
|---|---|--|
|  |  |  |
| Save | Default | Exit |

Console Select

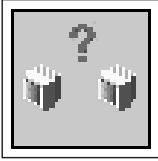

Selecting this icon makes it possible for you select between multiple TTY and graphics consoles. Only one session can exist at a time. Sessions are numbered by the serial ports and then the graphics adapters installed in the system.

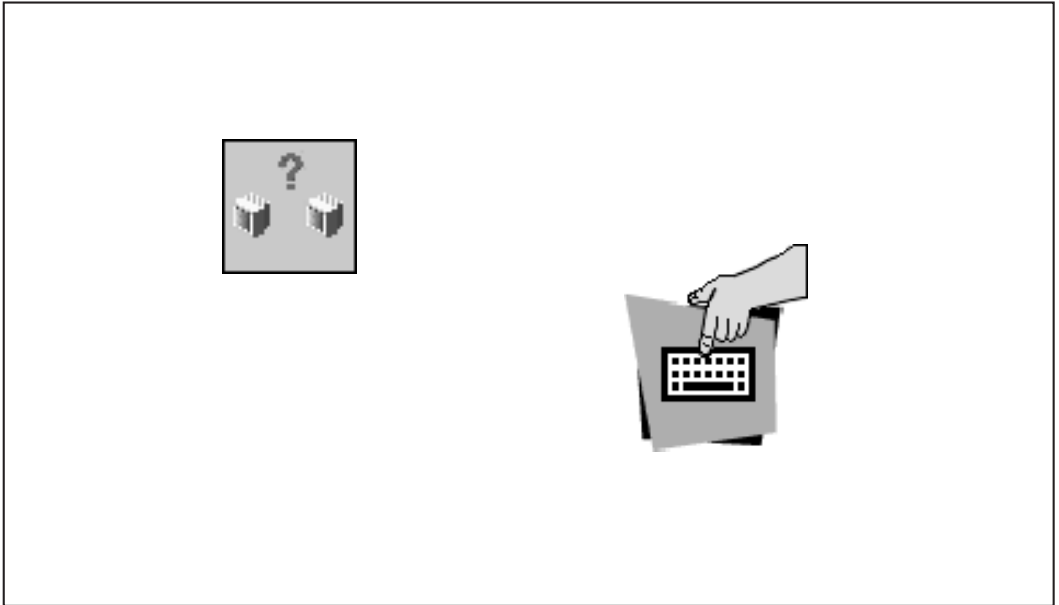

A number appears over the **keyboard** icon to represent the consoles installed. To select a console, type the number for the console you wish to use.

MultiBoot

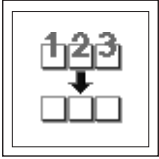

This selection invokes the Multiboot menu which provides several functions:

- To Select a particular operating system to boot.

In the case of AIX this is a supported option. If you receive an informational icon after making this selection, this would mean that information in non-volatile storage could have been lost, as would happen if the battery had been removed. In order to recreate this value, issue the bootlist command under AIX with the appropriate parameters as to the location of the operating system in a particular hard disk. Please see the explanation of the bootlist command in your AIX documentation.

- To select a particular operating system as the default operating system.
- To install from the list of possible devices.
- To set the sequence in which devices are searched for operating system startup code.
- To go to the Open Firmware command prompt.
- To set the Multiboot menu so that it comes up immediately as the system powers up.

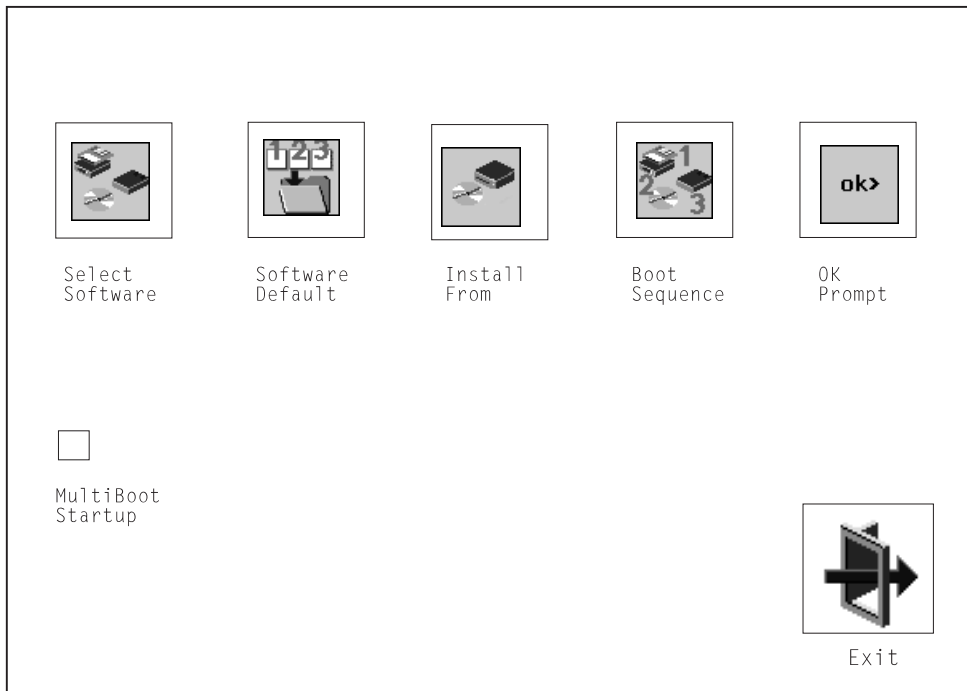

Select Software: If supported by the operating system, shows the names of the operating system installed. This option may not be supported by all operating systems.

In the case of AIX, this is a supported option. If you receive a message saying:
No Operating System Installed

this would mean that information in non-volatile storage could have been lost, as would happen if the battery had been removed. In order to recreate this value, issue the bootlist command under AIX with the appropriate parameters as to the location of the operating system in a particular Hard disk. Please see the explanation of the bootlist command in your AIX documentation.

Software Default: If supported by the operating system, lets you select the default operating system to start the system. This option may not be supported by all operating systems.

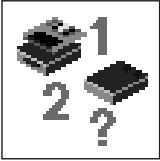

Install From: Produces a list of devices, for example the CD-ROM, where the operating system is installed from. You select one of the devices and the system searches the device for an operating system to install and if supported by the operating system in that device, the name of the operating system displays.

Boot Sequence

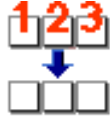

This selection enables you to view and change the custom boot list (the sequence in which devices are searched for operating system startup code).

| New | | List of Boot Devices |
|-----|-----|------------------------------------|
| - | [1] | Diskette |
| 1 | [2] | SCSI CD-ROM id=3 (slot=1) |
| | [3] | SCSI Tape Drive id=5 (slot=1) |
| 3 | [4] | SCSI 4.5 GB Harddisk id=6 (slot=1) |
| 2 | [5] | Ethernet (Integrated) |

| | | |
|---|---|--|
|  |  |  |
| Save | Default | Exit |

Attention: If you change your startup sequence, you must be extremely careful when performing *write* operations (for example, copying, saving, or formatting). You can accidentally overwrite data or programs if you select the wrong drive.

The default boot sequence is:

- The primary diskette drive
- CD-ROM drive
- Tape id=5 (slot=1)
- Hard disk drive id=6 (Slot=1)
- Network device.

To change the custom boot list, enter a new order in the **New** column, then select **Save**. The List of Boot Devices is updated to reflect the order you have chosen.

You can choose 1 to 5 devices for the custom boot list. To change the boot sequence back to the default values, select **Default**. (The default sequence is automatically saved.)

OK Prompt: Provides access to the Open Firmware command prompt.

Text-Based System Management Services

The text-based Open Firmware command line and System Management Services are available if an ASCII terminal is attached to your system unit. The text-based Open Firmware command line allows you to configure some adapters, and the System Management Services makes it possible for you to view information about your system unit and to perform such tasks as setting the password and changing device configurations.

To start the Text-Based System Management Services, turn on or restart the system. After the logo is displayed, the words "Memory", "Keyboard", "Network", "SCSI" and "Speaker" appear across the bottom of the screen. Press the 1 key after the word "Keyboard" appears and before the last word "Speaker" appears.

After the text-based System Management Services starts, the following screen appears:

```
System Management Services

1. Privilege Access Password
2. Display Error Log
3. Remote Initial Program Load Setup
4. SCSI Utilities
5. Console Select
6. MultiBoot
7. Select Language

                                |X=Exit|
                                -----

====>
```

Selecting the numbered options provide capabilities described on the following pages.

After you have finished using the text-based System Management Services, entering **x** (for exit) boots your system. You may also press 8 here to enter the 0K> prompt.

Privileged Access Password: Entering this selection permits access to the following options.

```

Password
Select
1. Enter Privileged Access Password
2. Remove Privileged Access Password
3. Unattended Start Mode <ON>

                                     |X=Exit|
                                     -----

===>
```

Set Privileged-Access Password: The privileged-access password protects against the unauthorized starting of the system programs.

Both the Service Processor and System Management Services use this password. If the password is set in System Management Services, the Service Processor automatically uses the same password.

If you previously had set a privileged-access password and want to remove it, select **Remove Privileged-Access Password**.

Unatt<On>: This icon is used to enable/disable Unattended Start Mode. This option is used to instruct the Service Processor to restore the power-state of the server after a temporary power failure. It is intended to be used on servers that require automatic power-on after a power failure. The default setting is ON.

Display Error Log: A screen similar to the following is displayed when you select this option. You can view or clear your system's error log.

```
System Error Log

      Date      Time      ErrorCode Location
Entry 1. 10/04/96 02:15:35 25a80011 00-00
Entry 2. No Entry

|C=Clear |           |X=Exit Log |
=====>
```

Note: The time stamp in this error log is Coordinated Universal Time (CUT) which is also referred to as Greenwich Mean Time (GMT). AIX error logs have more information available and can time stamp with local time.

Remote Initial Program Load Setup: This option allows you to enable and set up the remote startup capability of your system. First, you are asked to specify the network parameters.

```
Network Parameters

1. Set Address
2. Ping Remote System
3. Configure Adapters

|X=Exit |
=====>
```

Note: Some applications may require that IP addresses contain leading zeroes for numbers less than 100. For example, 129.132.4.20 may need to be entered as 129.132.004.020.

Selecting the Set Address option displays the following screen.

```
IP Parameters
1. Client IP Address  000.000.000.000
2. Server IP Address  000.000.000.000
3. Gateway IP Address 000.000.000.000
4. Subnet Mask       000.000.000.000

                               [X=Exit]

===>
```

Ping, second option available from the RIPL menu, allows you to test a connection to a remote system unit. After selecting the Ping option, you must choose which adapter communicates with the remote system.

```
Interface
1. Ethernet (Integrated)
2. Token Ring (Slot=3)

===>
```

After choosing which adapter to use to ping the remote system, you must provide the addresses needed to communicate with the remote system.

```
Ping

1. Client IP Address   129.132.4.20
2. Server IP Address  129.132.4.10
3. Gateway IP Address 129.132.4.30
4. Subnet Mask        255.255.255.0

|E=Execute|           |X=Exit|

==>
```

The third option available from the RIPL screen is the Configure adapters option. The following screen appear when you make this selection.

```
Configure Adapters

1. 10/100 Ethernet Slot=1
2. 10/100 Ethernet Slot=2

|X=Exit|
```

Selecting the Full Duplex option allows you to change how the Ethernet adapter communicates with the network:

```
Full Duplex
1. Yes
2. No
3. Auto
```

SCSI Utilities: Allow you to set SCSI hard disk spin up delay times and to set SCSI IDs for SCSI controllers installed in the S70 or S7A.

```
SCSI Utilities
```

1. Harddisk Spin Up Delay
2. Change SCSI Id

```
X=exit
```

Console Select

Selecting this option allows you to define which display is used by the system for system management.

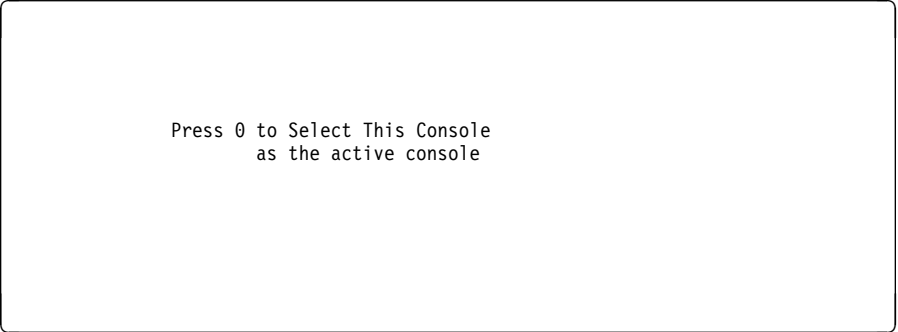

Press 0 to Select This Console
as the active console

MultiBoot Menu

```
Multiboot Menu

1. Select Software
2. Software Default
3. Select Install Device
4. Select Boot Devices
5. OK Prompt
6. Multiboot Startup

                                     [X=Exit]

====>
```

Select Software: If supported by the operating system, shows the names of the operating system installed. This option may not be supported by all operating systems.

In the case of AIX this is a supported option, if you receive a message saying that:
No Operating System Installed

this would mean that information in non-volatile storage could have been lost, as would happen if the battery had been removed. In order to recreate this value, issue the `bootlist` command under AIX with the appropriate parameters as to the location of the operating system in a particular hard disk. Please see the explanation of the `bootlist` command in your AIX documentation.

Software Default: If supported by the operating system, lets you select the default operating system to start the system. This option may not be supported by all operating systems.

Select Install Device: Produces a list of devices, for example the CD-ROM, where the operating system is installed from. You select one of the devices and the system searches the device for an operating system to install and if supported by the operating system in that device, the name of the operating system displays.

Select Boot Device: Provides a list of devices that can be selected to be stored on the boot list. Up to 5 devices are supported.

OK Prompt: Provides access to the Open Firmware command prompt.

Multiboot Start Option: Toggles between OFF and ON and selects if the Multiboot menu invokes automatically on startup or not.

Select Boot Devices

This selection enables you to view and change the custom boot list, which is the sequence of devices read at startup time.

```
Select Boot Devices

1. Display Current Settings
2. Restore Default Settings
3. Configure 1st Boot Device
4. Configure 2nd Boot Device
5. Configure 3rd Boot Device
6. Configure 4th Boot Device
7. Configure 5th Boot Device

                                     |X=Exit|
                                     -----

====>
```

Display Current Settings: Lists the current order of devices in the boot list. The following screen shows an example of this display.

```
Current Boot Sequence

1. Diskette
2. Ethernet (Integrated)
3. SCSI CD-ROM      id=3   (slot=1)
4. SCSI 500MB Hard Disk id=6   (slot=1)
5. SCSI 500MB Hard Disk id=5   (slot=5)

                                     |X=Exit|
                                     -----

====>
```

Restore Default Settings: Restores the boot list to the default sequence of:

- The primary diskette drive
- CD-ROM drive
- Tape id=5 (slot=1)
- Hard disk drive id=6 (Slot=1)
- Network device.

Selecting any of the **Configure Boot Device** options displays the following screen.

```
Configure Nth Boot Device

Device Number      Current Position      Device Name
-----
1                  1                     Diskette
2                  2                     Ethernet
3                  3                     SCSI CD-ROM
4                  4                     SCSI 4.5GB Hard Disk
5                  -

|P=prev-page| |N=next-page| |X=Exit|

===>
```

Select Language

This option allows you to change the language used by the text-based System Management Services screens and the Service Processor menus.

```
SELECT LANGUAGE

1. English
2. Deutsch
3. Espanol
4. Francais
5. Svenska
6. Italiano

====>                                |x=Exit|
```

Note: Your ASCII terminal must support the ISO-8859 character set in order to properly display languages other than English.

Chapter 5. Using the Online and Standalone Diagnostics

Sources for the Diagnostics

The diagnostics consist of Standalone Diagnostics and Online Diagnostics. Standalone Diagnostics are packaged on removable media. They must be booted before they can be run. If booted, they have no access to the AIX Error Log or the AIX Configuration Data. Online Diagnostics, when installed, reside with AIX in the file system. They can be booted in single user mode (referred to as service mode), run in maintenance mode (referred to as maintenance mode), or run concurrently (referred to as concurrent mode) with other applications. They have access to the AIX Error Log and the AIX Configuration Data.

Standalone and Online Diagnostics Operating Considerations

Note: When possible, run Online Diagnostics in Service Mode. Online Diagnostics perform additional functions, compared to Standalone Diagnostics. This ensures that the error state of the system is captured in NVRAM for your use in fixing the problem. The AIX error log and certain SMIT functions are only available when diagnostics are run from the disk drive.

The following items identify some things to consider before using the diagnostics.

1. When diagnostics are installed, the device support for some devices may not get installed. If this is the case, that device does not appear in the diagnostic test list when running disk based diagnostics.
2. Support for some TTY terminals is optionally installed. If you attach a TTY terminal to a system to run diagnostics be aware that it may not work properly since the AIX support for the terminal may not be installed.

Selecting a Console Display

When you run Standalone Diagnostics and under some conditions Online Diagnostics, you need to select the console display. The diagnostics display instructions on any graphics display and the terminal attached to the S1 serial port.

Identifying the Terminal Type to Diagnostics

Note: This is not the same as selecting a console display.

When you run diagnostics, the diagnostics must know what type of terminal you are using. If the terminal type is not known when the FUNCTION SELECTION menu is displayed, the diagnostics do not allow you to continue until a terminal is selected from the DEFINE TERMINAL option menu. Select **lft** for graphical displays.

Undefined Terminal Types

If an undefined terminal type from the DEFINE TERMINAL option menu is entered, the menu prompts the user to enter a valid terminal type, and the menu is redisplayed until either a valid type is entered or the user exits the DEFINE TERMINAL option.

Resetting the Terminal: If the user enters a terminal type that is valid (according to the DEFINE TERMINAL option menu) but is not the correct type for the ASCII terminal being used, difficulty may be encountered in reading the screen, using the function keys or the Enter key. These difficulties can be bypassed by pressing Ctrl-C to reset the terminal. The screen display which results from this resetting action varies with the mode in which the system is being run:

- Online Normal or Maintenance Mode - The command prompt appears.
- Standalone Mode or Online Service Mode -The terminal type is reset to "dumb", the Diagnostic Operating Instruction panel is displayed, and the user is required to go through the DEFINE TERMINAL process again.

Running Standalone Diagnostics

Consider the following when you run Standalone Diagnostics:

- The diagnostic CD must remain in the CD-ROM drive for the entire time that diagnostics are executing.
- The diagnostic CD-ROM cannot be ejected from the CD-ROM drive once the diagnostics have loaded. The CD can only be ejected after the system has been turned off and then turned on (standalone mode) or after the diagnostics program has terminated (Online concurrent mode).
- The CD-ROM drive from which diagnostics were loaded cannot be tested.
- The SCSI adapter (or circuitry) controlling the CD-ROM drive from which diagnostics were loaded cannot be tested.

Running Online Diagnostics

Consider the following when you run the Online Diagnostics from a server or a disk:

- The diagnostics cannot be loaded and run from a disk until the AIX operating system has been installed and configured. After the AIX operating system has been installed, all three modes of operation are available.
- The diagnostics cannot be loaded on a system (client) from a server if that system is not set up to boot from a server over a network. When the system is

set up to boot from a server, the diagnostics are run in the same manner as they are from disk.

- If the diagnostics are loaded from disk or a server, you must shutdown the AIX operating system before turning the system unit off to prevent possible damage to disk data. This is done in one of two ways:
 - If the diagnostics were loaded in standalone mode, press the F3 key until DIAGNOSTIC OPERATING INSTRUCTIONS displays; then press the F3 key once again to shutdown the AIX operating system.
 - If the diagnostics were loaded in maintenance or concurrent mode, enter the shutdown -F command.
- Under some conditions the system may stop, with instructions displayed on attached displays and terminals. Follow the instructions to select a console display.

Running the Diagnostics from a TTY Terminal

Consider the following when you run diagnostics using a TTY-type terminal as the console display:

- See the operator manual for your type of TTY terminal to find the key sequences you need to respond to the diagnostics. For the 3151, refer to the 3151 ASCII Display Station Guide to Operations, form number GA18-2633. For the 3164, refer to the 3164 ASCII Color Display Station Description, form number GA18-2617.
- When the diagnostics present display information through the Serial 1 port, certain attributes are used. These attributes are set as if the diagnostics were using a 3161 display terminal. The following tables list attributes for the 3161 ASCII Display Terminal and for two other ASCII display terminals commonly used with the system.
- If you have a TTY terminal other than a 3151, 3161 or 3164 attached to the S1 serial port, your terminal may have different names for the attributes. Use the attribute descriptions in the following tables to determine the settings for your terminal.

General Attributes Always Required

The following general attributes are the default settings for the diagnostics. Be sure your terminal is set to these attributes.

Note: These attributes should be set before the diagnostics are loaded.

Refer to the following table.

| General Setup Attributes | 3151 /11/31/41 Settings | 3151 /51/61 Settings | 3161/ 3164 Settings | Description |
|--------------------------|-------------------------|----------------------|---------------------|---|
| Machine mode | 3151 | 3151 PC | 3161 or 3164 | The diagnostics are set to emulate use of the 3161 ASCII Display Terminal. If your terminal can emulate a 5085, 3161 or 3164 terminal, use the following attribute settings. Otherwise, refer to your operator's manual, compare the following attribute descriptions with those of your terminal, and set your attributes accordingly. |
| Generated Code Set | | ASCII | | |
| Screen | Normal | Normal | | Uses the EIA-232 interface protocol. |
| Row and filemn | 24 x 80 | 24 x 80 | | Uses the EIA-232 interface protocol. |
| Scroll | Jump | Jump | Jump | When the last character on the bottom line is entered, the screen moves down one line. |
| Auto LF | Off | Off | Off | For the "On" setting, pressing the Return key moves the cursor to the first character position of the next line. For the "Off" setting, pressing the Return key moves the cursor to the first character position of the current line. The CR and LF characters are generated by the New line setting. |
| CRT saver | Off | Off | 10 | The "10" setting causes the display screen to go blank if there is no activity for 10 minutes. When the system unit sends data or a key is pressed, the display screen contents are displayed again. |

| General Setup Attributes | 3151 /11/31/41 Settings | 3151 /51/61 Settings | 3161/ 3164 Settings | Description |
|---------------------------------|--------------------------------|-----------------------------|----------------------------|--|
| Line wrap | On | On | On | The cursor moves to the first character position of the next line in the page after it reaches the last character position of the current line in the page. |
| Forcing insert | Off | Off | | |
| Tab | Field | Field | Field | The column tab stops are ignored, and the tab operation depends on the field attribute character positions. |
| Trace | | | All | Both inbound data (data to the system unit) and outbound data (data from the system unit) to and from the main port can be transferred to the auxiliary port without disturbing communications with the system unit when the Trace key is pressed. |

Additional Communication Attributes

The following communication attributes are for the 3151, 3161, and 3164 terminals.

| Communication Setup Attributes | 3151 /11/31/41 Settings | 3151 /51/61 Settings | 3161/3164 Settings | Description |
|--------------------------------|-------------------------|----------------------|--------------------|---|
| Operating mode | Echo | Echo | Echo | Data entered from the keyboard on the terminal is sent to the system unit for translation and then sent back to the display screen. Sometimes called conversational mode. |
| Line speed | 9600 bps | 9600 bps | 9600 bps | Uses the 9600 bps (bits per second) line speed to communicate with the system unit. |
| Word length (bits) | 8 | 8 | 8 | Selects eight bits as a data word length (byte). |
| Parity | No | No | No | Does not add a parity bit, and is used together with the word length attribute to form the 8-bit data word (byte). |
| Stop bit | 1 | 1 | 1 | Places a bit after a data word (byte). |
| Turnaround character | CR | CR | CR | Selects the carriage return (CR) character as the line turnaround character. |
| Interface | EIA-232 | EIA-232 | EIA-232 | Uses the EIA-232 interface protocol. |
| Line control | IPRTS | IPRTS | IPRTS | Uses the permanent request to send' (IPRTS) signal to communicate with system unit. |
| Break signal (ms) | 500 | 500 | 500 | The terminal sends a 'break signal' to the system unit within 500 ms after the Break key is pressed. |
| Send null suppress | On | On | | Trailing null characters are not sent to the system unit. |
| Send null | | | On | Trailing null characters are sent to the system unit. |
| Response delay (ms) | 100 | 100 | 100 | The terminal waits for 100ms for the system unit to respond. |

Additional Keyboard Attributes

The following keyboard attributes are for the keyboard attached to the 3151, 3161, and 3164 terminals.

| Keyboard Setup Attributes | 3151/11/31/41 Settings | 3151/51/61 Settings | 3161/3164 Settings | Description |
|----------------------------------|-------------------------------|----------------------------|---------------------------|--|
| Enter | Return | Return | Return | The Enter key functions as the Return key. |
| Return | New line | New line | New line | The cursor moves to the next line when the Return key is pressed. |
| New line | CR | CR | CR | The Return key generates the carriage return (CR) and the line feed (LF) characters. The line turn-around occurs after the CR and LF characters are generated. |
| Send | Page | Page | Page | The contents of the current page are sent to the system unit when the Send key is pressed. |
| Insert character | Space | Space | Space | A blank character is inserted when the Insert key is pressed. |

Additional Printer Attributes

The following printer attributes are for a printer attached to the 3151, 3161, and 3164 terminals.

| Printer Setup Attributes | 3151/11/31/41 Settings | 3151/51/61 Settings | 3161/3164 Settings | Description |
|--------------------------|------------------------|---------------------|--------------------|--|
| Line speed | 9600 | 9600 | 9600 | Uses 19200 or 9600 bps (bits per second) line speed to communicate with the system unit. |
| Word length (bits) | 8 | 8 | 8 | Selects eight bits as a data word length (byte). |
| Parity | Even | Even | No | |
| Stop bit | 1 | 1 | 1 | Places a bit after a data word (byte). |
| Characters | ALL | ALL | | |
| Line end | | | CR-LF | |
| Print | | | Viewport | |
| Print EOL | | | Off | |
| Print null | | | Off | |

Online Diagnostics Modes of Operation

The Online Diagnostics can be run in three modes:

- Service Mode
- Concurrent Mode
- Maintenance Mode

Service Mode

Service mode provides the most complete checkout of the system resources. This mode also requires that no other programs be running on the system. All system resources except the SCSI adapter, and the disk drives used for paging can be tested. However, note that the memory and processor are only tested during POST and the results of the POST tests are reported by diagnostics.

Error log analysis is done in service mode when you select the Problem Determination option on the DIAGNOSTIC MODE SELECTION menu.

Running the Online Diagnostics in Service Mode

To run Online Diagnostics in service mode, take the following steps:

1. Stop all programs including the AIX operating system (get help if needed).
2. Turn the power off.
3. Remove all tapes, diskettes, and CD-ROMs.
4. Turn the power on.
 - a. When or after the diskette indicator appears, press F6 on the directly-attached keyboard or 6 on the ASCII terminal keyboard to indicate that diagnostics are to be loaded.
 - b. Enter any requested passwords.
 - c. Follow any instructions to select a console.
5. After the diagnostic controller loads, DIAGNOSTIC OPERATING INSTRUCTIONS appear on the console display.
6. Follow the displayed instructions to checkout the desired resources.
7. When testing is complete; use the F3 key to return to the DIAGNOSTIC OPERATING INSTRUCTIONS.
8. Press the F3 key (from a defined terminal) or press 99 (for an undefined terminal) to shutdown the diagnostics before turning off the system unit.

Note: Pressing the F3 key (from a defined terminal) produces a "Confirm Exit" popup menu which offers two options: continuing with the shutdown by pressing F3; or returning to diagnostics by pressing Enter.

For undefined terminals, pressing 99 produces a full screen menu which offers two options: continuing with the shutdown by pressing 99 and then Enter; or returning to diagnostics by pressing Enter.

Concurrent Mode

Concurrent mode provides a way to run Online Diagnostics on some of the system resources while the system is running normal system activity.

Because the system is running in normal operation, some of the resources cannot be tested in concurrent mode. The following resources cannot be tested in concurrent mode:

- SCSI adapters connected to paging devices
- The disk drive used for paging
- Some display adapters and graphics related devices
- Memory (tested during POST)
- Processor (tested during POST).

There are three levels of testing in concurrent mode:

- The **share-test level** tests a resource while the resource is being shared by programs running in the normal operation. This testing is mostly limited to normal commands that test for the presence of a device or adapter.
- The **sub-test level** tests a portion of a resource while the remaining part of the resource is being used in normal operation. For example, this test could test one port of a multiport device while the other ports are being used in normal operation.
- The **full-test level** requires the device not be assigned to or used by any other operation. This level of testing on a disk drive may require the use of the varyoff command. The diagnostics display menus to allow you to vary off the needed resource.

Error log analysis is done in concurrent mode when you select the Problem Determination option on the DIAGNOSTIC MODE SELECTION menu.

To run the Online Diagnostics in concurrent mode you must be logged onto the AIX operating system and have proper authority to issue the commands (if needed, get help).

The `diag` command loads the diagnostic controller and displays the Online Diagnostic menus.

Running the Online Diagnostics in Concurrent Mode

To run Online Diagnostics in concurrent mode, take the following steps:

- Log on to the AIX operating system as root or superuser.
- Enter the `diag` command.
- When the DIAGNOSTIC OPERATING INSTRUCTIONS are displayed, follow the instructions to check out the desired resources.
- When testing is complete; use the F3 key to return to the DIAGNOSTIC OPERATING INSTRUCTIONS. Then press the F3 key again to return to the AIX operating system prompt. Be sure to vary on any resource you had varied to off.
- Press the Ctrl-D key sequence to log off from root or superuser.

Maintenance Mode

Maintenance mode runs the Online Diagnostics using the customer's version of the AIX operating system. This mode requires that all activity on the AIX operating system be stopped so the Online Diagnostics have most of the resources available to check. All of the system resources except the SCSI adapters, memory, processor, and the disk drive used for paging can be checked.

Error log analysis is done in maintenance mode when you select the Problem Determination option on the DIAGNOSTIC MODE SELECTION menu.

The `shutdown -m` command is used to stop all activity on the AIX operating system and put the AIX operating system into maintenance mode. Then the `diag` command is used to invoke the diagnostic controller so you can run the diagnostics. After the diagnostic controller is loaded, follow the normal diagnostic instructions.

Running the Online Diagnostics in Maintenance Mode

To run the Online Diagnostics in maintenance mode you must be logged on to the customer's version of the AIX operating system as *root* or *superuser* and use the `shutdown -m` and `diag` commands. Use the following steps to run the Online Diagnostics in maintenance mode:

1. Stop all programs except the AIX operating system (get help if needed).
2. Log onto the AIX operating system as *root* or *superuser*.
3. Enter the `shutdown -m` command.

4. When a message indicates the system is in maintenance mode, enter the diag command.
- Note:** It may be necessary to set *TERM* type again.
5. When DIAGNOSTIC OPERATING INSTRUCTIONS is displayed, follow the displayed instructions to checkout the desired resources.
6. When testing is complete; use the F3 key to return to DIAGNOSTIC OPERATING INSTRUCTIONS. Then press the F3 key again to return to the AIX operating system prompt.
7. Press Ctrl-D to log off from *root* or *superuser*.

Standalone Diagnostic Operation

Standalone Diagnostics provide a method to test the system when the Online Diagnostics are not installed and a method of testing the disk drives that cannot be tested by the Online Diagnostics.

No Error Log Analysis is done by the Standalone Diagnostics.

The CD-ROM drive and the SCSI controller that controls it cannot be tested by the Standalone Diagnostics.

Running the Standalone Diagnostics

To run Standalone Diagnostics in service mode, take the following steps:

1. Verify with the system administrator and system users that the system unit may be shut down, then stop all programs including the AIX operating system. (Refer to the AIX operating system documentation shutdown command information.)
2. Remove all tapes, diskettes, and CD-ROMs.
3. Insert the Diagnostic CD-ROM into the CD-ROM drive.
4. Turn off the system unit.
5. Turn the power on.
 - a. When or after the diskette indicator appears, press F5 on the direct attached keyboard or 5 on the TTY keyboard to indicate that diagnostics are to be loaded.
 - b. Enter any requested passwords.
 - c. Follow any instructions to select a console.
6. After the diagnostic controller loads, DIAGNOSTIC OPERATING INSTRUCTIONS appear on the console display.

7. Follow the displayed instructions to checkout the desired resources.
8. When testing is complete; use the F3 key to return to the DIAGNOSTIC OPERATING INSTRUCTIONS.

Logical and Physical Locations

This system uses Physical Location Codes in conjunction with AIX Location Codes to provide mapping of the failing field replaceable units. The location codes are produced by the system unit's firmware and AIX.

Physical Location Codes

Physical location codes provide a mapping of logical functions in a platform (or expansion sites for logical functions, such as connectors or ports) to their specific locations within the physical structure of the platform.

Location Code Format

The format for the location code is an alphanumeric string of variable length, consisting of a series of location identifiers, separated by the standard dash (-) or slash (/) character. The series is hierarchical; that is, each location identifier in the string is a physical child of the one preceding it.

- The - (dash) separator character represents a normal structural relationship where the child is a separate physical package and it plugs into (or is connected to) the parent. For example, P1-C1 is a CPU card (C1) plugged into a planar (P1), or P1-M1 is a memory card (M1) plugged into a planar (P1).
- The / (slash) separator character separates the base location code of a function from any extended location information. A group of logical devices can have the same base location code because they are all on the same physical package, but may require extended location information to describe the connectors they support. For example, P2/S1 describes the location of the serial port 1 controller and its connector (S1), which is located on planar P2 (its base location code), but the / indicates that further devices can be connected to it at the external S1 serial connector. The keyboard controller and its connector likewise have location code P2/K1, which means they have the same base location code (P2) as serial port 1, but a different external connector. In contrast, the location code P2-K1 actually points to the device connected to connector K1; that is, the keyboard. The location code P2/Z1 indicates an integrated SCSI controller which drives connector Z1, while location codes of P2-Z1-... point to the actual SCSI bus and devices.

Each location identifier consists of one alpha prefix character that identifies a location type, and a decimal integer number (typically one or two digits) that identifies a specific instance of this location type. Certain location types may also support secondary sub-locations, which are indicated by appending a period (".") character and a sub-location instance number.

Specifically, the format of a location code is defined as follows:

pn[.n][- or /]pn[.n][- or /]...

Where p is a defined alpha location type prefix, n is a location instance number, and [.n] is a sub-location instance number (where applicable). Sub-location notation is used only for location types which have clearly defined and limited expansion sites; for example, memory SIMMs slots on a memory card. Primarily, the [.n] sub-location notation is intended for use as an abbreviation of the location code in cases where:

1. Based on the device structure, the abbreviated sub-location code conveys the same information in a more concise form than an additional level of location identifier -- for example:
 - P1-M1.4 (pluggable DIMM 4 on Memory Card 1 on Planar 1), rather than P1-M1-M4
 - P1-C1.1 (pluggable CPU 1 on CPU Card 1 on Planar 1), rather than P1-C1-C1
 - P2-Z1-A3.1 (LUN 1 at SCSI ID 3 on integrated SCSI bus 1 from Planar 2), rather than P2-Z1-A3-A1
2. The sub-location is either a basic physical extension or sub-enclosure of the base location, but does not represent additional function or connectivity; for example, a drawer in a rack (U1.2) or a riser card on an I/O planar (P2.1).

AIX Location Codes

The basic formats of the AIX location codes are:

- For non-SCSI devices/drives
AB-CD-EF-GH
- For SCSI devices/drives
AB-CD-EF-G,H

For planars, cards, and non-SCSI devices the location code is defined as:

```
AB-CD-EF-GH
|  |  |  |
|  |  |  | Device/FRU/Port ID
|  |  |  | Connector ID
|  |  |  | devfunc Number, Adapter Number or Physical Location
|  |  |  | Bus Type or PCI Parent Bus
```

- The AB value identifies a bus type or PCI parent bus as assigned by the firmware.
- The CD value identifies adapter number, adapter's devfunc number, or physical location. The devfunc number is defined as the PCI device number times 8, plus the function number.
- The EF value identifies a connector.
- The GH value identifies a port, address, device, or FRU.

Adapters and cards are identified with just AB-CD.

The possible values for CD depend on the adapter/card.

For pluggable PCI adapters/cards, CD is the device's devfunc number (PCI device number times 8, plus the function number). The C and D are characters in the range of 0-9, and A-F (hex numbers). This allows the location code to uniquely identify multiple adapters on individual PCI cards.

EF is the connector ID. It is used to identify the adapter's connector that a resource is attached to.

GH is used to identify a port, device, or FRU. For example:

- For async devices GH defines the port on the fanout box. The values are 00 to 15.
- For a diskette drive H defines which diskette drive 1 or 2. G is always 0.

- For all other devices GH is equal to 00.

For integrated adapter, EF-GH is the same as the definition for a pluggable adapter. For example, the location code for a diskette drive is 01-D1-00-00. A second diskette drive is 01-D1-00-01.

For SCSI the location code is defined as:

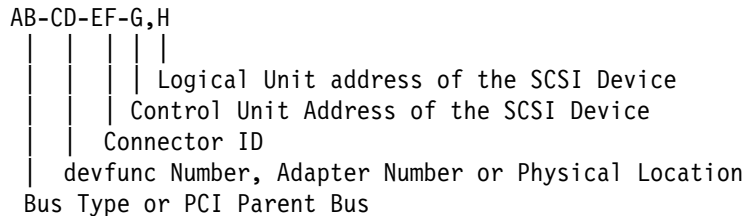

Where AB-CD-EF are the same as non-SCSI devices.

G defines the control unit address of the device. Values of 0 to 15 are valid.

H defines the logical unit address of the device. Values of 0 to 255 are valid.

There is also a bus location code that is generated as '00-XXXXXXXX' where XXXXXXXX is equivalent to the node's unit address.

Examples of physical location codes and AIX location codes are:

```

PCI adapter in drawer 0, Slot 1
Location Code U0.1-P1-I1
AIX location Code 20-58

```

```

PCI adapter in drawer 3, Slot 1
Location Code U0.4-P1-I1
AIX location Code E0-58

```

AIX and Physical Location Code Reference Tables

The following tables contain location codes that are used to identify functional units in the S70 and S7A systems. Each table below shows the locations for a physical part the system.

System Rack

| FRU Name | Slot Name | Location Code | AIX Location Code | Physical Connection | Logical Connection |
|------------------------------|-----------|---------------|-------------------|---------------------|--------------------|
| System Rack | | | | | |
| System Rack Drawer | | U1 | 00-00 | | |
| System Backplane | | U1.1-P1 | 00-00 | | |
| Memory Controller | | U1.1-P1 | 00-00 | On System Backplane | |
| Interrupt Controller | | U1.1-P1 | 00-00 | On System Backplane | |
| R1 Memory Card Quad A, Front | M01 | U1.1-P1-M1 | 00-00 | System Backplane | |
| R1 Memory Card Quad A, Front | M02 | U1.1-P1-M2 | 00-00 | System Backplane | |
| R1 Memory Card Quad B, Front | M03 | U1.1-P1-M3 | 00-00 | System Backplane | |
| R1 Memory Card Quad B, Front | M04 | U1.1-P1-M4 | 00-00 | System Backplane | |
| R1 Memory Card Quad C, Front | M05 | U1.1-P1-M5 | 00-00 | System Backplane | |
| R1 Memory Card Quad C, Front | M06 | U1.1-P1-M6 | 00-00 | System Backplane | |
| System Clock Card Front | M07 | U1.1-P1-X1 | 00-00 | System Backplane | |
| RIO Port 4 Connector | | U1.1-P1-X1/Q1 | | System Clock Card | |
| RIO Port 5 Connector | | U1.1-P1-X1/Q2 | | System Clock Card | |
| RIO Port 6 Connector | | U1.1-P1-X1/Q3 | | System Clock Card | |
| RIO Port 7 Connector | | U1.1-P1-X1/Q4 | | System Clock Card | |

| FRU Name | Slot Name | Location Code | AIX Location Code | Physical Connection | Logical Connection |
|--------------------------------|-----------|---------------|-------------------|---------------------|--------------------|
| Processor Card 0 Type 1, Front | M08 | U1.1-P1-C1 | | System Back-plane | |
| Processor Card 0 All Cache | | U1.1-P1-C1 | 00-00 | On Processor Card 0 | |
| Processor Card 0 Processor 0 | | U1.1-P1-C1 | 00-00 | On Processor Card 0 | |
| Processor Card 0 Processor 1 | | U1.1-P1-C1 | 00-01 | On Processor Card 0 | |
| Processor Card 0 Processor 2 | | U1.1-P1-C1 | 00-02 | On Processor Card 0 | |
| Processor Card 0 Processor 3 | | U1.1-P1-C1 | 00-03 | On Processor Card 0 | |
| Processor Card 1 Type 2, Front | M09 | U1.1-P1-C2 | | System Back-plane | |
| Processor Card 1 All Cache | | U1.1-P1-C2 | 00-00 | On Processor Card 1 | |
| Processor Card 1 Processor 4 | | U1.1-P1-C2 | 00-04 | On Processor Card 1 | |
| Processor Card 1 Processor 5 | | U1.1-P1-C2 | 00-05 | On Processor Card 1 | |
| Processor Card 1 Processor 6 | | U1.1-P1-C2 | 00-06 | On Processor Card 1 | |
| Processor Card 1 Processor 7 | | U1.1-P1-C2 | 00-07 | On Processor Card 1 | |
| R1 Memory Card Quad C, Front | M10 | U1.1-P1-M7 | 00-00 | System Back-plane | |
| R1 Memory Card Quad C, Front | M11 | U1.1-P1-M8 | 00-00 | System Back-plane | |
| R1 Memory Card Quad B, Front | M12 | U1.1-P1-M9 | 00-00 | System Back-plane | |
| R1 Memory Card Quad B, Front | M13 | U1.1-P1-M10 | 00-00 | System Back-plane | |

| FRU Name | Slot Name | Location Code | AIX Location Code | Physical Connection | Logical Connection |
|---|-----------|----------------|-------------------|----------------------------|--------------------|
| R1 Memory Card Quad A, Front | M14 | U1.1-P1-M11 | 00-00 | System Back-plane | |
| R1 Memory Card Quad A, Front | M15 | U1.1-P1-M12 | 00-00 | System Back-plane | |
| Op Panel Front | | U1.1-P1-L1 | | System Back-plane via card | |
| JTAG Port Rear | | U1.1-P1-Q8 | | System Back-plane via card | |
| R1 Memory Card Quad D, Rear | M16 | U1.1-P1-M13 | 00-00 | System Back-plane | |
| R1 Memory Card Quad D, Rear | M17 | U1.1-P1-M14 | 00-00 | System Back-plane | |
| R1 Memory Card Quad E, Rear | M18 | U1.1-P1-M15 | 00-00 | System Back-plane | |
| R1 Memory Card Quad E, Rear | M19 | U1.1-P1-M16 | 00-00 | System Back-plane | |
| DIMM Based Memory Card, Quad E Left Hand, Rear (S70 only) | M18 | U1.1-P1-M15 | 00-00 | System Back-plane | |
| DIMM 1 (S70 only) | M18-J1L | U1.1-P1-M15.1 | 00-00 | DIMM Memory Card | |
| DIMM 2 (S70 only) | M18-J1R | U1.1-P1-M15.2 | 00-00 | DIMM Memory Card | |
| DIMM 3 (S70 only) | M18-J3L | U1.1-P1-M15.3 | 00-00 | DIMM Memory Card | |
| DIMM 4 (S70 only) | M18-J3R | U1.1-P1-M15.4 | 00-00 | DIMM Memory Card | |
| DIMM 5 (S70 only) | M18-J5L | U1.1-P1-M15.5 | 00-00 | DIMM Memory Card | |
| DIMM 6 (S70 only) | M18-J5R | U1.1-P1-M15.6 | 00-00 | DIMM Memory Card | |
| DIMM 7 (S70 only) | M18-J7L | U1.1-P1-M15.7 | 00-00 | DIMM Memory Card | |
| DIMM 8 (S70 only) | M18-J7R | U1.1-P1-M15.8 | 00-00 | DIMM Memory Card | |
| DIMM 9 (S70 only) | M18-J2L | U1.1-P1-M15.9 | 00-00 | DIMM Memory Card | |
| DIMM 10 (S70 only) | M18-J2R | U1.1-P1-M15.10 | 00-00 | DIMM Memory Card | |

| FRU Name | Slot Name | Location Code | AIX Location Code | Physical Connection | Logical Connection |
|---|------------------|----------------------|--------------------------|----------------------------|---------------------------|
| DIMM 11 (S70 only) | M18-J4L | U1.1-P1-M15.11 | 00-00 | DIMM Memory Card | |
| DIMM 12 (S70 only) | M18-J4R | U1.1-P1-M15.12 | 00-00 | DIMM Memory Card | |
| DIMM 13 (S70 only) | M18-J6L | U1.1-P1-M15.13 | 00-00 | DIMM Memory Card | |
| DIMM 14 (S70 only) | M18-J6R | U1.1-P1-M15.14 | 00-00 | DIMM Memory Card | |
| DIMM 15 (S70 only) | M18-J8L | U1.1-P1-M15.15 | 00-00 | DIMM Memory Card | |
| DIMM 16 (S70 only) | M18-J8R | U1.1-P1-M15.16 | 00-00 | DIMM Memory Card | |
| DIMM Based Memory Card Quad E Right Hand (S70 only) | M19 | U1.1-P1-M16 | 00-00 | System Back- plane | |
| DIMM 1 (S70 only) | M19-J1L | U1.1-P1-M16.1 | 00-00 | DIMM Memory Card | |
| DIMM 2 (S70 only) | M19-J1R | U1.1-P1-M16.2 | 00-00 | DIMM Memory Card | |
| DIMM 3 (S70 only) | M19-J3L | U1.1-P1-M16.3 | 00-00 | DIMM Memory Card | |
| DIMM 4 (S70 only) | M19-J3R | U1.1-P1-M16.4 | 00-00 | DIMM Memory Card | |
| DIMM 5 (S70 only) | M19-J5L | U1.1-P1-M16.5 | 00-00 | DIMM Memory Card | |
| DIMM 6 (S70 only) | M19-J5R | U1.1-P1-M16.6 | 00-00 | DIMM Memory Card | |
| DIMM 7 (S70 only) | M19-J7L | U1.1-P1-M16.7 | 00-00 | DIMM Memory Card | |
| DIMM 8 (S70 only) | M19-J7R | U1.1-P1-M16.8 | 00-00 | DIMM Memory Card | |
| DIMM 9 (S70 only) | M19-J2L | U1.1-P1-M16.9 | 00-00 | DIMM Memory Card | |
| DIMM 10 (S70 only) | M19-J2R | U1.1-P1-M16.10 | 00-00 | DIMM Memory Card | |
| DIMM 11 (S70 only) | M19-J4L | U1.1-P1-M16.11 | 00-00 | DIMM Memory Card | |
| DIMM 12 (S70 only) | M19-J4R | U1.1-P1-M16.12 | 00-00 | DIMM Memory Card | |

| FRU Name | Slot Name | Location Code | AIX Location Code | Physical Connection | Logical Connection |
|---|-----------|----------------|-------------------|------------------------|--------------------|
| DIMM 13 (S70 only) | M19-J6L | U1.1-P1-M16.13 | 00-00 | DIMM Memory Card | |
| DIMM 14 (S70 only) | M19-J6R | U1.1-P1-M16.14 | 00-00 | DIMM Memory Card | |
| DIMM 15 (S70 only) | M19-J8L | U1.1-P1-M16.15 | 00-00 | DIMM Memory Card | |
| DIMM 16 (S70 only) | M19-J8R | U1.1-P1-M16.16 | 00-00 | DIMM Memory Card | |
| Processor Card 2 Type 1, Rear | | U1.1-P1-C3 | | System Back- plane | |
| Processor Card 2 All Cache | | U1.1-P1-C3 | 00-00 | On Processor Card 2 | |
| Processor Card 2 Processor 8 | | U1.1-P1-C3 | 00-08 | On Processor Card 2 | |
| Processor Card 2 Processor 9 | | U1.1-P1-C3 | 00-09 | On Processor Card 2 | |
| Processor Card 2 Processor 10 | | U1.1-P1-C3 | 00-10 | On Processor Card 2 | |
| Processor Card 2 Processor 11 | | U1.1-P1-C3 | 00-11 | On Processor Card 2 | |
| DIMM Based Memory Card, Quad E Left Hand (S70 only) | M21 | U1.1-P1-M17 | | System Back- plane | |
| DIMM 1 (S70 only) | M21-J1L | U1.1-P1-M17.1 | 00-00 | DIMM Memory Card | |
| DIMM 2 (S70 only) | M21-J1R | U1.1-P1-M17.2 | 00-00 | DIMM Memory Card | |
| DIMM 3 (S70 only) | M21-J3L | U1.1-P1-M17.3 | 00-00 | DIMM Memory Card | |
| DIMM 4 (S70 only) | M21-J3R | U1.1-P1-M17.4 | 00-00 | DIMM Memory Card | |
| DIMM 5 (S70 only) | M21-J5L | U1.1-P1-M17.5 | 00-00 | DIMM Memory Card | |

| FRU Name | Slot Name | Location Code | AIX Location Code | Physical Connection | Logical Connection |
|--|------------------|----------------------|--------------------------|----------------------------|---------------------------|
| DIMM 6 (S70 only) | M21-J5R | U1.1-P1-M17.6 | 00-00 | DIMM Memory Card | |
| DIMM 7 (S70 only) | M21-J7L | U1.1-P1-M17.7 | 00-00 | DIMM Memory Card | |
| DIMM 8 (S70 only) | M21-J7R | U1.1-P1-M17.8 | 00-00 | DIMM Memory Card | |
| DIMM 9 (S70 only) | M21-J2L | U1.1-P1-M17.9 | 00-00 | DIMM Memory Card | |
| DIMM 10 (S70 only) | M21-J2R | U1.1-P1-M17.10 | 00-00 | DIMM Memory Card | |
| DIMM 11 (S70 only) | M21-J4L | U1.1-P1-M17.11 | 00-00 | DIMM Memory Card | |
| DIMM 12 (S70 only) | M21-J4R | U1.1-P1-M17.12 | 00-00 | DIMM Memory Card | |
| DIMM 13 (S70 only) | M21-J6L | U1.1-P1-M17.13 | 00-00 | DIMM Memory Card | |
| DIMM 14 (S70 only) | M21-J6R | U1.1-P1-M17.14 | 00-00 | DIMM Memory Card | |
| DIMM 15 (S70 only) | M21-J8L | U1.1-P1-M17.15 | 00-00 | DIMM Memory Card | |
| DIMM 16 (S70 only) | M21-J8R | U1.1-P1-M17.16 | 00-00 | DIMM Memory Card | |
| DIMM Based Memory Card, Quad E Right Hand (S70 only) | M22 | U1.1-P1-M18 | 00-00 | System Back-plane | |
| DIMM 1 (S70 only) | M22-J1L | U1.1-P1-M18.1 | 00-00 | DIMM Memory Card | |
| DIMM 2 (S70 only) | M22-J1R | U1.1-P1-M18.2 | 00-00 | DIMM Memory Card | |
| DIMM 3 (S70 only) | M22-J3L | U1.1-P1-M18.3 | 00-00 | DIMM Memory Card | |
| DIMM 4 (S70 only) | M22-J3R | U1.1-P1-M18.4 | 00-00 | DIMM Memory Card | |
| DIMM 5 (S70 only) | M22-J5L | U1.1-P1-M18.5 | 00-00 | DIMM Memory Card | |
| DIMM 6 (S70 only) | M22-J5R | U1.1-P1-M18.6 | 00-00 | DIMM Memory Card | |
| DIMM 7 (S70 only) | M22-J7L | U1.1-P1-M18.7 | 00-00 | DIMM Memory Card | |

| FRU Name | Slot Name | Location Code | AIX Location Code | Physical Connection | Logical Connection |
|------------------------------------|-----------|----------------|-------------------|---------------------|--------------------|
| DIMM 8 (S70 only) | M22-J7R | U1.1-P1-M18.8 | 00-00 | DIMM Memory Card | |
| DIMM 9 (S70 only) | M22-J2L | U1.1-P1-M18.9 | 00-00 | DIMM Memory Card | |
| DIMM 10 (S70 only) | M22-J2R | U1.1-P1-M18.10 | 00-00 | DIMM Memory Card | |
| DIMM 11 (S70 only) | M22-J4L | U1.1-P1-M18.11 | 00-00 | DIMM Memory Card | |
| DIMM 12 (S70 only) | M22-J4R | U1.1-P1-M18.12 | 00-00 | DIMM Memory Card | |
| DIMM 13 (S70 only) | M22-J6L | U1.1-P1-M18.13 | 00-00 | DIMM Memory Card | |
| DIMM 14 (S70 only) | M22-J6R | U1.1-P1-M18.14 | 00-00 | DIMM Memory Card | |
| DIMM 15 (S70 only) | M22-J8L | U1.1-P1-M18.15 | 00-00 | DIMM Memory Card | |
| DIMM 16 (S70 only) | M22-J8R | U1.1-P1-M18.16 | 00-00 | DIMM Memory Card | |
| R1 Memory Card Quad E, Rear | M21 | U1.1-P1-M17 | 00-00 | System Back-plane | |
| R1 Memory Card Quad E, Rear | M22 | U1.1-P1-M18 | 00-00 | System Back-plane | |
| R1 Memory Card Quad D, Rear | M23 | U1.1-P1-M19 | 00-00 | System Back-plane | |
| R1 Memory Card Quad D, Rear | M24 | U1.1-P1-M20 | 00-00 | System Back-plane | |
| ISO RIO Extender Card R (Extender) | | U1.1-P1.1 | | System Back-plane | |
| RIO Port 0 Rear Connector | | U1.1-P1.1/Q1 | | RIO Extender Card | |
| RIO Port 1 Rear Connector | | U1.1-P1.1/Q2 | | RIO Extender Card | |
| RIO Port 2 Rear Connector | | U1.1-P1.1/Q3 | | RIO Extender Card | |
| RIO Port 3 Rear Connector | | U1.1-P1.1/Q4 | | RIO Extender Card | |
| Power Back-plane Board | | U1.1-P2 | | | |
| Regulator Card Front | R01 | U1.1-P2-V1 | | Power Back-plane | |

| FRU Name | Slot Name | Location Code | AIX Location Code | Physical Connection | Logical Connection |
|---------------------------------|------------------|----------------------|--------------------------|----------------------------|---------------------------|
| Regulator Card Front (S70 only) | R02 | U1.1-P2-V2 | | Power Back-plane | |
| Filler Card Front | R03 | | | Power Back-plane | |
| Regulator Card Front (S7A only) | R04 | U1.1-P2-V4 | | Power Back-plane | |
| Regulator Card Front (S7A only) | R05 | U1.1-P2-V5 | | Power Back-plane | |
| Filler Card Front | R06 | | | Power Back-plane | |
| Filler Card Front | R07 | | | Power Back-plane | |
| Filler Card Front | R08 | | | Power Back-plane | |
| Filler Card Front | R09 | | | Power Back-plane | |
| Regulator Card Front (S70 only) | R10 | U1.1-P2-V9 | | Power Back-plane | |
| Regulator Card Rear | R11 | U1.1-P2-V10 | | Power Back-plane | |
| Regulator Card Rear | R12 | U1.1-P2-V11 | | Power Back-plane | |
| Filler Card | R13 and R14 | | | Power Back-plane | |
| Regulator Card Rear | R15 | U1.1-P2-V12 | | Power Back-plane | |
| Regulator Card Rear | R16 | U1.1-P2-V13 | | Power Back-plane | |
| Regulator Card Mem CTRL Rear | R17 | U1.1-P2-V14 | | Power Back-plane | |
| Regulator Card Mem CTRL Rear | R18 | U1.1-P2-V15 | | Power Back-plane | |
| Regulator Card Rear | R19 | U1.1-P2-V16 | | Power Back-plane | |

| FRU Name | Slot Name | Location Code | AIX Location Code | Physical Connection | Logical Connection |
|-----------------------------------|-----------|---------------|-------------------|-------------------------------|--------------------|
| Regulator Card Rear | R20 | U1.1-P2-V17 | | Power Back-plane | |
| SPCN Card Rear | R21 | U1.1-P2-X1 | | Power Back-plane | |
| Blower 1 Sense 1 | | U1.1-P2-X1/F1 | | On SPCN Card | |
| Blower 2 Sense 2 | | U1.1-P2-X1/F2 | | On SPCN Card | |
| Blower 3 Sense 3 | | U1.1-P2-X1/F3 | | On SPCN Card | |
| Blower 4 Sense 4 | | U1.1-P2-X1/F4 | | On SPCN Card | |
| Blower 1 Front | | U1.2-F1 | | Power Harness, J18 | |
| Blower 2 Front | | U1.2-F2 | | Power Harness, J19 | |
| Blower 3 Rear | | U1.2-F3 | | Power Harness, J20 | |
| Blower 4 Rear | | U1.2-F4 | | Power Harness, J21 | |
| Bulk Power 1 Front | | U1.2-V2 | | Power Harness, P1 | |
| Bulk Power 2 Front | | U1.2-V3 | | Power Harness, P2 | |
| Bulk Power 3 Front | | U1.2-V4 | | Power Harness, P3 | |
| Bulk Power 4 Front | | U1.2-V5 | | Power Harness, P4 | |
| Bulk Power 5 Front | | U1.2-V6 | | Power Harness, P5 | |
| Bulk Power 6 Front | | U1.2-V7 | | Power Harness, P6 | |
| AC Power R and 5 v standby AC Box | | U1.2-V1 | | Power Harness, P1, P7, P8, P9 | |

| FRU Name | Slot Name | Location Code | AIX Location Code | Physical Connection | Logical Connection |
|---------------------------------|-----------|---------------|---|-----------------------------------|--------------------|
| I/O Drawer 0 Locations | | | | | |
| I/O Drawer 0 (of 0 to 3) | | U0.1 | | | |
| I/O planar | | U0.1-P1 | | | |
| RIO Controller 0 | | U0.1-P1 | 00-00 | | |
| PCI Controller 1 | | U0.1-P1 | 00-f850-0000 | | |
| PCI slot 1 | | U0.1-P1-I1 | 20-58 or 20-58 to 20-5F or 2B-XX | I/O planar J13, 64 bit slot | PCI Controller 1 |
| PCI slot 2 | | U0.1-P1-I2 | 20-60 or 20-60 to 20-67 or 2C-XX | I/O planar J4, 32 bit slot | PCI Controller 1 |
| PCI slot 3 | | U0.1-P1-I3 | 20-68 or 20-68 to 20-6F or 2D-XX | I/O planar J5, 32 bit slot | PCI Controller 1 |
| PCI slot 4 | | U0.1-P1-I4 | 20-70 or 20-70 to 20-77 or 2E-XX | I/O planar J6, 32 bit slot | PCI Controller 1 |
| PCI Controller 0 | | U0.1-P1 | 00-f840-0000 | | |
| PCI slot 5 | | U0.1-P1-I5 | 10-58 or 10-58 to 10-5F or 1B-XX | I/O planar J14, 64 bit slot | PCI Controller 0 |
| PCI slot 6 | | U0.1-P1-I6 | 10-60 or 10-60 to 10-67 or 1C-XX | I/O planar J7, 32 bit slot | PCI Controller 0 |
| PCI slot 7 | | U0.1-P1-I7 | 10-68 or 10-68 to 10-6F or 1D-XX | I/O planar J8, 32 bit slot | PCI Controller 0 |

| FRU Name | Slot Name | Location Code | AIX Location Code | Physical Connection | Logical Connection |
|--|-----------|---------------|--|----------------------------|--------------------|
| PCI slot 8 Service Processor | | U0.1-P1-X1 | 10-70 or 10-70 to 10-77 or 1E-XX (not used by AIX) | I/O planar J9, 32 bit slot | PCI Controller 0 |
| TOD | | U0.1-P1-X1 | Not used by AIX | On Service Processor | |
| BOOT | | U0.1-P1-X1 | Not used by AIX | On Service Processor | |
| JTAG | | U0.1-P1-X1 | Not used by AIX | On Service Processor | |
| VDISK | | U0.1-P1-X1 | Not used by AIX | On Service Processor | |
| NVRAM | | U0.1-P1-X1 | Not used by AIX | On Service Processor | |
| PCI slot 8, Service Processor ISA Bridge | | U0.1-P1-X1 | 10-78 or 10-78 to 10-7f or 1F-XX (not used by AIX) | I/O planar J9, 32 bit slot | PCI Controller 0 |
| PCI slot 8 Real Time Clock (RTC) | | U0.1-P1-X1 | Not used by AIX | On Service Processor | I/O ASIC SIO |
| PCI slot 8 Timer | | U0.1-P1-X1 | Not used by AIX | On Service Processor | I/O ASIC SIO |
| Interrupt Controller | | U0.1-P1-X1 | Not used by AIX | On Service Processor | I/O ASIC |
| DMA Controller | | U0.1-P1-X1 | Not used by AIX | On Service Processor | I/O ASIC |
| Diskette Controller | | U0.1-P1-X1-D1 | 01-D1 | On Service Processor | |
| Diskette Drive | | U0.1-P1-X1/D1 | 01-D1-00-00 | On Service Processor | |
| Keyboard Mouse Controller | | U0.1-P1-X1/K1 | 01-K1 | On Service Processor | |
| Keyboard | | U0.1-P1-X1-K1 | 01-K1-00-00 | On Service Processor | |
| Mouse Controller | | U0.1-P1-X1/K1 | 01-K1-01 | On Service Processor | |

| FRU Name | Slot Name | Location Code | AIX Location Code | Physical Connection | Logical Connection |
|----------------------------------|-----------|---------------|---|-----------------------------|--------------------|
| Mouse | | U0.1-P1-X1-O1 | 01-K1-01-00 | On Service Processor | |
| Parallel Port | | U0.1-P1-X1/R1 | 01-R1 | On Service Processor | |
| Serial Port 1 | | U0.1-P1-X1/S1 | 01-S1 | On Service Processor | |
| Serial Port 2 | | U0.1-P1-X1/S2 | 01-S2 | On Service Processor | |
| System Rack Operator Panel Cable | | | | Service Processor J17 | |
| PCI Controller 3 | | U0.1-P1 | 00-f870-0000 | | |
| PCI Slot 9 | | U0.1-P1-I9 | 40-58 or 40-58 to 40-5f or 4B-XX | I/O planar J15, 64 Bit slot | PCI Controller 3 |
| PCI Slot 10 | | U0.1-P1-I10 | 40-60 or 40-60 to 40-67 or 4C-XX | I/O planar J16, 64 Bit slot | PCI Controller 3 |
| PCI Controller 2 | | U0.1-P1 | 00-f860-0000 | | |
| PCI Slot 11 | | U0.1-P1-I11 | 30-58 or 30-58 to 30-5f or 3B-XX | I/O planar J10, 32 Bit slot | PCI Controller 2 |
| PCI Slot 12 | | U0.1-P1-I12 | 30-60 or 30-60 to 30-67 or 3C-XX | I/O planar J11, 32 Bit slot | PCI Controller 2 |
| PCI Slot 13 | | U0.1-P1-I13 | 30-68 or 30-68 to 30-6f or 3D-XX | I/O planar J12, 32 Bit slot | PCI Controller 2 |
| PCI Slot 14 | | U0.1-P1-I14 | 30-70 or 30-70 to 30-77 or 3E-XX | I/O planar J17, 64 Bit slot | PCI Controller 2 |
| Local ASIC Control Chip | | U0.1-P1 | 30-78 | | |
| Local ASIC Control Chip | | U0.1-P1 | 30-79 | | |
| RIO 0 Connector | | U0.1-P1/Q1 | | I/O Drawer planar, J1 | System Rack |

| FRU Name | Slot Name | Location Code | AIX Location Code | Physical Connection | Logical Connection |
|---|-----------|---------------|-------------------|--|-----------------------|
| RIO 1 Connector | | U0.1-P1/Q2 | | I/O Drawer planar J2 | System Rack |
| Speaker | | U0.1-P1-X1-Q1 | | Service Processor J3 | I/O planar (S7A only) |
| 3/4 Power Supply (7 EIA Unit I/O Drawer) or Right Power Supply (10 EIA Unit I/O Drawer when viewed from rear) | | U0.1-V2 | | Power cable P101-P108 (S70 only) PDB J2 (S7A only) | |
| 1/4 Power Supply (7 EIA Unit I/O Drawer) or Left Power Supply (10 EIA Unit I/O Drawer when viewed from rear) | | U0.1-V1 | | Power cable P201, P208 (S70 only) PDB J1 (S7A only) | |
| I/O Drawer Indicator Panel Card (7 EIA Unit I/O Drawer) or I/O Drawer Indicator Panel Card (10 EIA Unit I/O Drawer) | | U0.1-L1 | | I/O planar, J22 (7 EIA Unit I/O Drawer) or I/O Drawer Planar, J19 (10 EIA Unit I/O Drawer) | Cable to I/O planar |
| Fan Monitoring Card | | U0.1-X2 | | | Cable to PDB card |
| I/O Drawer Three Fan Assm. (7 EIA Unit I/O Drawer) | | U0.1-L1-F1 | | I/O Drawer indicator panel card, J2 | |
| I/O Drawer Center Blower (10 EIA Unit I/O Drawer) | | U0.1-F7 | | Fan Monitoring Card J3 | Fan Monitoring Card |

| FRU Name | Slot Name | Location Code | AIX Location Code | Physical Connection | Logical Connection |
|---|------------------|----------------------|--------------------------|--|---------------------------|
| I/O Drawer Left Blower (10 EIA Unit I/O Drawer) | | U0.1-F5 | | Fan Monitoring Card J2 | Fan Monitoring Card |
| I/O Drawer Right Blower (10 EIA Unit I/O Drawer) | | U0.1-F6 | | Fan Monitoring Card J4 | Fan Monitoring Card |
| I/O Drawer Fan 1 (Left PS, left fan when viewed from rear) (10 EIA Unit I/O Drawer) | | U0.1-F1 | | Fan Monitoring Card J5 | Fan Monitoring Card |
| I/O Drawer Fan 2 (Left PS, right fan when viewed from rear) (10 EIA Unit I/O Drawer) | | U0.1-F2 | | Fan Monitoring Card J5 | Fan Monitoring Card |
| I/O Drawer Fan 3 (Right PS, left fan when viewed from rear) (10 EIA Unit I/O Drawer) | | U0.1-F3 | | Fan Monitoring Card J5 | Fan Monitoring Card |
| I/O Drawer Fan 4 (Right PS, right fan when viewed from rear) (10 EIA Unit I/O Drawer) | | U0.1-F4 | | Fan Monitoring Card J5 | Fan Monitoring Card |
| Power Distribution Card (10 EIA Unit I/O Drawer) | | U0.1-X3 | | | J22 to I/O Planar |
| SE/SE SCSI Redrive Card | | U0.1-P2 | | Redrive card connector J1 to power cable | |

| FRU Name | Slot Name | Location Code | AIX Location Code | Physical Connection | Logical Connection |
|---------------------------|-----------|---------------|-------------------|---------------------|--------------------|
| Interface (Bulkhead) Card | | U0.1-P1-Q3 | | I/O planar, J3 | |

| FRU Name | Slot Name | Location Code | AIX Location Code | Physical Connection | Logical Connection |
|---------------------------------|-----------|---------------|---|-----------------------------------|--------------------|
| I/O Drawer 1 Locations | | | | | |
| I/O Drawer 1 (of 0 to 3) | | U0.2 | | | |
| I/O planar | | U0.2-P1 | | | |
| RIO Controller 1 | | U0.2-P1 | 00-00 | | |
| PCI Controller 5 | | U0.2-P1 | 00-f8D0-0000 | | |
| PCI slot 1 | | U0.2-P1-I1 | 60-58 or 60-58 to 60-5F or 6B-XX | I/O planar J13, 64 bit slot | PCI Controller 5 |
| PCI slot 2 | | U0.2-P1-I2 | 60-60 or 60-60 to 60-67 or 6C-XX | I/O planar J4, 32 bit slot | PCI Controller 5 |
| PCI slot 3 | | U0.2-P1-I3 | 60-68 or 60-68 to 60-6F or 6D-XX | I/O planar J5, 32 bit slot | PCI Controller 5 |
| PCI slot 4 | | U0.2-P1-I4 | 60-70 or 60-70 to 60-7f or 6E-XX | I/O planar J6, 32 bit slot | PCI Controller 5 |
| PCI Controller 4 | | U0.2-P1 | 00-f8C0-0000 | | |
| PCI slot 5 | | U0.2-P1-I5 | 50-58 or 50-58 to 50-5F or 5B-XX | I/O planar J14, 64 bit slot | PCI Controller 4 |
| PCI slot 6 | | U0.2-P1-I6 | 50-60 or 50-60 to 50-67 or 5C-XX | I/O planar J7, 32 bit slot | PCI Controller 4 |
| PCI slot 7 | | U0.2-P1-I7 | 50-68 or 50-68 to 50-6f or 5D-XX | I/O planar J8, 32 bit slot | PCI Controller 4 |
| PCI slot 8 | | U0.2-P1-I8 | 50-70 or 50-70 to 50-77 or 5E-XX | I/O planar J9, 32 bit slot | PCI Controller 4 |
| PCI Controller 7 | | U0.2-P1 | 00-f8f0-0000 | | |

| FRU Name | Slot Name | Location Code | AIX Location Code | Physical Connection | Logical Connection |
|---|-----------|---------------|---|--|-----------------------|
| PCI Slot 9 | | U0.2-P1-I9 | 80-58 or 80-58 to 80-5f or 8B-XX | I/O planar J15, 64 Bit slot | PCI Con- troller 7 |
| PCI Slot 10 | | U0.2-P1-I10 | 80-60 or 80-60 to 80-67 or 8C-XX | I/O planar J16, 64 Bit slot | PCI Con- troller 7 |
| PCI Controller 6 | | U0.2-P1 | 00-f8e0-0000 | | |
| PCI Slot 11 | | U0.2-P1-I11 | 70-58 or 70-58 to 70-5f or 7B-XX | I/O planar J10, 32 Bit slot | PCI Con- troller 6 |
| PCI Slot 12 | | U0.2-P1-I12 | 70-60 or 70-60 to 70-77 or 7C-XX | I/O planar J11, 32 Bit slot | PCI Con- troller 6 |
| PCI Slot 13 | | U0.2-P1-I13 | 70-68 or 70-68 to 70-6f or 7D-XX | I/O planar J12, 32 Bit slot | PCI Con- troller 6 |
| PCI Slot 14 | | U0.1-P1-I14 | 70-70 or 70-70 to 70-77 or 7E-XX | I/O planar J17, 64 Bit slot | PCI Con- troller 6 |
| Local ASIC control chip | | U0.2-P1 | 70-78 | | |
| Local ASIC control chip | | U0.2-P1 | 70-79 | | |
| RIO 0 Connector | | U0.2-P1/Q1 | | I/O planar, J1 | |
| RIO 1 Connector | | U0.2-P1/Q2 | | I/O planar, J2 | |
| 3/4 Power Supply (7 EIA Unit I/O Drawer) or Right Power Supply (10 EIA Unit I/O Drawer when viewed from rear) | | U0.2-V2 | | Power cable P101-P108 (S70 only) PDB J2 (S7A only) | |

| FRU Name | Slot Name | Location Code | AIX Location Code | Physical Connection | Logical Connection |
|---|------------------|----------------------|--------------------------|--|---------------------------|
| 1/4 Power Supply (7 EIA Unit I/O Drawer) or Left Power Supply (10 EIA Unit I/O Drawer when viewed from rear) | | U0.2-V1 | | Power cable P201, P208 (S70 only) PDB J1 (S7A only) | |
| I/O Drawer Indicator Panel Card (7 EIA Unit I/O Drawer) or I/O Drawer Indicator Panel Card (10 EIA Unit I/O Drawer) | | U0.2-L1 | | I/O planar, J22 (7 EIA Unit I/O Drawer) or I/O Drawer Planar, J19 (10 EIA Unit I/O Drawer) | Cable to I/O planar |
| Fan Monitoring Card | | U0.2-X2 | | | Cable to PDB card |
| I/O Drawer Three Fan Assm. (7 EIA Unit I/O Drawer) | | U0.2-L1-F1 | | I/O Drawer indicator panel card, J2 | |
| I/O Drawer Center Blower (10 EIA Unit I/O Drawer) | | U0.2-F7 | | Fan Monitoring Card J3 | Fan Monitoring Card |
| I/O Drawer Left Blower (10 EIA Unit I/O Drawer) | | U0.1-F5 | | Fan Monitoring Card J2 | Fan Monitoring Card |
| I/O Drawer Right Blower (10 EIA Unit I/O Drawer) | | U0.2-F6 | | Fan Monitoring Card J4 | Fan Monitoring Card |
| I/O Drawer Fan 1 (Left PS, left fan when viewed from rear) (10 EIA Unit I/O Drawer) | | U0.2-F1 | | Fan Monitoring Card J5 | Fan Monitoring Card |

| FRU Name | Slot Name | Location Code | AIX Location Code | Physical Connection | Logical Connection |
|---|-----------|---------------|-------------------|--|---------------------|
| I/O Drawer Fan 2 (Left PS, right fan when viewed from rear) (10 EIA Unit I/O Drawer) | | U0.2-F2 | | Fan Monitoring Card J5 | Fan Monitoring Card |
| I/O Drawer Fan 3 (Right PS, left fan when viewed from rear) (10 EIA Unit I/O Drawer) | | U0.2-F3 | | Fan Monitoring Card J5 | Fan Monitoring Card |
| I/O Drawer Fan 4 (Right PS, right fan when viewed from rear) (10 EIA Unit I/O Drawer) | | U0.2-F4 | | Fan Monitoring Card J5 | Fan Monitoring Card |
| Power Distribution Card (10 EIA Unit I/O Drawer) | | U0.2-X3 | | | J22 to I/O Planar |
| SE/SE SCSI Redrive Card | | U0.2-P2 | | Redrive card connector J1 to power cable | |
| Interface (Bulkhead) Card | | U0.2-P1-Q3 | | I/O planar, J3 | |

| FRU Name | Slot Name | Location Code | AIX Location Code | Physical Connection | Logical Connection |
|---------------------------------|-----------|---------------|---|-----------------------------------|--------------------|
| I/O Drawer 2 Locations | | | | | |
| I/O Drawer 2 (of 0 to 3) | | U0.3 | | | |
| I/O planar | | U0.3-P1 | | | |
| RIO Controller 2 | | U0.3-P1 | 00-00 | | |
| PCI Controller 9 | | U0.3-P1 | 00-f950-0000 | | |
| PCI slot 1 | | U0.3-P1-I1 | A0-58 or A0-58 to A0-5F or AB-XX | I/O planar J13, 64 bit slot | PCI Controller 9 |
| PCI slot 2 | | U0.3-P1-I2 | A0-60 or A0-60 to A0-67 or AC-XX | I/O planar J4, 32 bit slot | PCI Controller 9 |
| PCI slot 3 | | U0.3-P1-I3 | A0-68 or A0-68 to A0-6f or AD-XX | I/O planar J5, 32 bit slot | PCI Controller 9 |
| PCI slot 4 | | U0.3-P1-I4 | A0-70 or A0-70 to A0-77 or AE-XX | I/O planar J6, 32 bit slot | PCI Controller 9 |
| PCI Controller 8 | | U0.3-P1 | 00-f940-0000 | | |
| PCI slot 5 | | U0.3-P1-I5 | 90-58 or 90-58 to 90-5F or 9B-XX | I/O planar J14, 64 bit slot | PCI Controller 8 |
| PCI slot 6 | | U0.3-P1-I6 | 90-60 or 90-60 to 90-67 or 9C-XX | I/O planar J7, 32 bit slot | PCI Controller 8 |
| PCI slot 7 | | U0.3-P1-I7 | 90-68 or 90-68 to 90-6f or 9D-XX | I/O planar J8, 32 bit slot | PCI Controller 8 |
| PCI slot 8 | | U0.3-P1-I8 | 90-70 or 90-70 to 90-77 or 9E-XX | I/O planar J9, 32 bit slot | PCI Controller 8 |
| PCI Controller 11 | | U0.3-P1 | 00-f970-0000 | | |

| FRU Name | Slot Name | Location Code | AIX Location Code | Physical Connection | Logical Connection |
|---|-----------|---------------|---|--|------------------------|
| PCI Slot 9 | | U0.3-P1-I9 | C0-58 or C0-58 to C0-5f or CB-XX | I/O planar J15, 64 Bit slot | PCI Con- troller 9 |
| PCI Slot 10 | | U0.3-P1-I10 | C0-60 or C0-60 to C0-67 or CC-XX | I/O planar J16, 64 Bit slot | PCI Con- troller 9 |
| PCI Controller 10 | | U0.3-P1 | 00-f960-0000 | | |
| PCI Slot 11 | | U0.3-P1-I11 | B0-58 or B0-58 to B0-5f or BB-XX | I/O planar J10, 32 Bit slot | PCI Con- troller 10 |
| PCI Slot 12 | | U0.3-P1-I12 | B0-60 or B0-60 to B0-67 or BC-XX | I/O planar J11, 32 Bit slot | PCI Con- troller 10 |
| PCI Slot 13 | | U0.3-P1-I13 | B0-68 or B0-68 to B0-6f or BD-XX | I/O planar J12, 32 Bit slot | PCI Con- troller 10 |
| PCI Slot 14 | | U0.3-P1-I14 | B0-70 or B0-70 to B0-77 or BE-XX | I/O planar J17, 64 Bit slot | PCI Con- troller 10 |
| Local ASIC Control Chip | | U0.3-P1 | B0-78 | | |
| Local ASIC Control Chip | | U0.3-P1 | B0-79 | | |
| RIO 0 Connector | | U0.3-P1/Q1 | | I/O planar, J1 | |
| RIO 1 Connector | | U0.3-P1/Q2 | | I/O planar, J2 | |
| 3/4 Power Supply (7 EIA Unit I/O Drawer) or Right Power Supply (10 EIA Unit I/O Drawer when viewed from rear) | | U0.3-V2 | | Power Cable P101-P108 (S70 only) PDB J2 (S7A only) | |

| FRU Name | Slot Name | Location Code | AIX Location Code | Physical Connection | Logical Connection |
|---|------------------|----------------------|--------------------------|--|---------------------------|
| 1/4 Power Supply (7 EIA Unit I/O Drawer) or Left Power Supply (10 EIA Unit I/O Drawer when viewed from rear) | | U0.3-V1 | | Power Cable P201, P208 (S70 only) PDB J1 (S7A only) | |
| I/O Drawer Indicator Panel Card (7 EIA Unit I/O Drawer) or I/O Drawer Indicator Panel Card (10 EIA Unit I/O Drawer) | | U0.3-L1 | | I/O planar, J22 (7 EIA Unit I/O Drawer) or I/O Drawer Planar, J19 (10 EIA Unit I/O Drawer) | Cable to I/O planar |
| Fan Monitoring Card | | U0.3-X2 | | | Cable to PDB card |
| I/O Drawer Three Fan Assm. (7 EIA Unit I/O Drawer) | | U0.3-L1-F1 | | I/O Drawer indicator panel card, J2 | |
| I/O Center Blower (10 EIA Unit I/O Drawer) | | U0.3-F7 | | Fan Monitoring Card J3 | Fan Monitoring Card |
| I/O Drawer Left Blower (10 EIA Unit I/O Drawer) | | U0.3-F5 | | Fan Monitoring Card J2 | Fan Monitoring Card |
| I/O Drawer Right Blower (10 EIA Unit I/O Drawer) | | U0.3-F6 | | Fan Monitoring Card J4 | Fan Monitoring Card |
| I/O Drawer Fan 1 (Left PS, left fan when viewed from rear) (10 EIA Unit I/O Drawer) | | U0.3-F1 | | Fan Monitoring Card J5 | Fan Monitoring Card |

| FRU Name | Slot Name | Location Code | AIX Location Code | Physical Connection | Logical Connection |
|---|-----------|---------------|-------------------|--|---------------------|
| I/O Drawer Fan 2 (Left PS, right fan when viewed from rear) (10 EIA Unit I/O Drawer) | | U0.3-F2 | | Fan Monitoring Card J5 | Fan Monitoring Card |
| I/O Drawer Fan 3 (Right PS, left fan when viewed from rear) (10 EIA Unit I/O Drawer) | | U0.3-F3 | | Fan Monitoring Card J5 | Fan Monitoring Card |
| I/O Drawer Fan 4 (Right PS, right fan when viewed from rear) (10 EIA Unit I/O Drawer) | | U0.3-F4 | | Fan Monitoring Card J5 | Fan Monitoring Card |
| Power Distribution Card (10 EIA Unit I/O Drawer) | | U0.3-X3 | | | J22 to I/O Planar |
| SE/SE SCSI Redrive Card | | U0.3-P2 | | Redrive card connector J1 to power cable | |
| Interface (Bulkhead) Card | | U0.3-P1-Q3 | | I/O planar, J3 | |

| FRU Name | Slot Name | Location Code | AIX Location Code | Physical Connection | Logical Connection |
|---------------------------------|-----------|---------------|---|-----------------------------------|--------------------|
| I/O Drawer 3 Locations | | | | | |
| I/O Drawer 3 (of 0 to 3) | | U0.4 | | | |
| I/O planar | | U0.4-P1 | | | |
| RIO Controller 3 | | U0.4-P1 | 00-00 | | |
| PCI Controller 13 | | U0.4-P1 | 00-f9D0-0000 | | |
| PCI slot 1 | | U0.4-P1-I1 | E0-58 or E0-58 to E0-5F or EB-XX | I/O planar J13, 64 bit slot | PCI Controller 13 |
| PCI slot 2 | | U0.4-P1-I2 | E0-60 or E0-60 to E0-67 or EC-XX | I/O planar J4, 32 bit slot | PCI Controller 13 |
| PCI slot 3 | | U0.4-P1-I3 | E0-68 or E0-68 to E0-6f or ED-XX | I/O planar J5, 32 bit slot | PCI Controller 13 |
| PCI slot 4 | | U0.4-P1-I4 | E0-70 or E0-70 to E0-77 or EE-XX | I/O planar J6, 32 bit slot | PCI Controller 13 |
| PCI Controller 12 | | U0.4-P1 | 00-f9c0-0000 | | |
| PCI slot 5 | | U0.4-P1-I5 | D0-58 or D0-58 to D0-5f or DB-XX | I/O planar J14, 64 bit slot | PCI Controller 12 |
| PCI slot 6 | | U0.4-P1-I6 | D0-60 or D0-60 to D0-67 or DC-XX | I/O planar J7, 32 bit | PCI Controller 12 |
| PCI slot 7 | | U0.4-P1-I7 | D0-68 or D0-68 to D0-6f or DD-XX | I/O planar J8, 32 bit | PCI Controller 12 |
| PCI slot 8 | | U0.4-P1-I8 | D0-70 or D0-70 to D0-77 or DE-XX | I/O planar J9, 32 bit | PCI Controller 12 |
| PCI Controller 15 | | U0.4-P1 | 00-f9f0-0000 | | |

| FRU Name | Slot Name | Location Code | AIX Location Code | Physical Connection | Logical Connection |
|--|-----------|---------------|---|--|------------------------|
| PCI Slot 9 | | U0.4-P1-I9 | G0-58 or G0-58 to G0-5f or GB-XX | I/O planar J15, 64 Bit | PCI Con- troller 15 |
| PCI Slot 10 | | U0.4-P1-I10 | G0-60 or G0-60 to G0-67 or GC-XX | I/O planar J16, 64 Bit | PCI Con- troller 15 |
| PCI Controller 14 | | U0.4-P1 | 00-f9E0-0000 | | |
| PCI Slot 11 | | U0.4-P1-I11 | F0-58 or F0-58 to F0-5f or FB-XX | I/O planar J10, 32 Bit | PCI Con- troller 14 |
| PCI Slot 12 | | U0.4-P1-I12 | F0-60 or F0-60 to F0-67 or FC-XX | I/O planar J11, 32 Bit | PCI Con- troller 14 |
| PCI Slot 13 | | U0.4-P1-I13 | F0-68 or F0-68 to F0-6f or FD-XX | I/O planar J12, 32 Bit | PCI Con- troller 14 |
| PCI Slot 14 | | U0.4-P1-I14 | F0-70 or F0-70 to F0-77 or FE-XX | I/O planar J17, 64 Bit | PCI Con- troller 14 |
| Local ASIC control chip | | U0.4-P1 | F0-78 | | PCI Con- troller 14 |
| Local ASIC control chip | | U0.4-P1 | F0-79 | | PCI Con- troller 14 |
| RIO 0 Connector | | U0.4-P1/Q1 | | I/O planar J1 | |
| RIO 1 Connector | | U0.4-P1/Q2 | | I/O planar J2 | |
| 3/4 Power Supply (7 EIA Unit I/O Drawer) or Right Power Supply (10 EIA Unit I/O Drawer when viewed from rear) | | U0.4-V2 | | Power Cable P101-P108 (S70 only) PDB J2 (S7A only) | |

| FRU Name | Slot Name | Location Code | AIX Location Code | Physical Connection | Logical Connection |
|---|------------------|----------------------|--------------------------|--|---------------------------|
| 1/4 Power Supply (7 EIA Unit I/O Drawer) or Left Power Supply (10 EIA Unit I/O Drawer when viewed from rear) | | U0.4-V1 | | Power Cable P201, P208 (S70 only) PDB J1 (S7A only) | |
| I/O Drawer Indicator Panel Card (7 EIA Unit I/O Drawer) or I/O Drawer Indicator Panel Card (10 EIA Unit I/O Drawer) | | U0.4-L1 | | I/O planar, J22 (7 EIA Unit I/O Drawer) or I/O Drawer Planar, J19 (10 EIA Unit I/O Drawer) | Cable to I/O planar |
| Fan Monitoring Card | | U0.4-X2 | | | Cable to PDB card |
| I/O Drawer Three Fan Assm. (7 EIA Unit I/O Drawer) | | U0.4-L1-F1 | | I/O Drawer indicator panel card, J2 | |
| I/O Drawer Center Blower (10 EIA Unit I/O Drawer) | | U0.4-F7 | | Fan Monitoring Card J3 | Fan Monitoring Card |
| I/O Drawer Left Blower (10 EIA Unit I/O Drawer) | | U0.4-F5 | | Fan Monitoring Card J2 | Fan Monitoring Card |
| I/O Drawer Right Blower (10 EIA Unit I/O Drawer) | | U0.4-F6 | | Fan Monitoring Card J4 | Fan Monitoring Card |
| I/O Drawer Fan 1 (Left PS, left fan when viewed from rear) (10 EIA Unit I/O Drawer) | | U0.4-F1 | | Fan Monitoring Card J5 | Fan Monitoring Card |

| FRU Name | Slot Name | Location Code | AIX Location Code | Physical Connection | Logical Connection |
|---|-----------|---------------|-------------------|--|---------------------|
| I/O Drawer Fan 2 (Left PS, right fan when viewed from rear) (10 EIA Unit I/O Drawer) | | U0.4-F2 | | Fan Monitoring Card J5 | Fan Monitoring Card |
| I/O Drawer Fan 3 (Right PS, left fan when viewed from rear) (10 EIA Unit I/O Drawer) | | U0.4-F3 | | Fan Monitoring Card J5 | Fan Monitoring Card |
| I/O Drawer Fan 4 (Right PS, right fan when viewed from rear) (10 EIA Unit I/O Drawer) | | U0.4-F4 | | Fan Monitoring Card J5 | Fan Monitoring Card |
| Power Distribution Card (10 EIA Unit I/O Drawer) | | U0.4-X3 | | | J22 to I/O Planar |
| SE/SE SCSI Redrive Card | | U0.4-P2 | | Redrive card connector J1 to power cable | |
| Interface (Bulkhead) Card | | U0.4-P1-Q3 | | I/O planar, J3 | |

Chapter 6. Introduction to Tasks and Service Aids

The AIX Diagnostic Package contains programs that are called Tasks. Tasks can be thought of as "performing a specific function on a resource"; for example, running diagnostics, or performing a service aid on a resource. This chapter describes the Tasks available in AIX Diagnostics Version 4.2 and later.

Note: Many of these programs work on all system model architectures. Some programs are only accessible from Online Diagnostics in Service or Concurrent mode, others may be accessible only from Standalone Diagnostics. While still other programs may only be supported on a particular system architecture, such as CHRP (Common Hardware Reference platform).

To perform a Task, use the Task Selection option from from the FUNCTION SELECTION Menu:

Once a task is selected, a resource menu may be presented showing all resources supported by the task.

A fast path method is also available to perform a task by using the **diag** command and the **-T** flag. This means the user does not have to go through most of the introductory menus just to get to a particular task. Instead, the user is presented with a list of resources available to support the specified task. The current fast path tasks are:

- Certify - certifies media
- Chkspares - checks for the availability of spare sectors
- Download - downloads microcode to an adapter or device
- Disp_mcode _ displays current level of microcode
- Format - formats media
- Identify - identifies the PCI RAID physical disks.

To run these tasks directly from the command line, specify the resource and other task unique flags. Use the descriptions in this chapter to understand which flags are needed for a given task.

Tasks

The following tasks are described in this chapter.

- Add Resource to Resource List
- AIX Shell Prompt
- Analyze Adapter Internal Log
- Backup and Restore Media
- Certify Media
- Change Hardware Vital Product Data
- Configure Dials and LPFKeys
- Configure Reboot Policy
- Configure Remote Maintenance Policy
- Configure Ring Indicate Power On Policy
- Configure Surveillance Policy
- Create Customized Configuration Diskette
- Delete Resource from Resource List
- Disk Maintenance
- Display Configuration and Resource List
- Display Firmware Device Node Information
- Display Hardware Error Report
- Display Hardware Vital Product Data
- Display Machine Check Error Log
- Display Microcode Level
- Display or Change Bootlist
- Display or Change Diagnostic Run Time Options
- Display Previous Diagnostic Results
- Display Resource Attributes
- Display Service Hints
- Display Software Product Data
- Display System Environmental Sensors
- Display Test Patterns
- Download Microcode
- Fibre Channel RAID Service Aids
- Flash SK-NET FDDI Firmware
- Format Media
- Generic Microcode Download
- Local Area Network Analyzer
- Periodic Diagnostics
- PCI RAID Physical Disk Identify
- Process Supplemental Media
- Run Diagnostics
- Run Error Log Analysis
- Run Exercisers

- Save or Restore Hardware Management Policies
- SCSI Bus Analyzer
- SCSI Device Identification and Removal
- SCSD Tape Drive Service Aids
- Spare Sector Availability
- SSA Service Aid
- Update Disk Based Diagnostics
- Update System or Service Processor Flash
- 7135 RAIDiant Array Service Aids
- 7318 Serial Communication Network Server

Add Resource to Resource List

Use this task to add resources back to the resource list.

Note: Only resources that were previously detected by the diagnostics and deleted from the Diagnostic Test List are listed. If no resources are available to be added, then none are listed.

AIX Shell Prompt

Note: Use in Online Service Mode only.

This service aid allows access to the AIX command line. To use this service aid the user must know the root password (when a root password has been established).

Note: Do not use this task to install code, or change the configuration of the system. This task is intended to view files, configuration records, and data. Changing the system configuration or installing code with this service aid may produce unexplained system problems after exiting the diagnostics.

Analyze Adapter Internal Log

The PCI RAID adapter has an internal log that logs information about the adapter and the disk drives attached to the adapter. Whenever data is logged in the internal log, the device driver copies the entries to the AIX system error log and clears the internal log.

The Analyze Adapter Internal Log service aid analyzes these entries in the AIX system error log. The service aid displays the errors and the associated service actions. Entries that do not require any service actions are ignored.

Backup and Restore Media

This service aid allows verification of backup media and devices. It presents a menu of tape and diskette devices available for testing and prompts for selection of the desired device. It then presents a menu of available backup formats and prompts for selection of the desired format. The supported formats are tar, backup, and cpio. After the device and format are selected, the service aid backs up a known file to the selected device, restores that file to /tmp, and compares the original file to the restored file. The restored file is also left in /tmp to allow for visual comparison. All errors are reported.

Certify Media

This task allows the selection of diskette or hardfiles to be certified.

Hardfiles can be connected either to a SCSI adapter (non-RAID) or a PCI SCSI RAID adapter. The usage and criteria for a hardfile connected to a non-RAID SCSI adapter are different from those for a hardfile connected to a PCI SCSI RAID adapter.

- **Certify Diskette**

This selection provides a way to verify the data written on a diskette. When this service aid is selected, a menu asks you to select the type of diskette being verified. The program then reads all of the ID and data fields on the diskette one time and displays the total number of bad sectors found.

- **Certify Hardfile Attached to a Non-RAID SCSI Adapter**

This selection reads all of the ID and data fields. It checks for bad data and counts all errors encountered. If the unrecovered data errors exceed the threshold value, the hardfile needs to be formatted and certified. If the recovered data errors, recovered and unrecovered equipment errors exceed the threshold values, the disk needs to be replaced.

This task may be run directly from the AIX command line. The following usage statement describes the syntax of the command:

Usage:

```
diag -c -d <deviceName> -T "certify"
```

- **Certify Hardfile attached to a PCI SCSI RAID Adapter**

This selection is used to certify physical disks attached to a PCI SCSI RAID adapter. Certify reads the entire disk and checks for recovered errors, unrecovered errors and reassigned errors. If these errors exceed the threshold values, the user is prompted to replace the physical disk.

This task may be run directly from the AIX command line. The following usage statement describes the syntax of the command:

Usage:

```
diag -c -d < RAID adapterName > -T "certify {-l < chID > | -A}"
```

| Flag | Description |
|-------------|--|
| -l | Physical Disk channel/ID (example: 27) |
| -A | All disks. |

Change Hardware Vital Product Data

Use this service aid to display the Display/Alter VPD Selection Menu. The menu lists all resources installed on the system. When a resource is selected a menu is displayed that lists all the VPD for that resource.

Note: The user cannot alter the VPD for a specific resource unless it is not machine readable.

Configure Dials and LPFKeys

This service aid provides a tool for configuring and removing dials/LPFKeys to the asynchronous serial ports.

Since version 4.1.3 a TTY must be defined on the async port before the Dials and LPFKeys can be configured on the port. Before version 4.2 the Dials and LPFKeys could only be configured on the standard serial ports. At version 4.2 the Dials and LPFKeys can be configured on any async port.

This selection invokes the SMIT utility to allow Dials and LPFKeys configuration. A TTY must be in the available state on the async port before the Dials and LPFKeys can be configured on the port. The task allows an async adapter to be configured, then a TTY port defined on the adapter, and then Dials and LPFKeys can be defined on the port.

Configure Reboot Policy

This service aid controls how the system tries to recover from a system crash.

Use this service aid to display and change the following settings for the Reboot Policy.

Note: Because of system capability, some of the following settings may not be displayed by this service aid.

- Maximum Number of Reboot Attempts

Enter a number that is 0 or greater.

Note: A value of 0 indicates 'do not attempt to reboot' to a crashed system.

This number is the maximum number of consecutive attempts to reboot the system. The term "reboot", in the context of this service aid, is used to describe bringing system hardware back up from scratch, for example from a system reset or power on.

When the reboot process completes successfully, the reboot attempts count is reset to 0, and a "restart" begins. The term "restart", in the context of this service aid, is used to describe the operating system activation process. Restart always follows a successful reboot.

When a restart fails, and a restart policy is enabled, the system attempts to reboot for the maximum number of attempts.

- Use the O/S Defined Restart Policy (1=Yes, 0=No)

When 'Use the O/S Defined Restart Policy' is set to Yes, the system attempts to reboot from a crash if the operating system has an enabled Defined Restart or Reboot Policy.

When 'Use the O/S Defined Restart Policy' is set to No, or the operating system restart policy is undefined, then the restart policy is determined by the 'Supplemental Restart Policy'.

- Enable Supplemental Restart Policy (1=Yes, 0=No)

The 'Supplemental Restart Policy', if enabled, is used when the O/S Defined Restart Policy is undefined, or is set to False.

When surveillance detects operating system inactivity during restart, an enabled 'Supplemental Restart Policy' causes a system reset and the reboot process begins.

- Call-Out Before Restart (on/off)

When enabled, Call-Out Before Restart allows the system to call out (on a serial port that is enabled for call out) when an operating system restart is initiated. Such calls can be valuable if the number of these events becomes excessive, thus signalling bigger problems.

- Enable Unattended Start Mode (1=Yes, 0=No)

When enabled, 'Unattended Start Mode' allows the system to recover from the loss of AC power.

If the system was powered-on when the AC loss occurred, the system reboots when power is restored. If the system was powered-off when the AC loss occurred, the system remains off when power is restored.

This service aid may be accessed directly from the AIX command line, by entering:
`/usr/lpp/diagnostics/bin/uspchrp -b`

Configure Remote Maintenance Policy

Note: Runs on CHRP systems units only.

The Remote Maintenance Policy includes modem configurations and phone numbers to use for remote maintenance support.

Use this service aid to display and change the following settings for the Remote Maintenance Policy.

Note: Because of system capability, some of the following settings may not be displayed by this service aid.

- Configuration File for Modem on S1
Configuration File for Modem on S2

Enter the name of a modem configuration file to load on either serial port 1 (S1) or serial port 2 (S2). The modem configuration files are located in the directory **/usr/share/modems**. If a modem file is already loaded, it is showed by 'Modem file currently loaded'.

- Modem file currently loaded on S1
Modem file currently loaded on S2

This is the name of the file that is currently loaded on serial port 1 or serial port 2.

Note: These settings are only shown when a modem file is loaded for a serial port.

- Call In Authorized on S1 (on/off)
Call In Authorized on S2 (on/off)

Call In allows the Service Processor to receive a call from a remote terminal.

- Call Out Authorized on S1 (on/off)
Call Out Authorized on S2 (on/off)

Call Out allows the Service Processor to place calls for maintenance.

- S1 Line Speed
S2 Line Speed

A list of line speeds is available by using 'List' on the screen.

- Service Center Phone Number

This is the number of the service center computer. The service center usually includes a computer that takes calls from systems with call-out capability. This computer is referred to as "the catcher". The catcher expects messages in a specific format to which the Service Processor conforms. For more information about the format and catcher computers, refer to the README file in the AIX

/usr/samples/syscatch directory. Contact the service provider for the correct telephone number to enter here.

- Customer Administration Center Phone Number

This is the number of the System Administration Center computer (catcher) that receives problem calls from systems. Contact the system administrator for the correct telephone number to enter here.

- Digital Pager Phone Number In Event of Emergency

This is the number for a pager carried by someone who responds to problem calls from your system.

- Customer Voice Phone Number

This is the number for a telephone near the system, or answered by someone responsible for the system. This is the telephone number left on the pager for callback.

- Customer System Phone Number

This is the number to which your system's modem is connected. The service or administration center representatives need this number to make direct contact with your system for problem investigation. This is also referred to as the Call In phone number.

- Customer Account Number

This number could be used by a service provider for record keeping and billing.

- Call Out Policy Numbers to call if failure

This is set to either 'first' or 'all'. If the call out policy is set to 'first', call out stops at the first successful call to one of the following numbers in the order listed:

1. Service Center
2. Customer Admin Center
3. Pager

If Call Out Policy is set to 'all', call out attempts to call all of the following numbers in the order listed:

1. Service Center
2. Customer Admin Center
3. Pager

- Customer RETAIN Login ID
Customer RETAIN Login Password

These settings apply to the RETAIN service function.

- Remote Timeout, in seconds

Remote Latency, in seconds

These settings are functions of the service provider's catcher computer.

- Number of Retries While Busy

This is the number of times the system should retry calls that resulted in busy signals.

- System Name (System Administrator Aid)

This is the name given to the system and is used when reporting problem messages.

Note: Knowing the system name aids the support team quickly identify the location, configuration, history, etc. of your system.

This service aid may be accessed directly from the AIX command line, by entering:

```
/usr/lpp/diagnostics/bin/uspchrp -m
```

Configure Ring Indicate Power On Policy

This service aid allows the user to power on a system by telephone from a remote location. If the system is powered off, and Ring Indicate Power On is enabled, the system powers on at a predetermined number of rings. If the system is already on, no action is taken. In either case, the telephone call is not answered and the caller receives no feedback that the system has powered on.

Use this service aid to display and change the following settings for the Ring Indicate Power On Policy.

Note: Because of system capability, some of the following settings may not be displayed by this service aid.

- Power On Via Ring Indicate (on/off)
- Number of Rings Before Power On

This service aid may be accessed directly from the AIX command line, by entering:

```
/usr/lpp/diagnostics/bin/uspchrp -r
```

Configure Surveillance Policy

Note: Runs on CHRP systems units only.

This service aid monitors the system for hang conditions, that is, hardware or software failures that cause operating system inactivity. When enabled, and surveillance detects operating system inactivity, a call is placed to report the failure.

Use this service aid to display and change the following settings for the Surveillance Policy.

Note: Because of system capability, some of the following settings may not be displayed by this service aid.

- Surveillance (on/off)
- Surveillance Time Interval
This is the maximum time between heartbeats from the operating system.
- Surveillance Time Delay
This is the time to delay between when the operating system is in control and when to begin operating system surveillance.
- Changes are to take affect immediately
Set this to Yes if the changes made to the settings in this menu are to take place immediately. Otherwise the changes takes place beginning with the next system boot.

This service aid may be accessed directly from the AIX command line, by entering:
`/usr/lpp/diagnostics/bin/uspchrp -s`

Create Customized Configuration Diskette

This selection invokes the Diagnostic Package Utility Service Aid which allows the user to perform the following action:

- Create a Standalone Diagnostic Package Configuration Diskette

The Standalone Diagnostic Package Configuration Diskette allows the following to be changed from the console:

- Default refresh rate for a LFT

The refresh rate used by the standalone diagnostic package is 60Hz. If the display's refresh rate is 77Hz, then set the refresh rate to 77.

- Different async terminal console

A console configuration file that allows a terminal attached to any RS232 or RS422 adapter to be selected as a console device can be created using this service aid. The default device is a RS232 TTY attached to the first standard serial port (S1).

Delete Resource from Resource List

Use this task to delete resources from the resource list.

Note: Only resources that were previously detected by the diagnostics and have not been deleted from the Diagnostic Test List are listed. If no resources are available to be deleted, then none are listed.

Disk Maintenance

- Disk to Disk Copy
- Display/Alter Sector

Disk to Disk Copy

Notes:

1. This service aid cannot be used to update to a different size drive. The service aid only supports copying from a SCSI drive to another SCSI drive of similar size.
2. Use the **migratepv** command when copying the contents to other disk drive types. This command also works when copying SCSI disk drives or when copying to a different size SCSI disk drive. Refer to *System Management Guide: Operating System and Devices* for a procedure on migrating the contents of a physical volume.

This selection allows you to recover data from an old drive when replacing it with a new drive. The service aid recovers all LVM software reassigned blocks. To prevent corrupted data from being copied to the new drive, the service aid aborts if an unrecoverable read error is detected. To help prevent possible problems with the new drive, the service aid aborts if the number of bad blocks being reassigned reaches a threshold.

The procedure for using this service aid requires that both the old and new disks be installed in or attached to the system with unique SCSI addresses. This requires that the new disk drive SCSI address must be set to an address that is not currently in use and the drive be installed in an empty location. If there are no empty locations, then one of the other drives must be removed. Once the copy is complete, only one drive may remain installed. Either remove the target drive to return to the original configuration, or perform the following procedure to complete the replacement of the old drive with the new drive.

1. Remove both drives.
2. Set the SCSI address of the new drive to the SCSI address of the old drive.
3. Install the new drive in the old drive's location.

4. Install any other drives that were removed into their original location.

To prevent problems that may occur when running this service aid from disk, it is suggested that this service aid be run from the diagnostics that are loaded from removable media when possible.

Display/Alter Sector

This selection allows the user to display and alter information on a disk sector. Care must be used when using this service aid because inappropriate modification to some disk sectors may result in total loss of all data on the disk. Sectors are addressed by their decimal sector number. Data is displayed both in hex and in ASCII. To prevent corrupted data from being incorrectly corrected, the service aid does not display information that cannot be read correctly.

Display Configuration and Resource List

This service aid displays the item header only for all installed resources. Use this service aid when there is no need of seeing the VPD. (No VPD is displayed.)

Display Firmware Device Node Information

This task displays the firmware device node information that appears on CHRP platforms. The format of the output data may not be the same between different levels of AIX. It is intended to gather more information about individual or particular devices on the system.

Display Hardware Error Report

This service aid provides a tool for viewing the hardware error log. It uses the **errpt** command.

The Display Error Summary and Display Error Detail selection provide the same type of report as the **errpt** command. The Display Error Analysis Summary and Display Error Analysis Detail selection provide additional analysis.

Display Hardware Vital Product Data

This service aid displays all installed resources along with any VPD for those resources. Use this service aid when you want to look at the VPD for a specific resource.

Display Machine Check Error Log

Note: The Machine Check Error Log Service Aid is available only on Standalone Diagnostics.

When a machine check occurs, information is collected and logged in a NVRAM error log before the system unit shuts down. This information is logged in the AIX error log and cleared from NVRAM when the system is rebooted from the hard disk, LAN, or standalone media. When booting from Standalone Diagnostics, this service aid can take the logged information and turn it into a readable format that can be used to isolate the problem. When booting from the hard disk or LAN, the information can be viewed from the AIX error log using the Hardware Error Report Service Aid. In either case the information is analyzed when running the **sysplanar0** diagnostics in Problem Determination Mode.

Display Microcode Level

The following usage statements describe the syntax of the command to display the current level of micorcode on an adapter or device.

Usage:

```
diag -c -d <device_name> -T "disp_mcode"
```

Display or Change Bootlist

This service aid allows the bootlist to be displayed, altered, or erased.

The system attempts to perform an IPL from the first device in the list. If the device is not a valid IPL device or if the IPL fails, the system proceeds in turn to the other devices in the list to attempt an IPL.

Display or Change Diagnostic Run Time Options

The Display or Change Diagnostic Run Time Options task allows the diagnostic run time options to be set.

Note: The run time options are used only when selecting the Run Diagnostic task.

The run time options are:

- Display Diagnostic Mode Selection Menus

This option allows the user to turn on or off displaying the DIAGNOSTIC MODE SELECTION MENU (the default is on).

- Run Tests Multiple Times

This option allows the user to turn on or off running the diagnostic in loop mode (the default is off).

Note: This option is only displayed when running Online Diagnostics in Service Mode.

- Include Advanced Diagnostics

This option allows the user to turn on or off including the Advanced Diagnostics (the default is off).

- Include Error Log Analysis

This option allows the user to turn on or off including the Error Log Analysis (ELA) (the default is off).

- Number of Days Used to Search Error Log

This option allows the user to select the number of days to search the AIX error log for errors when running the Error Log Analysis. The default is seven days, but can be changed from one to sixty days.

- Display Progress Indicators

This option allows the user to turn on or off the progress indicators when running the Diagnostic Applications. The progress indicators are a popup box at the bottom of the screen indicating the test being run (the default is on).

- Save Changes to the Database

This option allows the user to save any changes made to the run-time options. Without saving the changes, any changes made are only applicable to that session of diagnostics (the default is no).

Display Previous Diagnostic Results

Note: This service aid is only available when you load the diagnostics from a disk drive or a network. However, on a CHRP system, this service aid is available when you the diagnostics in standalone mode because the results are stored in NVRAM.

Each time the diagnostics produce a service request number (SRN) to report a problem, information about that problem is logged. The service representative can look at this log to see which SRNs are recorded. This log also records the results of diagnostic tests that are run in loop mode.

When this service aid is selected, information on the last problem logged is displayed. The arrow keys can be used to look at information about previous problems.

The ASCII version of the Diagnostics Log is available in the `/etc/lpp/diagnostics/data/*.dat` files.

Display Resource Attributes

This task displays the Customized Device Attributes associated with a selected resource. This task is similar to running the `lsattr -E -l <resource>` command.

Display Service Hints

This service aid reads and displays the information in the CEReadME file from the diagnostics media. This file contains information that is not in the publications for this version of the diagnostics. It also contains information about using this particular version of diagnostics.

Use the arrow keys to scroll through the information in the file.

Display Software Product Data

This task invokes SMIT to display information about the installed software and provides the following functions:

- List Installed Software
 - List Applied but Not Committed Software Updates
 - Show Software Installation History
 - Show Fix (APAR) Installation Status
 - List Fileset Requisites
 - List Fileset Dependents
 - List Files Included in a Fileset
 - List File Owner by Fileset
-

Display System Environmental Sensors

This service aid displays the environmental sensors implemented on a CHRP system. The information displayed is the sensor name, physical location code, literal value of the sensor status, and the literal value of the sensor reading.

The sensor status can be any one of the following:

- Normal - The sensor reading is within the normal operating range.
- Critical High - The sensor reading indicates a serious problem with the device. Run diagnostics on `sysplanar0` to determine what repair action is needed.

- **Critical Low** - The sensor reading indicates a serious problem with the device. Run diagnostics on `sysplanar0` to determine what repair action is needed.
- **Warning High** - The sensor reading indicates a problem with the device. This could become a critical problem if action is not taken. Run diagnostics on `sysplanar0` to determine what repair action is needed.
- **Warning Low** - The sensor reading indicates a problem with the device. This could become a critical problem if action is not taken. Run diagnostics on `sysplanar0` to determine what repair action is needed.
- **Hardware Error** - The sensor could not be read because of a hardware error. Run diagnostics on `sysplanar0` in problem determination mode to determine what repair action is needed.
- **Hardware Busy** - The system has repeatedly returned a busy indication, and a reading is not available. Try the service aid again. If the problem continues, run diagnostics, on `sysplanar0` in problem determination mode to determine what repair action is needed.

This service aid can also be run as a command. The command can be used to list the sensors and their values in a text format, list the sensors and their values in numerical format, or a specific sensor can be queried to return either the sensor status or sensor value.

The command can be run by entering one of the following:

```
/usr/lpp/diagnostics/bin/uesensor -l | -a
/usr/lpp/diagnostics/bin/uesensor -t <token> -i <index> [-v]
```

Flags

- l** List the sensors and their values in a text format.
- a** List the sensors and their values in a numerical format. For each sensor, the following numerical values are displayed as:

```
<token> <index> <status> <measured value> <location code>
```
- t token** Specifies the sensor token to query.
- i index** Specifies the sensor index to query.
- v** Indicates to return the sensor measured value. The sensor status is returned by default.

Examples

1. Display a list of the environmental sensors:

```
/usr/lpp/diagnostics/bin/uesensor -l
```

```
Sensor = Fan Speed
```

```
Status = Normal
```

Value = 2436 RPM

Location Code = F1

Sensor = Power Supply

Status = Normal

Value = Present and operational

Location Code = V1

Sensor = Power Supply

*Status = Critical low

Value = Present and not operational

Location Code = V2

2. Display a list of the environmental sensors in a numerical list:

```
/usr/lpp/diagnostics/bin/uesensor -a
```

```
3 0 11 87 P1
```

```
9001 0 11 2345 F1
```

```
9004 0 11 2 V1
```

```
9004 1 9 2 V2
```

3. Return the status of sensor 9004, index 1:

```
/usr/lpp/diagnostics/bin/uesensor -t 9004 -i 1
```

```
9
```

4. Return the value of sensor 9004, index 1:

```
/usr/lpp/diagnostics/bin/uesensor -t 9004 -i 1 -v
```

```
2
```

Display Test Patterns

This service aid provides a means of adjusting system display units by providing displayable test patterns. Through a series of menus the user selects the display type and test pattern. After the selections are made the test pattern is displayed.

Download Microcode

This service aid provides a way to copy microcode to an adapter or device. The service aid presents a list of adapters and devices that use microcode. After the adapter or device is selected, the service aid provides menus to guide you in checking the current level and downloading the needed microcode.

This task may be run directly from the AIX command line. The following usage statements guide you for a particular type of adapter or device. See the flag descriptions to complete the AIX command.

Download Microcode to PCI SCSI RAID Adapter

The following usage statements describe the syntax of the command for a PCI SCSI RAID Adapter:

Usage:

```
diag -c -d <RAID adapterName> -T "download [-B] [-D] [-P]"
```

| Flag | Description |
|------|--|
| -B | Download boot block microcode (default to functional microcode). |
| -D | Microcode is on diskette (default to /etc/microcode directory). |
| -P | Download the previous level of microcode (default to latest level). |

Download Microcode to Disk Drive Attached to a PCI SCSI RAID Adapter

The following usage statements describe the syntax of the command for a disk drive attached to a PCI SCSI RAID Adapter.

Usage:

```
diag -c -d <RAID adapterName> -T "download {-l <chID> | -A} [-D] [-P]"
```

| Flag | Description |
|------|--|
| -A | All disk drives. |
| -D | Microcode is on diskette (default to /etc/microcode directory). |
| -l | RAID disk drive—physical disk channel/ID (example 27). |
| -P | Download the previous level of microcode (default to latest level). |

Download Microcode to a PCI FC-AL Adapter

The following usage statements describe the syntax of the command for a PCI FC-AL Adapter.

Usage:

```
diag -c -d <device_name> -T "download [-s {diskette|disk}]  
[-f <file_name>]"
```

| Flag | Description |
|------|--|
| -d | System name for the adapter or device (example fcs0). |
| -f | File name on the source device. (Disk source must have complete path from root directory.) |
| -s | microcode source. /etc/microcode is default. Default source device is disk. |

Download Microcode to Other Devices

The following usage statements describe the syntax of the command:

Usage:

```
diag -c -d <device_name> -T "download [-s diskette] [-l previous] [-F]"
```

| Flag | Description |
|------|-------------|
|------|-------------|

- | | |
|-----------|---|
| -F | Force flag. Required to download microcode if the current level is unavailable on the source. |
| -l | Microcode level. Latest is default. |
| -s | microcode source. /etc/microcode is default. Default source device is disk. |

Fibre Channel RAID Service Aids

The Fibre Channel RAID service aids contain the following functions:

Certify LUN

This selection reads and checks each block of data in the LUN. If excessive errors are encountered the user is notified.

You can run this task from the AIX command line. The following usage statement describes the syntax of the fastpath command:

```
Usage: diag -T "certify"
```

Certify Spare Physical Disk

This selection allows the user to certify (check integrity of the data) on drives designated as spares.

You can run this task from the AIX command line. The following usage statement describes the syntax of the fastpath command:

```
Usage: diag -T "certify"
```

Format Physical Disk

This selection is used to format a selected disk drive.

You can run this task from the AIX command line. The following usage statement describes the syntax of the fastpath command:

```
Usage: diag -T "format"
```

Array Controller Microcode Download

This selection allows the microcode on the Fibre Channel RAID controller to be updated when required.

You can run this task from the AIX command line. The following usage statement describes the syntax of the fastpath command:

Usage: diag -T "download"

Physical Disk Microcode Download

This selection is used to update the microcode on any of the disk drives in the array.

You can run this task from the AIX command line. The following usage statement describes the syntax of the fastpath command:

Usage: diag -T "download"

Update EEPROM

This selection is used to update the contents of the EEPROM on a selected controller.

Replace Controller

Use this selection when it is necessary to replace a controller in the array.

Flash SK-NET FDDI Firmware

This task allows the Flash firmware on the SysKonnnect SK-NET FDDI adapter to be updated.

Format Media

This task allows the selection of diskettes, hardfiles, or optical media to be formatted. Each selection is described below.

Hardfile Attached to SCSI Adapter (non-RAID)

- Hardfile Format

Writes all of the disk. The pattern put on the disk is device dependent, i.e. some drives may put all 0s, while some may put hexadecimal number 5F. No bad block reassignment occurs

- Hardfile Format and Certify

Does the same function as Format. After the format is completed, Certify is run. This certify reassigns all bad blocks encountered.

- Hardfile Erase Disk

This option can be used to overwrite (remove) all data currently stored in user-accessible blocks of the disk. The Erase Disk option writes one or more patterns to the disk. An additional option allows data in a selectable block to be read and displayed on the system console.

To use the Erase Disk option, specify the number (0-3) of patterns to be written. Select the patterns to be written; the patterns are written serially. That is, the first pattern is written to all blocks. Then the next pattern is written to all blocks, overlaying the previous pattern. A random pattern is written by selecting the "Write random pattern?" option.

Note: The Erase Disk service aid has not been certified as meeting the Department of Defense or any other organizations security guidelines.

The following steps should be followed if the data on the drive is to be overwritten:

1. Use the "Erase Disk" selection to overwrite the data on the drive.
2. Do a format without certify.
3. Run a second pass of the erase disk selection.

For a newly installed drive, you can insure that all blocks on the drive are overwritten with your pattern if you use the following procedure:

1. Format the drive.
2. Check the defect MAP by running the Erase Disk selection.

Note: If you use the "Format and Certify" option, there may be some blocks which get placed into the grown defect MAP.

3. If there are bad blocks in the defect MAP, record the information presented and ensure that this information is kept with the drive. This data is used later when the drive is to be overwritten.
4. Use the drive as you would normally.
5. When the drive is no longer needed and is to be erased, run the same version of the Erase Disk selection which was used in step 2.

Note: Using the same version of the service aid is only critical if there were any bad blocks found in step 3.

6. Compare the bad blocks which were recorded with the drive in step 3 with those which now appear in the grown defect MAP.

Note: If there are differences between the saved data and the newly obtained data, then all sectors on this drive cannot be overwritten. The new bad blocks are not overwritten.

7. If the bad block list is the same, continue running the service aid to overwrite the disk with the chosen pattern(s).

This task may be run directly from the AIX command line. The following usage statement describes the syntax of the command:

Usage:

```
diag -c -d <deviceName> -T "format [-s* fmtcert | erase -a {read | write}]  
[-F]"
```

Flags

| | |
|----------------|---|
| fmtcert | Formats and certifies the disk. |
| * | Available in no-console mode only. |
| -F | Force flag. Forces disk erasure even if all blocks cannot be erased due to errors accessing grown defect map. |

Note: Erase option in command line mode uses default values. To selectively read or write, use diag in console mode.

Hardfile Attached to PCI SCSI RAID Adapter

This function formats the physical disks attached to a PCI SCSI RAID adapter. This task may be run directly from the AIX command line. The following usage statement describes the syntax of the command:

Usage:

```
diag -c -d <RAID adapterName> -T "format {-l <chId> | -A }"
```

| Flag | Description |
|-------------|--|
| -l | Physical disk channel/ID - (An example of physical disk channel/ID is 27, where the channel is 2 and the ID is 7.) |
| -A | All disks |

Optical Media

- Optical Media Initialize

Formats the media without certifying. This function does not reassign the defective blocks or erase the data on the media. It provides a quick way of formatting the media and cleaning the disk.

Note: It takes approximately 1 minute to format the media.

- Optical Media Format and Certify

Formats and certifies the media. This function reassigns the defective blocks and erases all data on the media.

This task may be run directly from the AIX command line. The following usage statement describes the syntax of the command:

Usage:

```
diag -c -d <deviceName> -T "format [-s {initialize | fmtcert} ]"
```

| Option | Description |
|--------|-------------|
|--------|-------------|

| | |
|-------------------|-----------------------------------|
| initialize | Formats media without certifying. |
|-------------------|-----------------------------------|

| | |
|----------------|----------------------------------|
| fmtcert | formats and certifies the media. |
|----------------|----------------------------------|

Diskette Format

This selection formats a diskette by writing patterns to it.

Generic Microcode Download

This service aid provides a means of executing a "generic" script from a diskette. The intended purpose for this "generic" script is to load microcode to a supported resource. This script is responsible for executing whatever program is required in order to download the microcode onto the adapter or device.

This service aid is supported in both concurrent and standalone modes from disk, LAN, or loadable media.

On entry, the service aid displays information about what it does. It then asks for a Genucode diskette to be inserted into the diskette drive. The diskette must be in tar format. The service aid then restores the script file **genucode** to the **/tmp** directory. Then the script is executed. The script must at that point then pull off any other needed files from the diskette. The script should then exec whatever program is necessary in order to perform its function. On completion, a status code is returned, and the user is returned to the service aid. The **genucode** script should have a **# ! /usr/bin/ksh** line at the beginning of the file. Return status of 0 should be returned if the program was successful, else a non-zero status should be returned.

Local Area Network Analyzer

This selection is used to exercise the LAN communications adapters (Token-Ring, Ethernet, and (FDDI) Fiber Distributed Data Interface). The following services are available:

- Connectivity testing between two network stations. Data is transferred between the two stations. This requires the user to input the Internet Addresses of both stations.
- Monitoring ring (Token-Ring only). The ring is monitored for a period of time. Soft and hard errors are analyzed.

Periodic Diagnostics

This selection provides a tool for configuring periodic diagnostics and automatic error log analysis. A hardware resource can be chosen to be tested once a day, at a user specified time. If the resource cannot be tested because it is busy, error log analysis is performed. Hardware errors logged against a resource can also be monitored by enabling Automatic Error Log Analysis. This allows error log analysis to be performed every time a hardware error is put into the error log. If a problem is detected, a message is posted to the system console and a mail message sent to the user(s) belonging to the system group with information about the failure such as Service Request Number.

The service aid provides the following functions:

- Add or delete a resource to the periodic test list
- Modify the time to test a resource
- Display the periodic test list
- Modify the error notification mailing list
- Disable or Enable Automatic Error Log Analysis

PCI RAID Physical Disk Identify

This selection identifies physical disks connected to a PCI SCSI-2 F/W RAID adapter.

This task may be run directly from the AIX command line. The following usage statement describes the syntax of the command:

Usage

```
diag -c -d < pci RAID adapter > -T identify
```

Process Supplemental Media

Diagnostic Supplemental Media contains all the necessary diagnostic programs and files required to test a particular resource. The supplemental is normally released and shipped with the resource as indicated on the diskette label. Diagnostic Supplemental Media must be used when the device support has not been incorporated into the latest diagnostic CD-ROM.

This task processes the Diagnostic Supplemental Media. Insert the supplemental media when prompted, then press Enter. After processing has occurred, go to the Resource Selection list to find the resource to test.

Notes:

- This task is supported in Standalone Diagnostics only.
- Process and test one resource at a time.
- Do not process multiple supplementals at a time.

Run Diagnostics

The Run Diagnostics task invokes the Resource Selection List menu. When the commit key is pressed, Diagnostics are run on all selected resources.

The procedures for running the diagnostics depends on the state of the diagnostics run time options. The run time options are:

- **Display Diagnostic Mode Selection Menus**
If this option is on, the Diagnostic Mode Selection Menu is displayed when the commit key is pressed.
- **Include Advanced Diagnostics**
If this option is on, Advanced Diagnostics is included.
- **Include Error Log Analysis**
If this option is on, Error Log Analysis is included.
- **Run Tests Multiple Times**
If this option is on, diagnostic are run in loop mode. This option is only valid when running Online Diagnostics in Service Mode.

Run Error Log Analysis

The Run Error Log Analysis task invokes the Resource Selection List menu. When the commit key is pressed, Error Log Analysis is run on all selected resources.

Run Exercisers

Note: The Run Exercisers task is only supported in Online Maintenance Mode on CHRP systems.

This task provides a tool to troubleshoot intermittent system problems on AIX Release 4.3.2 or later. This task provides an exerciser supervisor that controls the selected exercisers.

When you select Run Exercisers from the Task Selection menu, the EXERCISER SELECTION menu displays. Select the exerciser you want to run from this menu. Each exerciser has other menus to set options for the exerciser.

Exerciser Commands (CMD)

Use the following commands as needed in the exerciser menus and reports. Not all commands are available in each menu or report.

| CMD | Description |
|------------|--|
| a | Acknowledge an error. |
| b | Back one page. |
| c | Toggle between cycle count and last error. |
| e | View the AIX error log. |
| f | Page forward one page. |
| q | Return to Main Menu. |
| r | Refresh screen. |
| s | Enable or disable beep on error. |
| x | Exit system exerciser. |

Acronyms

The following list describes acronyms used in the exerciser reports.

To toggle between two states (example Activate/Halt Devices), use the number of the device.

| Acronym | Description |
|----------------|---|
| COE | Continue on error (use number to select). |
| CP | Device has run the specified number of cycles and is not running. |
| DD | The exerciser has been terminated by a signal. |

| | |
|------------|---------------------------------------|
| ER | Device has stopped with an error. |
| HG | The device is hung. |
| HOE | Halt on error (use number to select). |
| RN | Device is running. |
| ST | Device is stopped. |

Memory Exerciser

The memory exercisers are labeled memx, where x is a number for the exerciser. Multiple exercisers can be active.

The memory exerciser requests as many memory buffers as possible from AIX. The exerciser then fills the memory buffers with specified bit patterns, then reads and compares the memory buffers to the specified bit patterns.

On systems with multiple processors a process is started for each processor. The free memory space is split evenly between the available processors thus reducing the time required to exercise all of the memory.

If the system is working properly, there will be no compare errors. If a non-recoverable memory error occurs, the system will crash. Recoverable memory errors are logged by the AIX operating system.

The following items must be available to run this service aid:

- On-line diagnostics loaded in maintenance mode
- 128KB of free space in **/etc/lpp/diagnostics/data**
- The following commands must be available:
 - **vmstat**
 - **lsps**
 - **bootinfo**

Save or Restore Hardware Management Policies

Use this service aid to save or restore the settings from Ring Indicate Power On Policy, Surveillance Policy, Remote Maintenance Policy and Reboot Policy.

- Save Hardware Management Policies

This selection writes all of the settings for the hardware management policies to the file:

`/etc/lpp/diagnostics/data/hmpolicies`

- Restore Hardware Management Policies

This selection restores all of the settings for the hardware management policies from the contents of the file:

```
/etc/lpp/diagnostics/data/hmpolicies
```

This service aid may be accessed directly from the AIX command line, by entering:

```
/usr/lpp/diagnostics/bin/uspchrp -a
```

SCSI Bus Analyzer

This service aid provides a means to diagnose a SCSI Bus problem in a free-lance mode.

To use this service aid, the user should have an understanding of how a SCSI Bus works. This service aid should be used when the diagnostics cannot communicate with anything on the SCSI Bus and cannot isolate the problem. Normally the procedure for finding a problem on the SCSI Bus with this service aid is to start with a single device attached, ensure that it is working, then start adding additional devices and cables to the bus ensuring that each one works. This service aid works with any valid SCSI Bus configuration.

The SCSI Bus Service Aid transmits a SCSI Inquiry command to a selectable SCSI Address. The service aid then waits for a response. If no response is received within a defined amount of time, the service aid displays a timeout message. If an error occurs or a response is received, the service aid then displays one of the following messages:

- The service aid transmitted a SCSI Inquiry Command and received a valid response back without any errors being detected.
- The service aid transmitted a SCSI Inquiry Command and did not receive any response or error status back.
- The service aid transmitted a SCSI Inquiry Command and the adapter indicated a SCSI bus error.
- The service aid transmitted a SCSI Inquiry Command and an adapter error occurred.
- The service aid transmitted a SCSI Inquiry Command and a check condition occur.

When the SCSI Bus Service Aid is entered a description of the service aid is displayed.

Pressing the Enter key displays the Adapter Selection menu. This menu allows the user to enter which address to transmit the SCSI Inquiry Command.

When the adapter is selected the SCSI Bus Address Selection menu is displayed. This menu allows the user to enter which address to transmit the SCSI Inquiry Command.

Once the address is selected the SCSI Bus Test Run menu is displayed. This menu allows the user to transmit the SCSI Inquiry Command by pressing the Enter key. The service aid then indicates the status of the transmission. When the transmission is completed, the results of the transmission are displayed.

Notes:

- A Check Condition can be returned when there is nothing wrong with the bus or device.
- AIX does not allow the command to be sent if the device is in use by another process.

SCSI Device Identification and Removal

This service aid allows the user to choose a SCSI device or location from a menu and to identify a device located in a system unit that uses a SCSI Enclosure Services (SES) backplane.

The service aid also does the following:

- Generates a menu displaying all SCSI devices.
- Lists the device and all of its sibling devices.
- List all SCSI adapters and their ports.
- List all SCSI devices on a port.

SCSD Tape Drive Service Aid

This service aid provides a means to obtain the status or maintenance information from a SCSD tape drive. Only some models of SCSI tape drive are supported.

The service aid provides the following options:

- Display time since a tape drive was last cleaned.

The time since the drive was last cleaned is displayed onto the screen. In addition, a message whether the drive is recommended to be cleaned is also displayed.

- Copy a tape drive's trace table.

The trace table of the tape drive is written to diskettes or a file. The diskettes must be formatted for DOS. Writing the trace table may require several diskettes.

The actual number of diskettes is determined by the size of the trace table. Label the diskettes as follows:

'TRACE[x].DAT' (where 'x' is a sequential diskette number. The complete trace table consists of the sequential concatenation of all the diskette data files.

When the trace table is written to a disk file, the service aid prompts for a file name. The default name is: '/tmp/TRACE.<x>', where x is the AIX name of the SCSD tape drive being tested.

- Display or copy a tape drive's log sense information.

The service aid provides options to display the log sense information to the screen, to copy it to a DOS formatted diskette or to copy it to a file. The file name "LOGSENSE.DAT" is used when the log sense data is written on the diskette. The service aid prompts for a file name when the log sense data is chosen to be copied to a file.

This service aid may be run directly from the AIX command line. The following usage statement describes the syntax of the command (path is /usr/lpp/diagnostics/bin/utape):

Usage:

```
utape [-h | -?] [-d <device>] [-n | -l | -t]
```

or

```
utape -c -d <device> [-v] {-n | {-l | -t} { -D | -f [<filename>]}}
```

| Flag | Description |
|--------|--|
| -c | Run the service aid without displaying menus. The return code indicates success or failure. The output is suppressed except for the usage statement and the numeric value for hours since cleaned (if -n and -D flags are used). |
| -D | Copy data to diskette. |
| -f | Copy data to the filename given after this flag or to a default filename if no name is specified. |
| -h, -? | Display a usage statement and/or return code. If the -c flag is present, only the return code displays to indicate the service aid did not run. If the -c isn't used, a usage statement displays and the service aid exits. |
| -l | Display or copy log sense information. |
| -n | Display time since drive was last cleaned. |
| -t | Copy trace table. |

- v** Verbose mode. If the `-c` flag is present, the information displays on the screen. If the `-n` flag is present, the information about tape head cleaning is printed.

Spare Sector Availability

This selection checks the number of spare sectors available on the optical disk. The spare sectors are used to reassign when defective sectors are encountered during normal usage or during a format and certify operation. Low availability of spare sectors shows that the disk needs to be backed up and replaced. Formatting the disk does not improve the availability of spare sectors.

This task may be run directly from the AIX command line. The following usage statement describes the syntax of the command:

Usage:

```
diag -c -d < deviceName > -T chkspares
```

SSA Service Aids

This service aid provides tools for diagnosing and resolving problems on SSA attached devices. The following tools are provided:

- Set Service Mode
- Link Verification
- Configuration Verification
- Format and Certify Disk

Update Disk Based Diagnostics

This service aid allows fixes (APARs) to be applied.

This task invokes the SMIT Update Software by Fix (APAR) task. The task allows the input device and APARs to be selected. Any APAR can be installed using this task.

Update System or Service Processor Flash

This selection updates the system or service processor flash for CHRP system units.

Further update and recovery instructions may be provided with the update. It is necessary to know the fully qualified path and file name of the flash update image file

that was provided. If the flash update image file is on a diskette, the service aid can list the files on the diskette for selection.

Refer to the update instructions, or the system unit's service guide to determine the level of the system unit or service processor flash.

When run from online diagnostics, the flash update image file is copied to the **/var** file system. If there is not enough space in the **/var** file system for the flash update image file, an error is reported. If this occurs, exit the service aid, increase the size of the **/var** file system and retry the service aid. After the file is copied, a warning screen asks for confirmation to continue the update flash. Continuing the update flash reboots the system. The system does not return to diagnostics. The current flash image is not saved. After the reboot, the **/var/update_flash_image** can be removed.

When running from standalone diagnostics, the flash update image file is copied to the file system from diskette. The user needs to provide the image on a diskette since the user does not have access to remote file systems or any other files that are on the system. If enough space is not available, an error is reported stating additional system memory is needed. After the file is copied, a warning screen asks for confirmation to continue the update flash. Continuing the update flash reboots the system. The current flash image is not saved.

The **update_flash** command can be used in place of this service aid. It is located in the **/usr/lpp/diagnostics/bin** directory.

Attention: The **update_flash** command reboots the entire system. Do not use this command if more than one user is signed onto the system.

7135 RAIDiant Array Service Aid

The 7135 RAIDiant Array service aids contain the following functions:

- Certify LUN

This selection reads and checks each block of data in the LUN. If excessive errors are encountered the user is notified.

- Certify Spare Physical Disk

This selection allows the user to certify (check the integrity of the data) on drives designated as spares.

- Format Physical Disk

This selection is used to format a selected disk drive.

- Array Controller Microcode Download

This selection allows the microcode on the 7135 controller to be updated when required.

- Physical Disk Microcode Download

This selection is used to update the microcode on any of the disk drives in the array.

- Update EEPROM

This selection is used to update the contents of the EEPROM on a selected controller.

- Replace Controller

Use this selection when it is necessary to replace a controller in the array.

Adapter Microcode Download

Usage:

```
diag -c -d <device name> -T"download [-B] [-D] [-P]"
```

Flags

- B** Download boot block microcode (default to functional microcode)
- D** Microcode is on diskette (default to /etc/microcode directory)
- P** Download the previous level of microcode (default to latest level)

Physical Disk Microcode Download

```
Usage: diag -c -d <deviceName> -T "download -l <ChId> [-D] [-P]"
```

- l** Physical disk channel/ID (i.e. 27)
- D** Microcode is on diskette (default to /etc/microcode directory)
- P** Download the previous level of microcode (default to latest level)

Physical Disk Format

```
Usage: diag -c -d <deviceName> -T "format -l <ChId>"
```

- l** Physical disk channel/ID (i.e. 27)

Physical Disk Certify

```
Usage: diag -c -d <deviceName> -T "certify -l <ChId>"
```

- l** Physical disk channel/ID (i.e. 23)

Physical Disk Identify

Usage: `diag -c -d <deviceName> -T "identify"`

7318 Serial Communications Network Server Service Aid

This service aid provides a tool for diagnosing terminal server problems.

Chapter 7. Using the System Verification Procedure

The system verification procedure is used to check the system for correct operation.

When you are analyzing a hardware problem, you should use Chapter 8 on page 8-1.

Step 1. Considerations before Running This Procedure:

Notes:

1. If this system unit is directly attached to another system unit or attached to a network, be sure communications with the other system unit is stopped.
2. This procedure requires use of all of the system resources. No other activity can be running on the system while you are doing this procedure.
 - This procedure requires a display connected to the video port or an ASCII terminal attached to the S1 port.
 - Before starting this procedure, you should stop all programs and the operating system.
 - This procedure runs the Online Diagnostics in Service mode or Standalone Diagnostics. If the Online Diagnostics are installed, they should be run. See the operator manual for your type of ASCII terminal to find the key sequences you need in order to respond to the diagnostics.
 - If you need more information about diagnostics see Chapter 5 on page 5-1.
 - If a console display is not selected, the diagnostics stop. The instructions for selecting a console display are displayed on all of the graphic displays and any terminal attached to the S1 port. Follow the displayed instructions to select a console display.
 - Go to Step 2.

Step 2. Loading the Diagnostics:

1. Stop all application programs running on the operating system.
2. Stop the operating system.
3. Turn the power off.
4. If you are loading the Standalone Diagnostics and running them from an ASCII terminal:
 - The attributes for the terminal must be set to match the defaults of the diagnostics.
 - If you need to change any settings, record the normal settings, and be sure the terminal attributes are set to work with the diagnostics. If needed, see “Running the Diagnostics from a TTY Terminal” on page 5-3.
 - Return to substep 5 when you finish checking the attributes.
5. Turn the power on.
 - a. When the keyboard indicator appears, press F5 on the direct attached keyboard (5 on the ASCII keyboard) to load the Standalone Diagnostics or F6 on the directly-attached keyboard (6 on the ASCII terminal keyboard) to load the Online Diagnostics.
 - b. Enter any requested passwords.
 - c. Follow any instructions to select a console.
6. When the Diagnostic Operating Instructions display, go to Step 3. If you are unable to load the diagnostics, go to “Problem Determination When Unable to Load Diagnostics” on page 8-11.

Step 3. Running System Verification:

The Diagnostic Operating Instructions should be displayed.

1. Press the Enter key.
2. If the terminal type has not been defined, you must use the `Initialize Terminal` option on the Function Selection menu to initialize the operating system environment before you can continue with the diagnostics.
3. If you want to do a general checkout without much operator action, Select the `Diagnostic Routines` option on the Function Selection menu.

If you want to do a more complete checkout including the use of wrap plugs, select the `Advanced Diagnostics` option on the Function Selection menu. The advanced diagnostics are primarily for the service representative; they may instruct you to install wrap plugs to better isolate a problem.

4. Select the `System Verification` option on the Diagnostic Mode Selection menu.
5. If you want to run a general checkout of all installed resources, Select the `All Resource` option on the Diagnostic Selection menu.

If you want to check one particular resource, select that resource on the Diagnostic Selection menu.

6. Go to Step 4.

Step 4. Additional System Verification:

The checkout programs end with either the `Testing Complete` menu and a message stating `No trouble was found` or the `A Problem Was Detected On (Time Stamp)` menu with an SRN.

1. Press Enter to return to the Diagnostic Selection menu.
2. If you want to check other resources, select the resource. When you have checked all of the resources you need to check, go to Step 5.

Step 5. Stopping the Diagnostics:

1. If running Online diagnostics, the system first should be shut down using the following procedure:
 - a. Press F3 repeatedly until you get to the Diagnostic Operating Instructions, then follow the displayed instructions.
 - b. Press F3 once, and then follow the displayed instructions to shut down system.
2. If you changed any attributes on your ASCII terminal to run the diagnostics, change the settings back to normal.
3. This completes the system verification. Report the SRN to the service organization if you received one. To do a normal boot, turn off the system unit and wait 30 seconds, and then set the power switch of the system unit to On.

Chapter 8. Hardware Problem Determination

This chapter provides information on using Standalone or Online Diagnostics. In addition, it also provides a list of error codes and recommended actions the user can perform to resolve the problem before contacting a service representative.

The manufacturer recommends that systems configured with 4GB of memory or greater have access to a 4mm or 8mm tape drive for submission of system dump information if required. This function may be accomplished through locally attached or network attached devices as appropriate.

Problem Determination Using the Standalone or Online Diagnostics

Use this procedure to obtain a service request number (SRN) when you are able to load the Standalone or Online Diagnostics. If you are unable to load the Standalone or Online Diagnostics, go to “Problem Determination When Unable to Load Diagnostics” on page 8-11. The service organization uses the SRN to determine which field replaceable units (FRUs) are needed to restore the system to correct operation.

Step 1. Considerations before Running This Procedure:

Note: See the operator manual for your ASCII terminal to find the key sequences you need to respond to the diagnostic programs.

- The diagnostics can use a display connected to a display adapter with the keyboard and mouse connected to the primary I/O Drawer or an ASCII terminal attached to a serial port.
- This procedure asks you to select the type of diagnostics you want to run. If you need more information about the types, see “Standalone and Online Diagnostics Operating Considerations” on page 5-1.
- Go to “Step 2.”

Step 2:

Are the Online Diagnostics installed on this system?

NO Go to “Step 15.”
YES Go to “Step 3.”

Step 3:

Determine if the operating system is accepting commands.

Is the operating system accepting commands?

- NO** The system must be turned off in order to run diagnostics.
1. Verify with the system administration and users that the system may be turned off. If so, then turn off the system unit and go to "Step 6."
- YES** Go to "Step 4."
-

Step 4:

Diagnostic tests can be run on many resources while the operating system is running. However, more extensive problem isolation is obtained by running Online Diagnostics in Service mode.

Do you want to run the Online Diagnostics in Service mode?

- NO** Go to "Step 5."
- YES** Do the following to shut down your system:
1. At the system prompt, stop the operating system using the proper command for your operating system. For AIX systems, use the shutdown -F command.
 2. After the operating system is stopped, power off the system unit. See "Powering Off the System" on page 2-2.
 3. Go to "Step 6."

Step 5:

This step invokes the Online Diagnostics in concurrent mode.

1. Log on as root or as superuser.
2. Enter the diag command.
3. Wait until the Diagnostic Operating Instructions are displayed, or wait for three minutes.

Are the Diagnostic Operating Instructions displayed without any obvious console display problems?

NO Do the following to shut down your system:

1. At the system prompt, stop the operating system using the proper command for your operating system. For AIX systems, use the shutdown -F command.
2. After the operating system is stopped, power off the system unit. See "Powering Off the System" on page 2-2.
3. Go to "Step 6."

YES Go to "Step 9."

Step 6:

This step loads Online Diagnostics in service mode. If you are unable to load the diagnostics, go to “Step 7.”

1. Turn the power on.
2. When the keyboard indicator (icon or text) appears, press F6 on the directly-attached keyboard or 6 on the ASCII terminal keyboard to indicate that diagnostics are to be loaded.
3. Enter any requested passwords.
4. Follow any instructions to select a console.

Did the Diagnostics Operating Instructions display without any obvious display problem?

NO Go to “Step 7.”
YES Go to “Step 9.”

Step 7:

Starting at the top of the following table, find your symptom and follow the instructions given in the Action column.

| Symptom | Action |
|---------------------|--|
| Display problem. | Go to “Step 8.” |
| All other symptoms. | Go to “Problem Determination When Unable to Load Diagnostics” on page 8-11 |

Step 8:

The following steps analyze a console display problem.

Find your type of console display in the following table, then follow the instructions given in the Action column.

| Console Display | Action |
|------------------------|--|
| Display Device | Go to the display documentation for problem determination. |
| ASCII terminal | Go to the documentation for problem determination for this type of terminal. |

Step 9:

The diagnostics loaded correctly.

Press the Enter key.

Is the Function Selection menu displayed?

NO Go to "Step 10."

YES Go to "Step 11."

Step 10:

There is a problem with the keyboard.

Find the type of keyboard you are using in the following table, then follow the instructions given in the Action column.

| Keyboard Type | Action |
|---|--|
| 101-key keyboard. Identify by the type of Enter key used. The Enter key is within one horizontal row of keys. | Record error code M0KBD001 and report the problem to the service organization. |
| 102-key keyboard. Identify by the type of Enter key used. The Enter key extends into two horizontal rows of keys. | Record error code M0KBD002 and report the problem to the service organization. |
| Kanji keyboard. Identify by the Japanese characters. | Record error code M0KBD003 and report the problem to the service organization. |
| ASCII-terminal keyboard. This applies to all attached terminals. | Go to the documentation for problem determination for this type terminal. |

Step 11:

1. If the terminal type has not been defined, you must use the `Initialize Terminal` option on the Function Selection menu to initialize the operating system environment before you can continue with the diagnostics. This is a separate and different operation than selecting the console display.
2. Select Diagnostic Routines.
3. Press the Enter key.
4. In the following table, find the menu or system response you received when you selected `Diagnostics`. Follow the instructions given in the Action column.

| System Response | Action |
|--|--|
| The Diagnostic Mode Selection menu is displayed. | Select Problem Determination and go to "Step 12." |
| The Missing Resource menu is displayed. | Follow the displayed instructions until either the Diagnostic Mode Selection menu or an SRN is displayed. If the Diagnostic Mode Selection menu is displayed, select Problem Determination and go to "Step 12." If you get an SRN, record it, and go to "Step 14." |
| The New Resource menu is displayed. | Follow the displayed instructions. Note: Devices attached to serial ports S1 or S2 will not appear on the New Resource menu. If the Diagnostic Mode Selection menu is displayed, select Problem Determination and go to "Step 12." If you get an SRN, record it, and go to "Step 14." If you do not get an SRN, go to "Step 17." |
| The system does not respond to selecting diagnostics | Go to "Step 10." |

Step 12:

Did the Diagnostic Selection Menu display?

- NO** If Problem Determination was selected from the Diagnostic Mode Selection menu, and if a recent error has been logged in the error log, the diagnostics automatically begin testing the resource.
- Follow the displayed instructions.
- If the No Trouble Found screen is displayed, press Enter.
- If another resource is tested, repeat this step.
- If the Diagnostic Selection menu is displayed, go to “Step 13.”
- If an SRN is displayed, record it, and go to “Step 14.”
- YES** Go to “Step 13.”
-

Step 13:

The All Resources option checks most of the configured adapters and devices.

Select and run the diagnostic tests on the resources you are having problems with or select the All Resources option check all of the configured resources. Find the response in the following table and take the Action for it.

| Diagnostic Response | Action |
|--|--|
| An SRN is displayed. | Go to “Step 14.” |
| The system hangs. | Report SRN 109-200. |
| The Testing Complete menu and the No trouble was found message is displayed, and you have not tested all of the resources. | Press Enter and continue with the testing. |
| The Testing Complete menu and the No trouble was found message displayed and you have tested all of the resources. | Go to “Step 17.” |

Step 14:

The diagnostics produced an SRN for this problem.

1. Record the SRN and other numbers read out.
 2. Report the SRN to the service organization.
 3. **STOP.** You have completed these procedures.
-

Step 15:

When you are loading the Standalone Diagnostics, the attributes for the terminal must be set to match the defaults of the diagnostic programs. The ASCII terminal must be attached to serial port 1 on the system unit.

Are you going to load Standalone Diagnostics and run them from a ASCII terminal?

NO

Go to "Step 16."

YES

Go to "Running the Diagnostics from a TTY Terminal" on page 5-3 and be sure your terminal attributes are set to work with the diagnostic programs.

Return to "Step 16" when you finish checking the attributes. Record any settings that are changed.

Step 16:

This step loads the Standalone Diagnostics. If you are unable to load the diagnostics, go to “Step 7.”

1. Turn the power on.
2. Insert the diagnostic CD-ROM into the CD-ROM drive in the primary I/O Drawer.
3. When the keyboard indicator appears, press F5 on the direct attached keyboard or 5 on the ASCII keyboard to indicate that diagnostics are to be loaded.
4. Enter any requested passwords.
5. Follow any instructions to select a console.

Did the Diagnostics Operating Instructions display without any obvious display problem?

NO Go to “Step 7.”
YES Go to “Step 9.”

Step 17:

The diagnostics did not find a hardware problem. If you still have a problem, contact your software support center.

Problem Determination When Unable to Load Diagnostics

Use this procedure to obtain an error code. The service organization uses the error code to determine which field replaceable units (FRUs) are needed to restore the system to correct operation.

Step 1. Considerations before Running This Procedure:

- The diagnostics can use a display connected to a display adapter with the keyboard and mouse connected to the primary I/O Drawer or an ASCII terminal attached to a serial port.
 - Go to “Step 2.”
-

Step 2:

Are the Online Diagnostics installed on this system?

NO Go to “Step 4.”
YES Go to “Step 3.”

Step 3:

This step attempts to load Online Diagnostics in service mode.

1. Turn the power off.
2. Turn the power on.
3. If the keyboard indicator appears, press F6 on the direct attached keyboard or 6 on the ASCII keyboard to indicate that diagnostics are to be loaded.
4. Enter any requested passwords.
5. Follow any instructions to select a console.
6. Wait until the diagnostics load or the system appears to stop.

Did the diagnostics load?

NO Go to "Step 5."
YES Go to "Step 6."

Step 4:

This step attempts to load the Standalone diagnostics.

1. Turn the power off.
2. Turn the power on.
3. Insert the diagnostic CD-ROM into the CD-ROM drive.
4. If the keyboard indicator appears, press F5 on the direct attached keyboard or 5 on the ASCII keyboard to indicate that diagnostics are to be loaded.
5. Enter any requested passwords.
6. Follow any instructions to select a console.
7. Wait until the diagnostics load or the system appears to stop.

Did the diagnostics load?

NO Go to "Step 5."
YES Go to "Step 6."

Step 5:

Starting at the top of the following table, find your symptom and follow the instructions given in the Action column.

| Symptom | Action |
|--|---|
| The operator panel power LED does not come on, or comes on and does not stay on. | <p>Check the power cable to the outlet. Check the circuit breakers and check for power at the outlet.</p> <p>Assure the room temperature is within 60 - 90°F.</p> <p>If you do not find a problem, record error code M0PS0000 and report the problem to the service organization.</p> |
| The system stops with the Diagnostic Operating Instructions displayed. | Go to "Step 6." |
| The system stops with a prompt to enter a password. | Enter the password. You are not be allowed to continue until a correct password has been entered. When you have entered a valid password, wait for one of the other conditions to occur. |
| The system stops with a three, four or eight-digit error code(s) displayed on the console. | Refer to "Error Codes" on page 8-16 and see if your error code is listed. If it is, perform the recommended action. If the error code is not listed, report the error code to your service representative. |
| The system login prompt is displayed. | <p>You may not have pressed the correct key or you may not have pressed the key soon enough when you were to indicate a Service Mode boot of diagnostic programs. If this was the case, start over at the beginning of this step.</p> <p>If you are sure you pressed the correct key in a timely manner go to Step 7.</p> |
| The system does not respond when the password is entered. | Go to Step 7. |

| Symptom | Action |
|---|---|
| <p>The system stopped and an indicator is displayed on the system console and an eight-digit error code is not displayed.</p> | <p>If the indicator (text or icon) represents:</p> <ul style="list-style-type: none"> • a keyboard, record error code M0KBD000 and report the problem to the service organization. • memory, record error code M0MEM002 and report the problem to the service organization. • SCSI, record error code M0CON000 and report the problem to the service organization. • Network, record error code M0NET000 and report the problem to the service organization. • Speaker/Audio, record error code M0BT0000 and report the problem to the service organization. |
| <p>The System Management Services menu is displayed.</p> | <p>The device or media you are attempting to boot from may be faulty.</p> <ol style="list-style-type: none"> 1. Check the SMS error log for any errors. To check the error log: <ul style="list-style-type: none"> • Choose tools • Choose error log • If an error is logged, check the time stamp. • If the error was logged during the current boot attempt, record it and report it to your service person. • If no recent error is logged in the error log, continue to the next step below. 2. If you are attempting to load the Online Diagnostics, try loading the Standalone Diagnostics. Otherwise, record error code M0SCSI00 and report to the service organization. |
| <p>The system stops and the message "STARTING SOFTWARE PLEASE WAIT ..." is displayed.</p> | <p>Report error code M0BT0001.</p> |
| <p>The message "The system will now continue the boot process" is displayed continuously on the system unit's console.</p> | <p>Report error code M0SCSI01.</p> |

Step 6:

The diagnostics loaded correctly.

Go to “Problem Determination Using the Standalone or Online Diagnostics” on page 8-1.

Step 7:

There is a problem with the keyboard.

Find the type of keyboard you are using in the following table, then follow the instructions given in the Action column.

| Keyboard Type | Action |
|---|--|
| 101-key keyboard. Identify by the type of Enter key used. The Enter key is within one horizontal row of keys. | Record error code MOKBD001 and report the problem to the service organization. |
| 102-key keyboard. Identify by the type of Enter key used. The Enter key extends into two horizontal rows of keys. | Record error code MOKBD002 and report the problem to the service organization. |
| Kanji keyboard. Identify by the Japanese characters. | Record error code MOKBD003 and report the problem to the service organization. |
| ASCII-terminal keyboard. This applies to all attached terminals. | Go to the documentation for problem determination for this type terminal. |

Error Codes

The following table lists error codes that you may encounter, and the actions to perform to correct the reported error.

| <i>Table 8-1 (Page 1 of 5). Firmware Error Codes.</i> | | |
|---|--|---|
| Error Code | Description | Action |
| 20A80000 | Insufficient information to boot. | Verify the IP address. |
| 20A80001 | Client IP address is already in use by other network device | Change IP address. |
| 20A80005 | File transmission (TFTP) failed. | Check network connection, try again. |
| 20E00001 | Privileged-access password entry error. | The password has been entered incorrectly. Retry installing the password. |
| 20E00009 | Invalid password entered - system locked | The password has been entered incorrectly 3 times. Turn off, then turn on the system unit, then enter the password correctly. |
| 20EE0003 | IP parameter requires 3 dots "." | Enter valid IP parameter. Example: 000.000.000.000 |
| 20EE0004 | Invalid IP parameter | Enter valid IP parameter. Example: 000.000.000.000 |
| 20EE0005 | Invalid IP parameter (>255) | Enter valid IP parameter. Example: 255.192.002.000 |
| 20EE0007 | Keyboard not found | Plug in keyboard. |
| 20EE0008 | No configurable adapters found in the system | This warning occurs when the selected SMS function cannot locate any devices/adapters supported by the function. If a supported device is installed, contact your service representative. |
| 20EE000B | The system was not able to find an operating system on the device list that was attempted. | Modify the Boot Sequence (also known as boot list) to include devices that are known to contain a copy of the Operating System. This can be accomplished by using the System Management Services Menus. For example, select a hard disk known to have a copy of the Operating System as the first and only device in the boot sequence (boot list) and attempt to boot again. |

Table 8-1 (Page 2 of 5). Firmware Error Codes.

| Error Code | Description | Action |
|------------|---|---|
| 20EE000C | Pointer to the operating system found in non-volatile storage. | <p>Values normally found in non-volatile storage that point to the location of an Operating System were not found. This can happen for two reasons, either your installed Operating System doesn't support storing the values or some event occurred that caused the system to lose non-volatile storage information (drainage or replacement of the battery). If you are running AIX, this information can be reconstructed by running the bootlist command specifying the device that the Operating System is installed on. Please refer to your AIX documentation for the exact syntax and usage of the bootlist command.</p> <p>In order to boot the Operating System so that the above mentioned values can be reconstructed, power the system down and power it back up again, this should cause the system to look for the Operating System in the devices contained in the custom boot list or in the default boot list, depending on the condition of the system. If this is not successful, modify the Boot Sequence (also known as boot list) to include devices that are known to contain a copy of the Operating System. This can be accomplished by using the System Management Services Menus. For example, select a hard disk known to have a copy of the Operating System as the first and only device in the boot sequence (boot list) and attempt to boot again.</p> |
| 25A80001 | Init-nvram invoked, ALL of NVRAM initialized | Errors reported against NVRAM can be caused by low battery voltage and (more rarely) power outages that occur during normal usage. These errors are generally warnings that the NVRAM data content had to be re-established, and do not require any further action unless the error is persistent. When one of these errors occurs, any system customization (for example, boot device list) information may have been lost. The system may need to be reconfigured. Call your service representative if the problem is persistent. |
| 25A80002 | Init-nvram invoked, some data partitions may have been preserved. | Refer to Action under error code 25A80001. |
| 25A80011 | Data corruption detected, ALL of NVRAM initialized | Refer to Action under error code 25A80001. |
| 25A80012 | Data corruption detected, some data partitions may have been preserved. | Refer to Action under error code 25A80001. |

Table 8-1 (Page 3 of 5). Firmware Error Codes.

| Error Code | Description | Action |
|------------|--|---|
| 25A80100 | NVRAM data validation check failed. | Turn off, turn on system unit and retry the operation before replacing any system component. Refer to Action under error code 25A80001. |
| 25A80210 | Setenv/\$Setenv parameter error - name contains a null character. | Refer to Action under error code 25A80001. |
| 25A80211 | Setenv/\$Setenv parameter error - value contains a null character. | Refer to Action under error code 25A80001. |
| 25A80998 | NVRAMRC script evaluation error - command line execution error | <p>Execution of a command line within the nvram configuration variable "nvramrc" (script) resulted in a "throw" being executed. This script can be modified by the system firmware SMS utilities, the operating system, PCI adapter rom code or utility, or an operator (via the open firmware script editing command "nvedit"). It may not be possible to resolve the problem without a detailed analysis of the nvram script, the current system configuration, and device tree contents.</p> <ol style="list-style-type: none"> 1. The problem can be caused by a SCSI adapter, whose SCSI bus ID has been changed from the default setting, no longer appearing in the system. This can be caused either by removing a SCSI adapter, or a problem with a SCSI adapter. <ol style="list-style-type: none"> a. Select the "SCSI ID" utility from the SMS menu(s). <ol style="list-style-type: none"> 1. Verify the list of SCSI controllers/adapters. If the list is not correct, suspect a problem with the adapter(s) installed but not listed. 2. Select the option to "Save" the configuration information. 3. Restart the system. b. If the problem persists, boot the operating system and verify the SCSI bus IDs of any installed/available SCSI controllers (change as necessary), and restart the system. 2. Contact your service support representative for further assistance. |

Table 8-1 (Page 4 of 5). Firmware Error Codes.

| Error Code | Description | Action |
|------------|---|---|
| 28030001 | RTC not updating - RTC initialization required | <p>Errors reported against the Real Time Clock can be caused by low Battery voltage and (more rarely) power outages that occur during normal system usage. These errors are warnings that the Real Time Clock data content needs to be re-established and do not require any FRU replacement unless the error is persistent. When one of these errors occurs, the Time and Date information has been lost.</p> <ul style="list-style-type: none"> To set/restore the Time and Date, use the Operating System facility. <p>If the error is persistent, contact your service representative.</p> |
| 28030002 | Bad time/date values | Set/restore Time and Date using the Operating System. |
| 28030004 | RTC operating mode parameters (eg. data mode) changed | <ol style="list-style-type: none"> Set Time and Date. Refer to Action under error code 28030002. |
| 2BA00013 | Service processor reports bad NVRAM CRC | If problem persists, contact your service representative. |
| 40B00000 | Operating system surveillance interval exceeded. | <ol style="list-style-type: none"> Surveillance mode control is from the Service Processor(SP) Menus. Verify that the Operating System (OS) Heartbeat Utility is installed and has been activated. Check for errors or unusual conditions that might prevent the OS from reporting Heartbeat messages; such as system dump, machine check or checkstop error. Review the error logs. If the problem persists, call the support center for assistance. |
| 4B00F00F | Call Home fault | <p>Check for:</p> <ol style="list-style-type: none"> Remote system problem Telephone line problem |
| 4B00F109 | Modem on serial port 1 failed to configure | Check modem power and modem connections |
| 4B00F10A | Modem on serial port 2 failed to configure | Check modem power and modem connections |
| 4B00F10F | Modem not detected | Check modem power and modem connections |

Table 8-1 (Page 5 of 5). Firmware Error Codes.

| Error Code | Description | Action |
|-------------------|-------------------------------------|---|
| 4B00F110 | Call to Service Center failed | Check for: <ol style="list-style-type: none">1. Remote system problem2. Telephone line problem3. Remote host problem |
| 4B00F111 | Call to System Administrator failed | Check for: <ol style="list-style-type: none">1. Remote system problem2. Telephone line problem3. Remote host problem |
| 4B00F112 | Call to Pager failed | Check for: <ol style="list-style-type: none">1. Remote system problem2. Telephone line problem |
| 4B00F11B | Operator Panel reponse failure | If this message persists, re-IPL to clear logs and reset programs. |

Appendix A. System Records

Record the Identification Numbers

S70 or S7A System Rack

Record and retain the following information.

| | |
|-------------------|------------------------|
| Product Name | S70 or S7A System Rack |
| CPU Type/Speed | _____ |
| Serial Number | _____ |
| Key Serial Number | _____ |

S70 or S7A System Rack Memory Configuration

| Memory Quad | Slots | Memory Card Size |
|-------------|----------------------|------------------|
| Quad A | M1, M2 M14, M15 | _____ |
| Quad B | M3, M4 M12, M13 | _____ |
| Quad C | M5, M6 M10, M11 | _____ |
| Quad D | M16, M17 M23, M24 | _____ |
| Quad E | M18, M19 M21, M22 | _____ |

| Memory Quad | Slots | DIMM Memory Size | |
|--|-------|------------------|-------|
| Quad E Dimm Based Memory Usage | M18 | Bank 0 | _____ |
| | | Bank 1 | _____ |
| | | Bank 2 | _____ |
| | | Bank 3 | _____ |
| | M19 | Bank 0 | _____ |
| | | Bank 1 | _____ |
| | | Bank 2 | _____ |
| | | Bank 3 | _____ |
| | M21 | Bank 0 | _____ |
| | | Bank 1 | _____ |
| | | Bank 2 | _____ |
| | | Bank 3 | _____ |
| | M22 | Bank 0 | _____ |
| | | Bank 1 | _____ |
| | | Bank 2 | _____ |
| | | Bank 3 | _____ |

S70 or S7A System Rack Cabling Configurations - RIO Cabling

Use the following diagram to draw the RIO cabling configuration from the System Rack to the I/O Drawer(s).

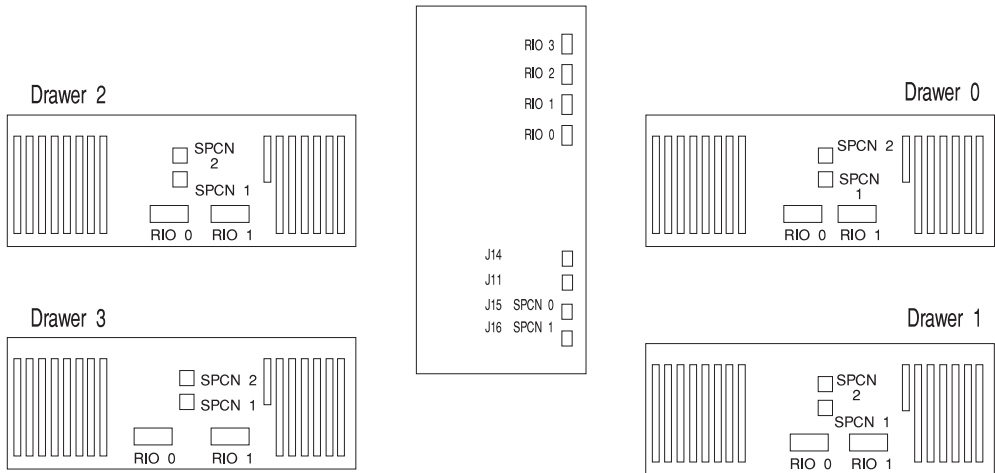

S70 or S7A System Rack Cabling Configurations - SPCN Cabling

Use the following diagram to draw the SPCN cabling configuration from the System Rack to the I/O Drawer(s).

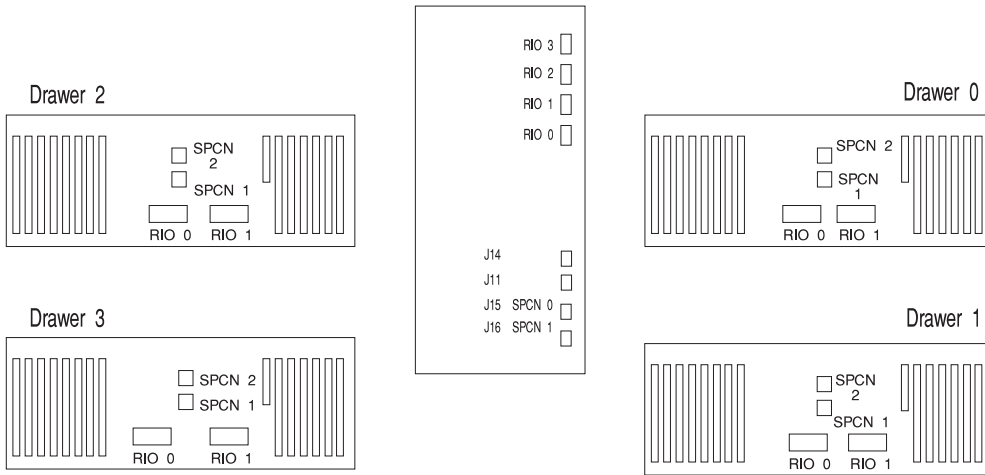

Primary I/O Drawer Device Records

Use the following tables to keep a record of the options installed in or attached to your system. This information can be helpful when you install additional options in your server or if you ever need to have your server serviced.

| Location | Option Description |
|--------------------|--|
| Mouse Connector | <u>IBM Mouse</u> <input type="checkbox"/> Other: _____ |
| Keyboard Connector | <u>Space Saving</u> <input type="checkbox"/> <u>Enhanced</u> <input type="checkbox"/> Other: _____ |
| Expansion Slot 14 | _____ |
| Expansion Slot 13 | _____ |
| Expansion Slot 12 | _____ |
| Expansion Slot 11 | _____ |
| Expansion Slot 10 | _____ |
| Expansion Slot 9 | _____ |
| Expansion Slot 8 | RESERVED - Service Processor |
| Expansion Slot 7 | _____ |
| Expansion Slot 6 | _____ |
| Expansion Slot 5 | _____ |
| Expansion Slot 4 | _____ |
| Expansion Slot 3 | _____ |
| Expansion Slot 2 | _____ |
| Expansion Slot 1 | _____ |
| Parallel Port | _____ |
| Serial Port 1 | _____ |
| Serial Port 2 | _____ |

Refer to the following diagram of your server's banks/bays when completing Table A-2 on page A-7.

10 EIA Unit I/O Drawer

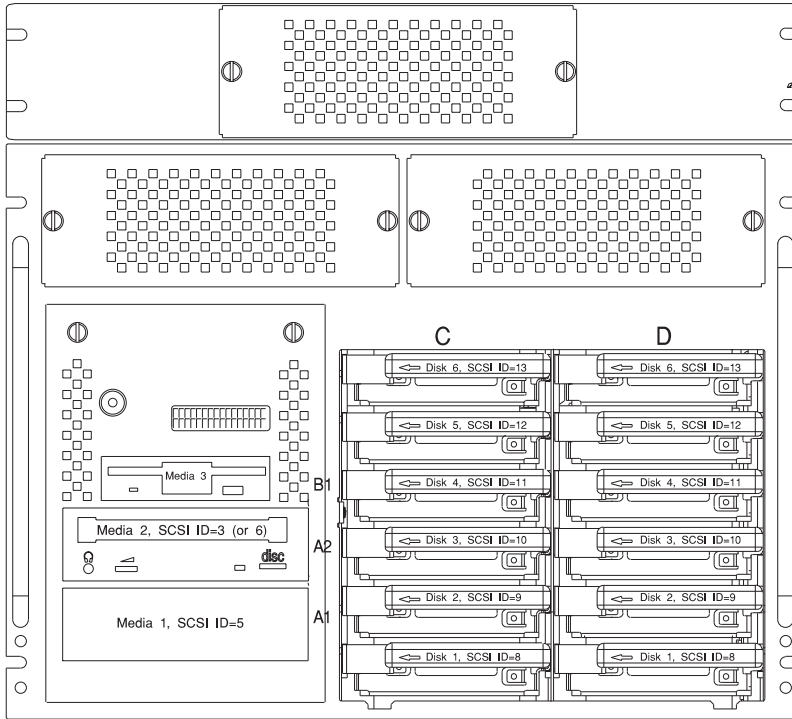

Table A-2. Internal Files and Devices in Primary Drawer (0) 10 EIA Unit I/O Drawer

| Location/Drive | SCSI ID | Drive Description |
|-----------------------|----------------|---------------------------------------|
| Bank B, Bay 1 | Non-SCSI | <u>3.5-Inch 1.44MB Diskette Drive</u> |
| Bank A, Bay 2 | 3 | <u>CD-ROM Drive</u> |
| Bank A, Bay 1 | 5 | _____ |
| Bank C, Drive 1 | 8 | _____ |
| Bank C, Drive 2 | 9 | _____ |
| Bank C, Drive 3 | 10 | _____ |
| Bank C, Drive 4 | 11 | _____ |
| Bank C, Drive 5 | 12 | _____ |
| Bank C, Drive 6 | 13 | _____ |
| Bank D, Drive 1 | 8 | _____ |
| Bank D, Drive 2 | 9 | _____ |
| Bank D, Drive 3 | 10 | _____ |
| Bank D, Drive 4 | 11 | _____ |
| Bank D, Drive 5 | 12 | _____ |
| Bank D, Drive 6 | 13 | _____ |
| _____ | _____ | _____ |
| _____ | _____ | _____ |
| _____ | _____ | _____ |
| _____ | _____ | _____ |

7 EIA Unit I/O Drawer

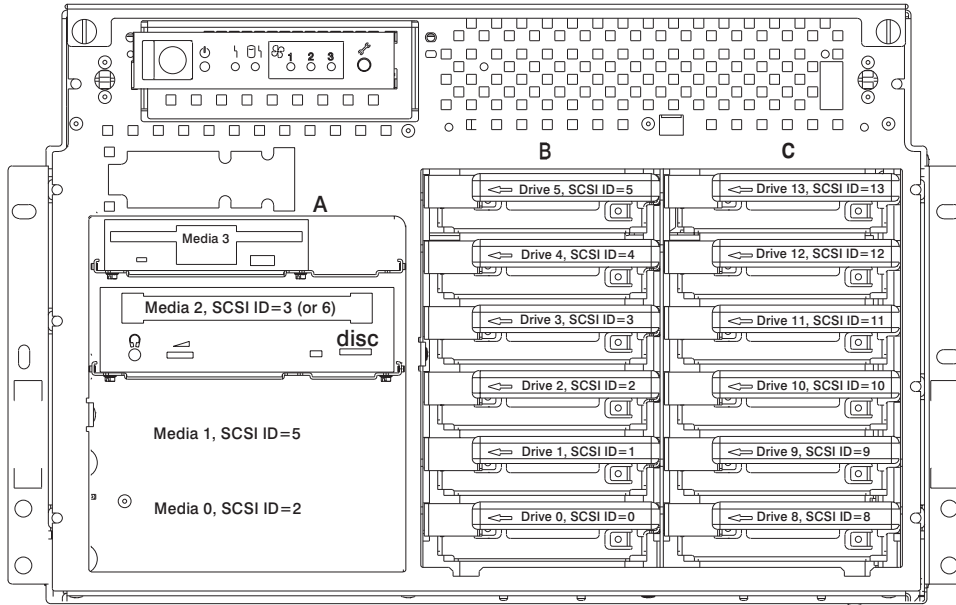

Table A-3. Internal Files and Devices in Primary Drawer (0) 7 EIA Unit I/O Drawer

| Location/Drive | SCSI ID | Drive Description |
|------------------|----------|---------------------------------------|
| Bank A, Bay 3 | Non-SCSI | <u>3.5-Inch 1.44MB Diskette Drive</u> |
| Bank A, Bay 2 | 3 | <u>CD-ROM Drive</u> |
| Bank A, Bay 1 | 5 | _____ |
| Bank A, Bay 0 | 2 | _____ |
| Bank B, Drive 0 | 0 | _____ |
| Bank B, Drive 1 | 1 | _____ |
| Bank B, Drive 2 | 2 | _____ |
| Bank B, Drive 3 | 3 | _____ |
| Bank B, Drive 4 | 4 | _____ |
| Bank B, Drive 5 | 5 | _____ |
| Bank C Drive 8 | 8 | _____ |
| Bank C, Drive 9 | 9 | _____ |
| Bank C, Drive 10 | 10 | _____ |
| Bank C, Drive 11 | 11 | _____ |
| Bank C, Drive 12 | 12 | _____ |
| Bank C, Drive 13 | 13 | _____ |
| _____ | _____ | _____ |
| _____ | _____ | _____ |
| _____ | _____ | _____ |
| _____ | _____ | _____ |

Additional I/O Drawer Device Records

Use the following tables to keep a record of the options installed in or attached to your system. This information can be helpful when you install additional options in your server or if you ever need to have your server serviced.

| Location | Option Description / Drawer # Description |
|-------------------|--|
| Expansion Slot 14 | _____ |
| Expansion Slot 13 | _____ |
| Expansion Slot 12 | _____ |
| Expansion Slot 11 | _____ |
| Expansion Slot 10 | _____ |
| Expansion Slot 9 | _____ |
| Expansion Slot 8 | _____ |
| Expansion Slot 7 | _____ |
| Expansion Slot 6 | _____ |
| Expansion Slot 5 | _____ |
| Expansion Slot 4 | _____ |
| Expansion Slot 3 | _____ |
| Expansion Slot 2 | _____ |
| Expansion Slot 1 | _____ |

Table A-5. Internal Files and Devices in Secondary Drawer (1)

| Location/Drive | SCSI ID | Drive Description |
|-------------------|---------|-------------------|
| Bank A, Bay 2 | — | _____ |
| Bank A, Bay 1 | — | _____ |
| Bank __, Drive __ | — | _____ |
| Bank __, Drive __ | — | _____ |
| Bank __, Drive __ | — | _____ |
| Bank __, Drive __ | — | _____ |
| Bank __, Drive __ | — | _____ |
| Bank __, Drive __ | — | _____ |
| Bank __, Drive __ | — | _____ |
| Bank __, Drive __ | — | _____ |
| Bank __, Drive __ | — | _____ |
| Bank __, Drive __ | — | _____ |
| Bank __, Drive __ | — | _____ |
| Bank __, Drive __ | — | _____ |
| _____ | _____ | _____ |
| _____ | _____ | _____ |
| _____ | _____ | _____ |
| _____ | _____ | _____ |

Table A-6. Internal and External Options in Secondary Drawer (2)

| Location | Option Description / Drawer # Description |
|-------------------|---|
| Expansion Slot 14 | _____ |
| Expansion Slot 13 | _____ |
| Expansion Slot 12 | _____ |
| Expansion Slot 11 | _____ |
| Expansion Slot 10 | _____ |
| Expansion Slot 9 | _____ |
| Expansion Slot 8 | _____ |
| Expansion Slot 7 | _____ |
| Expansion Slot 6 | _____ |
| Expansion Slot 5 | _____ |
| Expansion Slot 4 | _____ |
| Expansion Slot 3 | _____ |
| Expansion Slot 2 | _____ |
| Expansion Slot 1 | _____ |

Table A-7. Internal Files and Devices in Secondary Drawer (2)

| Location/Drive | SCSI ID | Drive Description |
|-------------------|---------|-------------------|
| Bank A, Bay 2 | — | _____ |
| Bank A, Bay 1 | — | _____ |
| Bank __, Drive __ | — | _____ |
| Bank __, Drive __ | — | _____ |
| Bank __, Drive __ | — | _____ |
| Bank __, Drive __ | — | _____ |
| Bank __, Drive __ | — | _____ |
| Bank __, Drive __ | — | _____ |
| Bank __, Drive __ | — | _____ |
| Bank __, Drive __ | — | _____ |
| Bank __, Drive __ | — | _____ |
| Bank __, Drive __ | — | _____ |
| Bank __, Drive __ | — | _____ |
| Bank __, Drive __ | — | _____ |
| _____ | _____ | _____ |
| _____ | _____ | _____ |
| _____ | _____ | _____ |
| _____ | _____ | _____ |

Table A-8. Internal and External Options in Secondary Drawer (3)

| Location | Option Description / Drawer # Description |
|-------------------|---|
| Expansion Slot 14 | _____ |
| Expansion Slot 13 | _____ |
| Expansion Slot 12 | _____ |
| Expansion Slot 11 | _____ |
| Expansion Slot 10 | _____ |
| Expansion Slot 9 | _____ |
| Expansion Slot 8 | _____ |
| Expansion Slot 7 | _____ |
| Expansion Slot 6 | _____ |
| Expansion Slot 5 | _____ |
| Expansion Slot 4 | _____ |
| Expansion Slot 3 | _____ |
| Expansion Slot 2 | _____ |
| Expansion Slot 1 | _____ |

Table A-9. Internal Files and Devices in Secondary Drawer (3)

| Location/Drive | SCSI ID | Drive Description |
|-------------------|---------|-------------------|
| Bank A, Bay 2 | — | _____ |
| Bank A, Bay 1 | — | _____ |
| Bank __, Drive __ | — | _____ |
| Bank __, Drive __ | — | _____ |
| Bank __, Drive __ | — | _____ |
| Bank __, Drive __ | — | _____ |
| Bank __, Drive __ | — | _____ |
| Bank __, Drive __ | — | _____ |
| Bank __, Drive __ | — | _____ |
| Bank __, Drive __ | — | _____ |
| Bank __, Drive __ | — | _____ |
| Bank __, Drive __ | — | _____ |
| Bank __, Drive __ | — | _____ |
| Bank __, Drive __ | — | _____ |
| _____ | _____ | _____ |
| _____ | _____ | _____ |
| _____ | _____ | _____ |
| _____ | _____ | _____ |

Appendix B. Supplies

This appendix contains a list of supplies and the part numbers needed to order them.

| Part Number | Description |
|--------------------|---|
| 21F8763 | 4mm Cleaning Cartridge |
| 21F8758 | 4mm DDS Data Tape Cartridge (5-pack) |
| 21F8762 | 4mm DDS Diagnostic Cartridge |
| 8191160 | 4mm DDS2 Data Tape Cartridge (5-pack) |
| 8191146 | 4mm DDS2 Diagnostic Cartridge |
| 21F8732 | 1/4-inch 1.2GB Data Tape Cartridge (5-pack) |
| 21F8587 | 1/4-inch 525MB Data Tape Cartridge (5-pack) |
| 21F8588 | 1/4-inch 150MB Data Tape Cartridge (5-pack) |
| 21F8570 | 1/4-inch Cartridge Head Cleaning Kit |
| 21F8595 | 8mm Data Tape Cartridge (5-pack) |
| 16G8467 | 8mm Cleaning Tape Cartridge |
| 21F8577 | 8mm Test Tape Cartridge |
| 13F5647 | Tape Cleaning Solution |

Appendix C. Operator Panel Functions

System Rack Operator Panel

The following diagram shows the locations of the operator panel display and the operator panel pushbuttons.

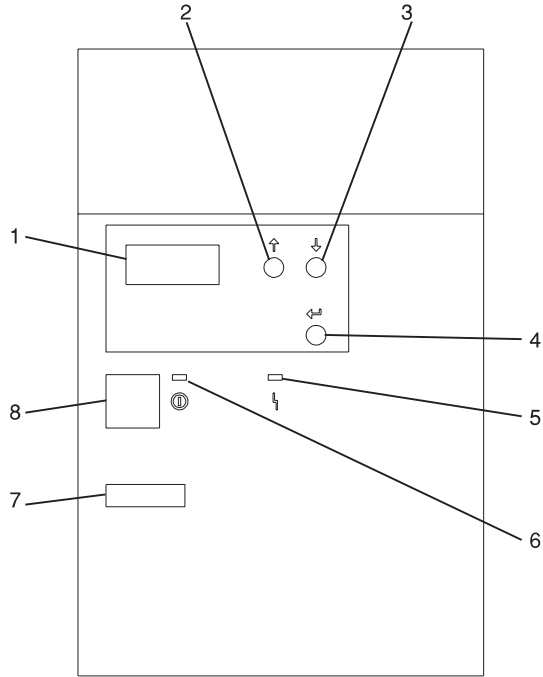

- 1 Operator Panel Display
- 2 Scroll Up Pushbutton
- 3 Scroll Down Pushbutton
- 4 Enter Pushbutton
- 5 Attention LED
- 6 Power On LED
- 7 Serial Number
- 8 Power Pushbutton

Function Code Table

The operator panel functions and descriptions are listed in the following table. For details about the function, see “Operator Panel Function Descriptions” on page C-4.

Notes:

1. The x can be any number 0 through 9, any letter A through F, or a blank.
2. Bold function codes indicate user supported codes.

| <i>Table C-1 (Page 1 of 3). Operator Panel Function Codes</i> | |
|---|---|
| Function Code | Function Selected |
| 01 xxxx xxxx | Pressing the Enter button toggles between: <ol style="list-style-type: none"> 1. Display the currently selected IPL type. 2. Display the currently selected IPL speed override for the next IPL. |
| 02 xxxx xxxx | <ol style="list-style-type: none"> 1. Pressing the Enter button once allows selection of the IPL types A or B Attention: IPL types C and D are for trained service personnel only and may cause data loss if used improperly. 2. Pressing the Enter button twice allows selection of an IPL speed override for the next IPL. Subsequent IPLS are performed at the system selected speed. |
| 03 xxxx xxxx | Start an IPL and load the system. The IPL uses the selected IPL options. Note: This may cause the system to power off and then back on. |
| 04 xxxx xxxx | Lamp test; all displays and indicators are switched on. |
| 05 xxxx xxxx | Informational System Power Control Network (SPCN) system reference code (SRC); displays an SRC on the operator panel. Note: Function 5 reference codes will only be displayed if the function code is changed from the default function 11 position. |
| 06 xxxx xxxx | Reserved |
| 07 xxxx xxxx | Attention: This function allows concurrent maintenance to be performed by trained service personnel. Inadvertent use may cause system failures. |
| 08 xxxx xxxx | Fast power off. |
| 09 xxxx xxxx through 10 xxxx xxxx | Reserved |
| 11 xxxx xxxx through 19 xxxx xxxx | System reference code (SRC); displays an SRC on the operator panel. Note: Function 12 displays informational status codes and is not used. |

| <i>Table C-1 (Page 2 of 3). Operator Panel Function Codes</i> | |
|---|--|
| Function Code | Function Selected |
| 20 xxxx xxxx | Reserved |
| 21 xxxx xxxx | Reserved |
| 22 xxxx xxxx | Initiates AIX dump. |
| 23 xxxx xxxx | Reserved |
| 24 xxxx xxxx | Reserved |
| 25 xxxx xxxx | The service representative switch 1 is set; this function is the first step necessary to set the service function range from 50 to 70. NOTE: This function is for service representatives only and should not be invoked by the user. |
| 26 xxxx xxxx | The service representative switch 2 is set; this function is the second step necessary to set the service function range from 50 to 70. NOTE: This function is for service representatives only and should not be invoked by the user. |
| 27 xxxx xxxx through 31 xxxx xxxx | Reserved |
| 32 xxxx xxxx | Reserved |
| 33 xxxx xxxx | Reserved |
| 34 xxxx xxxx | Reserved |
| 35 xxxx xxxx through 49 xxxx xxxx | Reserved |
| 50 xxxx xxxx | System processing unit stop. |
| 51 xxxx xxxx | System processing unit status. |
| 52 xxxx xxxx | System processing unit start. |
| 53 xxxx xxxx | Path switch and reset. |
| 54 xxxx xxxx | Reserved |
| 55 xxxx xxxx | Display low-level diagnostic service processor log buffer. |
| 56 xxxx xxxx | Display low-level diagnostic service processor code area. |
| 57 xxxx xxxx | Reserved |
| 58 xxxx xxxx | Display low-level diagnostic IPL parameters area. |
| 59 xxxx xxxx | Set first character of base address for function 62 display. |
| 60 xxxx xxxx | Set second character of base address for function 62 display. |
| 61 xxxx xxxx | Set third character of base address for function 62 display. |
| 62 xxxx xxxx | Display service processor control storage. |
| 63 xxxx xxxx | System status SRC trace. |
| 64 xxxx xxxx | Service processor diagnostic status SRC trace. |
| 65 xxxx xxxx | Reserved |

Table C-1 (Page 3 of 3). Operator Panel Function Codes

| Function Code | Function Selected |
|---------------|-------------------|
| 66 xxxx xxxx | Reserved |
| 67 xxxx xxxx | Reserved |
| 68 xxxx xxxx | Reserved |
| 69 xxxx xxxx | Reserved |
| 70 xxxx xxxx | Reserved |

Operator Panel Function Descriptions

Values for IPL Types and Speeds

See Table C-2 and Table C-3 for tables of valid IPL types and speeds used in operator panel functions 01 and 02.

Table C-2. IPL Types

| IPL Type | Description |
|----------|---|
| A | IPL using copy A of the system firmware. |
| B | IPL using copy B of the system firmware. |
| C | Attention: Not supported; may cause data loss if used. |
| D | Attention: Not supported; may cause data loss if used. |

Table C-3. IPL Speeds

| IPL Speed | Description | Details |
|---------------|---------------------------|--|
| F: | Fast Override | Fast diagnostics run. The following are skipped: <ul style="list-style-type: none"> • Mainstorage tests • CEC Inter-chip interface tests (wire test) • Extended Logical Built-in Self Tests • Also, cache data is not provided in mainstorage dumps. |
| S: | Slow Override | Full hardware diagnostics run. Use whenever hardware is changed, for intermittent hardware failures and on the first install IPL. |
| V = (F or S): | Use system selected speed | |

Function 01 - Display Selected IPL Type, Mode and Speed

This function allows you to display the IPL type and IPL speed. Pressing the Enter button in Function 01 toggles between:

1. Display IPL type (A or B).
2. Display IPL speed (F, S, or V = F or V = S).

| Function/Data | Description |
|----------------|--|
| 01 _ _ _ _ _ | Use the scroll up or scroll down buttons and scroll to Function 01. |
| 01 _ _ _ A _ _ | Press Enter to enter Function 01 Selected IPL Type display. Valid types, which appear in the sixth character position of the Function/Data display are A or B. See Table C-2 on page C-4 for descriptions of IPL types. |
| 01 _ _ V = F _ | Use Enter again to toggle to Selected IPL Speed display. Valid speed displays are F, S, V=F or V=S. <ul style="list-style-type: none">• F: Fast override selected.• S: Slow override selected.• V = (F or S): Use system selected speed. |
| 01 _ _ _ A _ _ | Use Enter to toggle to Selected IPL Type display. |

Function 02 - Select IPL Type, Mode and Speed

This function allows you to select the IPL type and IPL speed. System power must be off to change IPL speed.

1. Pressing Enter once puts you into the change IPL type (A or B) operation.
Attention: IPL types C and D are not supported and may cause data loss if used.
2. Pressing the Enter button twice puts you into the operation for overriding the system IPL speed (F, S, V) for the next IPL. Subsequent IPLs are performed at the system selected speed.

For example, if you want to select IPL Type, select Function 02. Push the Enter button once, and then use the scroll up or scroll down button to select an IPL type. Pressing Enter again saves that value and exits the Select IPL Type display.

If you want to change the IPL speed, you must have system power off. Select Function 02, push the Enter button twice, use the scroll up or scroll down button to select F, S, or V and then press Enter to activate the override (F or S) or cancel it (V) and exit the Select IPL Speed display. See Table C-3 on page C-4 for recommended speed settings.

Table C-5. Function 02 Select IPL Type

| Function/Data | Description |
|----------------|--|
| 02 _ _ _ _ _ | Use the scroll up or scroll down button and scroll to Function 02. |
| 02 _ _ _ A _ _ | Press Enter once to enter Function 02. Select IPL Type display. Use the scroll up or scroll down buttons to scroll through the IPL types A and B. See Table C-2 on page C-4 for descriptions of IPL types. Pressing Enter saves the selected IPL type and exits Function 02. |

Function 03 - Start IPL

Function 03 is enabled only when the system is powered on.

This function starts an IPL using the selected IPL mode when the Enter button is pressed.

Note: The system may power off and then back on as part of the IPL.

Function 04 - Lamp Test

This function ensures that no indicators are burned out and that characters displayed at the operator panel are valid. When this test is activated, the following lights go on:

- On the system operator panel:
 - The System Attention light
 - The Power On light
 - A 5 x 7 dot pattern for each character in the Function/Data display.

The lamp test continues on the system operator panel until you perform another operator panel function or a power procedure.

Function 05 - SPCN (System Power Control Network) Informational SRC

Function 05 displays information about power faults and provides informational reference codes during concurrent maintenance procedures. The format for this function is as follows:

05

1RRU rrrr

RR = Frame number refers to the particular I/O Drawer
or System Rack
U = Always 1 for information pertaining to the System Rack
or I/O Drawers other than the primary.
Always C is for the primary I/O Drawer.
rrrr = Service reference code (SRC)

Note: Function 5 reference codes are only displayed if the operator panel selection is moved from the default function 11 position.

Function 07 - Restore System Power and Perform Concurrent Maintenance Repair

Attention: This function allows concurrent maintenance to be performed by trained service personnel. Inadvertent use may cause system failures.

Function 08 - Fast Power Off

Use this function when the system is suspended and a power down cannot be performed.

Initially, an attention SRC (11-x A1xx 8008) is displayed. This indicates that Function 08 has been selected.

Note: If the server has Unattended Start Mode (USM) enabled, selecting this function causes the server to power off and then power on again.

Functions 11 to 19 - System Reference Code

Functions 11 through 19, if enabled, represent the words of the SRC.

Note: Function 11 provides the primary SRC. Function 12 is an informational status message only and not used. Functions 14 and 15 provide secondary reference codes in addition to the primary SRC. Function 13 provides status information for service support use. Function 19 provides CCIN information for FRU replacement.

Press Enter to view the SRC. If no SRC is present, press Enter to continue to the next function.

SRC information should be recorded for error reporting. For example, the system processor detected a failure.

1. Look at the four rightmost characters of the operator panel display for function 11. These four characters are the unit reference code.
2. Look at functions 14 and 15 for more reference codes. Each is four characters in length. There may be from zero to four unit reference codes contained in these words. For example:

Word 11 - B455 rrrr
Word 14 - rrrr rrrr
Word 15 - rrrr 0000
Word 19 - CCIN CCIN

This example shows a total of four reference codes for this failure. The rrrr signifies the reference codes. Each reference code has only one FRU associated with it. The CCIN code is used to determine a failing FRU in some cases.

3. Find the unit reference code in the SRC tables.

Note: Depending on the source of the SRC, some functions do not report any SRC status. All SRCs start with information in Function 11.

Appendix D. Microcode Update Procedures

This section applies to all RS/6000 S70 and S7A versions. There is specific System Firmware and Service Processor microcode to support specific machine types and models.

Determining the Microcode Versions

If the server is in operation, the installed microcode versions can be determined using AIX. If the server is about to be initialized, the installed microcode versions can be determined by using the SMS utilities for system firmware versions and Service Processor menus for Service Processor versions.

On S70 or S7A architecture servers, use the following procedure to determine your firmware level:

1. On the system you wish to update, at an AIX command prompt, enter the following command:

```
lscfg -vp | grep -p "ROM L"
```

You should see something similar to the following:

System Firmware:

```
ROM Level.(alterable).....19970801 (B) 19971213 (A)
Version.....RS6K
System Info Specific.(YL)...U0.1-P1-X1
```

SP_CARD_:

```
Version.....RS6K
ROM Level.(alterable).....19970530 (B) 19971213 (A)
System Info Specific.(YL)...U0.1-P1-X1
```

2. When an update is performed, the firmware is written to the B side only, and “promoted” to the A side. In the example above, the system firmware level is 19971213 and the service processor firmware level is 19971213.

Note: The above example will not match the version that you see for your system. The version that you see in the ROM Level fields depends on the level of firmware that you currently have on your A side, and B side of your system.

The **ROM Level (alterable)** number corresponds to the version number. In this example, the system was booted from the B version since it is listed first. If the most recent version number (A or B) is less than the update version number available for your server, you should consider installing the update.

When you have determined the version number(s), exit the configuration report by typing `q` and then press Enter.

During system IPL, an ASCII terminal on serial port 1 or 2 can be used to access the Service Processor menus. The Service Processor version number is contained in the heading of the first menu. The following is an example of what the heading with the Service Processor microcode version looks like:

```
Service Processor Firmware
Version 19970801
Copyright 1997 IBM Corporation
```

The numbers in the second line show the booted version number. If this version number is less than the update version number available for your server, you should consider installing the update.

Similarly, the FW version numbers can be accessed from the SMS utilities.

To determine the version of system microcode, power on your server and do the following:

- If you are using a graphics display:

Press F1 after the Keyboard icon appears but before the Speaker icon appears. When the tests have completed, and any required passwords have been entered, the SMS utilities menu appears.

When the graphics display is initialized and the icons begin to appear along the bottom of the screen, the microcode version is displayed in the bottom right-hand corner of the display.

- If you are using an ASCII terminal:

Press number 1 after the word 'keyboard' appears but before the word 'speaker' appears. When the tests have completed, and any required passwords have been entered, the SMS utilities menu appears. On the second line of the heading is a version number, date and time.

Obtaining the Microcode Update Package

Service Processor microcode update packages are available from the RS/6000 Support page on the Internet under RS/6000 Microcode Updates. The URL is:

<http://www.rs6000.ibm.com/support/>

Filenames are supplied in the table on the microcode download page. The most current downloading, unpacking and installation instructions are on-line and included in the download package.

To reduce system update time and resolve and dependency questions, the Service Processor Firmware and System Firmware are combined into a single image distributed as one update package.

Downloading Microcode Updates

Prior to downloading the microcode, you are asked to read and accept the terms of the Machine Code License Agreement. Once you accept the terms, you are assigned a password. Write down this password as it is required later to unpack the files you download.

Find the most recent update package for your server. Print the description file and download ONE of the update file sets, depending on the workstation being used for downloading, as follows.

Downloading to a DOS, OS/2 or Windows-based PC Workstation

In this process, you will create update diskettes for use at the server being updated.

1. Download the DOS format set of files to an empty subdirectory on your workstation.

Note: For the following instructions, we assume the name of this empty subdirectory is `d:[Path]\download`.

2. Execute each of the downloaded ***.exe** files.

When prompted, enter the password assigned to you when you accepted the terms of the download agreement.

This unpacks the download(s) and makes them ready for local processing, creating a new subdirectory (we'll call `d:[path]\download\unpacked` for these instructions) containing some ***.emt** files, the DSK4DOS utility and documentation (text) files. You can find the actual name of this directory by searching for the date on which it was created.

3. Have AIX-formatted diskettes ready (one for each **.emt** file in the `\download\unpacked` subdirectory). Insert one of the diskettes into your workstation diskette drive and enter the following commands at the DOS prompt:

```
cd d:[Path]\download\unpacked
DSK4DOS filenamex.emt a:
```

where `filenamex` represents each **.emt** filename.

This will create a diskette per processed file. These diskettes are the inputs for the update process. The diskette number is the last character (x) in the ***.emt** filename.

Continue these transfers to diskette for each **.emt** file in the `d:[Path]\download\unpacked` directory.

4. Label the diskette(s) with the update name and version number, the diskette number (x), if there is more than one, the (short) list of files in the diskette, and the word BACKUP.
5. After reading the accompanying description and installation instructions, proceed to the installation instructions. When asked for the source of the update image, it is on the diskettes you just created.

If there is any conflict in the instructions, those accompanying the update files take precedence.

Downloading to an AIX Workstation

In this process, you will create update diskettes for use at the server being updated.

1. Download the AIX multiple-file format set of files, if there is one, to an empty subdirectory on your workstation. If there is no multi-file format selection, choose the available AIX selection.

Note: For the following instructions, we assume the name of this empty subdirectory is /home/download.

2. Execute each of the downloaded files. Be sure to call each file by its **complete** name, including the extension.

When prompted, enter the password assigned to you when you accepted the terms of the download agreement. Each execution will request the password.

This unpacks the download(s), creating a new subdirectory (we'll call it /home/download/unpacked for these instructions) containing some ***.bak** files and documentation (text) files. You can find the actual name of this directory by searching for the date on which it was created.

3. Transfer the unpacked **.bak** file(s) to diskette(s) with the following AIX command:

```
dd if=/home/download/unpacked/[filenamex].bak of=/dev/rfd0/ bs=9216
```

[filename] represents the name of each file and **x** signifies the label number of each diskette image, if there are more than one.

Continue these transfers to diskette for each **.bak** file in the /home/download/unpacked directory. Other files that may appear in this directory are documentation (text) files.

4. Label the diskette(s) with the update name and version number, the diskette number (x), the (short) list of files on the diskette, and the word BACKUP.
5. After reading the accompanying description and installation instructions, proceed to the installation instructions. When asked for the source of the update image, it is on the diskette(s) you just created.

If there is any conflict in the instructions, those accompanying the update files take precedence.

Downloading to the AIX Server You are Updating

1. Transfer the AIX single-file format file to an empty subdirectory on your server.

Note: For the following instructions, we assume the name of this empty subdirectory is `/home/download`.

2. Execute this file on your server. Be sure to call the file by its **complete** name, including the extension.

When prompted, enter the password assigned to you when you accepted the terms of the download agreement.

This unpacks the download, creating a new subdirectory (we'll call it `/home/download/unpacked` for these instructions) containing some **.bak** files and documentation (text) files. You can find the actual name of this directory by searching for the date on which it was created.

3. View the contents of subdirectory `/home/download/unpacked` to get the full name of the **.bak** file for use now and when installing the update.
4. Execute the following AIX command:

```
/etc/restore -x -f/home/download/unpacked/*.bak  
(replace * with the filename)
```

This creates a new subdirectory containing at least two **.img** files. Other files that may appear are documentation (text) files.

The new subdirectory name can be observed on your monitor during the execution of the restore command. For these instructions, we use an example name of `mcupdate` for the subdirectory. The actual subdirectory name may be different.

5. After reading any accompanying description and installation instructions, proceed to the installation instructions. When asked for the source of the update image, it is in the new subdirectory and has a **.img** filetype.

If there is any conflict in the instructions, those accompanying the update files take precedence.

Update Process Overview

The following information provides an overview of the update process in general, and applies to all available update methods described on the following pages.

When updating from diskettes, insert the first diskette in the drive before selecting the Update System or Service Processor Flash service aid. This precaution ensures proper early diskette recognition. The service aid, however, may still ask for the diskette even with it already in place.

To conserve resources in your server, restoring the update image from diskettes is a two-pass process. In the first pass, the service aid is collecting a list of filenames and sizes to be restored, and comparing resources needed to resources available.

If this first pass determines more resources are needed, it may request an increase in size for the file system `/var`. Use standard AIX techniques to do this. If the update image does not fit into this file system, the update cannot be successful. The second pass restores the update.

As the microcode update takes place, during the processes shutdown sequence following the microcode transfer, progress can be monitored from the operator panel. The checkpoints E080 and E081 alternately appear while the update is in progress.

At some points in the update process, these checkpoints may not change for one to ten minutes. If this occurs, be patient and allow the time for the update process to complete.

How to Install a Microcode Update

Updating the microcode requires rebooting the server. The update is applied during the processes shutdown sequence following the microcode transfer. The next boot uses the updated microcode for its control.

The new microcode is placed in the IPL Type B location for use while your acceptance tests are under way. When you are satisfied with the performance of the new version, "promote" it to the IPL Type A location. There is no time limit on when promotion must occur. Thorough testing of any changes to your system is recommended before committing to them.

Keeping an archive of microcode levels allows recovery in case newer levels are found to create problems with your specific applications.

This section describes the update and promotion procedures.

Updating microcode in the S70 servers **MUST** be initiated from either the Update Flash Diagnostic Service Aid or directly from an AIX command line.

Updating from the Service Aids

1. Invoke the Service Aids from either on-line or standalone diagnostics. For more information, refer to Chapter 6 on page 6-1.
2. Choose Update System or Service Processor Flash service aid.
3. Follow the on-screen update steps as they are presented.

When asked for the filename, first list the files and then select the appropriate one for your update. If the filenames contain numbers, begin with the filename that contains the number 1.

Following a successful update initialization, the server automatically performs the update, reboots, and loads at the new level. Since the update occurs during this shutdown/reboot sequence, it is important to protect the server from interruptions.

After acceptance testing is completed, make your microcode update permanent. See "Promoting the Microcode Update" on page D-10.

Updating from the AIX command line

The Service Aids collect the information needed to construct an AIX command. You can create that same command directly using the following syntax:

```
update_flash [-q] -f filename
```

or

```
update_flash [-q] -D device -l
```

or

```
update_flash [-q] -D device -f filename
```

where

- q updates the flash and reboots the system without asking for confirmation.
- D device specifies the flash image file is on diskette(s) in the specified device.
- f filename is the fully qualified pathname of the flash update image file.
- l provides a list of files on the diskette for the user to select the flash update image file. l is a lower case letter L.

For a microcode image file named "filename.img." located in a file system in the example path /tmp/mcupdate enter:

```
/usr/lpp/diagnostics/bin/update_flash -f /tmp/mcupdate/filename.img
```

For microcode images located on diskette(s), and to obtain a selection list of files on the diskette(s), enter:

```
/usr/lpp/diagnostics/bin/update_flash -D /dev/rfd0 -l
```

Information similar to the example below is displayed. Enter a numeric response.

- Choose one of the following
by number, then press "Enter":
0. No choice
 1. [Path]filename.img
 2. [Path]promote.img
 3. [Path][other files]

For a microcode image file "filename.img" located on diskette, and to perform the update without asking the user for confirmation to reboot the system, enter:

```
/usr/lpp/diagnostics/bin/update_flash -D /dev/rfd0 -f filename.img -q
```

Note: A system reboot is necessary to update the microcode. The default action of the command is to locate the image file, then ask for confirmation to proceed with the microcode update and required reboot. If the -q flag is set, the command does not ask for confirmation before beginning the microcode update and reboot.

Promoting the Microcode Update

Your S70 server allows a trial period for testing the update before committing to the new version. When this update has been tested thoroughly, refer to the commands you previously entered to install the update. Enter the same commands, this time specifying the filename **promote.img** rather than the filename you selected previously. Be aware that the promotion process requires the server to **shut down** its processes to rewrite IPL Type A and reboot from it.

Your S70 or S7A maintains two copies of System and Service Processor microcode. These copies reside in locations referred to as **IPL TYPE A** and **IPL TYPE B**.

Your server normally runs IPL Type A. New microcode updates are stored in IPL Type B until they are promoted. Once promotion takes place, the two IPL Types are identical.

When a microcode update is processed, the server automatically begins using IPL Type B. When promotion is processed, the server automatically begins using IPL Type A.

Between the time of a microcode update and the promotion procedure, the server may be instructed (using operator panel function 02) to use either IPL type for the purpose of microcode testing. When you are ready to promote the new microcode, the server **MUST** be using IPL Type B. Otherwise, the promotion fails. The recovery procedure is:

- Turn off the server power.
- Switch the server's operation to IPL Type B.
- Turn on the server power to IPL from Type B.

Operator panel function 01 may be used to determine which IPL type is in use at any given time. See "Operator Panel Function Descriptions" on page C-4 for more information about these operator panel functions.

As the promotion occurs, during the processes shutdown sequence, checkpoint E082 appears during the promotion activity. This checkpoint can last up to a few minutes.

Archiving the Updates

In the event it becomes necessary to restore your server to a previous microcode level, it is suggested you identify and archive the materials for each update you install.

If the download process produces diskettes, label and store them in a safe place.

If the download process produces only an update image file, archive and identify the file for convenient retrieval.

Appendix E. Service Processor Setup and Test

For your convenience, a sample SP setup procedure is provided below. Your setup may include more or less of the available features, so you may wish to adjust this checklist for your own application.

SP Setup Checklist

1. Ensure the server is powered off.
2. Attach a local ASCII terminal for this setup procedure.
3. Attach a modem (if needed), see “How to access SP menus locally” on page 3-3, and see “Modem Configuration Menu” on page 3-18 for the menus needed to configure your modem.
4. Power on the server, the local terminal, and the modem.
5. Bring up the Service Processor Menus, see Chapter 3 on page 3-1.

ATTENTION: To bring up the Service Processor Menus while the server is booting up, watch the operator panel display for checkpoint E04F. At this checkpoint, a ten second window of time begins with three beeps. Checkpoint E07A is displayed and is visible during the ten second window. During this window, strike any key on the local terminal and the Service Processor menus appear on the local terminal.

6. Set the System Name, see “Privileged User Menus” on page 3-7.
7. Enable Surveillance, see 3-9.
8. Configure Call-In/Call-Out, see “Call-In/Call-Out Setup Menu” on page 3-17.
9. Exit the Service Processor menus
10. Wait until the system offers a logon prompt. Log on and perform an orderly system shutdown using the AIX shutdown `-F` command.
11. Power off the server.
12. Test Call-In, page E-2
13. Test Call-Out, page E-3
14. Use the “Save or Restore Hardware Management Policies” on page 6-28 to backup the service processor settings.

Note: This is strongly recommended to protect the usefulness of the service processor and the availability of your server.

Your Service Processor is ready to go to work.

Testing the Service Processor Setup

These tests include communicating with the server's operating system. Be sure the necessary serial port(s) is configured. If you need assistance, refer to "Serial Port Configuration" on page E-3.

Use following procedure to verify your Service Processor setup is working.

The server should still be powered off as a result of the setup checklist steps on page E-1.

Call-In

1. From any telephone, call the server's telephone number. After you hear three rings, hang up. The server powers on.
Note: Although the server powers on during the three rings, you do not receive an indication over the telephone that the server is powering on.
2. Give the server five minutes to boot up and prepare to receive another call.
3. From an ASCII terminal or terminal emulator, call the server again. The server answers and presents the Service Processor Menu on your terminal.
4. If required, enter your privileged access password. If no password is required, the Main Menu displays.
5. From the Main Menu, select Continue System Boot to view the IPL progress messages. Depending on your server's configuration, the boot up sequence may take several minutes. Once the boot up completes, the logon prompt displays. You have successfully called into the SP and brought up the server.
6. Log in and then log out to disconnect from the operating system.
7. Call your server again. The operating system answers and offers the login prompt.

If these tests are successful, call-in is working correctly. You must now shut down and power off the server. To do this, perform the following steps:

8. Log in and command your server to shutdown and power off. In AIX, use the shutdown -F command.

Call-Out

During the Service Processor setup, you entered **your** phone number for the Pager (on page 3-22) and Customer Voice (on page 3-22) phone numbers. These entries are used for this test.

1. Power on the server.
2. Bring up the Service Processor Menus, see Chapter 3 on page 3-1.
ATTENTION: To bring up the Service Processor Menus while the server is booting up, watch the operator panel display for checkpoint E04F. At this checkpoint, a ten second window of time begins with three beeps. Checkpoint E07A is displayed and is visible during the ten second window. During this window, strike any key on the local terminal and the Service Processor menus appear on the local terminal.
3. At the **SP Main Menu**, select Call-In/Call-Out Setup menu, then select Call-Out test. This causes a simulated error condition for the purposes of this test.
4. When your telephone rings, answer the call. You should hear the sound of a telephone being dialed. This is your system unit trying to page you.

If this test is successful, call-out is working.

You should now select “Telephone Number Setup Menu” on page 3-21 to enter the **actual** telephone numbers your server uses to report problems.

Serial Port Configuration

To configure the serial port on an AIX system, enter the following commands from an AIX console:

1. Log in as root.
2. To find if you have any serial ports already configured, enter:

```
lsdev -Cc tty
```

If no serial ports are configured, none are listed. If you wish to configure serial ports that are not listed, continue with the remaining steps.

3. Identify the serial port(s) with the modem(s).
4. Enter

```
smit tty
```
5. Select add tty
6. Select RS232

7. Select Baud rate 9600 or higher.
8. Select login enable and set the flow control to RTS.
9. Commit the selections and set up any other needed serial ports.
10. Exit SMIT.

Appendix F. Modem Configurations

Sample Modem Configuration Files

With hundreds of modems to choose from, and various modem programming standards, configuring a modem for use with the SP can be challenging. The SP is designed to place little demand on an attached modem, thereby increasing the setup and connection success rates. Several sample modem configuration files are supplied that will either work directly with your modem, or provide a good starting point for a custom setup, if required.

The sample modem configuration files can be found in your SP firmware and in the `/usr/share/modems` subdirectory (if your server is using AIX) with the following names. A listing of each file is included at the end of this appendix.

Generic Modem Configuration Files

| AIX File Name | SP Firmware File Name |
|----------------------|------------------------------|
| modem_z_cfg | modem_z_sp |
| modem_z0_cfg | modem_z0_sp |
| modem_f_cfg | modem_f_sp |
| modem_f0_cfg | modem_f0_sp |
| modem_f1_cfg | modem_f1_sp |

Specific Modem Configuration Files

| AIX File Name | SP Firmware File Name |
|----------------------|------------------------------|
| modem_m0.cfg | modem_m0_sp |
| modem_m1.cfg | modem_m1_sp |

With the following selection procedures and your modem manual, one of these configuration files should be suitable for your use.

Configuration File Selection

1. Is your modem an IBM 7852-400?

If yes, use modem configuration file `modem_m0_sp` and go to step 7 on page F-3 below.

Note: The IBM 7852-400 modem has dip switches on the right hand side of the unit. See “IBM 7852-400 DIP Switch Settings” on page F-5 for the correct switch settings.

If no, continue with step 2 below.

2. Is your modem an IBM 7857-017?

If yes, use modem configuration file `modem_m1_sp` and go to step 7 on page F-3 below.

Note: The IBM 7857-017 modem has two telephone line connections on the back of the unit. One is marked “LL” (for Leased Line), and the other is marked “PTSN” (for Public Telephone Switched Network). The service processor expects to use the modem on the public network, so the telephone line should attach to the PTSN connector. Also, see the note on page 3-36.

If no, continue with step 3 below.

3. Does your modem respond to the extended command set (prefixed with &)?

If yes, go to step 5 below.

If no, continue with step 4 below.

4. Does your modem respond to:

a. ATZ reset command, or

b. ATZn reset commands, where n can be 0, 1, etc.?

If ATZ, configuration file `modem_z.cfg` is recommended.

If ATZn, configuration file `modem_z0.cfg` is recommended.

Go to step 7 on page F-3 below.

5. Does your modem command set include a test for V.42 error correction at the remote modem (often called “Auto-Reliable Mode”)?

If yes, this test must be disabled. Sample configuration files `/usr/share/modem_m0.cfg` or `/usr/share/modem_m1.cfg` can be used as models to help you create a file for your particular modem. See “Customizing the Modem Configuration Files” on page F-4. Go to 7 on page F-3.

If no, go to 6 below.

6. Does your modem respond to:

- a. AT&F reset command, or
- b. AT&Fn reset commands, where n can be 0, 1, etc.?

If AT&F, configuration file modem_f.cfg is recommended.

If AT&Fn, configuration file modem_f0.cfg or modem_f1.cfg is recommended, depending on which provides the hardware flow control profile.

- 7. Selection is complete. If you find it necessary to adjust any of these configuration files, do so with reference to the manual that came with your modem.¹ It is recommended you select settings that enable hardware flow control and respond to DTR.

Note: Some older modems do not respond to the commands X0 or &R1. You should edit out these commands from the modem configuration file if yours is such a modem. See your modem manual for more information.

Examples For Using the Generic Sample Modem Configuration Files

| Modem | Setup Z | Setup Z0 (Rare) | Setup F | Setup F0 | Setup F1 |
|-------------------------------|---------|--------------------|---------|----------|----------|
| AT&T DataPort 2001 ** | | | | X | |
| Bocamodem 1440E | | | X | | |
| Hayes Smart Modem 300 | X | | | | |
| IBM 5841 | X | | | | |
| IBM 5843 | X | | | | |
| IBM 7851 | | | | X | |
| IBM 7852-10 | | | | X | |
| IBM 7855 | | | | | X |
| USRobotics 36.6K Sportster | | | | | X |
| Zoom V.32 | | | X | | |

Note: ** Ring interrupt only on first ring.

Customizing the Modem Configuration Files

You can create your own modem configuration file(s) or modify the samples provided. After you customize your modem configuration files, you **MUST** access them via the Configure Remote Maintenance Policy Service Aid rather than from the SP menus.

Note: If you have already set up your serial ports, line speeds, authorizations and telephone numbers from the SP menus, specify your customized modem configuration files from the service aid.

If you have not already set up your serial ports, line speeds, authorizations and telephone numbers from the SP menus, you may set them up with the service aids while you specify your customized modem configuration files.

IBM 7852-400 DIP Switch Settings

If you are using a 7852-400 modem to enable service processor communications, for proper operation, the DIP switches must be set according to the following table.

| Switch | Position | Function |
|--------|----------|--|
| 1 | Up | Force DTR |
| 2 | Up | Flow Control &E4 |
| 3 | Down | Result Codes Enabled |
| 4 | Down | Modem Emulation Disabled |
| 5 | Up | Auto Answer Enabled |
| 6 | Up | Maximum Throughput Enabled |
| 7 | Up | RTS Normal Functions |
| 8 | Down | Enable Command Mode |
| 9 | Down | Remote Digital Loopback Test Enabled |
| 10 | Up | Dial-Up Line Enabled |
| 11 | *Up | AT Responses Enabled (Extended Responses Disabled) |
| 12 | *Down | Asynchronous Operation |
| 13 | UP | 28.8KB Line Speed |
| 14 | Up | |
| 15 | Up | CD and DSR Normal Functions |
| 16 | Up | 2-Wire Leased Line Enabled |

* Only switches 11 and 12 are changed from the factory default settings.

Terminal Emulators

The SP is compatible with simple ASCII terminals, and therefore compatible with most emulators. It is for the cases when a remote session is handed off from SP to the operating system that agreeing terminal emulators becomes important.

The server's operating system will have some built-in terminal emulators. Your server may also have a commercially available terminal emulation. It is important that the local and host computers select the same or compatible terminal emulators so the key assignments and responses will match. This will assure successful communications and control.

For best formatting, choose line wrap in your terminal emulator setup.

Recovery Procedures

Line noises, power surges, etc., can sometimes cause your modem to enter an undefined state. When it is being used for dial in, dial out or Ring Indicate Power-On, your modem is initialized each time one of these actions is expected. If one of these environmental conditions occur after your modem has been initialized, it may be necessary to recover your modem to a known state.

If your modem communicates properly with remote users, it is probably in control. It may be wise to occasionally change some of the functional settings and then change them back, just for the sense of security that the modem is communicating, and to assure it has been initialized recently.

Another strategy, particularly if your system is difficult to access physically, is to protect it with an Uninterruptable Power Source (UPS) and a phone-line surge protector.

In case recovery becomes necessary, your system should be shut down as gracefully as possible. Disconnect and reconnect modem power, and power on the system to allow complete reinitialization of your system.

Seamless Transfer of a Modem Session

There are about as many modem command variations as there are modems. The sample modem configuration files have been written to capture the largest number of workable modem settings.

The modem command `&Dn` (where 'n' is a number) generally sets the modem response to the Data Terminal Ready (DTR) signal from the server's serial port. The desired response is that the modem will hold a connection while DTR is enabled, and drop the connection when DTR is released. This is the mechanism by which the server "hangs up" on a connection under normal conditions.

Usually the command `&D2` will work, but not always. The sample modem configuration files take this high percentage position, see the note on page F-8. You should consult your modem's manual for its specific response scheme for the `&Dn` command.

There are two methods for dealing with the modem's response to DTR:

1. Recovery
2. Prevention

Before proceeding with one of these strategies, you need to determine if your server's modem is set up properly to respond to DTR.

With the remote terminal connected to serial port 1 and defined as the **primary** console device, there are two tests you can perform:

1. Will the modem **drop** the connection after the "System initialization complete" message appears at the remote terminal?

If yes, this is the correct response. The modem is set up correctly.

If no, try another `&Dn` setting for your server's modem. See your modem manual for this information. The `&Dn` command appears in three places each in three of the sample modem configuration files, see the note on page F-8.

2. Will the server's modem **disconnect** when the power drops? You can make this observation at the remote terminal by commanding your server to shutdown and power off. (The AIX command `shutdown -F` will do this.) Watch for the message `NO CARRIER` on your remote terminal.

If yes, this is the correct response. The modem is set up correctly.

If no, try another `&Dn` setting for your server's modem. See your modem manual for this information. The `&Dn` command appears in three places each in three of the sample modem configuration files, see the note on page F-8.

Note: Only the following sample modem configuration files contain the &Dn command (in three places each):

- modem_f.cfg
- modem_f0.cfg
- modem_f1.cfg

If you are using modem_z.cfg or modem_z0.cfg, you cannot control DTR response. If your remote terminal does not disconnect after logging off, you must command the remote terminal emulator to hang up. This then breaks the connection.

Recovery Strategy

The recovery strategy consists of making **three** calls to establish a remote session. This is the easiest solution to implement, and allows more freedom for configuring your server's serial ports.

To set up a remote terminal session, dial in to the server and start the system. Wait 5 minutes for the initialization period and call again to gain control via the SP menus. Continue booting the system from the System Power control menu. After the operating system is loaded and initialized, the connection is dropped. At this point, when you call the server back the operating system answers and offers you the login prompt.

Prevention Strategy

The disconnect is caused by the operating system when it initializes the **primary** console. The tests listed above are conducted with the remote terminal selected as the primary console to manifest the modem's response to DTR transitions.

If a local ASCII terminal or a graphics console is to be a permanent part of your server, then make one of them the primary console. Your remote terminal will no longer experience the connection loss.

If a local console is not a permanent part of your server, you can still assign either the unused graphics console or the unused serial port as the primary console. This gives you the desired seamless connection at your remote terminal.

If you choose to use the unused serial port as the primary console, some initialization traffic will be sent to any serial device attached to that port. As a result, that serial device's connection and function could be affected. These impacts may make that port unattractive for devices other than a temporary local ASCII terminal.

Modem Configuration Samples

Sample File modem_z.cfg

```
#
# COMPONENT_NAME: (ESPSETUP) ENTRY SERVICE PROCESSOR SETUP Z
#
# FUNCTIONS: Modem configuration file for many early Hayes* compatible modems.
# This example uses the ATZ reset command to choose the factory defaults.
# This setup will work for many modems, but it is required for early vintage
# modems which respond to neither the ATZ0 reset command nor the extended (&)
# commands. Refer to your modem manual.
#
# * Trademark of Hayes Microcomputer Products, Inc.
#
# (C) COPYRIGHT International Business Machines Corp. 1996
# All Rights Reserved
# Licensed Materials - Property of IBM
#
# US Government Users Restricted Rights - Use, duplication or
# disclosure restricted by GSA ADP Schedule Contract with IBM Corp.
#
#
# If the modem has configuration switches, they should be set to the
# factory default settings.

ICDelay 1
DefaultT0 10
CallDelay 120
# AT Attention Code           , Inserts delay in dialing commands
# Z Reset to factory defaults Q0 Turn on responses
# E0 Turn echo off           Q1 Turn off responses
# V0 Use numeric responses   S0=0 Automatic answer inhibit
# +++ Escape to command mode S0=2 Answer on second ring
# H0 Hang-up                 T = Tone mode. When used as T\r, it is a
#                               no op to maintain program synchronization
#                               when modem may/will echo the commands.
#
# %N Call-Out phone number   %P Paging phone number
# %S Modem speed (available to users)
#
# Following are common responses from a wide range of modems:
# 16, 15, 12, 10, 5 and 1 are connection responses. Add others as required.
# 7=busy; 6=no dial tone; 4=error; 3=no carrier; 2=ring; 0=OK
#
# PROGRAMMING NOTE: No blanks between double quote marks (").

connect: send "ATZQ0T\r"           # Reset to factory defaults.
         ignore "0\r" or "OK\r\n" timeout 2 # Ignore modem response.
         send "ATE0T\r"           # Initialize modem: Echo OFF,
         expect "0\r" or "OK\r\n" timeout 2 # Enable responses (Numeric),
         send "ATQ0V0T\r"         # Limit response codes.
         expect "0\r" timeout 2     # Confirm commands successful.
         send "ATS0=0\r"          # Set AutoAnswer OFF
         expect "0\r" timeout 2     # Confirm command successful.
         done

connect: send "ATDT%N\r"           # Tone dialing command.
         # %N from Call Home setup.

         # Expect a connection response.
         expect "16\r" or "15\r" or "14\r" or "12\r" or "10\r" or "5\r" or "1\r" busy "7\r"
         timeout 60
         done
```

```

retry:      send "A/"                                # Repeat the previous command.

                                                    # Expect a connection response.
expect "16\r" or "15\r" or "14\r" or "12\r" or "10\r" or "5\r" or "1\r" busy "7\r"
timeout 60
done

disconnect:
delay 2                                           # Separate from previous data.
send "+++"                                       # Assure command mode.
delay 2                                           # Allow mode switching delay.
send "ATH0T\r"                                    # Set modem switch-hook down
                                                    # (i.e., hang up).
ignore "0\r" or "OK\r" timeout 2                # Ignore modem response.
send "ATE0Q1\r"                                  # Initialize modem: Echo OFF,
                                                    # Disable responses.

ignore "0\r" timeout 1
done

condin:    send "ATZQ0T\r"                         # Reset to factory defaults.
ignore "0\r" or "OK\r\n" timeout 2             # Ignore modem response.
send "ATE0T\r"                                  # Initialize modem: Echo OFF,
expect "0\r" or "OK\r\n" timeout 2            # Enable responses (Numeric),
send "ATQ0V0T\r"                              # Limit response codes.
expect "0\r" timeout 2                        # Confirm commands successful.
send "ATS0=2\r"                                # Set AutoAnswer ON
expect "0\r" timeout 2                        # Confirm command successful.
done

waitcall:  ignore "2\r" timeout 1                # Ignore first ring.
expect "2\r" timeout 10                       # Pick up second ring
                                                    # or timeout.
                                                    # Expect a connection response.
expect "16\r" or "15\r" or "14\r" or "12\r" or "10\r" or "5\r" or "1\r"
timeout 60
done

page:      send "ATDT%N,,,%R;\r"                # %N = pager call center number
                                                    # Add enough commas to wait for
                                                    # time to enter paging number.
                                                    # %R = paging number

                                                    # Confirm successful command.
expect "0\r" timeout 60
delay 2                                           # Wait before hanging up.
send "ATH0T\r"                                    # Hang up.
expect "0\r" timeout 2                          # Confirm successful command.
done

ripo:     send "ATZQ0T\r"                         # Reset to factory defaults.
ignore "0\r" or "OK\r\n" timeout 2            # Ignore modem response.
send "ATE0T\r"                                  # Initialize modem: Echo OFF,
expect "0\r" or "OK\r\n" timeout 2            # Enable responses (Numeric),
send "ATQ0V0T\r"                              # Limit response codes.
expect "0\r" timeout 2                        # Confirm commands successful.
send "ATS0=0\r"                                # Set AutoAnswer OFF
expect "0\r" timeout 2                        # Confirm command successful.
done                                             # RI Power On enabled.

error:    # Handle unexpected modem
           # responses.
expect "8\r" or "7\r" or "6\r" or "4\r" or "3\r"
delay 2
done

```

Sample File modem_z0.cfg

```
#
# COMPONENT_NAME: (ESPSETUP) ENTRY SERVICE PROCESSOR SETUP Z0
#
# FUNCTIONS: Modem configuration file for some early Hayes* compatible modems.
# This example uses the ATZ0 reset command to choose the factory defaults.
# This setup is recommended for modems that will respond to the ATZ0 command
# and which do not respond to the extended (&) commands. Refer to your modem
# manual.
#
# * Trademark of Hayes Microcomputer Products, Inc.
#
# (C) COPYRIGHT International Business Machines Corp. 1996
# All Rights Reserved
# Licensed Materials - Property of IBM
#
# US Government Users Restricted Rights - Use, duplication or
# disclosure restricted by GSA ADP Schedule Contract with IBM Corp.
#
#
# If the modem has configuration switches, they should be set to the
# factory default settings.

ICDelay 1
DefaultT0 10
CallDelay 120
# AT Attention Code           , Inserts delay in dialing commands
# Z0  Reset. Restore Profile 0 Q0  Turn on responses
# E0  Turn echo off           Q1  Turn off responses
# V0  Use numeric responses    S0=0 Automatic answer inhibit
# +++ Escape to command mode  S0=2 Answer on second ring
# H0  Hang-up                 X0=0 Limit modem response codes
#                               T = Tone mode. When used as T\r, it is a
#                               no op to maintain program synchronization
#                               when modem may/will echo the commands.
#
#
# %N Call-Out phone number    %P  Paging phone number
# %S Modem speed (available to users)
#
# Following are common responses from a wide range of modems:
# 16, 15, 12, 10, 5 and 1 are connection responses. Add others as required.
# 7=busy; 6=no dial tone; 4=error; 3=no carrier; 2=ring; 0=OK
#
# PROGRAMMING NOTE: No blanks between double quote marks (").

condout:  send "ATZ0Q0T\r"           # Reset modem. Select profile 0
          ignore "\r" or "OK\r\n" timeout 2 # Ignore modem response.
          send "ATE0T\r"             # Initialize modem: Echo OFF,
          expect "\r" or "OK\r\n" timeout 2 # Enable responses (Numeric),
          send "ATQ0V0X0T\r"         # Limit response codes.
          expect "\r" timeout 2       # Confirm commands successful.
          send "ATS0=0\r"             # Set AutoAnswer OFF
          expect "\r" timeout 2       # Confirm command successful.
          done

connect:  send "ATDT%N\r"            # Tone dialing command.
          # %N from Call Home setup.

          # Expect a connection response.
          expect "16\r" or "15\r" or "14\r" or "12\r" or "10\r" or "5\r" or "1\r" busy "7\r"
          timeout 60
          done

retry:    send "A/"                  # Repeat the previous command.

          # Expect a connection response.
```

```

expect "16\r" or "15\r" or "14\r" or "12\r" or "10\r" or "5\r" or "1\r" busy "7\r"
timeout 60
done

disconnect:
delay 2 # Separate from previous data.
send "+++" # Assure command mode.
delay 2 # Allow mode switching delay.
send "ATH0T\r" # Set modem switch-hook down
# (i.e., hang up).
ignore "0\r" or "OK\r" timeout 2 # Ignore modem response.
send "ATE0Q1\r" # Initialize modem: Echo OFF,
# Disable responses.

ignore "0\r" timeout 1
done

condin: send "ATZ0Q0T\r" # Reset modem. Select profile 0
ignore "0\r" or "OK\r\n" timeout 2 # Ignore modem response.
send "ATE0T\r" # Initialize modem: Echo OFF,
expect "0\r" or "OK\r\n" timeout 2 # Enable responses (Numeric),
send "ATQ0V0X0T\r" # Limit response codes.
expect "0\r" timeout 2 # Confirm commands successful.
send "ATS0=2\r" # Set AutoAnswer ON
expect "0\r" timeout 2 # Confirm command successful.
done

waitcall: ignore "2\r" timeout 1 # Ignore first ring.
expect "2\r" timeout 10 # Pick up second ring
# or timeout.
# Expect a connection response.

expect "16\r" or "15\r" or "14\r" or "12\r" or "10\r" or "5\r" or "1\r"
timeout 60
done

page: send "ATDT%N,,,%R;\r" # %N = pager call center number
# Add enough commas to wait for
# time to enter paging number.
# %R = paging number

# Confirm successful command.

expect "0\r" timeout 60
delay 2 # Wait before hanging up.
send "ATH0T\r" # Hang up.
expect "0\r" timeout 2 # Confirm successful command.
done

ripo: send "ATZ0Q0T\r" # Reset modem. Select profile 0
ignore "0\r" or "OK\r\n" timeout 2 # Ignore modem response.
send "ATE0T\r" # Initialize modem: Echo OFF,
expect "0\r" or "OK\r\n" timeout 2 # Enable responses (Numeric),
send "ATQ0V0X0T\r" # Limit response codes.
expect "0\r" timeout 2 # Confirm commands successful.
send "ATS0=0\r" # Set AutoAnswer OFF
expect "0\r" timeout 2 # Confirm command successful.
done # RI Power On enabled.

error: # Handle unexpected modem
# responses.
expect "8\r" or "7\r" or "6\r" or "4\r" or "3\r"
delay 2
done

```

Sample File modem_f.cfg

```
#
# COMPONENT_NAME: (ESPSETUP) ENTRY SERVICE PROCESSOR SETUP F
#
# FUNCTIONS: Modem configuration file for many recent Hayes* compatible modems.
# This example uses the AT&F reset command to choose the factory defaults.
# This set up is preferred for modems with extended (&) commands. For early
# vintage modems, setup Z or Z0 is recommended. If your modem responds to
# the extended (&) commands and to factory default choices (&Fn), setup file
# F0 or F1 is recommended.
#
# * Trademark of Hayes Microcomputer Products, Inc.
#
# (C) COPYRIGHT International Business Machines Corp. 1996
# All Rights Reserved
# Licensed Materials - Property of IBM
#
# US Government Users Restricted Rights - Use, duplication or
# disclosure restricted by GSA ADP Schedule Contract with IBM Corp.
#
#
# If the modem has configuration switches, they should be set to the
# factory default settings.

ICDelay 1
DefaultT0 10
CallDelay 120
# AT Attention Code , Inserts delay in dialing commands
# &F Reset to default profile Q0 Turn on responses
# E0 Turn echo off Q1 Turn off responses
# V0 Use numeric responses S0=0 Automatic answer inhibit
# +++ Escape to command mode S0=2 Answer on second ring
# H0 Hang-up X0=0 Limit modem response codes
# T = Tone mode. When used as T\r, it is a
# no op to maintain program synchronization
# when modem may/will echo the commands.
#
# &C1 Detect CD &D2 Respond to DTR (often the default)
#
# %N Call-Out phone number %P Paging phone number
# %S Modem speed (available to users)
#
# Following are common responses from a wide range of modems:
# 16, 15, 12, 10, 5 and 1 are connection responses. Add others as required.
# 7=busy; 6=no dial tone; 4=error; 3=no carrier; 2=ring; 0=OK
#
# PROGRAMMING NOTE: No blanks between double quote marks (").

connect: send "AT&FQ0T\r" # Reset to factory defaults.
         ignore "0\r" or "OK\r\n" timeout 2 # Ignore modem response.
         send "ATE0T\r" # Initialize modem: Echo OFF,
         expect "0\r" or "OK\r\n" timeout 2 # Enable responses (Numeric),
         send "ATQ0V0X0T\r" # Limit response codes.
         expect "0\r" timeout 2 # Confirm commands successful.
         send "ATS0=0\r" # Set AutoAnswer OFF
         expect "0\r" timeout 2 # Confirm command successful.
         send "AT&C1&D2\r" # Detect carrier and DTR.
         expect "0\r" timeout 2 # Confirm command successful.
         done

connect: send "ATDT%N\r" # Tone dialing command.
         # %N from Call Home setup.

         # Expect a connection response.
         expect "16\r" or "15\r" or "14\r" or "12\r" or "10\r" or "5\r" or "1\r" busy "7\r"
         timeout 60
```

```

done

retry:    send "A/"                                # Repeat the previous command.

                                                # Expect a connection response.
expect "16\r" or "15\r" or "14\r" or "12\r" or "10\r" or "5\r" or "1\r" busy "7\r"
timeout 60
done

disconnect:
delay 2                                         # Separate from previous data.
send "+++"                                     # Assure command mode.
delay 2                                         # Allow mode switching delay.
send "ATH0T\r"                                  # Set modem switch-hook down
                                                # (i.e., hang up).
ignore "0\r" or "OK\r" timeout 2              # Ignore modem response.
send "ATE0Q1\r"                                # Initialize modem: Echo OFF,
                                                # Disable responses.

ignore "0\r" timeout 1
done

conadin:  send "AT&FQ0T\r"                       # Reset to factory defaults.
ignore "0\r" or "OK\r\n" timeout 2           # Ignore modem response.
send "ATE0T\r"                                 # Initialize modem: Echo OFF,
expect "0\r" or "OK\r\n" timeout 2           # Enable responses (Numeric),
send "ATQ0V0X0T\r"                           # Limit response codes.
expect "0\r" timeout 2                       # Confirm commands successful.
send "ATS0=2\r"                               # Set AutoAnswer ON
expect "0\r" timeout 2                       # Confirm command successful.
send "AT&C1&D2\r"                            # Detect carrier and DTR.
expect "0\r" timeout 2                       # Confirm command successful.
done

waitcall: ignore "2\r" timeout 1              # Ignore first ring.
expect "2\r" timeout 10                      # Pick up second ring
                                                # or timeout.
                                                # Expect a connection response.
expect "16\r" or "15\r" or "14\r" or "12\r" or "10\r" or "5\r" or "1\r"
timeout 60
done

page:    send "ATDT%N,,,%R;\r"                # %N = pager call center number
                                                # Add enough commas to wait for
                                                # time to enter paging number.
                                                # %R = paging number

                                                # Confirm successful command.
expect "0\r" timeout 60
delay 2                                         # Wait before hanging up.
send "ATH0T\r"                                  # Hang up.
expect "0\r" timeout 2                       # Confirm successful command.
done

ripo:    send "AT&FQ0T\r"                       # Reset to factory defaults.
ignore "0\r" or "OK\r\n" timeout 2           # Ignore modem response.
send "ATE0T\r"                                 # Initialize modem: Echo OFF,
expect "0\r" or "OK\r\n" timeout 2           # Enable responses (Numeric),
send "ATQ0V0X0T\r"                           # Limit response codes.
expect "0\r" timeout 2                       # Confirm commands successful.
send "ATS0=0\r"                               # Set AutoAnswer OFF
expect "0\r" timeout 2                       # Confirm command successful.
send "AT&C1&D2\r"                            # Detect carrier and DTR.
expect "0\r" timeout 2                       # Confirm command successful.
done                                           # RI Power On enabled.

error:                                         # Handle unexpected modem
                                                # responses.

```

```
expect "8\r" or "7\r" or "6\r" or "4\r" or "3\r"  
delay 2  
done
```

Sample File modem_f0.cfg

```
#
# COMPONENT_NAME: (ESPSETUP) ENTRY SERVICE PROCESSOR SETUP F0
#
# FUNCTIONS: Modem configuration file for many recent Hayes* compatible modems.
# This example uses the AT&F0 reset command to choose the factory defaults.
# This set up is preferred for modems with extended (&) commands. For early
# vintage modems, setup Z or Z0 is recommended. If your modem responds to
# the extended (&) commands and to factory default choices (&Fn), but doesn't
# work properly with this setup file, setup F1 is recommended.
#
# * Trademark of Hayes Microcomputer Products, Inc.
#
# (C) COPYRIGHT International Business Machines Corp. 1996
# All Rights Reserved
# Licensed Materials - Property of IBM
#
# US Government Users Restricted Rights - Use, duplication or
# disclosure restricted by GSA ADP Schedule Contract with IBM Corp.
#
# If the modem has configuration switches, they should be set to the
# factory default settings.

ICDelay 1
DefaultT0 10
CallDelay 120
# AT Attention Code , Inserts delay in dialing commands
# &F0 Reset. Restore profile 0 Q0 Turn on responses
# E0 Turn echo off Q1 Turn off responses
# V0 Use numeric responses S0=0 Automatic answer inhibit
# +++ Escape to command mode S0=2 Answer on second ring
# H0 Hang-up X0=0 Limit modem response codes
# T = Tone mode. When used as T\r, it is a
# no op to maintain program synchronization
# when modem may/will echo the commands.
#
# &C1 Detect CD &D2 Respond to DTR (often the default)
# &R1 Ignore RTS (CTS)
#
# %N Call-Out phone number %P Paging phone number
# %S Modem speed (available to users)
#
# Following are common responses from a wide range of modems:
# 16, 15, 12, 10, 5 and 1 are connection responses. Add others as required.
# 7=busy; 6=no dial tone; 4=error; 3=no carrier; 2=ring; 0=OK
#
# PROGRAMMING NOTE: No blanks between double quote marks (").

condout: send "AT&F0Q0T\r" # Reset modem. Select profile 0
         ignore "\r" or "OK\r\n" timeout 2 # Ignore modem response.
         send "ATE0T\r" # Initialize modem: Echo OFF,
         expect "\r" or "OK\r\n" timeout 2 # Enable responses (Numeric),
         send "ATQ0V0X0T\r" # Limit response codes.
         expect "\r" timeout 2 # Confirm commands successful.
         send "ATS0=0\r" # Set AutoAnswer OFF
         expect "\r" timeout 2 # Confirm command successful.
         send "AT&C1&D2&R1\r" # Detect carrier and DTR,
         # Ignore RTS.
         expect "\r" timeout 2 # Confirm command successful.
         done

connect: send "ATDT%N\r" # Tone dialing command.
         # %N from Call Home setup.

         # Expect a connection response.
```

```

expect "16\r" or "15\r" or "14\r" or "12\r" or "10\r" or "5\r" or "1\r" busy "7\r"
timeout 60
done

retry:    send "A/"                # Repeat the previous command.

                                                # Expect a connection response.
expect "16\r" or "15\r" or "14\r" or "12\r" or "10\r" or "5\r" or "1\r" busy "7\r"
timeout 60
done

disconnect:
delay 2                # Separate from previous data.
send "+++"            # Assure command mode.
delay 2                # Allow mode switching delay.
send "ATH0T\r"        # Set modem switch-hook down
                                                # (i.e., hang up).
ignore "0\r" or "OK\r" timeout 2    # Ignore modem response.
send "ATE0Q1\r"       # Initialize modem: Echo OFF,
                                                # Disable responses.

ignore "0\r" timeout 1
done

condin:   send "AT&F0Q0T\r"        # Reset modem. Select profile 0
ignore "0\r" or "OK\r\n" timeout 2 # Ignore modem response.
send "ATE0T\r"                    # Initialize modem: Echo OFF,
expect "0\r" or "OK\r\n" timeout 2 # Enable responses (Numeric),
send "ATQ0V0X0T\r"                # Limit response codes.
expect "0\r" timeout 2             # Confirm commands successful.
send "ATS0=2\r"                    # Set AutoAnswer ON
expect "0\r" timeout 2             # Confirm command successful.
send "AT&C1&D2&R1\r"              # Detect carrier and DTR,
                                                # Ignore RTS.

expect "0\r" timeout 2             # Confirm command successful.
done

waitcall: ignore "2\r" timeout 1    # Ignore first ring.
expect "2\r" timeout 10           # Pick up second ring
                                                # or timeout.
                                                # Expect a connection response.
expect "16\r" or "15\r" or "14\r" or "12\r" or "10\r" or "5\r" or "1\r"
timeout 60
done

page:     send "ATDT%N,,,%R;\r"    # %N = pager call center number
                                                # Add enough commas to wait for
                                                # time to enter paging number.
                                                # %R = paging number

                                                # Confirm successful command.
expect "0\r" timeout 60
delay 2                # Wait before hanging up.
send "ATH0T\r"        # Hang up.
expect "0\r" timeout 2 # Confirm successful command.
done

ripo:    send "AT&F0Q0T\r"        # Reset modem. Select profile 0
ignore "0\r" or "OK\r\n" timeout 2 # Ignore modem response.
send "ATE0T\r"                    # Initialize modem: Echo OFF,
expect "0\r" or "OK\r\n" timeout 2 # Enable responses (Numeric),
send "ATQ0V0X0T\r"                # Limit response codes.
expect "0\r" timeout 2             # Confirm commands successful.
send "ATS0=0\r"                    # Set AutoAnswer OFF
expect "0\r" timeout 2             # Confirm command successful.
send "AT&C1&D2&R1\r"              # Detect carrier and DTR,
                                                # Ignore RTS.

expect "0\r" timeout 2             # Confirm command successful.

```

```
done                                # RI Power On enabled.
error:                               # Handle unexpected modem
                                     # responses.
expect "8\r" or "7\r" or "6\r" or "4\r" or "3\r"
delay 2
done
```

Sample File modem_f1.cfg

```
#
# COMPONENT_NAME: (ESPSETUP) ENTRY SERVICE PROCESSOR SETUP F1
#
# FUNCTIONS: Modem configuration file for many recent Hayes* compatible modems.
# This example uses the AT&F1 reset command to choose the factory defaults.
# This set up is for modems with extended (&) commands and which do not work
# properly with setup F0. For early vintage modems, setup Z or Z0 is
# recommended.
#
# * Trademark of Hayes Microcomputer Products, Inc.
#
# (C) COPYRIGHT International Business Machines Corp. 1996
# All Rights Reserved
# Licensed Materials - Property of IBM
#
# US Government Users Restricted Rights - Use, duplication or
# disclosure restricted by GSA ADP Schedule Contract with IBM Corp.
#
#
# If the modem has configuration switches, they should be set to the
# factory default settings.

ICDelay 1
DefaultT0 10
CallDelay 120
# AT Attention Code           , Inserts delay in dialing commands
# &F1 Reset. Restore profile 1 Q0 Turn on responses
# E0 Turn echo off           Q1 Turn off responses
# V0 Use numeric responses    S0=0 Automatic answer inhibit
# +++ Escape to command mode S0=2 Answer on second ring
# H0 Hang-up                  X0=0 Limit modem response codes
#                               T = Tone mode. When used as T\r, it is a
#                               no op to maintain program synchronization
#                               when modem may/will echo the commands.
#
#
# &C1 Detect CD                &D2 Respond to DTR (often the default)
# &R1 Ignore RTS (CTS)
#
# %N Call-Out phone number    %P Paging phone number
# %S Modem speed (available to users)
#
# Following are common responses from a wide range of modems:
# 16, 15, 12, 10, 5 and 1 are connection responses. Add others as required.
# 7=busy; 6=no dial tone; 4=error; 3=no carrier; 2=ring; 0=OK
#
# PROGRAMMING NOTE: No blanks between double quote marks (").

condout:  send "AT&F1Q0T\r"           # Reset modem. Select profile 1
          ignore "\0\r" or "OK\r\n" timeout 2 # Ignore modem response.
          send "ATE0T\r"             # Initialize modem: Echo OFF,
          expect "\0\r" or "OK\r\n" timeout 2 # Enable responses (Numeric),
          send "ATQ0V0X0T\r"         # Limit response codes.
          expect "\0\r" timeout 2     # Confirm commands successful.
          send "ATS0=0\r"            # Set AutoAnswer OFF
          expect "\0\r" timeout 2     # Confirm command successful.
          send "AT&C1&D2&R1\r"       # Detect carrier and DTR,
          # Ignore RTS.
          expect "\0\r" timeout 2     # Confirm command successful.
          done

connect:  send "ATDT%N\r"            # Tone dialing command.
          # %N from Call Home setup.
          # Expect a connection response.
          expect "16\r" or "15\r" or "14\r" or "12\r" or "10\r" or "5\r" or "1\r" busy "7\r"
```

```

timeout 60
done

retry:      send "A/"                                # Repeat the previous command.

                                                    # Expect a connection response.
expect "16\r" or "15\r" or "14\r" or "12\r" or "10\r" or "5\r" or "1\r" busy "7\r"
timeout 60
done

disconnect:
delay 2      # Separate from previous data.
send "+++"   # Assure command mode.
delay 2      # Allow mode switching delay.
send "ATH0T\r" # Set modem switch-hook down
                                                    # (i.e., hang up).
ignore "0\r" or "OK\r" timeout 2 # Ignore modem response.
send "ATE0Q1\r" # Initialize modem: Echo OFF,
                                                    # Disable responses.

ignore "0\r" timeout 1
done

condin:     send "AT&F1Q0T\r" # Reset modem. Select profile 1
            ignore "0\r" or "OK\r\n" timeout 2 # Ignore modem response.
            send "ATE0T\r" # Initialize modem: Echo OFF,
            expect "0\r" or "OK\r\n" timeout 2 # Enable responses (Numeric),
            send "ATQ0V0X0T\r" # Limit response codes.
            expect "0\r" timeout 2 # Confirm commands successful.
            send "ATS0=2\r" # Set AutoAnswer ON
            expect "0\r" timeout 2 # Confirm command successful.
            send "AT&C1&D2&R1\r" # Detect carrier and DTR,
            # Ignore RTS.
            expect "0\r" timeout 2 # Confirm command successful.
done

waitcall:   ignore "2\r" timeout 1 # Ignore first ring.
            expect "2\r" timeout 10 # Pick up second ring
            # or timeout.
            # Expect a connection response.
expect "16\r" or "15\r" or "14\r" or "12\r" or "10\r" or "5\r" or "1\r"
timeout 60
done

page:       send "ATDT%N,,,%R;\r" # %N = pager call center number
            # Add enough commas to wait for
            # time to enter paging number.
            # %R = paging number

                                                    # Confirm successful command.
            expect "0\r" timeout 60
            delay 2 # Wait before hanging up.
            send "ATH0T\r" # Hang up.
            expect "0\r" timeout 2 # Confirm successful command.
done

ripo:       send "AT&F1Q0T\r" # Reset modem. Select profile 1
            ignore "0\r" or "OK\r\n" timeout 2 # Ignore modem response.
            send "ATE0T\r" # Initialize modem: Echo OFF,
            expect "0\r" or "OK\r\n" timeout 2 # Enable responses (Numeric),
            send "ATQ0V0X0T\r" # Limit response codes.
            expect "0\r" timeout 2 # Confirm commands successful.
            send "ATS0=0\r" # Set AutoAnswer OFF
            expect "0\r" timeout 2 # Confirm command successful.
            send "AT&C1&D2&R1\r" # Detect carrier and DTR,
            # Ignore RTS.
            expect "0\r" timeout 2 # Confirm command successful.
            done # RI Power On enabled.

```



```
error:                                     # Handle unexpected modem
                                           # responses.
expect "8\r" or "7\r" or "6\r" or "4\r" or "3\r"
delay 2
done
```

Sample File modem_m0.cfg

```
#
# COMPONENT_NAME: (ESPSETUP) ENTRY SERVICE PROCESSOR SETUP: modem_m0
#
# FUNCTIONS: Modem configuration file specifically for IBM 7852-400
# modem with Auto-Reliable feature. This feature must be turned off
# for Catcher calls. This example uses the AT&F reset command to
# choose the factory defaults.
#
# (C) COPYRIGHT International Business Machines Corp. 1996
# All Rights Reserved
# Licensed Materials - Property of IBM
#
# US Government Users Restricted Rights - Use, duplication or
# disclosure restricted by GSA ADP Schedule Contract with IBM Corp.
#
#
# The modem has configuration switches. They should be set to the
# factory default settings, except switches 11 and 12. These must be
# to UP ("AT" responses) and DOWN (Asynchronous operation), respectively.

ICDelay 1
DefaultT0 10
CallDelay 120
#
# %N Call-Out phone number %R Return phone number
#
#
# PROGRAMMING NOTE: No blanks between double quote marks (").

condout: send "AT&F&E2E0T\r" # Reset to factory defaults
# Reliable mode
# Echo off
ignore "0\r" or "OK\r\n" timeout 2 # Ignore modem response.
send "AT&E12&E14\r" # Disable pacing
# Disable data compression
expect "0\r" or "OK\r\n" timeout 2 # Confirm commands successful.
send "AT&SF1&S0S9=1\r" # DSR independent of CD
# Force DSR on.
# CD respond time=100ms
expect "0\r" or "OK\r\n" timeout 2 # Confirm commands successful.
send "ATV0S0=0\r" # Numeric response code
# Auto-Answer off
expect "0\r" or "OK\r\n" timeout 2 # Confirm commands successful.
done

connect: send "ATDT%N\r" # Tone dialing command.
# %N from Call Home setup.
# Expect a connection response.
expect "33\r" or "31\r" or "28\r" or "26\r" or "24\r" or "21\r" or
"19\r" or "13\r" or "12\r" or "1\r" busy "7\r"
timeout 60
done

retry: send "A/" # Repeat the previous command.
# Expect a connection response.
expect "33\r" or "31\r" or "28\r" or "26\r" or "24\r" or "21\r" or
"19\r" or "13\r" or "12\r" or "1\r" busy "7\r"
timeout 60
done

disconnect:
delay 2 # Separate from previous data.
send "+++" # Assure command mode.
delay 2 # Allow mode switching delay.
send "ATH0T\r" # Set modem switch-hook down
```

```

                                # (i.e., hang up).
                                # Ignore modem response.
                                # Initialize modem: Echo OFF,
                                # Disable responses.
                                ignore "0\r" or "OK\r" timeout 2
                                send "ATE0Q1\r"

                                ignore "0\r" timeout 1
                                done

conidin:   send "AT&F&E2E0T\r"          # Reset to factory defaults.
                                                # Reliable mode
                                                # Echo off
                                ignore "0\r" or "OK\r\n" timeout 2      # Ignore modem response.
                                send "AT&E12&E14\r"                       # Disable pacing
                                                # Disable data compression
                                expect "0\r" or "OK\r\n" timeout 2        # Confirm commands successful
                                send "AT&SF1&S0S9=1\r"                    # DSR independent of CD.
                                                # Force DSR on.
                                                # CD respond time=100ms
                                expect "0\r" or "OK\r\n" timeout 2        # Confirm commands successful.
                                send "ATV0S0=2\r"                          # Numeric response code
                                                # Answer on 2nd ring
                                expect "0\r" timeout 2                      # Confirm commands successful.
                                done

waitcall: ignore "2\r" timeout 1          # Ignore first ring.
                                expect "2\r" timeout 10                   # Pickup 2nd ring or timeout
                                                # Expect a connection response.
                                expect "33\r" or "31\r" or "28\r" or "26\r" or "24\r" or "21\r" or
"19\r" or "13\r" or "12\r" or "1\r" busy "7\r"
                                timeout 60
                                done

page:     send "ATDT%N,,,,%R;\r"        # %N = pager call center number
                                                # Add enough commas to wait for
                                                # time to enter paging number.
                                                # %R = paging number
                                expect "0\r" timeout 60                   # Confirm successful command.
                                delay 2                                     # Wait before hanging up.
                                send "ATH0\r"                              # Hang up.
                                expect "0\r" timeout 2                     # Confirm successful command.
                                done

ripo:    send "AT&F&E2E0T\r"          # Reset to factory defaults.
                                                # Reliable mode
                                                # Echo off
                                ignore "0\r" or "OK\r\n" timeout 2      # Ignore modem response.
                                send "AT&E12&E14\r"                       # Disable pacing
                                                # Disable data compression
                                expect "0\r" or "OK\r\n" timeout 2        # Confirm successful command.
                                send "AT&SF1&S0S9=1\r"                    # DSR independent of CD.
                                                # Force DSR on.
                                                # CD respond time=100ms
                                expect "0\r" or "OK\r\n" timeout 2        # Confirm commands successful.
                                send "ATV0S0=0\r"                          # Numeric response code
                                                # Auto Answer OFF
                                expect "0\r" timeout 2                      # Confirm commands successful.
                                done

error:   # Handle unexpected modem
                                                # responses.
                                expect "8\r" or "7\r" or "6\r" or "4\r" or "3\r"
                                delay 2
                                done

```

Sample File modem_m1.cfg

```
#
# COMPONENT_NAME: (ESPSETUP) ENTRY SERVICE PROCESSOR SETUP modem_m1
#
# FUNCTIONS: Modem configuration file specifically for IBM 7857-017 modem with
# Auto-Reliable feature. This feature must be turned off for Catcher calls.
# This example uses the AT&F reset command to choose the factory defaults.
#
# To allow dial commands for digital pagers, it is necessary to reduce
# the number of characters in the dial command. Each comma (delay) has
# been set to 6 seconds (S8=6) for that reason.
#
#
# (C) COPYRIGHT International Business Machines Corp. 1996
# All Rights Reserved
# Licensed Materials - Property of IBM
#
# US Government Users Restricted Rights - Use, duplication or
# disclosure restricted by GSA ADP Schedule Contract with IBM Corp.
#

ICDelay 1
DefaultT0 10
CallDelay 120
#
# %N Call-Out phone number %R Return phone number
#
#
# PROGRAMMING NOTE: No blanks between double quote marks (").

condout: send "AT&F*E0E0\r" # Reset to factory defaults.
# *E0=data compression disabled
# E0=echo disabled
ignore "0\r" or "OK\r\n" timeout 2 # Ignore modem response.
send "AT#F0*Q2S8=6\r" # Trellis modulation disabled
# Retrain with adaptive rate
# Set ,=6second
expect "0\r" or "OK\r\n" timeout 2 # Confirm commands successful
send "ATV0X0S0=0\r" # Numeric response code
# AT compatible messages
# Auto-Answer disabled
expect "0\r" or "OK\r\n" timeout 2 # Confirm commands successful.
done

connect: send "ATDT%N\r" # Tone dialing command.
# %N from Call Home setup.
expect "1\r" busy "7\r" timeout 60 # Expect a connection response.
done

retry: send "A/" # Repeat the previous command.
expect "1\r" busy "7\r" timeout 60 # Expect a connection response.
done

disconnect:
delay 2 # Separate from previous data.
send "+++" # Assure command mode.
delay 2 # Allow mode switching delay.
send "ATH0\r" # Set modem switch-hook down
# (i.e., hang up).
ignore "0\r" or "OK\r" timeout 2 # Ignore modem response.
send "ATE0Q1\r" # Initialize modem: Echo OFF,
# Disable responses.

ignore "0\r" timeout 1
done

condin: send "AT&F*E0E0\r" # Reset to factory defaults.
```

```

# *E0=data compression disabled
# E0=echo disabled
ignore "0\r" or "OK\r\n" timeout 2 # Ignore modem response.
send "AT#F0*Q2\r" # Trellis modulation disabled
# Retrain with adaptive rate
expect "0\r" or "OK\r\n" timeout 2 # Confirm commands successful
send "ATV0X0S0=2\r" # Numeric response code
# AT compatible messages
# Answer on 2nd ring
# Confirm commands successful.

expect "0\r" timeout 2
done

waitcall: ignore "2\r" timeout 1 # Ignore first ring.
expect "2\r" timeout 10 # Pick up second ring
# or timeout.
# Expect a connection response.

expect "1\r" timeout 60
done

page: send "ATD%N,%R\r" # %N = pager call center number
# commas=6sec wait time to
# enter paging number.
# %R = return number
expect "0\r" or "3\r" timeout 30 # Confirm successful command.
delay 2 # Wait before hanging up.
send "+++" # Assure command mode.
delay 2 # Allow mode switching delay.
send "ATH0\r" # Hang up.
expect "0\r" timeout 2 # Confirm successful command.
done

ribo: send "AT&F*E0E0\r" # Reset to factory defaults.
# *E0=data compression disabled
# E0=echo disabled
ignore "0\r" or "OK\r\n" timeout 2 # Ignore modem response.
send "AT#F0*Q2\r" # Trellis modulation disabled
# Retrain with adaptive rate
expect "0\r" or "OK\r\n" timeout 2 # Confirm successful command.
send "ATV0X0S0=0\r" # Numeric response code
# AT compatible messages
# Auto-Answer disabled
# Confirm commands successful.

expect "0\r" timeout 2
done

error: # Handle unexpected modem
# responses.

expect "8\r" or "7\r" or "4\r" or "3\r"
delay 2
done

```

Index

Numerics

- 3.5-inch diskette drive
 - using 2-19
- 4-mm tape cartridge
 - loading 2-38
 - unloading 2-39
- 4.0GB 4-mm tape drive
 - general information 2-30
 - status lights 2-36
 - using 2-36
- 5.0GB 8-mm tape drive
 - general information 2-21
 - status lights 2-25
 - using 2-25
- 7318 communications server service aid 6-35
- 7318 serial communications network server 6-35
- 8-mm tape cartridge
 - loading 2-27
 - unloading 2-28

A

- about this book xxi
- account number 3-24
- AIX location codes 5-15, 5-17
- alter/display bootlist 6-14
 - display or change diagnostic run time options 6-14

B

- backup service processor settings E-1
- battery
 - disposal, recycling xix

- bezel
 - installing 2-59
- boot sequence 4-18

C

- call home, see call-out
- call-in
 - testing E-2
- call-in security 3-30
- call-out
 - policy 3-23
 - testing E-3
- call-out (call-home) 3-36
- caution
 - laser compliance statement xvii
- CD-ROM drive
 - using 2-40
- check points 3-5, 3-14, 3-39
- checklist, setup E-1
- configuration, service processor 3-15
- configuration, system processor 3-15
- configuring disk drives 2-48
- console mirroring
 - enable/disable 3-11
 - quick disconnect 3-37
 - system configuration 3-37
- console select 4-15
- customer administration center 3-22

D

- determining versions D-1
- device records A-5, A-10
 - internal and external options A-5, A-10
 - internal files and devices A-7, A-9

- devices, startup 4-18
- diagnostic considerations
 - running from a TTY terminal 5-3
 - running online 5-2
 - running standalone 5-2
- diagnostics
 - general attributes 5-4
- diagnostics, sources 5-1
- dial-out telephone numbers,
 - setting 3-21
- disk drive
 - See hot swap disk drives
- disk drives 2-48
 - configuring 2-48
 - unconfiguring 2-48
- display/alter bootlist 6-14
- downloading microcode updates D-4

E

- entering open firmware 2-8
- ergonomic information 2-60
- error logs 3-14, 4-6, 4-22

F

- fibre channel RAID service aids 6-20
- fixed disk
 - See hot swap disk drives
- flash SK-NET FDDI firmware 6-21
- function code table C-2
- function keys 2-7

G

- general access password,
 - changing 3-11
- general information for 4.0GB 4-mm tape drive 2-30
- general information for 5.0GB 8-mm tape drive 2-21

- general user menus 3-5

H

- hard disk drive
 - See hot swap disk drives
- hardfile
 - See hot swap disk drives
- hardware problem determination 8-1
- heartbeat 3-34
- hot swap disk drives
 - handling 2-46
 - removing 2-56
 - status lights 2-47
 - using 2-44
- hot-swap disk drives
 - inserting 2-50

I

- I/O Drawer
 - front view 1-7, 1-8
 - indicator panel 2-10
 - reading 2-10
 - rear view 1-9
- I/O drawer locations
 - drawer 0 5-26
 - drawer 1 5-32
 - drawer 2 5-36
 - drawer 3 5-40
- indicator panel, 10 EIA Unit I/O Drawer 2-10
- inserting a SCSI disk drive 2-50
- installing
 - bezel 2-59
- installing microcode update D-8

K

- keyboards
 - using 2-13

L

- language selection 3-16
- laser compliance statement xvii
- laser safety information xvii
- LCD progress indicator log 3-39
- LEDs
 - power, I/O Drawer 2-11
- loading the 4-mm tape cartridge 2-38
- loading the 8-mm tape cartridge 2-27
- local area network service aid 6-24
- location code
 - format 5-13
- location codes 5-13, 5-17
 - AIX 5-15
 - physical 5-13
- locations
 - AIX 5-17
 - location code reference tables 5-17
 - logical 5-13
 - physical 5-13, 5-17

M

- memory configuration records A-1
- menu inactivity 3-4
- menus
 - general user 3-5
 - privileged user 3-7
 - returning to SP menus 3-4
 - SP 3-3
 - SP call-in/call-out setup 3-17
 - SP call-out policy setup 3-23
 - SP customer account setup 3-24
 - SP language selection 3-16
 - SP reboot policy setup 3-25
 - SP serial port selection 3-19
 - SP serial port speed setup 3-20
 - SP setup 3-9
 - SP system information 3-14
 - SP system power control 3-13

menus (*continued*)

- SP telephone setup 3-21
- support menus
 - SMS 3-2
 - SP menus 3-2
 - SP service aids 3-2
- microcode
 - downloading updates D-4
 - installing updates D-8
 - promoting update D-10
 - update procedures D-1
- microcode updates, downloading D-4
- microcode versions, determining D-1
- modem
 - configuration file selection F-2
 - configurations F-1
 - seamless transfer F-7
- modem_f.cfg, sample file F-13
- modem_f0.cfg, sample file F-16
- modem_f1.cfg, sample file F-19
- modem_m0.cfg, sample file F-22
- modem_m1.cfg, sample file F-24
- modem_z.cfg, sample file F-9
- modem_z0.cfg, sample file F-11
- mouse
 - using 2-15
- multiboot 4-16

N

- network 6-24
 - local area analyzer task 6-24
 - local area service aid 6-24
- notices
 - laser compliance statement xvii
- NVRAM 3-15

O

- online diagnostics
 - concurrent mode 5-10

- online diagnostics (*continued*)
 - maintenance mode 5-11
 - service mode 5-9
- online diagnostics modes of operation 5-9
- open firmware, entering 2-8
- operating considerations
 - standalone and online diagnostics 5-1
- operator panel
 - functions C-1
- operator panel display
 - locations 2-1
 - reading, System Rack 2-9
- overview 1-1
 - I/O connectors 1-9
 - I/O Drawer 1-7
 - I/O rack 1-5
 - System Rack 1-3

P

- pager 3-22
- panel, indicator 2-10
- passwords
 - changing general access
 - password 3-11
 - changing privileged access
 - password 3-10, 4-4
 - overview 3-10
- physical location codes 5-13, 5-17
- ping 4-9
- POST errors
 - read 3-6, 3-15
- POST indicators 2-5
- power
 - powering off the system 2-2
 - powering on the system 2-2
- power LED 2-10

- power-on methods 3-29
- preface xxi
- primary console F-8
- privileged access password, changing 3-10
- privileged user menus 3-7
- problem determination
 - using the standalone or online diagnostics 8-1, 8-11
 - when unable to load diagnostics 8-11
- procedures
 - updating microcode D-1
- product disposal xix
- progress indicators 3-5, 3-14, 3-39

R

- read system, POST errors 3-6, 3-15
- reboot recovery 3-31
- records, device A-5, A-10
- recycling xix
- reference tables
 - aix location code 5-17
 - physical location code 5-17
- related publications xxi
- remote initial program load
 - See RIPL
- remote latency 3-23
- remote timeout 3-23
- removing a hot-swap disk drive 2-56
- restart recovery 3-31
- restoring service processor
 - settings 3-4
- RETAIN 3-24
- retries 3-23
- RIO cabling configurations A-3
- RIPL 4-7
- run exercisers 6-27

running the online diagnostics in concurrent mode 5-11
running the online diagnostics in maintenance mode 5-11
running the online diagnostics in service mode 5-9
running the standalone diagnostics 5-12

S

safety

laser compliance statement xvii

safety notices xv

saving service processor settings 3-4, E-1

SCSI (small computer system interface)

seamless transfer of a modem session F-7

security, call-in 3-30

sequence, startup 4-18

service aids

7135 RAIDiant array 6-33

add resource to resource list 6-4

AIX shell prompt 6-4

backup/restore media 6-4

certify media 6-5

configure dials and LPFKeys 6-6

configure reboot policy 6-6

configure remote maintenance policy 6-8

configure surveillance policy 6-10

create customized configuration diskette 6-11

disk based diagnostic 6-32

disk to disk copy 6-12

display firmware device node information 6-13

display hardware error report 6-13

display microcode level 6-14

display previous diagnostic results 6-15

service aids (*continued*)

display resource attributes 6-16

display service hints 6-16

display test patterns 6-18

display/alter sector 6-13

download microcode 6-18

fibre channel RAID service aids 6-20

flash SK-NET FDDI firmware 6-21

format media 6-21

generic microcode download 6-24

machine check error log 6-14

PCI RAID physical disk identify 6-25

periodic diagnostics 6-25

ring indicate power on policy 6-10

run exercisers 6-27

save or restore hardware management policies 6-28

SCSD tape drive 6-30

SCSI bus analyzer 6-29

SCSI device identification and removal 6-30

spare sector availability 6-32

SSA service aids 6-32

tasks 6-1

update system or service processor flash 6-32

service center 3-22

service director feature 2-61

service mode

service processor procedures 3-26

service processor call-in security 3-30

service processor checklist E-1

service processor configuration 3-15

service processor feature 2-61

service processor installation checklist E-1

service processor procedures in service mode 3-26

- service processor settings 3-4
 - restoring 3-4
 - saving 3-4
- service processor settings, backup E-1
- service processor setup E-1
- service processor setup checklist E-1
- service processor test E-1
- service processor, also see SP
- service provider 3-22
- small computer system interface (SCSI)
 - See SCSI (small computer system interface)
- SP menus
 - accessing locally 3-3
 - accessing remotely 3-3
 - call-in/call-out 3-17
 - call-out policy 3-23
 - customer account 3-24
 - general user 3-5
 - language selection 3-16
 - menu inactivity 3-4
 - privileged user 3-7
 - reboot policy 3-25
 - restart policy 3-25
 - returning to 3-4
 - serial port selection 3-19
 - serial port speed setup 3-20
 - setup menu 3-9
 - supported menu options 3-2
 - system information 3-14
 - system power control 3-13
 - telephone number 3-21
- SPCN cabling configurations A-4
- SSA service aids 6-32
- standalone and online diagnostics operating considerations 5-1
- standalone diagnostic operation 5-12
- standalone diagnostics
 - running 5-12
- start talk mode 3-11
- start up program 4-18
- starting system programs 4-20
- surveillance
 - failure 3-34
 - operating system 3-34
 - set parameters 3-12
 - system firmware 3-34
- system
 - powering off 2-2
 - powering on 2-2
- system administrator 3-22
- system error log, displaying 4-22
- system information menu 3-14
- system introduction 1-1
- system management services
 - graphical 4-1
 - text-based 4-20
- system phone number 3-22
- system POST errors
 - read 3-6, 3-15
- system power-on methods 3-29
- system processor configuration
 - menu 3-15
- System Rack location codes 5-17
- System Rack operator panel
 - display 2-9
- system records A-1
 - cabling configurations, RIO A-3
 - cabling configurations, SPCN A-4
 - key serial number A-1
 - machine type/model A-1
 - memory configuration A-1
 - serial number A-1
- system verification procedure 7-1

T

- tasks 6-1
 - display hardware error log
 - task 6-13

tasks (*continued*)

- display or change diagnostic 6-14
- process supplemental media 6-25
- run diagnostics task 6-26
- run error log analysis 6-27

testing the setup

- call-in E-2
- call-out E-3

trademarks xxi

web sites

- ergonomic information 2-60

U

unattended start mode,

- enable/disable 3-13

unconfiguring disk drives 2-48

unloading the 4-mm tape

- cartridge 2-39

unloading the 8-mm tape

- cartridge 2-28

updating microcode D-1

using

- 3.5-inch diskette drive 2-19
- 4.0GB 4-mm tape drive 2-36
- 5.0GB 8-mm tape drive 2-25
- CD-ROM drive 2-40
- hot swap disk drives 2-44
- keyboards 2-13
- mouse 2-15
- system verification procedure 7-1

using service director 2-61

using service processor 2-61

V

vital product data, see VPD

voice phone number 3-22

VPD (vital product data) 3-14

W

Reader's Comments — We'd Like to Hear From You

RS/6000 Enterprise Servers S70 and S7A and User's Guide

Part Number: SA38-0549-01

Overall how satisfied are you with the information in this book?

| | Very Satisfied | Satisfied | Neutral | Dissatisfied | Very Dissatisfied |
|----------------------|--------------------------|--------------------------|--------------------------|--------------------------|--------------------------|
| Overall Satisfaction | <input type="checkbox"/> | <input type="checkbox"/> | <input type="checkbox"/> | <input type="checkbox"/> | <input type="checkbox"/> |

How satisfied are you that the information in this book is:

| | Very Satisfied | Satisfied | Neutral | Dissatisfied | Very Dissatisfied |
|--------------------------|--------------------------|--------------------------|--------------------------|--------------------------|--------------------------|
| Accurate | <input type="checkbox"/> | <input type="checkbox"/> | <input type="checkbox"/> | <input type="checkbox"/> | <input type="checkbox"/> |
| Complete | <input type="checkbox"/> | <input type="checkbox"/> | <input type="checkbox"/> | <input type="checkbox"/> | <input type="checkbox"/> |
| Easy to find | <input type="checkbox"/> | <input type="checkbox"/> | <input type="checkbox"/> | <input type="checkbox"/> | <input type="checkbox"/> |
| Easy to understand | <input type="checkbox"/> | <input type="checkbox"/> | <input type="checkbox"/> | <input type="checkbox"/> | <input type="checkbox"/> |
| Well organized | <input type="checkbox"/> | <input type="checkbox"/> | <input type="checkbox"/> | <input type="checkbox"/> | <input type="checkbox"/> |
| Applicable to your tasks | <input type="checkbox"/> | <input type="checkbox"/> | <input type="checkbox"/> | <input type="checkbox"/> | <input type="checkbox"/> |

Please tell us how we can improve this book:

Thank you for your response. May we contact you? Yes No

When you send comments to us, you grant us a nonexclusive right to use or distribute your comments in any way we believe appropriate without incurring any obligation to you.

Name

Address

Company or Organization

Phone Number

Cut or Fold
Along Line

Fold and Tape

Please do not Staple

Fold and Tape



NO POSTAGE
NECESSARY
IF MAILED IN THE
UNITED STATES



BUSINESS REPLY MAIL

POSTAGE WILL BE PAID BY ADDRESSEE

Information Development
Department H6DS-9561
11400 Burnet Road
Austin, TX 78758-3493



Fold and Tape

Please do not Staple

Fold and Tape

Cut or Fold
Along Line



Part Number: 08L0658



Printed in the United States of America
on recycled paper containing 10%
recovered post-consumer fiber.

SA38-0549-01



08L0658

