

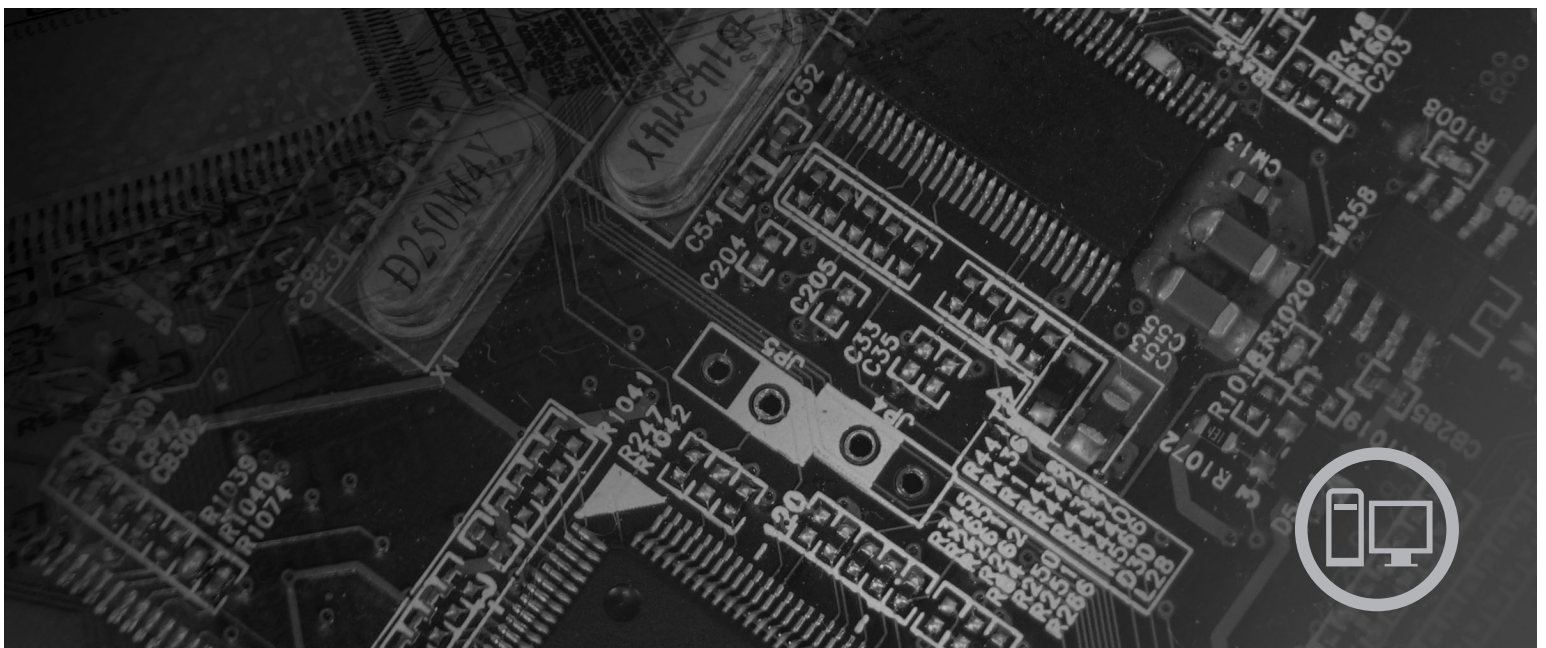

Lenovo 3000 Hardware Installation and Replacement Guide



Machine Types 9680, 9681, 9682, 9683, 9684, 9685

lenovo

Lenovo 3000

Note

Before using this information and the product it supports, be sure to read and understand the *Safety and Warranty Guide* for this product and "Notices," on page 41.

Third Edition (September 2007)

© Copyright Lenovo 2005, 2007.

Portions © Copyright International Business Machines Corporation 2005.

All rights reserved.

LENOVO products, data, computer software, and services have been developed exclusively at private expense and are sold to governmental entities as commercial items as defined by 48 C.F.R. 2.101 with limited and restricted rights to use, reproduction and disclosure.

LIMITED AND RESTRICTED RIGHTS NOTICE: If products, data, computer software, or services are delivered pursuant a General Services Administration "GSA" contract, use, reproduction, or disclosure is subject to restrictions set forth in Contract No. GS-35F-05925.

Contents

Figures	v	Replacing the hard disk drive	21
Chapter 1. Important safety information	1	Replacing the diskette drive	23
Chapter 2. Overview	3	Replacing an optical drive	24
Additional information resources	3	Replacing the heat sink and fan assembly	25
Handling static-sensitive devices.	3	Replacing the system fan assembly	29
Locations	4	Replacing a memory module	30
Locating controls and connectors on the front of your computer.	4	Replacing a PCI adapter	31
Locating connectors on the rear of your computer	5	Replacing a keyboard	32
Locating components	7	Replacing a mouse	33
Identifying parts on the system board	8	Chapter 4. Completing the parts replacement	35
Chapter 3. Installing options and replacing hardware	11	Obtaining device drivers	36
Tools required	11	Chapter 5. Security features	37
Installing external options	11	Integrated cable lock	37
Removing the cover	11	Padlock.	38
Accessing system board components and drives	12	Password protection	38
Installing internal options	13	Erasing a lost or forgotten password (clearing CMOS).	38
Installing memory	13	Appendix. Notices	41
Installing PCI adapters	15	Television output notice	42
Installing internal drives	16	Trademarks	42
Replacing the battery	20		

Figures

1. Controls and connectors	4	26. Removing the diskette drive	24
2. Rear connector locations	5	27. Retaining bracket for diskette drive	24
3. Component locations	7	28. Installing the new diskette drive	24
4. Location of parts on system board	8	29. Removing the optical drive	25
5. Location of parts on the system board	9	30. Retaining bracket for optical drive	25
6. Location of parts on the system board	10	31. Installing the new optical drive	25
7. Removing the computer cover	12	32. Removing the heat sink held in place by a clamp	26
8. Removing the bezel	12	33. Removing the heat sink held in place by screws	27
9. Removing the PCI adapter	13	34. Clamping the heat sink to the plastic retention bracket	28
10. Removing the drive bay assembly	13	35. Replacing the screws to the heat sink and fan assembly	28
11. Retaining clips	14	36. Removing the system fan assembly	29
12. Positioning the memory module	14	37. Removing the memory module	30
13. Opening the adapter latch	15	38. Installing the memory module	31
14. Securing the adapter	16	39. Removing the adapter	32
15. Locating drive bays	17	40. Installing the new adapter	32
16. Retaining bracket	18	41. Keyboard connectors	33
17. Installing the drive	18	42. Mouse connectors	34
18. Connecting a parallel ATA drive	19	43. Installing the computer cover	35
19. Connecting a serial ATA drive	19	44. Kensington lock location	37
20. Retaining bracket	20	45. Padlock loop	38
21. Installing the diskette drive	20		
22. Battery removal	21		
23. Battery installation	21		
24. Removing the hard disk drive	22		
25. Installing the hard disk drive into bracket	23		

Chapter 1. Important safety information

CAUTION:

Before using this manual, it is important that you read and understand all the related safety information for this product. Refer to the *Safety and Warranty Guide* that you received with this product for the latest safety information. Reading and understanding this safety information reduces the risk of personal injury and or damage to your product.

If you no longer have a copy of the *Safety and Warranty Guide*, you can obtain one online from the Lenovo Support Web site at:
<http://www.lenovo.com/support>.

Chapter 2. Overview

This guide is intended to be used by customers who are installing or replacing Customer Replaceable Units (CRUs).

This guide does not include procedures for all parts. It is expected that cables, switches, and certain mechanical parts can be replaced by trained service personnel without the need for step-by-step procedures.

Note: Use only the parts provided by Lenovo™.

This guide contains instructions for installing or replacing the following parts:

- Battery
- Hard disk drive
- Diskette drive
- Optical drive
- Heat sink and fan assembly
- System fan assembly
- Memory module
- PCI adapter card
- Keyboard
- Mouse

Additional information resources

If you have Internet access, the most up-to-date information for your computer is available from the World Wide Web.

You can find:

- CRU removal and installation instructions
- CRU removal and installation videos
- Publications
- Troubleshooting information
- Parts information
- Downloads and drivers
- Links to other useful sources of information
- Support phone list

To access this information, point your browser to <http://www.lenovo.com/support>

Handling static-sensitive devices

Do not open the static-protective package containing the new part until the defective part has been removed from the computer and you are ready to install the new part. Static electricity, although harmless to you, can seriously damage computer components and parts.

When you handle parts and other computer components, take these precautions to avoid static-electricity damage:

- Limit your movement. Movement can cause static electricity to build up around you.
- Always handle parts and other computer components carefully. Handle adapters, memory modules, system boards, and microprocessors by the edges. Never touch any exposed circuitry.
- Prevent others from touching the parts and other computer components.
- Before you replace a new part, touch the static-protective package containing the part to a metal expansion-slot cover or other unpainted metal surface on the computer for at least two seconds. This reduces static electricity in the package and your body.
- When possible, remove the new part from the static-protective packaging, and install it directly in the computer without setting the part down. When this is not possible, place the static-protective package that the part came in on a smooth, level surface and place the part on it.
- Do not place the part on the computer cover or other metal surface.

Locations

This chapter provides illustrations to help locate the various connectors, controls and components of the computer. To remove the computer cover, see “Removing the cover” on page 11.

Locating controls and connectors on the front of your computer

Figure 1 shows the location of connectors on the front of the computer.

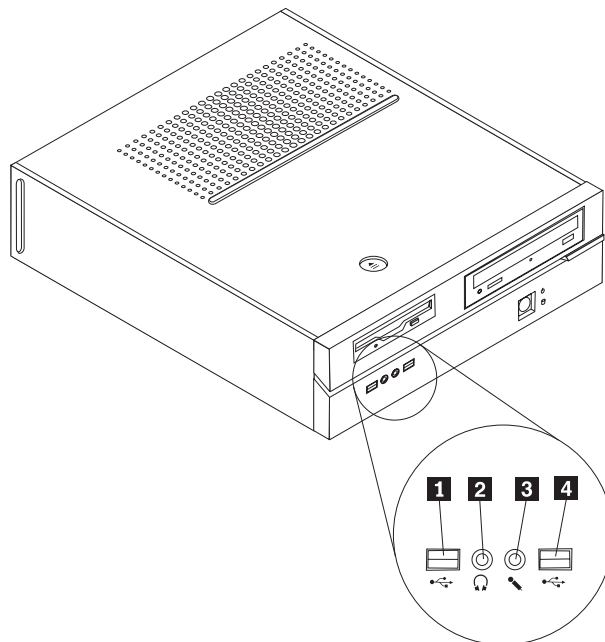

Figure 1. Controls and connectors

- | | | | |
|----------|---------------------|----------|----------------------|
| 1 | USB connector | 3 | Microphone connector |
| 2 | Headphone connector | 4 | USB connector |

Locating connectors on the rear of your computer

Figure 2 shows the location of connectors on the rear of the computer.

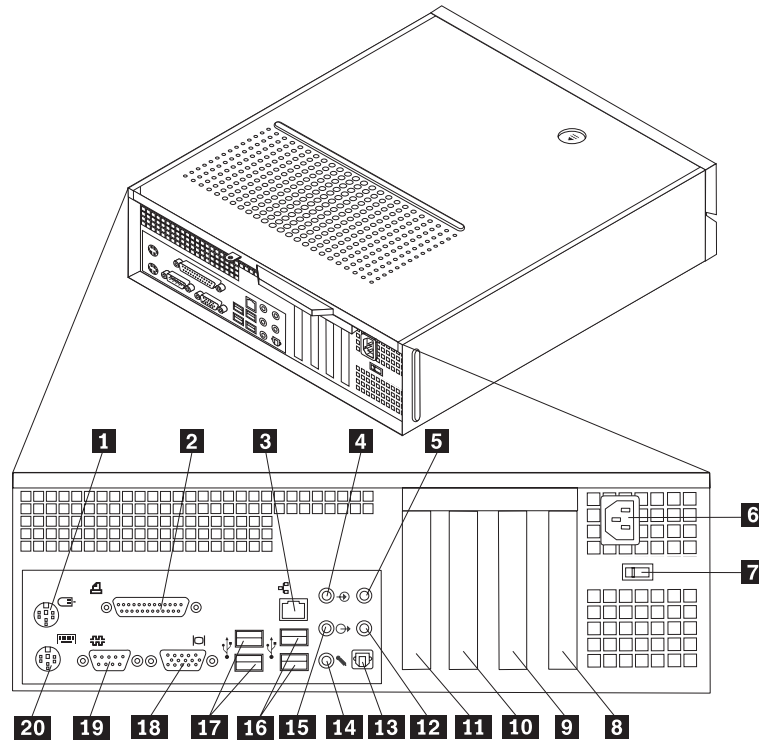

Figure 2. Rear connector locations

- | | | | |
|-----------|--|-----------|--|
| 1 | Standard mouse connector | 11 | PCI Express 1x adapter or PCI Express x16 graphics adapter connector |
| 2 | Parallel connector | 12 | C/LFE connector (some models) |
| 3 | Ethernet connector | 13 | SPDIF connector (some models) |
| 4 | Audio line in connector | 14 | Audio line out connector |
| 5 | Back surround connector (some models) | 15 | Microphone connector |
| 6 | Power cord connector | 16 | USB connectors (2) |
| 7 | Voltage-selection switch (some models) | 17 | USB connectors (2) |
| 8 | PCI adapter connector | 18 | VGA monitor connector |
| 9 | PCI adapter or PCI Express 1x adapter connector | 19 | Serial connector |
| 10 | PCI Express 1x adapter or PCI Express x16 graphics adapter connector | 20 | Standard keyboard connector |

Connector	Description
Standard mouse connector	Used to attach a mouse, trackball, or other pointing device that uses a standard mouse connector.
USB connectors	Used to attach a device that requires a Universal Serial Bus (USB) connection, such as a USB keyboard, USB mouse, USB scanner or USB printer. If you have more than eight USB devices, you can purchase a USB hub, which you can use to connect additional USB devices.
Ethernet connector	Used to attach an Ethernet cable for a local area network (LAN). Note: To operate the computer within FCC Class B limits, use a Category 5 Ethernet cable.
Serial connector	Used to attach an external modem, serial printer, or other devices that use a 9-pin serial connector.
Parallel connector	Used to attach a parallel printer, parallel scanner, or other devices that use a 25-pin parallel connector.
Audio-line-in connector	Used to receive audio signals from an external audio device, such as a stereo system. When you attach an external audio device, a cable is connected between the audio line out connector of the device and the audio line in connector of the computer.
Audio-line-out connector	Used to send audio signals from the computer to external devices, such as powered stereo speakers (speakers with built-in amplifiers), headphones, multimedia keyboards, or the audio line in connector on a stereo system or other external recording device.
Standard keyboard connector	Used to attach a keyboard that uses a standard keyboard connector.

Locating components

Figure 3 will help you locate the various components in your computer.

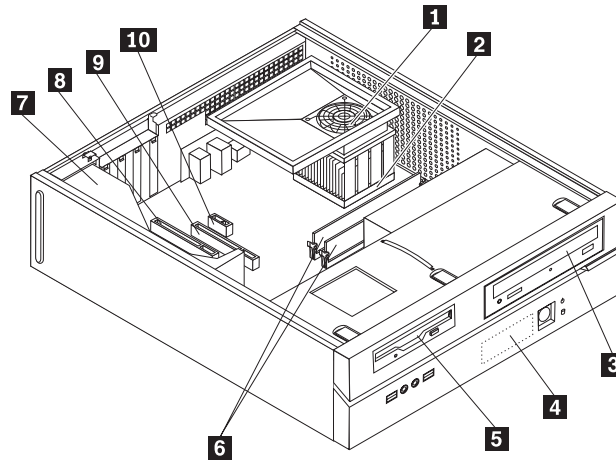

Figure 3. Component locations

- | | | | |
|----------|--------------------------------|-----------|--|
| 1 | Fan plenum, fan, and heat sink | 6 | Memory modules |
| 2 | Microprocessor | 7 | Power supply |
| 3 | Optical drive | 8 | PCI adapter or PCI Express x1 adapter connector |
| 4 | Hard disk drive | 9 | PCI Express x16 graphics adapter or PCI Express x1 adapter connector |
| 5 | Diskette drive | 10 | PCI Express x1 adapter or PCI Express x16 graphics adapter connector |

Identifying parts on the system board

The system board (sometimes called the planar or motherboard) is the main circuit board in your computer. It provides basic computer functions and supports a variety of devices.

Figure 4 shows the locations of parts on the system board for some computer models.

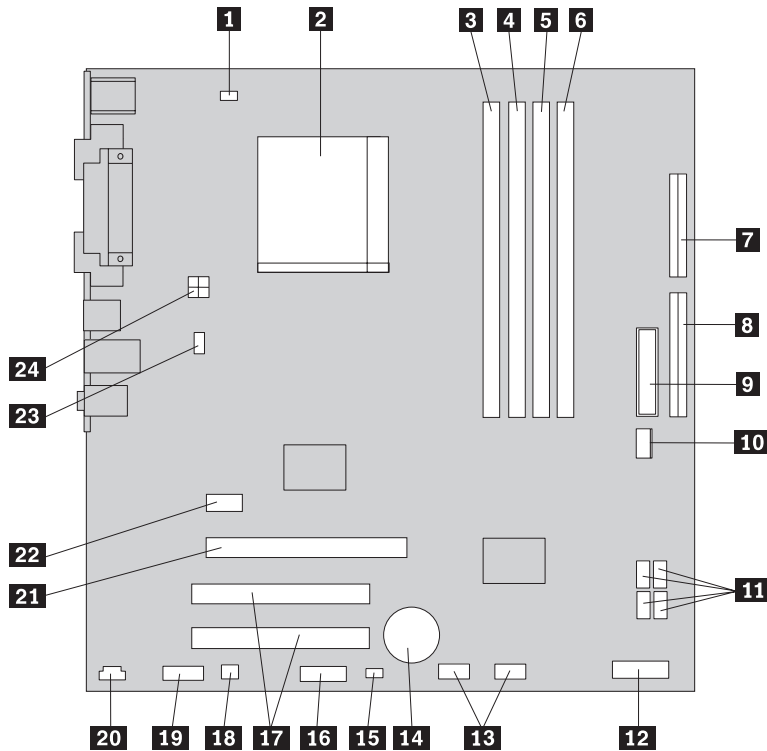

Figure 4. Location of parts on system board

- | | | | |
|-----------|------------------------------|-----------|--|
| 1 | Microprocessor fan connector | 13 | Front USB connectors (2) |
| 2 | Microprocessor and heat sink | 14 | Battery |
| 3 | Memory connector 1 | 15 | Clear CMOS/Recovery jumper |
| 4 | Memory connector 2 | 16 | Serial (COM) connector |
| 5 | Memory connector 3 | 17 | PCI adapter connectors (2) |
| 6 | Memory connector 4 | 18 | Mono (speaker) connector |
| 7 | Diskette drive connector | 19 | Front audio connector |
| 8 | IDE connector | 20 | CD-IN connector |
| 9 | Power connector | 21 | PCI Express x16 graphics adapter connector |
| 10 | Power fan connector | 22 | PCI Express x1 adapter connector |
| 11 | SATA IDE connectors (4) | 23 | System fan connector |
| 12 | Front panel connector | 25 | 12v power connector |

Figure 5 shows the locations of parts on the system board for some computer models.

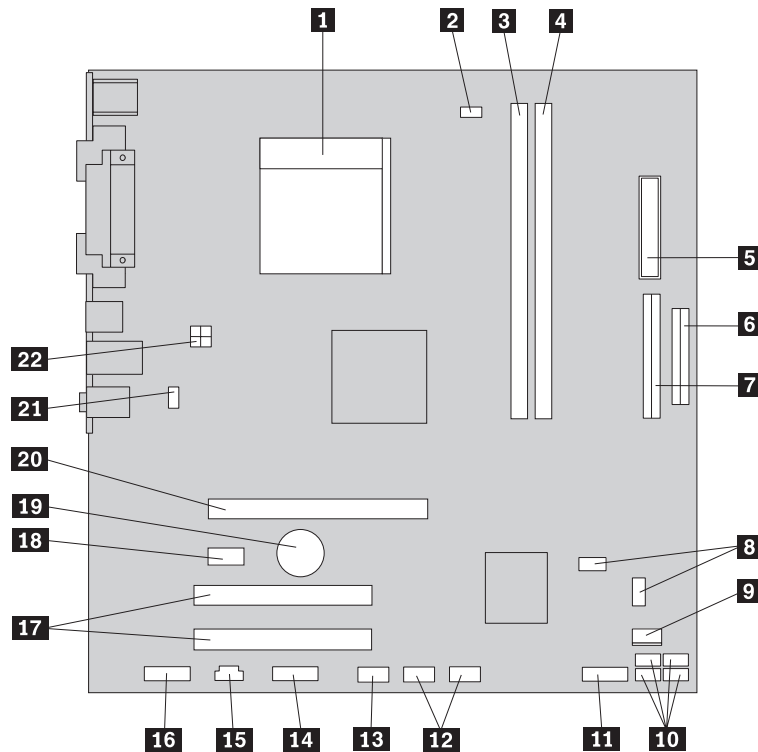

Figure 5. Location of parts on the system board

- | | | | |
|-----------|---------------------------------|-----------|--|
| 1 | Microprocessor and heat sink | 12 | Front USB connectors (2) |
| 2 | Microprocessor fan connector | 13 | Serial (COM) connector |
| 3 | Memory connector 1 | 14 | Leo connector |
| 4 | Memory connector 2 | 15 | CD-IN connector |
| 5 | Power connector | 16 | Front audio connector |
| 6 | Diskette drive connector | 17 | PCI adapter connectors (2) |
| 7 | IDE connector | 18 | PCI Express x1 adapter connector |
| 8 | Clear CMOS/Recovery jumpers (2) | 19 | Battery |
| 9 | Power fan connector | 20 | PCI Express x16 graphics adapter connector |
| 10 | SATA IDE connectors (4) | 21 | System fan connector |
| 11 | Front panel connector | 22 | 12v power connector |

Figure 6 shows the locations of parts on the system board for some computer models.

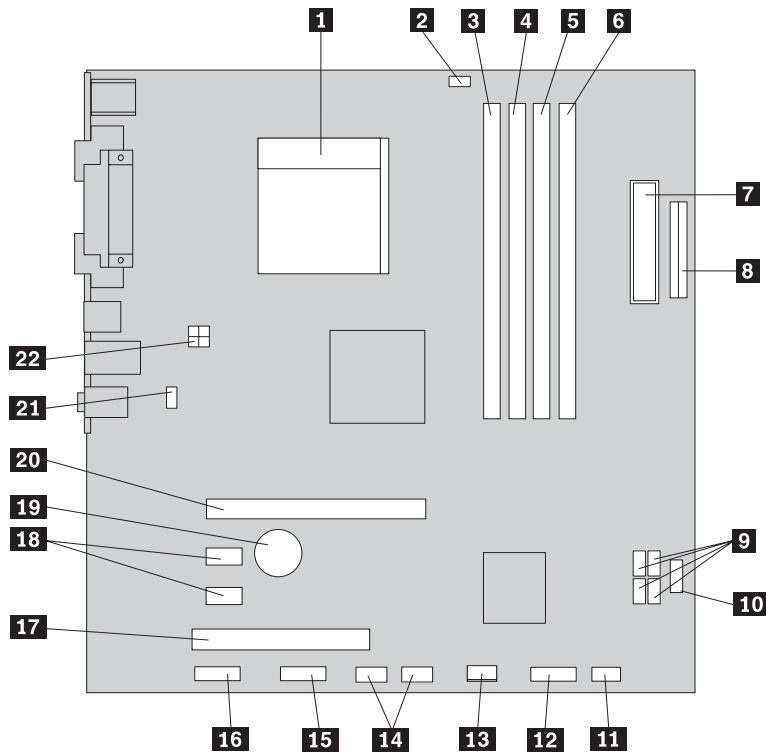

Figure 6. Location of parts on the system board

- | | | | |
|-----------|------------------------------|-----------|--|
| 1 | Microprocessor and heat sink | 12 | Front panel connector |
| 2 | Microprocessor fan connector | 13 | Power fan connector |
| 3 | Memory connector 1 | 14 | Front USB connectors (2) |
| 4 | Memory connector 2 | 15 | Serial (COM) connector |
| 5 | Memory connector 3 | 16 | Front audio connector |
| 6 | Memory connector 4 | 17 | PCI adapter connector |
| 7 | Power connector | 18 | PCI Express x1 adapter connectors (2) |
| 8 | Diskette drive connector | 19 | Battery |
| 9 | SATA IDE connectors (4) | 20 | PCI Express x16 graphics adapter connector |
| 10 | Front USB connector | 21 | System fan connector |
| 11 | Clear CMOS/Recovery jumper | 22 | 12v power connector |

Chapter 3. Installing options and replacing hardware

Attention

Do not open your computer or attempt any repair before reading the “Important safety information” in the *Safety and Warranty Guide* that was included with your computer for the computer. To obtain copies of the *Safety and Warranty Guide*, go to <http://www.lenovo.com/support>.

Note: Use only the parts provided by Lenovo.

Tools required

To install some options in your computer, you might need a flat-blade or Phillips screwdriver. Additional tools might be needed for certain options. See the instructions that come with the option.

Installing external options

External speakers, a printer, or a scanner can be connected to your computer. For some external options, you must install additional software in addition to making the physical connection. When adding an external option, see “Locating controls and connectors on the front of your computer” on page 4 and “Locating connectors on the rear of your computer” on page 5 to identify the required connector, and then use the instructions that come with the option to help you make the connection and install any software or device drivers that are required for the option.

Removing the cover

Important



Turn off your computer and wait 3 to 5 minutes to let the computer cool before removing the computer cover.

To remove the computer cover:

1. Remove any media (diskettes, CDs, or tapes) from the drives, shut down your operating system, and turn off all attached devices.
2. Unplug all power cords from electrical outlets.
3. Disconnect all cables attached to the computer. This includes power cords, input/output (I/O) cables, and any other cables that are connected to the computer.
4. Remove any locking devices such as a padlock that secure the cover.

5. Press the cover-release button on the top of the computer cover, slide the cover to the rear, and remove it. If your computer has screws to secure the computer cover, remove the screws, and then remove the cover.

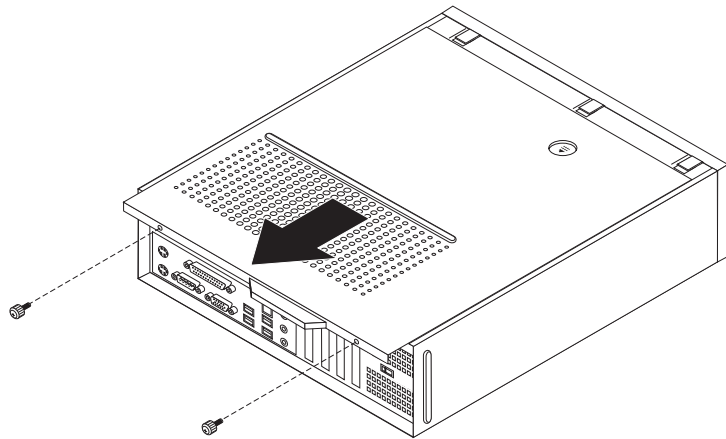

Figure 7. Removing the computer cover

Accessing system board components and drives

You might have to remove the drive bay assembly to access system board components such as memory, the battery, internal drives, and CMOS.

To access system board components and the drives:

1. Remove the computer cover. See “Removing the cover” on page 11.
2. Remove the front bezel by releasing the three tabs and pivoting the bezel forward to remove completely.

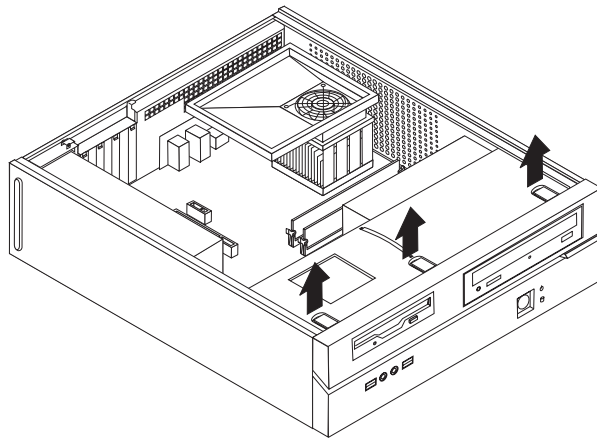

Figure 8. Removing the bezel

3. In some models, you might have to remove the PCI adapter in order to gain access to the battery.

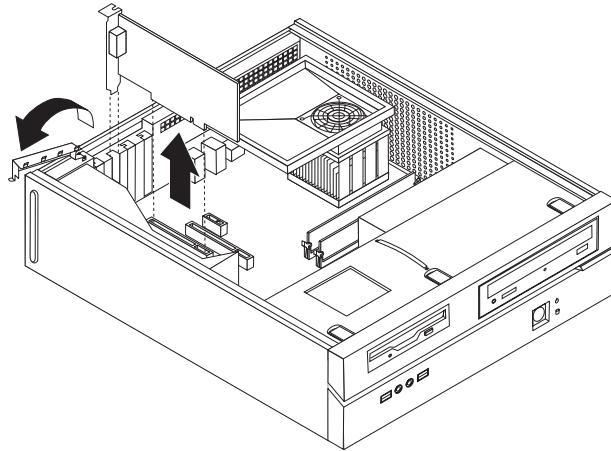

Figure 9. Removing the PCI adapter

4. Slide the drive bay assembly forward until the drive bay assembly is aligned with the two slots on the sides of the chassis and remove the drive cables from the system board. Then pull upward on the handle **1** to remove the drive bay assembly completely from the computer.

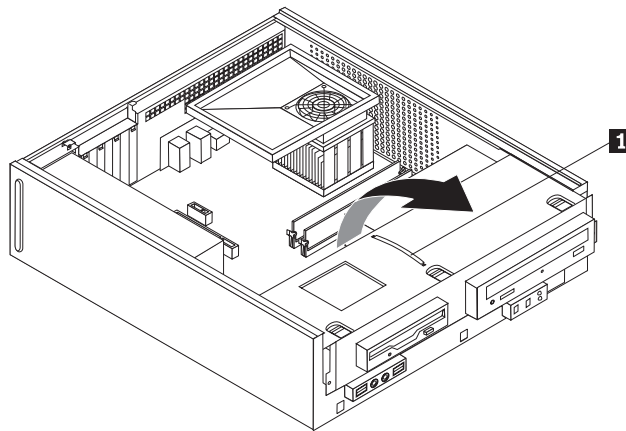

Figure 10. Removing the drive bay assembly

Installing internal options

Important

Read “Handling static-sensitive devices” on page 3 before opening the computer cover.

Installing memory

Your computer either has two or four connectors for installing double data rate 2 dual inline memory modules (DDR2 DIMMs). System boards with two connectors can accommodate up to a maximum of 2.0 GB of system memory. System boards with four connectors can accommodate up to a maximum of 4.0 GB of system memory.

When installing memory modules, the following rules apply:

- If you are adding or replacing a memory module on a system board with four memory connectors, at least one memory module must be installed in the first memory channel (in either memory connector 1 or memory connector 2). See “Identifying parts on the system board” on page 8 for more information.
- Use 1.8 V, 240-pin, double data rate 2 synchronous dynamic random access memory (DDR2 SDRAM).
- Use 256 MB, 512 MB, or 1 GB memory modules in any combination.

Note: Only DDR2 SDRAM DIMMs can be used.

To install a memory module:

1. Remove the computer cover. See “Removing the cover” on page 11.
2. You might have to remove the drive bay assembly to access the memory connectors. See “Accessing system board components and drives” on page 12.
3. Remove any parts that might prevent access to the memory connectors.
4. Locate the memory connectors. See “Identifying parts on the system board” on page 8.
5. Open the retaining clips.

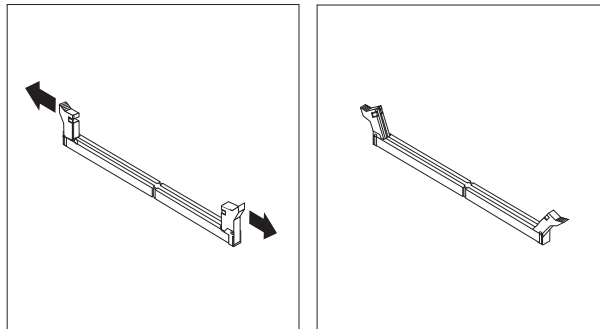

Figure 11. Retaining clips

6. Position the memory module over the memory connector. Make sure that the notch **1** on the memory module aligns correctly with the connector key **2** on the system board. Push the memory module straight down into the connector until the retaining clips close.

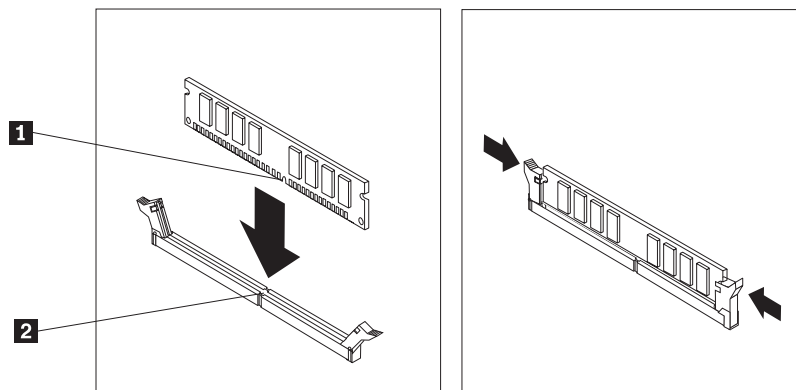

Figure 12. Positioning the memory module

What to do next:

- To work with another option, go to the appropriate section.
- To complete the installation, go to Chapter 4, “Completing the parts replacement,” on page 35.

Installing PCI adapters

This section provides information and instructions for installing PCI adapters. Your computer has four expansion connectors. On some system boards, there are two connectors for PCI adapters, one PCI Express x1 adapter connector, and one for a PCI Express x16 graphics adapter connector. On some system boards, there are two PCI Express x1 adapter connectors, one PCI adapter connector, and one for a PCI Express x16 graphics adapter connector.

To install a PCI adapter:

1. Remove the computer cover. See “Removing the cover” on page 11.
2. Open the adapter latch and remove the connector cover for the appropriate expansion connector.

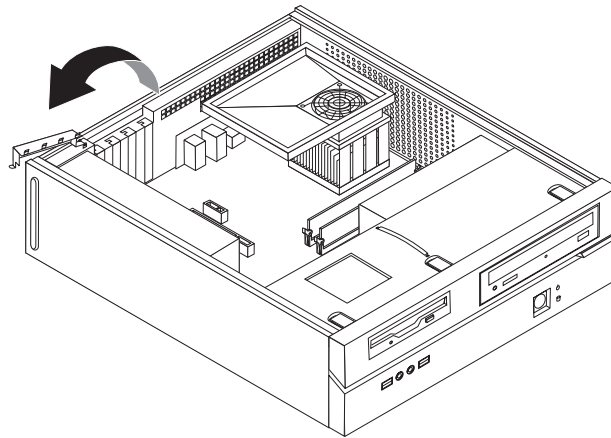

Figure 13. Opening the adapter latch

3. Remove the adapter from its static-protective package.
4. Install the adapter into the appropriate connector on the system board.

5. Close the adapter latch to secure the adapter.

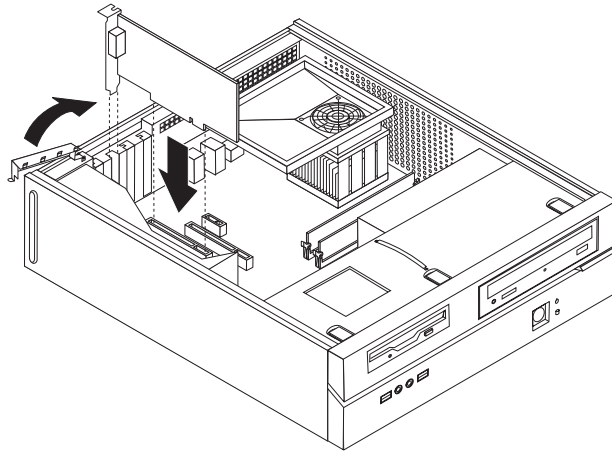

Figure 14. Securing the adapter

What to do next:

- To work with another option, go to the appropriate section.
- To complete the installation, go to Chapter 4, “Completing the parts replacement,” on page 35.

Installing internal drives

This section provides information and instructions for installing and removing internal drives.

Internal drives are devices that your computer uses to read and store data. You can add drives to your computer to increase storage capacity and to enable your computer to read other types of media. Some of the different drives that are available for your computer are:

- Serial Advanced Technology Attachment (SATA) hard disk drives
- Parallel ATA (PATA) hard disk drives
- SATA optical drives, such as CD drives or DVD drives
- PATA optical drives
- Removable media drives

Note: These different drives are also referred to as integrated drive electronics (IDE) drives.

Internal drives are installed in *bays*. In this book, the bays are referred to as bay 1, bay 2, and so on.

When you install an internal drive, it is important to note what type and size of drive that you can install in each bay. Also, it is important to correctly connect the internal drive cables to the installed drive.

Drive specifications

Your computer comes with the following factory-installed drives:

- An optical drive in bay 1 (some models)
- A 3.5-inch hard disk drive in bay 2
- A 3.5-inch diskette drive in bay 3 (some models)

Any bay that does not have a drive installed has a static shield and bay panel installed.

The following illustration shows the locations of the drive bays.

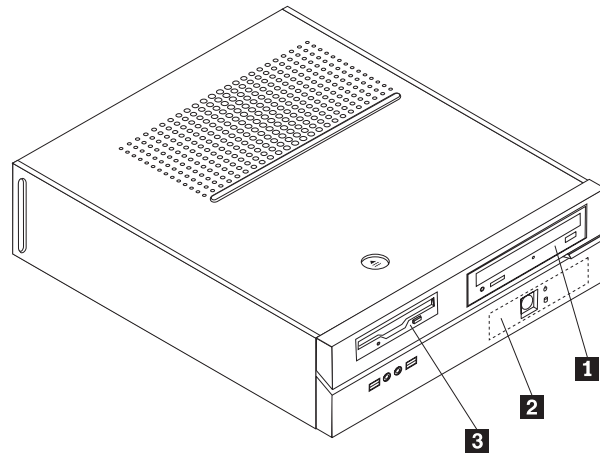

Figure 15. Locating drive bays

The following list describes the types and size of drives you can install in each bay:

- | | |
|--|--|
| 1 Bay 1 - Maximum height: 43.0 mm (1.7 in.) | Optical drives, such as CD drive or DVD drive (preinstalled in some models)
3.5-inch hard disk drive (requires a Universal Adapter Bracket, 5.25 to 3.5-inch) * |
| 2 Bay 2 - Maximum height: 26.1 mm (1.0 in.) | 5.25-inch hard disk drive
3.5-inch hard disk drive (preinstalled) |
| 3 Bay 3 - Maximum height: 12.7 mm (0.5 in.) | 3.5-inch diskette drive (preinstalled in some models) |

* You can obtain a Universal Adapter Bracket, 5.25 to 3.5-inch, from a local computer retailer or by contacting the Customer Support Center.

Installing a drive in bay 1

To install an optical drive or an additional hard disk drive in bay 1, do the following:

1. Remove the computer cover. See “Removing the cover” on page 11.
2. To access the system board components, see “Accessing system board components and drives” on page 12.
3. If you are installing a drive with accessible media, such as an optical drive, remove the plastic panel in the bezel by squeezing the plastic tabs that secure the panel on the inside of the bezel.
4. Remove the metal shield from the drive bay.
5. For a 5.25-inch drive, install a retainer bracket on the side of the drive.

Note: If you are installing a 3.5-inch hard disk drive you must use a Universal Adapter Bracket, 5.25 to 3.5-inch. You can obtain this bracket from a local computer retailer or by contacting the Customer Support Center.

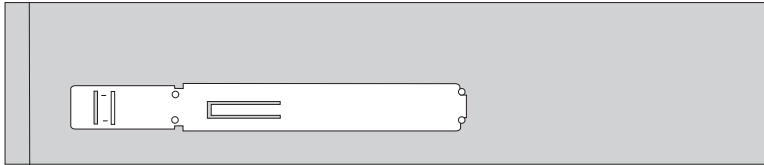

Figure 16. Retaining bracket

6. Install the drive into the drive bay until it snaps into position.

Note: When installing the Universal Adapter Bracket, if the retainer bracket is not available, install the screws to secure the adapter bracket into the drive bay.

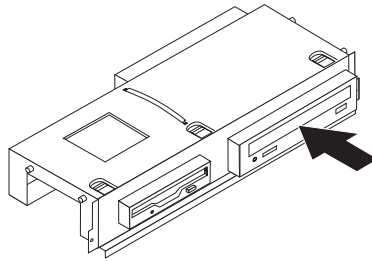

Figure 17. Installing the drive

7. Align the drive bay assembly with the two slots and rails on the sides of the chassis and connect the new drive cable on the system board. See “Connecting drives.”

Connecting drives

The steps to connect a drive are different depending on the type of drive you are connecting. Use one of the following procedures for your drive connection.

Connecting a parallel ATA drive:

1. Locate the two-connector signal cable that comes with your computer or with the new drive.
2. Locate the IDE connector on the system board. See “Identifying parts on the system board” on page 8.

3. Connect one end of the signal cable to the drive and the other to the IDE connector on the system board.
4. Locate the extra four-wire power connector labelled P4 and connect it to the drive.

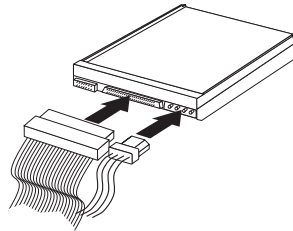

Figure 18. Connecting a parallel ATA drive

Connecting a serial ATA drive: A serial optical or additional hard disk drive can be connected to any available SATA IDE connector.

1. Locate the signal cable that comes with the new drive.
2. Locate the available SATA IDE connector on the system board. See “Identifying parts on the system board” on page 8.
3. Connect one end of the signal cable to the drive and the other to the available SATA IDE connector on the system board.
4. Locate one of the extra five-wire power connectors and connect it to the drive.

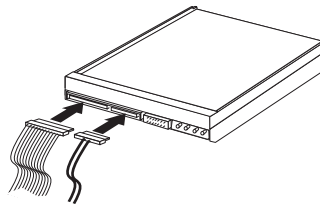

Figure 19. Connecting a serial ATA drive

What to do next:

- To work with another option, go to the appropriate section.
- To complete the installation, go to Chapter 4, “Completing the parts replacement,” on page 35.

Installing a diskette drive in bay 3

To install a diskette drive in bay 3, do the following:

1. Remove the computer cover. See “Removing the cover” on page 11.
2. To access the system board components, see “Accessing system board components and drives” on page 12.
3. Remove the metal shield from the diskette drive bay by using a flat-blade screwdriver to gently pry it loose.
4. Remove the plastic panel in the bezel by squeezing the plastic tabs that secure the panel on the inside of the bezel.

5. Install a retainer bracket on the side of the diskette drive.

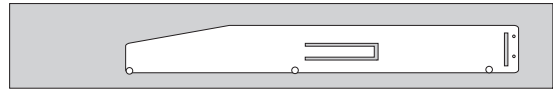

Figure 20. Retaining bracket

6. Install the diskette drive into the bay from the front until it snaps into position.

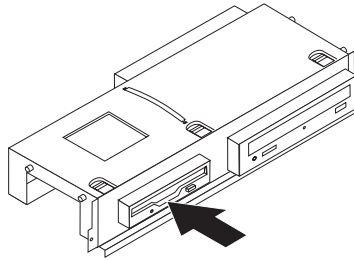

Figure 21. Installing the diskette drive

7. Align the drive bay assembly with the two slots and rails on the sides of the chassis and connect the flat cable to the new drive.

What to do next:

- To work with another option, go to the appropriate section.
- To complete the installation, go to Chapter 4, "Completing the parts replacement," on page 35.

Replacing the battery

Your computer has a special type of memory that maintains the date, time, and settings for built-in features, such as parallel-port assignments (configuration). A battery keeps this information active when you turn off the computer.

The battery normally requires no charging or maintenance throughout its life; however, no battery lasts forever. If the battery fails, the date, time, and configuration information (including passwords) are lost. An error message is displayed when you turn on the computer.

Refer to the "Lithium battery notice" in the *Safety and Warranty Guide* for information about replacing and disposing of the battery.

To change the battery:

1. Turn off the computer and disconnect the power cord from the electrical outlet and from the computer.
2. Remove the computer cover. See "Removing the cover" on page 11.
3. You might have to access the system board components. See "Accessing system board components and drives" on page 12.
4. Locate the battery. See Figure 3 on page 7.

5. Remove the old battery.

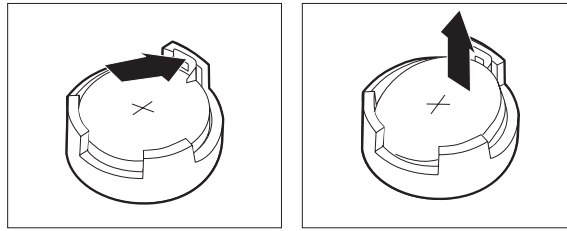

Figure 22. Battery removal

6. Install the new battery.

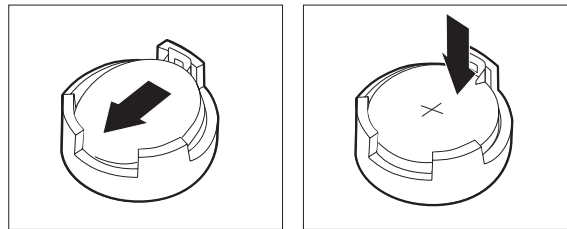

Figure 23. Battery installation

7. Replace the computer cover, and connect the cables. See Chapter 4, "Completing the parts replacement," on page 35.

Note: When the computer is turned on for the first time after battery replacement, an error message might be displayed. This is normal after replacing the battery.

8. Turn on the computer and all attached devices.
9. Use the Setup Utility program to set the date and time and any passwords. See "Using the Setup Utility" in your *User Guide*.

Replacing the hard disk drive

Attention

Do not open your computer or attempt any repair before reading the "Important safety information" in the *Safety and Warranty Guide* that was included with your computer for the computer. To obtain copies of the *Safety and Warranty Guide*, go to <http://www.lenovo.com/support>.

This section provides instructions on how to replace the hard disk drive.

Important

When you receive a new hard disk drive, you also receive a set of *Product Recovery discs*. The set of *Product Recovery discs* will enable you to restore the contents of the hard disk to the same state as when your computer was originally shipped from the factory. For more information on recovering factory-installed software, refer to "Recovering software" in your *User Guide*.

To replace the hard disk drive, do the following:

1. Remove the computer cover. See “Removing the cover” on page 11.
2. To access the system board components, see “Accessing system board components and drives” on page 12.
3. Disconnect the signal and power cables from the rear of the hard disk drive.
4. Use the blue handle to pivot the hard disk drive and bracket upward, slide the hard drive to the left until it is free of the retaining clips in the bottom of the chassis, and then completely remove it from the chassis.

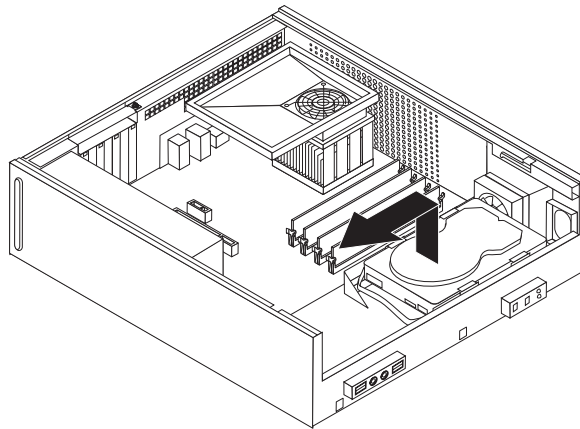

Figure 24. Removing the hard disk drive

5. Install the new drive into the blue bracket, flex the bracket, and align the pins **1** through **4** on the bracket with the holes in the hard disk drive. Do not touch the circuit board **5** on the bottom of the hard disk drive.

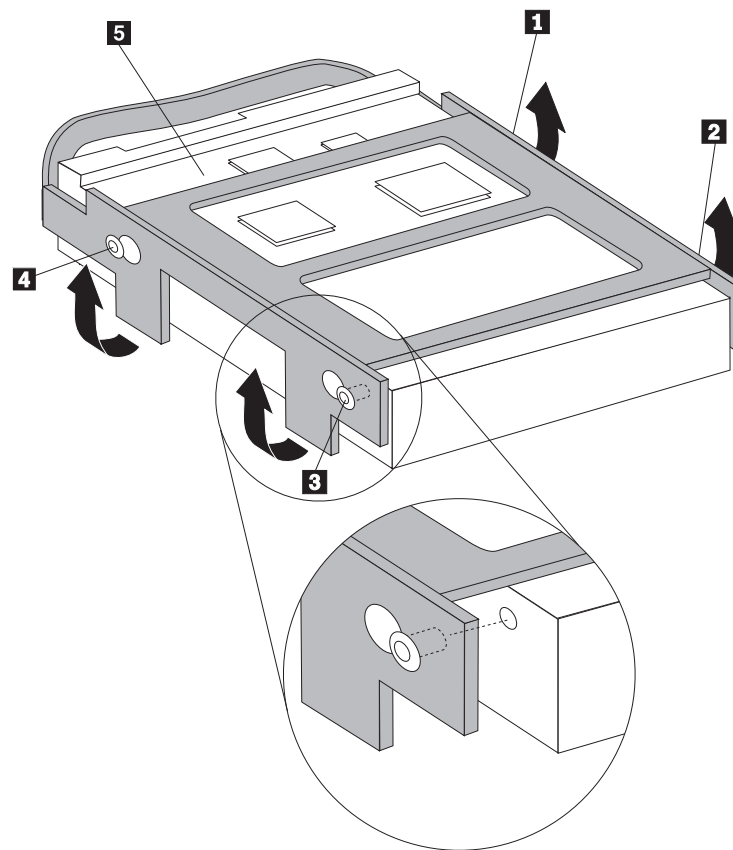

Figure 25. Installing the hard disk drive into bracket

6. Position the hard disk drive and bracket so that it engages the retaining clips in the bottom of the chassis when you slide the bracket to the right.
7. Slide the hard disk drive and bracket to the right until it snaps into position.
8. Connect the signal and power cables to the rear of the hard disk drive.
9. Go to Chapter 4, “Completing the parts replacement,” on page 35.

Replacing the diskette drive

Attention

Do not open your computer or attempt any repair before reading the “Important safety information” in the *Safety and Warranty Guide* that was included with your computer for the computer. To obtain copies of the *Safety and Warranty Guide*, go to <http://www.lenovo.com/support>.

This section provides instructions on how to replace the diskette drive.

1. Remove the computer cover. See “Removing the cover” on page 11.
2. To access the system board components, see “Accessing system board components and drives” on page 12.

3. Release the diskette drive by pressing inward on the blue retainer at the side of the drive.
4. Remove the failing diskette drive by sliding it out the front of the drive bay assembly.

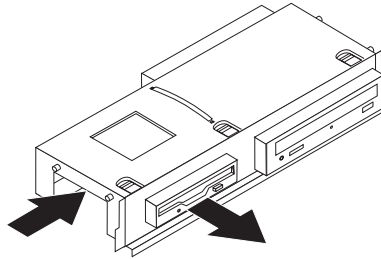

Figure 26. Removing the diskette drive

5. Remove the retainer bracket from the failing drive and install it on the new drive.

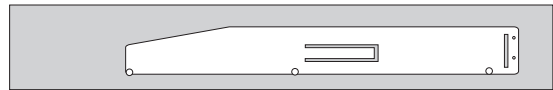

Figure 27. Retaining bracket for diskette drive

6. Install the new diskette drive into the drive bay from the front until it snaps into position.

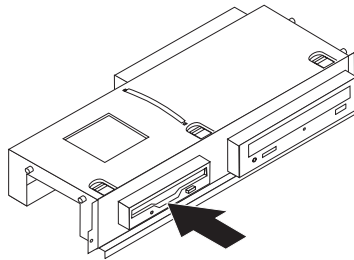

Figure 28. Installing the new diskette drive

7. Go to Chapter 4, “Completing the parts replacement,” on page 35.

Replacing an optical drive

Attention

Do not open your computer or attempt any repair before reading the “Important safety information” in the *Safety and Warranty Guide* that was included with your computer for the computer. To obtain copies of the *Safety and Warranty Guide*, go to <http://www.lenovo.com/support>.

This section provides instructions on how to replace the optical drive.

1. Remove the computer cover. See “Removing the cover” on page 11.
2. To access the system board components, see “Accessing system board components and drives” on page 12.

3. Release the optical drive by pressing inward on the blue retainer at the side of the drive.
4. Slide the optical drive being replaced out the front of the drive bay assembly.

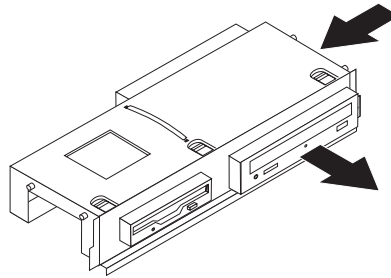

Figure 29. Removing the optical drive

5. Remove the retainer bracket from the failing drive and install it on the new drive.

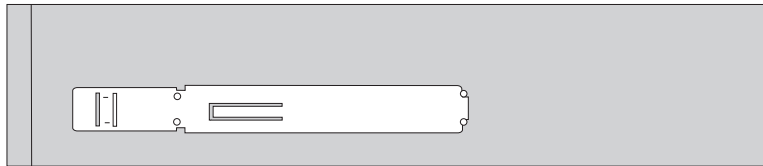

Figure 30. Retaining bracket for optical drive

6. Install the new optical drive into the bay until it snaps into position.

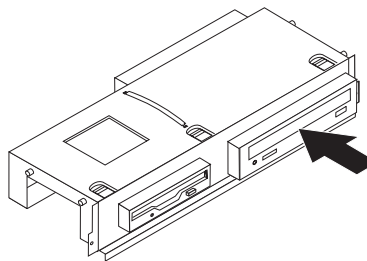

Figure 31. Installing the new optical drive

7. Go to Chapter 4, “Completing the parts replacement,” on page 35.

Replacing the heat sink and fan assembly

Attention

Do not open your computer or attempt any repair before reading the “Important safety information” in the *Safety and Warranty Guide* that was included with your computer for the computer. To obtain copies of the *Safety and Warranty Guide*, go to <http://www.lenovo.com/support>.

This section provides instructions on how to replace the heat sink and fan assembly.

1. Remove the computer cover. See “Removing the cover” on page 11.

2. Disconnect the microprocessor fan cable from the system board. See “Identifying parts on the system board” on page 8.
3. Remove the fan plenum from the heat sink and fan assembly. See “Locating components” on page 7.
4. Depending on which heat sink you are removing, do one of the following:
 - a. Pivot the handle **1** to release the heat sink clamp and then disengage the clamp from the plastic retention bracket.

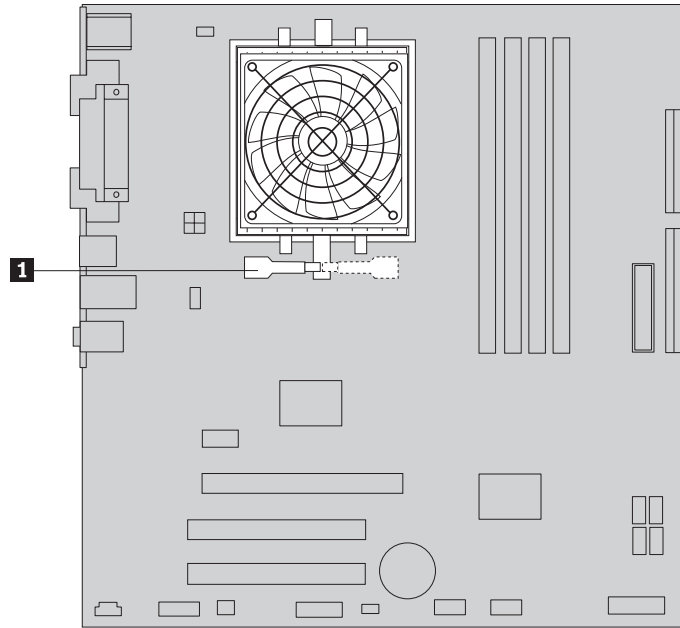

Figure 32. Removing the heat sink held in place by a clamp

- b. Remove the four screws **1** securing the heat sink and fan assembly to the system board.

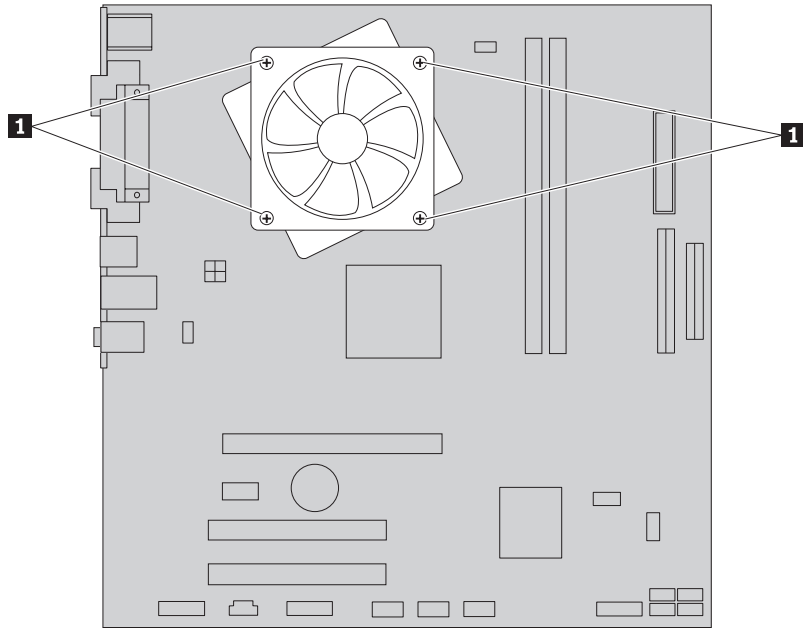

Figure 33. Removing the heat sink held in place by screws

Note: You might have to gently twist the heat sink to free it from the microprocessor.

5. Lift the heat sink and fan assembly off the system board.

6. Depending on which heat sink you are installing, do one of the following:
 - a. Position the new heat sink on the microprocessor socket and then position the clamp on the plastic retention bracket. Pivot the handle **1** to clamp the heat sink to the plastic retention bracket.

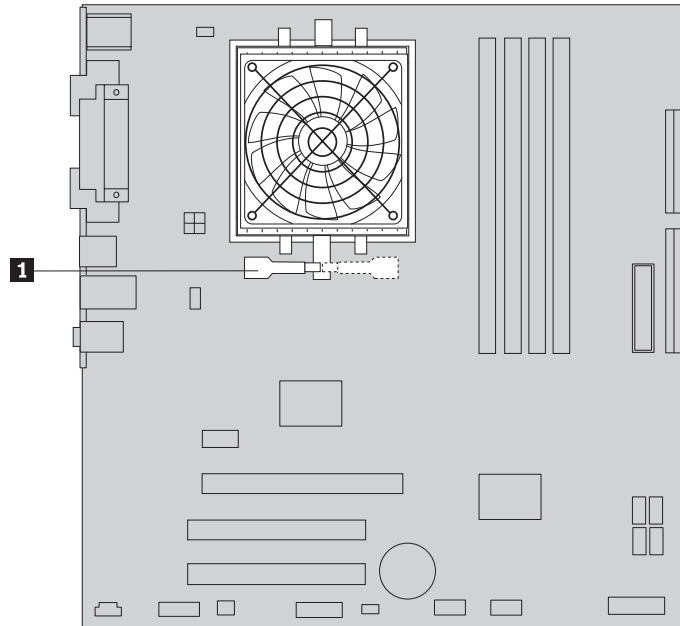

Figure 34. Clamping the heat sink to the plastic retention bracket

- b. Position the new heat sink on the plastic retention bracket so that the four screws are aligned with the posts on the system board. Tighten the four screws **1** to the heat sink and fan assembly to the system board.

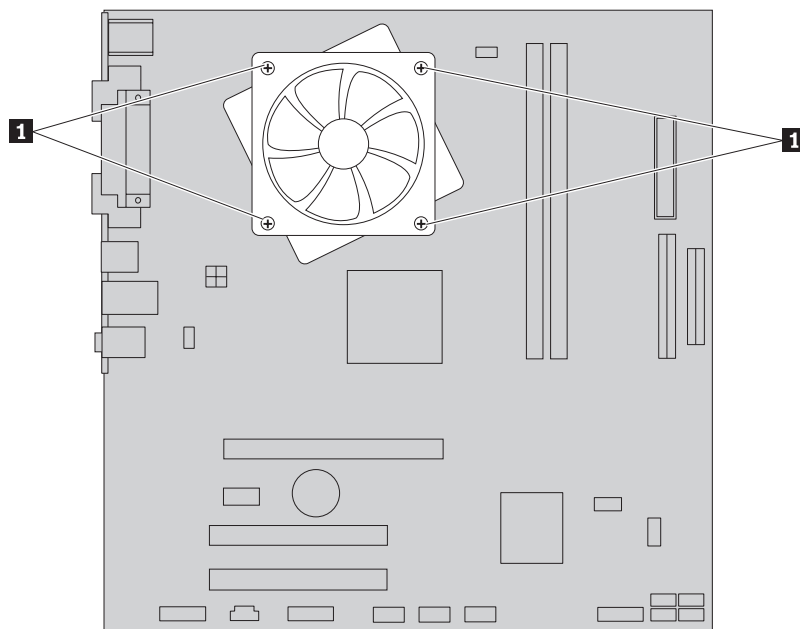

Figure 35. Replacing the screws to the heat sink and fan assembly

7. Connect the microprocessor fan cable to the microprocessor fan connector on the system board.
8. Go to Chapter 4, “Completing the parts replacement,” on page 35.

Replacing the system fan assembly

Attention

Do not open your computer or attempt any repair before reading the “Important safety information” in the *Safety and Warranty Guide* that was included with your computer for the computer. To obtain copies of the *Safety and Warranty Guide*, go to <http://www.lenovo.com/support>.

This section provides instructions on how to replace the system fan assembly.

1. Remove the computer cover. See “Removing the cover” on page 11.
2. To access the system board components, see “Accessing system board components and drives” on page 12.
3. Disconnect the system fan cable from the system board. See “Identifying parts on the system board” on page 8.
4. Remove the hard disk drive. See “Replacing the hard disk drive” on page 21.
5. Remove the two screws securing the system fan assembly.
6. Remove the system fan assembly by pulling the bracket outward and lifting it up from the system board to remove completely.

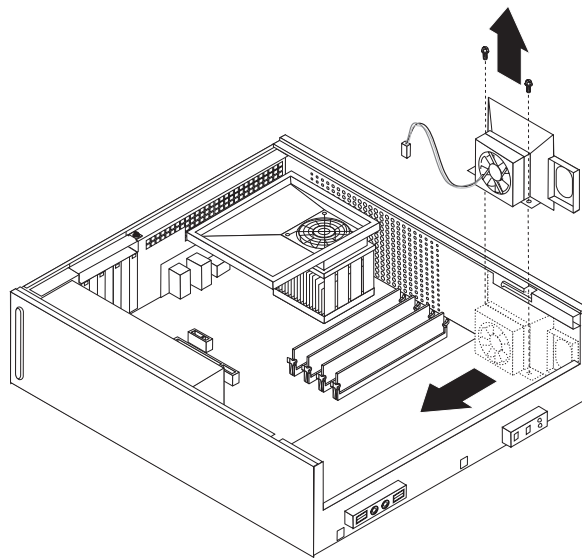

Figure 36. Removing the system fan assembly

7. Install the new system fan assembly and install the two screws that secure the fan assembly.
8. Connect the system fan cable to the system fan connector on the system board.
9. Replace the hard disk drive.

10. Go to Chapter 4, “Completing the parts replacement,” on page 35.

Replacing a memory module

Attention

Do not open your computer or attempt any repair before reading the “Important safety information” in the *Safety and Warranty Guide* that was included with your computer for the computer. To obtain copies of the *Safety and Warranty Guide*, go to <http://www.lenovo.com/support>.

This section provides instructions on how to replace a memory module.

Note: Your computer has support for either two or four memory modules.

1. Remove the computer cover. See “Removing the cover” on page 11.
2. You might have to remove the drive bay assembly to access the memory connectors. See “Accessing system board components and drives” on page 12.
3. Remove any parts that might prevent access to the memory connectors.
4. Remove the memory module being replaced by opening the retaining clips as shown.

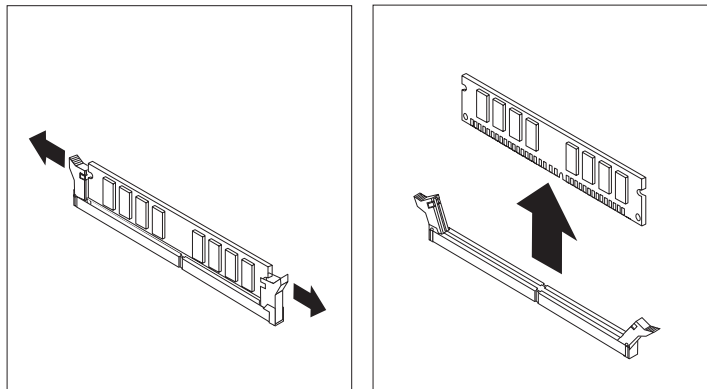

Figure 37. Removing the memory module

5. Position the replacement memory module over the memory connector. Make sure that the notch **1** on the memory module aligns correctly with the connector key **2** on the system board. Push the memory module straight down into the memory connector until the retaining clips close.

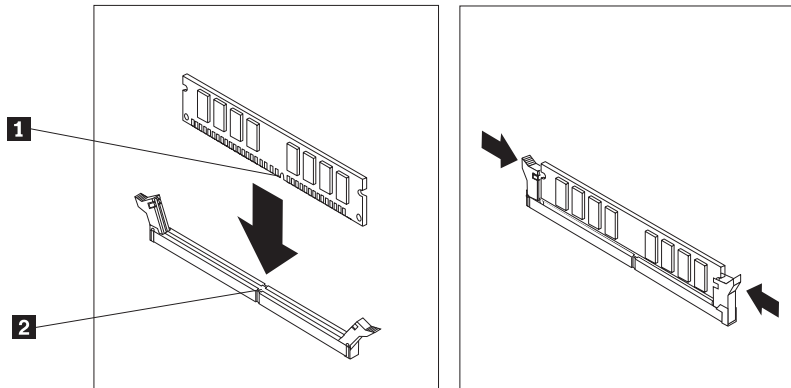

Figure 38. Installing the memory module

6. Go to Chapter 4, “Completing the parts replacement,” on page 35.

Replacing a PCI adapter

Attention

Do not open your computer or attempt any repair before reading the “Important safety information” in the *Safety and Warranty Guide* that was included with your computer for the computer. To obtain copies of the *Safety and Warranty Guide*, go to <http://www.lenovo.com/support>.

This section provides instructions on how to replace a PCI adapter.

1. Remove the computer cover. See “Removing the cover” on page 11.

2. Open the adapter latch and remove the failing adapter.

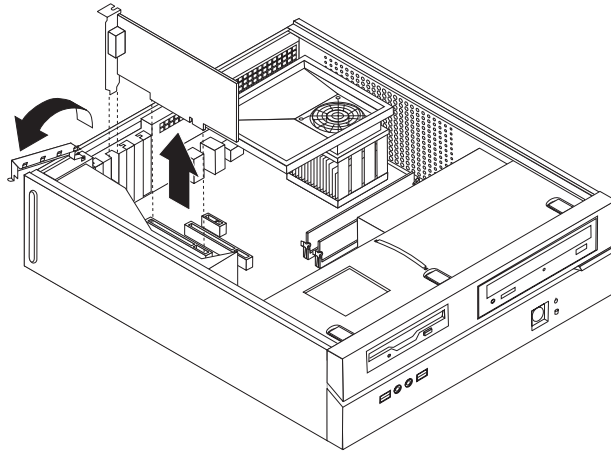

Figure 39. Removing the adapter

3. Remove the new adapter from its static-protective package.
4. Install the new adapter into the appropriate connector on the system and close the adapter latch.

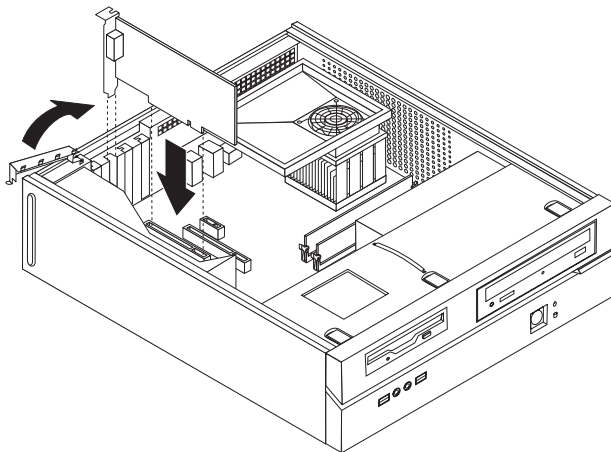

Figure 40. Installing the new adapter

5. Go to Chapter 4, "Completing the parts replacement," on page 35.

Replacing a keyboard

Attention

Do not open your computer or attempt any repair before reading the "Important safety information" in the *Safety and Warranty Guide* that was included with your computer for the computer. To obtain copies of the *Safety and Warranty Guide*, go to <http://www.lenovo.com/support>.

This section provides instructions on how to replace a keyboard.

1. Remove any media (diskettes, CDs, or tapes) from the drives, shut down your operating system, and turn off all attached devices.
2. Unplug all power cords from electrical outlets.
3. Locate the keyboard connector.

Note: Your keyboard might be connected to a standard keyboard connector **1** or a USB connector **2** in the front or rear of your computer. See “Locating connectors on the rear of your computer” on page 5 or “Locating controls and connectors on the front of your computer” on page 4.

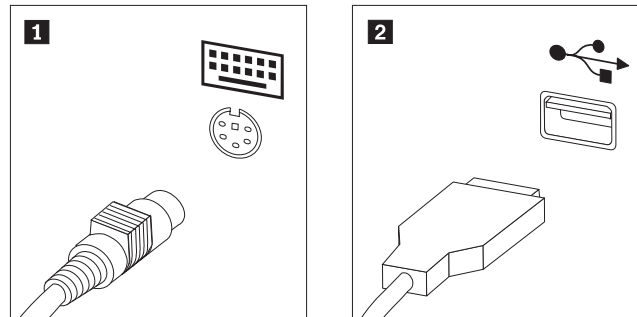

Figure 41. Keyboard connectors

4. Disconnect the failing keyboard cable from the computer.
5. Connect the new keyboard to the appropriate connector on the computer.
6. Go to Chapter 4, “Completing the parts replacement,” on page 35.

Replacing a mouse

Attention

Do not open your computer or attempt any repair before reading the “Important safety information” in the *Safety and Warranty Guide* that was included with your computer for the computer. To obtain copies of the *Safety and Warranty Guide*, go to <http://www.lenovo.com/support>.

This section provides instructions on how to replace a mouse.

1. Remove any media (diskettes, CDs, or tapes) from the drives, shut down your operating system, and turn off all attached devices.
2. Unplug all power cords from electrical outlets.

3. Locate the mouse connector.

Note: Your mouse might be connected to a standard mouse connector **1** or a USB connector **2** in the front or rear of your computer. See “Locating connectors on the rear of your computer” on page 5 or “Locating controls and connectors on the front of your computer” on page 4.

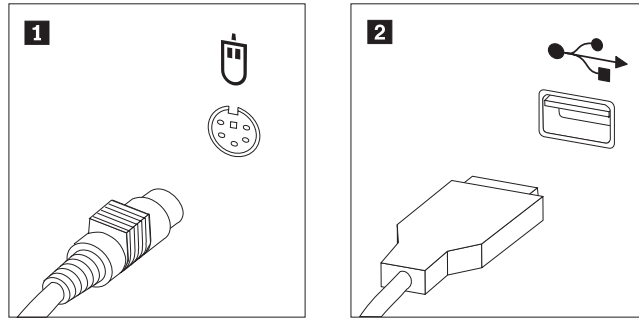

Figure 42. Mouse connectors

4. Disconnect the failing mouse cable from the computer.
5. Connect the new mouse to the appropriate connector on the computer.
6. Go to Chapter 4, “Completing the parts replacement,” on page 35.

Chapter 4. Completing the parts replacement

After working with parts, you need to replace the computer cover and reconnect any cables, including telephone lines and power cords. Also, depending on the part that was replaced, you might need to confirm the updated information in the Setup Utility program.

To replace the computer cover and connect cables to your computer:

1. Ensure that all components have been reassembled correctly and that no tools or loose screws are left inside your computer.
2. Reposition any cables that might impede the replacement of the computer cover.

Important

Correctly route all power supply cables to avoid interference with the drive bay assembly. Keep cables clear of the hinges and sides of the computer chassis.

3. If the drive bay assembly was removed; align the drive bay assembly with the two slots and rails on the sides of the chassis, reconnect the drive cables on the system board, and then slide the drive bay assembly towards the rear of the chassis until it snaps into position.
4. Reinstall the front bezel if it was removed.
5. Position the computer cover on the chassis so that the rail guides on the sides of the cover engage the rails and push the cover to the closed position until it snaps into position. If your computer has screws to secure the computer cover, install the screws.

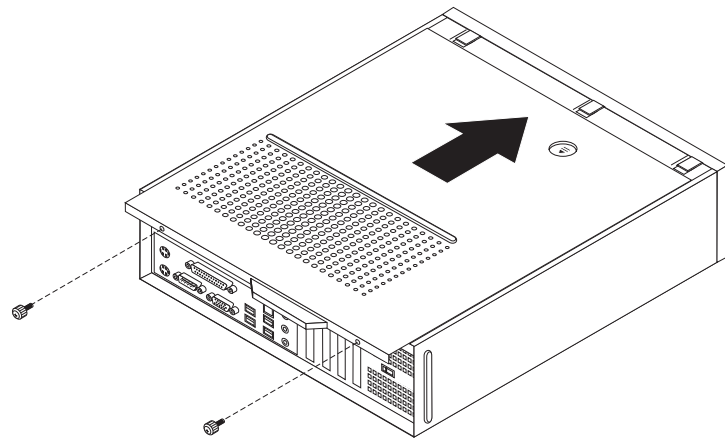

Figure 43. Installing the computer cover

6. Install any locking devices such as a padlock as necessary.
7. Reconnect the external cables and power cords to the computer. See “Locating connectors on the rear of your computer” on page 5.
8. To update the configuration, see “Using the Setup Utility” in the *User Guide* that was included with your computer.

Note: In most areas of the world, Lenovo requires the return of the defective CRU. Information about this will come with the CRU or will come a few days after the CRU arrives.

Obtaining device drivers

You can obtain device drivers for operating systems that are not preinstalled at <http://www.lenovo.com/support/> on the World Wide Web. Installation instructions are provided in README files with the device-driver files.

Chapter 5. Security features

To help prevent hardware theft and unauthorized access to your computer, several security lock options are available. In addition to a physical lock, unauthorized use of your computer can be prevented by a software lock that locks the keyboard until a correct password is typed in.

Make sure that any security cables you install do not interfere with other computer cables.

Integrated cable lock

With an integrated cable lock (sometimes referred to as the Kensington lock), you can secure your computer to a desk, table, or other non-permanent fixture. The cable lock attaches to a security slot at the rear of your computer and is operated with a key. The cable lock also locks the buttons used to open the computer cover. This is the same type of lock used with many laptop computers. You can order a security cable directly from Lenovo. Go to <http://www.lenovo.com/support/> and search on Kensington.

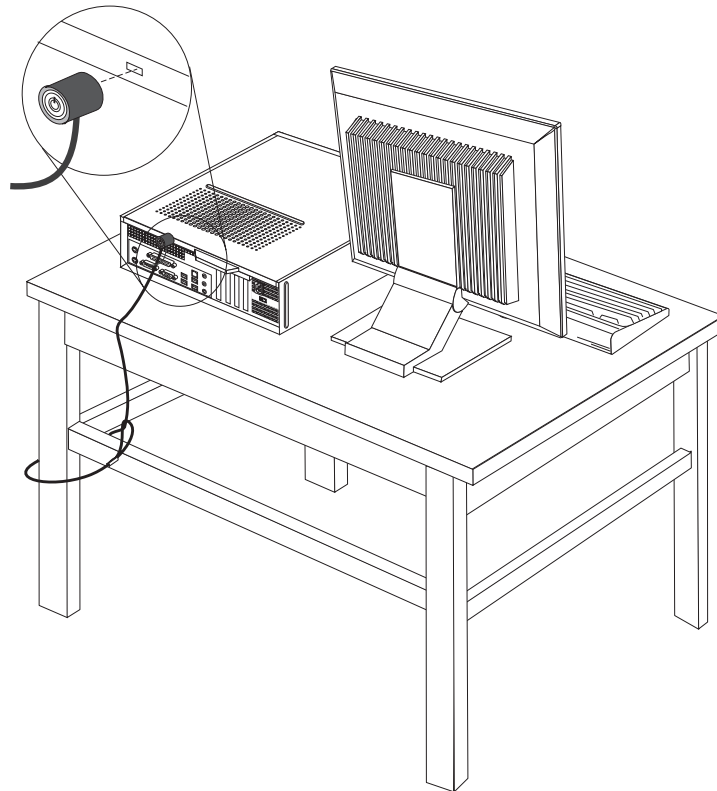

Figure 44. Kensington lock location

Padlock

Your computer is equipped with a padlock loop such that the cover cannot be removed when a padlock is installed.

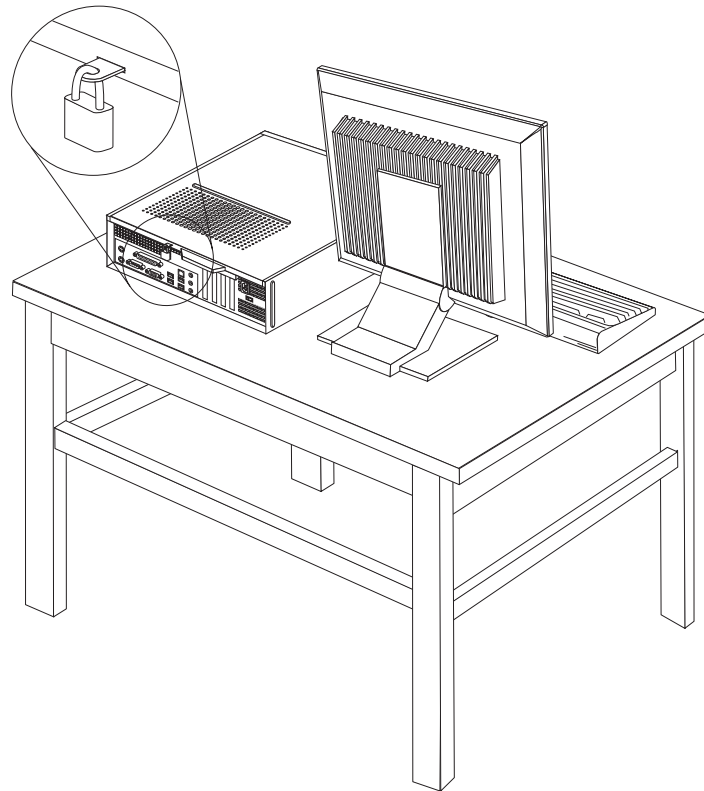

Figure 45. Padlock loop

Password protection

To deter unauthorized use of your computer, you can use the Setup Utility program to set a password. When you turn on your computer you are prompted to type the password to unlock the keyboard for normal use.

What to do next:

- To work with another option, go to the appropriate section.
- To complete the installation, go to Chapter 4, "Completing the parts replacement," on page 35.

Erasing a lost or forgotten password (clearing CMOS)

This section applies to lost or forgotten passwords. For more information about lost or forgotten passwords, go to the Lenovo Caresm program.

To erase a forgotten password:

1. Remove the computer cover. See "Removing the cover" on page 11.
2. You might have to access the system board components. See "Accessing system board components and drives" on page 12.

3. Locate the Clear CMOS/Recovery jumper on the system board. See “Identifying parts on the system board” on page 8.
4. Move the jumper from the standard position (pins 1 and 2) to the maintenance or configure position (pins 2 and 3).
5. Replace the computer cover and connect the power cord. See Figure 43 on page 35.
6. Restart the computer, leave it on for approximately ten seconds. Turn off the computer by holding the power switch for approximately five seconds. The computer will turn off.
7. Repeat steps 1 through 3 on page 38.
8. Move the Clear CMOS/Recovery jumper back to the standard position (pins 1 and 2).
9. Replace the computer cover and connect the power cord. See Chapter 4, “Completing the parts replacement,” on page 35.

Appendix. Notices

Lenovo may not offer the products, services, or features discussed in this document in all countries. Consult your local Lenovo representative for information on the products and services currently available in your area. Any reference to a Lenovo product, program, or service is not intended to state or imply that only that Lenovo product, program, or service may be used. Any functionally equivalent product, program, or service that does not infringe any Lenovo intellectual property right may be used instead. However, it is the user's responsibility to evaluate and verify the operation of any other product, program, or service.

Lenovo may have patents or pending patent applications covering subject matter described in this document. The furnishing of this document does not give you any license to these patents. You can send license inquiries, in writing, to:

*Lenovo (United States), Inc.
1009 Think Place - Building One
Morrisville, NC 27560
U.S.A.
Attention: Lenovo Director of Licensing*

LENOVO PROVIDES THIS PUBLICATION "AS IS" WITHOUT WARRANTY OF ANY KIND, EITHER EXPRESS OR IMPLIED, INCLUDING, BUT NOT LIMITED TO, THE IMPLIED WARRANTIES OF NON-INFRINGEMENT, MERCHANTABILITY OR FITNESS FOR A PARTICULAR PURPOSE. Some jurisdictions do not allow disclaimer of express or implied warranties in certain transactions, therefore, this statement may not apply to you.

This information could include technical inaccuracies or typographical errors. Changes are periodically made to the information herein; these changes will be incorporated in new editions of the publication. Lenovo may make improvements and/or changes in the product(s) and/or the program(s) described in this publication at any time without notice.

The products described in this document are not intended for use in implantation or other life support applications where malfunction may result in injury or death to persons. The information contained in this document does not affect or change Lenovo product specifications or warranties. Nothing in this document shall operate as an express or implied license or indemnity under the intellectual property rights of Lenovo or third parties. All information contained in this document was obtained in specific environments and is presented as an illustration. The result obtained in other operating environments may vary.

Lenovo may use or distribute any of the information you supply in any way it believes appropriate without incurring any obligation to you.

Any references in this publication to non-Lenovo Web sites are provided for convenience only and do not in any manner serve as an endorsement of those Web sites. The materials at those Web sites are not part of the materials for this Lenovo product, and use of those Web sites is at your own risk.

Any performance data contained herein was determined in a controlled environment. Therefore, the result obtained in other operating environments may

vary significantly. Some measurements may have been made on development-level systems and there is no guarantee that these measurements will be the same on generally available systems. Furthermore, some measurements may have been estimated through extrapolation. Actual results may vary. Users of this document should verify the applicable data for their specific environment.

Television output notice

The following notice applies to models that have the factory-installed television-output feature.

This product incorporates copyright protection technology that is protected by method claims of certain U.S. patents and other intellectual property rights owned by Macrovision Corporation and other rights owners. Use of this copyright protection technology must be authorized by Macrovision Corporation, and is intended for home and other limited viewing uses only unless otherwise authorized by Macrovision Corporation. Reverse engineering or disassembly is prohibited.

Trademarks

The following terms are trademarks of Lenovo in the United States, other countries, or both:

- Lenovo
- Lenovo Care
- Lenovo logo

IBM is a trademark of the International Business Machines Corporation in the United States, other countries, or both.

Other company, product, or service names may be trademarks or service marks of others.

lenovo

Part Number: 43C3124

Printed in USA

(1P) P/N: 43C3124

