



---

## 24-Inch ServeRAID-6M Internal Connection Cable Option

This 24-Inch ServeRAID-6M Internal Connection Cable Option kit contains the following items for use with your IBM @server xSeries™ 345 Type 8670 and xSeries 235 Type 8671 servers:

- One 24-Inch ServeRAID-6M Internal Connection Cable Option.
- This document, which also contains the warranty information for this option. (See “Warranty information” on page 10.)

Store this document with your server documentation for future reference.

The cable option supports the IBM ServeRAID-6M Ultra320 SCSI controller.

### Notes:

1. The cable option is a small computer system interface (SCSI) cable and is referred to as the SCSI cable option throughout this document.
2. The illustrations in this document might differ slightly from your hardware.

---

© Copyright International Business Machines Corporation 2003. All rights reserved.  
Note to U.S. Government Users Restricted Rights — Use, duplication or disclosure restricted by GSA ADP Schedule Contract with IBM Corporation.

**Part Number: 02R0694**

**First Edition (May 2003)**

**Printed in the U.S.A.**



\*1P02R0694\*

## Safety



Before installing this product, read the Safety Information.

قبل تركيب هذا المنتج، يجب قراءة الملاحظات الأمنية

Antes de instalar este produto, leia as Informações de Segurança.

在安装本产品之前，请仔细阅读 **Safety Information** (安全信息)。

安裝本產品之前，請先閱讀「安全資訊」。

Prije instalacije ovog produkta obavezno pročitajte Sigurnosne Upute.

Před instalací tohoto produktu si přečtěte příručku bezpečnostních instrukcí.

Læs sikkerhedsforskrifterne, før du installerer dette produkt.

Lees voordat u dit product installeert eerst de veiligheidsvoorschriften.

Ennen kuin asennat tämän tuotteen, lue turvaohjeet kohdasta Safety Information.

Avant d'installer ce produit, lisez les consignes de sécurité.

Vor der Installation dieses Produkts die Sicherheitshinweise lesen.

Πριν εγκαταστήσετε το προϊόν αυτό, διαβάστε τις πληροφορίες ασφάλειας (safety information).

לפני שתתקינו מוצר זה, קראו את הוראות הבטיחות.

A termék telepítése előtt olvassa el a Biztonsági előírásokat!

Prima di installare questo prodotto, leggere le Informazioni sulla Sicurezza.

製品の設置の前に、安全情報をお読みください。

본 제품을 설치하기 전에 안전 정보를 읽으십시오.

Пред да се инсталира овој продукт, прочитајте информацијата за безбедност.

Les sikkerhetsinformasjonen (Safety Information) før du installerer dette produktet.

Przed zainstalowaniem tego produktu, należy zapoznać się z książką "Informacje dotyczące bezpieczeństwa" (Safety Information).

Antes de instalar este produto, leia as Informações sobre Segurança.

Перед установкой продукта прочтите инструкции по технике безопасности.

Pred inštaláciou tohto zariadenia si pečítajte Bezpečnostné predpisy.

Pred namestitvijo tega proizvoda preberite Varnostne informacije.

Antes de instalar este producto, lea la información de seguridad.

Läs säkerhetsinformationen innan du installerar den här produkten.

- Statement 1



## **DANGER**

**Electrical current from power, telephone, and communication cables is hazardous.**

**To avoid a shock hazard:**

- **Do not connect or disconnect any cables or perform installation, maintenance, or reconfiguration of this product during an electrical storm.**
- **Connect all power cords to a properly wired and grounded electrical outlet.**
- **Connect to properly wired outlets any equipment that will be attached to this product.**
- **When possible, use one hand only to connect or disconnect signal cables.**
- **Never turn on any equipment when there is evidence of fire, water, or structural damage.**
- **Disconnect the attached power cords, telecommunications systems, networks, and modems before you open the device covers, unless instructed otherwise in the installation and configuration procedures.**
- **Connect and disconnect cables as described in the following table when installing, moving, or opening covers on this product or attached devices.**

**To Connect:**

1. Turn everything OFF.
2. First, attach all cables to devices.
3. Attach signal cables to connectors.
4. Attach power cords to outlet.
5. Turn device ON.

**To Disconnect:**

1. Turn everything OFF.
2. First, remove power cords from outlet.
3. Remove signal cables from connectors.
4. Remove all cables from devices.

- Statement 4

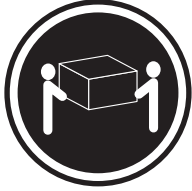

≥18 kg (39.7 lbs)



≥32 kg (70.5 lbs)



≥55 kg (121.2 lbs)

**CAUTION:**  
Use safe practices when lifting.

- Statement 5



**CAUTION:**  
The power control button on the device and the power switch on the power supply do not turn off the electrical current supplied to the device. The device also might have more than one power cord. To remove all electrical current from the device, ensure that all power cords are disconnected from the power source.

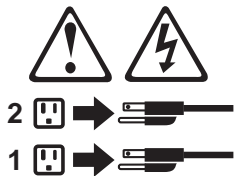

- Statement 8



**CAUTION:**  
Never remove the cover on a power supply or any part that has the following label attached.



Hazardous voltage, current, and energy levels are present inside any component that has this label attached. There are no serviceable parts inside these components. If you suspect a problem with one of these parts, contact a service technician.

## IBM xSeries 345 installation

Use the documentation that comes with your server and the ServeRAID controller along with the following instructions to install the cable option in an IBM @server xSeries 345 Type 8670.

Statement 5



### CAUTION:

The power control button on the device and the power switch on the power supply do not turn off the electrical current supplied to the device. The device also might have more than one power cord. To remove all electrical current from the device, ensure that all power cords are disconnected from the power source.

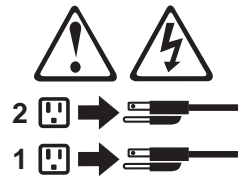

Complete the following steps to install the SCSI cable option:

1. Turn off the server; then, disconnect all power cords and external cables.
2. Remove the server top cover.
3. Remove the peripheral component interconnect (PCI) riser cage assembly. See the documentation that comes with your server for instructions.
4. Remove the air baffle between the power supplies and the hot-swap fans.
5. Disconnect the SCSI cable from the connector on the backplane and the connector on the system board.
6. Install the SCSI controller into slot 4 (connector J4) in the PCI riser cage assembly.
7. Using the following illustration, route and connect the SCSI cable option:
  - a. Route the SCSI cable option between the card guides.
  - b. Connect one end of the SCSI cable option to the SCSI connector on the SCSI controller.

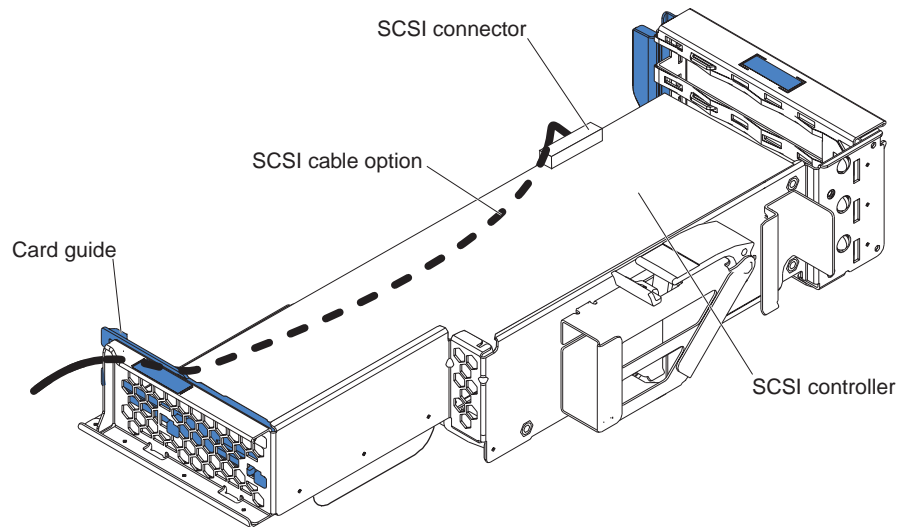

8. Ensure that the SCSI cable option remains between the card guides; then, reinstall the PCI riser cage assembly.
9. Using the following illustration, attach the free end of the SCSI cable option to the SCSI backplane connector:
  - a. Route the SCSI cable option between the hot-swap fans.
  - b. Connect the free end of the SCSI cable option to the SCSI backplane connector.

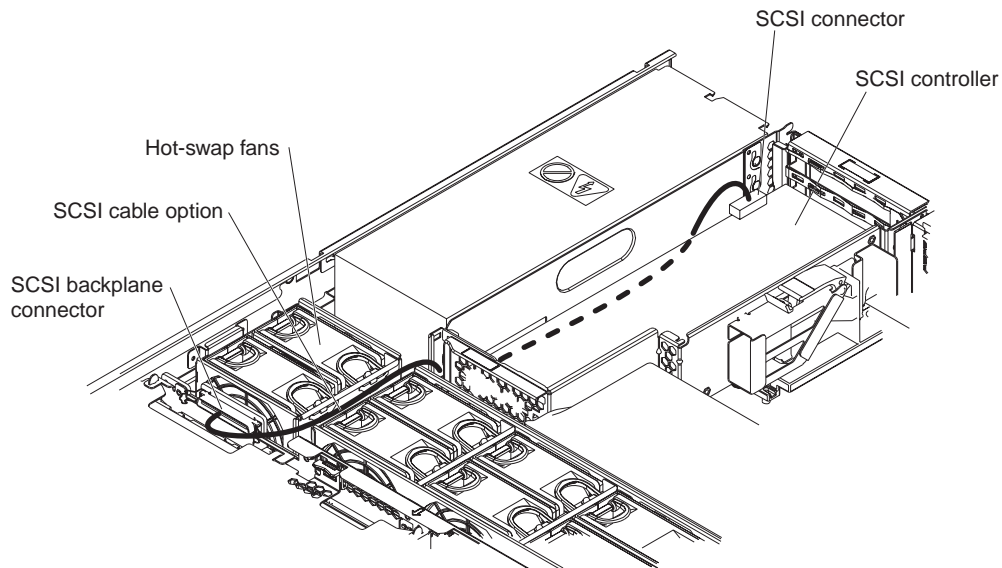

**Attention:**

- a. Ensure that the SCSI cable option does not block the airflow in the PCI riser cage assembly.
  - b. If the SCSI controller contains a battery pack, route the SCSI cable option away from the battery pack.
10. Reinstall the air baffle between the power supplies and the hot-swap fans.
  11. Reinstall the top cover.
  12. Reconnect the external cables and all power cords.
  13. If necessary, turn on the server.

## IBM xSeries 235 installation

Use the documentation that comes with your server along with the following instructions to install the SCSI cable option in an IBM @server xSeries 235 Type 8671.

Statement 5

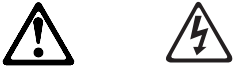

### CAUTION:

The power control button on the device and the power switch on the power supply do not turn off the electrical current supplied to the device. The device also might have more than one power cord. To remove all electrical current from the device, ensure that all power cords are disconnected from the power source.

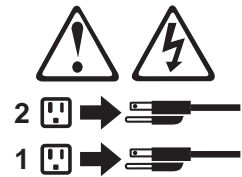

Complete the following steps to install the SCSI cable option:

1. Turn off the server; then, disconnect all power cords and external cables.
2. Remove the server left-side cover or top cover, depending on the model.
3. Remove the air-baffle assembly.

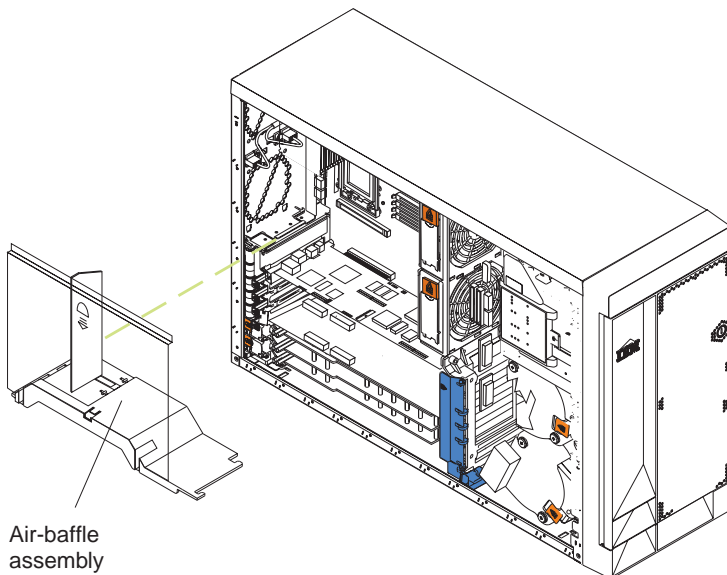

4. Remove the plastic dividers from the PCI slots.
5. Disconnect the cable that is attached to the center-fans connector; then, remove the adapter-support bracket.

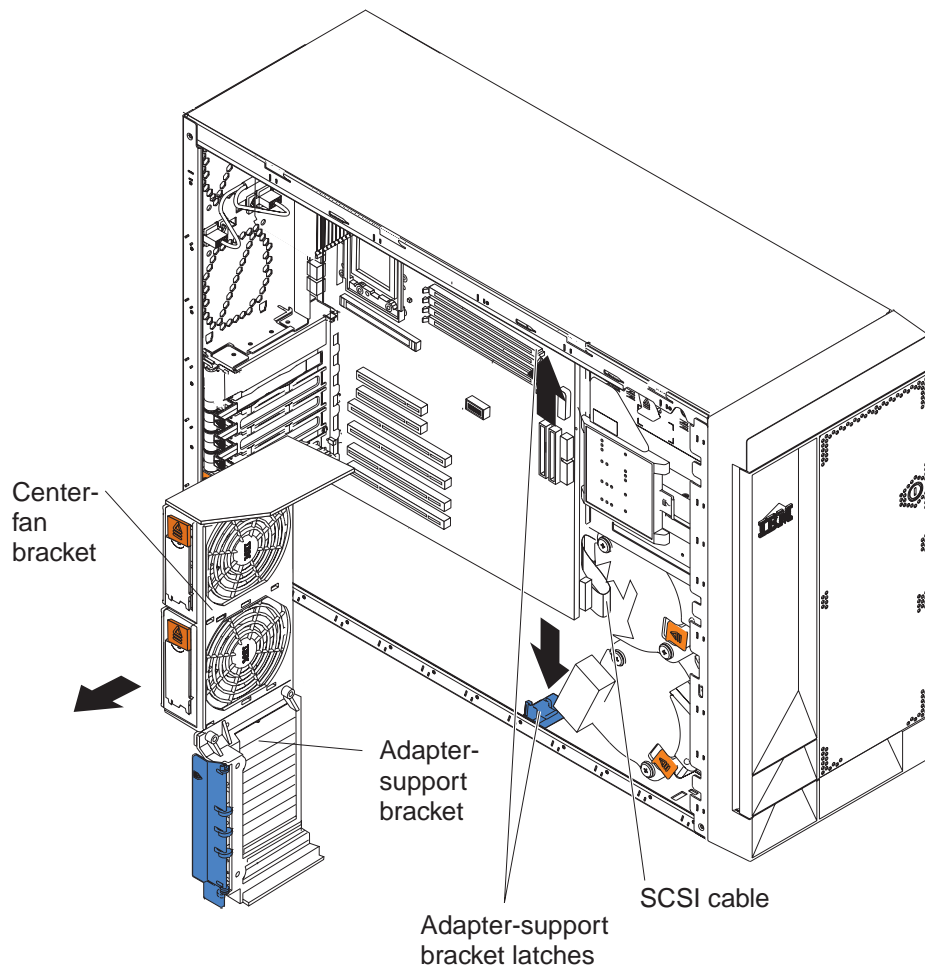

6. Disconnect the SCSI cable from the connector on the SCSI backplane and the connector on the system board. Note the location of the connector on the SCSI backplane; you will attach the new cable to this connector in step 7.
7. Connect one end of the SCSI cable option to the SCSI connector on the SCSI backplane.
8. Reinstall the adapter-support bracket and other components that you removed, except the cover.
9. Route the SCSI cable option through the adapter-support bracket as shown in the illustration in this step; then, connect the free end of the SCSI cable option to the SCSI connector on the SCSI controller, as indicated by the arrow.



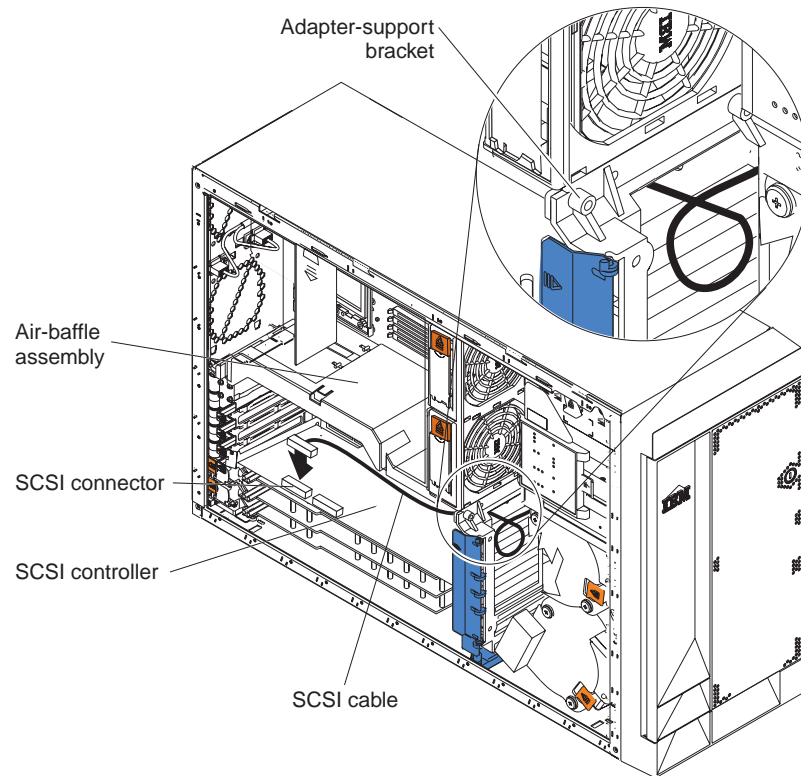

10. Reconnect the remaining internal components that you disconnected.
11. Reinstall the cover.
12. Reconnect the external cables and all power cords.
13. If necessary, turn on the server.

---

## Warranty information

This section contains the warranty period for your product and the service and support that are provided by your warranty.

---

### Warranty period

The warranty period varies by machine type and country or region.

Contact your place of purchase for warranty service information. Some IBM Machines are eligible for on-site warranty service depending on the country or region where service is performed.

**Prior to on-site warranty service, you are required to go through problem determination with an IBM service specialist call center technician.**

This paragraph applies only to products with a warranty period of 3 years on parts and 1 year on labor. A warranty period of 3 years on parts and 1 year on labor means that IBM will provide warranty service without charge for:

1. parts and labor during the first year of the warranty period
2. parts only, on an exchange basis, in the second and third years of the warranty period. IBM will charge you for any labor it provides in performance of the repair or replacement.

The IBM Machine Warranties Web site at [http://www.ibm.com/servers/support/machine\\_warranties/](http://www.ibm.com/servers/support/machine_warranties/) contains a worldwide overview of the IBM Statement of Limited Warranty for IBM Machines, a glossary of terms used in the Statement of Limited Warranty, Frequently Asked Questions (FAQ), and links to Product Support Web pages. The IBM Statement of Limited Warranty is available from this Web site in 29 languages in Portable Document Format (PDF).

**Machine** - 24-Inch ServeRAID-6M Internal Connection Cable Option

Country or region	Warranty period	Service delivery method
Worldwide	Parts - 1 year, labor - 1 year	Customer carry-in or mail-in

### Problem determination

Prior to on-site warranty service, you are required to go through problem determination with an IBM service specialist call center technician. The service specialist will run diagnostic tests on the hardware and check the software.

### Running diagnostics

The IBM service specialist will help you determine whether your equipment is functioning as specified. It might be necessary to isolate the failing xSeries™, Netfinity®, or IntelliStation® system; IBM component; or both from any active production environment to run diagnostics and perform defect-isolation programs. You are responsible for making the system, IBM component, or both available for running diagnostics and defect-isolation programs.

## Checking software

The IBM service specialist will help you ensure that the correct BIOS code, firmware, device drivers, and other supporting IBM software are installed and correctly configured. It might be necessary to manually gather information about the relevant software levels or run IBM-approved utility programs to gather this information. It might be necessary to isolate the failing system from any active production environment to gather this information. You are responsible, with assistance from the service specialist, for gathering this information. The IBM Statement of Limited Warranty does not include on-site assistance with this activity.

## Warranty service and support

With the original purchase of an IBM xSeries or IntelliStation system, you have access to extensive support. During the IBM Machine warranty period, you may call IBM or your reseller for problem-determination assistance under the terms of the IBM Statement of Limited Warranty.

The following services are available during the warranty period:

- **Problem determination** - Trained personnel are available to assist you with determining if you have a hardware problem and deciding what action is necessary to fix the problem.
- **IBM hardware repair** - If the problem is determined to be caused by IBM hardware under warranty, trained service personnel are available to provide the applicable level of service, either on-site or at an IBM service center as determined by IBM.
- **Engineering Change management** - Occasionally, there might be changes that are required after a product has been shipped from IBM. In those instances, IBM will make Engineering Changes (ECs) available that apply to your hardware.
- **Customer replaceable units (CRUs)** - Some parts of IBM xSeries and IntelliStation systems are designated as customer replaceable units. IBM ships CRUs to you for replacement by you. CRUs include keyboards, monitors, memory, diskette drives, hard disk drives, and mice (this list is not inclusive of all CRUs).

The following items are not covered under warranty service:

- Replacement or use of non-IBM parts. All IBM parts contain a 7-character identification in the format IBM FRU XXXXXXX.
- Identification of software problem sources.
- Installation of customer replaceable units (CRUs).
- Installation and configuration of BIOS code, firmware, or device drivers that are designated as customer installable.

See the IBM Statement of Limited Warranty for a full explanation of IBM warranty terms. Be sure to retain your proof of purchase to obtain warranty service.

Please have the following information ready when you call:

- The machine type and model of your IBM hardware product (if available)
- Serial numbers of your IBM hardware products
- A description of the problem
- The exact wording of any error messages
- Hardware and software configuration information

## **International Warranty Service**

If you travel with your xSeries or IntelliStation system or relocate it to a country or region where your system is sold and serviced by IBM or IBM resellers authorized to perform warranty service, International Warranty Service (IWS) is available during the warranty period. Eligible IBM systems are identified by their four-digit machine types.

You can obtain IWS through the service delivery method (such as depot, carry-in, or on-site) provided in the servicing country or region. Service methods and procedures vary by country or region, and some service or parts might not be available in all countries and regions. Service centers in certain countries or regions might not be able to service all models of a particular machine type. In addition, some countries or regions might have fees and restrictions that apply at the time of service.

To determine whether your system is eligible for IWS, go to <http://www.ibm.com/pc/support/> and click **Warranty lookup**.

## **Purchasing additional services**

During and after the warranty period, you can purchase additional services, such as support for IBM and non-IBM hardware, operating system, and application programs; network setup and configuration; upgraded or extended hardware repair services; and custom installations. Service availability and service name might vary by country or region.

For more information about these services, contact your IBM marketing representative.

---

# IBM Statement of Limited Warranty

Z125-4753-06 8/2000

## Part 1 - General Terms

This Statement of Limited Warranty includes Part 1 - General Terms and Part 2 - Country-unique Terms. The terms of Part 2 replace or modify those of Part 1. The warranties provided by IBM in this Statement of Limited Warranty apply only to Machines you purchase for your use, and not for resale, from IBM or your reseller. The term "Machine" means an IBM machine, its features, conversions, upgrades, elements, or accessories, or any combination of them. The term "Machine" does not include any software programs, whether pre-loaded with the Machine, installed subsequently or otherwise. Unless IBM specifies otherwise, the following warranties apply only in the country where you acquire the Machine. Nothing in this Statement of Limited Warranty affects any statutory rights of consumers that cannot be waived or limited by contract. If you have any questions, contact IBM or your reseller.

### The IBM Warranty for Machines

IBM warrants that each Machine 1) is free from defects in materials and workmanship and 2) conforms to IBM's Official Published Specifications ("Specifications"). The warranty period for a Machine is a specified, fixed period commencing on its Date of Installation. The date on your sales receipt is the Date of Installation unless IBM or your reseller informs you otherwise.

If a Machine does not function as warranted during the warranty period, and IBM or your reseller are unable to either 1) make it do so or 2) replace it with one that is at least functionally equivalent, you may return it to your place of purchase and your money will be refunded.

### Extent of Warranty

The warranty does not cover the repair or exchange of a Machine resulting from misuse, accident, modification, unsuitable physical or operating environment, improper maintenance by you, or failure caused by a product for which IBM is not responsible. The warranty is voided by removal or alteration of Machine or parts identification labels.

**THESE WARRANTIES ARE YOUR EXCLUSIVE WARRANTIES AND REPLACE ALL OTHER WARRANTIES OR CONDITIONS, EXPRESS OR IMPLIED, INCLUDING, BUT NOT LIMITED TO, THE IMPLIED WARRANTIES OR CONDITIONS OF MERCHANTABILITY AND FITNESS FOR A PARTICULAR PURPOSE. THESE WARRANTIES GIVE YOU SPECIFIC LEGAL RIGHTS AND YOU MAY ALSO HAVE OTHER RIGHTS WHICH VARY FROM JURISDICTION TO JURISDICTION. SOME JURISDICTIONS DO NOT ALLOW THE EXCLUSION OR LIMITATION OF EXPRESS OR IMPLIED WARRANTIES, SO THE ABOVE EXCLUSION OR LIMITATION MAY NOT APPLY TO YOU. IN THAT EVENT, SUCH WARRANTIES ARE LIMITED IN DURATION TO THE WARRANTY PERIOD. NO WARRANTIES APPLY AFTER THAT PERIOD.**

### Items Not Covered by Warranty

IBM does not warrant uninterrupted or error-free operation of a Machine.

Any technical or other support provided for a Machine under warranty, such as assistance via telephone with "how-to" questions and those regarding Machine set-up and installation, will be provided **WITHOUT WARRANTIES OF ANY KIND.**

### Warranty Service

To obtain warranty service for a Machine, contact IBM or your reseller. If you do not register your Machine with IBM, you may be required to present proof of purchase.

During the warranty period, IBM or your reseller, if approved by IBM to provide warranty service, provides without charge certain types of repair and exchange service to keep Machines in, or restore them to, conformance with their Specifications. IBM or your reseller will inform you of the available types of service for a Machine based on its country of installation. At its discretion, IBM or your reseller will 1) either repair or exchange the failing Machine and 2) provide the service either at your location or a service center. IBM or your reseller will also manage and install selected engineering changes that apply to the Machine.

Some parts of IBM Machines are designated as Customer Replaceable Units (called "CRUs"), e.g., keyboards, memory, or hard disk drives. IBM ships CRUs to you for replacement by you. You must return all defective CRUs to IBM within 30 days of your receipt of the replacement CRU. You are responsible for downloading designated Machine Code and Licensed Internal Code updates from an IBM Internet Web site or from other electronic media, and following the instructions that IBM provides.

When warranty service involves the exchange of a Machine or part, the item IBM or your reseller replaces becomes its property and the replacement becomes yours. You represent that all removed items are genuine and unaltered. The replacement may not be new, but will be in good working order and at least functionally equivalent to the item replaced. The replacement assumes the warranty service status of the replaced item. Many features, conversions, or upgrades involve the removal of parts and their return to IBM. A part that replaces a removed part will assume the warranty service status of the removed part.

Before IBM or your reseller exchanges a Machine or part, you agree to remove all features, parts, options, alterations, and attachments not under warranty service.

You also agree to

1. ensure that the Machine is free of any legal obligations or restrictions that prevent its exchange;
2. obtain authorization from the owner to have IBM or your reseller service a Machine that you do not own; and
3. where applicable, before service is provided:
  - a. follow the problem determination, problem analysis, and service request procedures that IBM or your reseller provides;
  - b. secure all programs, data, and funds contained in a Machine;
  - c. provide IBM or your reseller with sufficient, free, and safe access to your facilities to permit them to fulfill their obligations; and
  - d. inform IBM or your reseller of changes in a Machine's location.

IBM is responsible for loss of, or damage to, your Machine while it is 1) in IBM's possession or 2) in transit in those cases where IBM is responsible for the transportation charges.

Neither IBM nor your reseller is responsible for any of your confidential, proprietary or personal information contained in a Machine which you return to IBM or your reseller for any reason. You should remove all such information from the Machine prior to its return.

### **Limitation of Liability**

Circumstances may arise where, because of a default on IBM's part or other liability, you are entitled to recover damages from IBM. In each such instance, regardless of the basis on which you are entitled to claim damages from IBM (including fundamental breach, negligence, misrepresentation, or other contract or tort claim), except for any liability that cannot be waived or limited by applicable laws, IBM is liable for no more than

1. damages for bodily injury (including death) and damage to real property and tangible personal property; and
2. the amount of any other actual direct damages, up to the charges (if recurring, 12 months' charges apply) for the Machine that is subject of the claim. For purposes of this item, the term "Machine" includes Machine Code and Licensed Internal Code.

This limit also applies to IBM's suppliers and your reseller. It is the maximum for which IBM, its suppliers, and your reseller are collectively responsible.

**UNDER NO CIRCUMSTANCES IS IBM LIABLE FOR ANY OF THE FOLLOWING: 1) THIRD-PARTY CLAIMS AGAINST YOU FOR DAMAGES (OTHER THAN THOSE UNDER THE FIRST ITEM LISTED ABOVE); 2) LOSS OF, OR DAMAGE TO, YOUR RECORDS OR DATA; OR 3) SPECIAL, INCIDENTAL, OR INDIRECT DAMAGES OR FOR ANY ECONOMIC CONSEQUENTIAL DAMAGES, LOST PROFITS OR LOST SAVINGS, EVEN IF IBM, ITS SUPPLIERS OR YOUR RESELLER IS INFORMED OF THEIR POSSIBILITY. SOME JURISDICTIONS DO NOT ALLOW THE EXCLUSION OR LIMITATION OF INCIDENTAL OR CONSEQUENTIAL DAMAGES, SO THE ABOVE LIMITATION OR EXCLUSION MAY NOT APPLY TO YOU.**

### **Governing Law**

Both you and IBM consent to the application of the laws of the country in which you acquired the Machine to govern, interpret, and enforce all of your and IBM's rights, duties, and obligations arising from, or relating in any manner to, the subject matter of this Agreement, without regard to conflict of law principles.

## **Part 2 - Country-unique Terms**

### **AMERICAS**

#### **BRAZIL**

**Governing Law:** *The following is added after the first sentence:*

Any litigation arising from this Agreement will be settled exclusively by the court of Rio de Janeiro.

#### **NORTH AMERICA**

**Warranty Service:** *The following is added to this Section:*

To obtain warranty service from IBM in Canada or the United States, call 1-800-IBM-SERV (426-7378).

#### **CANADA**

**Governing Law:** *The following replaces "laws of the country in which you acquired the Machine" in the first sentence:*

laws in the Province of Ontario.

#### **UNITED STATES**

**Governing Law:** *The following replaces "laws of the country in which you acquired the Machine" in the first sentence:*

laws of the State of New York.

### **ASIA PACIFIC**

#### **AUSTRALIA**

**The IBM Warranty for Machines:** *The following paragraph is added to this Section:*

The warranties specified in this Section are in addition to any rights you may have under the Trade Practices Act 1974 or other similar legislation and are only limited to the extent permitted by the applicable legislation.

**Limitation of Liability:** *The following is added to this Section:*

Where IBM is in breach of a condition or warranty implied by the Trade Practices Act 1974 or other similar legislation, IBM's liability is limited to the repair or replacement of the goods or the supply of equivalent goods. Where that condition or warranty relates to right to sell, quiet possession or clear title, or the goods are of a kind ordinarily acquired for personal, domestic or household use or consumption, then none of the limitations in this paragraph apply.

**Governing Law:** *The following replaces "laws of the country in which you acquired the Machine" in the first sentence:*

laws of the State or Territory.

### **CAMBODIA, LAOS, AND VIETNAM**

**Governing Law:** *The following replaces "laws of the country in which you acquired the Machine" in the first sentence:*

laws of the State of New York.

*The following is added to this Section:*

Disputes and differences arising out of or in connection with this Agreement shall be finally settled by arbitration which shall be held in Singapore in accordance with the rules of the International Chamber of Commerce (ICC). The arbitrator or arbitrators designated in conformity with those rules shall have the power to rule on their own competence and on the validity of the Agreement to submit to arbitration. The arbitration award shall be final and binding for the parties without appeal and the arbitral award shall be in writing and set forth the findings of fact and the conclusions of law.

All proceedings shall be conducted, including all documents presented in such proceedings, in the English language. The number of arbitrators shall be three, with each side to the dispute being entitled to appoint one arbitrator.

The two arbitrators appointed by the parties shall appoint a third arbitrator before proceeding upon the reference. The third arbitrator shall act as chairman of the proceedings. Vacancies in the post of chairman shall be filled by the president of the ICC. Other vacancies shall be filled by the respective nominating party. Proceedings shall continue from the stage they were at when the vacancy occurred.

If one of the parties refuses or otherwise fails to appoint an arbitrator within 30 days of the date the other party appoints its, the first appointed arbitrator shall be the sole arbitrator, provided that the arbitrator was validly and properly appointed.

The English language version of this Agreement prevails over any other language version.

### **HONG KONG AND MACAU**

**Governing Law:** *The following replaces "laws of the country in which you acquired the Machine" in the first sentence:*

laws of Hong Kong Special Administrative Region.

### **INDIA**

**Limitation of Liability:** *The following replaces items 1 and 2 of this Section:*



1. liability for bodily injury (including death) or damage to real property and tangible personal property will be limited to that caused by IBM's negligence;
2. as to any other actual damage arising in any situation involving nonperformance by IBM pursuant to, or in any way related to the subject of this Statement of Limited Warranty, IBM's liability will be limited to the charge paid by you for the individual Machine that is the subject of the claim.

## **JAPAN**

**Governing Law:** *The following sentence is added to this Section:*

Any doubts concerning this Agreement will be initially resolved between us in good faith and in accordance with the principle of mutual trust.

## **NEW ZEALAND**

**The IBM Warranty for Machines:** *The following paragraph is added to this Section:*

The warranties specified in this Section are in addition to any rights you may have under the Consumer Guarantees Act 1993 or other legislation which cannot be excluded or limited. The Consumer Guarantees Act 1993 will not apply in respect of any goods which IBM provides, if you require the goods for the purposes of a business as defined in that Act.

**Limitation of Liability:** *The following is added to this Section:*

Where Machines are not acquired for the purposes of a business as defined in the Consumer Guarantees Act 1993, the limitations in this Section are subject to the limitations in that Act.

## **PEOPLE'S REPUBLIC OF CHINA (PRC)**

**Governing Law:** *The following replaces this Section:*

Both you and IBM consent to the application of the laws of the State of New York (except when local law requires otherwise) to govern, interpret, and enforce all your and IBM's rights, duties, and obligations arising from, or relating in any manner to, the subject matter of this Agreement, without regard to conflict of law principles.

Any disputes arising from or in connection with this Agreement will first be resolved by friendly negotiations, failing which either of us has the right to submit the dispute to the China International Economic and Trade Arbitration Commission in Beijing, the PRC, for arbitration in accordance with its arbitration rules in force at the time. The arbitration tribunal will consist of three arbitrators. The language to be used therein will be English and Chinese. An arbitral award will be final and binding on all the parties, and will be enforceable under the Convention on the Recognition and Enforcement of Foreign Arbitral Awards (1958).

The arbitration fee will be borne by the losing party unless otherwise determined by the arbitral award.

During the course of arbitration, this Agreement will continue to be performed except for the part which the parties are disputing and which is undergoing arbitration.

## **EUROPE, MIDDLE EAST, AFRICA (EMEA)**

***THE FOLLOWING TERMS APPLY TO ALL EMEA COUNTRIES:***

The terms of this Statement of Limited Warranty apply to Machines purchased from IBM or an IBM reseller.

### **Warranty Service:**

If you purchase an IBM Machine in Austria, Belgium, Denmark, Estonia, Finland, France, Germany, Greece, Iceland, Ireland, Italy, Latvia, Lithuania, Luxembourg, Netherlands, Norway, Portugal, Spain,

Sweden, Switzerland or United Kingdom, you may obtain warranty service for that Machine in any of those countries from either (1) an IBM reseller approved to perform warranty service or (2) from IBM. If you purchase an IBM Personal Computer Machine in Albania, Armenia, Belarus, Bosnia and Herzegovina, Bulgaria, Croatia, Czech Republic, Georgia, Hungary, Kazakhstan, Kirghizia, Federal Republic of Yugoslavia, Former Yugoslav Republic of Macedonia (FYROM), Moldova, Poland, Romania, Russia, Slovak Republic, Slovenia, or Ukraine, you may obtain warranty service for that Machine in any of those countries from either (1) an IBM reseller approved to perform warranty service or (2) from IBM.

If you purchase an IBM Machine in a Middle Eastern or African country, you may obtain warranty service for that Machine from the IBM entity within the country of purchase, if that IBM entity provides warranty service in that country, or from an IBM reseller, approved by IBM to perform warranty service on that Machine in that country. Warranty service in Africa is available within 50 kilometers of an IBM authorized service provider. You are responsible for transportation costs for Machines located outside 50 kilometers of an IBM authorized service provider.

#### **Governing Law:**

The applicable laws that govern, interpret and enforce rights, duties, and obligations of each of us arising from, or relating in any manner to, the subject matter of this Statement, without regard to conflict of laws principles, as well as Country-unique terms and competent court for this Statement are those of the country in which the warranty service is being provided, except that in 1) Albania, Bosnia-Herzegovina, Bulgaria, Croatia, Hungary, Former Yugoslav Republic of Macedonia, Romania, Slovakia, Slovenia, Armenia, Azerbaijan, Belarus, Georgia, Kazakhstan, Kyrgyzstan, Moldova, Russia, Tajikistan, Turkmenistan, Ukraine, and Uzbekistan, the laws of Austria apply; 2) Estonia, Latvia, and Lithuania, the laws of Finland apply; 3) Algeria, Benin, Burkina Faso, Cameroon, Cape Verde, Central African Republic, Chad, Congo, Djibouti, Democratic Republic of Congo, Equatorial Guinea, France, Gabon, Gambia, Guinea, Guinea-Bissau, Ivory Coast, Lebanon, Mali, Mauritania, Morocco, Niger, Senegal, Togo, and Tunisia, this Agreement will be construed and the legal relations between the parties will be determined in accordance with the French laws and all disputes arising out of this Agreement or related to its violation or execution, including summary proceedings, will be settled exclusively by the Commercial Court of Paris; 4) Angola, Bahrain, Botswana, Burundi, Egypt, Eritrea, Ethiopia, Ghana, Jordan, Kenya, Kuwait, Liberia, Malawi, Malta, Mozambique, Nigeria, Oman, Pakistan, Qatar, Rwanda, Sao Tome, Saudi Arabia, Sierra Leone, Somalia, Tanzania, Uganda, United Arab Emirates, United Kingdom, West Bank/Gaza, Yemen, Zambia, and Zimbabwe, this Agreement will be governed by English Law and disputes relating to it will be submitted to the exclusive jurisdiction of the English courts; and 5) in Greece, Israel, Italy, Portugal, and Spain any legal claim arising out of this Statement will be brought before, and finally settled by, the competent court of Athens, Tel Aviv, Milan, Lisbon, and Madrid, respectively.

#### ***THE FOLLOWING TERMS APPLY TO THE COUNTRY SPECIFIED:***

##### **AUSTRIA AND GERMANY**

**The IBM Warranty for Machines:** *The following replaces the first sentence of the first paragraph of this Section:*

The warranty for an IBM Machine covers the functionality of the Machine for its normal use and the Machine's conformity to its Specifications.

*The following paragraphs are added to this Section:*

The minimum warranty period for Machines is six months. In case IBM or your reseller is unable to repair an IBM Machine, you can alternatively ask for a partial refund as far as justified by the reduced value of the unrepaired Machine or ask for a cancellation of the respective agreement for such Machine and get your money refunded.

**Extent of Warranty:** *The second paragraph does not apply.*

**Warranty Service:** *The following is added to this Section:*

During the warranty period, transportation for delivery of the failing Machine to IBM will be at IBM's expense.

**Limitation of Liability:** *The following paragraph is added to this Section:*

The limitations and exclusions specified in the Statement of Limited Warranty will not apply to damages caused by IBM with fraud or gross negligence and for express warranty.

*The following sentence is added to the end of item 2:*

IBM's liability under this item is limited to the violation of essential contractual terms in cases of ordinary negligence.

## EGYPT

**Limitation of Liability:** *The following replaces item 2 in this Section:*

as to any other actual direct damages, IBM's liability will be limited to the total amount you paid for the Machine that is the subject of the claim. For purposes of this item, the term "Machine" includes Machine Code and Licensed Internal Code.

*Applicability of suppliers and resellers (unchanged).*

## FRANCE

**Limitation of Liability:** *The following replaces the second sentence of the first paragraph of this Section:*

In such instances, regardless of the basis on which you are entitled to claim damages from IBM, IBM is liable for no more than: *(items 1 and 2 unchanged).*

## IRELAND

**Extent of Warranty:** *The following is added to this Section:*

Except as expressly provided in these terms and conditions, all statutory conditions, including all warranties implied, but without prejudice to the generality of the foregoing all warranties implied by the Sale of Goods Act 1893 or the Sale of Goods and Supply of Services Act 1980 are hereby excluded.

**Limitation of Liability:** *The following replaces items one and two of the first paragraph of this Section:*

1. death or personal injury or physical damage to your real property solely caused by IBM's negligence; and
2. the amount of any other actual direct damages, up to 125 percent of the charges (if recurring, the 12 months' charges apply) for the Machine that is the subject of the claim or which otherwise gives rise to the claim.

*Applicability of suppliers and resellers (unchanged).*

*The following paragraph is added at the end of this Section:*

IBM's entire liability and your sole remedy, whether in contract or in tort, in respect of any default shall be limited to damages.

## ITALY

**Limitation of Liability:** *The following replaces the second sentence in the first paragraph:*

In each such instance unless otherwise provided by mandatory law, IBM is liable for no more than:

1. *(unchanged)*

2. as to any other actual damage arising in all situations involving nonperformance by IBM pursuant to, or in any way related to the subject matter of this Statement of Warranty, IBM's liability, will be limited to the total amount you paid for the Machine that is the subject of the claim.

*Applicability of suppliers and resellers (unchanged).*

*The following replaces the third paragraph of this Section:*

Unless otherwise provided by mandatory law, IBM and your reseller are not liable for any of the following: *(items 1 and 2 unchanged)* 3) indirect damages, even if IBM or your reseller is informed of their possibility.

## **SOUTH AFRICA, NAMIBIA, BOTSWANA, LESOTHO AND SWAZILAND**

**Limitation of Liability:** *The following is added to this Section:*

IBM's entire liability to you for actual damages arising in all situations involving nonperformance by IBM in respect of the subject matter of this Statement of Warranty will be limited to the charge paid by you for the individual Machine that is the subject of your claim from IBM.

## **UNITED KINGDOM**

**Limitation of Liability:** *The following replaces items 1 and 2 of the first paragraph of this Section:*

1. death or personal injury or physical damage to your real property solely caused by IBM's negligence;
2. the amount of any other actual direct damages or loss, up to 125 percent of the charges (if recurring, the 12 months' charges apply) for the Machine that is the subject of the claim or which otherwise gives rise to the claim;

*The following item is added to this paragraph:*

3. breach of IBM's obligations implied by Section 12 of the Sale of Goods Act 1979 or Section 2 of the Supply of Goods and Services Act 1982.

*Applicability of suppliers and resellers (unchanged).*

*The following is added to the end of this Section:*

IBM's entire liability and your sole remedy, whether in contract or in tort, in respect of any default shall be limited to damages.

---

## **Notices**

IBM may not offer the products, services, or features discussed in this document in other countries. Consult your local IBM representative for information on the products and services currently available in your area. Any reference to an IBM product, program, or service is not intended to state or imply that only that IBM product, program, or service may be used. Any functionally equivalent product, program, or service that does not infringe any IBM intellectual property right may be used instead. However, it is the user's responsibility to evaluate and verify the operation of any non-IBM product, program, or service.

IBM may have patents or pending patent applications covering subject matter described in this document. The furnishing of this document does not give you any license to these patents. You can send license inquiries, in writing, to:

*IBM Director of Licensing  
IBM Corporation  
North Castle Drive  
Armonk, NY 10504-1785  
U.S.A.*

INTERNATIONAL BUSINESS MACHINES CORPORATION PROVIDES THIS PUBLICATION "AS IS" WITHOUT WARRANTY OF ANY KIND, EITHER EXPRESS OR IMPLIED, INCLUDING, BUT NOT LIMITED TO, THE IMPLIED WARRANTIES OF NON-INFRINGEMENT, MERCHANTABILITY OR FITNESS FOR A PARTICULAR PURPOSE. Some jurisdictions do not allow disclaimer of express or implied warranties in certain transactions; therefore, this statement may not apply to you.

This information could include technical inaccuracies or typographical errors. Changes are periodically made to the information herein; these changes will be incorporated in new editions of the publication. IBM may make improvements and/or changes in the product(s) and/or the program(s) described in this publication at any time without notice.

Any references in this information to non-IBM Web sites are provided for convenience only and do not in any manner serve as an endorsement of those Web sites. The materials at those Web sites are not part of the materials for this IBM product and use of those Web sites is at your own risk.

IBM may use or distribute any of the information you supply in any way it believes appropriate without incurring any obligation to you.

---

## Trademarks

The following terms are trademarks of International Business Machines Corporation in the United States, other countries, or both:

e-business logo  
eServer  
IBM  
IntelliStation  
Netfinity  
ServeRAID  
xSeries

Other company, product, or service names may be trademarks or service marks of others.

