

IBM Netfinity

**Cluster Enabler  
Getting Started Handbook  
for Oracle Parallel Server**



IBM

IBM Netfinity

**Cluster Enabler  
Getting Started Handbook  
for Oracle Parallel Server**

**Note**

Before using this information and the product it supports, be sure to read the general information under Appendix C, "Product Notices" on page 63.

**First Edition (September 1998)**

**The following paragraph does not apply to the United Kingdom or any country where such provisions are inconsistent with local law:** INTERNATIONAL BUSINESS MACHINES CORPORATION PROVIDES THIS PUBLICATION "AS IS" WITHOUT WARRANTY OF ANY KIND, EITHER EXPRESS OR IMPLIED, INCLUDING, BUT NOT LIMITED TO, THE IMPLIED WARRANTIES OF MERCHANTABILITY OR FITNESS FOR A PARTICULAR PURPOSE. Some states do not allow disclaimer of express or implied warranties in certain transactions, therefore, this statement may not apply to you.

This publication could include technical inaccuracies or typographical errors. Changes are periodically made to the information herein; these changes will be incorporated in new editions of the publication. IBM may make improvements and/or changes in the product(s) and/or the program(s) described in this publication at any time.

This publication was developed for products and services offered in the United States of America. IBM may not offer the products, services, or features discussed in this document in other countries, and the information is subject to change without notice. Consult your local IBM representative for information on the products, services, and features available in your area.

Requests for technical information about IBM products should be made to your IBM reseller or IBM marketing representative.

**Copyright International Business Machines Corporation 1998. All rights reserved.**

Note to U.S. Government Users — Documentation related to restricted rights — Use, duplication or disclosure is subject to restrictions set forth in GSA ADP Schedule Contract with IBM Corp.

---

# Contents

<b>Safety Information</b> .....	iv
<b>About This Book</b> .....	v
How This Book Is Organized .....	v
Publications Required for the Installation .....	vi
Hardware Publications .....	vi
Software Publications .....	vii
<b>Introduction</b> .....	1
Hardware Installation Requirements .....	2
Software Installation Requirements .....	3
Tool Requirements .....	3
<b>Installing the Hardware</b> .....	4
Front and Back View of the Hardware .....	5
Step 1: Unpack and Set Up the Racks .....	7
Step 2: Install the Hardware in Rack #1 .....	7
Step 3: Install the Hardware in Rack #2 .....	7
Step 4: Install the Hardware in Rack #3 .....	8
Step 5: Install the Required Upgrades in the IBM Netfinity 7000 Server .....	8
<b>Cabling the Hardware</b> .....	10
Cable Management and Labeling for Solutions Utilizing Racks .....	11
Step 1: Connect the Monitor, Keyboard, and Mouse Cables to the Console Server Selector Switch .....	12
Step 2: Connect the IBM 100/10 EtherJet PCI Adapter to the 8271-712 Ethernet LAN Switch .....	16
Step 3: Connect the Fibre Channel Cables from the Emulex Host Adapter to the Vixel Hubs .....	23
Step 4: Connect the Symbios DM2000 Drive Module to the Symbios CM1000 Command Module .....	30
Step 5: Connect the APC Cables to the Server .....	30
Step 6: Connect Power to the APC Smart-UPS Power Supply .....	34
Step 7: Hardware Power Up Sequence .....	38
<b>Installing the Software</b> .....	39
Step 1: Configure the ServeRAID II Adapter .....	40
Step 2: Install Microsoft Windows NT Server Enterprise Edition Service Pack 3 .....	40
Step 3: Install the Emulex Device Drivers .....	40
Step 4: Install SYMlicity Storage Manager .....	40
Step 5: Create an Extended Partition for the IBM Cluster Enabler Heartbeat Disk .....	41
Step 6: Install Oracle Parallel Server (OPS) .....	41
Step 7: Install the IBM Netfinity Cluster Enabler (OSD Software) .....	41
Step 8: Test and Verify Connectivity .....	45
Step 9: Assign Symbolic Links for the IBM Netfinity Cluster Enabler Heartbeat Disk .....	45
Step 10: Configure the IBM Netfinity Cluster Enabler (OSD Software) .....	46
Step 11: Set Port Numbers in Windows NT Services File .....	49

<b>Updating the IBM Cluster Enabler</b> . . . . .	50
<b>Troubleshooting IBM Netfinity Cluster Enabler</b> . . . . .	51
Isolating Problems . . . . .	53
<b>Getting Help, Service, and Information</b> . . . . .	57
Solving Problems . . . . .	57
<b>Appendix A. Supplementary Instructions for Installing a Five or Six Node   Oracle Parallel Server Configuration</b> . . . . .	58
Step 1: Copy Initialization Files . . . . .	58
Step 2: Assign Symbolic Links to Each Logical Drive . . . . .	59
Step 3: Configure the IBM Netfinity Cluster Enabler (OSD Software) . . . . .	59
Step 4: Create Services . . . . .	59
Step 5: Add the ORACLE_SID Entry to the Registry . . . . .	59
Step 6: Configure the Network . . . . .	59
Step 7: Create an Oracle Parallel Server Database . . . . .	59
<b>Appendix B. About the IBM Core Cluster Service</b> . . . . .	61
<b>Appendix C. Product Notices</b> . . . . .	63
Trademarks . . . . .	63

---

## Safety Information



Before installing this product, read the "Safety Information" section of the *Server Library*.

Antes de instalar este produto, leia o Manual de Informações sobre Segurança.

**安裝本產品前請先閱讀《安全信息》手冊。**

Prije instalacije ovog proizvoda pročitajte priručnik sa sigurnosnim uputama.

P ed instalací tohoto produktu si p e t e p íru ku bezpe nostních instrukcí.

Læs hæftet med sikkerhedsforskrifter, før du installerer dette produkt.

Lue Safety Information -kirjanen, ennen kuin asennat tämän tuotteen.

Avant de procéder à l'installation de ce produit, lisez le manuel Safety Information.

Vor Beginn der Installation die Broschüre mit Sicherheitshinweisen lesen.

Πριν εγκαταστήσετε αυτό το προϊόν, διαβάστε το εγχειρίδιο Safety Information.

**Installálás el tt olvassa el a Biztonsági el írások kézikönyvét !**

Prima di installare questo prodotto, leggere l'opuscolo contenente le informazioni sulla sicurezza.

**本製品を導入する前に、安全情報資料を御読みください。**

이 제품을 설치하기 전에, 안전 정보 책자를 읽어보십시오.

Пред да го инсталирате овој производ прочитајте ја книгата со безбедносни информации.

Lees voordat u dit product installeert eerst het boekje met veiligheidsvoorschriften.

Les heftet om sikkerhetsinformasjon (Safety Information) før du installerer dette produktet.

Przed zainstalowaniem tego produktu należy przeczytać broszurę Informacje Dotyczące Bezpieczeństwa.

Antes de instalar este produto, leia o folheto Informações sobre Segurança.

Перед установкой продукта прочтите брошюру по технике безопасности (Safety Information).

Pred inštaláciou tohto produktu si pre ítajte Informa nú brožúrku o bezpe nosti.

Preden namestite ta izdelek, preberite knjižico Varnostne informacije.

Antes de instalar este producto, lea la Información de Seguridad.

Läs säkerhetsinformationen innan du installerar den här produkten.

**在安裝本產品之前，也請先閱讀「安全性資訊」小冊子。**

---

## About This Book

This book will assist you with the hardware setup and software installation of the IBM Netfinity Cluster Enabler Operating System Dependent (OSD) software that is used for building an IBM Netfinity Clustering Solution.

This book guides you through the hardware setup of your IBM Netfinity Cluster of Servers, and through installing the IBM Netfinity Cluster Enabler OSD software. The OSD is required for the proper operation of the Oracle Parallel Server (OPS). The hardware setup consists of two, four, or six IBM Netfinity 7000 Servers with a fibre channel external storage system as the shared device.

This book is intended for the network administrator—that is, the individual responsible for configuring, maintaining, managing, and troubleshooting an IBM Netfinity Server.

---

## How This Book Is Organized

This book has the following major sections:

“Introduction” on page 1 contains a description of the IBM Netfinity Cluster Enabler.

“Installing the Hardware” on page 4 contains procedures for installing and cabling the hardware in a rack. This section also contains information about cable management and labeling for the IBM Netfinity Cluster Enabler solution.

“Installing the Software” on page 39 contains procedures for installing all the necessary software including IBM Netfinity Cluster Enabler.

“Troubleshooting IBM Netfinity Cluster Enabler” on page 51 contains information on how to recover from some potential problems that might occur and information on how to isolate problems.

“Getting Help, Service, and Information” on page 57 contains instructions on how and where to obtain service.

Appendix A, “Supplementary Instructions for Installing a Five or Six Node Oracle Parallel Server Configuration” on page 58 contains instructions on how to set up a fifth and sixth node in the cluster.

Appendix B, “About the IBM Core Cluster Service” on page 61 contains information about the manual installation and operation of the IBM Core Cluster Service.

Appendix C, “Product Notices” on page 63 contains product warranties, notices, and trademarks.



---

## Publications Required for the Installation

During the installation of the IBM Netfinity Cluster Enabler, you might need to refer to one or more of the following publications.

### Hardware Publications

*IBM Netfinity 7000 User's Handbook.* This book contains detailed instructions for installing and setting up your IBM Netfinity 7000 servers.

*IBM 9306 Model 900 Netfinity Rack Enclosure Unpacking Instruction.* This book contains detailed instructions for unpacking the PC Server Rack Enclosure.

*IBM 9306 Model 900 Netfinity Rack Planning and Installation Guide.* This book contains information about the IBM 9306 Model 900 Netfinity Rack. It also contains a product description, a list of available options, option and equipment installation guidelines, and a description of the IBM Netfinity Rack Configurator program.

*IBM Netfinity Rack Monitor Compartment Installation Instructions.* This book contains detailed instructions for installing the monitor compartment in a rack.

*IBM 9306 Model 900 Netfinity Rack Console Server Selector Switch User's Guide and Installation Instructions.* This book contains detailed instructions for installing and using the selector switch.

*IBM Netfinity Rack Attachment Kit Installation Instructions.* This book contains detailed instructions for connecting two or more racks together to form a suite of racks.

*IBM Netfinity Fixed Shelf Installation Instructions.* This book contains detailed instructions for installing fixed shelves in the rack.

*IBM ServeRAID II Adapter Installation Instructions and User's Guide.* This book contains information and detailed instructions for using the IBM ServeRAID Adapter and the IBM ServeRAID II Ultra SCSI Adapter.

*IBM PC Server 100/10 EtherJet Adapter User's Manual.* This book contains detailed instructions for installing the IBM 100/10 PCI EtherJet adapter in the server.

*8271 Ethernet LAN Switch Model 712 User's Guide.* This book contains information for installing and configuring an 8271-712 switch.

*APC Smart-UPS Uninterruptible Power Supply.* This book contains information that will help you get the fullest performance and service life from your UPS along with a description of the inner workings of the UPS.

*Emulex Light Pulse Fibre Channel Solutions User Guide.* This book contains detailed instructions for installing the Emulex LP6000 Fibre Channel PCI Host Adapter.

*MetaStor Drive Module System Guide.* This book contains introductory information and step-by-step instructions for operating and servicing the MetaStor DM2000 Drive Module.

*MetaStor Command Module Installation Guide.* This book contains detailed instructions for installing a rack mount MetaStor CM1000 Command Module.

*MetaStor Command Module System Guide.* This book contains introductory information and step-by-step instructions for operating and servicing the MetaStor CM1000 Command Module.

## **Software Publications**

*PowerChute Plus CD-ROM.* This CD-ROM contains instructions for installing PowerChute *plus* for Windows NT and for installing related products and features.

*Microsoft Windows NT Installation and User's Guide.* This book contains instructions for installing and using Microsoft Windows NT.

*Oracle Parallel Server Getting Started for Windows NT Version 8.0.4.* This book contains operating system-specific information on using Oracle Parallel Server for Windows NT.

*SYMplicity Storage Manager User Guide.* This book contains complete instructions for installing the SYMplicity Storage Manager software to perform various storage management tasks.

*SYMplicity Storage Manager Installation and Support Guide for Windows NT.* This book contains detailed instructions for installing the SYMplicity Storage Manager software with the Windows NT operating system.

# Introduction

Welcome to the *Getting Started Handbook* for the *IBM Netfinity Cluster Enabler*. This book will guide you through the process of assembling the hardware of your IBM Netfinity Cluster Server and installing your software for the proper operation of the Oracle Parallel Server (OPS) Version 8.04. The IBM Netfinity Cluster Enabler is the key to integrating the Windows NT operating system with Oracle Parallel Server. The IBM Netfinity Cluster Enabler consists of IBM Core Cluster Services (IBMCCS) and Operating System Dependent (OSD) software, which have been developed according to Oracle Parallel Server specifications.

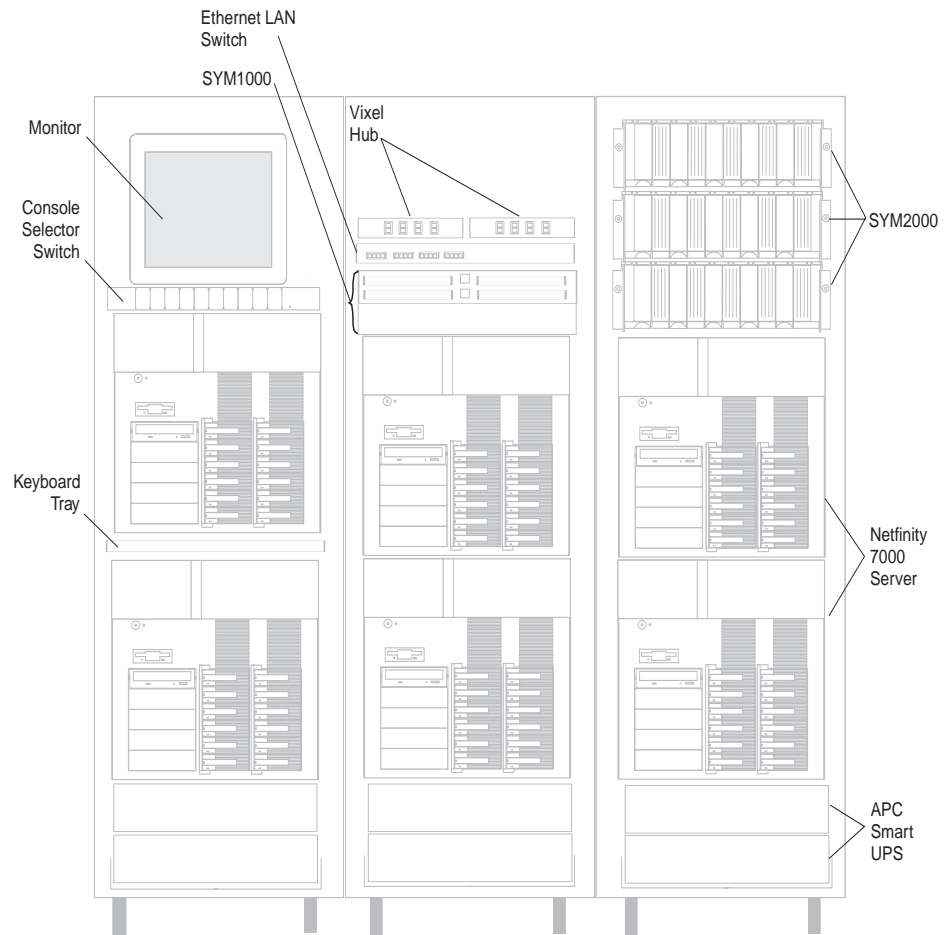

Figure 1. Six-Node Cluster Configuration

The IBM Netfinity Cluster Solution consists of two, four, or six IBM Netfinity 7000 servers configured with various hardware components to form a system capable of delivering a single database to a maximum number of clients for high availability and scalability. The system can be configured according to the demands of the operating environment, whether that be to maximize the number of clients, or to configure the system with storage redundancy to safeguard the information contained within the database. All of these options allow for greater user design and flexibility; this guide will also assist in setting up those options.

## Hardware Installation Requirements

The following items are required to complete a two, four, or six server (node) hardware configuration. However, hardware requirements may vary depending upon your configuration.

Hardware Requirements	2 Node	4 Node	6 Node
IBM Netfinity Racks	1 or 2	2	3
IBM Netfinity 7000 Servers	2	4	6
IBM Console Server Selector Switch	1	1	1
IBM ServeRAID II Adapters (1 per server)	2	4	6
IBM 100/10 EtherJet PCI Adapters (** see the note)	2	4	6
IBM Console Cable Sets	2	4	6
IBM 8271-712 Ethernet LAN Switch	1	1	1
Monitor Compartment for the IBM Netfinity Enclosure	0	1	1
Fixed Shelf for the IBM Netfinity Rack	1	1	1
Keyboard tray for the IBM Netfinity Enclosure	1	1	1
Hard Disk Drives for the Server (3 per server)	6	12	18
Symbios CM1000 MetaStor Command Module	1	1	1
3702 Array Controllers for the MetaStor Command Module	2	2	2
Rack Mounts for the Symbios CM1000 MetaStor Command Module	1	1	1
Symbios DM2000 MetaStor Drive Modules	up to 3	up to 3	up to 3
Hard Disk Drives for the Symbios DM2000 MetaStor Drive Module (per drive module)	up to 10	up to 10	up to 10
Rack Mounts for the Symbios DM2000 MetaStor Drive Module	up to 3	up to 3	up to 3
Vixel Rapport 1000 FCAL Hub	1	2	2
Emulex LP6000 Host Adapters	2	4	6
Microprocessor Upgrades (3 per server)	6	12	18
512 MB RAM Upgrade Options (1 GB of memory per server) (Refer to the documentation that comes with your server for memory configuration.)	3	6	8
APC Smart-UPS	2	4	6
Standard Category-5 Ethernet Cables with RJ45 Connectors	2	4	6
Shortwave Fibre Optic Cables	5	7	9
Fibre Optic Gigabit Interface Converters (each vixel hub comes with 4 GBICs)	6	8	10
1 Megabyte of Video RAM per Netfinity Server	-	-	-

<b>Hardware Requirements</b>	<b>2 Node</b>	<b>4 Node</b>	<b>6 Node</b>
Display Monitor, Keyboard, and Mouse	1	1	1
<b>Note:</b> **Plan for additional adapter(s) for private LAN connection.			
<b>Note:</b> In addition to the items listed above, a table will be required to hold the monitor, keyboard, and mouse for a 2 server (node) and 4 server (node) cluster.			

---

## Software Installation Requirements

The following software is required to complete the solution.

Microsoft Windows NT Server, Version 4.0, Enterprise Edition with Service Pack 3 (purchased from Microsoft).

Symbios Storage Manager for Windows NT, Version 6.20 or higher (included with Metastor subsystem).

Oracle Enterprise Edition Version 8.0.4 for Windows NT (purchased from Oracle).

IBM Netfinity Cluster Enabler, Version 1.0 (download the software from the World Wide Web) currently at:

<http://www.pc.ibm.com/us/netfinity/clustering.html>

**Note:** The above address will link you to the down-loadable file.

Contact your service representative for assistance.

---

## Tool Requirements

The following tools are required for the installation of this kit:

- A small flat-blade screw driver
- A phillips-head screwdriver
- A 3/16-inch socket wrench and nut driver
- A 5-mm allen wrench
- An 8-mm socket wrench
- A 9-mm socket wrench
- A 10-mm socket wrench

---

## Installing the Hardware

This section will guide you through the tasks for setting up the hardware as part of the IBM Netfinity Cluster Enabler Solution. The following instructions guide you through installing a six server (node) configuration in three racks, starting from the bottom.

**Note:** If you are installing a two or four server (node) configuration, refer to the illustrations when installing the hardware into the rack.

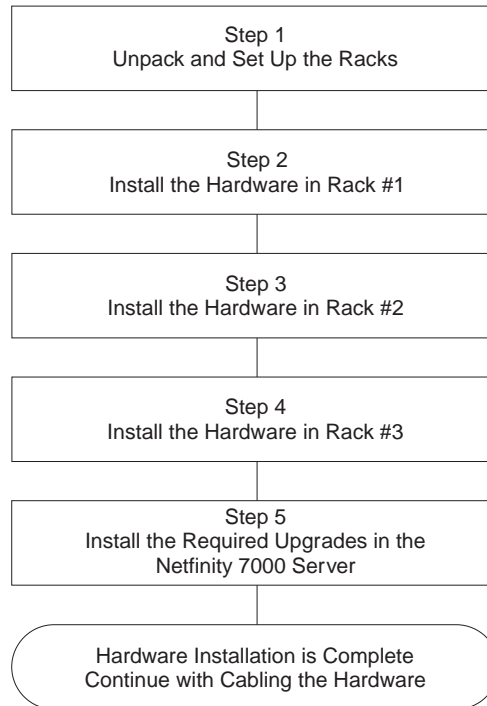

## Front and Back View of the Hardware

The legend contains detailed front and rear views of the hardware components illustrated in this handbook. The illustrations in this handbook might look slightly different from your hardware.

### Front View



Vixel Hub



IBM Console Server Selector Switch

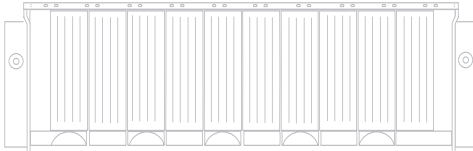

Symbios DM2000 MetaStor Drive Module

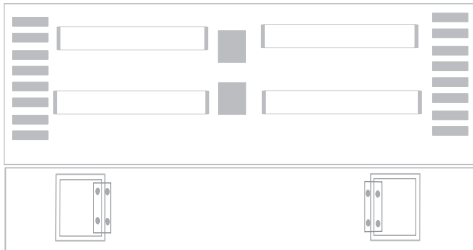

Symbios CM1000 MetaStor Command Module

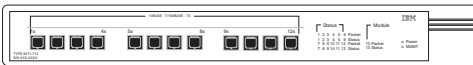

IBM 8271-712 Ethernet LAN Switch

### Back View

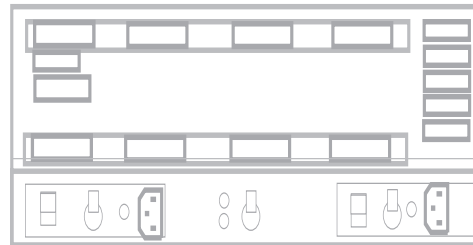
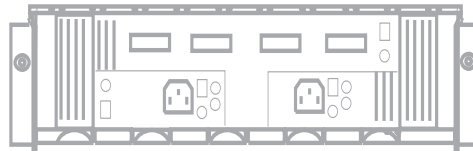

**Front View**

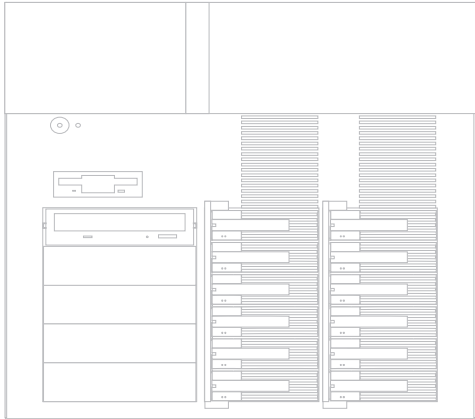

IBM Netfinity 7000 Server



APC Smart-UPS

**Back View**

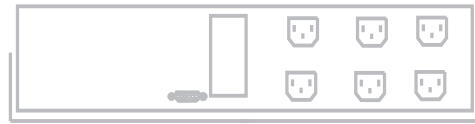
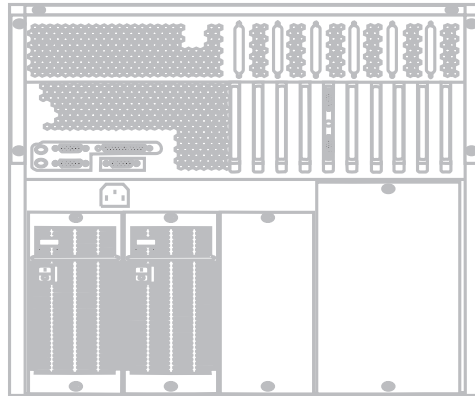



---

## Step 1: Unpack and Set Up the Racks

Unpack and setup the racks.

---

**TIP:** For individual racks, be sure to install the stabilizer brackets.

---

Refer to the IBM Netfinity Rack Configurator Program and the *IBM 9306 Model 900 Netfinity Rack Planning and Installation Guide* for detailed instructions.

**Note:** Do not install the monitor, keyboard, and mouse at this time.

---

## Step 2: Install the Hardware in Rack #1

---

**TIP:** It is good practice to install the APC Smart-UPS and the servers in the bottom of rack.

---

1. Install two APC Smart-UPS in the bottom of the first rack.

Refer to the IBM Netfinity Rack Configurator program and *IBM 9306 Model 900 Netfinity Rack Planning and Installation Guide* for detailed instructions.

2. Install the first IBM Netfinity 7000 into the rack.

Refer to *Netfinity 7000 User's Handbook* for detailed instructions.

3. Install the keyboard tray into the rack.

Refer to the documentation that comes with the IBM Netfinity Rack Keyboard Tray for detailed instructions.

4. Install the second IBM Netfinity 7000 into the rack.

Refer to the *Netfinity 7000 User's Handbook* for detailed instructions.

5. Install the monitor compartment and monitor into the rack.

Refer to the *IBM Netfinity Rack Monitor Compartment Guide* for detailed instructions.

6. Install the IBM 9306 Model 900 Netfinity Rack Console Server Selector Switch into the rack.

Refer to the *IBM 9306 Model 900 Netfinity Rack Planning and Installation Guide* for detailed instructions.

---

## Step 3: Install the Hardware in Rack #2

---

**TIP:** It is good practice to install the APC Smart-UPS and the servers in the bottom of rack.

---

1. Install two APC Smart-UPS in the bottom of the second rack.

Refer to *IBM 9306 Model 900 Netfinity Rack Planning and Installation Guide* for detailed instructions.

2. Install the third IBM Netfinity 7000 into the rack.

Refer to the *Netfinity 7000 User's Handbook* for detailed instructions.

3. Install the fourth IBM Netfinity 7000 into the rack.  
Refer to *Netfinity 7000 User's Handbook* for detailed instructions.
4. Install the bracket and Symbios CM1000 Command Module into the rack.  
Refer to *IBM 9306 Model 900 Netfinity Rack Planning and Installation Guide* for detailed instructions.
5. Install the bracket and 8271-712 Ethernet LAN Switch into the rack.  
Refer to *IBM 9306 Model 900 Netfinity Rack Planning and Installation Guide* for detailed instruction.
6. Install a rack fixed shelf over the 8271-712 Ethernet Switch and place the two vixel hubs (side-by-side) on top of the shelf.

---

## Step 4: Install the Hardware in Rack #3

---

**TIP:** It is good practice to install the APC Smart-UPS and the servers in the bottom of rack.

---

1. Install two APC Smart-UPS in the bottom of the third rack.  
Refer to *IBM 9306 Model 900 Netfinity Rack Planning and Installation Guide* for detailed instructions.
2. Install the fifth IBM Netfinity 7000 into the rack.  
Refer to *IBM Netfinity 7000 User's Handbook* for detailed instructions.
3. Install the sixth IBM Netfinity 7000 into the rack.  
Refer to *IBM Netfinity 7000 User's Handbook* for detailed instructions.
4. Install the brackets and three Symbios DM2000 drive modules into the rack.  
Refer to *IBM 9306 Model 900 Netfinity Rack Planning and Installation Guide* for detailed instructions.

---

## Step 5: Install the Required Upgrades in the IBM Netfinity 7000 Server

1. Install the ServeRAID II adapter in slot 1 of each IBM Netfinity 7000.  
Refer to *IBM PC ServeRAID II Adapter Installation Instructions and User's Guide* for detailed instructions.
2. Cable the ServeRAID II adapter in each IBM Netfinity 7000.  
Refer to the installing adapters section in the *IBM Netfinity 7000 User's Handbook* for detailed instructions.
3. Install the Emulex host adapter in each IBM Netfinity 7000.  
Refer to the instructions that come with the Emulex host adapter for detailed instructions.
4. Install the EtherJet PCI adapter in each IBM Netfinity 7000.  
Refer to the instructions that come with the IBM 100/10 EtherJet PCI adapter for detailed instructions.

5. Install additional memory (a total of 1 GB) in each IBM Netfinity 7000.

Refer to the instructions that come with the memory for detailed instructions.

6. Install the microprocessors (a total of 4) in each IBM Netfinity 7000.

Refer to the instructions that come with the microprocessor for detailed instructions.

The IBM Netfinity Cluster Enabler hardware installation is now complete, continue with “Cabling the Hardware” on page 10.

---

## Cabling the Hardware

This section guides you through the tasks of cabling the hardware for connectivity for the IBM Netfinity Cluster Enabler Solution.

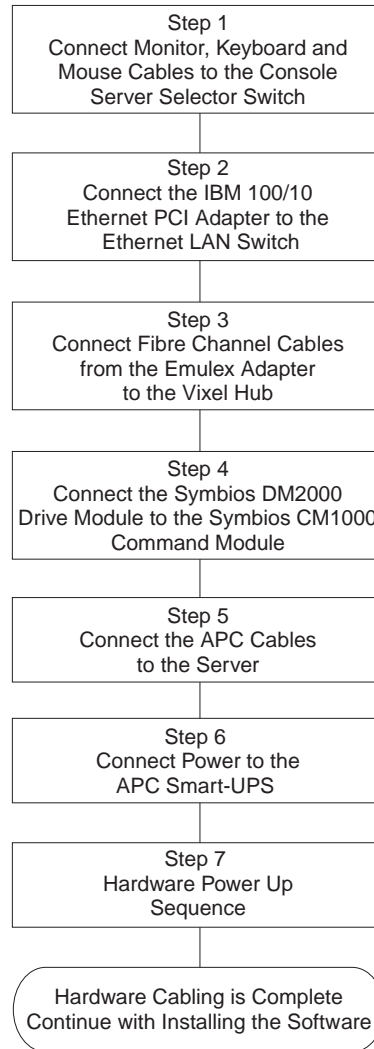

---

## Cable Management and Labeling for Solutions Utilizing Racks

Cable management and labeling is increasingly important. Cable management and labeling needs have expanded from the traditional labeling of network connections to labeling most cable connections between your servers, disk subsystems, multiple network connections, power and video subsystems. Examples of solutions include fibre channel configurations, server cluster solutions, multiple unique solutions located in the same rack or across multiple racks, and solutions where components might not be physically located in the same room, building, or site.

The necessity for detailed cable management and labeling is due to the complexity of today's configurations and the potential distances between solution components. Benefits from more detailed cable management and labeling include:

- ease of installation
- ongoing solutions and systems management
- increased serviceability

Be sure to label your cables for guidance, refer to the World Wide Web currently at:

<http://www.pc.ibm.com/us/support>

for detailed instructions on how to label your IBM Netfinity Cluster Enabler solution.

Then, return here and continue with "Step 1: Connect the Monitor, Keyboard, and Mouse Cables to the Console Server Selector Switch" on page 12.

## Step 1: Connect the Monitor, Keyboard, and Mouse Cables to the Console Server Selector Switch

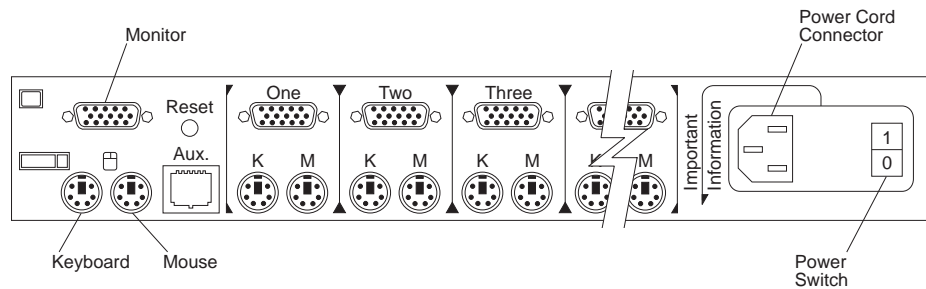

1. Connect the monitor cable to the selector switch monitor connector.
2. Connect the keyboard cable to the selector switch keyboard connector.
3. Connect the mouse cable to the selector switch mouse connector.
4. Determine the server you want to connect to port 1.
5. Looking below the label marked **One**, connect the server keyboard and mouse ports to the selector switch connectors marked **K** and **M** respectively. Connect the server monitor port to the selector switch 15-pin VGA connector.
6. Connect the other end of the monitor, keyboard and mouse cables to the server. Refer to following figures (depending upon your configuration) when completing this step.
7. Repeat step 5 and step 6 and connect to the corresponding connectors until all of the remaining cables are connected to the selector switch and all of the servers. Refer to the following figures (depending upon your configuration) when completing this step.

Refer to *IBM 9306 Model 900 Netfinity Rack Console Server Selector Switch User's Guide and Installation Instructions* for information on how to use the selector switch.

Figure 2 shows a two-server (node) configuration.

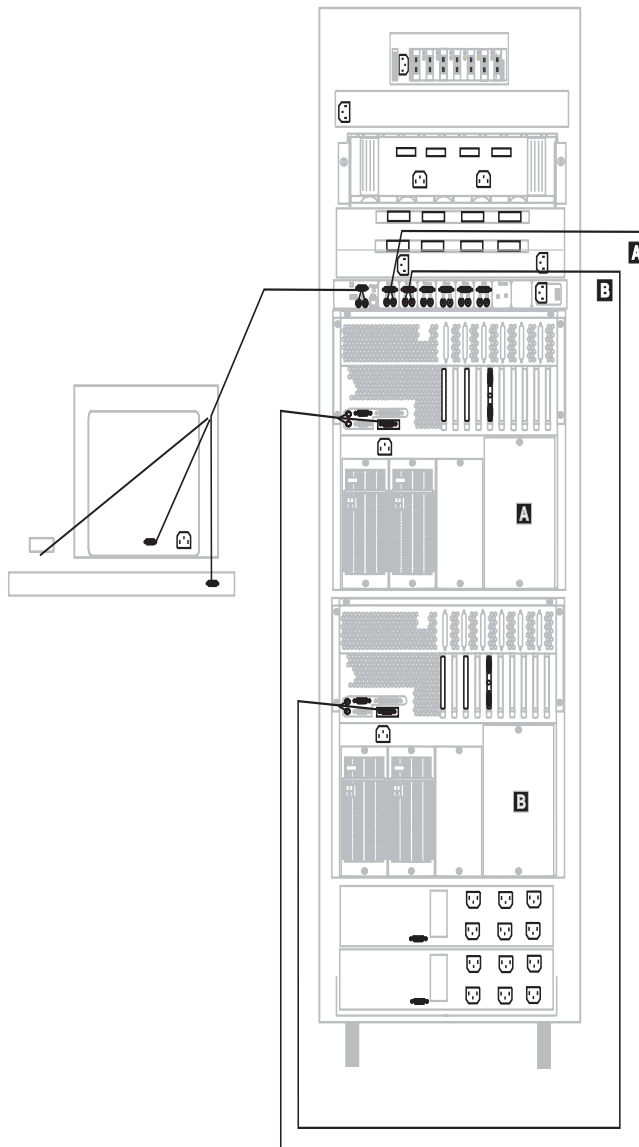

Figure 2. Connecting the Monitor, Keyboard, and Mouse Cables to two Netfinity 7000 Server - Rear View

**Note:** The letters on each server represent the individual servers in the cluster.

Figure 3 shows a four-server (node) configuration.

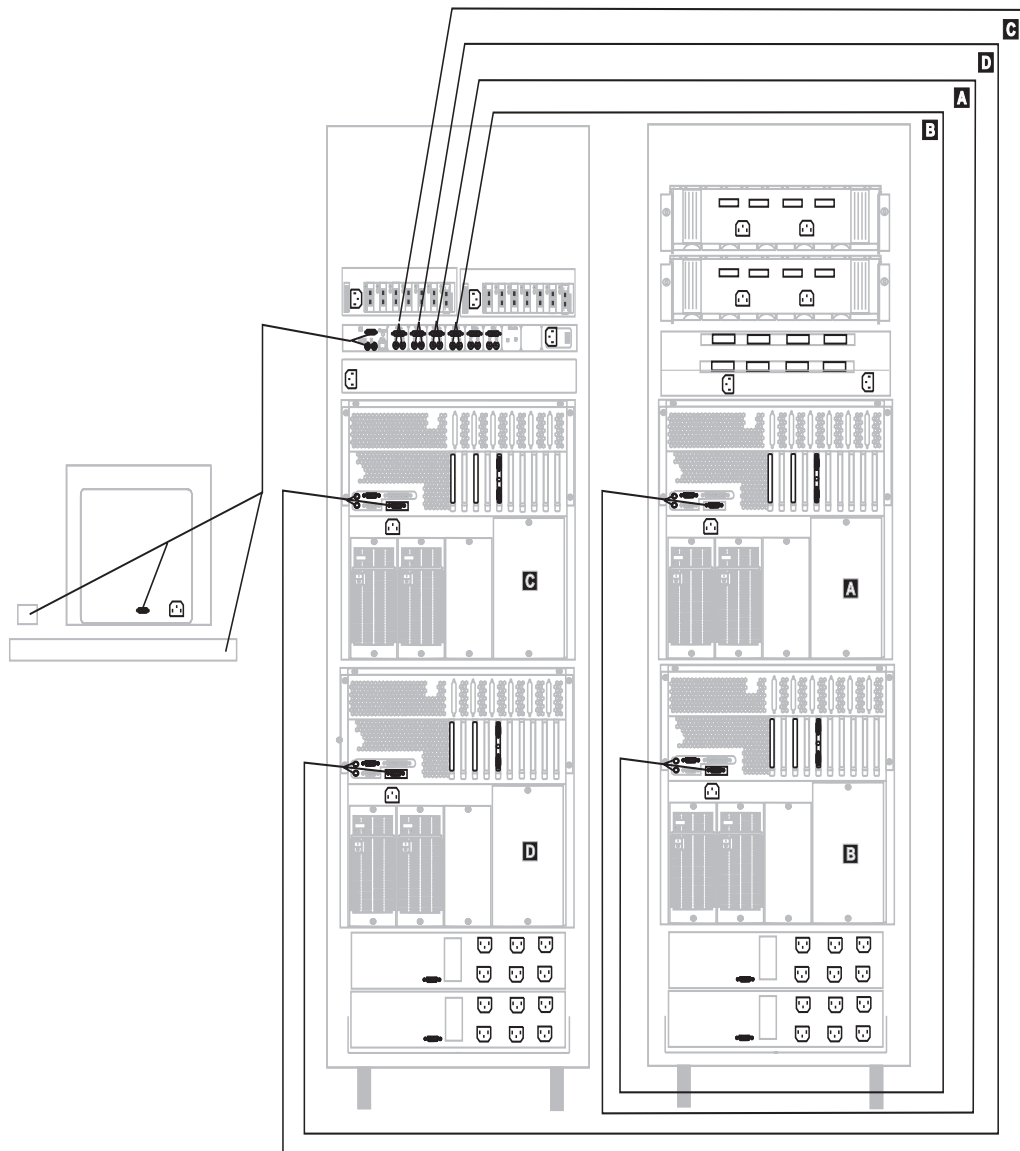

Figure 3. Connecting the Monitor, Keyboard, and Mouse Cables to four Netfinity 7000 Server - Rear View

**Note:** The letters on each server represent the individual servers in the cluster.



Figure 4 shows a six-server (node) configuration.

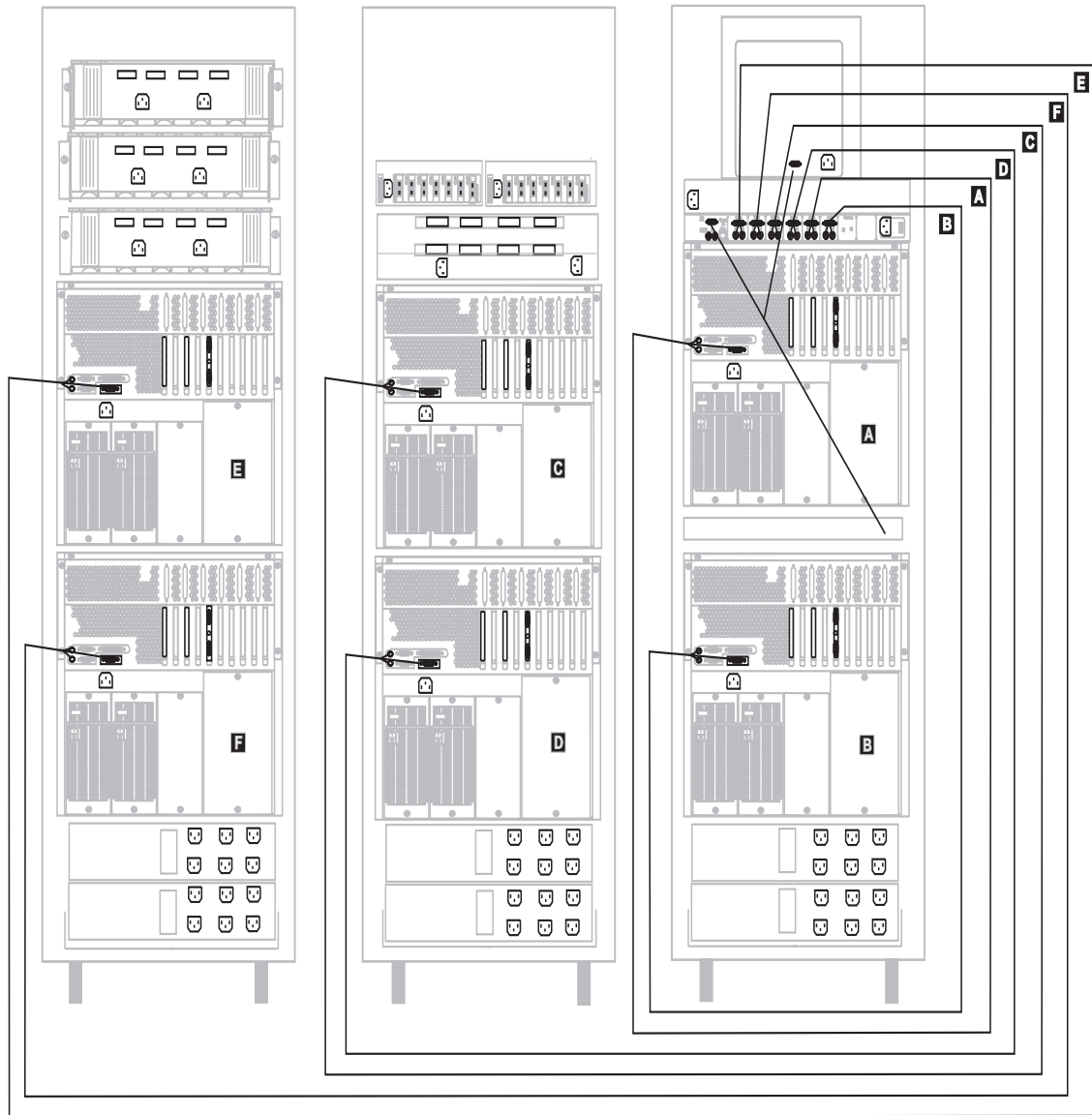

Figure 4. Connecting the Monitor, Keyboard, and Mouse Cables to six Netfinity 7000 Server - Rear View

**Note:** The letters on each server represent the individual servers in the cluster.

---

## **Step 2: Connect the IBM 100/10 EtherJet PCI Adapter to the 8271-712 Ethernet LAN Switch**

Refer to the following figures (depending upon your configuration) when completing these steps.

1. Connect one end of the Category-5 Ethernet cable to the IBM 100/10 EtherJet PCI Adapter.
2. Connect the other end of the Category-5 Ethernet cable to the front of the 8271-712 Ethernet LAN Switch.

Figure 5 shows a two-server (node) configuration.

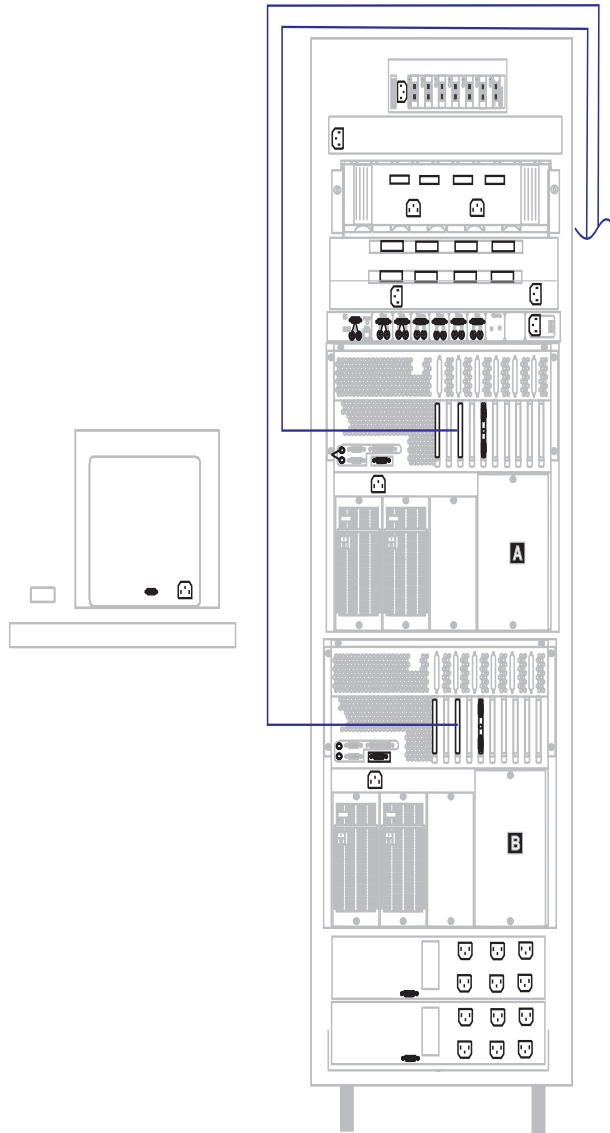

Figure 5. Connecting the IBM 100/10 EtherJet PCI Adapter Part I - Rear View

**Note:** The letters on each server represent the individual servers in the cluster.

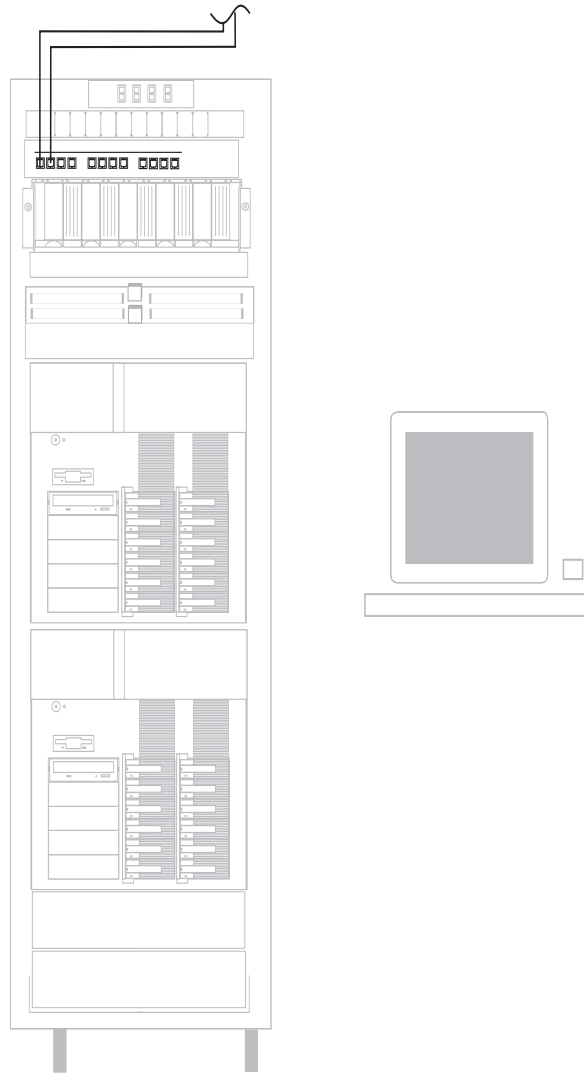

Figure 6. Connecting the IBM 100/10 EtherJet PCI Adapter Part II - Front View

**Note:** The letters on each server represent the individual servers in the cluster.

Figure 7 shows a four-server (node) configuration.

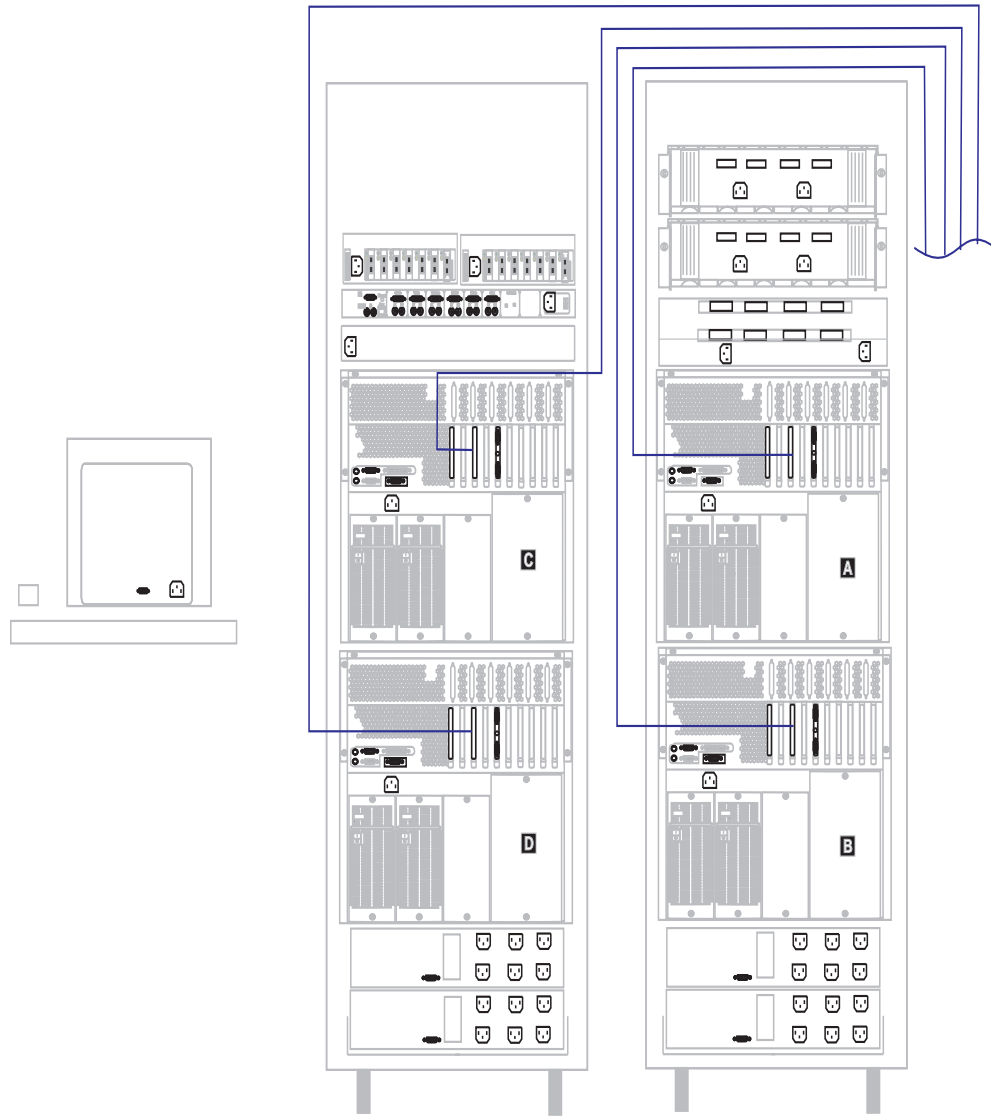

Figure 7. Connecting the IBM 100/10 EtherJet PCI Adapter Part I - Rear View

**Note:** The letters on each server represent the individual servers in the cluster.

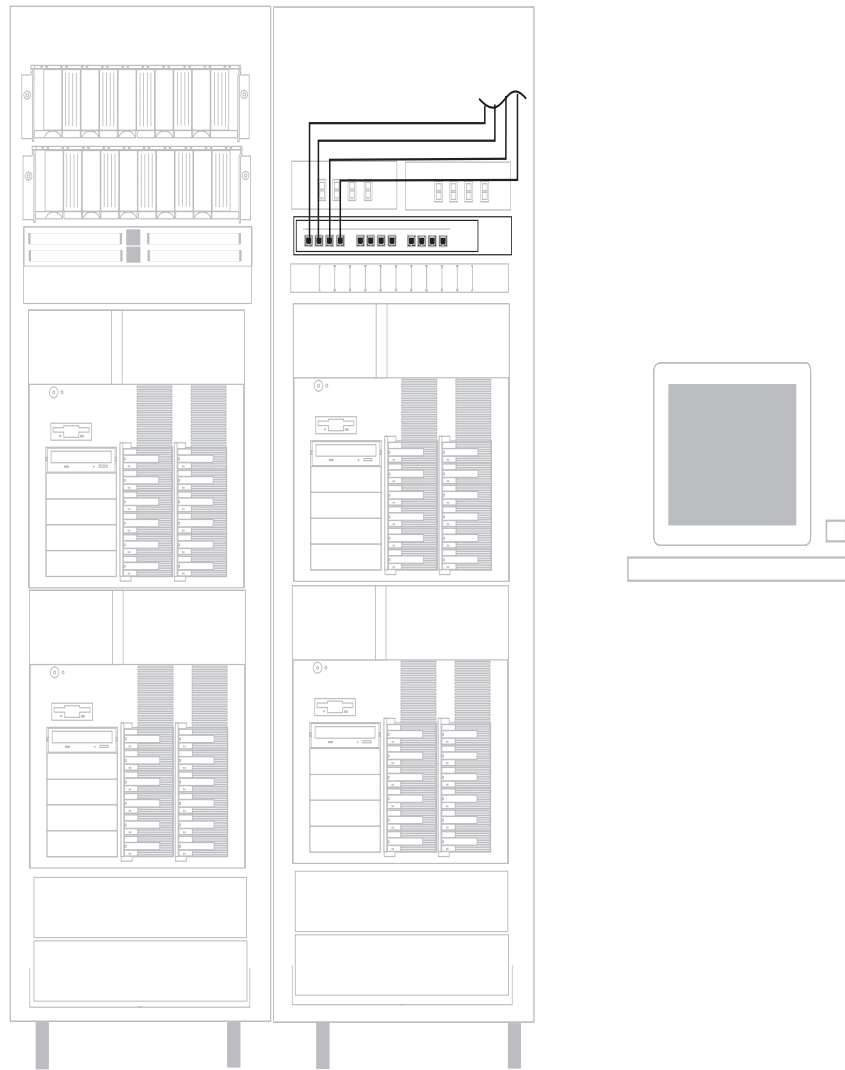

Figure 8. Connecting the IBM 100/10 EtherJet PCI Adapter Part II - Front View

**Note:** The letters on each server represent the individual servers in the cluster.

Figure 9 shows a six-server (node) configuration.

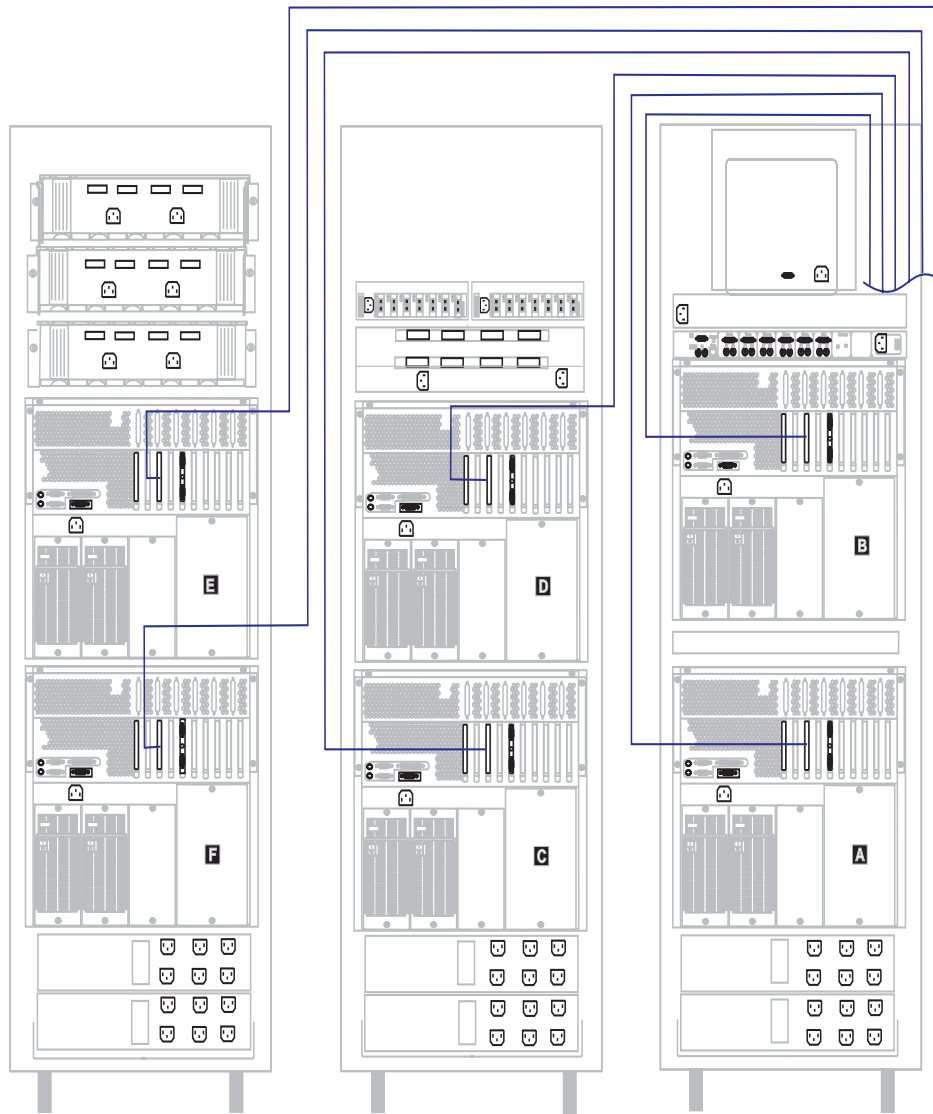

Figure 9. Connecting the IBM 100/10 EtherJet PCI Adapter Part I - Rear View

**Note:** The letters on each server represent the individual servers in the cluster.



Figure 10. Connecting the IBM 100/10 EtherJet PCI Adapter Part II - Front View

**Note:** The letters on each server represent the individual servers in the cluster.



---

## Step 3: Connect the Fibre Channel Cables from the Emulex Host Adapter to the Vixel Hubs

Refer to the following figures (depending upon your configuration) when completing these steps.

**Note:** The ports on the back of vixel hub are labeled 0 through 6 which are not port position dependent.

1. Connect one end of the first fibre channel cable to the Emulex fibre channel host adapter that is installed in the server.

**Note:** Do not bend, crimp, or coil the fibre channel cables smaller than a 4-inch diameter.

2. Connect the other end of the Emulex fibre channel cable to one of the ports on the back of the vixel hub.
3. Repeat steps 1 through 2 for each server.
4. Connect a second fibre channel cable to the 3702 RAID controller (within the CM1000) to the front port on the Symbios CM1000 Command Module. See the **X** in the following figures for the front port connection on the Symbios CM1000 Command Module. Refer to the Symbios CM1000 publication for specific instructions when connecting the cable to the front connector.
5. Connect the other end of the fibre channel cable to one of the ports on the back of the vixel hub.

Figure 11 shows a two-server (node) configuration.

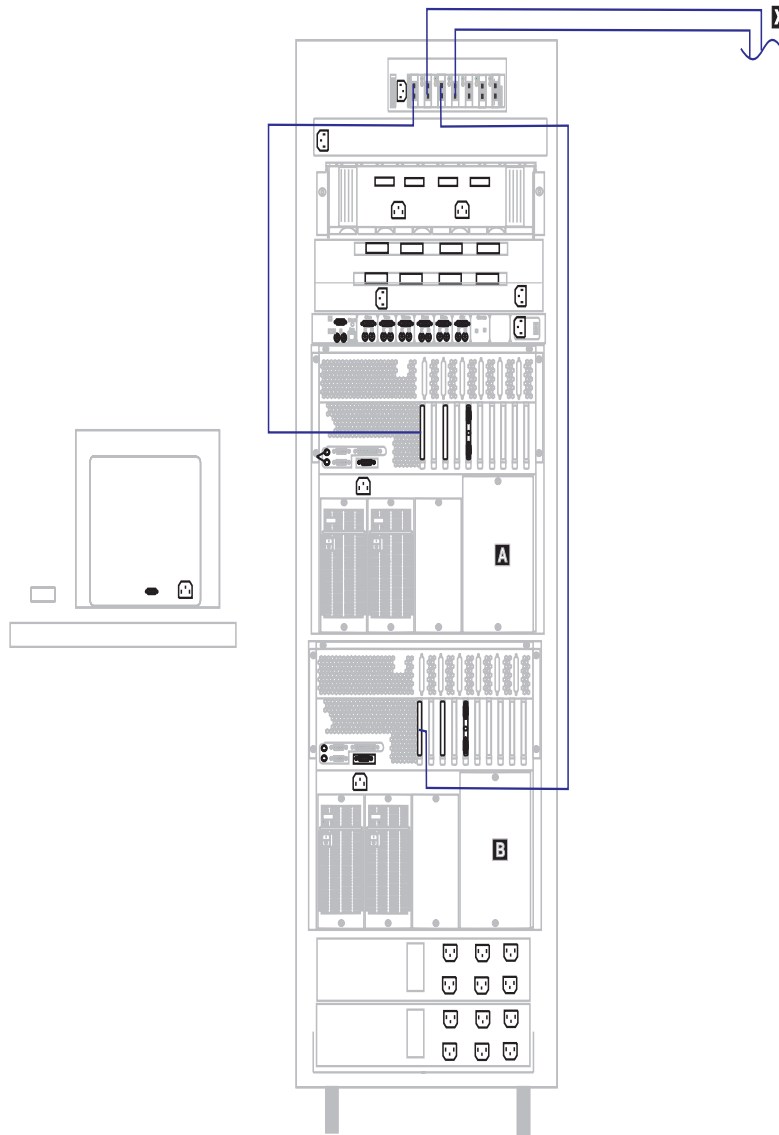

Figure 11. Connect the Fibre Channel Cables Part I - Rear View

**Note:** The letters on each server represent the individual servers in the cluster.

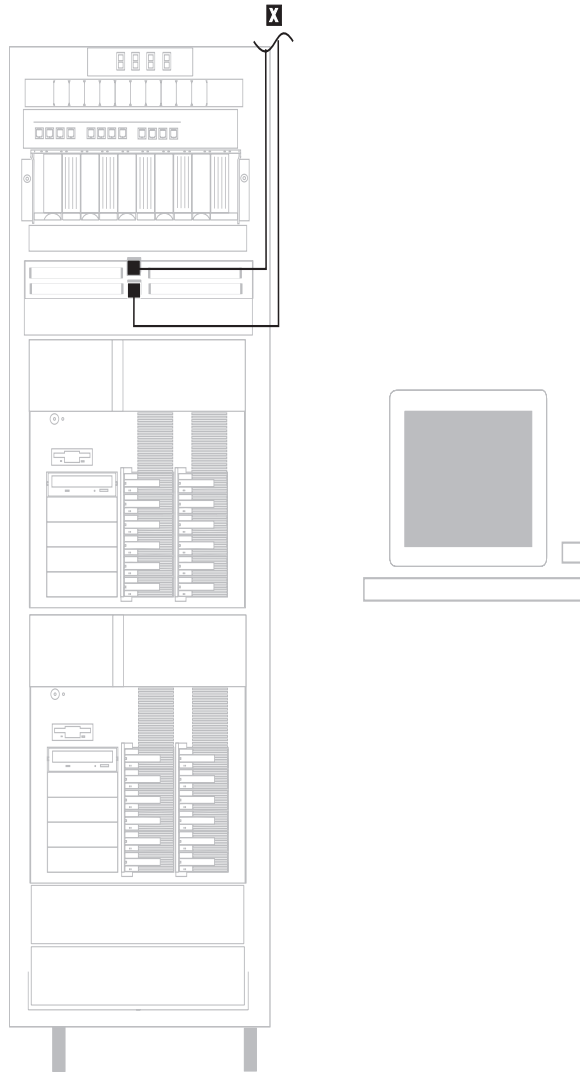

Figure 12. Connect the Fibre Channel Cables Part II - Front View

**Note:** The letters on each server represent the individual servers in the cluster.

Figure 13 shows a four-server (node) configuration.

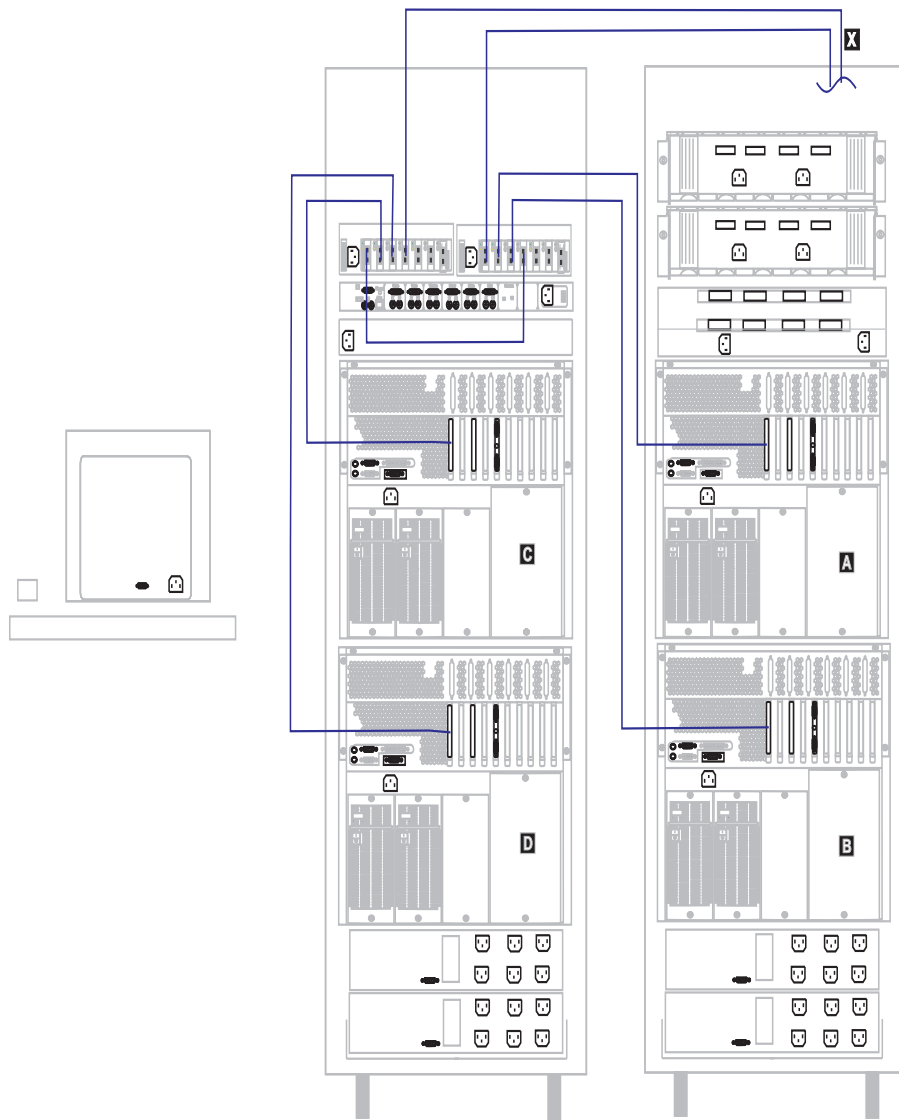

Figure 13. Connect the Fibre Channel Cables Part I - Rear View

**Note:** The letters on each server represent the individual servers in the cluster.

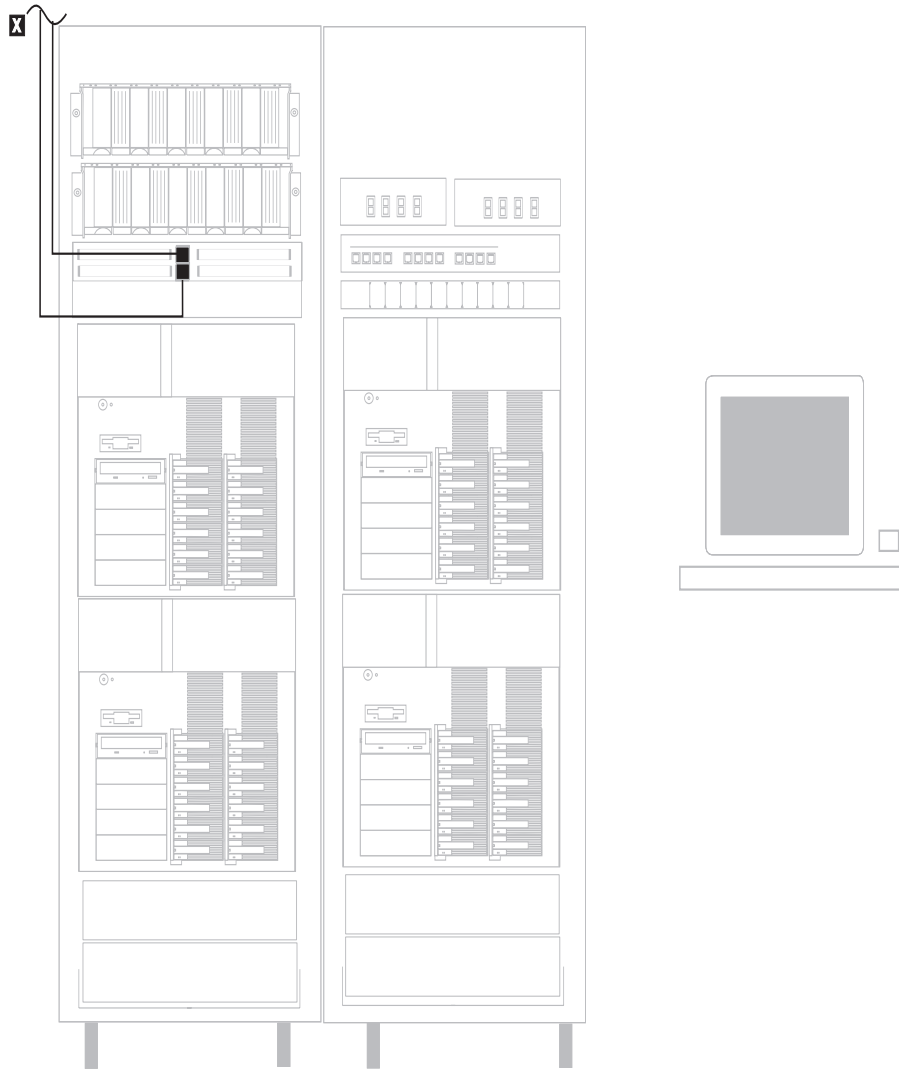

Figure 14. Connect the Fibre Channel Cables Part II - Front View

**Note:** The letters on each server represent the individual servers in the cluster.

Figure 15 shows a six-server (node) configuration.

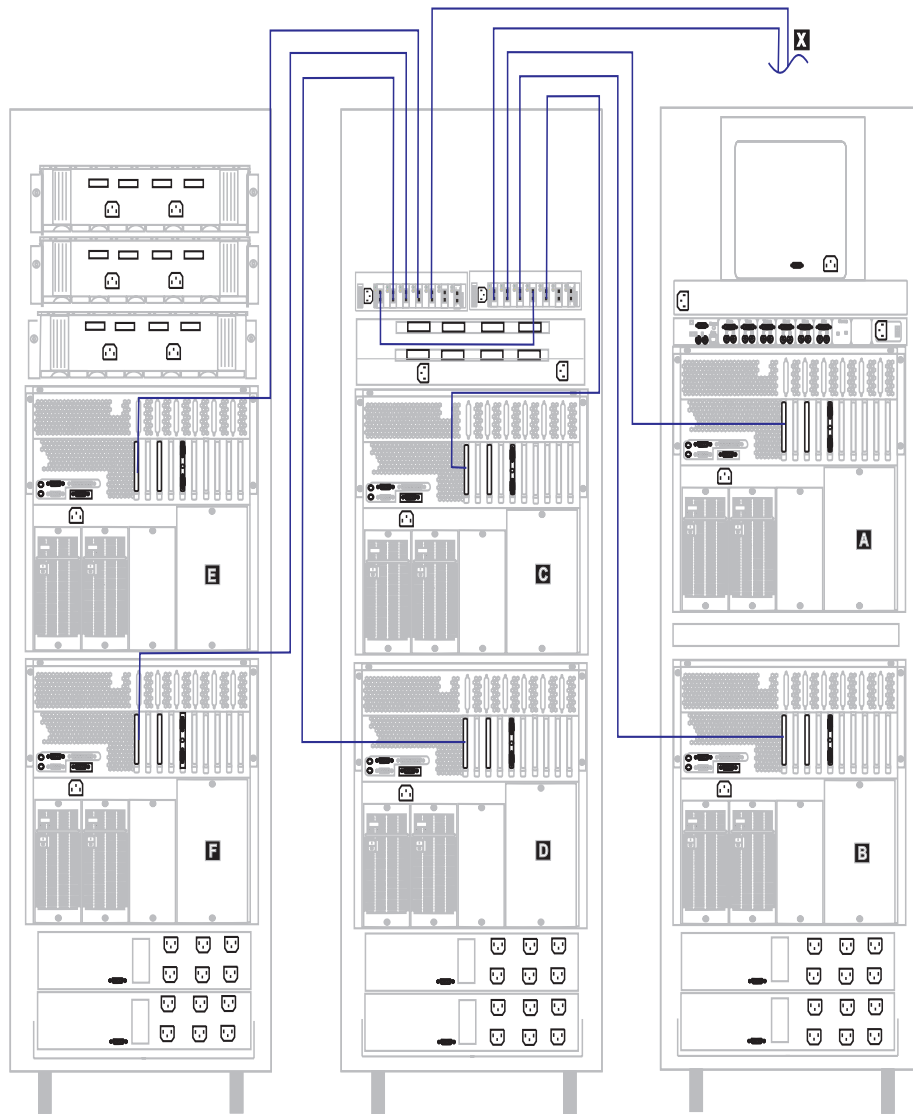

Figure 15. Connect the Fibre Channel Cables Part I - Rear View

**Note:** The letters on each server represent the individual servers in the cluster.

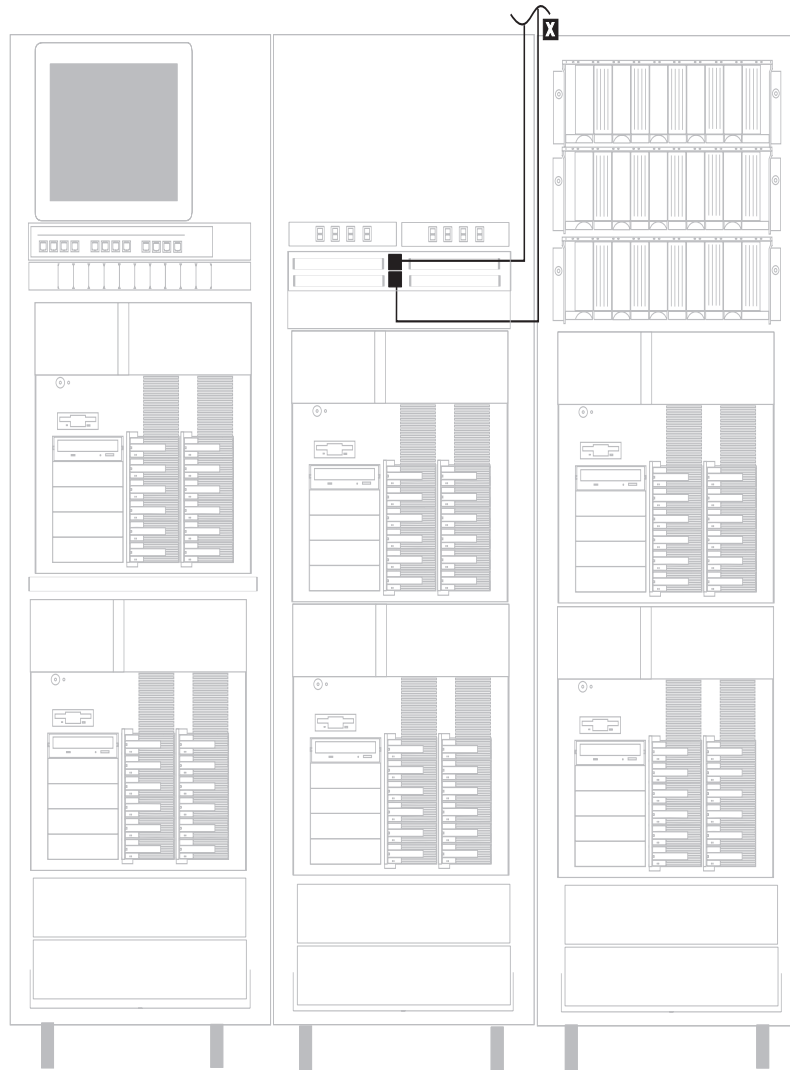

Figure 16. Connect the Fibre Channel Cables Part II - Front View

**Note:** The letters on each server represent the individual servers in the cluster.

---

## Step 4: Connect the Symbios DM2000 Drive Module to the Symbios CM1000 Command Module

Depending upon the number of Symbios DM2000 Drive Modules you use in your configuration, the cabling may be different. Refer to the *MetaStor Drive Module System Guide* for detailed cabling instructions recommended for your configuration.

---

## Step 5: Connect the APC Cables to the Server

Refer to the following figures (depending upon your configuration) when completing these steps.

1. Connect the APC cable (9-pin serial cable) to the serial port on the back of each server.
2. Connect the other end of the APC cable (9-pin serial cable) to one of the serial ports on the back of each APC Smart-UPS power supply.

**Note:** The power cord and the serial cable should be connected to the same APC Smart-UPS power supply.

3. Repeat the above steps for each server.



Figure 17 shows a two-server (node) configuration.

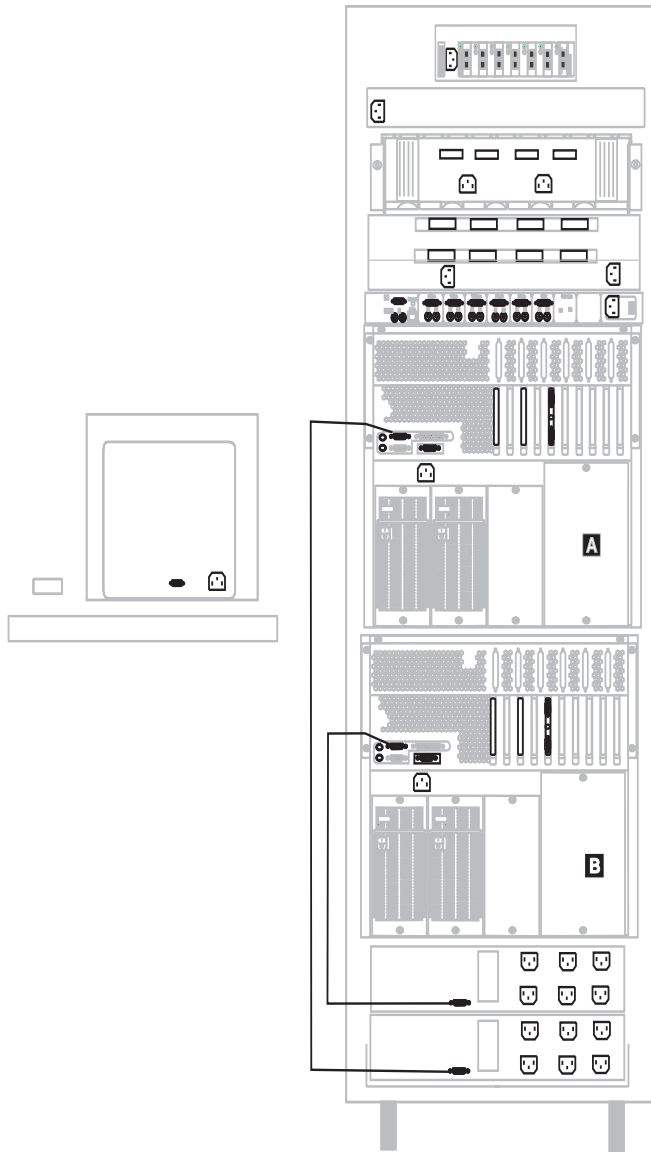

Figure 17. Connecting the APC Mounting Cables to two Netfinity 7000 Server - Rear View

**Note:** The letters on each server represent the individual servers in the cluster.

Figure 18 shows a four-server (node) configuration.

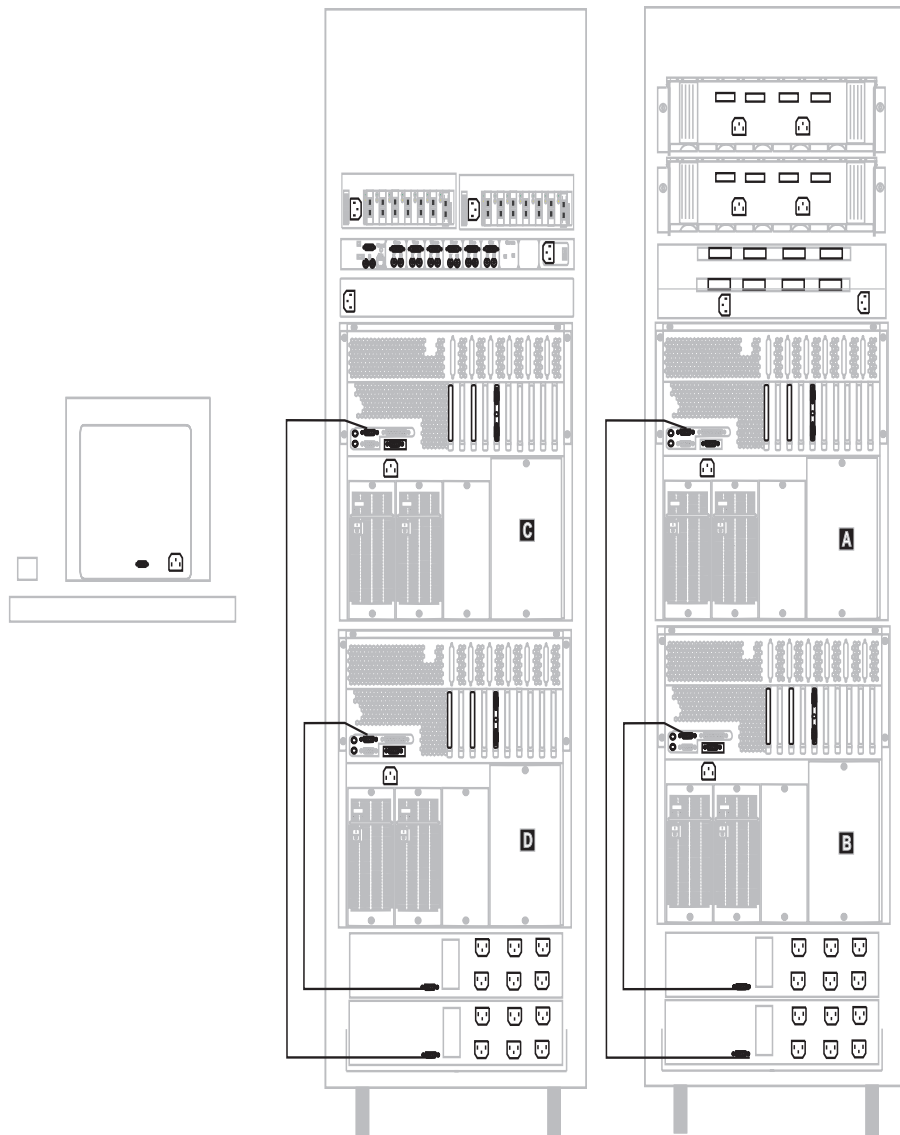

Figure 18. Connecting the APC Mounting Cables to four Netfinity 7000 Server - Rear View

**Note:** The letters on each server represent the individual servers in the cluster.

Figure 19 shows a six-server (node) configuration.

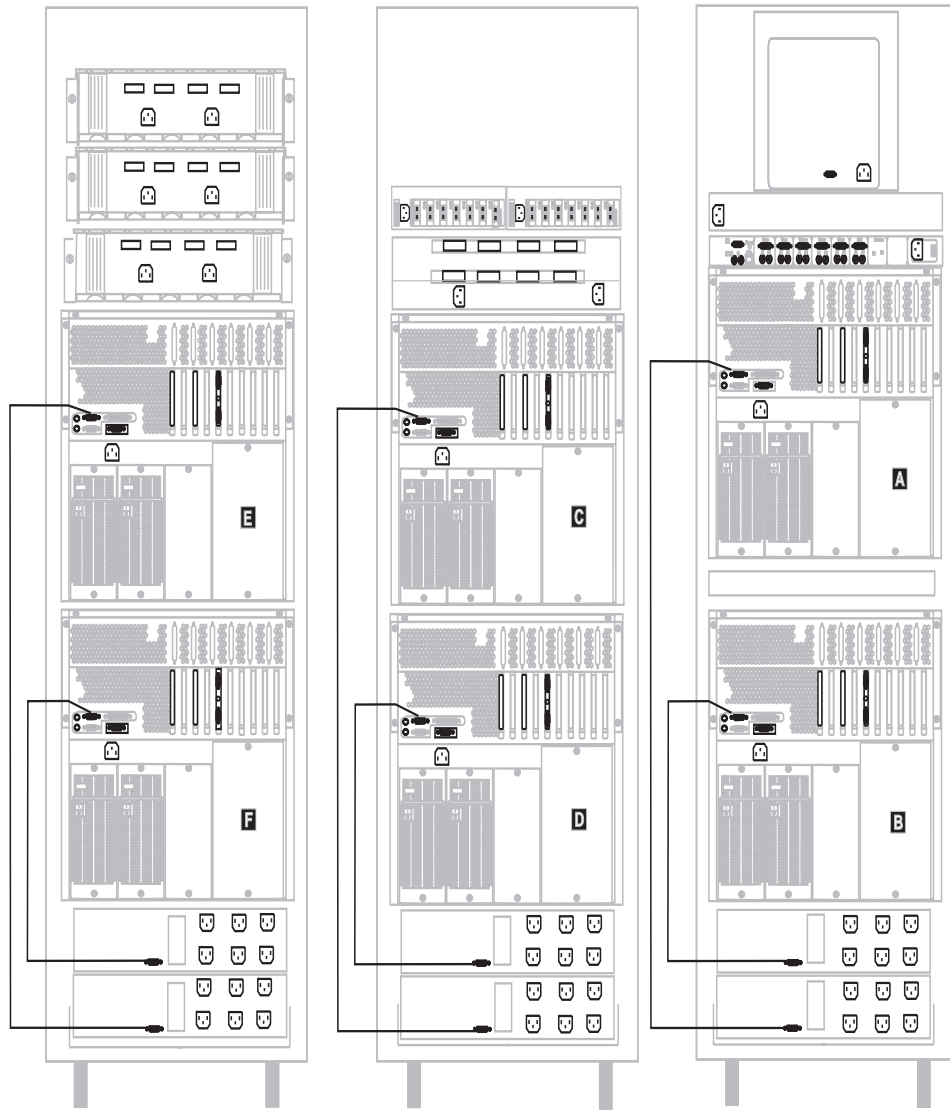

Figure 19. Connecting the APC Mounting Cables to six Netfinity 7000 Server - Rear View

**Note:** The letters on each server represent the individual servers in the cluster.

---

## Step 6: Connect Power to the APC Smart-UPS Power Supply

Refer to the following figures (depending upon your configuration) when completing this step.

Connect the power cords for the IBM Console Selector Switch, IBM 8271-712 Ethernet LAN Switch, Symbios CM1000 Command Module, Symbios DM2000 Drive Module, and the display monitor among the available APC Smart-UPS power supply.

---

**TIP:** To ensure high availability between the clusters, do the following:

1. Connect the power cables from each server to a different UPS.
  2. Connect the power cords from the SYM 1000 to different UPS.
  3. Ensure that you distribute the power cords among the available UPS.
- 

**Notes:**

1. Refer to the APC Smart-UPS documentation for power requirements.
2. Do not power up the servers at this time.

Figure 20 shows a two-server (node) configuration.

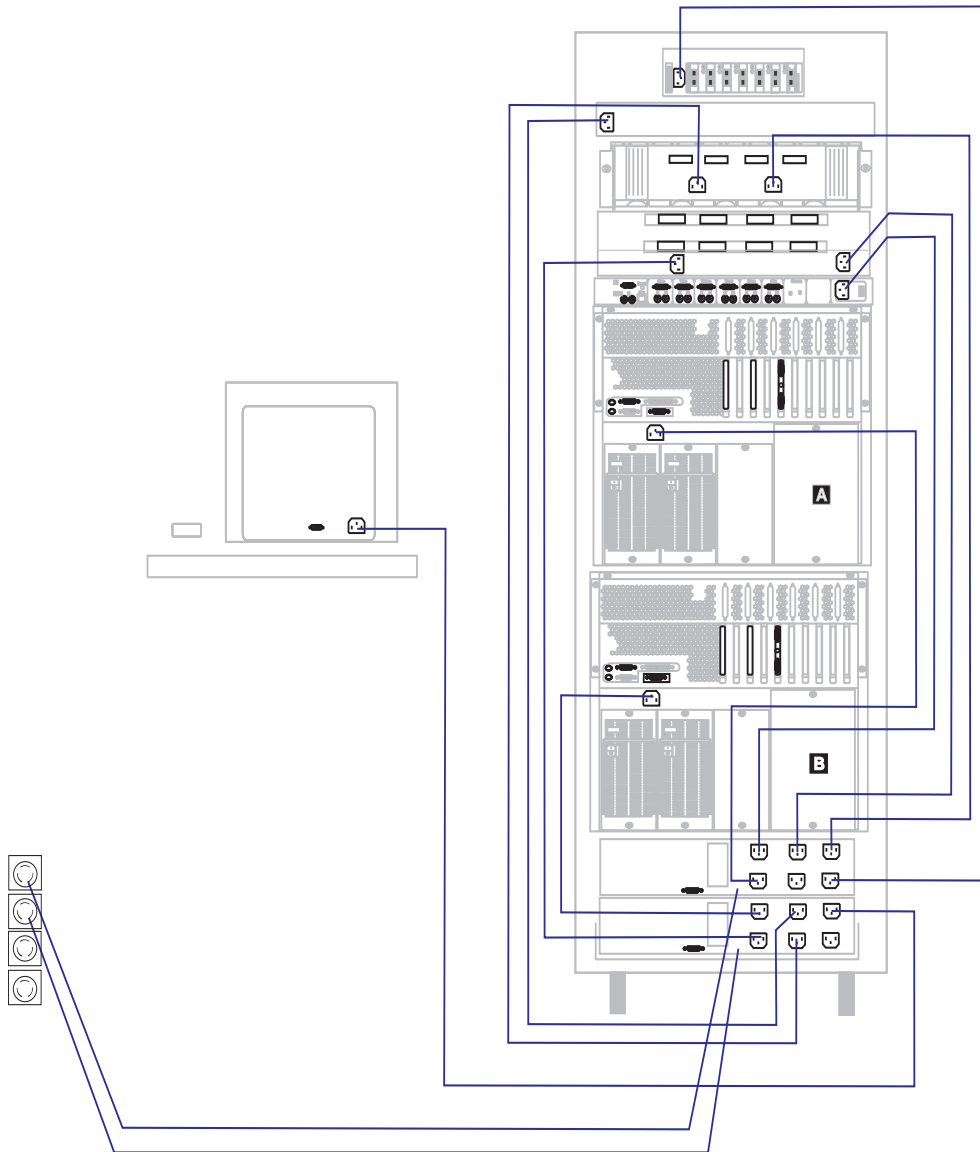

Figure 20. Connecting Power Cords to the APC Smart-UPS Power Supply - Rear View

Figure 21 shows a four-server (node) configuration.

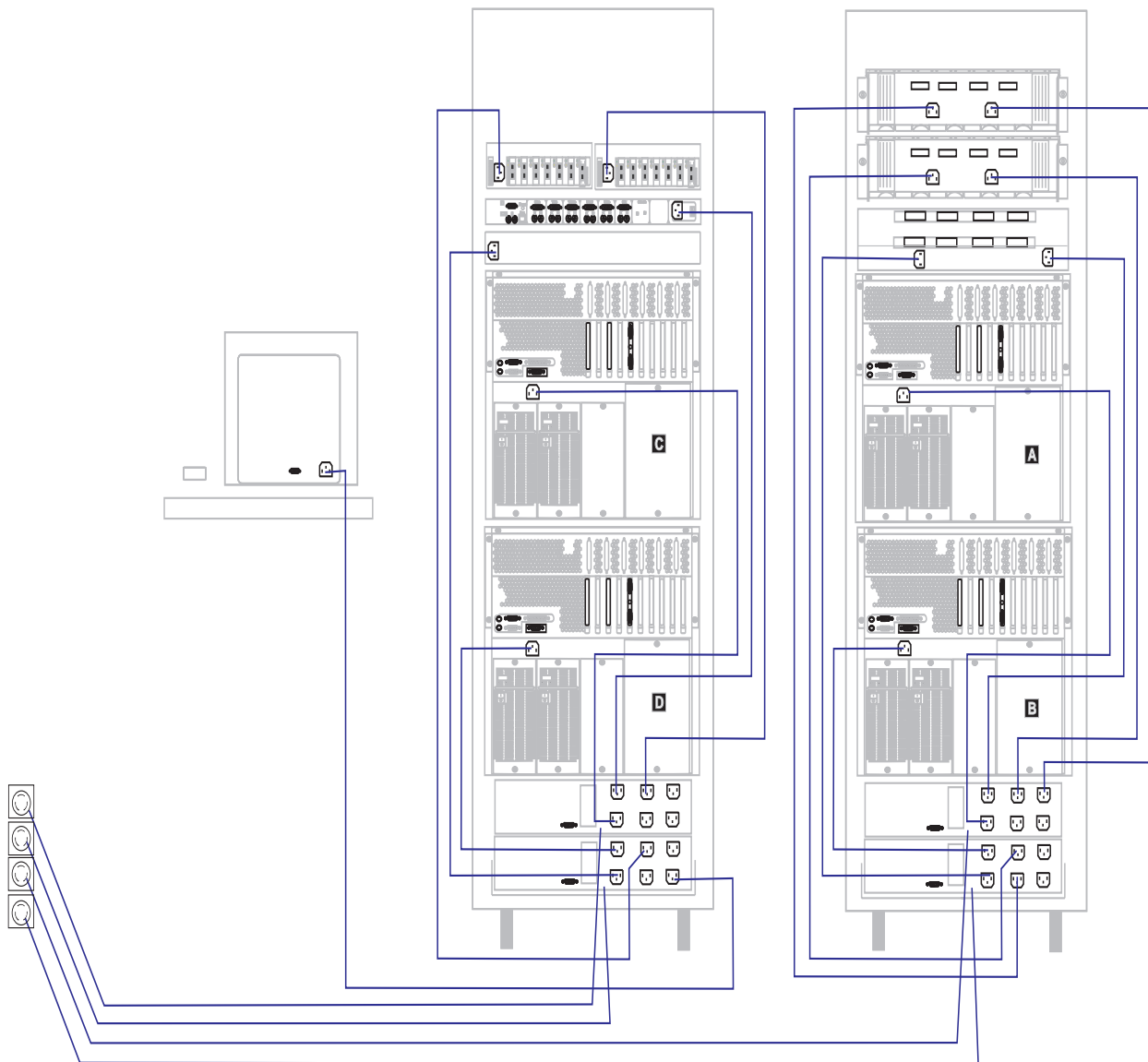

Figure 21. Connecting Power Cords to the APC Smart-UPS Power Supply - Rear View

**Note:** The letters on each server represent the individual servers in the cluster.

Figure 22 shows a six-server (node) configuration.

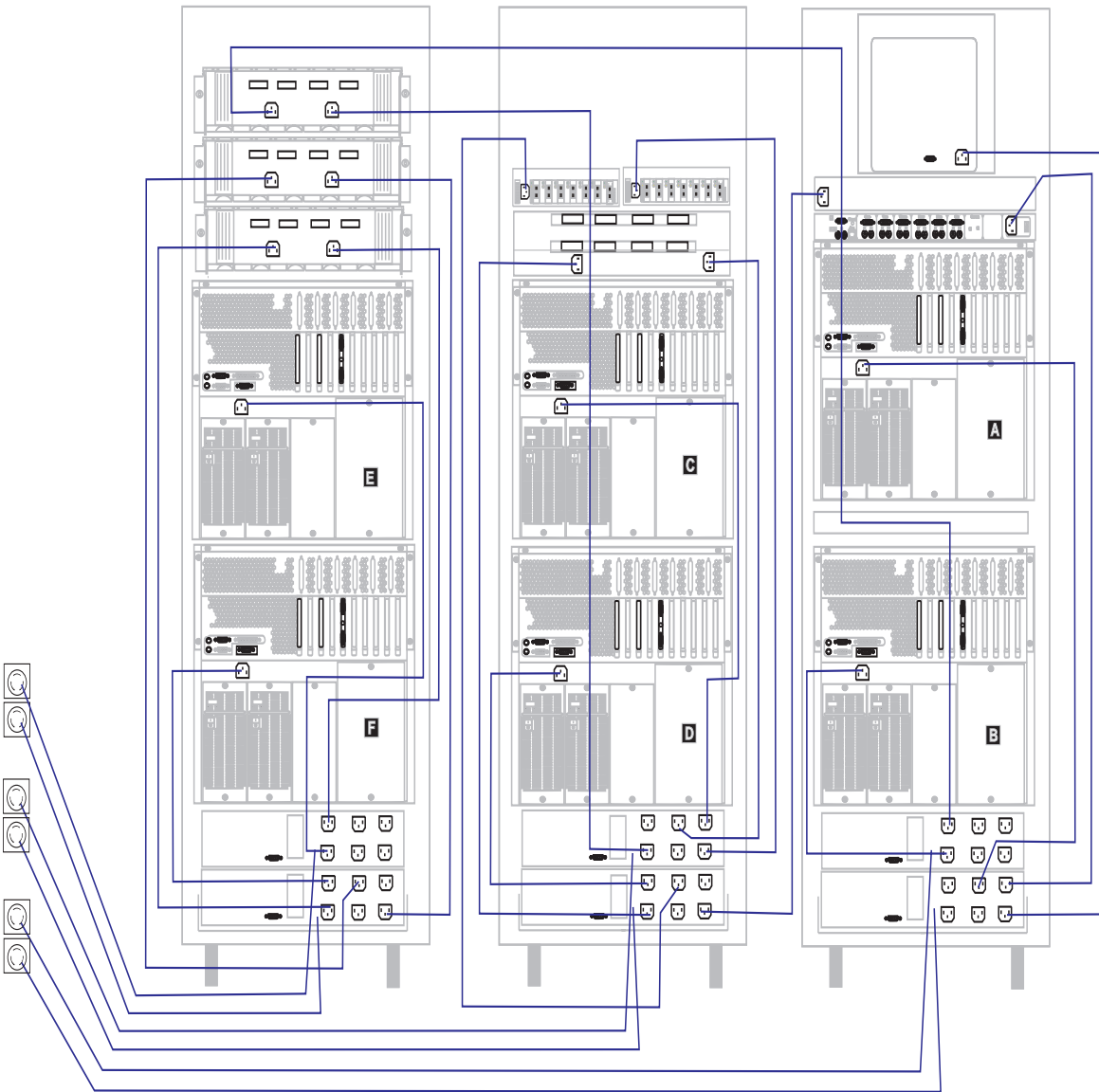

Figure 22. Connecting Power Cords to the APC Smart-UPS Power Supply - Rear View

**Note:** The letters on each server represent the individual servers in the cluster.

---

## Step 7: Hardware Power Up Sequence

1. Ensure that the APC Smart UPS Power Supply have charged for 2.5 hours before use. Refer to the APC Smart-UPS documentation for more information.
2. Power on the APC Smart-UPS Power Supply by pushing the test button. Refer to the APC Smart-UPS documentation for more information.
3. Power on the Ethernet Switch, Vixel Hubs, and Console Selector Switch.
4. Power on the Symbios CM1000 Command Modules and Symbios DM2000 Drive Module simultaneously.

**Note:** Ensure that the Symbios CM1000 Command Modules and the Symbios DM2000 Drive Module have powered on successfully (wait approximately one minute after the disk appears to be idle before continuing to the next step).

5. Power on one server at a time and wait until it is fully powered on before powering on the next server.

---

**TIP:** Starting or stopping the servers (nodes) in rapid succession is not recommended. Wait a minimum of 30 seconds between starting or stopping the servers (nodes) in a cluster.

---

The IBM Netfinity Cluster Enabler hardware installation is now complete; continue with “Cable Management and Labeling for Solutions Utilizing Racks” on page 11.



---

## Installing the Software

This section guides you through the tasks for installing the software.

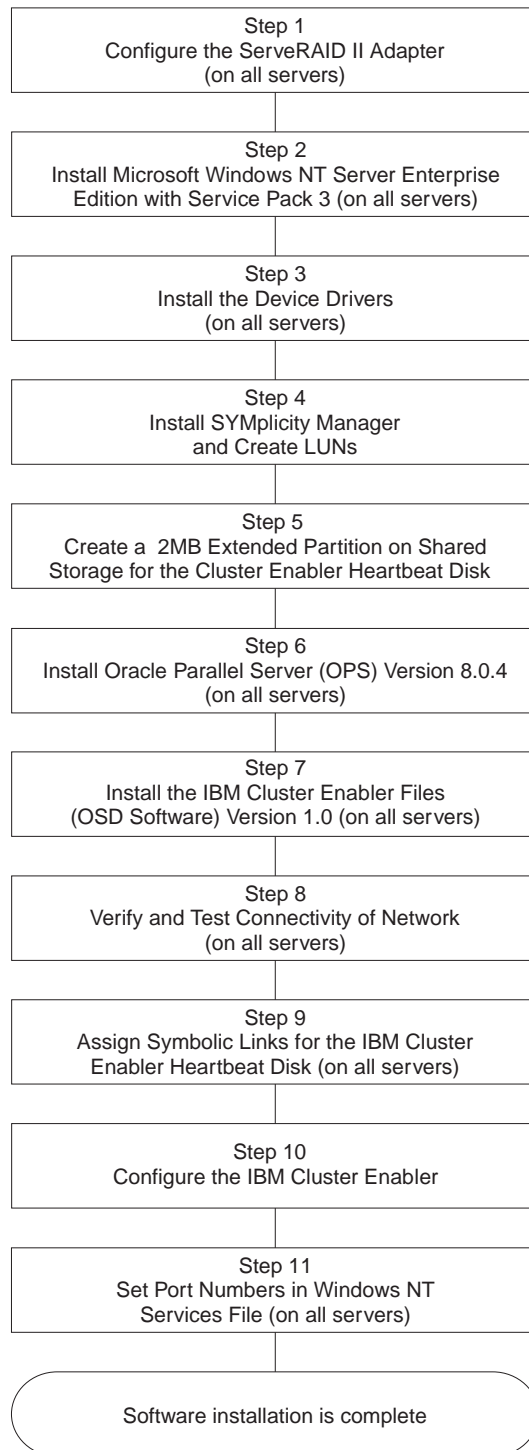

---

## Step 1: Configure the ServeRAID II Adapter

Oracle Parallel Server (OPS) requires that the operating system and the Oracle program files reside on non-shared storage on each server (node). The IBM ServeRAID II adapter provides the hardware RAID redundancy for this non-shared storage startup device.

1. Create an array and a logical drive in each server, using the ServeRAID configuration utility. Refer to the *ServeRAID Adapter Installation Instructions and User's Guide* that comes with the adapter for detailed installation instructions.
2. Continue to "Step 2: Install Microsoft Windows NT Server Enterprise Edition Service Pack 3."

---

## Step 2: Install Microsoft Windows NT Server Enterprise Edition Service Pack 3

1. Install Microsoft Windows NT Server Enterprise Edition Service Pack 3 on each server. Refer to the documentation that comes with Windows NT Version 4.0 for detailed installation instructions.
2. Continue to "Step 3: Install the Emulex Device Drivers."

---

## Step 3: Install the Emulex Device Drivers

1. Install the Emulex device drivers in each server. Refer to the documentation that comes with the Emulex device drivers for detailed installation instructions.

**Note:** The latest Emulex device drivers and firmware downloadable images are currently at:

`ftp://ftp.emulex.com/pub/fibre`

on the World Wide Web.

2. Shut down and restart the server.
3. Continue to "Step 4: Install SYMplicity Storage Manager."

---

## Step 4: Install SYMplicity Storage Manager

SYMplicity Storage Manager configures, monitors, and controls the state of the RAID controllers and disk arrays. It also provides RAID controller failover; therefore, it is necessary to install SYMplicity Storage Manager on each server (node).

---

**TIP:** IBM Cluster Enabler only supports active/active mode for the RAID controller. Refer to the SYMplicity Storage Manager documentation for detailed information on how to set up active/active mode.

---

1. Install SYMplicity software on each server (node).
2. Plan and configure for your logical unit numbers (LUNs). Refer to the Symbios and Oracle Parallel Server documentation for more information.

3. Go to the desired server and create LUNs only once for all shared storage on each server.
4. Continue to “Step 5. Create an Extended Partition for the IBM Cluster Enabler Heartbeat Disk.”

---

## Step 5. Create an Extended Partition for the IBM Cluster Enabler Heartbeat Disk

The IBM Netfinity Cluster Enabler software uses a special logical partition on a shared disk for communication in the event of a failure. This logical partition, referred to as the *heartbeat disk*, allows all servers to determine the correct configuration for continued operation. Therefore, the IBM Netfinity Cluster Enabler heartbeat disk must be configured as a logical drive on an extended disk partition.

1. Create a 2 MB logical drive on an extended disk partition, on the shared storage, for the IBM Netfinity Cluster Enabler heartbeat. Refer to the "Performing the Pre-Installation Tasks" section in the *Oracle Parallel Server Getting Started* documentation for detailed instructions.
2. Continue with “Step 6: Install Oracle Parallel Server (OPS).”

---

## Step 6: Install Oracle Parallel Server (OPS)

Install the Oracle Parallel Server (OPS). Refer to *Oracle Parallel Server Getting Started for Windows NT Handbook* for detailed installation instructions.

---

## Step 7: Install the IBM Netfinity Cluster Enabler (OSD Software)

You will need to install the IBM Netfinity Cluster Enabler Operating System Dependent (OSD) software on each server to provide low level cluster functions for the Oracle Parallel Server. To install the IBM Netfinity Cluster Enabler (OSD), do the following:

1. Download a copy of the IBM Netfinity Cluster Enabler software from the World Wide Web currently at:

<http://www.pc.ibm.com/us/netfinity/clustering.html>

**Note:** The above address will link you to the down loadable file.

2. Add the down loadable file to your local server; then, run SETUP.
3. Click on **Start** and then click **Run**.

4. In the **Open** box, type **SETUP.EXE** and then click on **OK**.

A Welcome screen appears.

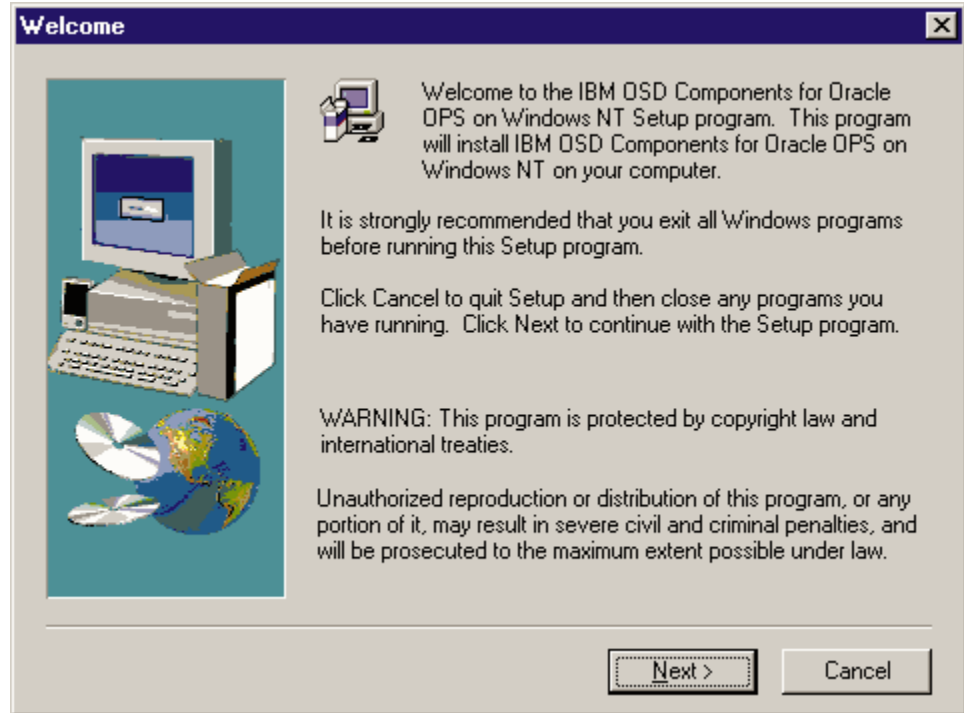

5. Click the **Next** button.

You will see a pop-up window warning that the IBM Core Cluster Service must be stopped.

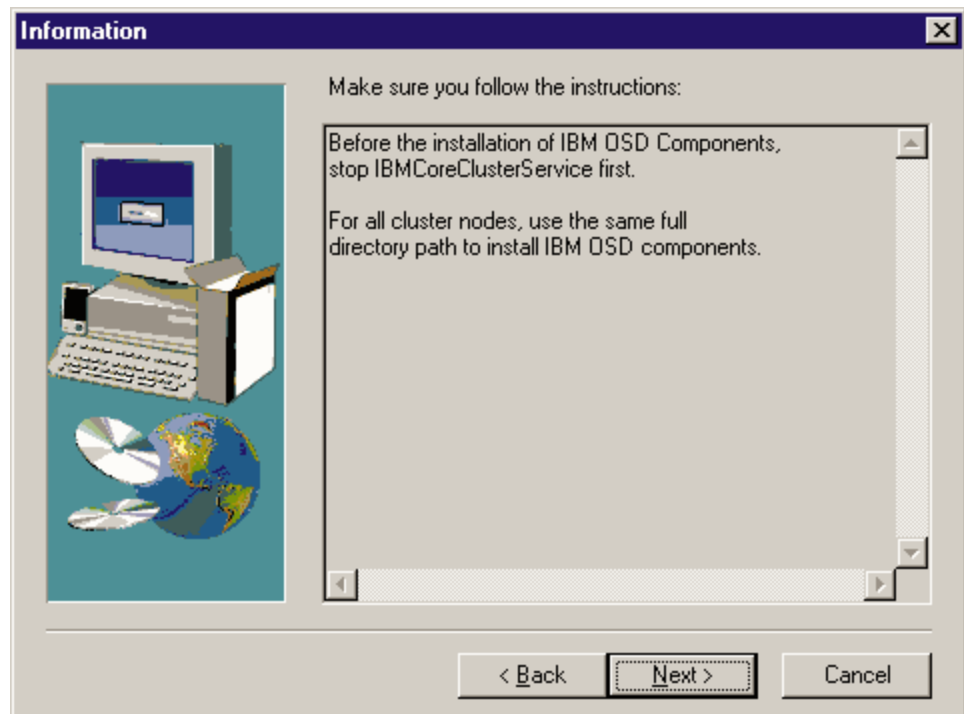

If you are installing the IBM Netfinity Cluster Enabler software for the first time, continue with step 6 on page 43.

If you are not installing the IBM Netfinity Cluster Enabler software for the first time, continue with step-A below.

- a. Select **Start** → **Settings** → **Control Panel** to stop the service.
  - b. Double-click on the **Services** icon.
  - c. Highlight **IBMCORECLUSTERSERVICE**; then, click on the **Stop** button.
  - d. Close the Services window.
6. Click **Next** button.
7. Select a destination folder to install the IBM Netfinity Cluster Enabler software.

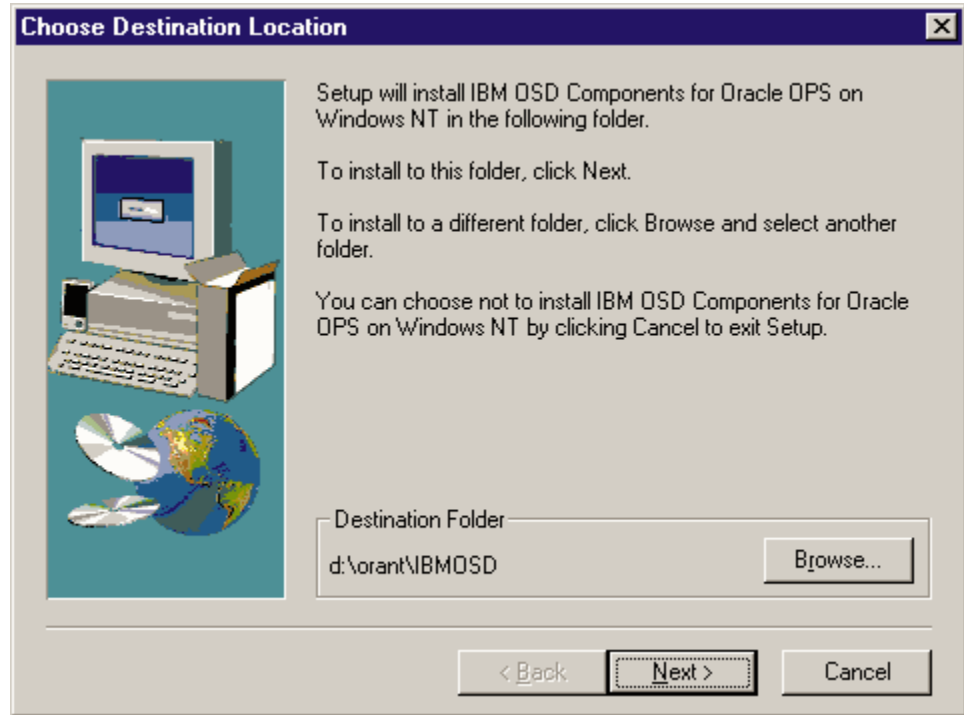

- a. To accept the default path of **%ORACLE\_HOME%\IBMOSD**, click on the **Next** button.
- b. To select a different directory, click on the **Browse** button and select the desired directory name.  
**Note:** Be sure to use the same full directory name for each server.
- c. Click on the **OK** button.
- d. Click on the **Next** button.

Setup verifies all the necessary information before copying the IBM Netfinity Cluster Enabler files to the desired directory.

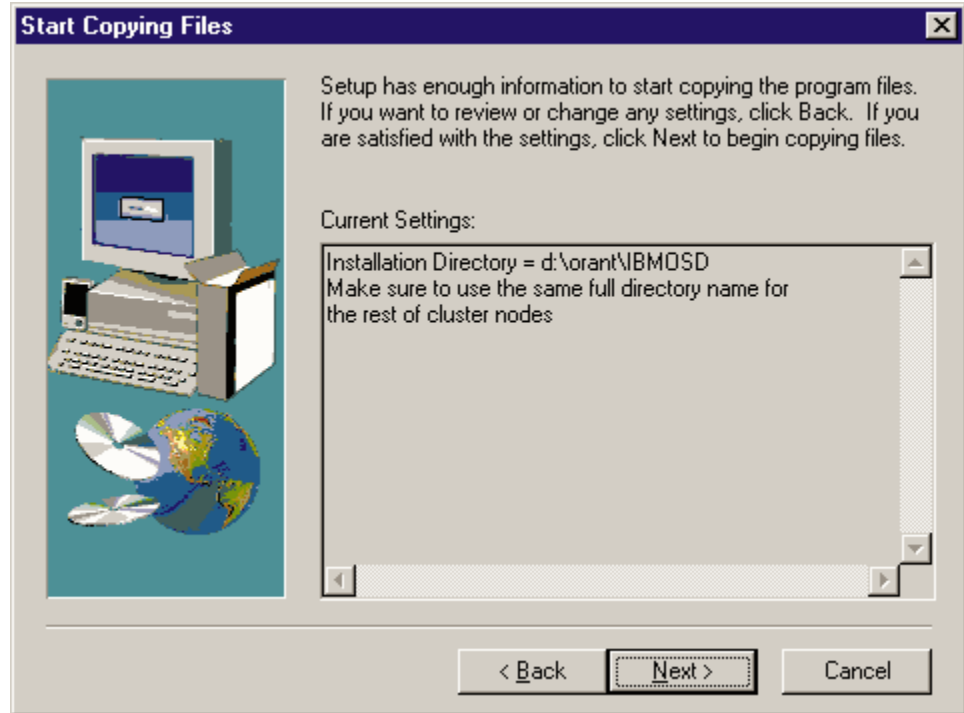

8. Click the **Next** button.

When the IBM Netfinity Cluster Enabler files are finished copying the files into the desired directory:

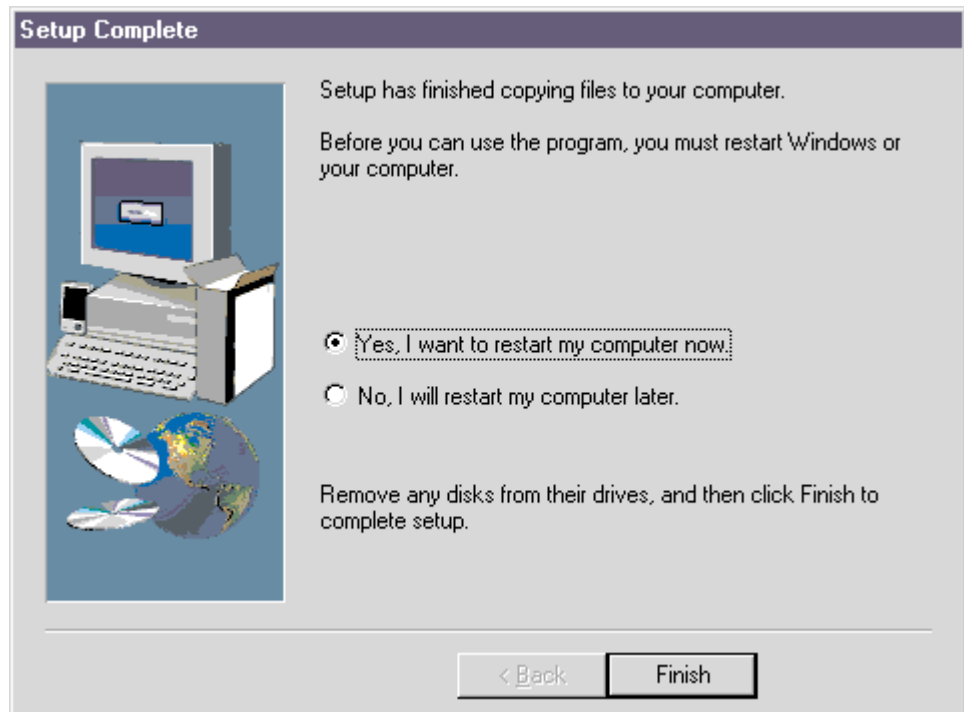

9. Select the radio button to restart the computer (server) now.

10. Click **Finish**.

Setup verifies all the necessary information before copying the IBM Netfinity Cluster Enabler files to the desired directory.

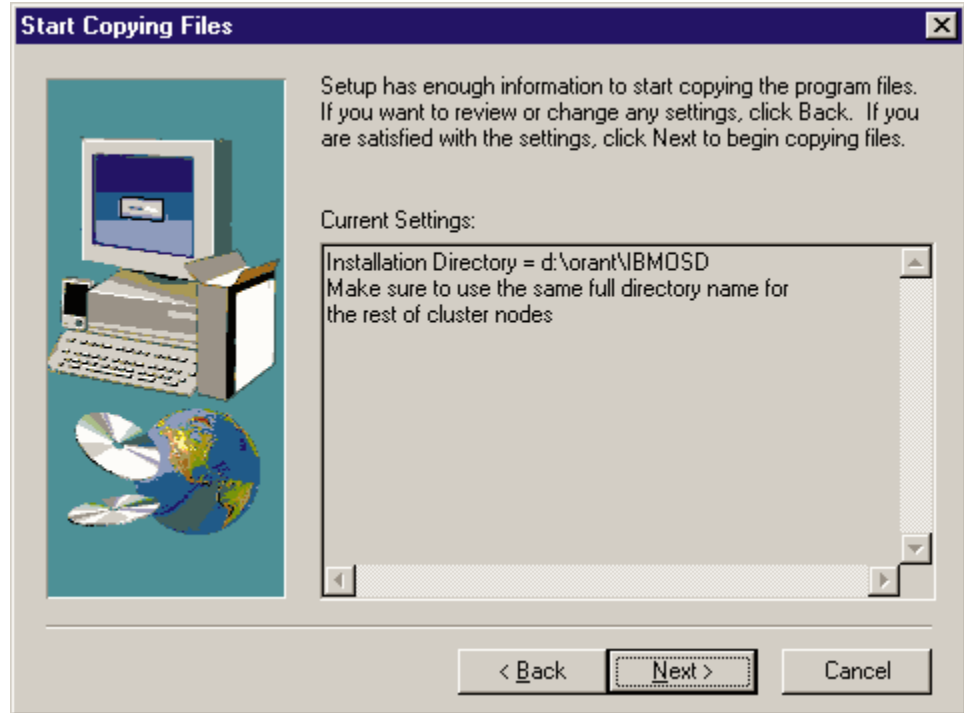

8. Click the **Next** button.

When the IBM Netfinity Cluster Enabler files are finished copying the files into the desired directory:

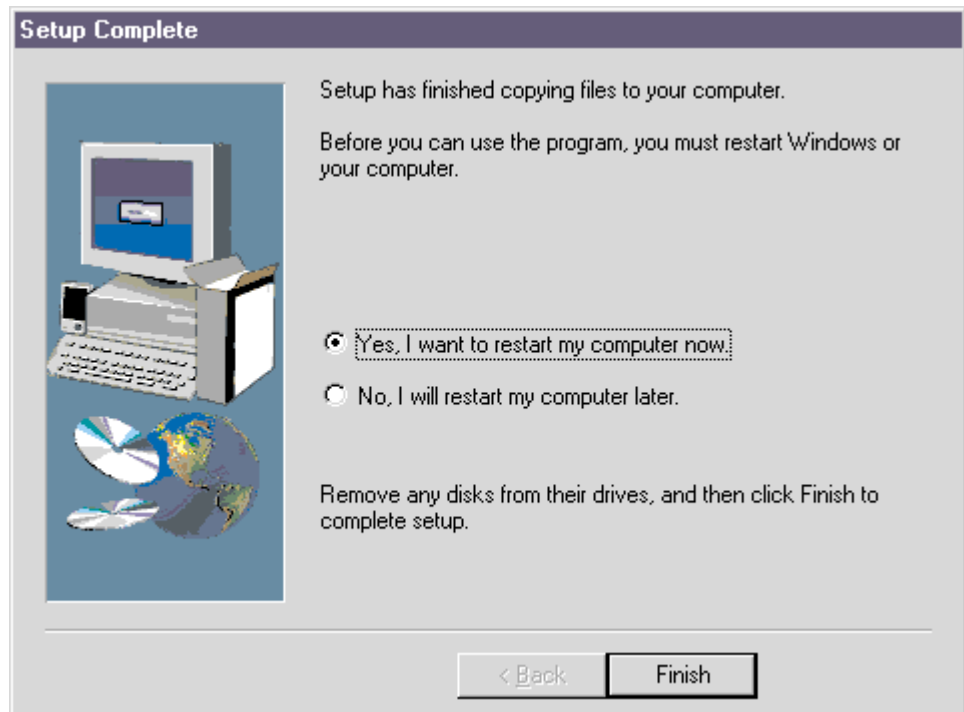

9. Select the radio button to restart the computer (server) now.

10. Click **Finish**.

The server must be restarted for the settings to take effect.

11. Repeat steps 1 on page 41 through step 10 on page 44 and install the IBM Netfinity Cluster Enabler files on each server.
12. Continue with “Step 8: Test and Verify Connectivity.”

---

## Step 8: Test and Verify Connectivity

Before you configure the IBM Netfinity Cluster Enabler files, you must test and verify the connectivity. To test and verify the connectivity, do the following:

1. Ping each server by the host name to ensure connectivity and verify the resolution of the IP addresses to the host names.
2. Use the Windows NT Disk Administrator to ensure that there are unused and unassigned logical drive letters available on each server.
  - a. Select **Start** → **Programs** → **Administrative Tools (Common)**
  - b. Double-click on **Disk Administrator** to view the logical drive letters available.
  - c. Click the right mouse button on the selected logical drive letter and select **Assign drive letter** from the menu option.
  - d. Select the **Do not assign drive letter** option.
  - e. Click **OK**.

or

Use Windows NT File Explorer and disconnect a network drive.

- a. Select **Start** → **Programs**
- b. Double-click on **Windows NT Explorer**.
- c. Select the network drive you want to disconnect, then, select **Tools** from the menu bar.
- d. Click on **Disconnect Network Drive**.

---

## Step 9: Assign Symbolic Links for the IBM Netfinity Cluster Enabler Heartbeat Disk

To assign a symbolic link for the heartbeat disk that was created in Step 5, you will need to create and edit the ORALINKx.TBL file; then, run the SETLINKS utility. Refer to *Oracle Parallel Server Getting Started* documentation for information about the SETLINKS utility.

**Note:** Do not run the SETLINKS utility until after you have created symbolic links for the Oracle Parallel Server.

1. Create an ASCII file named ORALINKx.TBL  
where *x* can be any character or number.
2. Add a symbolic link to the physical partition for each heartbeat disk you created and add the following entry into the ORALINKx.TBL, for example:

```
OPS_CMDISK \Device\HarddiskX\Partition Y
```

where: OPS\_CMDISK is the symbolic link name



X is the physical drive number  
Y is the partition number of the partition  
you created for the heartbeat disk for the  
IBM Netfinity Cluster Enabler.

**Notes:**

- a. The symbolic link name *must* be OPS\_CMDISK.
- b. The IBM Netfinity Cluster Enabler uses raw disk I/O routines to access the OPS\_CMDISK drive, so the disk does not need to be formatted.
3. If you are installing a five or six server (node) configuration refer to Appendix A, "Supplementary Instructions for Installing a Five or Six Node Oracle Parallel Server Configuration" on page 58 before continuing to the next step.
4. Continue with the next step in the *Oracle Parallel Server Getting Started* documentation.

---

## Step 10: Configure the IBM Netfinity Cluster Enabler (OSD Software)

The IBM Netfinity Cluster Enabler needs to be configured only once for all of the servers in the configuration.

**Note:** IBM Netfinity Cluster Enabler (OSD software) does not support fully qualified domain names (FQDN).

To configure the IBM Netfinity Cluster Enabler, do the following:

1. Ensure that all servers are up and running.
2. Click on **Start** and then click on **Run**.

In the **Open** box, type:

`%Your_Installation_Dir%\BIN\IBMGSCFG.EXE` and then click on **OK**.

or

Open a command prompt and type:

`%Your_Installation_Dir%\BIN\IBMGSCFG.EXE` and then press **ENTER**.

or

Select **Start** → **Programs** → **Windows NT Explorer**.

The IBM OSD Configuration (IBM Netfinity Cluster Enabler) window appears.

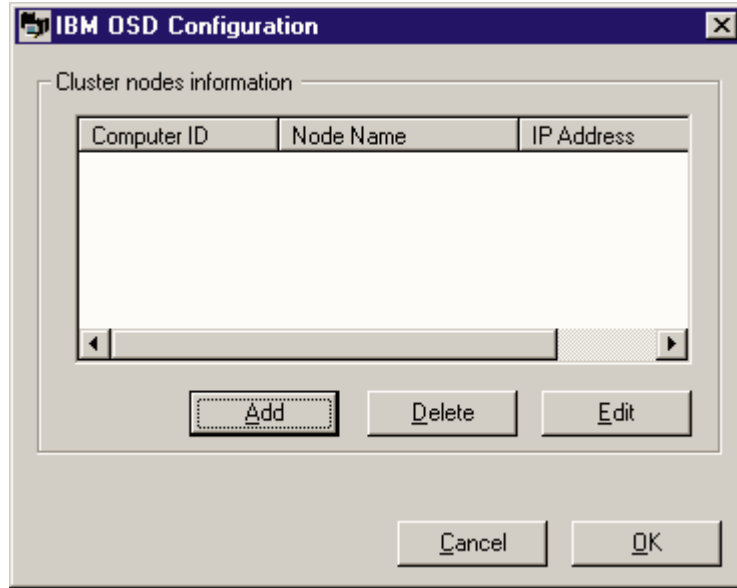

3. Click on the **Add** button.

The Editing cluster node information screen appears.

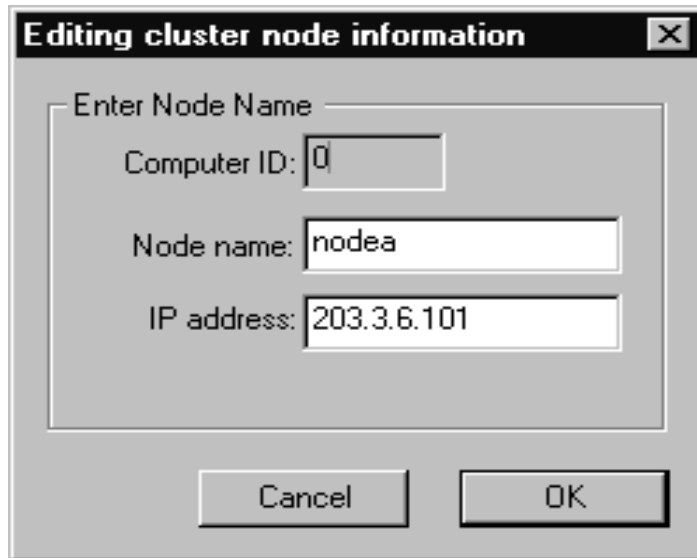

4. Type the server (node) name and the IP address for the server you want to add to the cluster.

**Note:** You must verify the IP address used for each server (node) for the cluster to interconnect.

5. Click on the **OK** button.

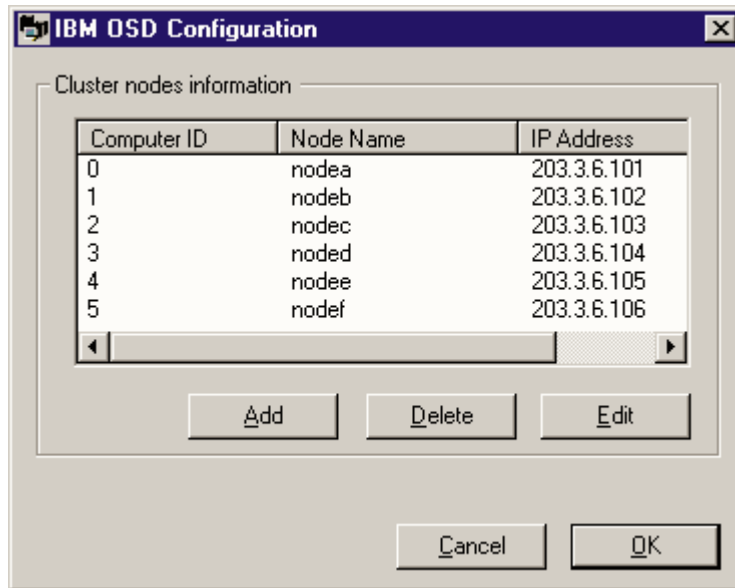

6. Repeat step 4 on page 47 until all server (node) names and IP addresses are entered in the cluster.
7. Click on the **OK** button.

Item	Description
<b>To delete a server (node)</b>	Select the server (node) and click the delete button.
<b>To edit a server (node) name or IP address</b>	Select the server (node) name or IP address and make the appropriate change.

The IBM Netfinity Cluster Enabler configuration program creates CSCUSTER.CFG and CSCOMPUTER.CFG configuration files, copies these files to each server listed in the cluster server information window, and updates the Windows NT Registry for each server. The IBM Netfinity Cluster Enabler configuration files are located under the subdirectory of *%Your\_Installation\_Dir%\config*. The Windows NT Registry data is located under:

HKEY\_LOCAL\_MACHINE\Software\Oracle\OSD\CM\DefinedNodes  
HKEY\_LOCAL\_MACHINE\Software\Oracle\OSD\CM\DefinedIPs  
HKEY\_LOCAL\_MACHINE\Software\Oracle\OSD\CM\CMHostName

8. Continue with "Step 11: Set Port Numbers in Windows NT Services File" on page 49.

---

## Step 11: Set Port Numbers in Windows NT Services File

As part of the configuration process for the IBM Netfinity Cluster Enabler software, four new services and their port numbers must be added to the Windows NT SERVICES file in each server. Setting these values enables the IBM Netfinity Cluster Enabler software in each server to communicate with the software in the other servers. The port numbers are used to direct IP messages to the correct program in each server.

Any port number that complies with the following rules can be used.

### Notes:

1. Each of the four services must have a different port number.
2. Each port number can be any 4-digit port number that is not already used in the SERVICES list and that is not already being used by any other program.
3. The port numbers for a particular service *must* be the same on all servers (nodes) in the cluster.

To add the following port numbers in the SERVICES file in each server, do the following:

1. Select **Start** → **Programs** → **Windows NT Explorer**

The Windows NT SERVICES file is a text file located in the Windows NT System Root directory at the following path:

```
%SYSTEMROOT%\SYSTEM32\DRIVERS\ETC\SERVICES
```

2. Edit the SERVICES file and add the four new services and their port numbers.

The following four services *must* be added to each server (node).

Services	Port#/Protocol
cstsl	1234/tcp
cstsr	1235/tcp
csgsl	1236/tcp
csgsr	1237/udp

### Notes:

- a. The above port numbers are examples only.
  - b. The protocol for **csgsr** is **udp** while the protocol for the other services is **tcp**.
3. Repeat step 1 and step 2 for each server.
  4. Continue with the next step in the *Oracle Parallel Server Getting Started* documentation.

The IBM Netfinity Cluster Enabler OSD software installation is now complete.

---

## Updating the IBM Cluster Enabler

To update the IBM Cluster Enabler (OSD) software, follow these steps on the entire cluster, one server at a time.

**Note:** The latest level of IBM Netfinity Cluster Enabler (OSD) software can be downloaded from the World Wide Web at:

<http://www.pc.ibm.com/us/netfinity/clustering.html>

1. Stop the Oracle database, IBMCoreClusterService, and any dependent Oracle services.

**Tip:** Stop and start only one server at a time.

- a. Select **Start→Settings→Control Panel**.
  - b. Double-click on the **Services** icon.
  - c. Highlight **IBMCoreClusterService**; then, click on the **Stop** button.
  - d. Close the **Services** window.
2. Copy the self extracting OSD files to a temporary directory.
  3. Run the IBM OSD extraction file to automatically invoke the setup program.
  4. Restart the IBMCoreClusterService, Oracle services, and Oracle dependent services.
    - a. Select **Start→Settings→Control Panel**.
    - b. Double-click on the **Services** icon.
    - c. Highlight **IBMCoreClusterService**; then, click on the **Start** button.
    - d. Close the **Services** window.
  5. Repeat step 1 through step 4 for each server.
  6. Verify that the IBM Cluster Enabler (OSD) software configurations have not changed by completing the procedure in “Step 7: Install the IBM Netfinity Cluster Enabler (OSD Software)” on page 41.

## Troubleshooting IBM Netfinity Cluster Enabler

The following table was developed from a database of frequently encountered problems that may occur. The first column provides a symptom of the malfunction. In the second column a brief explanation for the occurrence of the problem is provided. The last column provides a recommended course of action to resolve the problem.

Problem	Explanation	Action
IBM Core Cluster Service error appears after the first restart.	When a server is first restarted after installing the IBM Netfinity Cluster Enabler, it is possible to get an error message indicating that the services have failed to start. This message is not truly an error. Once all configuration steps are complete, the services will start correctly.	Restart the IBM Core Cluster Service.
Fully Qualified Domain Names (FQDN) are not supported.	Not supported.	Rerun IBM Netfinity Cluster Enabler configuration using non-fully qualified hostnames.
IBM Core Cluster Service <i>started</i> meaning.	When the IBM Core Cluster Service is started from the Windows NT Services menu, a set of processes are initiated. If any of these processes fail, a recovery action occurs that automatically restarts all of the processes. During the restart period, which could last from 2 to 3 minutes, the IBM Core Cluster Service is still in the <i>started</i> state, but some of the processes might not be fully restarted and running.	None.
Windows NT physical disk counters are not accurate.	Windows NT disk performance monitoring is turned off by default.	None.
IBM Netfinity Cluster Enabler (OSD) files cannot be uninstalled.	If the installation of the IBM Netfinity Cluster Enabler (OSD) software is interrupted (for example, a power failure) you will not be able to uninstall the files.	Delete the InstallShield UNINST.ISU file located in the installation directory and reinstall the IBM Netfinity Cluster Enabler (OSD) software.

Problem	Explanation	Action
<p>Shared drives show up first in the WINDISK instead of the local drives.</p>	<p>To implement failover capability with dual Symbios RAID controllers for Windows NT 4.0, a Symbios SymArray Class driver must first be loaded prior to loading the Windows NT SCSI Class driver. This implementation will cause the logical unit number (LUN) disk(s) to be assigned prior to the local disk(s) with Windows NT Disk Administrator. This is because Oracle OPS uses symbolic names instead of disk drive letters to map physical partitions to symbolic names. If a shared disk has failed and not been replaced, there is a potential problem using SETLINKS, with the mapping of symbolic links into a system disk instead of a shared disk. If LUN disk(s) have been assigned before local disk(s), then the system disk could be corrupted and impossible to restart.</p>	<p>To prevent this problem from happening, either correct the failed shared disk(s) and recover the LUN disk(s) before running SETLINKS. Or edit the ORAxix.TBL file to reflect the current disk configuration.</p>
<p>The OSD service  <pre>Net Stop IBMCoreClusterService</pre> does not successfully complete if other Oracle services are running.</p>	<p>The IBM Core Cluster Service and other Oracle services are interdependent due to timing considerations. When stopping IBM Core Cluster Service while OraclePGMSService and OracleServiceOPSn are running, you will be prompted to confirm that you want to stop these other services. According to the way Windows NT processes these services the Oracle services may be stopped, but the IBM Core Cluster Service may not.</p>	<p>When the Oracle services have stopped, issue</p> <pre>Net Stop IBMCoreClusterService</pre> a second time. Or choose from the following: Stop each service in the correct order: <ol style="list-style-type: none"> <li>1. OracleServiceOPSn</li> <li>2. OraclePGMSService</li> <li>3. IBMCoreClusterService</li> </ol> Use the Windows NT Services window to stop IBMCoreClusterService.

---

## Isolating Problems

IBM has created the following section to help you isolate problems if and when they occur. This solution contains many parts, some of which are not from IBM. To expedite problem resolution use the following problem determination sequence. It will help you resolve any problems and help identify whom you should seek for support.

This problem map will assist you with the isolation and resolution of problems with the hardware, the IBM Cluster Enabler (OSD) software, and the Oracle Parallel Server (OPS) software. The error you receive could be application generated or related. If while stepping through this guide, you have determined that an error is application generated or related, contact the appropriate vendor for that application.

### Step 1. Validating Device Drivers and Microcode

Verify that the server (node) in the cluster is operating with the appropriate version of the controller microcode, adapter microcode, system BIOS, and device driver levels. A list of supported versions can be found at the Web site:

<http://www.pc.ibm.com/us/support>

### Step 2. Isolating the Disk Subsystem

The following list of problem attributes will aid you in isolating the disk subsystem.

Cannot see the RAID adapter.

Cannot see shared storage disk drives from the Windows NT disk administrator.

Errors from SYMplicity Manager.

Amber lights on hard disk drives.

SYMArray messages in the system event log of the Windows NT event log.

LP6NDS35 messages in the system event log of Windows NT event log.

If any of the above conditions or messages occur, do the following:

- a. Use the recovery steps in the SYMplicity Storage Manager to correct the condition or message.
- b. Refer to Symbios documentation for further problem analysis.
- c. Contact Symbios support.
- d. Continue with step 6 on page 55.

If none of the conditions or messages occur, continue with step 3.

### Step 3. Isolating the IBM Netfinity Server Hardware

IBM Netfinity Server hardware problems appear as one of the following:

POST error messages.

Error messages in the Windows NT event log.

Blue screen (trap) errors before you are prompted to log on.

If any of the above conditions or messages occurs do the following:

- a. Consult the hardware documentation for the component that appears to be failing.
- b. Check the IBM online technical tips at:

<http://www.pc.ibm.com/us/support>



**Note:** Search for text relating to the component that appears to be failing.

- c. Contact IBM support.
- d. Continue with step 6 on page 55.

#### Step 4. Isolating Start Up Software Errors

To complete the software isolation steps for problem determination, you must determine the prior state of the server (node) producing the error. Identification of the prior state is determined by the node's participation in the cluster since either the OSD, or OPS software, has been installed. The table below specifies the states and conditions which determine the node's status.

<b>Start Up:</b>	The server (node) has been installed but has never participated in a cluster and functionally performed (continue with step 4).
<b>Up and Running:</b>	The server (node) has participated in a cluster and functionally performed. Neither the IBM Cluster Enabler (OSD), nor the Oracle Parallel Server (OPS) software has been installed (continue with step 5 on page 55).

Check the following items in the order shown:

- a. Validate that the critical Windows NT services are running to ensure the OPS solution is functioning.
- b. Close and restart Windows NT services if it is already open.
- c. Validate that the following four services are present and in a running state:

- IBMCoreClusterService
  - OracleTNSListener80
  - OraclePGMSService
  - OracleService<SID>

(where the number digit in the SID is one number higher than the node number)

If any of the above services is not in a running state, restart the service and all subsequent services documented above.

**Note:** Each service may take from 2 to 3 minutes to start.

- d. Validate that all servers (nodes) are using the same port number referenced in "Step 11: Set Port Numbers in Windows NT Services File" on page 49.
- e. Verify that the following three files are located in

- `%your_installation_dir%\IBMOSD\Config`

If any of these files are not present, reinstall the OSD software on that specific server (node).

- CSMETA.CFG
  - CSCUSTER.CFG
  - CSCOMPUTER.CFG.

- f. Verify that the environment variable, CS\_Install\_Dir is present and its path points to the OSD directory. If this environment variable is not present, or does not show the correct path, **do not** attempt to change the environment variable; reinstall the IBM Cluster Enabler software.
- g. Validate that the servers (nodes), ID, and IP addresses are filled in and correct in the CSCUSTER.CFG file.
- h. Validate that the first line of file CSCOMPUTER.CFG identifies the ID number of the server (node) this file came from.

If any of the above conditions, messages, or suggested actions does not correct the problem, do the following:

- 1) Reinstall the IBM Cluster Enabler software.
- 2) Continue with step 6.

### **Step 5. Isolating Up and Running Software Errors**

Check the following items in the order shown:

- a. Validate that the critical Windows NT services are running to ensure that the OPS solution is functioning.
- b. Close and restart Windows NT services if it is already open.
- c. Validate that the following four services are present and in a running state:

IBMCoreClusterService  
OracleTNSListener80  
OraclePGMSService  
OracleService<SID>

(where the number digit in the SID is one number higher than the node number)

If any of the above services is not in a running state, restart the service and all subsequent services documented above.

**Note:** Each service may take from 2 to 3 minutes to start.

- d. Validate all servers (nodes) are using the same port number referenced in “Step 11: Set Port Numbers in Windows NT Services File” on page 49.
- e. Check the Windows NT event log for hardware errors.
- f. Correct any hardware errors as necessary.
- g. Restart the server (node).

If any of the conditions or messages in the above steps do not correct the problem, do the following:

- 1) Contact Oracle support for ORA-xxxxx errors, or Oracle database errors at the Oracle command prompt.
- 2) Continue with step 6.

### **Step 6. Contacting Support**

To assist with problem resolution, have the following information ready before contacting support, either electronic or voice.

Contacting IBM Support:

- a. Machine Type Model and Serial Number of the failing server.
- b. Operating system, service pack, and IBM Cluster Enabler (OSD) software level.
- c. BIOS, microcode, and device driver levels for the system unit, Symbios disk subsystem.
- d. Configuration of Symbios disk subsystem.
- e. Number of servers (nodes) in the cluster showing similar symptoms.

Contacting Symbios Support:

- a. Server type and configuration.
- b. Operating System and service pack level.

- c. Name and version of SYMplicity Storage Manager software.
- d. Model number of array and serial number on the Symbios CM1000 command module.

Contacting Oracle Support:

- a. Refer to the Oracle web site at:  
<http://www.oracle.com/support>
- b. Customer number.
- c. Operating System version number.
- d. Oracle DataBase version number.
- e. ORA-xxxxx error information, if any.
- f. Error or log file information resulting from the problem.

**Note:** The *Oracle Guide to Customer Support* publication included with your Oracle software will provide the most current information on customer support.

---

## Getting Help, Service, and Information

If you need help, service, technical assistance, or just want more information about IBM products, you will find a wide variety of sources available from IBM to assist you.

For example, IBM maintains pages on the World Wide Web where you can get information about IBM products and services, find the latest technical information, and download device drivers and updates. Some of these pages are:

<a href="http://www.ibm.com">http://www.ibm.com</a>	Main IBM home page
<a href="http://www.pc.ibm.com">http://www.pc.ibm.com</a>	IBM Personal Computer home page
<a href="http://www.pc.ibm.com/desktop/">http://www.pc.ibm.com/desktop/</a>	IBM Commercial Desktop home page
<a href="http://www.pc.ibm.com/servers/">http://www.pc.ibm.com/servers/</a>	IBM PC Server home page
<a href="http://www.pc.ibm.com/options/">http://www.pc.ibm.com/options/</a>	IBM Options home page

Help is also available from bulletin boards and online services, as well as by fax and telephone.

Services available and telephone numbers listed are subject to change without notice.

---

## Solving Problems

Many computer problems can be solved without outside assistance, by using the online help or by looking in the online or printed documentation that comes with your computer or software. Also, be sure to read the information in any README files that come with your software.

Most computers, operating systems, and application programs come with documentation that contains troubleshooting procedures and explanations of error messages. The documentation that comes with your computer also contains information about the diagnostic tests you can perform.

---

## Appendix A. Supplementary Instructions for Installing a Five or Six Node Oracle Parallel Server Configuration

The *Oracle Parallel Server Getting Started Guide* provides instructions on how to set up first 4 server (nodes) of the cluster. If you want to set up a five or six server (node) of the cluster, use the instructions in this section along with the instructions in Chapter 5 of the *Oracle Parallel Server Getting Started Guide*.

The following files and additional information provide instructions on how to set up a fifth and sixth node Oracle Parallel Server configuration. The files are not provided by Oracle on the Oracle8 Enterprise Edition for Windows NT CD. You can find the files needed to complete this task in the %Your\_Installation\_Dir%\config directory provided with the IBM Cluster Enabler (OSD software).

Copy the following files to the ORACLE\_HOME/OPS directory.

### Database Initialization Files

INITOPS5.ORA  
INITOPS6.ORA

### SETLINKS Input Files

ORALINK4.TBL  
ORALINK5.TBL

### Database Creation Files

C\_RBS5.SQL  
C\_THR5.SQL  
C\_RBS6.SQL  
C\_THR6.SQL

Refer to Chapter 5, of the *Oracle Parallel Server Getting Started* and the following additional steps for setting up a fifth and sixth node in the cluster.

---

### Step 1: Copy Initialization Files

1. Ensure that you have copies the **INITOPS5.ORA** and **INITOPS6.ORA** files to the ORACLE\_HOME\OPS directory.
2. Refer to the instructions in the *Oracle Parallel Server Getting Started Guide*.

---

## Step 2: Assign Symbolic Links to Each Logical Drive

If you are setting up a fifth and sixth node in the cluster, input files are created for SETLINKS that contain information for each node. These files are:

ORALINK4.TBL (for fifth node)  
ORALINK5.TBL (for sixth node)

1. Ensure that you have copied the ORALINK4.TBL and ORALINK5.TBL files to the ORACLE\_HOME\OPS directory.
2. Edit each ORALINKx.TBL  
(where x is one less than the number of the node) file.
3. Replace the harddiskX letter and partitionY letter to match the disk numbers and partitions number you recorded earlier in "Step 3: Unassign Drive Letters" in Chapter 3, "Performing Pre-Installation Tasks" of the *Oracle Parallel Server Getting Started Guide*.
4. Run the ASCII input file for each ORALINKx.TBL through the SETLINKS application as shown below:

```
C:\>CD ORACLE_HOME\OPS  
C:\ORACLE_HOME\OPS> SETLINKS /F:ORALINKx.TBL
```

(where x is one less than the number of the node)

Refer to the instructions in Chapter 5, Step 2: Assign Symbolic Links to Each Logical Drive, in the *Oracle Parallel Getting Started Guide* for more information.

---

## Step 3: Configure the IBM Netfinity Cluster Enabler (OSD Software)

Refer to "Step 10: Configure the IBM Netfinity Cluster Enabler (OSD Software)" on page 46 for instructions.

---

## Step 4: Create Services

Refer to the instructions in the *Oracle Parallel Server Getting Started Guide*.

---

## Step 5: Add the ORACLE\_SID Entry to the Registry

Refer to the instructions in the *Oracle Parallel Server Getting Started Guide*.

---

## Step 6: Configure the Network

Refer to the instructions in the *Oracle Parallel Server Getting Started Guide*.

---

## Step 7: Create an Oracle Parallel Server Database

1. Ensure that you have copied the following files to the ORACLE\_HOME\OPS directory.

C\_RBS5.SQL  
C\_THR5.SQL

C\_RBS6.SQL  
C\_THR6.SQL

2. Connect to the instance and run the OPSALL.SQL script to create the database, do the following:

```
C:\> CD ORACLE_HOME\OPS  
C:\ORACLE_HOME\OPS> SVRMGR3  
SVRMGR> @OPSALL.SQL
```

**Note:** Running the OPSALL.SQL will only enable a 2 server (node) in the cluster.

If you are setting up a 3rd, 4th, 5th, or 6th server (node) in the cluster, repeat the following for each node:

```
C:\> CD ORACLE_HOME\OPS  
C:\ORACLE_HOME\OPS> SVRMGR3  
SVRMGR> STARTUP
```

```
SVRMGR> @C_THRx.SQL  
SVRMGR> @C_RBSx.SQL
```

where x equals the number of the node)

3. Continue with Chapter 5, Step 7-4 of the *Oracle Parallel Getting Started Guide* and complete the remaining steps.

---

## Appendix B. About the IBM Core Cluster Service

The IBM Netfinity Cluster Enabler installation and configuration utility automatically installs and uninstalls the IBM Core Cluster Service without you ever having to be directly involved. The following descriptions will help you understand the operations of the IBM Core Cluster Services.

The IBM Core Cluster Service is a new Windows NT Service that is provided by IBM as part of the IBM Netfinity Cluster Enabler program. The purpose of the IBM Core Cluster Service is to start the processes necessary to run OraclePGMSService, which is the primary clustering component of Oracle Parallel Server (OPS). The OraclePGMSService requires a set of IBM clustering services to be running before OraclePGMSService can be operational. The IBM Core Cluster Service starts the IBM clustering services and ensures that the OraclePGMSService dependency is managed automatically.

### Manually Installing the IBM Core Cluster Service

To manually install the IBM Core Cluster Service:

1. Change to the directory containing IBMCORECLUSTERSERVICE.EXE
2. Type: **IBMCoreClusterService -install**

The IBM Core Cluster Service registers itself with the Windows NT Service Manager and sets itself as a dependency for the OraclePGMSService service. The dependency ensures that IBM Core Cluster Service is started before OraclePGMSService is started.

### Manually Starting the IBM Core Cluster Service

To manually start the IBM Core Cluster Service:

1. Select **Start** → **Settings** → **Control Panel**
2. Double-click on **Services**.
3. From the Windows NT Services window, select **IBMCoreClusterService**; then, click on the **Start** button.

The IBM Core Cluster Service starts the clustering processes. When the startup sequence is complete, the status of IBM Core Cluster Services in the Windows NT Services window will be *Started*.

### Manually Stopping the IBM Core Cluster Service

To stop the IBM Core Cluster Service:

1. Select **Start** → **Settings** → **Control Panel**
2. Select the **IBMCoreClusterService**; then, click on the **Stop** button.

When the stop sequence is complete, the status of IBM Core Cluster Services in the Windows NT Services window will be *Stopped*.

**Note:** The IBM Core Cluster Service will start automatically when the system is restarted.



## Manually Uninstalling the IBM Core Cluster Service

To uninstall the IBM Core Cluster Service,

1. Ensure that the IBMCoreClusterService is in a stopped state.
2. Type: **IBMCoreClusterService -uninstall**

The IBM Core Cluster Service unregisters itself with the Windows NT Service Manager and removes itself as a dependency from the OraclePGMSService.

---

## Appendix C. Product Notices

References in this publication to IBM products, programs, or services do not imply that IBM intends to make these available in all countries in which IBM operates. Any reference to an IBM product, program, or service is not intended to state or imply that only that IBM product, program, or service may be used. Subject to IBM's valid intellectual property or other legally protectable rights, any functionally equivalent product, program, or service may be used instead of the IBM product, program, or service. The evaluation and verification of operation in conjunction with other products, except those expressly designated by IBM, are the responsibility of the user.

IBM may have patents or pending patent applications covering subject matter in this document. The furnishing of this document does not give you any license to these patents. You can send license inquiries, in writing, to:

IBM Director of Licensing  
IBM Corporation  
500 Columbus Avenue  
Thornwood, NY 10594  
U.S.A.

Any references in this publication to non-IBM Web sites are provided for convenience only and do not in any manner serve as an endorsement of those Web sites. The materials at those Web sites are not part of the materials for this IBM product and use of those Web sites is at your own risk.

---

## Trademarks

The following terms are trademarks of the IBM Corporation in the United States or other countries:

EtherJet  
IBM  
Netfinity

HelpCenter  
HelpWare  
OS/2

Windows and Windows NT are trademarks or registered trademarks of the Microsoft Corporation.

Other company, product, and service names may be trademarks or service marks of others.