



**Hardware Maintenance Service  
for Service Level A**

For Micro Tower Models  
Machine Type 2193, 2194 and 6345

For Desktop Models  
Machine Type 2196, 2197 and 6344

**Note**

Before using this information and the product it supports, be sure to read the general information under "Notices" on page 4.

**First Edition (March 2000)**

The following paragraph does not apply to any state or country where such provisions are inconsistent with local law:

INTERNATIONAL BUSINESS MACHINES CORPORATION PROVIDES THIS PUBLICATION "AS IS" WITHOUT WARRANTY OF ANY KIND, EITHER EXPRESSED OR IMPLIED, INCLUDING, BUT NOT LIMITED TO, THE IMPLIED WARRANTIES OF MERCHANTABILITY OR FITNESS FOR A PARTICULAR PURPOSE. References to IBM products, programs, or services do not imply that IBM intends to make them available outside the United States. This publication could include technical inaccuracies or typographical errors. Changes are periodically made to the information herein; these changes will be made in later editions. IBM may make improvements and/or changes in the product(s) and/or the program(s) at any time. Address comments about this publication to IBM Corporation, Dept. E23/962-2, 455 Park Place, Lexington, KY 40511-1856, USA. Information you supply may be used by IBM without obligation. For copies of publications related to this product, call toll free 1-800-IBM-7282 in the Continental U.S.A. In Canada, call toll free 1-800-465-7999.

**© Copyright International Business Machines Corporation 2000.  
All rights reserved.**

Note to U.S. Government Users – Documentation related to restricted rights – Use, duplication or disclosure is subject to restrictions set forth in GSA ADP Schedule Contract with IBM Corp.

---

## Contents

<b>Notices</b> .....	<b>4</b>
Voltage Supply Switch Settings .....	4
Safety Information .....	5
Laser Compliance Statement .....	34
Trademarks .....	35
Preface .....	36
<b>General Information</b> .....	<b>37</b>
Introduction .....	38
Product Overview .....	38
Hardware Interfaces .....	43
CMOS Reset .....	45
Flash (BIOS) Update Procedure .....	46
BIOS-contained Model Number and Serial Number .....	47
BIOS Setup Utility .....	48
Working with the Setup Menus .....	48
Start Options .....	50
Advanced Setup .....	52
Power Management Setup .....	56
ISA Legacy Resource .....	58
Set Password .....	58
Specifications .....	59
Operating Requirements .....	60
Special Tools .....	61
<b>Check Procedures</b> .....	<b>62</b>
Introduction .....	63
Start .....	64
Index of Symptoms, Messages, Error Codes, or Beeps .....	69
Troubleshooting .....	84
Factory-Installed Storage Devices .....	85
Factory-Installed Modem Card .....	87
Audio (Not Supported by Diagnostics Program) .....	89
CD-ROM Drive .....	91
Memory .....	92
Keyboard .....	92
Mouse .....	93
Power Supply .....	96
Monitor .....	99
Undetermined Problems .....	101
<b>Diagnostic Aids</b> .....	<b>103</b>
Introduction .....	104
Power-On Self Test .....	104
Diagnostics Tools .....	105
Using Diagnostics Program from Recovery CD .....	105
Diagnostics Program Features .....	106

**Repairing Information ..... 109**

Removals and Replacements of machine type 2193,  
2194, and 6345 ..... 110  
Identifying the Parts of the System Unit ..... 111  
Top Cover ..... 113  
    Adapter Cards ..... 114  
    Diskette Drive ..... 116  
    CD-ROM Drive ..... 118  
Hard Disk Drive ..... 119  
System Board ..... 120  
    Power Supply ..... 121  
    Memory (DIMM) ..... 123  
Removals and Replacements of machine type 2196,  
2197, and 6344 ..... 124  
Identifying the Parts of the System Unit ..... 125  
Top Cover ..... 127  
    Adapter Cards ..... 128  
    Diskette Drive ..... 130  
    CD-ROM Drive ..... 131  
Hard Disk Drive ..... 132  
System Board ..... 133  
    Power Supply ..... 136  
    Memory (DIMM) ..... 137

**Parts/Test Point Locations ..... 139**

Introduction ..... 140  
Layout of System Board of the Machine Type 2194  
(Italy), 2197 and 6344 (EMEA/AP) ..... 141  
    Jumper Settings of the System Board of the Machine Type  
    2194 (Italy), 2197 and 6344 (EMEA/AP) ..... 142  
    Connectors and Functions of System Board of the Machine  
    Type 2194 (Italy), 2197 and 6344 (EMEA/AP) ..... 143  
Layout of System Board of the Machine Type 6344  
(US/Canada/LA) ..... 144  
    Connectors and Functions of System Board of the Machine  
    Type 6344 (US/Canada/LA) ..... 145  
Layout of System Board of the Machine Type 2193 and  
2196 ..... 146  
    Jumper Settings of the System Board of the Machine  
    Type 2193 and 2196 ..... 147  
    Connectors and Functions of System Board of the  
    Machine Type 2193 and 2196 ..... 148  
Layout of System Board of the Machine Type 2194 and  
6345 ..... 149  
    Jumper and Connector Settings of the System Board of the  
    Machine Type 2194 and 6345 ..... 150  
Power Supply Cable Connector Specifications ..... 157  
    Main Output Pin Assignment ..... 158  
Factory-Installed Modem Card Layout ..... 160  
    Factory-Installed Modem Card Connector Functions.. 160

3.5-In. Hard Disk Drive Jumper Locations & Settings .....	161
CD-ROM Drive .....	162
CD-ROM Drive Rear Panel Connectors and Features .....	163
CD-ROM Drive Jumper Settings .....	163
DIMM Configurations .....	164
System Board Connector Pin Signals.....	164
Monitor Port Signals.....	164
Serial Port Signals .....	164
Parallel Port Signals.....	165
Mouse Port Signals.....	165
Keyboard Port Signals .....	165
Diskette Drive Cable Connector Signals.....	166
IDE Cable Connector Signals.....	167
<b>Safety Inspection Guide .....</b>	<b>169</b>
General Guidelines .....	170
<b>Parts Catalog .....</b>	<b>171</b>
Part Catalog of machine type 2193, 2194, and 6345 .....	172
Assembly 1: System Unit .....	172
Assembly 2: Diskette Drive, Hard Disk Drive .....	176
Assembly 3: CD-ROM, Modem Card.....	177
Assembly 4: Keyboard and Mouse .....	180
Part Catalog of machine type 2196, 2197, and 6344 .....	185
Assembly 1: System Unit .....	185
Assembly 2: Diskette Drive, Hard Disk Drive .....	189
Assembly 3: CD-ROM, Modem Card.....	190
Assembly 4: Keyboard and Mouse .....	192
<b>Appendix A. Online Support Information .....</b>	<b>195</b>
<b>Index</b>	

## Notices

References in this publication to IBM products, programs, or services do not imply that IBM intends to make these available in all countries in which IBM operates. Any reference to an IBM product, program, or service is not intended to state or imply that only IBM's product, program, or service may be used. Any functionally equivalent product, program, or service that does not infringe any of IBM's intellectual property rights, or other legally protectable rights, may be used instead of the IBM product, program, or service. References in this publication to IBM products, programs, or services are purely hardware-related and do not cover circumstances of software problems. Evaluation and verification of operation in conjunction with other products, program, or services, except those expressly designated by IBM are the user's responsibility.

IBM may have patents or pending patent applications covering subject matter in this document. The featuring of these patents, pending or otherwise, in this document does not give you any license to these patents. You can send license inquires, in writing, to the IBM Director of Commercial Relations, IBM Corporation, Purchase, NY10577.

### Voltage Supply Switch Settings

Your IBM Personal Computer *might* have voltage switches, which must be set correctly for your voltage supply. If your monitor or system unit has a voltage switch, complete these steps to make sure each switch is set correctly:

1. Determine the correct voltage switch setting for your area:

<u>Voltage Supply Range</u>	<u>Voltage Switch Setting</u>
100-127 V	110 V
200-240 V	220 V

2. Locate the voltage switch on the back of your monitor or system unit. If the setting shown on the switch is:

- Correct: start setting up your IBM personal computer.
- Incorrect: change the voltage switch setting.

## Safety Information



### **DANGER**

**To avoid a shock hazard, do not connect or disconnect any cables or perform installation, maintenance, or reconfiguration of this product during an electrical storm.**

**To avoid shock hazard:**

- The power cord must be connected to a properly wired and earthed receptacle.**
- Any equipment to which this product will be attached must also be connected to properly wired receptacles.**

**When possible, use one hand to connect or disconnect signal cables to prevent a possible shock from touching two surfaces with different electrical potentials.**

**Electrical current from power, telephone, and communications cables is hazardous. To avoid shock hazard, connect and disconnect cables as described following when installing, moving, or opening covers of this product or attached devices.**

<b>To Connect</b>	<b>To Disconnect</b>
1. Turn Everything OFF.	1. Turn Everything OFF.
2. First, attach all cables to devices.	2. First, remove power cord(s) from outlet
3. Attach signal cables to receptacles.	3. Remove signal cables from receptacles.
4. Attach power cord(s) to outlet.	4. Remove all cables from devices.
5. Turn device ON	





**Caution:**

When replacing the battery, use only IBM Part Number 36L9077 or an equivalent type battery recommended by the manufacturer. If your system has a module containing a lithium battery, replace it only with the same module type made by the same manufacturer. The battery contains lithium and can explode if not properly used, handled, or disposed of.

**Do not:**

- Throw or immerse into water
- Heat to more than 100°C (212°F)
- Repair or disassemble

Dispose of the battery as required by local ordinances or regulations.



**Caution:**

When a CD-ROM drive is installed, note the following.

Use of controls or adjustments or performance of procedures other than those specified herein might result in hazardous radiation exposure.

Removing the covers of the CD-ROM drive could result in exposure to hazardous laser radiation. There are no serviceable parts inside the CD-ROM drive. Do not remove the CD-ROM drive covers.

**DANGER**

Some CD-ROM drives contain an embedded Class 3A or Class 3B laser diode. Note the following.

Laser radiation when open. Do not stare into the beam, do not view directly with optical instruments, and avoid direct exposure to the beam.



≥32 Kg (70.5 lbs)    ≥55Kg (121.2 lbs)

**Caution:**

Use safe lifting practices when lifting your machine.



**Caution:**

Electrical current from power, telephone, and communication cables can be hazardous. To avoid personal injury or equipment damage, disconnect the attached power cords, telecommunications systems, networks, and modems before you open the covers, unless instructed otherwise in the installation and configuration procedures.



**PERIGO**

Para evitar choques elétricos, não conecte ou desconecte nenhum cabo, nem efetue instalação, manutenção ou reconfiguração deste produto durante uma tempestade com raios.

Para evitar choques elétricos:

- O cabo de alimentação deve ser conectado a um receptáculo corretamente instalado e aterrado.
- Todos os equipamentos aos quais este produto será conectado devem também ser conectados a receptáculos corretamente instalados.

Quando possível, utilize uma das mãos para conectar ou desconectar cabos de sinal, para evitar um possível choque ao tocar duas superfícies com potenciais elétricos diferentes.

A corrente elétrica proveniente de cabos de alimentação, de telefone e de comunicação é perigosa. Para evitar choques elétricos, conecte e desconecte os cabos conforme descrito a seguir, ao instalar, movimentar ou abrir tampas deste produto ou de dispositivos conectados.

<b>Para Conectar</b>	<b>Para Desconectar</b>
1. DESLIGUE tudo.	1. DESLIGUE tudo.
2. Conecte primeiro todos os cabos nos dispositivos.	2. Remova primeiro o(s) cabo(s) de alimentação das tomadas.
3. Conecte os cabos de sinal nos receptáculos.	3. Remova os cabos de sinal dos receptáculos.
4. Conecte o(s) cabo(s) de alimentação nas tomadas.	4. Remova todos os cabos dos dispositivos.
5. LIGUE o dispositivo.	



**cuidado:**

Ao substituir a bateria, utilize apenas o Número de Peça IBM 33F8354 ou um tipo de bateria equivalente recomendado pelo fabricante. Se seu sistema possuir um módulo com uma bateria de lítio, substitua-o apenas pelo mesmo tipo de módulo, produzido pelo mesmo fabricante. A bateria contém lítio e pode explodir se não for utilizada, manuseada e descartada de forma adequada.

**Não:**

- Jogue ou coloque na água
- Aqueça a mais de 100°C (212°F)
- Conserte nem desmonte.

Descarte a bateria conforme requerido pelas disposições e regulamentações locais.



**cuidado:**

Quando uma unidade de CD-ROM estiver instalada, observe o seguinte.

A utilização de controles ou ajustes ou a execução de procedimentos diferentes daqueles especificados nesta publicação pode resultar em exposição perigosa à radiação.

A remoção das tampas da unidade de CD-ROM pode resultar em exposição a radiação perigosa de laser. Não existem peças que possam ser consertadas no interior da unidade de CD-ROM. Não remova as tampas da unidade de CD-ROM.

**PERIGO**

Algumas unidades de CD-ROM contém um diodo de laser da Classe 3A ou da Classe 3B. Observe o seguinte.

Radiação de laser quando aberto. Não olhe diretamente para o feixe de laser, não olhe diretamente com instrumentos óticos, e evite exposição direta ao raio.



≥32 Kg    ≥55Kg  
(70,5    (121,2  
lbs)      lbs)

**cuidado:**

Utilize práticas seguras para levantamento de peso ao levantar sua máquina.



**cuidado:**

A corrente elétrica proveniente de cabos de alimentação, de telefone e de comunicação é perigosa. Para evitar ferimentos pessoais ou danos aos equipamentos, desconecte os cabos de alimentação, sistemas de telecomunicação, redes e modems antes de abrir as tampas, a menos que receba outras instruções nos procedimentos de instalação e configuração.

声明 1



危险!

为避免电击危险，请不要在暴风雨期间连接或断开任何电缆，或是进行此产品的安装、维护或重新配置操作。

为避免电击危险：

- 电源线必须连接到适当的电线及接地插座。
- 此产品将要连接的所有设备也必须连接到正确接线的插座上。

如果可能，请使用一只手连接或断开连接信号电缆，以避免在接触两个具有不同电势的表面时遭到电击。

电源线、电话线以及通信电缆中的电流非常危险。为避免电击，请在安装、移动或打开本产品或连接设备的外盖时，按照下述步骤连接或断开电缆。

**要连接电缆**

1. 关闭所有设备。
2. 首先将所有电缆与设备连接。
3. 将信号线连接到插座。
4. 将电源线连接到电源插座。
5. 打开设备。

**要断开电缆**

1. 关闭所有设备。
2. 首先从电源插座拔下电源线。
3. 从插座拔下信号电缆。
4. 从设备上拔下所有电缆。

## 声明 2



### 注意！

当更换电池时，仅可使用 IBM 部件号为 33F8354 的产品或由制造商推荐的同等电池。如果系统中有包含锂电池的模块，则只能使用由相同制造商制造的相同类型模块更换。该电池含有锂，如果使用、操作或处理不当会发生爆炸。

### 不要：

- 将其投入或浸于水中
- 加热超过100°C (212°F)
- 修理或拆卸

应按照当地法规和条例对此电池进行处理。

## 声明 3



### 注意！

在已安装 CD-ROM 驱动器的情况下，请注意下面的内容。

不遵循此处指定的控制、调整、或操作过程的操作将可能导致危险的辐射泄漏。

取下 CD-ROM 驱动器的外盖会导致危险的激光辐射泄漏。CD-ROM 驱动器内没有可以使用的部件。请不要取下 CD-ROM 驱动器的外盖。

## 声明 4

### 危险！

一些 CD-ROM 驱动器中包含内置的 3A 类或 3B 类激光二极管。  
请注意下述内容。

打开驱动器会产生激光辐射。请不要凝视激光束，请不要使用光学仪器直接观看激光束，同时也要避免人体直接暴露在激光束下。



声明 5



32 kg (70.5 磅)



55 kg (121.2 磅)

**注意!**

搬运机器时，请进行安全搬运操作。

声明 10



**注意!**

电源线、电话线以及通信电缆中的电流非常危险。为避免人身伤害或设备损坏，除非在安装和配置过程中特别指明，请在打开服务器外盖前断开已连接的全部电源线、电信系统、网络及调制解调器。

• 聲明 1



危險

為了避免雷擊，在閃電期間，請勿連接或拔掉本裝置上的任何電纜線，或請勿安裝、維修或重新架構本產品。

為了避免雷擊：

- 電源線必須連接到接線及接地正確的插座。
- 本產品所連接的設備也必須連接到接線正確的插座。

儘可能使用單手來連接或拔掉信號電纜，以避免因接觸兩不同電位的平面，而受到電擊。

電源、電話及通信電纜上均有電流通過。為了避免電擊，在安裝、移動本產品，或開啓本產品的蓋子或與本產品連接之裝置的蓋子時，請依照下列「連接」及「拔掉」電纜線的步驟操作。

連接

1. 關掉所有開關。
2. 首先，將所有電纜線連接到裝置。
3. 將信號電纜連接到信號插座。
4. 將電源線連接到電源插座。
5. 開啓裝置電源。

拔掉

1. 關掉所有開關。
2. 首先，自電源插座拔掉電源線。
3. 拔掉信號插座上的所有信號電纜。
4. 拔掉裝置上的所有電纜線。

• 聲明 2



注意：

更換電池時，只可使用 IBM 零件編號 33F8354 的電池，或廠商建議的相當類型的電池。如您系統中的模組含有鋰電池，更換時，請使用相同廠商製造的相同模組類型。如未正常使用、處理或捨棄含有鋰的電池時，可能會造成爆炸。

嚴禁：

- 丟入或浸入水中
- 加熱超過攝氏100度（華氏212度）
- 修補或拆解

處理廢棄電池時，請遵照當地法令規章處理。

• 聲明 3



注意：  
安裝光碟機時，請注意下列事項：

不依此處所指示的控制、調整或處理步驟，恐有遭致輻射之虞。

移開光碟機蓋子，恐有遭致雷射輻射之虞。光碟機中沒有需要維修的部分。請勿移開光碟機的蓋子。

• 聲明 4



危險

光碟機含有內嵌式 Class 3A 或 Class 3B 雷射二極體時，請注意下列事項：

開啓時會產生雷射輻射。請勿凝視光束，不要使用光學儀器直接觀察，且應避免直接暴露在光束下。

• 聲明 5



≥ 32 公斤 (70.5 磅)



≥ 55 公斤 (121.2 磅)

注意：  
提昇機器時，請使用安全提昇措施。

• 聲明 10



注意：  
電源、電話及通信電纜上均有電流通過。在安裝及架構之時，若非專家指導，為了避免人員受傷、設備受損，在開啓伺服器蓋子之前，請切斷電源線、電信系統、網路及數據機。



**DANGER**

Pour éviter tout risque de choc électrique, ne manipulez aucun câble et n'effectuez aucune opération d'installation, d'entretien ou de reconfiguration de ce produit au cours d'un orage.

Pour éviter tout risque de choc électrique :

- Les cordons d'alimentation du présent produit et de tous les appareils qui lui sont connectés doivent être branchés sur des socles de prise de courant correctement câblés et mis à la terre.

Afin d'éviter tout risque de choc électrique provenant d'une différence de potentiel de terre, n'utilisez qu'une main, lorsque cela est possible, pour connecter ou déconnecter les cordons d'interface.

Le courant électrique passant dans les câbles de communication, ou les cordons téléphoniques et d'alimentation peut être dangereux. Pour éviter tout risque de choc électrique, lorsque vous installez ou que vous déplacez le présent produit ou des périphériques qui lui sont raccordés, reportez-vous aux instructions ci-dessous pour connecter et déconnecter les différents cordons.

Connexion	Déconnexion
1. Mettez les unités hors tension.	1. Mettez les unités hors tension.
2. Commencez par brancher tous les cordons sur les unités.	2. Commencez pas débrancher les cordons alimentation des socles de prise de courant.
3. Branchez les câbles d'interface sur les prises.	3. Débranchez les câbles d'interface des prises.
4. Branchez les cordons d'alimentation sur un socle de prise de courant.	4. Débranchez tous les câbles des unités.
5. Mettez les unités sous tension.	



**attention:**

Remplacez la pile usagée par une pile de référence identique exclusivement - voir la référence IBM - ou par une pile équivalente recommandée par le fabricant. Si votre système est doté d'un module contenant une pile au lithium, vous devez le remplacer uniquement par un module identique, produit par le même fabricant. La pile contient du lithium et présente donc un risque d'explosion en cas de mauvaise manipulation ou utilisation.

- Ne la jetez pas à l'eau.
- Ne l'exposez pas à une température supérieure à 100°C.
- Ne cherchez pas à la réparer ou à la démonter.

Pour la mise au rebut, reportez-vous à la réglementation en vigueur.



**attention:**

Si une unité de CD-ROM est installée, prenez connaissance des informations suivantes :

Pour éviter tout risque d'exposition au rayon laser, respectez les consignes de réglage et d'utilisation des commandes, ainsi que les procédures décrites dans le présent document.

Pour éviter une exposition directe au rayon laser, n'ouvrez pas l'unité de CD-ROM. Vous ne pouvez effectuer aucune opération de maintenance à l'intérieur.



**DANGER**

Certaines unités de CD-ROM contiennent une diode laser de classe 3A ou 3B. Prenez connaissance des informations suivantes :

Rayonnement laser lorsque le carter est ouvert. Évitez de regarder fixement le faisceau ou de l'observer à l'aide d'instruments optiques. Évitez une exposition directe au rayon.



≥32 Kg    ≥55Kg

attention:

Ce produit pèse un poids considérable. Faites-vous aider pour le soulever.



Le courant électrique circulant dans les câbles de communication et les cordons téléphoniques et d'alimentation peut être dangereux. Pour votre sécurité et celle de l'équipement, avant de retirer les carters, mettez celui-ci hors tension et déconnectez ses cordons d'alimentation, ainsi que les câbles qui le relient aux réseaux, aux systèmes de télécommunication et aux modems (sauf instruction contraire mentionnée dans les procédures d'installation et de configuration).



#### **VORSICHT**

Aus Sicherheitsgründen bei Gewitter an diesem Gerät keine Kabel anschließen oder lösen. Ferner keine Installations-, Wartungs- oder Rekonfigurationsarbeiten durchführen.

Aus Sicherheitsgründen:

- Gerät nur an eine Schutzkontaktsteckdose mit ordnungsgemäß geerdetem Schutzkontakt anschließen.
- Alle angeschlossenen Geräte ebenfalls an Schutzkontaktsteckdosen mit ordnungsgemäß geerdetem Schutzkontakt anschließen.

Signalkabel möglichst einhändig anschließen oder lösen, um einen Stromschlag durch Berühren von Oberflächen mit unterschiedlichem elektrischem Potential zu vermeiden.

Elektrische Spannungen von Netz-, Telefon- und Datenübertragungsleitungen sind gefährlich. Um einen Stromschlag zu vermeiden, nur nach den Anweisungen arbeiten, die für Installation, Transport oder Öffnen von Gehäusen dieses Produkts oder angeschlossenen Einheiten gelten.

<b>Kabel anschließen</b>	<b>Kabel lösen</b>
1. Alle Geräte ausschalten und Netzstecker ziehen.	1. Alle Geräte ausschalten.
2. Zuerst alle Kabel an Einheiten anschließen.	2. Zuerst Netzstecker von Steckdose lösen.
3. Signalkabel an Anschlußbuchsen anschließen.	3. Signalkabel von Anschlußbuchsen lösen.
4. Netzstecker an Steckdose anschließen.	4. Alle Kabel von Einheiten lösen.
5. Gerät einschalten.	



**achtung:**

Eine verbrauchte Batterie nur durch eine Batterie mit der IBM Teilenummer 33F8354 oder durch eine vom Hersteller empfohlene Batterie ersetzen. Wenn Ihr System ein Modul mit einer Lithium-Batterie enthält, ersetzen Sie es immer mit dem selben Modultyp vom selben Hersteller. Die Batterie enthält Lithium und kann bei unsachgemäßer Verwendung, Handhabung oder Entsorgung explodieren.

**Die Batterie nicht**

- mit Wasser in Berührung bringen.
- über 100 C erhitzen.
- reparieren oder zerlegen.

Die örtlichen Bestimmungen für die Entsorgung von Sondermüll beachten.





**achtung:**

**Wenn ein CD-ROM-Laufwerk installiert ist, beachten Sie folgendes. Steuer- und Einstellelemente sowie Verfahren nur entsprechend den Anweisungen im vorliegenden Handbuch einsetzen. Andernfalls kann gefährliche Laserstrahlung auftreten.**

**Das Entfernen der Abdeckungen des CD-ROM-Laufwerks kann zu gefährlicher Laserstrahlung führen. Es befinden sich keine Teile innerhalb des CD-ROM-Laufwerks, die vom Benutzer gewartet werden müssen. Die Verkleidung des CD-ROM-Laufwerks nicht öffnen.**

## VORSICHT

Manche CD-ROM-Laufwerke enthalten eine eingebaute Laserdiode der Klasse 3A oder 3B. Die nachfolgend aufgeführten Punkte beachten.

Laserstrahlung bei geöffneter Tür. Niemals direkt in den Laserstrahl sehen, nicht direkt mit optischen Instrumenten betrachten und den Strahlungsbereich meiden.



≥32 Kg    ≥55Kg

### achtung:

Beim Anheben der Maschine die vorgeschriebenen Sicherheitsbestimmungen beachten.



### achtung:

An Netz-, Telefon- und Datenleitungen können gefährliche elektrische Spannungen anliegen. Um eine Gefährdung des Benutzers oder Beschädigung des Geräts zu vermeiden, ist der Server auszuschalten. Die Verbindung zu den angeschlossenen Netzkabeln, Telekommunikationssystemen, Netzwerken und Modems ist vor dem Öffnen des Servergehäuses zu unterbrechen (in Installations- und Konfigurationsanweisungen nicht anders angegeben).



**PERICOLO**

Per evitare il pericolo di scosse elettriche durante i temporali, non collegare o scollegare cavi, non effettuare l'installazione, la manutenzione o la riconfigurazione di questo prodotto.

Per evitare il pericolo di scosse elettriche:

- collegare il cavo di alimentazione ad una presa elettrica correttamente cablata e munita di terra di sicurezza;
- collegare qualsiasi apparecchiatura collegata a questo prodotto ad una presa elettrica correttamente cablata e munita di terra di sicurezza.

Quando possibile, collegare o scollegare i cavi di segnale con una sola mano per evitare il rischio di scosse derivanti dal contatto con due superfici a diverso potenziale elettrico.

La corrente elettrica circolante nei cavi di alimentazione, del telefono e di segnale è pericolosa. Per evitare scosse elettriche, collegare e scollegare i cavi come descritto quando si effettuano l'installazione, la rimozione o l'apertura dei coperchi di questo prodotto o durante il collegamento delle unità.

Per collegare	Per scollegare
1. SPEGNERE tutti i dispositivi.	1. SPEGNERE tutti i dispositivi.
2. Collegare prima tutti i cavi alle unità.	2. Rimuovere prima il(i) cavo(i) di alimentazione dalla presa elettrica.
3. Collegare i cavi di segnale alle prese.	3. Rimuovere i cavi di segnale dalle prese.
4. Collegare il(i) cavo(i) di alimentazione alla presa elettrica.	4. Rimuovere tutti i cavi dalle unità.
5. ACCENDERE le unità.	



**ATTENZIONE:**

Quando si sostituisce la batteria, utilizzare solo una batteria IBM o batterie dello stesso tipo o di tipo equivalente consigliate dal produttore. Se il sistema di cui si dispone è provvisto di un modulo contenente una batteria al litio, sostituire tale batteria solo con un tipo di modulo uguale a quello fornito dal produttore. La batteria contiene litio e può esplodere se utilizzata, maneggiata o smaltita impropriamente.

*Evitare di:*

- Gettarla o immergerla in acqua
- Riscaldarla ad una temperatura superiore ai 100°C
- Cercare di ripararla o smaltirla

Smaltire secondo la normativa in vigore (D.Lgs 22 del 5/2/97) e successive disposizioni nazionali e locali.



**ATTENZIONE:**

Quando è installata un'unità CD-ROM, notare quanto segue:

L'utilizzo di controlli, regolazioni o l'esecuzione di procedure non descritti nel presente manuale possono provocare l'esposizione a radiazioni pericolose.

L'apertura di un'unità CD-ROM può determinare l'esposizione a radiazioni laser pericolose. All'interno dell'unità CD-ROM non vi sono parti su cui effettuare l'assistenza tecnica. Non rimuovere i coperchi dell'unità CD-ROM.

**PERICOLO**

Alcune unità CD-ROM contengono all'interno un diodo laser di Classe 3A o Classe 3B. Prestare attenzione a quanto segue:

Aperto l'unità vengono emesse radiazioni laser. Non fissare il fascio, non guardarlo direttamente con strumenti ottici ed evitare l'esposizione diretta al fascio.



≥32 Kg    ≥55Kg

**ATTENZIONE:**

Durante il sollevamento della macchina seguire delle norme di di sicurezza.



**ATTENZIONE:**

La corrente circolante nei cavi di alimentazione, del telefono e di segnale è pericolosa. Per evitare situazioni pericolose per le persone o danneggiamenti all'apparecchiatura, scollegare i cavi di alimentazione, i sistemi di telecomunicazioni, le reti e ed i modem prima di aprire i coperchi se non diversamente indicato nelle procedure di installazione e configurazione.



위험

전기 충격을 피하려면 날씨가 나쁠 때(예: 눈 또는 비가 오거나 천둥 번개가 칠 때)는 케이블을 연결하거나 끊지 않도록 하고 이 제품의 설치, 유지보수 또는 재구성 등의 작업을 수행하지 않도록 하십시오.

전기 충격을 피하려면 다음과 같아야 합니다.

- 고압선은 적절한 배선 및 접지 상태의 콘센트로 연결되어야 합니다.
- 이 제품이 접속될 모든 장비도 적절한 배서 상태의 콘센트로 연결되어야 합니다.

다른 전위를 가진 두 표면을 만졌을 때 발생할 수 있는 전기 충격을 피하려면 한 손으로 신호선을 연결하거나 끊으십시오.

전원, 전화 및 통신 케이블로부터 흘러 나오는 전류는 위험합니다. 전기 충격을 피하려면 이 제품이나 접속 장치를 설치, 이동 및 덮개를 열 때 다음 설명에 따라 케이블을 연결하고 끊도록 하십시오.

연결하려면

1. 모든 스위치를 켜다.
2. 먼저 모든 케이블을 장치에 연결한다.
3. 신호선을 콘센트에 연결한다.
4. 전원을 콘센트에 연결한다.
5. 장치 스위치를 켜다.

연결해제하려면

1. 모든 스위치를 끈다.
2. 먼저 모든 케이블을 장치에 제거한다.
3. 신호선을 콘센트에서 제거한다.
4. 장치에서 모든 케이블을 제거한다.

경고문 2



주의:

배터리를 교체할 때는 IBM 부품 번호 &PN. 또는 제조업체에서 추천하는 동등한 유형의 배터리를 사용하십시오. 시스템에 리튬 배터리를 포함하는 모듈이 있으면 이것은 동일한 제조업체에서 생산된 동일한 모듈 유형으로만 교체하십시오. 배터리에 리튬이 포함되어 있으므로 제대로 사용, 처리 또는 처분하지 않으면 폭발할 수 있습니다.

다음은 주의하십시오.

- 먼지거나 물에 담그지 않도록 하십시오.
- 100°C(212°F) 이상으로 가열하지 않도록 하십시오.
- 수리하거나 분해하지 않도록 하십시오.

지역 법령이나 규정의 요구에 따라 배터리를 처분하십시오.

경고문 3



주의:

CD-ROM 드라이브가 설치되어 있으면 다음 사항을 명심하십시오.

여기에서 지정하지 않은 방식으로 CD-ROM 드라이브를 제어 또는 조절하거나 다른 절차로 사용하면 위험한 방사능 노출이 발생할 수 있습니다.

CD-ROM 드라이브의 덮개를 제거하면 위험한 레이저 방사능이 노출될 수 있습니다. CD-ROM 드라이브 내에는 정비할 수 있는 부품이 없습니다. CD-ROM 드라이브 덮개를 제거하지 않도록 하십시오.

경고문 4

위험

일부 CD-ROM 드라이브에는 클래스 3A 또는 3B 레이저 2급 진공관(다이오드)이 들어 있습니다. 다음 사항을 명심하십시오.

열면 레이저 방사능이 노출됩니다. 광선을 주시하거나 광학 기계를 직접 쳐다보지 않도록 하고 광선에 노출되지 않도록 하십시오.

경고문 5



32kg(70.5 파운드)



55kg(121.2 파운드)

주의:

기계를 들 때는 안전하게 들어 올리십시오.

경고문 10



주의:

전원, 전화 및 통신 케이블로부터 흘러 나오는 전류는 위험합니다. 설치 및 구성 절차에 다른 지시가 없으면, 다치거나 장비 손상이 생기지 않게 하기 위해 서버 덮개를 열기 전에 접속된 전선, 원격 통신 시스템, 네트워크 및 모뎀의 연결을 끊으십시오.





**PELIGRO**

Para evitar una posible descarga eléctrica, no conecte ni desconecte los cables ni lleve a cabo ninguna operación de instalación, de mantenimiento o de reconfiguración de este producto durante una tormenta eléctrica.

Para evitar una posible descarga:

- El cable de alimentación debe conectarse a un receptáculo con una instalación eléctrica correcta y con toma de tierra.
- Los aparatos a los que se conecte este producto también deben estar conectados a receptáculos con la debida instalación eléctrica.

Cuando sea posible, utilice una sola mano para conectar o desconectar los cables de señal a fin de evitar una posible descarga al tocar dos superficies con distinto potencial eléctrico.

La corriente eléctrica de los cables de comunicaciones, teléfono y alimentación puede resultar peligrosa. Para evitar una posible descarga, siga las indicaciones de conexión y desconexión de los cables siempre que tenga que instalar, mover o abrir las cubiertas de este producto o de los dispositivos acoplados.

Instrucciones de conexión	Instrucciones de desconexión
1. Apague todos los componentes (OFF).	1. Encienda todos los componentes (ON).
2. En primer lugar, conecte todos los cables a los dispositivos.	2. En primer lugar, retire los cables de alimentación de las tomas.
3. Conecte los cables de señal a los receptáculos.	3. Retire los cables de señal de los receptáculos.
4. Conecte los cables de alimentación a las tomas.	4. Retire todos los cables de los dispositivos.
5. Encienda el dispositivo (ON).	



caution:

Al cambiar la batería, utilice únicamente la batería IBM Número de pieza 33F8354 o un tipo de batería equivalente recomendado por el fabricante. Si el sistema tiene un módulo que contiene una batería de litio, sustitúyalo únicamente por el mismo tipo de módulo del mismo fabricante. La batería contiene litio y puede explotar si no se utiliza, manipula o desecha correctamente.

*Lo que no debe hacer*

- Tirar o sumergir el producto en agua.
- Exponer el producto a una temperatura superior a 100°C.
- Reparar o desmontar el producto.

Cuando quiera desechar la batería, siga las disposiciones y reglamentaciones locales.



caution:

Cuando instale una unidad de CD-ROM, tenga en cuenta la siguiente información.

Si se llevan a cabo controles o ajustes o se utilizan métodos que no se atengan a lo aquí especificado, se puede producir una exposición peligrosa a las radiaciones.

Si se retiran las cubiertas de la unidad de CD-ROM, se puede producir una peligrosa exposición a radiaciones de láser. Dentro de la unidad de CD-ROM no existen piezas reparables. No retire las cubiertas de la unidad de CD-ROM.

**PELIGRO**

Algunas unidades de CD-ROM tienen incorporado un diodo de láser de Clase 3A o de Clase 3B. Tenga en cuenta la siguiente información.

Cuando la unidad está abierta se generan emisiones de rayos láser. No dirija la mirada al haz, no lo observe directamente con instrumentos ópticos y evite la exposición directa.



≥32 Kg    ≥55Kg

**caution:**

Alce la máquina con cuidado; el sobrepeso podría causar alguna lesión.



**caution:**

La corriente eléctrica de los cables de comunicaciones, de teléfono y de alimentación puede resultar peligrosa. Para evitar posibles lesiones o daños del aparato, desconecte los cables de alimentación, los sistemas de telecomunicaciones, las redes y los módems antes de abrir las cubiertas del servidor, salvo que se indique lo contrario en las instrucciones de las operaciones de instalación y configuración.

### **Laser Compliance Statement**

The CD/DVD-ROM drive in the computer is a laser product. The CD/DVD-ROM drive's classification label (sample shown below) is located on the drive.

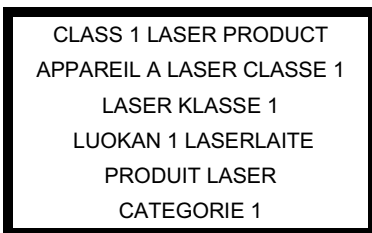

The CD/DVD-ROM drive is certified in the U.S. to conform to the requirements of the Department of Health and Human Services 21 Code of Federal Regulations (DHHS 21 CFR) Subchapter J for Class 1 laser products.

In other countries, the drive is certified to conform to the requirements of EN60825.

Class 1 laser products are not considered to be hazardous. The CD/DVD-ROM drive has an internal Class 1, 0.5-milliwatt, aluminum gallium-arsenide laser that operates at a wavelength of 760 to 810 nanometers.

The design of the laser system and the CD/DVD-ROM drive ensures that there is no exposure to laser radiation above a Class 1 level during normal operation, user maintenance, or servicing conditions.

## Trademarks

The following are trademarks of the IBM Corporation in the United States or other countries or both:

Operating System/2	OS/2
AT	Personal System/2
HelpCenter	PS/1
IBM	PS/2

Intel, Pentium, MMX, EtherExpress, and LANDesk are trademarks or registered trademarks of Intel Corporation. Microsoft, MS-DOS, Windows, and Windows NT are trademarks or registered trademarks of Microsoft Corporation. Other company, product, and service names may be trademarks or service marks of others.

---

## Preface

This manual contains service information for the **Service Level A (SL-A)** model of the IBM Personal Computer, worldwide.

This manual is intended to be used as a stand-alone document to service Machine type 2193, 2194, 2196, 2197, 6344 and 6345 product. It is divided into the following chapters:

**Notices** contains important safety information and notices required to service this computer.

**General Information** contains a brief description of this manual.

**Check Procedures** provide step-by-step instructions that aid in locating the failure Field Replaceable Unit (FRU).

**Diagnostic Aids** explain how to use the diagnostics tools for isolating failures.

**Repairing Information** contains illustrations and descriptions to disassemble and reassemble the computer.

**Parts/Test Point Locations** contains illustrations and descriptions of the locations of the major parts, jumpers, and connectors.

**Safety Inspection Guide** contains information about inspecting a machine for safety problems before putting the machine under a Maintenance Agreement.

**Parts Catalog** contains descriptions, illustrations, and part numbers for individual FRUs.

**Appendix A, FRU Number Index** contains part numbers listed in numerical order.

**Appendix B, Online Support Information** contains online support information.

**Index** contains specific terms and words in alphabetical order.

---

## General Information

<b>General Information .....</b>	<b>37</b>
Introduction .....	38
Product Overview .....	38
Hardware Interfaces .....	43
CMOS Reset .....	45
Flash (BIOS) Update Procedure .....	46
BIOS-contained Model Number and Serial Number .....	47
BIOS Setup Utility .....	48
Working with the Setup Menus .....	48
Start Options .....	50
Advanced Setup .....	52
Power Management Setup .....	56
ISA Legacy Resource .....	58
Set Password .....	58
Specifications .....	59
Operating Requirements .....	60
Special Tools .....	61

---

## Introduction

This chapter gives a general overview of the Machine Type 2193, 2194, 2196, 2197, 6344 and 6345, describes the standard and optional features, and details functional and environmental specifications. The machine type 2196, 2197 and 6344 are desktop models. The machine type 2193, 2194 and 6345 are micro tower models.

---

## Product Overview

All the machine type mentioned above contain three PCI slots, and the system board supports the AMD K6-2 processor and Intel Pentium III processors.

Listed below are system features:

### Processors (Machine Type 2193 and 2196)

- Processor with the capabilities of 3D Now™! technology
- Socket-7 Zero Insertion Force (ZIF) connector. You must remove the old processor to install an upgrade processor.
- Detachable CPU heat sink with fan.
- One of the following processors can be installed:
  - AMD K6-2 550 MHZ CPU with 3D Now™! technology
  - AMD K6-2 500 MHZ CPU with 3D Now™! Technology
  - AMD K6-2 533 MHZ CPU with 3D Now™! technology

### Processors (Machine Type 2194, 219, 6344 and 6345)

- Socket 370
- Detachable CPU heat sink with fan.
- One of the following processors:
  - Intel Celeron 533 MHZ CPU
  - Intel Celeron 500 MHZ CPU
  - Intel Celeron 600 MHZ CPU
  - Intel PIII 550 MHZ CPU
  - Intel PIII 600 MHZ CPU



- Intel PIII 667 MHZ CPU

### **Memory**

- 512-KB Pipeline Burst Static RAM (PBSRAM). Fixed onboard.
- 168-pin synchronous dynamic random access memory (SDRAM), dual inline memory module (DIMM) sockets.
  - 2 memory sockets.
  - 16-MB, 32-MB, 64-MB or 128-MB DIMM.
  - Maximum memory is 512MB.

### **External Ports**

- Video port (15-pin D-sub connector)
- Parallel port (25-pin D-sub connector)
- Serial port (9-pin D-sub connector)
- Game/MIDI port (15-pin D-sub connector)
- Keyboard port (6-pin PS/2 mini-din connector)
- Mouse port (6-pin PS/2 mini-din connector)
- Four USB ports  
For 2194, 6345 and 6344 (in the US, LA and Canada) systems will only have 2 USB ports
- 10/100 Mbps Ethernet port  
This setting is not supported in 2194 systems. For 6344 systems in the US, LA and Canada will use an Ethernet card.
- Digital Flat Panel port (only supported in some models)
- Microphone-in jack
- Line-out jack
- Line-in jack

### **Diskette Drive**

- AT-type
- 3.5-in. 1.44MB slimline diskette drive.

### **Hard Disk Drive**

- 3.5-in., 1-in. height IDE AT drive.
- 512 KB cache buffer in hard disk drive.
- Average and minimum 11.1 ms seek time, access time varies for the hard disk drive and the hard disk drive manufacturer.

### **CD-ROM Drive**

- 5.25-in. high-performance, 40X CD-ROM IDE/AT drive.
- Read data and play audio from standard and mini CD-ROM and audio compact discs (audio CDs).

### **Multimedia**

- One pair of internal speakers.

### **Power Management**

- Compliant to ACPI and supports display power management signaling (DPMS) monitor.
- Software shutdown by Windows 98.
- System enters standby mode if any of following conditions are met:
  - Execute standby from the Windows 98 Start menu
  - Press system power button if it is set to act as standby function. See "Power Management Setup" on page 56.
  - Standby timer set in the Windows 98 power utility timer elapses without system activity.
- Monitor enters standby mode if:
  - Windows 98 power utility timer elapses
  - System sleep timer elapses

### **Power Supply**

- 95-watt switchable high/low voltage power supply.
- Standard SFX power supply with +5V and +3.3V standby power

**Internal Cabling**

- 40-pin ribbon cable for CD-ROM and ATA-66 cable for hard disk drive.
- One 34-pin ribbon cable for AT diskette drive.
- One 4-pin (2-wire) cable for hard disk drive light-emitting diode (LED).
- One 3-pin (3-wire) cable for power light-emitting diode (LED).
- One 2-pin (2-wire) cable for power switch.
- One 16-pin game port cable.

**Modem**

- 56.6 Kbps PCI plug and play modem adapter card with data/fax features.
- Telephone line-out (RJ-11) connector (Not available for all models).
- Telephone line-in (RJ-11) connector.

**IBM Monitor**

- Super video graphics array (SVGA) monitor.
- Compliant to VESA power saving mode.
- Connector for a detachable grounded 3-wire power cord.
- 1.8-m (5.8-ft) attached signal cable.
- Auto-sensing power input for 100 V ac to 240 V ac.

**Keyboard**

- PS/2 104-key rubber dome IBM Keyboard with 1.8-m (5.8-ft) cable. Keyboard is Geography/Model dependent.

**Mouse**

- 2 button mouse connected to the mouse port with 1.8-m (5.8-ft) cable.

---

## Hardware Interfaces

The following peripheral interfaces for adapters, options, and drives are supported in the system unit.

Item	Interface
Expansion slot for I/O adapter cards	Three PCI (peripheral component interconnect) v2.1 compatible expansion slots that operate at 33 MHz bus speed. PCI slot 1 can hold a short (175mm) PCI adapter card. PCI slot 2 can hold a PCI adapter card measuring 165 mm in length (or less). PCI slot 3 can hold a PCI adapter card measuring 236 mm in length (or less). The desktop model (machine type 2196, 2197 and 6344) only support low profile PCI interface. (169mm)
Hard Disk Drives	Two PCI local bus Enhanced IDE v1.0 compatible hard disk drive interfaces that support PIO mode up to mode 4, DMA 32-bit access up to mode 2 and Ultra 33 Synchronous DMA up to mode 2 (33M bytes/sec).
CD/DVD-ROM Drive	5.25-in. high-performance, forty speed (40X) CD-ROM IDE/AT drive Support Bootable CD-ROM Format specification version 1.0. Compliant to Audio-CD, Video-CD, CD-ROM/XA, Karaoke-CD, and Photo-CD (both single and multi-session) format.
Diskette Drive	AT diskette interface
Video	Physical interface is compatible with the IBM Personal System/2 (PS/2) VGA interface. SiS540, SIS 630 and Intel 810e VGA on board.
Modem	One 56.6 Kbps PCI plug and play modem adapter card with data/fax features.(not standard in 6344 and 6345 systems)

Table 1-1 System Board Hardware Interfaces	
Item	Interface
Audio	For 2194 and 6345 systems, use ADI 1881 Codec. All other models use Cirrus Logic 4299 Codec.
Pointing device	IBM PS/2-compatible mouse
Keyboard device	IBM PS/2-compatible keyboard
Serial port	9-pin connector with RS232D electrical interface
Parallel port	Supports SPP (IBM PC/AT, PS/2) compatible, EPP (IEEE 1284 compliance), ECP (IEEE 1284 compliance) interface.
Game port	Game port interface for joystick. It also supports MIDI.
Ethernet Port	Only 2194 and some 2193 models do not have Ethernet on board
USB	USB controller integrated in core logic chip set.

---

**CMOS Reset**

This system does not deny access to BIOS Setup Utility. Execute "Load BIOS Default Settings" in BIOS Setup to clear the corrupted CMOS data. See "Loading the Default Settings" on page 49.

---

## Flash (BIOS) Update Procedure

**NOTE:** The flash update procedure does not change the model number and serial number information in BIOS.

1. Prepare a bootable DOS diskette with AWDFLASH.EXE and VXXYYZZ.BIN files

**NOTE:** The AWDFLASH.EXE is flash utility programs. The VXXYYZZ.BIN is a BIOS source code binary file.

2. Insert the diskette and boot from drive A.

**WARNING:** Do not boot with any memory related driver such as HIMEM.SYS, EMS.SYS ....

3. At the DOS prompt, type **A:> AWDFLASH VXXYYZZ.BIN** and then press **Enter**.

4. The screen shows: "Do You Want To Save Bios (Y/N)". Type **Y** if you want to save old bios data, and **N** if you do not.

5. When the screen shows: "Are You Sure To Program (y/n)", type **Y** to flash and update the system bios.

6. The program updates the BIOS automatically.

7. Wait for the update to complete.

**WARNING:** Do not turn off the system power while the BIOS is programming, or the flash ROM will be destroyed.

8. Press **F1** to Reset (or press **F10** to exit) the system after the BIOS is completely updated.

---

### BIOS-contained Model Number and Serial Number

The model number and serial number information is stored in BIOS ROM and displayed in the "Model Information" of BIOS Setup main menu. If a repair is completed by replacing the system board or installing a new BIOS ROM, then you need to enter the original system model number and serial number in the new BIOS ROM.

To enter the model number and serial number into BIOS:

1. Prepare a bootable DOS diskette with VPD.EXE files.
2. Insert the diskette and boot from drive A.

**WARNING:** Do not boot with any memory related driver such as HIMEM.SYS, EMS.SYS ....

3. At the DOS prompt, type **A:>VPD** then press **Enter**. You will be asked if you want to update the serial number, type **Y** to continue. When the screen shows:

Serial Number:

Enter the serial number and press **Enter** to continue. You can type a maximum of 7 characters (without spaces).

Follow the instructions on the screen to complete the procedure.

4. Type **A:>VPD** and press **Enter** to display and verify your input model number and serial number information.



---

## BIOS Setup Utility

The Setup Utility lets you review and change important information about the computer and its hardware.

### Working with the Setup Menus

#### Starting the Setup Utility

Follow these steps to enter Setup when the computer is off:

1. Turn on your monitor.
2. Turn on the system unit.
3. When you see the IBM logo, press **F1** to enter Setup and display the Main Menu.

Refer to the Setup Utility Main Menu below.

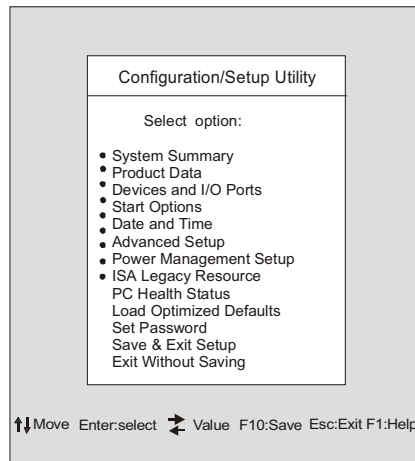

The following table lists specific keys on the keyboard that will help you move through the Setup menus:

<b>Keys</b>	<b>Function</b>
Down- or up-arrow key	Use these arrow keys to highlight an option on the menu. (Press the <b>Enter</b> key to choose the option.)
Left- or right-arrow key	Use these arrow keys to make a selection and change an option's setting. In some menus, you can use these keys to move from one field to another.
F1	Press this key if you want help for a selected item in a menu.
Esc	After viewing or making changes to the settings on a menu, press this key to exit the menu.
Enter	Press this key to choose a highlighted option from a menu.

### **Changing Parameter Settings**

In the Setup menus, the configuration information that you can change is enclosed in brackets like these: [ ]. You cannot change any information that is not enclosed in brackets. Use the up- or down-arrow keys to highlight options then press Enter to display a menu. When changing the setting of a particular parameter, highlight the setting then use the left- or right-arrow key to change the setting.

### **Loading the Default Settings (Setup Defaults)**

When you purchase an IBM personal computer, it is already configured for use. The original configuration settings, also called factory or default settings, are stored in the CMOS. Setup includes an option Load Optimized Default Settings that allows you to reload the original configuration at any time. If you have made changes in Setup but would like to restore the default settings, follow these steps:

1. From the main menu, highlight the option Load Optimized Default Settings then press **Enter**. A dialog box appears confirming if you want to load the default settings.
2. Type **Y** to select YES, then press **Enter**
3. Highlight the option **Save & Exit Setup**, then press **Enter**.
4. Type **Y** to select Yes, then press **Enter** to save the changes in CMOS.

You must load the Setup default settings in the following instances:

- When you replace the system battery
- When you customize your system configuration settings and some resource assignments conflict causing the computer to hang.

### **Exiting Setup (Save & Exit Setup/Exit Without Saving)**

Press Esc to return to the main menu when you have finished viewing settings and making changes. From this location, you can exit Setup and save your changes or exit without saving your changes.

Follow these steps to exit Setup:

1. From the main menu, press the **Esc** key.
2. The Exit Setup dialog box appears saying Quit Without Saving (Y/N) ? Type **Y** if you want to quit directly.

You also can Exit the Setup via highlighting the **Save & Exit Setup** option or **Exit without Saving** option and follow the dialog box directions.

### **Start Options**

Setup automatically updates this menu when you do either of the following:

- Add or change hardware on your computer
- Make changes to other menus in Setup and save those changes

To view the computer information such as the model number, serial number, and BIOS version and date, select the **Standard CMOS Setup** option from the Setup main menu. The items displayed are not configurable.

### **Virus Warning**

Determines if the BIOS will monitor the boot sector and partition table of the hard disk drive for any attempt at modification. If any attempt is made, the BIOS will halt the system and an error message will appear.

Afterwards, if necessary, you will be able to run an anti-virus program to locate and remove the problem before any damage is done.

### **Quick Power On Self Test**

Speeds up Power On Self Test (POST) after you power up the computer. If it is set to Enabled, BIOS will shorten or skip some check items during POST.

### **Swap Floppy Drive**

Determines if the swap floppy drive is enabled or not.

### **Boot Up Numlock Status**

Determines the default state of the numeric keypad. By default, the system boots up with NumLock on.

### **Gate A 20 Option**

This setting allows you to select how the gate A20 is handled. Initially, the gate A20 was handled via a pin on the keyboard. Today, the system chipset provide more common and much faster support than keyboards.

### **Typematic Rate Setting**

Determines if the typematic rate is to be used. When disabled, continually holding down a key on your keyboard generates only one instance. In other words, the BIOS will only report that the key is down. When the typematic rate is enabled, the BIOS will report as before, but will wait a moment. If the key is still down, it will report that the key has been depressed repeatedly. You might use this feature to accelerate cursor movements with the arrow keys.

### **Typematic Rate (Chars/Sec)**

When the typematic rate is enabled, you can select the rate at which the keys are accelerated.

### **Typematic Delay (Msec)**

When the typematic rate is enabled, you can select the delay between when the key was first depressed and when the acceleration begins.

### **Security Option**

Determines the access limitation to the system and Setup, or just Setup.

### **Report No Diskette Drive for Win 95**

Select **YES** to release IRQ6 (Interrupt Request) when the system contains no floppy drive for compatibility with Windows 95 logo certification. Also select **Disabled** for the Onboard FDC Control Field in the **Devices and I/O Ports** menu.

### **Halt on**

Determines under what conditions the power-on self test (POST) will halt when errors are detected.

### **Date and Time**

Allows you to set date and time.

### **Advanced Setup**

You can set up some advanced hardware features in this function. If they are configured incorrectly, the system might malfunction.

### **Cache Control**

Determines the internal cache and external cache will be enabled or disabled. If enabled, the memory access will speed up.

## **ROM Shadowing**

- **Video BIOS Shadowing** option determines whether video BIOS will be copied to RAM. However, it is optional depending on chipset design. Video Shadow will increase the video speed.
- **C8000- DFFF Shadowing** option determines if the option ROMs will be copied to RAM.

## **Devices and I/O ports**

The options in this menu item are used to configure the devices and the I/O ports that this system has.

### **Diskette Drive A**

Determines the type of Diskette Drive A.

### **PS/2 Mouse Function**

Determines the mouse function is enabled or disabled.

### **On Board Audio**

Determine the on board Audio function to be enabled or disabled.

### **On Board LAN**

Determines the on board LAN function to be enabled or disabled.

### **Serial Port Setup**

Determines the I/O port address and Interrupt Request Number of serial port.

### **Parallel Port Setup**

Determines the I/O port address and Interrupt Request Number of parallel port.

### **USB Setup**

The options in this menu item are used to enable the USB (Universal Serial Bus) functions.

#### **USB Controller**

Select **enabled** if you will use USB device.

#### **USB Keyboard Support**

Select **enabled** to use a USB keyboard. Also the USB Controller must be set to **enabled**.

### **IDE Drives Setup**

#### **PIO (Programmed Input/Output)**

IDE device driver controllers can support up to two separate drives. These drives have a master/slave relationship which is determined by the cabling configuration used to attach them to the controller.

PIO means Programmed Input/Output. Rather than have the BIOS issue a series of commands to effect a transfer to or from the disk drive, PIO allows the BIOS to tell the controller what it wants and then let the controller and the CPU perform the complete task by themselves. This is simpler and more efficient.

Your system supports five modes, numbered from 0 to 4, which primarily differ in timing. When Auto(default) is selected, the BIOS will select the best available mode. This is true for the next four setup items:

1. IDE Primary Master PIO
2. IDE Primary Slave PIO
3. IDE Secondary Master PIO
4. IDE Secondary Slave PIO

**Ultra DMA (Direct Memory Access)**

This setting allows you to speed up data transfer between the IDE devices and your system. Select the **Auto** option to enable it or select disabled to disable it.

**IDE Burst Mode**

Determines the acceleration of data transfer for IDE devices.

**IDE Data Port Post write**

Determines the data transfer in the manner of "post write" feature.

**IDE HDD Block Mode**

Determines the automatic detection of the optimal number of block.

**Video Setup**

Select this menu item to modify the video settings.

**System Shared Memory Size**

Determines whether 2MB, 4MB, 8MB, 16MB, 32MB, or 64MB of system memory is to be used by video.

**Init Display First**

Specify which video subsystem to initialize first.

**PS/2 Mouse Detect Function**

Determines whether the power-on self test will check to see if a mouse is attached to the mouse connector.



**Onboard FDD Control**

Allows you to enable or disable the diskette drive (floppy disk drive) controller.

**Game Port Address**

Determines the game port I/O address.

**Midi Port Address**

Determines the game port I/O address.

**Midi Port Address**

Determines the midi port IRQ (Interrupt Request) number.

**Power Management Setup**

The Power Management Setup allows you to configure your system to most effectively save energy while operating in a manner consistent with your own style of computer use.

**APM****Video Off Option**

Determines the video off function for power management.

**Video off Method**

Determines the manner in which the Monitor is blanked.

**Activity Monitor****MODEM Use IRQ**

Allows you to select the IRQ to be used by the modem.

**HDD Port Activity**

When set to enabled, any activity taking place at the hard disk or diskette drive will awaken the computer from a powered-down/stndby state.

**COM Port Activity**

When set to enabled, any activity taking place at any of the COM ports (serial ports or modem) will awaken the computer from a powered-down/stndby state.

**LPT Port Activity**

When set to enabled, any activity taking place at the parallel port will awaken the computer from a powered-down/stndby state.

**Automatic Power On**

Define automated method of waking up the computer.

**ACPI Suspend Type**

Determines the suspend type.

**PCI/VGA Palette Snoop**

Determines whether the MPEGISA/VESA VGA Cards can work with PCI/VGA or not.

**ISA Legacy Resource**

ISA legacy resources (DMA, Interrupts, Memory) are resources that used by ISA adapters which are not Plug-and-Play adapters. Don't use this setting due to the computer only support pci adapter cards.

**CLOCK Generator Configuration**

This setting allows you to change the clock rate of CPU, SDRAM, DIMM and PCI bus.

**Set Password**

In this option, you can set up a password to restrict access to the Setup Utility or to your System. You can also change or remove the password.

If you set up a password for entering setup, you must type this password each time you want to enter the Setup utility. If you do not type the correct password, you cannot enter Setup.

If you set up a system password, you must type this password each time you power on your system.

---

## Specifications

### Dimensions (width x depth x height):

- System unit:
  - For machine type 2193, 2194 and 6345:
    - 190 mm (7.48 in.) x 370 mm (14.57 in.) x 380 mm (14.96 in.)
  - For machine type 2196, 2197 and 6344:
    - 305 mm (12.45 in.) x 380.4 mm (14.97 in.) x 88 mm (3.46 in.)

### Weight:

- System unit:
  - For machine type 2193, 2194 and 6345:
    - 9.2 kg (20.26 lb)
  - For machine type 2196, 2197 and 6344:
    - 8.5 kg (18.72 lb)

### Environment:

- Temperature for system unit:
  - Power on: 10° to 35°C (50° to 95°F)
  - Power off: -20° to 60°C (14° to 140°F)
- Humidity for system unit:
  - Power on: 8% to 80%
  - Power off: 8% to 80%
- Altitude for system unit:
  - 7,000 feet

### Power consumption:

- System unit:
  - Maximum: 95-watts

### Electrical input:

- Input voltage for system unit (Sine-wave input is required) :
  - Low Range: 100 V ac to 127 V ac
  - High Range: 200 V ac to 240 V ac

---

## **Operating Requirements**

All machines require two power inputs: one on the system unit and one on the monitor display.

The system unit comes with a voltage selector switch, allowing selection of either 115 V ac or 230 V ac. This switch must be in the 230 V ac position when the machine is plugged into a 230 V ac electrical outlet.

---

**Special Tools**

The following special tool is required to service this system when running the diagnostics program (PC-Doctor):

- Wrap plug, P/N 72X854

---

## CheckProcedures

<b>Check Procedures</b> .....	<b>62</b>
Introduction .....	63
Start .....	64
Index of Symptoms, Messages, Error Codes, or Beeps....	69
Troubleshooting .....	84
Factory-Installed Storage Devices.....	85
Factory-Installed Modem Card .....	87
Audio (Not Supported by Diagnostics Program) .....	89
CD-ROM Drive.....	91
Memory.....	92
Keyboard .....	92
Mouse.....	93
Power Supply.....	96
Monitor.....	99
Undetermined Problems .....	101

## Introduction

This chapter contains the check procedures used to diagnose the causes of product failures. The diagnostic information consists of:

**Start:** This is the starting point for any diagnostic action. Based on high-level symptoms, the check procedure directs you to more detailed procedures to help resolve machine failures.

**Index of Symptoms, Messages, Error Codes, or Beeps:** The tables for BIOS Error Messages, Codes, Beeps, and Error Symptoms list symptoms along with their probable causes, and direct you to the applicable check procedures to help resolve machine failures. These tables also list the field replaceable units (FRUs) most likely to cause a particular problem.

**Check Procedures:** When the Start check procedure or the Index of Symptoms, Messages, Error Codes, or Beeps tables point you to a specific check procedure, proceed to that section. If there are any notes or instructions at the top of the page, read them before you begin with the procedure. Carefully read each step of the check procedure and perform the steps as instructed. If you do not remember the location of a specific part or test point, or an adjustment or removal procedure, see the chapter that contains that information. Always return to the check procedure after you do this. In some cases, you are referred to other check procedures to detect the cause of the failure.



---

## Start

This is the entry point for all check procedures. The check procedures use failure symptoms, Power-On Self Test (POST) error codes, or beeps to help determine the defective field replaceable unit (FRU). Follow the suggested check procedures or use the diagnostics diskette to determine the problem FRU.

**IMPORTANT:** Replace FRUs ONLY when it is determined that the error is not a result of software, loose contacts, or dirty component surfaces. Any FRU change should be verified by running a complete test (**Diagnostics - All Tests** in PC-Doctor diagnostics program).

This book comes with a diagnostic program diskette. This diskette should be used ONLY with **Machine Type 2193, 2194, 2196, 2197, 6344 and 6345**. Do not use this diskette on other models.

POST error codes and error messages are displayed on the screen after the IBM logo. A beep will precede each error code or message. Please refer to "Index of Symptoms, Messages, Error Codes, or Beeps" on page 69 for additional help.

All voltages in the check procedures are positive unless otherwise indicated. Use frame ground for all voltage checks unless otherwise specified.

**IMPORTANT:** There is a voltage selector on the rear panel of the machine. Use a flat-head screwdriver to turn the voltage selector to the voltage setting for the area in which you will be using the system.

**NOTE:** If the check procedures instruct you to replace a FRU and the error message persists, an option adapter card might be causing the failure. Remove all option adapter cards, one at a time, until the error changes or the problem is no longer apparent. The problem may be in the last card that you removed or something associated with it.

The Recovery CD contains pre-loaded software that may reinstall the original software and recover the system. Ensure data and programs of the hard drive have a backup copy.

**How to Diagnose Combined FRUs:** If an adapter or device consists of more than one FRU, any of the FRUs might cause an error code. Before replacing the device or adapter, remove the FRUs one by one to see if the symptoms change.

**If a newly replaced FRU does not correct the problem:** If you have reached this point of the check procedures and were instructed to replace a FRU but doing so did not correct the problem, reinstall the original FRU and go through "Start" again.

If you want to print a copy of a BIOS Setup Utility screen to an attached printer, press **Print Screen** key, while the screen is displayed.

**PLEASE READ THE FOLLOWING:**

**Human Error is a cause for concern when applied to check procedures. It exists in every first time set of analysis procedures. It is therefore essential for effective and time-efficient servicing that each stage of every procedure be verified. (For example: When a symptom is found, or when a symptom appears to have been cured; the preceding steps should be repeated for accuracy of analysis.)**

**001 - START**

To begin, note the following:

- Disable the setting of "Quick Power-On Self Test" from BIOS Setup.
- Disconnect all external cables and devices including speakers and microphone from the system unit, except for the keyboard, mouse, and monitor.
- Power off the system unit before moving it or when replacing FRUs.
- Remove all adapter cards, except for the factory-installed modem adapter card and any other IBM factory-installed adapter cards.
- Disconnect any drives except:
  - 3.5-in. diskette drive
  - Hard disk drive
  - Factory-installed devices (such as a CD-ROM drive)
- Make sure that all power cords and cables are connected properly.
- Make sure that the monitor brightness and contrast controls are not turned down.
- Power on the system unit.

**NOTE:** Some monitors have a detachable system I/O signal cable between the monitor and the system unit. In this case, check this signal cable before replacing the unit. See "Monitor Port Signals" on page 164 for pin identification.

- Make sure that the monitor refresh rate is correct.
- Note any symptoms, messages, error codes, or beeps.
- Make sure that there are no diskettes or CDs in the drives.

**002 - DOES AN IBM LOGO SCREEN APPEAR? (YES, READ AHEAD. NO, GO TO STEP 004.)**

- Insert the diagnostics diskette in the diskette drive.

**003 - DOES SYSTEM LOAD THE DIAGNOSTICS PROGRAM FROM THE DISKETTE DRIVE? (YES, READ AHEAD. NO, GO TO STEP 004.)**

- Follow the instructions on the screen and select **Utility** from the diagnostics program menu.
- Select **Tech Support Form** from the menu, press F5 to execute, then generate a system configuration report.
- Compare the system configuration list with the actual devices installed in system.

**NOTE:** If necessary, remove the machine cover and visually compare the devices installed in system to those shown in the system configuration report.

- Go to step 006.

**004 - DO ANY MESSAGES, ERROR CODES, OR SYMPTOMS APPEAR? (YES, READ AHEAD. NO, GO TO STEP 005)**

- Go to "Index of Symptoms, Messages, Error Codes, or Beeps" on page 69.
- End.

**005 -**

- If the keyboard responds incorrectly, go to "Keyboard" on page 92.

**006 - DOES THE SYSTEM CONFIGURATION REPORT CORRECTLY IDENTIFY THE DEVICES INSTALLED IN SYSTEM? (YES, READ AHEAD. NO, GO TO STEP 007.)**

- Select **Diagnostics** from the diagnostics program menu.
- Select and execute **All Tests**.
- Go to step 008.

**007 -**

The system configuration report shows only those devices supported by the diagnostics diskette.

If a device is missing from the list and is not factory installed, refer to the service manual provided for that device.

**008 - DOES THE DIAGNOSTICS FINISH WITHOUT ANY ERRORS? (YES, READ AHEAD. NO, GO TO STEP 009.)**

- If the **Diagnostics \ All Tests** did not detect a failure but the system still indicates a failure:
- Check all adapter card jumper settings.
- Check all adapter cards switch settings.
- Check all adapter card cables and connectors.
- Make sure that all of the above are set correctly and show the correct voltages and continuity. Replace any defective cables or adapter cards. See "Power Supply Cable Connector Specifications" on page 157 and the layout of system board according to the machine type in chapter 5.
- Run the **Diagnostics \ All Tests** again.
- If an error or other symptom is displayed, go to "Index of Symptoms, Messages, Error Codes, or Beeps" on page 69.
- If no error can be detected or the symptom is intermittent, go to "Undetermined Problems" on page 101.
- End

**009 -**

- If the last test stops and you cannot continue, first make sure all switches, power connectors, cables, and jumpers are set correctly and show the correct voltages and continuity.
- Take note of any messages, error codes, beeps, or new symptoms. Go to "Index of Symptoms, Messages, Error Codes, or Beeps" on page 69.
- If there is no error symptom or the error symptom is intermittent, go to "Undetermined Problems" on page 101.

---

## Index of Symptoms, Messages, Error Codes, or Beeps

**How to Use Error Messages:** Use the messages, error codes, and beeps combinations that occur to diagnose failures. If more than one failure occurs, diagnose from the first failure that appears. The cause of the first failure can result in false messages, error codes, or beeps. If you did not receive any messages, error codes, or beeps, see if the symptom is listed in Table 2-3, "Error Symptoms List" on page 76.

**ATTENTION:** When you have replaced a FRU, you must run the diagnostics to ensure that no other activity has been affected by the change. This system check can be done through the diagnostics program (Select **Diagnostics**, then select and execute **All Tests** from PC-Doctor).

**POST:** Some diagnostic aids are resident in the machine, such as the Power-On Self Test (POST). The machine performs the POST each time it is powered on. Use this information throughout the diagnostic procedures. The POST is a series of system checks and initializations that verify the correct operation of the base system.

After a successful POST, the system attempts to load operating system. The system can be customized for different startup (boot) methods by the BIOS Setup Utility. See "Advanced Setup" on page 52.

The system's default startup sequence automatically looks for the operating system files in the hard disk if these files are not found in the diskette.

**NOTE:** Remember that POST does not test all areas, but only those that allow the system to operate well enough to run the diagnostics program.

Table 2-1 lists BIOS error codes, messages, and beeps to their possible causes, table 2-3 lists error symptoms and their possible causes. The most likely cause is listed first. Make sure you complete all items in the cause or "Action/FRU" column. When servicing a system, always begin with "Start" on page 64.

If the problem cannot be corrected using these two index tables, go to "Undetermined Problems" on page 101.

**NOTES:**

If an error message and incorrect audio response occur, diagnose the error message first.

If you cannot run the diagnostics program tests but did receive a POST error code, diagnose the POST error message.

If you did not receive any error message, look for a description of your error symptoms in "Error Symptoms List" in page 76.

Check all power supply voltages, switch, and jumper settings before you replace the system board. Also check the power supply voltages if you have a "system no-power" condition. ("Power Supply Cable Connector Specifications" on page 157 and "Layout of System Board of the Machine Type" on page 141.)

If the problem cannot be corrected by using the "BIOS Error Codes, Messages, And Beeps List" table and "Error Symptoms List" table, go to "Undetermined Problems" on page 101.

<b>BIOS Error Codes, Messages, beeps</b>	<b>Action/FRU</b>
<b>NOTE:</b> To diagnose a problem, first find the BIOS error messages, codes, or beeps in left column. If directed to a check procedure, replace the FRU indicated in the check procedure. If no check procedure is indicated, the first Action/FRU listed in right column is the most likely cause.	
<b>POST Error Codes and Messages</b>	
161 CMOS battery failed	Load default settings in Setup and reboot the system. CMOS battery. System board.
162 CMOS checksum error	Make sure the equipment (diskette drive, hard disk drive, keyboard, mouse, etc.) are connected properly and are set correctly in BIOS Setup. Load default settings in setup. CMOS battery should be replaced. System board.
164 Memory size error	Make sure the DIMMs are inserted properly. System board.

Table 2-1 BIOS Error Codes, Messages, and Beeps List

BIOS Error Codes, Messages, beeps	Action/FRU
<p><b>NOTE:</b> To diagnose a problem, first find the BIOS error messages, codes, or beeps in left column. If directed to a check procedure, replace the FRU indicated in the check procedure. If no check procedure is indicated, the first Action/FRU listed in right column is the most likely cause.</p>	
<p>201 Memory test failure.</p>	<p>Insert the memory modules in the DIMM sockets properly, and then reboot the system.</p> <p>Memory module. See the "Step 005" of "Memory" on page 92 to replace memory module.</p> <p>System board.</p>
<p>301 Keyboard error or no keyboard present.</p>	<p>Make sure the keyboard is connected properly and are set correctly in BIOS Setup.</p> <p>System board.</p>
<p>662 FLOPPY DISK(S) failure (80)</p>	<p>Unable to reset floppy subsystem.</p>
<p>662 FLOPPY DISK(S) failure (40)</p>	<p>Floppy Type mismatch.</p>
<p>1701 Hard disk(s) Diagnosis failure</p>	<p>Make sure the hard disks are set correctly in BIOS setup.</p> <p>Hard disk drive cable/connection.</p> <p>Hard disk drive.</p> <p>System board.</p>



Table 2-1 BIOS Error Codes, Messages, and Beeps List	
BIOS Error Codes, Messages, beeps	Action/FRU
<p><b>NOTE:</b> To diagnose a problem, first find the BIOS error messages, codes, or beeps in left column. If directed to a check procedure, replace the FRU indicated in the check procedure. If no check procedure is indicated, the first Action/FRU listed in right column is the most likely cause.</p>	
<p>1762 Primary master IDE has changed Primary slave IDE has changed Secondary master IDE has changed Secondary slave IDE has changed</p>	<p>Make sure that the System Boot Drive parameter in the Startup Options of BIOS Setup is not set to [Drive A only]. Load default settings in Setup. Insert a system diskette into diskette drive and reboot system. Make sure the diskette drive configuration setting in BIOS Setup is correct. Hard disk drive power. Diskette drive. System board.</p>
<p>1780 Primary master hard disk failure  1781 Primary slave hard disk failure</p>	<p>A warning message to indicate there has been change of IDE Primary (Secondary) Channel Master (Slave) device. Load default settings in Setup. Check IDE drive jumper. See "3.5-In. Hard Disk Drive Jumper Locations" on page 161. IDE drive power. IDE drive cable/connection. IDE drive.</p>
<p>1782 Secondary master hard disk failure  1783 Secondary slave hard disk failure</p>	<p>A warning message to indicate there has been change of IDE Primary (Secondary) Channel Master (Slave) device. Load default settings in Setup. Check IDE drive jumper. See "3.5-In. Hard Disk Drive Jumper Locations" on page 161. IDE drive power. IDE drive cable/connection. IDE drive.</p>

Table 2-1 BIOS Error Codes, Messages, and Beeps List

BIOS Error Codes, Messages, beeps	Action/FRU
<p><b>NOTE:</b> To diagnose a problem, first find the BIOS error messages, codes, or beeps in left column. If directed to a check procedure, replace the FRU indicated in the check procedure. If no check procedure is indicated, the first Action/FRU listed in right column is the most likely cause.</p>	
<p>8602 Mouse error on no Mouse present</p>	<p>Make sure the Mouse is connected properly and are set correctly in BIOS Setup. Mouse. System board.</p>
<p>SYSTEM HALTED, (CTRL-ALT-DEL) TO REBOOT...</p>	<p>Indicates the present boot attempt has been aborted and the system must be rebooted. Press and hold down the <b>CTRL</b> and <b>ALT</b> key and <b>DEL</b>.</p>
<p>Hard Disk(s) failure (80)</p>	<p>Hard Disk Drive reset failed.</p>
<p>Hard Disk(s) failure (40)</p>	<p>Hard Disk Drive controller diagnostics failed.</p>
<p>Hard Disk(s) failure (20)</p>	<p>Hard Disk Drive initialization error.</p>
<p>Hard Disk(s) failure (10)</p>	<p>Unable to recalibrate fixed disk.</p>
<p>Non-System disk or disk error  Replace and strike any key when ready</p>	<p>Insert a system disk into Drive A: and press <b>&lt;Enter&gt;</b>.  If you assumed the system would boot from the hard drive, make sure the controller is inserted correctly and all cables are properly attached.  Be sure the disk is formatted as a boot device. Then reboot the system.</p>
<p>OFFENDING SEGMENT:</p>	<p>This message is used in conjunction with the I/O CHANNEL CHECK and RAM PARITY ERROR messages when the segment that has caused the problem has been isolated.</p>
<p>PRESS A KEY TO REBOOT</p>	<p>This will be displayed at the bottom of the screen when an error occurs that requires you to reboot. Press any key and the system will reboot.</p>

Table 2-1 BIOS Error Codes, Messages, and Beeps List	
BIOS Error Codes, Messages, beeps	Action/FRU
<b>NOTE:</b> To diagnose a problem, first find the BIOS error messages, codes, or beeps in left column. If directed to a check procedure, replace the FRU indicated in the check procedure. If no check procedure is indicated, the first Action/FRU listed in right column is the most likely cause.	
PRESS F1 TO DISABLE NMI, F2 TO REBOOT	When BIOS detects a Non-maskable Interrupt condition during boot, this will allow you to disable the NMI and continue to boot, or you can reboot the system with the NMI enabled.
RAM PARITY ERROR – CHECKING FOR SEGMENT ...	Indicates a parity error in Random Access Memory.
Memory parity Error at ...	Indicates a memory parity error at a specific location. You can use this location along with the memory map for your system to find and replace the bad memory chips.
Memory Verify Error at ...	Indicates an error verifying a value already written to memory. Use the location along with your system's memory map to locate the bad chip.
OFFENDING ADDRESS NOT FOUND	This message is used in conjunction with the I/O CHANNEL CHECK and RAM PARITY ERROR messages when the segment that has caused the problem cannot be isolated.
ERROR ENCOUNTERED INITIALIZING HARD DRIVE	Hard drive cannot be initialized. Be sure the adapter is installed correctly and all cables are correctly and firmly attached. Also be sure the correct hard drive type is selected in Setup.
ERROR INITIALIZING HARD DISK CONTROLLER	Cannot initialize controller. Make sure the cord is correctly and firmly installed in the bus. Be sure the correct hard drive type is selected in Setup. Also check to see if any jumper needs to be set correctly on the hard drive.
FLOPPY DISK CNTRLR ERROR OR NO CNTRLR PRESENT	Cannot find or initialize the floppy drive controller. Make sure the controller is installed correctly and firmly. If there are no floppy drives installed, be sure the Diskette Drive selection in Setup is set to NONE.

Table 2-2 BIOS Error Codes, Messages, and Beeps List	
BIOS Error Codes, Messages, beeps	Action/FRU
<p><b>NOTE:</b> To diagnose a problem, first find the BIOS error messages, codes, or beeps in left column. If directed to a check procedure, replace the FRU indicated in the check procedure. If no check procedure is indicated, the first Action/FRU listed in right column is the most likely cause.</p>	
Beeps	
(2: long, 1: short) 2-1-1	This code indicates that a video error has occurred and the BIOS cannot initialize the video screen to display any additional information.
2- (repeatedly)	The code indicates that DRAM error has occurred. See “Memory (DIMM)” on page 123 to get more information.

Table 2-3 Error Symptoms List	
Error Symptoms	Action/FRU
<p><b>NOTE:</b> To diagnose a problem, first find the error symptom in the left column. If directed to a check procedure, replace the FRU indicated in the check procedure. If no check procedure is indicated, the first Action/FRU listed in right column is the most likely cause.</p>	
<b>Processor</b>	
<p><b>NOTE:</b> Normally, the processor fan should be operative, and the processor clock setting should be exactly set to match its speed requirement before diagnosing any processor problems.</p>	
Processor fan does not run but power supply fan runs.	<p>Make sure that the system is not in power saving mode. See "Power Management Setup" on page 55.</p> <p>With the system power on, measure the voltage of processor fan connector FN. (See "Power Supply Cable Connector Specifications" on page 157 and refer to the connectors and functions illustrated in chapter 5.) Its reading should be +12Vdc.</p> <p>Processor fan. System board.</p>
Processor test failed.	<p>Processor. System board.</p>
<b>System Board</b>	
<p><b>NOTE:</b> Ensure that the memory modules are installed properly and the contact lead is clean before diagnosing any system problems.</p>	
Memory test failed.	<p>"Memory" on page 92 System board</p>
Incorrect memory size shown or repeated during POST.	<p>Insert the memory modules in the DIMM sockets properly, and then reboot the system.</p> <p>Memory module. See the "Step 005" of "Memory" on page 92 to replace memory module. System board.</p>

Table 2-3 Error Symptoms List	
Error Symptoms	Action/FRU
<p><b>NOTE:</b> To diagnose a problem, first find the error symptom in the left column. If directed to a check procedure, replace the FRU indicated in the check procedure. If no check procedure is indicated, the first Action/FRU listed in right column is the most likely cause.</p>	
System works but fails to enter power saving mode when the "Power Management" is set to [Enabled], and power saving timer set in BIOS has elapsed.	<p>Load default settings.</p> <p>In Win98, check settings in Control Panel Power utility.</p> <p>Reload software from Recovery CD.</p>
System hangs before system boot.	<p>"Index of Symptoms, Messages, Error Codes, or Beeps" on page 69.</p> <p>"Undetermined Problems" on page 101.</p>
System hangs after system boot.	<p>Execute a system test ("Diagnostics/All Tests" in PC-Doctor diagnostics program) and set it to stop at "Halt on Error" to see the potential cause of the problem.</p> <p>"Undetermined Problems" on page 101.</p>
Blinking cursor only; system does not work.	<p>"Start" on page 64.</p> <p>Diskette/IDE drive connection/cables</p> <p>Diskette/IDE disk drives</p> <p>"Undetermined Problems" on page 101.</p> <p>System board</p>
<b>Diskette Drive</b>	
<p><b>NOTE:</b> Ensure that the diskette drive is configured correctly in BIOS Setup and its read/write head is clean before diagnosing any diskette drive problems.</p>	

Table 2-3 Error Symptoms List	
Error Symptoms	Action/FRU
<p><b>NOTE:</b> To diagnose a problem, first find the error symptom in the left column. If directed to a check procedure, replace the FRU indicated in the check procedure. If no check procedure is indicated, the first Action/FRU listed in right column is the most likely cause.</p>	
Media and drive are mismatched.	<p>Make sure that the diskette drive is configured correctly in the Disk Drives of BIOS Setup.</p> <p>Make sure that the diskette drive is correctly formatted.</p> <p>Diskette drive connection/cable</p> <p>Diskette drive</p> <p>System board</p>
Diskette drive does not work.	<p>Make sure that the diskette drive is not set to [None] in the "Standard CMOS Setup" of BIOS Setup.</p> <p>Diskette drive power</p> <p>Diskette drive connection/cable</p> <p>Diskette drive</p> <p>System board</p>
Diskette drive test failed.	<p>Diskette</p> <p>Diskette drive</p> <p>Diskette drive cable</p> <p>System board</p>
<b>Hard Disk Drive</b>	
<p><b>NOTE:</b> Ensure hard disk drive is configured correctly in BIOS Setup, cable/jumper are set correctly before diagnosing any hard disk drive problems.</p>	
Hard disk drive test failed.	<p>Load default settings.</p> <p>Hard disk drive cable.</p> <p>Hard disk drive.</p> <p>System board.</p>
Hard disk drive format error.	<p>Load default settings.</p> <p>Hard disk drive cable.</p> <p>Hard disk drive.</p> <p>System board.</p>
Hard disk drive write error.	<p>Load default settings.</p> <p>Hard disk drive.</p>

Table 2-3 Error Symptoms List	
Error Symptoms	Action/FRU
<p><b>NOTE:</b> To diagnose a problem, first find the error symptom in the left column. If directed to a check procedure, replace the FRU indicated in the check procedure. If no check procedure is indicated, the first Action/FRU listed in right column is the most likely cause.</p>	
Hard disk drive LED fails to light, but system operates normally.	With the system power on, measure the voltage of hard disk LED connector J18 (Please refer to the connectors and functions illustrated in chapter 5).
<b>CD-ROM Drive</b>	
<p><b>NOTE:</b> Make sure CD-ROM drive is configured correctly in BIOS Setup, cable/jumper are set correctly and its laser beam is clean before diagnosing any CD-ROM drive problems.</p>	
<p>CD-ROM drive LED flashes for more than 30 seconds before LED shutting off.</p> <p>Software asks to reinstall disc.</p> <p>Software displays a reading CD error.</p>	<p>CD may have dirt or foreign material on it. Check with a known good disc.</p> <p>CD is not inserted properly.</p> <p>CD is damaged.</p>
CD-ROM drive LED doesn't come on but works normally.	CD-ROM drive
CD-ROM drive cannot load or eject when the system is turned on and its eject button is pressed and held.	<p>CD-ROM drive power.</p> <p>"CD-ROM Drive" on page 91.</p> <p>CD-ROM drive</p>
CD-ROM drive does not read and there are no error codes or messages are displayed.	<p>CD may have dirt or foreign material on it. Check with a known good disc.</p> <p>Make sure that the CD-ROM driver is installed properly.</p> <p>CD-ROM drive.</p>



Table 2-3 Error Symptoms List	
Error Symptoms	Action/FRU
<p><b>NOTE:</b> To diagnose a problem, first find the error symptom in the left column. If directed to a check procedure, replace the FRU indicated in the check procedure. If no check procedure is indicated, the first Action/FRU listed in right column is the most likely cause.</p>	
CD-ROM drive can play audio CD but no sound output.	<p>Make sure that the headphone jack of the CD-ROM has an output, then check if the audio cable from CD-ROM drive to system board CD audio connector is connected properly.</p> <p>Turn up the sound volume.</p> <p>Speaker power/connection/cable.</p> <p>CD-ROM drive.</p>
<b>Real-Time Clock</b>	
Real-time clock is inaccurate.	<p>Make sure that the information in the Date and Time of BIOS Setup is set correctly.</p> <p>Load default settings.</p> <p>RTC battery.</p> <p>System board</p>
<b>Audio</b>	
Audio software program invokes but no sound comes from speakers.	Speaker power/connection/cable.
<b>Modem</b>	
Data/fax modem software program invokes but cannot receive/send data/fax.	"Factory-Installed Modem Card" on page 87.
<b>Video and Monitor</b>	
Video memory test failed. Video adapter failed.	<p>Remove all non-factory cards.</p> <p>Load default settings (if screen is readable).</p> <p>System board</p>

Table 2-3 Error Symptoms List	
Error Symptoms	Action/FRU
<p><b>NOTE:</b> To diagnose a problem, first find the error symptom in the left column. If directed to a check procedure, replace the FRU indicated in the check procedure. If no check procedure is indicated, the first Action/FRU listed in right column is the most likely cause.</p>	
Display problem: - Incorrect colors - No high intensity - Missing, broken, or incorrect characters - Blank monitor(dark) - Blank monitor(bright) - Distorted image - Unreadable monitor - Other monitor problems	Monitor signal connection/cable. Monitor System board
Display changing colors.	Monitor signal connection/cable Monitor System board
Display problem not listed above (including blank or illegible monitor).	"Monitor" on page 99. Load default settings (if screen is readable). System board
<b>Parallel</b>	
<p><b>NOTE:</b> Execute "Load BIOS Default Settings" in BIOS Setup to confirm ports' presence before diagnosing any parallel/serial ports problems.</p>	
Serial or parallel port loop-back test failed.	Make sure that the LPT# or COM# you test is the same as is set in BIOS Setup. Loop-back. System board.

Table 2-3 Error Symptoms List	
Error Symptoms	Action/FRU
<b>NOTE:</b> To diagnose a problem, first find the error symptom in the left column. If directed to a check procedure, replace the FRU indicated in the check procedure. If no check procedure is indicated, the first Action/FRU listed in right column is the most likely cause.	
Printing failed.	Make sure that the printer driver is properly installed. Refer to the service manual for the printer. Printer. Printer cable. System board.
Printer problems.	Refer to the service manual for the printer.
<b>Joystick</b>	
Game port does not respond or does not work.	Connect a joystick to the game port, then execute "Interactive Test/Joystick test" in PC-Doctor diagnostics program. System board.
<b>Diagnostic Program</b>	
Diagnostics programs cannot be executed.	Reboot the system from the diagnostics diskette. Load default settings. Diagnostics diskette. Memory module. System board.
Missing diagnostics files(s).	Diagnostics diskette.
<b>Keyboard</b>	
Some or all keys on keyboard do not work.	"Keyboard" on page 92.
<b>Power Supply</b>	
Pressing power switch cannot turn off system.. (Only unplug power cord from electrical outlet can turn off system.)	See "Power Management Setup" on page 55. Power switch cable assembly "Power Supply" on page 96. System board
Pressing power switch cannot turn on system..	Check the voltage selector on the power supply if it is off. Power switch cable assembly.

Table 2-3 Error Symptoms List	
Error Symptoms	Action/FRU
<p><b>NOTE:</b> To diagnose a problem, first find the error symptom in the left column. If directed to a check procedure, replace the FRU indicated in the check procedure. If no check procedure is indicated, the first Action/FRU listed in right column is the most likely cause.</p>	
Executing software shutdown from Windows98 Start menu cannot turn off system. (Only pressing power switch can force system to turn off).	Load default settings. Reload software from Recovery CD.
No system power, or power supply fan is not running.	"Power Supply" on page 96. System board.
<b>Other Problems</b>	
Any other problems.	"Undetermined Problems" on page 101.

---

## Troubleshooting

**Failing Parts or Assemblies:** The check procedures generally help you trace a problem to one part or assembly. The last step of the specific check procedure you are using indicates that a part or assembly is failing. You should inspect the part or assembly before you decide to replace it. It might be loose, dirty, or in need of a small repair. The check procedures might lead you to two, or even three, possible failing parts or assemblies. The parts that might be failing are listed in order of the most probable failure. Also, the FRU parts are defined as replaced units and are not repaired in the field.

**Measuring Voltages:** Some check procedure steps instruct you to measure voltages on cable plugs and electronic board connectors. If you are asked to measure voltage at several places on a plug or connector, a chart next to or near the instruction indicates the number of the plug or connector, the pin numbers you should measure, the signal name, and the correct voltage for the condition you are measuring. Measure the voltage only at the pins listed in the chart. Remember to set the meter on the correct scale and to put the meter leads in the correct position for the voltage you are asked to measure.

**NOTE:** Use frame ground as the ground reference. Attach the black (ground) lead of meter to frame ground, except where specified otherwise.

### Factory-Installed Storage Devices

Use this check procedure to test any factory-installed drives.

**ATTENTION:** The customer may have customized settings in the Setup Utility (other than default settings) on the computer you are servicing. Running the Setup Utility might alter those settings. Take note of the current settings and verify that the customer settings are in place when service is complete.

**NOTE:** If you cannot access the hard disk drive or load a diskette from Drive A or load a CD from the CD-ROM drive, make sure that the BIOS Setup Utility has the startup sequence set with diskette, CD-ROM, and hard disk drives.

#### 001 - START

- Insert the diagnostics diskette into the diskette drive.
- Power-off then power-on the system unit.

#### 002 - DO ANY POST MESSAGES, ERROR CODES, BEEPS, OR SYMPTOMS OCCUR? (YES, READ AHEAD. NO, GO TO STEP 003)

- Go to "Index of Symptoms, Messages, Error Codes, or Beeps" on page 69.
- End.

#### 003 -

- Select **Utility** from the menu.
- Select and execute **Tech Support Form** from the menu to generate a system configuration report.
- Compare the system configuration list with the actual devices installed in system.

**NOTE:** If necessary, remove the cover and visually compare the devices installed in the system unit to those shown in the Tech Support Form.

#### 004 - IF THE NUMBER OF DISKETTE, HARD DISK, OR CD-ROM DRIVE IS NOT CORRECT, READ AHEAD; OR GO TO STEP 005.

- Check the cable installation of all disk drives.
- Diskette drive should be connected to the system board Floppy connector. (Please refer to the connectors and functions illustrated in chapter 5.)

- ❑ IDE Primary Channel Master and Slave Drives in BIOS Setup should be connected to the system board primary IDE connector. (Please refer to the connectors and functions illustrated in chapter 5.)
- ❑ IDE Secondary Channel Master and Slave Drives in BIOS Setup should be connected to the system board secondary IDE connector. (Please refer to the connectors and functions illustrated in chapter 5.)

**NOTE:** The CD-ROM drive that comes with system unit should be configured as IDE Secondary Channel Master device.

- ❑ Check the hard disk and CD-ROM drives jumper settings. See "3.5-In. Hard Disk Drive Jumper Locations" on page 161 and "CD-ROM Drive" on page 91.
- ❑ Check the voltages of all disk drive power connectors. See "Power Supply Cable Connector Specifications" on page 157.
- ❑ Correct the parameter settings under Disk Drives in the BIOS Setup. See "IDE Drives Setup" on page 54.
- ❑ In the BIOS Setup, check that the correct drive size is set for the flagged drive shown in the Installed Devices list.
- ❑ Load default settings.
- ❑ If the problem remains, check the continuity on the drive and the cable and replace it if necessary. If that does not fix the problem, replace the system board.
- ❑ End.

#### 005 –

- ❑ Select **Diagnostics** from the PC-Doctor diagnostics program main menu. Select and execute **Floppy Disk Test** if you want to test the diskette drive. Select and execute **Hard Disk Test** if you want to test the hard disk drive.
- ❑ Select **Interactive Tests** from the PC-Doctor diagnostics program main menu, then select and execute **CD-ROM/DVD Test** if you want to test the CD-ROM drive.
- ❑ If the diagnostics program did not detect a failure, but the system still displays a failure:
  - ❑ If an error or other symptom appears, go to "Index of Symptoms, Messages, Error Codes, or Beeps" on page 69.
  - ❑ If no error can be detected or the symptom is intermittent, go to "Undetermined Problems" on page 101.
- ❑ End.

## Factory-Installed Modem Card

### 001 - START

- Power off the system unit.
- In Windows 98 Device Manager, make sure that the modem is not configured with a conflicting COM port and IRQ setting.
- Make sure that the communication software is configured with the correct COM and IRQ settings (same as COM port and IRQ as the modem).
- Make sure that all communication parameters (baud rate, data, stop and parity bits) are properly configured and are identical on both sides.
- Connect the phone line to the LINE port of the modem card.

**NOTE:** Check the outside phone line by connecting a working telephone to the telephone wall jack. Listen for a dial tone to ensure that the phone line is good.

### 002 -

- Insert the diagnostics diskette into the diskette drive.
- Power on the system unit.
- Select **Diagnostics** menu,
- Select **All Tests**, then execute **Modem** test.

### 003 - DOES THE MODEM PASS THE TEST? (YES, READ AHEAD. NO, GO TO STEP 004.)

- Power off the system unit.
- Remove all adapter cards.
- Connect a hard disk drive with pre-loaded Windows 98.
- Power on the system unit.
- Perform the following steps under Windows 98.

**NOTE:** If an operating system other than Microsoft Windows 98 is installed, the program screens and icons may differ from these instructions.

- 1. Start Microsoft Windows 98.
- 2. Select the **Start** icon.
- 3. Select **Program**, then select **Accessories, Hyper Terminal**.
- 4. Select an **on-line service station**, dial and connect to it.



**004 - CAN THE MODEM DIAL OUT AND CONNECT TO ANY BBS SUCCESSFULLY? (YES, READ AHEAD. NO, GO TO STEP 005.)**

- The modem adapter functions normally.
- End.

**005 -**

- Make sure that Windows 98 is properly installed, then power off the system unit.
- Plug the modem adapter card into a different PCI slot.
- Go to step 002.
- If the error symptom still remains, replace the modem adapter card.
- End.

### **Audio (Not Supported by Diagnostics Program)**

**NOTE:** Audio tests for the sound card cannot be carried out in the PC Doctor DOS diagnostics program. It is, however, possible to carry out a dial tone test for the modem.

While performing this check, you may need to enter and exit Microsoft Windows 98 several times. When instructed to select an icon or button, double-click on the item with the mouse.

For more information about using Microsoft Windows 98, see the user's guide that came with the computer.

If an operating system other than Microsoft Windows 98 is installed, the program screens and icons may differ from these instructions.

#### **001 - START**

- Power off the system unit.
- Remove all adapter cards.
- Connect a hard disk drive with pre-loaded Windows 98.
- Power on the system unit.
- Load default settings in setup (audio may be disabled).

#### **002 - DO ANY POST MESSAGES, ERROR CODES, BEEPS, OR SYMPTOMS APPEAR? (YES, READ AHEAD. NO, GO TO STEP 003)**

- Go to "Index of Symptoms, Messages, Error Codes, or Beeps" on page 69.
- End.

#### **003 - DO ANY MESSAGES OR ERROR CODES DISPLAY AFTER POST COMPLETES BUT BEFORE MICROSOFT WINDOWS 98 STARTS? (YES, READ AHEAD. NO, GO TO STEP 004)**

**NOTE:** If POST does not complete, answer this question "No".

- Make sure that Windows 98 is properly installed.
- End.

**004 -**

- Perform the following under Windows 98.

**NOTE:** If an operating system other than Microsoft Windows 98 is installed, the program screens and icons may differ from these instructions.

1. Start Microsoft Windows 98.
2. Select the **Start** icon.
3. Select **Settings**, then select **Control Panel**.
4. Select the **Sound** icon.
5. In the Sound window, select **chimes** from the **Names** field. (To test other adapter card software, select an action from a menu in that software.)

**005 - IS THE PREVIEW BUTTON, OR ACTION IN OTHER SOFTWARE, SELECTABLE ON THE SCREEN (SHOWN IN BLACK AND NOT GRAY)? (YES, GO TO STEP 006. NO, READ AHEAD.)**

- Make sure that Windows 98 is properly installed.
- Go to step 001.

**006 -**

- Select the **Preview** button from the Sound window.

**007 - DO YOU HEAR ANY SOUND FROM THE SPEAKER? (YES, READ AHEAD. NO, GO TO STEP 008.)**

- The audio feature is functioning normally. Click **Cancel** to close the dialog box. Exit Microsoft Windows 98.
- If the symptom remains or has changed, go to "Index of Symptoms, Messages, Error Codes, or Beeps" on page 69.
- End.

**008 -**

- Make sure that the volume control is not turned low.
- Make sure that the speaker and its adapter are not damaged.
- Make sure that the speaker is plugged in speak-out jack. Refer to the connectors and functions illustrated in chapter 5.
- If the error cannot be resolved, replace the system board.
- End.

**CD-ROM Drive**

**001 - START**

- Insert the diagnostics diskette into the diskette drive and make sure that there is no CD in the CD-ROM drive.
- Select **Interactive Tests** menu, then select and execute **CD-ROM Test**.

**002 - DO YOU SEE A MESSAGE "NO CD-ROM DRIVE OR MSCDEX DEVICE DRIVER INSTALLED." ? (YES, READ AHEAD. NO, GO TO 003.)**

- Exit the diagnostics program and power off the system.
- Check and make sure that the CD-ROM drive power cable and audio and data cables are not damaged and are connected properly.
- Check and make sure that the CD-ROM drive driver is loaded correctly.
- Load default settings.

**003 - DO THE TESTS OF OPEN/CLOSE TRAY BY DIAGNOSTICS PROGRAM AND BY DEPRESSING CD-ROM DRIVE BUTTON WORK? (YES, READ AHEAD. NO, GO TO STEP 006.)**

- Load a known good data CD into the CD-ROM drive and try to read its content by typing DIR at DOS prompt.

**004 - CAN A CD BE READ FROM THE CD-ROM DRIVE? (YES, THEN THE CD-ROM DRIVE FUNCTIONS NORMALLY. NO, READ AHEAD.)**

- Try reading the CD with a known good CD-ROM drive.

**005 - IS THE CD STILL NOT READABLE? (YES, READ AHEAD. NO, GO TO STEP 006.)**

- Replace system board.
- End.

**006 -**

- Replace CD-ROM drive.
- End.

## Memory

### 001 - START

- Power off the system unit.
- Insert the diagnostics diskette into the diskette drive.
- Make sure that all DIMMs are installed correctly.
- Power on the system unit.
- Take note of any messages, error codes, or symptoms.

### 002 - DO YOU RECEIVE POST MEMORY ERROR MESSAGE? (YES, READ AHEAD. NO, GO TO STEP 003)

- Enter **BIOS Setup Utility** then reboot the system. Take note of any messages, error codes, or symptoms. If the error message remains, go to step 005.

### 003 -

- Follow the screen instructions to run the **Memory test**.

### 004 - DOES THE MEMORY TEST COMPLETE WITHOUT AN ERROR? (YES, READ AHEAD. NO, GO TO STEP 005.)

- The system memory is now functioning correctly. If you suspect an intermittent problem, run the **Memory test** again.
- End.

### 005 -

- Replace each DIMM, one at a time, with a known working DIMM of the same size and type.
- If the problem does not appear, it means that the last DIMM replaced is defective. If all DIMMs on the system board have been replaced and the problem remains, replace system board.
- Go to step 001.

**NOTE:** If on startup, there is no memory inserted on system board, you will hear 2-(repeatedly). (2:long beep)

## Keyboard

### 001 - START

- Power off the system unit and make sure that the keyboard plug is connected properly.

### 002 -

- Insert the diagnostics diskette into the diskette drive and power on the system unit.
- Select **Interactive Tests** menu, then execute **Keyboard** test.

**003 - DOES THE KEYBOARD FUNCTION CORRECTLY?  
(YES, READ AHEAD. NO, GO TO STEP 004.)**

- Keyboard is functioning normally.
- End.

**004 - ARE THERE ANY STUCK KEYS OR ANY GRIME IN THE GAP OF KEYCAPS? (YES, READ AHEAD. NO, GO TO STEP 005.)**

- Power off the system unit. Carefully remove the grime and solve the stuck keys problem.
- Go to step 001.

**005 - ARE THERE ANY BROKEN PINS IN THE KEYBOARD PLUG? (YES, GO TO STEP 007. NO, READ AHEAD.)**

- Try with a known good keyboard.

**006 - DOES THE ERROR SYMPTOM STILL REMAIN?  
(YES, READ AHEAD. NO, GO TO STEP 007.)**

- Replace the system board.
- End.

**007 -**

- Replace the keyboard.
- End.

**Mouse**

**NOTE:** A sticking key button can cause the mouse to operate incorrectly. If you suspect this, go to "Keyboard" on page 92.

**001 - START**

- Make sure that the mouse ball turns freely.
- Make sure that the mouse plug connects properly.

**002 -**

- Power off the system unit.

- Insert the diagnostics diskette into the diskette drive.
- Power on the system unit.
- Select **Interactive Tests** menu, then execute **Mouse** test.

**003 - DO YOU SEE THE MOUSE CURSOR IN THE DIAGNOSTICS PROGRAM? (YES, READ AHEAD. NO, GO TO STEP 011)**

- Test right (left) button and check if right (left) button works.

**004 - DOES THE MOUSE BUTTON WORK? (YES, READ AHEAD. NO, GO TO STEP 007)**

- Test mouse cursor movement.

**005 - DOES THE MOUSE MOVE SMOOTHLY AND KEEP X AND Y COORDINATES CHANGED? (YES, READ AHEAD. NO, GO TO STEP 006)**

- Mouse is functioning normally.
- End.

**006 -**

- Power off the system unit.
- Open mouse bottom cover and clean track ball.
- Go to step 002.

**007**

- Power off the system unit.
- Check the mouse plug.

**008 - ARE THERE ANY BROKEN PINS IN THE MOUSE PLUG? (YES, GO TO STEP 010. NO, READ AHEAD.)**

- Try with a known good mouse.

**009 - DO THE ERROR SYMPTOMS STILL REMAIN? (YES, READ AHEAD. NO, GO TO STEP 010.)**

- Replace the system board.
- End

**010 -**

- Replace the mouse.
- End.

**011 -**

- Exit diagnostics program.
- Make sure that the mouse driver is properly installed.
- Go to step 002.

## **Power Supply**

### **001 - START**

- Power off the system unit.
- Check the power cord for continuity. Replace if necessary.
- Check for the correct line voltage from the power outlet, and verify that the voltage selector switch is set to the correct voltage.
- Power on the system unit.

### **002 - DOES THE POWER SUPPLY FAN RUN? (YES, GO TO STEP 003. NO, GO TO STEP 004)**

### **003 - DOES THE SYSTEM FAIL TO SHUT OFF WHEN THE ON/OFF SWITCH IS PRESSED? (YES, READ AHEAD. NO, GO TO STEP 005)**

- You might have a damaged on/off switch cable assembly.
- Disconnect the on/off switch cable assembly connector from the power supply connector and take an ohm reading.
- Go to step 007.

### **004 -**

- Disconnect the power cord from the back of the system unit.
- Disconnect all power and switch cable connectors from the system board and the power supply.
- Disconnect the power connectors to all drives.
- Connect the power connector to system board as a power load for driving up power supply.
- Reconnect the power cord.

### **005 - DOES THE POWER SUPPLY FAN RUN? (YES, READ AHEAD. NO, GO TO STEP 009)**

- With the system powered on and the power supply fan running, check the voltages of the power supply connectors for the system board and all drive connectors, as shown in the following figures.



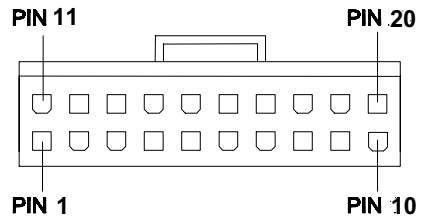

Power Supply Connectors (Bottom View)

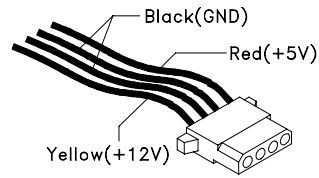

Hard Drive or CD-ROM End of Power Cable

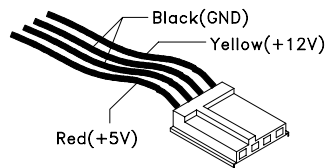

3.5-In. Diskette Drive End of Power Cable

**006 - ARE THE VOLTAGES CORRECT AND DOES THE FAN RUN? (YES, READ AHEAD. NO, GO TO STEP 009)**

- The power supply is working normally.
- If you suspect the on/off switch cable assembly, see Step 003.
- If the fan continues to run when all connectors are plugged back in, go to "Undetermined Problems" on page 101. If the fan stops running when a drive connector is plugged back in, go to "Start" on page 64.

**007 - DO YOU HAVE AN OHM READING WHEN THE SWITCH IS PRESSED AND AN OPEN READING WHEN THE SWITCH IS RELEASED? (YES, READ AHEAD. NO, GO TO STEP 008)**

- Replace the on/off switch cable assembly.

**008 -**

- Replace the system board.
- End.

**009 -**

- Replace the power supply.
- End.

## Monitor

First, set the system to VGA mode. To do this in Windows 98, press the **F8** function key during startup. Safe mode (VGA) will be set for Windows 98. Use the operating system's video setup to change the monitor resolution.

If the monitor type is set to the power saving mode, the screen remains black and the LED lights or flashes in amber color. When the monitor is turned on alone, or is turned on and connected to a powered-off system unit, the monitor LED blinks in amber color. Under the normal operating conditions, the LED lights in green color.

**NOTE:** Some monitors have a detachable system I/O signal cable between the monitor and the system unit. Check the line voltage, power cord, and continuity for the system I/O signal cable before replacing the monitor. See "Monitor Port Signals" on page 164 for pin identification.

### 001 - START

- Power off the system unit and monitor.
- Remove all adapter cards.
- Make sure that the monitor I/O signal cable is properly connected to the system unit and monitor.
- Make sure that the power cords are properly connected to the system unit and monitor, and that the line voltage is correct.
- Make sure that the monitor contrast and brightness controls are not turned too low.
- Make sure that the diagnostics diskette is in the diskette drive.
- Power on the monitor, and wait 20 seconds.
- Power on the system unit.

**NOTE:** If the monitor was not sold together with the system unit, you may need to refer to the service information provided with the monitor.

**002 - IS THE SCREEN READABLE? (YES, READ AHEAD. NO, GO TO STEP 004)**

**NOTE:** If the screen shows a blinking cursor with no memory count running, answer this question "No".

- Select **Interactive Tests** from the Main Menu.
- Select and execute **Video** test from the menu.
- Follow the prompts and perform the video test.
- Go to "Index of Symptoms, Messages, Error Codes, or Beeps" on page 69.

**NOTE:** You might have to adjust the monitor controls to obtain the best image.

**003 - DOES THE MONITOR SUCCESSFULLY PASS ALL TESTS? (YES, READ AHEAD. NO, GO TO STEP 004)**

- You have successfully completed the video diagnostics tests. If the problem remains, go to "Index of Symptoms, Messages, Error Codes, or Beeps" on page 69.
- End.

**004 -**

- Power off the system unit.
- Remove the hard disk drive system cable.
- Power on the system unit.

**005 - IS THE SCREEN READABLE?**

- Replace the monitor. If the symptom remains, replace the system board.
- End.

## Undetermined Problems

If an error code is present, go to "Index of Symptoms, Messages, Error Codes, or Beeps" on page 69. If no error code is present, continue with this check. Check the power supply voltages (see "Power Supply Cable Connector Specifications" on page 157). If the voltages are correct, return here and continue with the following steps:

1. Power off the system unit.
2. Perform the following checks, one by one, until you have isolated the problem FRU (refer to "Parts/Test Point Locations" on page 139 for locations):
  - Load default settings in setup.
  - Check all system board jumper positions and switch settings.
  - Check all adapter card jumper positions.
  - Check all device jumper positions.
  - Check all cables and connectors for proper installation.

If the jumpers, switch, and voltage settings are correct, return here and continue:

3. Remove or disconnect the following, one at a time:

- Non-IBM devices
- External devices
- Any adapters
- Modem card, if installed
- CD-ROM drive
- Diskette drive
- Hard disk drive
- DIMM
- Processor
- System board

4. Power on the system unit.
5. Repeat steps 1 through 4 until you find the failed device or adapter.
6. If software related, reload software from Recovery CD.

If the symptom changes, go to "Index of Symptoms, Messages, Error Codes, or Beeps" on page 69 or to the check procedure for the last item tested.

Replace the last item tested if the system operates normally after removing the last item.



---

## Diagnostic Aids

<b>Diagnostic Aids .....</b>	<b>103</b>
Introduction .....	104
Power-On Self Test.....	104
Diagnostics Tools.....	105
Using Diagnostics Program from Recovery CD.....	105
Diagnostics Program Features.....	106

---

## Introduction

This section explains the diagnostic aids, power-on self test (POST) and diagnostics program (PC-Doctor), that are available for troubleshooting problems on the system.

---

## Power-On Self Test

Each time you power-on the system, the power-on self test (POST) is initiated. Several items are tested during POST, but is for the most part transparent to the user.

POST checks the following:

- System Board
- Memory
- SVGA Controller
- Hard Disk Drive(s)
- Floppy Diskette Drive(s)
- Keyboard
- Mouse
- Parallel Port(s)
- Serial Port(s)
- CD-ROM Drive(s)
- Sound Controller

To start POST, turn on the monitor and then the system unit. The following will happen:

1. The IBM logo will appear on center of the screen.
2. At this time one of two hot-keys may be used. The F1 key, as described on screen, will cause the system Setup Utility menu to appear. The F9 key will switch the graphical IBM logo screen to the traditional text-based system startup screen, which displays BIOS version and system memory tested.
3. If an error is detected during POST, the IBM logo screen will automatically switch to the text-based screen and display the error message or code with a beep. Depending on the criticality of the POST error, the system may halt and/or display the message "Press F1 to go to the Setup or Enter to continue".

If this message appears, pressing the Enter key will allow the system to attempt to proceed despite the reported error; pressing F1 will cause the system Setup Utility menu to appear.



4. If no keyboard keys are pressed, and if POST is completed without errors, the system will then proceed with the loading of DOS or other operating system from diskette drive A or a hard disk drive or CD-ROM drive, depending on the options selected in the Setup Utility.

If any errors are detected by POST, there will be an error message accompanied with an error code shown on display screen and a beep. See "Index of Symptoms, Messages, Error Codes, or Beeps" on page 69 to find the most likely cause and countermeasure.

---

## Diagnostics Tools

**IMPORTANT:** This manual is intended to test the IBM Machine Types 2193, 2194, 2196, 2197, 6344 and 6345 only. Testing devices which are not included with the original product package, including other IBM products, prototype cards, or modifying hardware settings may give false errors and invalid system responses. The diagnostics not specifically made for this model may also report incorrect errors and information.

The diagnostics program comes on a CD (compact disk) along with this book. This version of PC-Doctor diagnostics program, developed by Watergate for IBM, is the primary method of testing the computer. You can use it to test the IBM components of the system and some external devices. The amount of time required to test components depends on the number of components installed and selected. The more devices you have attached to your system and selected in PC-Doctor, the longer the testing will take.

### Using Diagnostics Program from Recovery CD

1. Insert the recovery CD into the CD-ROM drive then restart computer.
2. Press **F1** while POST to enter BIOS Setup menu. Select and enter "**BIOS Features Setup**", set "**Boot Sequence to CD-ROM, A, C**". Save and exit from BIOS Setup.
3. When screen prompts to install original software, type **N** to exit the installation program. Then type **PCDR** and press **Enter** to start the diagnostics program. Follow the instructions on the screen to operate the diagnostics program.

### Diagnostics Program Features

Diagnostics program (PC-Doctor for DOS) includes the following features:

Table 3-1. Diagnostics Program Features	
Main Menu Selections	Submenu Selections
Diagnostics	<ul style="list-style-type: none"><li>• System Test</li><li>• Memory Test</li><li>• Hard Disk Test</li><li>• Floppy Disk Test</li><li>• All Tests</li></ul>
Interactive Tests	<ul style="list-style-type: none"><li>• Keyboard</li><li>• Video</li><li>• Internal Speaker</li><li>• Mouse</li><li>• Joystick Test</li><li>• Diskette</li><li>• Printer Test</li><li>• SCSI Test</li><li>• CD-ROM/DVD Test</li><li>• Stereo Speaker</li></ul>

Hardware Info	<ul style="list-style-type: none"> <li>• Onboard Ethernet</li> <li>• USB Port</li> <li>• System Configuration</li> <li>• Memory Contents</li> <li>• IRQ and DMA Use</li> <li>• Device Drivers</li> <li>• COM and LPT Ports</li> <li>• Physical Disk Drives</li> <li>• Logical Disk Drives</li> <li>• VGA Information</li> <li>• Software Interrupts</li> <li>• SCSI Devices</li> <li>• I/O Use</li> <li>• IDE Drive Info</li> <li>• Network Information</li> <li>• PCMCIA Information</li> <li>• PCI Information</li> <li>• SMP Information</li> <li>• PNPISA Info</li> <li>• DMIBIOS Info</li> </ul>
Utility	<ul style="list-style-type: none"> <li>• File Editor</li> <li>• Surface Scan Hard Disk</li> <li>• Terminal</li> <li>• Tech Support Form</li> <li>• Battery Rundown</li> <li>• Select Language</li> </ul>
Quit	<ul style="list-style-type: none"> <li>• Exit Diags</li> <li>• Park HD</li> <li>• Reboot</li> <li>• Upgrade Now</li> </ul>



---

## Repair Information

<b>Repairing Information</b> .....	<b>109</b>
Removals and Replacements of machine type 2193, 2194, and 6345 .....	110
Identifying the Parts of the System Unit .....	111
Top Cover .....	113
Adapter Cards .....	114
Diskette Drive .....	116
CD-ROM Drive .....	118
Hard Disk Drive .....	119
System Board .....	120
Power Supply .....	123
Memory (DIMM) .....	123
Removals and Replacements of machine type 2196, 2197, and 6344 .....	124
Identifying the Parts of the System Unit .....	125
Top Cover .....	127
Adapter Cards .....	128
Diskette Drive .....	130
CD-ROM Drive .....	131
Hard Disk Drive .....	132
System Board .....	133
Power Supply .....	136
Memory (DIMM) .....	137

---

**Removals and Replacements of machine type 2193, 2194,  
and 6345**

**BEFORE REMOVING ANY FRU, POWER-OFF THE  
COMPUTER UNPLUG ALL POWER CORDS FROM  
ELECTRICAL OUTLETS, THEN DISCONNECT ANY  
INTERCONNECTING CABLES.**

**ATTENTION:** The System board, processors, adapter cards, DIMMs, and upgrade processors can be damaged by electrostatic discharge. Use an electrostatic discharge (ESD) strap to establish personal grounding. If you don't have an ESD strap, establish personal grounding by touching a ground point with one hand before touching the static-sensitive FRUs.

The Arrows in the removals and replacements procedures show the direction of movement to remove a field-replaceable unit (FRU), to turn a screw, or the direction to press a tab to release the FRU.

Begin all removals by removing the cover (and rear cover, if applicable). When other FRUs must be removed prior to removing the failing FRU, they are listed at the top of the page. Go to the removal procedure for each FRU listed. Remove the FRU, and then continue with the removal of failing FRU.

To replace a FRU, reverse the removal procedure and follow any notes that pertain to replacement.

Before disconnecting any cables, note their location and orientation. Reinstall any new FRUs with cabling in their original location.

### **Identifying the Parts of the System Unit**

This computer system has 4 bays, each bay has a factory-installed drive in it. The devices are 3.5" Diskette, 40X CD-ROM drive (For 6345 system only some models have) and 5.0 GB hard disk (some models may have hard disk of 10 or 15 GB capacity).

Diskette drives in this unit use the standard diskette advanced technology (AT) Interface. Hard disk and CD-ROM drives in this unit use an integrated drive Electronics (IDE) AT interface. This computer supports the American National Standard Institute (ANSI) standard for AT attachment disk drives and CD-ROMs.

This system has 3 interface cards slots for adapter card expansion. All of them are Peripheral Component Interconnect (PCI) interfaces.

Only 2194 and some 2193 models do not have a 10/100 Mbps Ethernet port on board. 2193 system can support DFP (Digital Flat Panel) function.

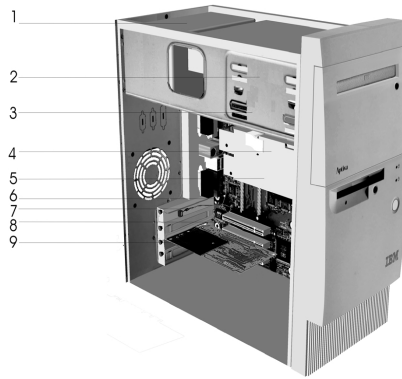

1. Power Supply  
This is a 95-watt switching power supply.
2. CD-ROM Drive  
This machine has a factory-installed 40 X CDROM drive.
3. Bay 2  
This drive can accommodate a 5.25-inch device.
4. Hard Disk Drive  
This machine has a factory-installed 3.5" (10 or 15) GB hard disk drive.
5. Diskette Drive  
This machine has a factory-installed 3.5" 1.44MB Floppy drive.
6. System board
7. Speaker jack. (for unpowered speaker only)
8. Expansion slots  
On the rear panel of the system unit are 3 slot openings for installation of adapter card.
9. Modem card  
The system may include a V.90 Data/Fax modem. Also 6345 system has Ethernet card.



### Top Cover

To remove the top cover of this system unit:

- Remove the 4 screws that secure the top cover at the back of the system unit.
- Hold both sides of the system unit cover and push it backward about 25 mm.
- Lift the top cover up to remove it completely.
- Touch the bare metal frame of your system unit to dissipate the static electricity from your body. Do not touch any of the components inside the frame before you touch the frame. Do not touch any of the components that have a voltage-warning label.
- Disconnect the system unit power cord.

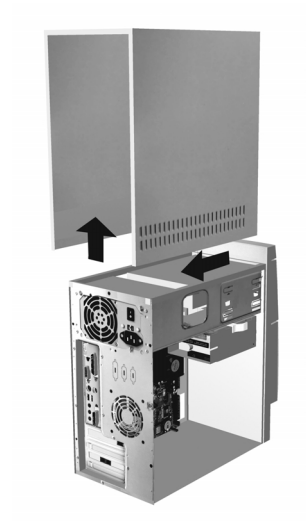
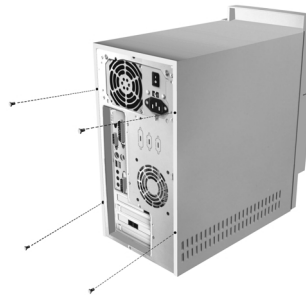

## Adapter Cards

### Installing Adapter Cards

- Remove the screw that secures the adapter card retainer and slot cover. Then remove the card retainer and slot cover.
- Align and insert the adapter card into the adapter card connector.
- Secure the card with the screw that you removed in the first step.
- Reinstall all hardware (except for the slot cover, which cannot be reinstalled) and screws that you removed prior to the installation of the adapter card.

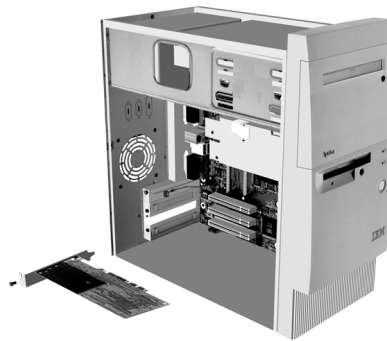

### **Removing Adapter Cards**

Follow these steps to remove an adapter card:

- Position the system unit so that the card is accessible to you.
- If the adapter card has cables, disconnect them. Be sure to take note of where the cable is connected. You will have to reconnect these cables when you reinstall the card.
- Remove the adapter card screw
- Firmly hold the adapter card and carefully pull it from the card connector.
- If you are not reinstalling the card, reinstall all other hardware and screws that were removed prior to the removal of the adapter card.

### Diskette Drive

To remove the diskette drive:

- Disconnect the power and signal cables from the back of the diskette drive.
- Remove the diskette mounting tray from the chassis as following illustration :
- Pivot the latch that secures the lower drive-mounting tray.
- 

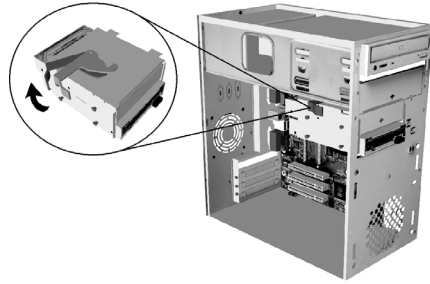

- Slide the drive-mounting tray toward the rear of the computer and remove it.
- Note: If the chassis is not like the figure, please refer to the following.
- Press down the latch.
- Pivot the tray outward, then lift it slightly to remove it.

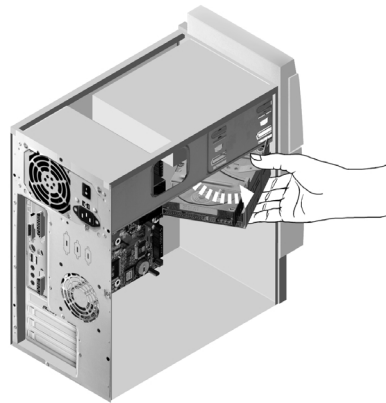

- ❑ Remove the four screws (two on each side) that hold the diskette drive to the mounting tray

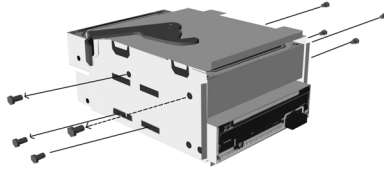

- ❑ .Pull the diskette drive from the mounting tray to remove it.

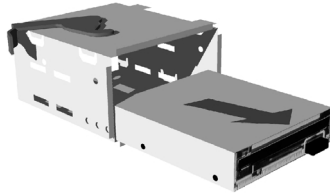

### CD-ROM Drive

To remove CD-ROM Drive:

- Disconnect the power, sound and signal cables from the CD-ROM.
- Remove the four screws (two on each side) that hold the CD-ROM drive to the chassis.
- Open the door on the front of the computer.

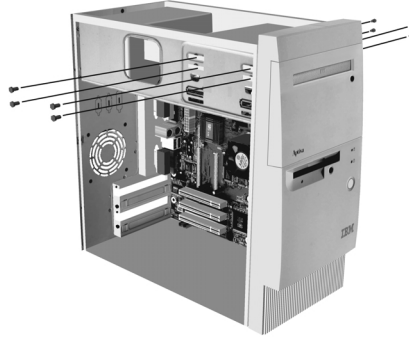

- Slide the CD-ROM drive forward through the front opening and remove it.

### Hard Disk Drive

To remove or replace the hard disk drive:

- ❑ Make sure to disconnect the power and signal cables from the CD-ROM drive and the diskette drive.
- ❑ Pivot the latch that secures the lower drive-mounting tray. Slide the drive-mounting tray toward the rear of the computer and remove it.

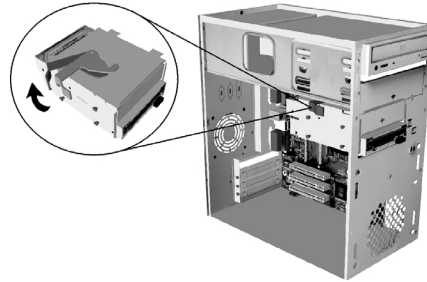

**Note:** If the chassis is not like the figure, please refer to the following.

1. Press down the latch.
2. Pivot the tray outward, then lift it slightly to remove it.

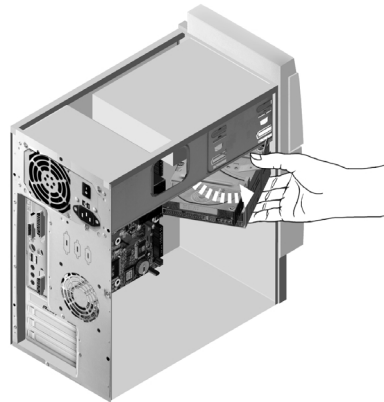

- Remove the four screws (two on each side) that hold the hard disk drive to the mounting tray.
- Pull the hard disk drive from the mounting tray to remove it.

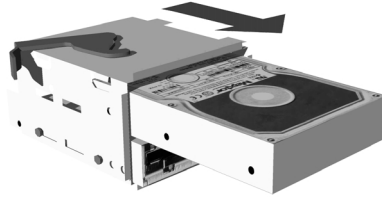

### System Board

To remove the system board from the system:

- To remove the system board. You must remove the adapter cards first.
- Disconnect the power cable, CD-ROM cable, Diskette Drive cable, Hard Disk Drive cable, audio cable, power switch cable, speaker cable and LED cable from system board.
- Remove the eight screws on system board.

Note: Be sure to stay the I/O Port Bracket on chassis when replacing the system board.

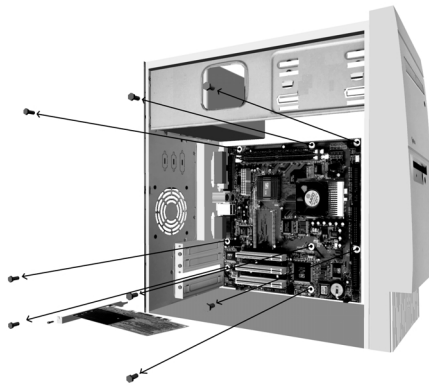



**Layout of system board of the machine type 2193**

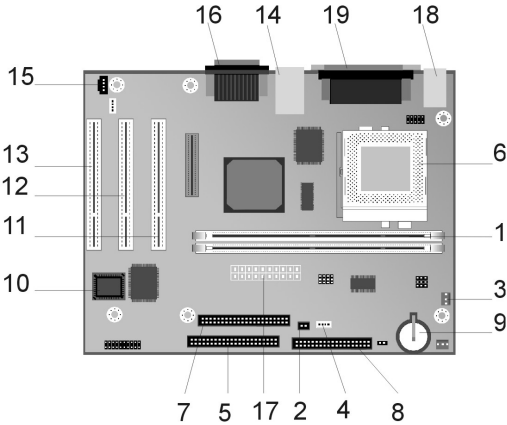

- |   |  |
|---|--|
| 1. DIMM                                       | 11. PCI SLOT 1                           |
| 2. Power Switch connector                     | 12. PCI SLOT 2                           |
| 3. CPU Fan Connector                          | 13. PCI SLOT 3                           |
| 4. Hard Disk Drive Led and Power Led          | 14. USB                                  |
| 5. Primary IDE Connector (Hard Disk Drive)    | 15. CD-ROM audio signal connector        |
| 6. CPU  | 16. Audio and game port                  |
| 7. Secondary IDE Connector (CD-ROM)           | 17. Power Supply Connector               |
| 8. Diskette Drive Connector                   | 18. Keyboard and mouse connectors        |
| 9. System Battery                             | 19. Parallel, Video and Serial connector |
| 10. Flash ROM BIOS Power switch Led Connector |  |

**Layout of system board of the machine type 2194 and 6345**

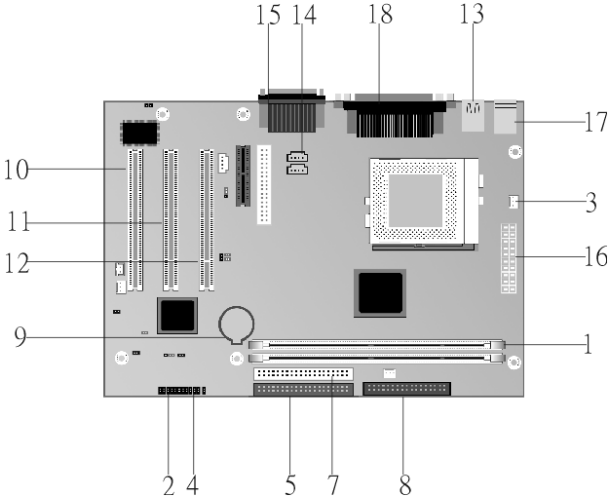

- |  |  |
|--|--|
| 1. DIMM                                    | 11. PCI SLOT 2                           |
| 2. Power Switch connector                  | 12. PCI SLOT 3                           |
| 3. CPU Fan Connector                       | 13. USB                                  |
| 4. Hard Disk Drive LED and Power LED       | 14. CD-ROM audio signal connector        |
| 5. Primary IDE Connector (Hard Disk Drive) | 15. Audio and game port                  |
| 6. CPU                                     | 16. Power Supply Connector               |
| 7. Secondary IDE Connector(CD-ROM)         | 17. Keyboard and mouse connectors        |
| 8. Diskette Drive Connector                | 18. Parallel, Video and Serial connector |
| 9. System Battery                          |  |
| 10. PCI SLOT 1                             |  |

### **Power Supply**

This system has a 95-watt switching power supply.

1. To remove the power supply. You must remove the top cover first.
2. Disconnect the power cable from the riser board and all drives.
3. Remove the screws in the machine rear that secure the power supply.

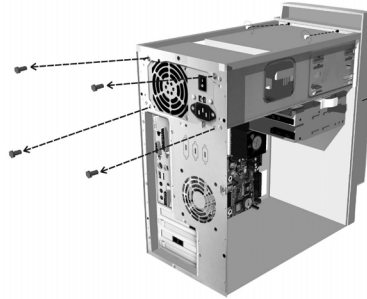

### **Memory (DIMM)**

This system has 2 system memory module sockets, DIMM 0 and DIMM 1. These sockets hold dual in line memory modules (DIMM) that contains 3.3V signal or double-sided synchronous DRAM (SDRAM).

The maximum memory size is 512 MB total.

---

**Removals and Replacements of machine type 2196, 2197,  
and 6344**

**BEFORE REMOVING ANY FRU, POWER-OFF THE  
COMPUTER UNPLUG ALL POWER CORDS FROM  
ELECTRICAL OUTLETS, THEN DISCONNECT ANY  
INTERCONNECTING CABLES.**

**ATTENTION:** The System board, processors, adapter cards, DIMMs, and upgrade processors can be damaged by electrostatic discharge. Use an electrostatic discharge (ESD) strap to establish personal grounding. If you don't have an ESD strap, establish personal grounding by touching a ground point with one hand before touching the static-sensitive FRUs.

The Arrows in the removals and replacements procedures show the direction of movement to remove a field-replaceable unit (FRU), to turn a screw, or the direction to press a tab to release the FRU.

Begin all removals by removing the cover (and rear cover, if applicable). When other Furs must be removed prior to removing the failing FRU, they are listed at the top of the page. Go to the removal procedure for each FRU listed. Remove the FRU, and then continue with the removal of failing FRU.

To replace a FRU, reverse the removal procedure and follow any notes that Pertain to replacement.

Before disconnecting any cables, note their location and orientation. Reinstall any new Furs with cabling in their original location.

### **Identifying the Parts of the System Unit**

This computer system has 3 bays, each bay has a factory-installed drive in it. The devices are 3.5" Diskette, 40X CD-ROM drive and 5.0 GB hard disk (some models may have hard disk of 10 or 15 GB capacity).

Diskette drives in this unit use the standard diskette advanced technology (AT) Interface. Hard disk and CD-ROM drives in this unit use an integrated drive Electronics (IDE) AT interface. This computer supports the American National Standard Institute (ANSI) standard for AT attachment disk drives and CD-ROMs.

This system has 3 interface cards slots for adapter card expansion. All of them are Peripheral Component Interconnect (PCI) interfaces.

This system has 1 video bridge expansion slot adjacent to the PCI slots. All models of this system have a 10/100 Mbps Ethernet port on board. (For 6344 systems in the US, LA and Canada will use an Ethernet card)

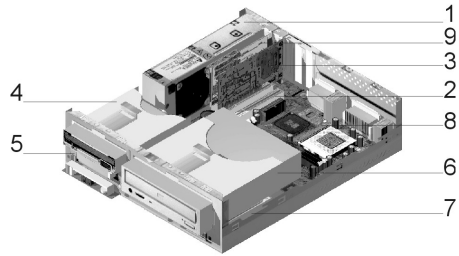

|

1. Power Supply  
This is a 95-watt switching power supply.
2. Expansion slots  
On the rear panel of the system unit are 3 slot openings for installation of adapter card.
3. Modem card  
This system may include a V.90 Data/Fax modem. For 6344 systems will use the Ethernet card.
4. Diskette Drive  
This machine has a factory-installed 3.5" 1.44MB floppy drive.
5. PCMCIA drive  
This option is only available on selected models.
6. CD-ROM Drive  
This machine has a factory-installed 40 X CDROM drive but not standard in 6344 models.
7. Hard Disk Drive  
This machine has a factory-installed 5.25" 4 (6 or 8) GB hard disk drive.
8. System board
9. PCMCIA drive adapter card  
This option is only available on some models.

## Top Cover

To remove the top cover of this system unit:

- Remove the screws that secure the top cover at the back of the system unit.
- Hold both sides of the system unit top cover and push it forward about 25 inch.
- Lift the top cover up to remove it completely.
- Touch the bare metal frame of your system unit to dissipate the static electricity from your body. Do not touch any of the components inside the frame before you touch the frame. Do not touch any of the components that have a voltage-warning label.

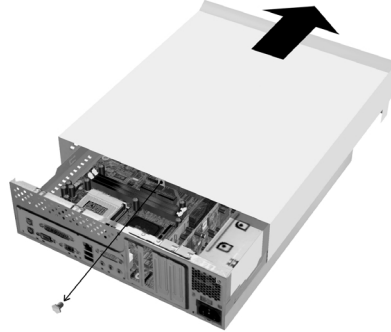

- Disconnect the system unit power cord.

## **Adapter Cards**

### Installing Adapter Cards

- Remove the screw that secures the adapter card retainer and slot cover. Then remove the card retainer and slot cover.
- Align and insert the adapter card into the adapter card connector.
- Secure the card with the screw that you removed in the first step.
- Reinstall all hardware (except for the slot cover, which cannot be reinstalled) and screws that you removed prior to the installation of the adapter card.



### **Removing Adapter Cards**

Follow these steps to remove an adapter card:

- Position the system unit so that the card is accessible to you.
- If the adapter card has cables, disconnect them. Be sure to take note of where the cable is connected. You will have to reconnect these cables when you reinstall the card.
- Remove the adapter card screw
- Firmly hold the adapter card and carefully pull it from the card connector.
- If you are not reinstalling the card, reinstall all other hardware and screws that were removed prior to the removal of the adapter card.

### Diskette Drive

To remove the diskette drive:

- Disconnect the power and signal cables from the back of the diskette drive.
- Pull up the latch that secures the drive-mounting tray.

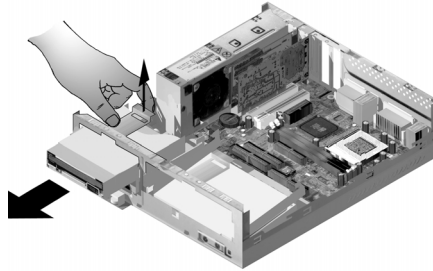

- Slide the drive-mounting tray toward from the front of the computer and remove it.
- Remove the four screws (two on each side) that secure the bay holder.
- Pull the diskette drive from the mounting tray to remove it.
- Reverse the procedure to install a new drive.

### CD-ROM Drive

To remove CD-ROM Drive:

- Disconnect the power, sound and signal cables from the CD-ROM.
- Pull up the latch that secures the CD-ROM drive-mounting tray.

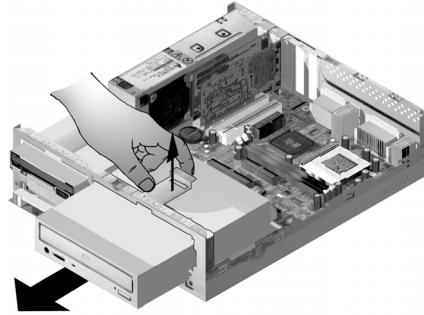

- Slide the drive-mounting tray toward the back of the computer and remove it.
- Remove four screws (two on each side) that secure the bay holder.
- Pull the bay holder backward and lift it up to remove it completely.
- Reverse the procedure to install a new drive.

### Hard Disk Drive

To remove or replace the hard disk drive:

- Follow the above steps to remove the CD-ROM.
- Make sure to disconnect the power cord and signal cables from the hard disk drive and the diskette device.
- Remove the screws that secure the bay holder that holds the hard diskette drive.

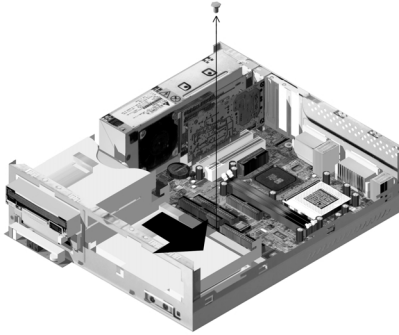

- Pull the bay holder right to uncouple it from the chassis completely and lift it up.

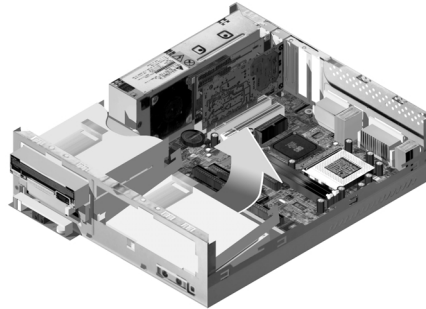

## System Board

To remove the system board from the system:

- To remove the system board. You must remove the adapter cards first.
- Disconnect the power cable, CD-ROM cable, Diskette Drive cable, Hard Disk Drive cable, audio cable, power switch cable, speaker cable and LED cable from system board.
- Remove the eight screws on system board.

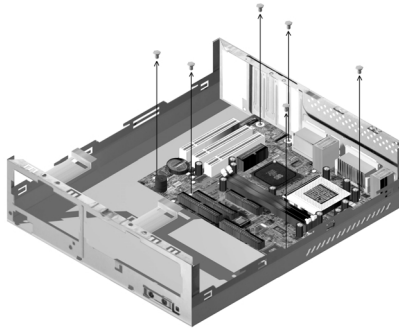

**Layout of system board of machine type 2196**

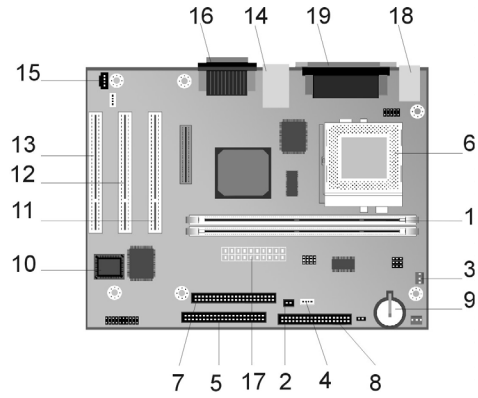

- |   |  |
|---|--|
| 1. DIMM                                       | 11. PCI SLOT 1                           |
| 2. Power Switch connector                     | 12. PCI SLOT 2                           |
| 3. CPU Fan Connector                          | 13. PCI SLOT 3                           |
| 4. Hard Disk Drive LED and Power LED          | 14. USB                                  |
| 5. Primary IDE Connector (Hard Disk Drive)    | 15. CD-ROM audio signal connector        |
| 6. CPU  | 16. Audio and game port                  |
| 7. Secondary IDE Connector (CD-ROM)           | 17. Power Supply Connector               |
| 8. Diskette Drive Connector                   | 18. Keyboard and mouse connectors        |
| 9. System Battery                             | 19. Parallel, Video and Serial connector |
| 10. Flash ROM BIOS Power switch LED Connector |  |

**Layout of system board with SiS630 core logic chip set  
(machine type 2197 and 6344)**

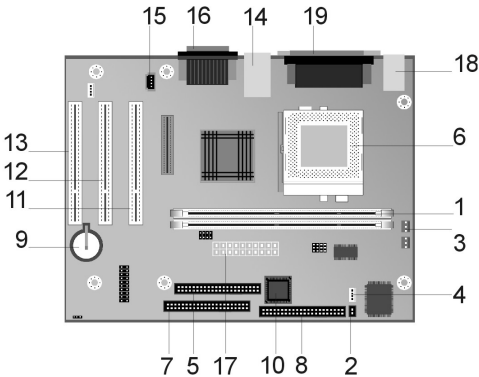

- |   |  |
|---|--|
| 1. DIMM                                       | 11. PCI SLOT 1                           |
| 2. Power Switch connector                     | 12. PCI SLOT 2                           |
| 3. CPU Fan Connector                          | 13. PCI SLOT 3                           |
| 4. Hard Disk Drive LED and Power LED          | 14. USB                                  |
| 5. Primary IDE Connector(Hard Disk Drive)     | 15. CD-ROM audio signal connector        |
| 6. CPU  | 16. Audio and game port                  |
| 7. Secondary IDE Connector(CD-ROM)            | 17. Power Supply Connector               |
| 8. Diskette Drive Connector                   | 18. Keyboard and mouse connectors        |
| 9. System Battery                             | 19. Parallel, Video and Serial connector |
| 10. Flash ROM BIOS Power switch LED Connector |  |

## Power Supply

This system has a 95-watt switching power supply.

1. To remove the power supply. You must remove the top cover first.
2. Disconnect the power cable from the riser board and all drives.
3. Remove the screws in the machine rear that secure the power supply.

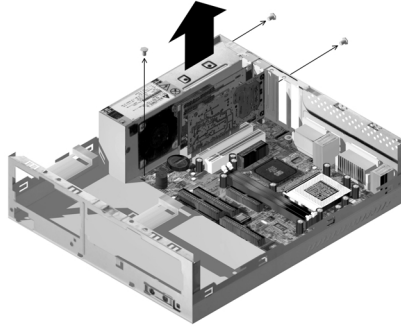



**Memory (DIMM)**

This system has 2 system memory module sockets, DIMM 0 and DIMM 1. These sockets hold dual in line memory modules (DIMM) that contains 3.3V signal or double-sided synchronous DRAM (SDRAM).

The maximum memory size is 512 MB total.



## Parts/Test Point Locations

<b>Parts/Test Point Locations .....</b>	<b>139</b>
Introduction .....	140
Layout of System Board of the Machine Type 2194 (Italy), 2197 and 6344 (EMEA/AP) .....	141
Jumper Settings of the System Board of the Machine Type 2194 (Italy), 2197 and 6344 (EMEA/AP).....	142
Connectors and Functions of System Board of the Machine Type 2194 (Italy), 2197 and 6344 (EMEA/AP).....	143
Layout of System Board of the Machine Type 6344 (US/Canada/LA).....	144
Connectors and Functions of System Board of the Machine Type 6344 (US/Canada/LA) .....	146
Layout of System Board of the Machine Type 2193 and 2196.....	146
Jumper Settings of the System Board of the Machine Type 2193 and 2196 .....	147
Connectors and Functions of System Board of the Machine Type 2193 and 2196.....	148
Layout of System Board of the Machine Type 2194 and 6345.....	149
Jumper and Connector Settings of System Board of the Machine Type 2194 and 6345 .....	150
Power Supply Cable Connector Specifications .....	157
Main Output Pin Assignment.....	158
Factory-Installed Modem Card Layout.....	160
Factory-Installed Modem Card Connector Functions..	160
3.5-In. Hard Disk Drive Jumper Locations & Settings .....	161
CD-ROM Drive .....	162
CD-ROM Drive Rear Panel Connectors and Features	163
CD-ROM Drive Jumper Settings .....	163
DIMM Configurations .....	164
System Board Connector Pin Signals.....	164
Monitor Port Signals.....	164
Serial Port Signals .....	164
Parallel Port Signals.....	165
Mouse Port Signals.....	165
Keyboard Port Signals .....	165
Diskette Drive Cable Connector Signals.....	166
IDE Cable Connector Signals.....	167

## **Introduction**

This chapter contains system board layouts and jumper settings. It is useful when you are asked to measure voltages. Use this information to help you locate parts such as electronic boards, connectors, pin numbers, and test points. This chapter also contains jumper settings for the hard disk drive, CD-ROM (compact disc-read-only memory) drive, and the connector information for modem adapter card.

**Layout of System Board of the Machine Type 2194 (Italy),  
2197 and 6344 (EMEA/AP)**

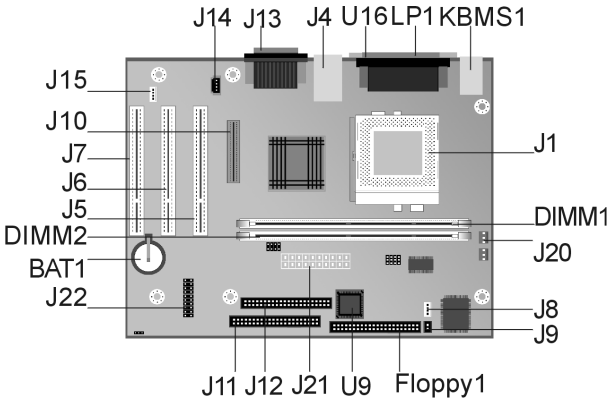

Jumpers and Connectors Locations of System Board of the machine type 2194 (Italy), 2197 and 6344 (EMEA/AP)

**Jumper Settings of the System Board of the Machine Type  
2194 (Italy), 2197 and 6344 (EMEA/AP)**

Table 5-1. Jumper settings of the System Board of the Machine Type 2194 (Italy), 2197 and 6344 (EMEA/AP)					
Jumper/Settings				Function	
				Bus Frequency(MHz)	
<u>JP9</u>	<u>JP10</u>	<u>JP11</u>	<u>JP13</u>	CPUCLK	SDRAMCLK
2-3	2-3	2-3	2-3	66	100
1-2	2-3	2-3	2-3	100	100
1-2	2-3	1-2	2-3	100	133
1-2	1-2	1-2	2-3	133	133
2-3	2-3	2-3	1-2	66	66
CPU Core Clock Multiplier Jumper connected				CPU Clock Frequency Ratio	
<u>JP1</u>	<u>JP2</u>	<u>JP3</u>	<u>JP4</u>		
1-2		1-2		8.0	
1-2	1-2		1-2	7.5	
1-2			1-2	7.0	
1-2	1-2			6.5	
1-2				6.0	
	1-2	1-2	1-2	5.5	
		1-2	1-2	5.0	
	1-2	1-2		4.5	
		1-2		4.0	
	1-2		1-2	3.5	
<u>JP6</u>	CMOS data clear-up Jumper connected			Function	
		2-3		Normal	
		1-2		Clear	
<u>J8</u>	Jumper connected to Front Panel			Indication	
		1-2		Power LED	
		3-4		Hard Disk Drive LED	
<u>J9</u>	Jumper connected to power switch			Power Button	
		1-2			

**Connectors and Functions of System Board of the Machine Type 2194 (Italy), 2197 and 6344 (EMEA/AP)**

Table 5-2. Connectors and Functions of System Board of the Machine Type 2194 (Italy), 2197 and 6344 (EMEA/AP)	
Connector	Function
BAT 1	Battery socket
Floppy 1	Floppy connector
J3	CPU FAN
J4	LAN and USB connector
J5	PCI Slot 1
J6	PCI Slot 2
J7	PCI Slot 3
J18	Power and HDD LED
J10	Digital Flat Panel Connector
J9	Power Switch connector
J11	Hard Disk connector (Primary IDE)
J12	CD-ROM Drive connector (Secondary IDE)
J13	CD Audio connector
J14	CD ROM connector (Secondary IDE)
J15	Passive speaker connector
J19	COM 1 connector
J20	Game port, audio in, audio out and MIC connector
J21	ATX Power connector
J22	Front USB, Audio In, Audio Out and Volume control
KBMS 1	PS/2 Keyboard and Mouse connector
U9	Flash ROM BIOS
U 16	VGA connector

**Layout of System Board of the Machine Type 6344  
(US/Canada/LA)**

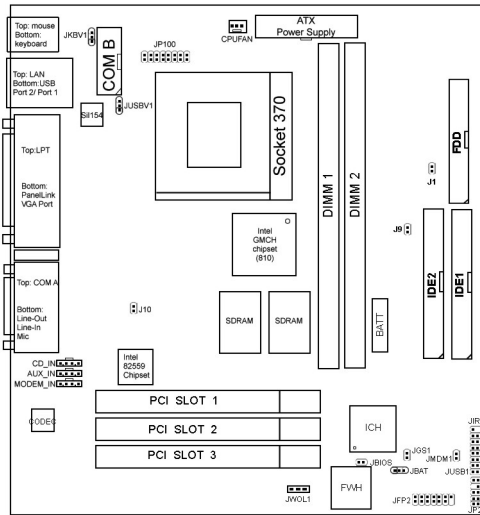

Jumpers and Connectors Locations of System Board  
of the machine type 6344 (US/Canada/LA)

**Jumper Settings of the System Board of the Machine Type 6344 (US/Canada/LA). The Jumper Ratio is determining by BIOS.**



**Connectors and Functions of System Board of the Machine Type 6344 (US/Canada/LA)**

Table 5-3. Connectors and Functions of System Board of the Machine Type 6344 (US/Canada/LA)	
Connector	Function
BATT	Battery socket
FDD 1	Floppy connector
CPUFAN	CPU FAN
PCI Slot 1	PCI Slot 1
PCI Slot 2	PCI Slot 2
PCI Slot 3	PCI Slot 3
JBAT	Clear CMOS
JFP2	HDD LED, Power LED, Speaker, Power Switch and Reset Swith
IDE 1	Primary IDE
IDE 2	Secondary IDE
JWR1	ATX Power Connector
COMA	Serial Port Connector
COMB	Serial Port Connector
LPT1	Parallel Port Connector
VGA	VGA Connector
JKBMS 1	Keyboard / Mouse connector
JWOL1	Wake Up on LAN Connector
JMDM1	Modem Wake Up Connector
J5	CD-In Connector
J6	Aux Line In Connector
JUSB1	USB Front Connector
JP2	Front Panel Audio Connector
JUSBU1	USB Power

**Layout of System Board of the Machine Type 2193 and 2196**

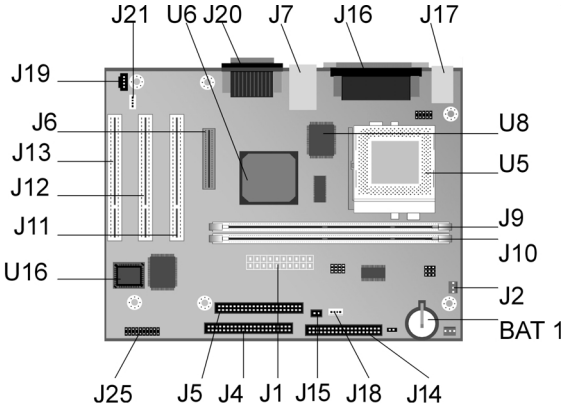

Jumpers and Connectors Locations of System Board of the machine type 2193 and 2196

**Jumper Settings of the System Board of the Machine Type 2193 and 2196**

Table 5-4. Jumper Settings of the System Board of the Machine Type 2193 and 2196					
Jumper/Settings				Function	
				Bus Frequency(MHz)	
<u>JP1</u>	<u>JP2</u>	<u>JP3</u>	<u>JP4</u>	CPUCLK	PCICLK
1-2	1-2	1-2	1-2	66	100
2-3	1-2	2-3	1-2	100	133
2-3	2-3	1-2	2-3	95	95
2-3	1-2	1-2	1-2	100	100
1-2	1-2	1-2	2-3	66	66
CPU Core Clock Multiplier Jumper connected				CPU Clock Frequency Ratio	
JP6	JP7	JP8		6.0	
2-3	1-2	1-2		5.5	
1-2	1-2	2-3		5.0	
1-2	2-3	2-3		4.5	
2-3	2-3	2-3		4.0	
2-3	1-2	2-3		3.	
1-2	1-2	1-2			
JP9 CMOS data clear-up Jumper connected				Function	
2-3				Normal	
1-2				Clear	
J18 Jumper connected to Front Panel				Indication	
1-2				Power LED	
3-4				Hard Disk Drive LED	
J15 Jumper connected to power switch				Power Button	
1-2					

**Connectors and Functions of System Board of the Machine Type 2193 and 2196**

Table 5-5. Connectors and Functions of System Board of the Machine Type 2193 and 2196	
Connector	Function
BAT 1	Battery socket
J1	ATX Power connector
J2	CPU FAN Connector
J4	Hard Disk connector (Primary IDE)
J5	CD-ROM Drive connector (Secondary IDE)
J7	USB and LAN connector
J9	DIMM 0
J10	DIMM 1
J11	PCI Slot 1
J12	PCI Slot 2
J13	PCI Slot 3
J14	Floppy Diskette connector
J15	Power Switch
J16	Printer, COM 1 and VGA connector
J17	PS/2 Key Board and Mouse connector
J18	Power and HDD LED connector
J19	CD Audio in connector
J20	Game port, Audio In, Audio Out and MIC connector
J21	Passive speaker connector

**Layout of System Board of the Machine Type 2194 and 6345**

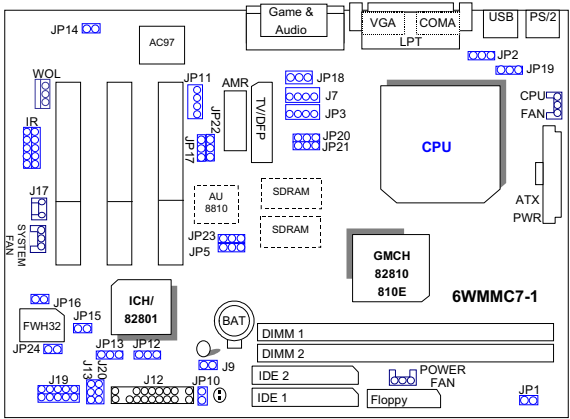

**Jumpers and Connectors Locations of System Board of the machine type 2194 and 6345**

**Jumper and Connector Settings of the System Board of the Machine Type 2194 and 6345**

Table 5-6. Jumper and Connector Settings of the System Board of the Machine Type 2194 and 6345	
◆ I/O Ports Connector	
USB	USB port.
IDE1	For Primary IDE port.
IDE2	For Secondary IDE port.
PS/2	For PS/2 Mouse & Keyboard port.
FLOPPY	For Floppy port.
COMA	For Serial port1 (COM A){Support Modem Ring On}.
LPT	For LPT port.
VGA	For VGA Port.
ATX Power	For ATX Power Connector.
GAME & Audio	For Game & MIC LINE-IN, LINE-OUT, TEL Port ,CD-IN, AUX-IN, SPDIF OUT (Optional)

◆ Socket 370
For Socket 370 Processor installed

◆ IR : INFRARED Connector (IR / CIR)	
Pin No.	Function
1	VCC
2	NC
3	IRRX
4	GND
5	IRTX
6	NC
7	CIRRX
8	VCC
9	NC
10	NC

◆ CPU FAN : CPU cooling FAN Power Connector	
Pin No.	Function
1	GND.
2	+12V
3	SENSE

◆ PWR FAN: Power FAN Connector	
Pin No.	Function
1	GND.
2	+12V
3	SENSE

◆ SYS FAN: System FAN Connector	
Pin No.	Function
1	GND.
2	+12V
3	SENSE

◆ J9:Buzzer Enable (Optional)	
Pin No.	Function
Open	Internal Buzzer Disable
Close	Internal Buzzer Enable

◆ J17 RING PWR ON :Internal Modem Card Ring PWR On	
Pin No.	Function
1	Signal
2	GND

◆ JP2 : Keyboard Power On Selection	
Pin No.	Function
1-2 close	Enabled Keyboard Power On.
2-3 close	Disabled Keyboard Power On(Default).

◆ JP12 : Clear CMOS	
Pin No.	Function
1-2 close	Clear CMOS

2-3 close	Normal operation (Default).
-----------	-----------------------------

◆ J7: CD Audio Line in	
Pin No.	Function
1	CD_L
2,3	GND
4	CD_R

◆ JP11:AUX_IN	
Pin No.	Function
1	AUX_L
2,3	GND
4	AUX_R

◆ J14:Wake on LAN	
Pin No.	Function
1	+5VSB
2	GND
3	Signal

◆ JP3:TEL –The connector for Modem with internal voice connector.	
Pin No.	Function
1	Phone-in
2,3	GND
4	Mono-out

◆ JP1:STR Enable	
Pin No.	Function
Close	STR Enable
Open	STR Disable (Default)

◆ JP14: Case Open	
Pin No.	Function
1	Signal
2	GND

◆ JP13 : Safe Mode/Recovery/Normal	
Pin No.	Function
1-2 close	Normal (Default)
2-3 close	Safe Mode



1-2-3open	Recovery
-----------	----------

◆ JP16: Top Block Lock	
Pin No.	Function
Open	Top Block Lock
Close	Top Block Unlock (Default)

◆ JP15: Timeout Reboot	
Pin No.	Function
Open	Timeout Reboot.
Close	No Reboot on Timeout. (Default)

◆ JP17: Onboard Sound function (Optional)	
Pin No.	Function
1-2 close	Enabled Sound.(Default)
2-3 close	Disabled Sound.

◆ J13/ J20: USB Port Selection (Optional)	
Pin No.	Function
1-2 close	Front Panel USB Port Enabled.
2-3 close	Back Front Panel USB Port Enabled.

◆ J19: Front Panel USB Port (Optional)	
Pin No.	Function
1,4,5,10	NC
2	+5V
3,7,9	GND
6	USB P0+
8	USB P0-

◆ JP18: SPDIF (Optional)	
Pin No.	Function
1	VCC
2	SPDIF OUT
3	GND

◆ JP19: USB Device Wake up	
Pin No.	Function
1-2 close	Disable USB Device Wake up (Default).

2-3 close	Enable USB Device Wake up.
-----------	----------------------------

◆ JP20/JP21:Quad Speaker (Optional)	
Pin No.	Function
1-2 close	LINE_IN
2-3 close	QUAD OUT

◆ JP24:FWH Write Protection	
Pin No.	Function
Open	Normal (Default)
Close	Write Protection.

## J12 : For 2X11 Pins Jumper

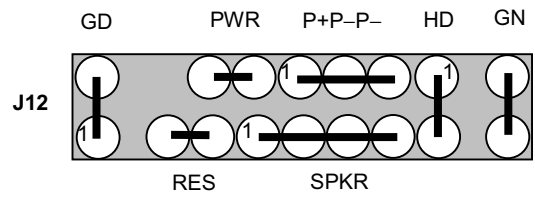

### Soft PWR: Soft Power Connector



Open: Normal Operation  
Short: Power On/Off

### RES: Reset Switch

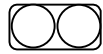

Open: Normal Operation  
Short: For Hardware Reset System

### P+P-P-: Power LED



PIN 1 : LED anode (+)  
PIN 2 : LED cathode (-)  
PIN 3 : LED cathode (-)

**SPKR: Speaker Connector**



PIN 1 : VCC (+)  
PIN 2 : NC  
PIN 3 : NC  
PIN 4 : Data (-)

**HD: IDE Hard Disk Active LED**



PIN 1: LED anode (+)  
PIN 2: LED cathode (-)

**GN: Green Function Switch**



Open : Normal operation  
Short : Entering Green Mode

**GD: Green LED**



PIN 1 : LED anode (+)  
PIN 2 : LED cathode (-)

---

### Power Supply Cable Connector Specifications

Refer to the following figures when checking for voltages on power supply cable connectors.

When checking voltages, the power supply fan must be running. To power on the power supply without using the on/off switch, use a screwdriver or other tools to short the power supply connector (with the switch cable disconnected from the connector on the system board) or use a connection (jumper) to short the black and green wires of the 20-pin connector on power supply.

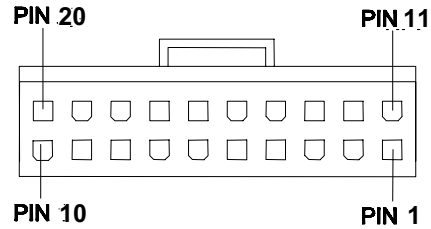

System Board Power Supply Connectors

### Main Output Pin Assignment

Table 5-7. Main Output Pin Assignment		
Pin	Function	Color
1	+3.3 V	Orange
2	3.3 V	Orange
3	COMMON	BLACK
4	+5Vdc	RED
5	COMMON	BLACK
6	+5Vdc	RED
7	COMMON	BLACK
8	POWER GOOD	GRAY
9	+5Vs	PURPLE
10	+12Vdc	YELLOW
11	3.3V	Orange
12	-12Vdc	BLUE
13	COMMON	BLACK
14	P.S-on	GREEN
15	COMMON	BLACK
16	COMMON	BLACK
17	COMMON	BLACK
18	NC	NC
19	+5Vdc	RED
20	+5Vdc	RED

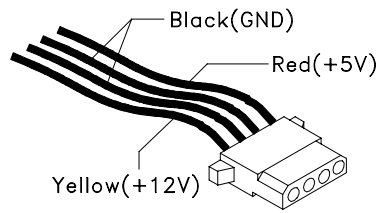

Hard Drive or CD-ROM Power Cable Connector

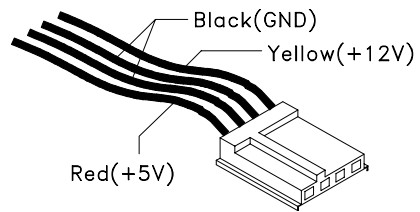

3.5-In. Diskette Drive Power Cable Connector

**Factory-Installed Modem Card Layout**

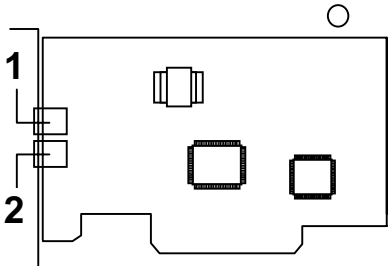

Factory-Installed Modem Card Layout

**Factory-Installed Modem Card Connector Functions**

Item	Function	Connect to...
1	Telephone line-out Some modem adapters may come without this jack.	Telephone set
2	Telephone line-in	Telephone line

**NOTE:** Care should be taken while connecting the voice-in/speaker-out connector. The longer exposed end (approx. 15mm) of the cable should be connected to the modem card. The other end should be connected to the system board.



### 3.5-In. Hard Disk Drive Jumper Locations & Settings

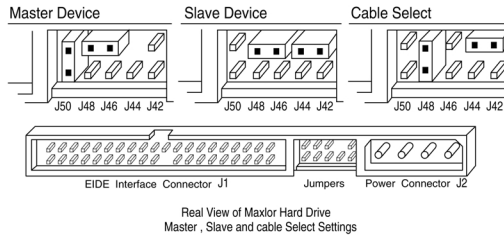

### 3.5-In. Hard Disk (Maxtor) Jumper Settings Locations

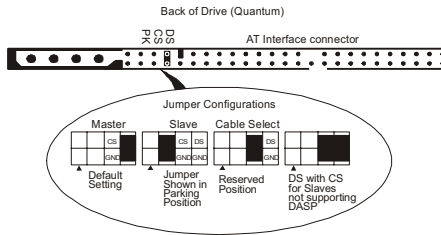

### 3.5-in Hard Disk (Quantum) Jumper Settings Locations

## CD-ROM Drive

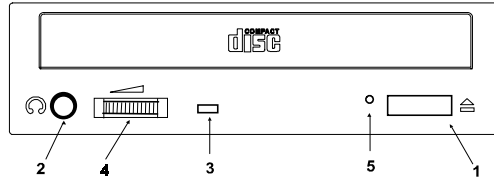

CD-ROM Front Panel

**NOTE:** Position of CD-ROM switches and LEDs may vary from illustration.

Item	Description
1	Load / eject button
2	Headphone jack
3	Power-on / busy indicator, lights up in green color while disc is set in ready state; lights up and flashes in amber color during data read or seek operation.
4	Headphone volume control
5	Emergencies eject hole. See CD-ROM Emergency-exit below.

### CD-ROM Emergency-exit

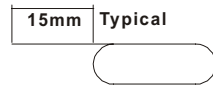

If for any reason the tray does not eject automatically, insert and press an eject-bar inside the emergency eject hole to manually eject the tray. A straightened paper clip with a diameter of 1.2 mm (typical) can be used as an eject-bar.

**NOTE:** Make sure to turn off the power before manual discs eject operation.

## CD-ROM Drive Rear Panel Connectors and Features

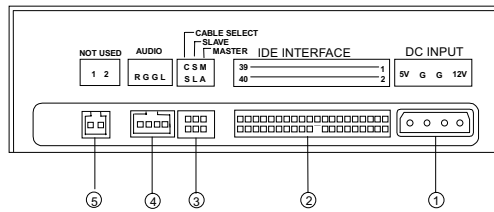

CD-ROM Rear Panel

Item	Function	Connect to...
1	Power supply connector	Power supply
2	Configuration jumper. See Table 5-9.	--
3	NOT USED	--

### CD-ROM Drive Jumper Settings

CS	SL	MA	DESCRIPTION
--	--	On	Drive configured as a Master. (default)
--	On	--	Drive configured as a Slave.
On	--	--	Cable select

### DIMM Configurations

The system board has two DIMM sockets. A maximum of 256KB memory may be installed.

You can install 16MB, 32MB, 64MB, or 128MB DIMM in any sockets and with any combinations.

---

**System Board Connector Pin Signals****Monitor Port Signals**

Pin	Signal Name	I/O	Pin	Signal Name	I/O
1	Red Video	O	9	+5 V dc	N/A
2	Green Video	O	10	Synch Ground	N/A
3	Blue Video	O	11	No Connection	N/A
4	No Connection	N/A	12	Monitor ID Bit 1	I
5	Synch Ground	N/A	13	Horizontal Synch	O
6	Red Ground	N/A	14	Vertical Synch	O
7	Green Ground	N/A	15	Monitor ID Bit 3	I
8	Blue Ground	N/A			

**Serial Port Signals**

Pin	Signal Name	I/O	Pin	Signal Name	I/O
1	Data Carrier Detect	I	6	Data Set Ready	I
2	Receive Data	I	7	Request To Send	O
3	Transmit Data	O	8	Clear To Send	I
4	Data Terminal Ready	O	9	Ring Indicator	I
5	Signal Ground	N/A			

**Parallel Port Signals**

Pin	Signal Name	I/O	Pin	Signal Name	I/O
1	Strobe	O	14	Auto Feed	N/A
2	Data Bit 0	I/O	15	Error	I
3	Data Bit 1	I/O	16	Initialize	O
4	Data Bit 2	I/O	17	Select (In)	O
5	Data Bit 3	I/O	18	Ground	Power
6	Data Bit 4	I/O	19	Ground	Power

7	Data Bit 5	I/O	20	Ground	Power
8	Data Bit 6	I/O	21	Ground	Power
9	Data Bit 7	I/O	22	Ground	Power
10	Acknowledge	I	23	Ground	Power
11	Busy	I	24	Ground	Power
12	Paper Empty	I	25	Ground	Power
13	Select	O			

#### Mouse Port Signals

Pin	Signal Name	I/O	Pin	Signal Name	I/O
1	Mouse Data	I/O	4	+5 V dc	Power
2	No Connection	N/A	5	Mouse Clock	I/O
3	Ground	Power	6	No Connection	N/A

#### Keyboard Port Signals

Pin	Signal Name	I/O	Pin	Signal Name	I/O
1	Keyboard Data	I/O	4	+5 V dc	Power
2	Mouse Data	N/A	5	Keyboard Clock	I/O
3	Ground	Power	6	Mouse Clock	N/A

**Diskette Drive Cable Connector Signals**

Pin	Signal Name	I/O	Pin	Signal Name	I/O
1	No Connection	N/A	18	Direction SELECT	O
2	Density Select	O	19	Ground	N/A
3	No Connection	N/A	20	Step	O
4	High Density Out	I	21	Ground	N/A
5	Ground	N/A	22	Write Data	O
6	No Connection	N/A	23	Ground	N/A
7	Ground	N/A	24	Write GATE	O
8	Index	I	25	Ground	N/A
9	Ground	N/A	26	Track 0	I
10	No Connection	N/A	27	Ground	N/A
11	Ground	N/A	28	Write Protect	I
12	Drive Select 1	O	29	Ground	N/A
13	Ground	N/A	30	Read Data	I
14	No Connection	N/A	31	Ground	N/A
15	Ground	N/A	32	SIDE 1 SELECT	O
16	Motor On	O	33	Ground	N/A
17	Ground	N/A	34	Diskette Change	I

### IDE Cable Connector Signals

Pin	Signal Name	I/O	Pin	Signal Name	I/O
1	Host Reset	O	21	DMA Request	I
2	Ground	N/A	22	Ground	Power
3	Host Data 7	I/O	23	Host IOW	O
4	Host Data 8	I/O	24	Ground	Power
5	Host Data 6	I/O	25	Host IOR	O
6	Host Data 9	I/O	26	Ground	Power
7	Host Data 5	I/O	27	I/O Channel Ready	I
8	Host Data 10	I/O	28	No Connection	N/A
9	Host Data 4	I/O	29	DMA Acknowledge	O
10	Host Data 11	I/O	30	Ground	Power
11	Host Data 3	I/O	31	Host IRQ	I
12	Host Data 12	I/O	32	No Connection	N/A
13	Host Data 2	I/O	33	Host A1	O
14	Host Data 13	I/O	34	No Connection	N/A
15	Host Data 1	I/O	35	Host A0	O
16	Host Data 14	I/O	36	Host A2	O
17	Host Data 0	I/O	37	Host CS0	O
18	Host Data 15	I/O	38	Host CS1	O
19	Ground	Power	39	ACTIVE bar	I
20	No Connection	N/A	40	Ground	Power





---

## Safety Inspection Guide

Safety Inspection Guide .....	169
General Guidelines .....	170

### **General Guidelines**

The purpose of this Safety Inspection Guide is to help you identify possible unsafe conditions on machines that are being inspected for a Maintenance Agreement. Each machine has necessary functions items installed to provide the operators and service personnel with an acceptable level of safety. This guide lists only these items. Good judgment should be used to identify possible safety conditions not covered by this Safety Inspection Guide.

If any unsafe conditions are present, you must find out how serious the hazard is and if you can continue before you correct the hazard.

All current IBM service supplements outlining feature/model changes, along with the machine history, should be reviewed.

Check the following items:

- Damaged, missing, or changed parts, especially in the area of the On/Off switch and the power supply.
- Damaged, missing, or changed covers.
- Possible safety exposure from any non-IBM attachments.

---

## Parts Catalog

Part Catalog of machine type 2193, 2194, and 6345 .....	172
Assembly 1: System Unit .....	172
Assembly 2: Diskette Drive, Hard Disk Drive .....	176
Assembly 3: CD-ROM, Modem Card .....	177
Assembly 4: Keyboard and Mouse .....	180
Parts Catalog of machine type 2196, 219, and 6344 .....	185
Assembly 1: System Unit .....	185
Assembly 2: Diskette Drive, Hard Disk Drive .....	189
Assembly 3: CD-ROM, Modem Card .....	190
Assembly 4: Keyboard and Mouse .....	192

## Part Catalog of machine type 2193, 2194, and 6345

### Assembly 1: System Unit

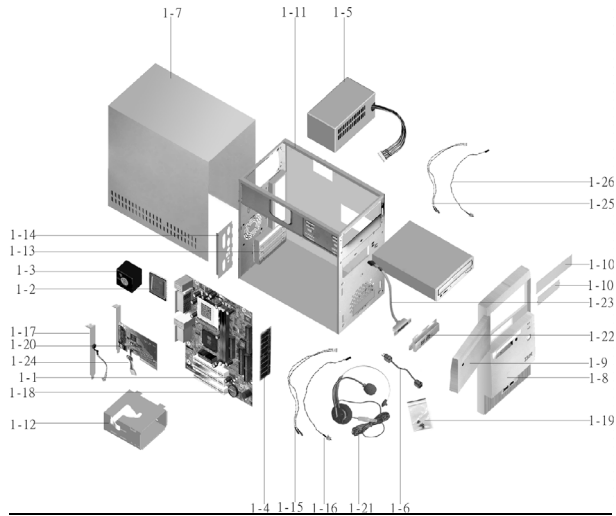

Asm-Index	FRU Number	Description
1-1	19K3582	Gigabyte 810E,GA-6WMMC7/e1 System Board
1-1	19K3284	Pro283 (SiS540) AMD System Board (type 2193)
1-2	10K2120	AMD K6-2-500MHz 100FSB E7 (w/o heatsink and fan)
1-2	19K3286	AMD K6-2-533MHz 100FSB E7 (w/o heatsink and fan)
1-2	19K3412	AMD K6-2-550MHz 100FSB E7 (w/o heatsink and fan)
1-2	19K3288	INTEL Celeron 500MHz 66FSB
1-2	19K3289	INTEL Celeron 533MHz 66FSB
1-2	19K3386	INTEL Celeron 600MHz 66FSB

1-2	19K3387	INTEL PIII 600MHz 133FSB
1-2	19K3388	INTEL, PIII 667MHz 133FSB
1-3	19K3292	Fansink, Supports PIII and Celeron 600MHz and up (PIII base) Processors
1-3	19K3348	Fansink, Supports K6-2 and Celeron (non-PIII base) Processors
1-4	19K3356	32MB module (PC100)
1-4	19K3293	64MB module (PC133)
1-4	19K3294	128MB module (PC133)
1-5	19K3308	95W Power Supply
1-6	6952301	Power Cord US/CE/CF/Taiwan
1-6	6952301	Power Cord LA-Lo Voltage
1-6	13F9978	Power Cord LA-Lo Voltage
1-6	13F9939	Power Cord Brazil
1-6	36L8879	Power Cord APU Countries
1-6	14F0032	Power Cord UK/HK/Singapore
1-6	13F9978	Power Cord Euro
1-6	14F0050	Power Cord Swiss
1-6	13F9996	Power Cord Denmark
1-6	14F0086	Power Cord Israel
1-6	14F0014	Power Cord South Africa

<b>1-6</b>	14F0068	Power Cord Italy
<b>1-6</b>	02K0545	Power Cord China
<b>1-6</b>	13F9939	Power Cord ANZ
<b>1-6</b>	36L9015	Power Cord Japan
<b>1-7</b>	09N5397	Top Cover, Used w/Chenming Chassis
<b>1-7</b>	19K3593	Top Cover, Used w/Enlight Chassis
<b>1-8</b>	19K3314	Main (Bezel) Panel w/USB
<b>1-8</b>	09N5400	Main (Bezel) Panel
<b>1-9</b>	09N5398	Bezel Door (Aptiva)
<b>1-9</b>	19K3375	Bezel Door (PC300)
<b>1-10</b>	09N5399	Drive Bay Panels (3.5" and 5.25")
<b>1-10</b>	19K3313	Drive Bay Panel, Bay 1 (5.25") w/EMC Shield
<b>1-11</b>	19K3315	Chassis (w/o power supply ) w/USB (Chenming)
<b>1-11</b>	19K3594	Chassis (w/o power supply ) w/o USB (Enlight)
<b>1-11</b>	19K3602	Chassis (w/o power supply ) w USB (Enlight)
<b>1-12</b>	09N5401	3.5" FDD/HDD (Holder) Bracket, Used w/Chenming Chassis
<b>1-12</b>	19K3595	3.5" FDD/HDD (Holder) Bracket, Used w/Enlight Chassis
<b>1-13</b>	09N5404	Port Bracket
<b>1-14</b>	19K3581	Planar I/O Port EMC Shield for Gigabyte board

<b>1-14</b>	19K3630	Planar I/O Port EMC Shield w/o LAN
<b>1-14</b>	19K3316	Planar I/O Port EMC Shield w/USB/LAN
<b>1-15</b>	19K3578	HDD-PWR LED/PWR Switch Cable Assembly for Gigabyte System board
<b>1-16</b>	19K3580	Y Audio Cable (for Gigabyte board)
<b>1-16</b>	19K3521	Y Audio Cable (for 2193)
<b>1-17</b>	19K3359	Speaker Port Bracket w/Cable
<b>1-18</b>	36L9077	CMOS Backup Battery (CR2032)
<b>1-19</b>	09N5409	Screw Pack
<b>1-20</b>	01N3003	Accton Ethernet Card
<b>1-21</b>	19K3312	Andrea Noise Cancelling, NC8
<b>1-22</b>	19K3603	USB Bracket (Enlight chassis)
<b>1-22</b>	19K3317	USB Bracket (Chenming chasis)
<b>1-23</b>	19K3318	USB Cable
<b>1-24</b>	19K3366	Speaker Cable, Internal, Used w/P&D Card MT/DT
<b>1-25</b>	09N5403	Power Switch Cable Assembly
<b>1-26</b>	09N5411	Led Cable Assembly

---

**Assembly 2: Diskette Drive, Hard Disk Drive**

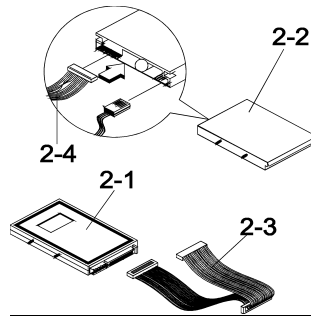

Asm-Index	FRU Number	Description
2-1	19K3298	5 GB Hard Disk Drive, 3.5"
2-1	10K2059	10 GB Hard Disk Drive, 3.5"
2-1	19K3299	15 GB Hard Disk Drive, 3.5"
2-1	19K3355	20 GB Hard Disk Drive, 3.5"
2-2	36L9130	3.5", Diskette Drive
2-3	19K3319	HDD IDE Cable (DMA 66 MHz)
2-4	19K3357	FDD IDE Cable



**Assembly 3: CD-ROM, Modem Card**

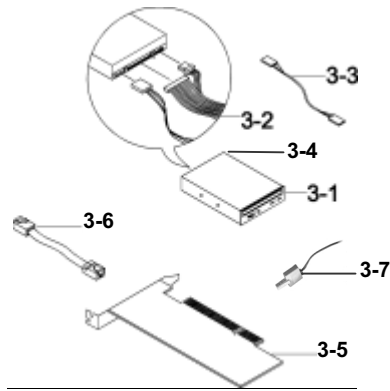

Asm-Index	FRU Number	Description
3-1	19K3360	40X CD-ROM, White
3-1	19k3300	48XCD-ROM, White
3-1	19K3301	32X CD-RW, White
3-1	19K3349	40X CD-ROM, Black Bezel
3-2	19K3358	CD-ROM IDE Cable
3-3	09N5406	CD-ROM Audio Cable (2194)
3-3	19K3337	CD-ROM Audio Cable (2193)
3-4	19K3302	40X/8X DVD-ROM, White
3-4	19K3350	40X/8X DVD-ROM, Black Bezel
3-5	09N5440	Modem, 56K Data Fax, GVC NA/LA/SA/TW/HK/China/ Japan

3-5	19K3303	Modem, 56K Data Fax, GVC EMEA/ANZ/India/Singapore
3-5	09N5441	Modem, 56K Data Fax, ASKEY NA/LA/SA/TW/HK/China/ Japan
3-5	19K3434	Modem, 56K Data Fax, Askey EMEA
3-5	10K2136	Modem, 56K Data Fax, Askey ANZ/India/Singapore
3-6	36L9016	7FT Phone Cord
3-6	09N5423	7FT Phone Cord, HK
3-7	01N1872	Modem Phone Cable Adapter Australia
3-7	01N1874	Modem Phone Cable Adapter NZ
3-7	60H6043	Modem Phone Cable Adapter Spain/Southern Ireland
3-7	60H6045	Modem Phone Cable Adapter Austria
3-7	60H6046	Modem Phone Cable Adapter Belgium
3-7	60H6047	Modem Phone Cable Adapter Denmark
3-7	60H6048	Modem Phone Cable Adapter Norway/Finland
3-7	60H6049	Modem Phone Cable Adapter FR
3-7	60H6050	Modem Phone Cable Adapter Germany
3-7	60H6051	Modem Phone Cable Adapter UK/Northern Ireland

<b>3-7</b>	60H6052	Modem Phone Cable Adapter Italy
<b>3-7</b>	60H6053	Modem Phone Cable Adapter Netherlands
<b>3-7</b>	60H6054	Modem Phone Cable Adapter Sweden
<b>3-7</b>	60H6055	Modem Phone Cable Adapter Switzerland

**Assembly 4: Keyboard and Mouse**

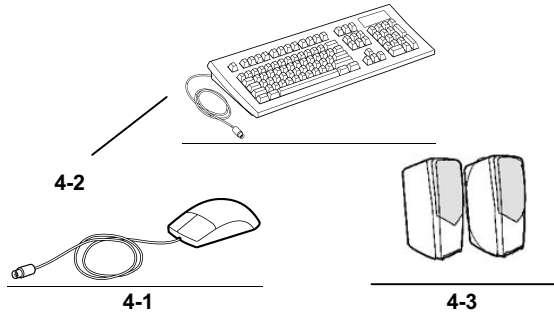

Asm-Index	FRU Number	Description
4-1	10L6145	Mouse, Badger
4-1	28L1865	Mouse, Scrollpoint II
4-2	37L2590	104 US ENGLISH 103P
4-2	37L2591	105 FR CANADIAN 058 (Commercial)
4-2	37L2592	105 FR CANADIAN 445 (Consumer)
4-2	37L2593	105 LA SPANISH 171
4-2	37L2594	105 BRAZILIAN/PORTUGUESE 275
4-2	37L2595	105 ARABIC 253
4-2	37L2596	105 BELGIUM UK 120
4-2	37L2597	105 DANISH 159
4-2	37L2598	105 DUTCH 143
4-2	37L2599	105 FRENCH 189

4-2	37L2600	105 GERMAN 129
4-2	37L2601	105 GREEK 319
4-2	37L2602	105 ITALIAN 142
4-2	37L2603	105 NORWEGIAN 155
4-2	37L2604	105 PORTUGUESE 163
4-2	37L2605	105 SPANISH 172
4-2	37L2606	105 SWED/FINNISH 153
4-2	37L2607	105 SWISS 150
4-2	37L2608	105 UK ENGLISH 166
4-2	37L2609	104 US ENGLISH-EMEA 103P ANZ
4-2	37L2610	109 JAPANESE 194
4-2	37L2611	104 CHINESE/US 467 HK/TW
4-2	37L2612	105 BELGIUM FRENCH 120
4-2	37L2640	105 ICELANDIC 197
4-2	37L2514	104 PALM REST US ENG 103P US/CHINA/ANZ/Singapore
4-2	37L0912	105 PALM REST FR CANADIAN 058 (Commercial)
4-2	37L2515	104 PALM REST FR CANADIAN 445 (Consumer)
4-2	37L2516	105 PALM REST LA SPANISH 171
4-2	37L2518	105 PALM REST ARABIC 275
4-2	37L2519	105 PALM REST, EURO BELGIUM/FR 120
4-2	37L2520	105 PALM REST, EURO BELGIUM/UK 120
4-2	37L2521	105 PALM REST BULGARIAN 442
4-2	37L2522	105 NO PALM REST CZECH 243

4-2	37L2523	105 PALM REST, EURO DANISH 159
4-2	37L2524	105 PALM REST, EURO DUTCH 143
4-2	37L2525	105 PALM REST, EURO FRENCH 189
4-2	37L2526	105 PALM REST, EURO GERMAN 129
4-2	37L2527	105 PALM REST, EURO GREEK 319
4-2	37L2528	104 PALM REST HEBREW 212
4-2	37L2529	105 PALM REST HUNGARIAN 208
4-2	37L2530	105 PALM REST ICELANDIC 197
4-2	37L2531	105 PALM REST, EURO ITALY 142
4-2	37L2532	105 PALM REST, EURO NORWEGIAN 155
4-2	37L2533	105 PALM REST POLISH 214
4-2	37L2534	105 PALM REST PORTUGUESE 163
4-2	37L2535	105 PALM REST ROMANIAN 446
4-2	37L2536	104 PALM REST RUSSIAN 443
4-2	37L2537	105 PALM REST SERBIAN/CYR 118
4-2	37L2538	105 PALM REST SLOVIC 245
4-2	37L2539	105 PALM REST, EURO SPANISH 145
4-2	37L2540	105 PALM REST, EURO SWED/FINN 153
4-2	37L2541	105 PALM REST, EURO SWISS 150
4-2	37L2542	105 PALM REST TURKISH 179
4-2	37L2543	105 PALM REST TURKISH 440
4-2	37L2544	105 PALM REST, EURO UK ENG 166

4-2	37L2545	105 PALM REST YUGOSL/LAT 234
4-2	37L2546	104 PALM REST US ENG- EMEA, ANZ/Singapore
4-2	37L2548	104 PALM REST CHINESE/US 467, HK/TW
4-2	37L2550	104 PALM REST THAILAND 191
4-2	37L2517	107 PALM REST BRAZILIAN/PORTUGUESE 275
4-2	37L2547	109 PALM REST JAPANESE 194
4-2	28L1860	KOREAN 413
4-3	19K3310	Passive Speaker, Zylux Tier 2 (No Adapter Req'd) No Logo, Blue Grill, PC99
4-3	10K2601	Infinity ( Zylux ), Active, Tier 1, Pearl White, PC99
4-3	10K2587	Speaker Power Adapter US/CE/LA/Taiwan
4-3	10K2591	Speaker Power Adapter EURO and LA High Voltage Models
4-3	10K2589	Speaker Power Adapter GB/UK includes Scotland/England/Northern Ireland/Wales and HK
4-3	10K2595	Speaker Power Adapter ANZ, APU
4-3	10K2597	Speaker Power Adapter China
4-3	10K2593	Speaker Power Adapter Japan
4-3	10K2789	Speaker Power Adapter Brazil
4-3	19K3635	Jazz Speaker J-205A, Active, PC99
4-3	19K3636	Jazz Speaker Power Adapter PPI-0940-UL US, LA(LoVolt), Canada, Mexico, Peru, Colombia, Ecuador, Venezuela, Bolivia, Panama, El Salvador, Honduras, Nicaragua, Dominican Republic, Guatemala, Taiwan, Saudi Arabia, Thailand
4-3	19K3639	Jazz Speaker Power Adapter, TEAC-41-090400V, (Euro) France, Germany, Sweden,

		Norway, Netherlands, Finland, Belgium, Bosnia, Croatia, Egypt, Greece, Hungary, Poland, Portugal, Romania, Slovenia, Spain, Sweden, Turkey, LA (HI Volt), Danish, Swiss, Italy
<b>4-3</b>	19K3638	Jazz Speaker Power Adapter, TEAC-41-090400V Includes Scotland/England/Northern Island/Wales/GB/HK/Singapore/United Arab Emirate (Dubai)
<b>4-3</b>	19K3637	Jazz Speaker Power Adapter, TEAC-41-090400V, ANZ, APU
<b>4-3</b>	19K3641	Jazz Speaker Power Adapter, CH0026677089 China
<b>4-3</b>	19K3640	Jazz Speaker Power Adapter, T-MARK 61-17459, Japan



## Part Catalog of machine type 2196, 2197, and 6344

### Assembly 1: System Unit

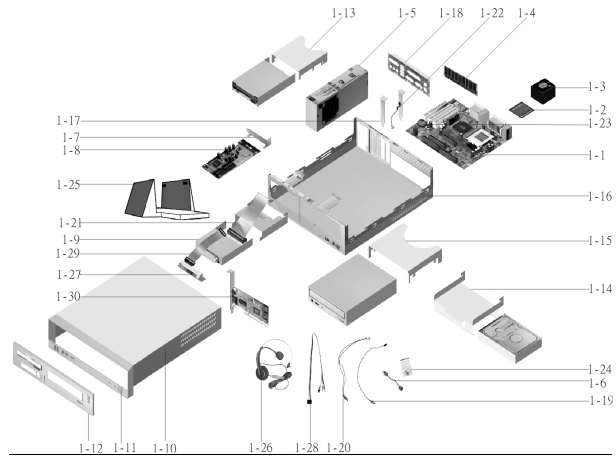

Asm-Index	FRU Number	Description
1-1	19K3284	Pro283 System board
1-1	19K3285	Pro286 System board
1-1	19K3629	Pro286 System board, for Celeron Processors only, w/ LAN
1-1	19K3584	MSI-6188 810E
1-2	19K3286	AMD K6-2-533MHz 100FSB E7 (w/o heatsink and fan)
1-2	19K3412	AMD K6-2-550MHz 100FSB E7 (w/o heatsink and fan)
1-2	19K3288	INTEL Celeron 500MHz 66FSB
1-2	19K3289	INTEL Celeron 533MHz 66FSB
1-2	19K3386	INTEL Celeron 600MHz 66FSB
1-2	19K3291	INTEL, PIII 550MHz 100FSB
1-2	19K3387	INTEL, PIII 600MHz 133FSB
1-2	19K3388	INTEL, PIII 667MHz 133FSB

1-3	19K3348	Fansink, Supports K6-2 and Celeron Processors
1-3	19K3292	Fansink, Supports PIII Processors and Celeron 600 and up
1-4	19K3356	32MB module (PC100)
1-4	19K3293	64MB module (PC133)
1-4	19K3294	128MB module (PC133)
1-5	19K3309	95W Power Supply (LP)
1-5	19K3585	95W used w/MSI-6188 810E Planar
1-6	6952301	Power Cord US/CE/CF/Taiwan
1-6	6952301	Power Cord LA-Lo Voltage
1-6	36L8879	Power Cord APU Countries
1-6	14F0032	Power Cord UK/HK/Singapore/United Arab Emirate (Dubai)
1-6	13F9978	Power Cord (Euro) France, Germany, Sweden, Norway, Netherlands, Finland, Belgium, Bosnia, Croatia, Egypt, Greece, Hungary, Poland, Portugal, Romania, Slovenia, Spain, Sweden, Turkey, LA (HI Volt)
1-6	13F9939	Power Cord ANZ
1-6	14F0050	Power Cord Swiss
1-6	13F9996	Power Cord Denmark
1-6	14F0068	Power Cord Italy,Chile
1-6	14F0086	Power Cord Israel
1-6	14F0014	Power Cord South Africa
1-6	36L9015	Power Cord Japan
1-6	02K0545	Power Cord China
1-7	19K3520	PCMCIA (Holder) Bracket, Req'd all mdl's for DASD support, DT
1-8	19K3297	PCMCIA Card

<b>1-9</b>	19K3330	PCMCIA Device
<b>1-10</b>	19K3320	Top Cover
<b>1-11</b>	19K3321	Main (Bezel) Panel w/USB/Audio/Volumn
<b>1-11</b>	19K3322	Main (Bezel) Panel wo/USB/Audio/Volumn
<b>1-12</b>	19K3323	Outer(Bezel) Panel w/FDD/CD-ROM slots, Blue, DT,Aptiva
<b>1-12</b>	19K3324	Outer(Bezel) Panel w/FDD/CD-ROM slots, Blue,DT,Aptiva
<b>1-12</b>	19K3325	Outer(Bezel) Panel w/FDD/CD-ROM slots, White (for PC300)
<b>1-12</b>	19K3326	Outer(Bezel) Panel w/FDD slot, White
<b>1-13</b>	19K3327	FDD(Holder) Bracket
<b>1-14</b>	19K3328	HDD(Holder) Bracket
<b>1-15</b>	19K3329	CD-ROM(Holder) Bracket
<b>1-16</b>	19K3331	Chassis (wo/power supply)
<b>1-17</b>	19K3333	Port Bracket LP/PCI
<b>1-18</b>	19K3334	Planar I/O Port EMC Shield
<b>1-18</b>	19K3591	Planar I/O Port EMC Shield (includes label), Used w/MSI-6188 810E Planar
<b>1-19</b>	19K3335	Power Switch Cable Assembly
<b>1-20</b>	19K3336	LED Cable Assembly
<b>1-21</b>	19K3339	PCMCIA Cable
<b>1-22</b>	19K3344	Speaker PCI Port Bracket w/Cable
<b>1-23</b>	36L9077	CMOS Backup Battery (CR2032)
<b>1-24</b>	19K3346	Screw Pack
<b>1-25</b>	19K3347	System Stand, Blue
<b>1-26</b>	19K3312	Microphone Andrea Noise Canceling, NC8
<b>1-27</b>	19K3296	Volume Cntrl/Speaker Jack/USB/Microphone w/Bracket
<b>1-28</b>	19K3579	HDD-PWR LED/PWR Switch Cable Assembly, Used w/MSI-6188 810E Planar

<b>1-29</b>	19K3338	Cable Asm, (Volume Cntrl/Speaker Jack/USB/Microphone
<b>1-30</b>	19K4309	Accton Ethernet 10/100 PCI Card w/low profile bracket

---

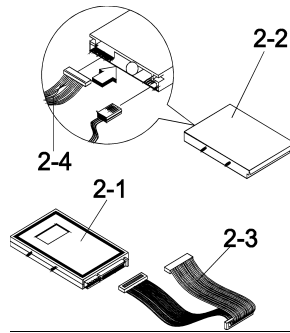
**Assembly 2: Diskette Drive, Hard Disk Drive**

Asm-Index	FRU Number	Description
2-1	19K3298	5GB Hard Disk Drive, 3.5"
2-1	10K2059	10 GB Hard Disk Drive, 3.5"
2-1	19K3299	15 GB Hard Disk Drive, 3.5"
2-1	19K3355	20 GB Hard Disk Drive, 3.5"
2-2	36L9130	3.5", Diskette Drive
2-3	19K3341	Hard Disk Drive Cable
2-4	19K3340	Diskette Drive Cable

**Assembly 3: CD-ROM, Modem Card**

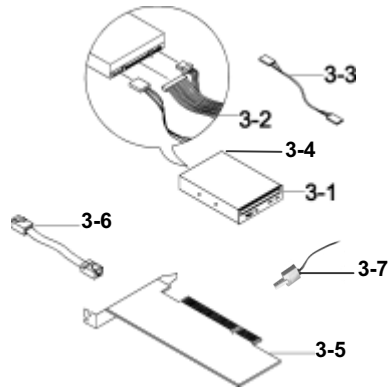

Asm-Index	FRU Number	Description
3-1	19K3360	40X CD-ROM, White
3-1	19k3300	48XCD-ROM, White
3-1	19K3301	32X CD-RW, White
3-1	19K3413	32X CD-ROM, Black Bezel
3-1	19K3643	48X CD-ROM, Black Bezel
3-1	19K3349	40 X CD-ROM, Black Bezel
3-2	19K3342	CD-ROM Cable
3-3	09N5406	CD-ROM Audio Cable (for MSI board)
3-3	19K3337	CD-ROM Audio Cable (for Pro board)

<b>3-4</b>	19K3302	40X/8X DVD-ROM, White
<b>3-4</b>	19K3350	40X/8X DVD-ROM, Black Bezel
<b>3-5</b>	19K3304	Modem, 56K Data Fax, ASKEY w/LP Brkt NA/LA/SA/TW/HK/China/Japan
<b>3-5</b>	19K3306	Modem, 56K Data Fax, ASKEY w/LP Brkt ANZ/India/Singapore
<b>3-6</b>	36L9016	7FT Phone Cord
<b>3-6</b>	09N5423	7FT Phone Cord , HK
<b>3-7</b>	01N1872	Phone Cord Adapter Australia
<b>3-7</b>	01N1874	Phone Cord Adapter NZ

**Assembly 4: Keyboard and Mouse**

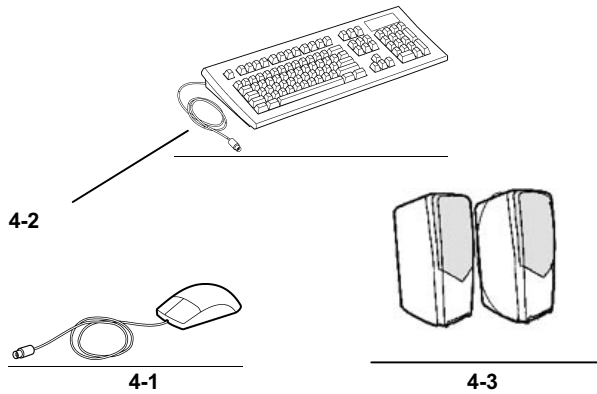

Asm-Index	FRU Number	Description
4-1	10L6145	Mouse, Badger
4-1	28L1865	Mouse, Scrollpoint II
4-2	37L2609	104 US ENGLISH-EMEA 103P
4-2	37L2610	ANZ 109 JAPANESE 194
4-2	37L2611	104 CHINESE/US 467 HK/TW
4-2	37L2514	104 PALM REST US ENG 103P US/CHINA/ANZ/Singapore
4-2	37L0912	105 PALM REST FR CANADIAN 058 (Commercial)
4-2	37L2516	105 PALM REST LA SPANISH 171
4-2	37L2518	105 PALM REST ARABIC 275
4-2	37L2519	105 PALM REST, EURO BELGIUM/FR 120
4-2	37L2520	105 PALM REST, EURO BELGIUM/UK 120
4-2	37L2521	105 PALM REST BULGARIAN 442



4-2	37L2522	105 NO PALM REST CZECH 243
4-2	37L2523	105 PALM REST, EURO DANISH 159
4-2	37L2524	105 PALM REST, EURO DUTCH 143
4-2	37L2525	105 PALM REST, EURO FRENCH 189
4-2	37L2526	105 PALM REST, EURO GERMAN 129
4-2	37L2527	105 PALM REST, EURO GREEK 319
4-2	37L2528	104 PALM REST HEBREW 212
4-2	37L2529	105 PALM REST HUNGARIAN 208
4-2	37L2530	105 PALM REST ICELANDIC 197
4-2	37L2531	105 PALM REST, EURO ITALY 142
4-2	37L2532	105 PALM REST, EURO NORWEGIAN 155
4-2	37L2533	105 PALM REST POLISH 214
4-2	37L2534	105 PALM REST PORTUGUESE 163
4-2	37L2535	105 PALM REST ROMANIAN 446
4-2	37L2536	104 PALM REST RUSSIAN 443
4-2	37L2537	105 PALM REST SERBIAN/CYR 118
4-2	37L2538	105 PALM REST SLOVIC 245
4-2	37L2539	105 PALM REST, EURO SPANISH 145
4-2	37L2540	105 PALM REST, EURO SWED/FINN 153
4-2	37L2541	105 PALM REST, EURO SWISS 150
4-2	37L2542	105 PALM REST TURKISH 179
4-2	37L2543	105 PALM REST TURKISH 440
4-2	37L2544	105 PALM REST, EURO UK ENG 166

4-2	37L2545	105 PALM REST YUGOSL/LAT 234
4-2	37L2546	104 PALM REST US ENG- EMEA, ANZ
4-2	37L2548	104 PALM REST CHINESE/US 467 HK/TW
4-2	37L2550	104 PALM REST THAILAND 191
4-2	37L2517	107 PALM REST BRAZILIAN/PORTUGUESE 275
4-2	37L2547	109 PALM REST JAPANESE 194
4-2	28L1860	KOREAN 413
4-3	19K3310	Passive Speaker, Zylux Tier 2 (No Adapter Req'd) No Logo, Blue Grill, PC99

---

## Appendix A. Online Support Information

This section describes online technical support services available to help repair the computer.

This section covers:

- IBM PC Company Fax-Back Service
- IBM useful sites on the World Wide Web (WWW)
- IBM Online Assistant
- Discussion Forums

The IBM PC Company offers online resources including several Internet World Wide Web sites, the IBM Online HelpCenter support areas, and a Fax-Back service.

The IBM Automated Fax-Back System offers a variety of IBM computer-related articles. To access this service, call 800-IBM-3395. The Fax-Back system file library can also be accessed through the PC Company BBS.

The IBM Online Assistant will help you to diagnose and resolve technical problems by giving you access to the same tools used by IBM PC HelpCenter specialists. IBM Online Assistant guides you from symptom to resolution, by asking simple questions based on the collective experience of IBM senior support specialists. In addition many recommended next steps link to the extensive IBM online library, providing access to supporting information during the diagnostic process. To access the Online Assistant go to the IBM support web site, (<http://www.ibm.com/support>) press the profile button and set up your personal profile. Your profile will give you access to the IBM Online Assistant through your personalized page.

For other technical questions your personalized page will also give you access to IBM Discussion Forums. The forums are monitored by IBM HelpCenter technicians to answer your technical questions.

Here are useful IBM Internet addresses for information:

<http://www.ibm.com/support>

IBM Home Page on the World Wide Web

---

## Index

### A

- Adapter Cards
  - Installing, 114
  - Removing, 115
- Audio
  - Check Procedure, 89
  - Error Symptoms, 80

### B

- Beeeps, 63, 69, 70
- BIOS
  - Flash Update Procedure, 46
  - Model Number and Serial Number, 47
- BIOS setup Utility, 48

### C

- Cabling, 41
- CD-ROM Drive, 40, 43, 118, 162
  - Check Procedure, 91
  - Connectors and Features, 163
  - Emergency-exit, 162
  - Error Symptoms, 78
  - Front Panel, 162
  - Jumper Settings, 163
- Check Procedures, 62
- CMOS Reset, 45

### D

- Diagnostic Aids, 103
- Diagnostic Diskette, 82
- Diagnostic Program
  - Error symptoms, 82
- Diagnostic Program
  - Using from Recovery CD, 105
- Diagnostic Tools, 105
- Diskette Drive, 40, 43, 116
  - Connector Signals, 166
  - Error Symptoms, 77

### E

- Electrical Input, 59
- Error Codes, 69, 70
- Error Messages, 69, 70
- Error Symptoms, 69, 76
- External Ports, 39
  - Ethernet Port, 44
  - Game Port, 44
  - Parallel Port, 44
  - Serial Port, 44
  - USB port, 44

### F

- Fan
  - Error Symptoms 76, 96

### H

- Hard Disk Drive 40, 119
  - 3.5-In. Jumper Locations & Settings, 161
  - 32-bit Access, 43
  - Check Procedure, 85
  - Error Symptoms, 78
  - PIO Mode, 54
  - Hard Disk Drive, 43

### I

- IDE
  - Connector Signals, 167

### J

- Joystick, 44, 106
  - Error Symptoms, 82

### K

- Keyboard, 41
  - Check Procedure, 92
  - Error Symptoms, 82
- Keyboard Port
  - Port Signals, 165

**M**  
Memory, 38  
    Check Procedure, 92  
    DIMM Configurations, 164  
    Error Symptoms, 76  
Model Number, 47  
Modem, 41  
    Check Procedure, 87  
    Connector Functions, 160  
    Error Symptoms, 80  
    Layout, 160  
Monitor, 41  
    Check Procedure, 99  
    Error Symptoms, 80  
    Port Signals, 164  
Mouse, 42  
    Check Procedure, 93  
Mouse Port  
    Port Signals, 165  
Multimedia, 40

PIO Mode, 54  
Plug and Play, 5  
POST, 64  
Power Consumption, 59  
Power Management, 40, 55

**O**  
Online Support Information,  
185

**P**  
Parallel Port, 44, 53  
    Error Symptoms, 81  
    Port Signals, 165  
Parts Catalog of machine type  
2193, 2194 and 6345, 171  
    CD-ROM, Modem Card,  
    177  
    Diskette Drive, Hard Disk  
    Drive, 176  
    Keyboard and Mouse, 180  
    System Unit, 172  
Parts Catalog of machine type  
2196, 2197 and 6344, 185  
    CD-ROM, Modem Card,  
    190  
    Diskette Drive, Hard Disk  
    Drive, 189  
    Keyboard and Mouse, 192  
System Unit, 185  
Parts/Test Point Locations,  
139  
Password  
    Setting, 58  
PCI, 43

Power Supply, 41  
  Check Procedure, 96  
  Connector Specifications,  
  143  
  Error Symptoms, 82  
Processor  
  Error Symptom, 76

## **R**

Real-Time Clock  
  Error Symptoms 79  
Removals and Replacements  
  of the machine type 2193,  
  2194 and 6345, 110  
  Adapter Cards, 114  
  CD-ROM Drive, 118  
  Diskette Drive, 116  
  Hard Disk Drive, 119  
  Memory (DIMM), 123  
  Power Supply, 121  
  System Board, 120  
  Top Cover, 113  
Repair Information, 109  
Removals and Replacements  
  of the machine type 2196,  
  2197 and 6344, 124  
  Adapter Cards, 128  
  CD-ROM Drive, 131  
  Diskette Drive, 132  
  Hard Disk Drive, 132  
  Memory (DIMM), 137  
  Power Supply, 136  
  System Board, 133  
  Top Cover, 127  
Repair Information, 109

## **S**

Safety Inspection Guide, 169  
Serial Number, 47  
Serial Port, 39, 44, 53  
  Error Symptoms, 81  
  Port Signals, 164  
service level A (SL-A), 36  
Specifications, 59  
  Dimensions, 59  
  Electrical Input, 59  
  Environment, 59  
  Power Consumption, 59  
  Weight, 59  
System Board  
196

Layout of the Machine  
Type 2194 (Italy), 2197  
and 6344 (EMEA/AP), 141

Processor Type Jumper  
Setting of the Machine  
Type 2194 (Italy), 2197  
and 6344 (EMEA/AP), 142  
Connector and Functions  
of the Machine Type 2194  
(Italy), 2197 and 6344  
(EMEA/AP), 143  
Error Symptoms, 76

## **T**

Tools, 61

## **U**

Undetermined Problems  
  Check Procedure, 101  
USB, 44

## **V**

Video, 39  
  Error Symptoms, 80



Printed in U.S.A.

International Business Machines Corporation  
Old Orchard Road,  
Armonk, New York 10504

Part Number: 19K2493

Pub Number: S19K-2493-00

3/00