

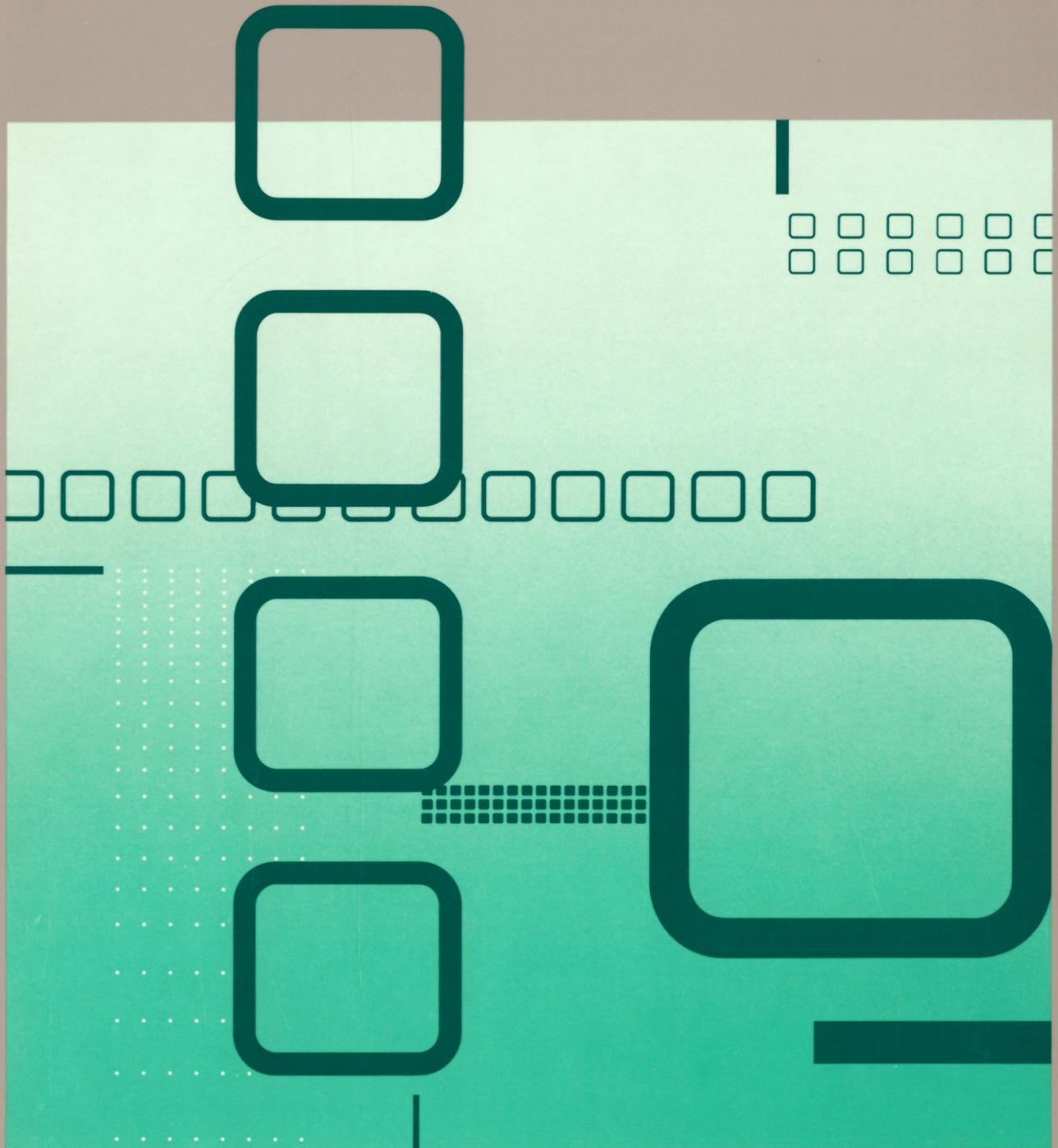

**Problem  
Determination  
Guide**





---

# Token-Ring Network

## Problem Determination Guide

## Federal Communications Commission (FCC) Statement

**Warning:** This equipment generates, uses, and can radiate radio frequency energy and if not installed and used in accordance with the instructions manual, may cause interference to radio communications. It has been tested and found to comply with the limits for a Class A computing device pursuant to Subpart J of Part 15 of FCC Rules, which are designed to provide reasonable protection against such interference when operated in a commercial environment. Operation of this equipment in a residential area is likely to cause interference in which case the user at his own expense will be required to take whatever measures may be required to correct the interference.

**Instructions to User:** If this equipment does cause interference to radio or television reception, which can be determined by turning the equipment off and on, the user is encouraged to try to correct the interference by one or more of the following measures:

- Reorient the receiving antenna.
- Relocate the computer with respect to the receiver.
- Move the computer away from the receiver.
- Plug the computer into a different outlet so that computer and receiver are on different branch circuits.

Properly shielded and grounded cables and connectors must be used for connection to peripherals in order to meet FCC emission limits. Proper cables are available from IBM authorized dealers. IBM is not responsible for any radio or television interference caused by using other than recommended cables or by unauthorized modifications to this equipment. It is the responsibility of the user to correct such interference.

If necessary, the user should consult the dealer or an experienced radio/television technician for additional suggestions. The user may find the following booklet prepared by the Federal Communications Commission helpful:

### *How to Identify and Resolve Radio-TV Interference Problems*

This booklet is available from:

Consumer Assistance and Small Business Division Room 254 1919 M St. NW Washington, DC 20554 Tele (202) 632-7000	FOB Public Contact Branch Room 725 1919 M St. NW Washington, DC 20554 Tele (202) 634-1940
--------------------------------------------------------------------------------------------------------------------------------	-------------------------------------------------------------------------------------------------------

**Note:** This product is intended for use within a single establishment and within a single, homogeneous user population. For sensitive applications requiring isolation from each other, management may wish to provide isolated cabling or to encrypt the sensitive data before putting it on the network.

### Revised Edition (November 1988)

This is a revision of SX27-3710-2, which is now obsolete. Significant new material has been added throughout, and existing material has been changed. See "Summary of Changes" on page iii.

It is possible that this material may contain reference to, or information about, IBM products (machines or programs), programming, or services that are not announced in your country. Such references or information must not be construed to mean that IBM intends to announce such IBM products, programming, or services in your country.

Publications are not stocked at the address given below; requests for IBM publications should be made to your IBM representative or to the IBM branch office serving your locality.

A form for reader's comments is provided at the back of this publication. If the form has been removed, comments may be addressed to IBM Corporation, Communications Products Information Development, Department E02, PO Box 12195, Research Triangle Park, North Carolina, U.S.A. 27709. IBM may use or distribute any of the information you supply in any way it believes appropriate without incurring any obligation whatever. You may, of course, continue to use the information you supply.

---

## Preface

This guide provides problem determination procedures for isolating and correcting problems with an IBM Token-Ring Network operating at either 4 or 16 megabits per second (Mbps). Problems in communications devices attached to the ring are handled by their own problem determination procedures.

This guide is intended for customer personnel who must maintain their networks and who are responsible for the isolation and resolution of network problems. The guide is also intended for use by IBM maintenance personnel. It is designed to be used with the IBM Token-Ring Network Ring Diagnostic (on the Token-Ring Adapter Diskette), the IBM Local Area Network Manager, or a network application program that provides ring status and fault domain information. Instructions on how to use the Ring Diagnostic appear in Part 2 of this guide. Refer to the *IBM Local Area Network Manager User's Guide* for information on the IBM Local Area Network Manager.

---

## Summary of Changes

The majority of the changes in this edition are the result of significant additions to the procedures previously found in Chapter 4 of the manual. These new procedures are now in Chapter 3. The procedure for experienced trouble-shooters formerly in Chapter 3 is now in Chapter 4.

This edition also includes minor editorial and technical changes.



---

## How to Use This Guide

This guide consists of an introduction followed by two parts.

Chapter 1, the introduction, explains the phases of the problem determination process. You should read it before problem determination is needed. This chapter also contains a brief description of the IBM Token-Ring Network design and the error detection and recovery capability of the IBM Token-Ring Network PC Adapter.

**Part 1, "The Problem Determination Procedures,"** contains three chapters:

- Read Chapter 2 to find out what you will need to know and the items you will need to perform the problem determination procedures. This chapter explains how to perform some of the frequently occurring tasks in the procedures. Chapter 2 also provides information about using your network documentation to find components on the ring. Read these instructions before starting or refer to them when needed.
- Chapter 3 contains the complete problem determination procedures, preceded by a brief discussion of how the procedures should be used. These procedures themselves begin on "Starting the Problem Determination Procedures" on page 3-5.
- Chapter 4 contains a ring recovery procedure for the *experienced* troubleshooter. These procedures may be used instead of the procedures in Chapter 3 to deal with beaconing and soft error conditions.

**Part 2, "The Ring Diagnostic,"** provides information about the diagnostic aid contained on the diskette that accompanies the IBM Token-Ring Network PC Adapter, 16/4 Adapter, Adapter II, 16/4 Adapter/A, or Adapter/A. The IBM Token-Ring Network Ring Diagnostic runs on an IBM Personal Computer or IBM PERSONAL SYSTEMS/2® computer. It provides messages that indicate the status of the ring. Part 1 tells you when to use the Ring Diagnostic. Part 2 provides complete information about how to use the Ring Diagnostic. It contains two chapters:

- Follow the instructions in Chapter 5 to load and set up the files necessary to use the Ring Diagnostic.
- Read Chapter 6 to learn how to start the Ring Diagnostic. The chapter also describes the Ring Diagnostic data area messages and tells how to use this information in determining what events are occurring on the IBM Token-Ring Network.

The Appendixes contain procedures that deal with special situations. Appendix A provides information about using your network documentation to find components in the ring. Appendix B contains a list of error codes that will help you in troubleshooting.

The Glossary defines terms and abbreviations used in this guide.

---

## Related Publications

For additional information, refer to the IBM publications listed below. Consult your IBM representative or your IBM local branch office for information on how to obtain these publications.

- *IBM Cabling System Planning and Installation Guide*, GA27-3361
- *Using the IBM Cabling System with Communication Products*, GA27-3620
- *IBM Token-Ring Network Introduction and Planning Guide*, GA27-3677
- *IBM Token-Ring Network Telephone Twisted-Pair Media Guide*, GA27-3714
- *IBM Token-Ring Network Installation Guide*, GA27-3678
- *IBM Token-Ring Network PC Adapter Guide to Operations* (with adapter and diskette)
- *IBM Token-Ring Network 16/4 Adapter Guide to Operations* (with adapter and diskette)
- *IBM Token-Ring Network PC Adapter Technical Reference*
- *IBM Token-Ring Network NETBIOS User's Guide* (with diskette)
- *IBM Token-Ring Network Manager User's Guide* (with diskette)
- *IBM Token-Ring Network Architecture Reference*
- *IBM Token-Ring Network Bridge Program User's Guide* (with diskette)
- *IBM Token-Ring Network/PC Network Interconnect User's Guide* (with diskette)
- *Local Area Network Support Program*
- *IBM Token-Ring Network Adapter/A Installation and Testing Instructions* (with adapter and diskette)
- *IBM Token-Ring Network 16/4 Adapter/A Installation and Testing Instructions* (with adapter and diskette)
- *Quick Reference for the IBM Personal System/2 Computer*
- *IBM Local Area Network Manager's User's Guide* (with diskette)
- *IBM Local Area Network Administrator's Guide*, GA27-3748
- *IBM Local Area Network Technical Reference*.



# Contents

<b>Chapter 1. Introduction</b> . . . . .	1-1
The Problem Determination Process . . . . .	1-3
IBM Token-Ring Network Design . . . . .	1-4
Error Detection and Removal . . . . .	1-9

---

## Part 1. Problem Determination

<b>Chapter 2. Preparing for Problem Determination</b> . . . . .	2-1
Using this Chapter . . . . .	2-3
Some Problem Determination Suggestions . . . . .	2-3
What You Need . . . . .	2-4
Records . . . . .	2-4
Equipment . . . . .	2-4
Other Publications . . . . .	2-5
Format of the Problem Determination Procedures . . . . .	2-6
Using the Diagrams . . . . .	2-7
<b>Chapter 3. The Problem Determination Procedures</b> . . . . .	3-1
Using the Procedures . . . . .	3-3
Starting the Problem Determination Procedures . . . . .	3-5
Ring Recovery: Beaconsing . . . . .	3-7
Ring Recovery: Beaconsing on the Backup Ring . . . . .	3-14
Beacon Isolation - Part 1 . . . . .	3-16
Beacon Isolation - Part 2 . . . . .	3-21
Beacon Isolation - Part 3 . . . . .	3-24
Ring Recovery for Soft Errors, Part 1 . . . . .	3-28
Ring Recovery for Soft Errors, Part 2 . . . . .	3-33
Soft Error Isolation with One Address Known . . . . .	3-37
Diagnosing Intermittent Beaconsing Conditions . . . . .	3-39
Diagnosing Intermittent Soft Errors . . . . .	3-41
Open Errors, Part 1 . . . . .	3-43
Open Errors, Part 2 — Signal Loss . . . . .	3-44
Open Errors, Part 3 — Time-Out . . . . .	3-45
Open Errors, Part 4 — Ring Failure or Beaconsing . . . . .	3-46
Open Errors, Part 5 — Duplicate Address . . . . .	3-47
Open Errors, Part 1, for Remote Program Load . . . . .	3-49
Open Errors, Part 2, for Remote Program Load . . . . .	3-50
Open Errors, Part 3, for Remote Program Load . . . . .	3-51
Open Errors, Part 4, for Remote Program Load . . . . .	3-52
Open Errors, Part 5, for Remote Program Load . . . . .	3-53
Open Errors, Part 6, for Remote Program Load . . . . .	3-55
Open Errors, Part 7, for Remote Program Load . . . . .	3-56
Only Adapter on the Ring . . . . .	3-57
Only Adapter on the Ring for Remote Program Load . . . . .	3-58
Manual Procedure, Part 1 . . . . .	3-59
Manual Procedure, Part 2 . . . . .	3-62
Manual Procedure, Part 3 . . . . .	3-67
Manual Procedure, Part 4 . . . . .	3-70
Manual Procedure, Part 5 . . . . .	3-78
Manual Procedure, Part 6 . . . . .	3-83
Manual Procedure, Part 7 . . . . .	3-88

Manual Procedure, Part 1, for Remote Program Load	3-89
Manual Procedure, Part 2, for Remote Program Load	3-92
Manual Procedure, Part 3, for Remote Program Load	3-97
Manual Procedure, Part 4, for Remote Program Load	3-100
Manual Procedure, Part 5, for Remote Program Load	3-102
Manual Procedure, Part 6, for Remote Program Load	3-104
Manual Procedure, Part 7, for Remote Program Load	3-107
Testing IBM 8228s	3-108
Testing IBM 8218s and IBM 8219s	3-109
Ring Wrapped or Loss of Critical Resource	3-113
Testing an IBM 8220 Optical Fiber Subsystem	3-114
Isolation of an IBM 8220 Optical Fiber Subsystem	3-115
IBM 8220 Self-Test	3-119
Duplicate Address on an IBM 8220	3-121
Testing Patch Cables	3-122
Testing Ring Segments	3-123
Wire Fault, Auto-Removal, or Open Errors (Function Failure)	3-125
Wire Fault, Auto Removal, or Open Error (Function Failure) for Remote Program Load	3-126
Isolation of an IBM 8228	3-127
Isolation of an IBM 8228 for Remote Program Load	3-130
IBM 8228/Adapter Test	3-132
Lobe Logic Isolation (Beaconing and Open Errors)	3-134
Lobe Logic Isolation (Beaconing and Open Errors) for Remote Program Load	3-136
Lobe Logic Isolation, Soft Errors	3-137
Lobe Logic Isolation, Soft Errors, for Remote Program Load	3-138
Lobe Logic Isolation, NAUN's Lobe	3-139
Device and Lobe Error Isolation	3-140
Adapter/Cable Isolation	3-142
Excessive Ring Error Reports	3-146
Session Errors, Part 1	3-147
Session Errors, Part 2	3-149
Session Errors, Part 3	3-150
Session Errors, Part 4	3-151
Errors When Processing Data Received from Other Devices	3-152
Errors When Processing Data Received from Other Devices for Remote Program Load	3-154
Isolation of an Optical Fiber Ring Segment, Part 1	3-156
Isolation of an Optical Fiber Ring Segment, Part 2	3-159
Isolation of IBM 8218s	3-162
IBM 8218/8219/8220 Power Problems	3-163
Diagnosing Difficult Ring Problems	3-166
Diagnosing Difficult Lobe Problems	3-167
Diagnosing Difficult Lobe Problems for Remote Program Load	3-169
Testing Data Cables	3-171
Repairing a Data Cable	3-176
Replacing a Defective IBM 8228	3-177
Replacing a Defective IBM 8218	3-178
Replacing a Defective IBM 8219	3-179
Replacing a Defective IBM 8220	3-180
<b>Chapter 4. Ring Recovery Procedure for the Experienced Trouble-Shooter</b>	<b>4-1</b>
Using the Procedures	4-3
What You Need	4-4
Getting Started	4-4

---

**Part 2. The Ring Diagnostic**

<b>Chapter 5. Preparing a Diskette for the Ring Diagnostic</b> . . . . .	5-1
Introduction . . . . .	5-3
What You Need . . . . .	5-4
Preparing to Run Ring Diagnostics . . . . .	5-5
Preparing the Diskette . . . . .	5-6
The Ring Diagnostic Parameters . . . . .	5-7
Required Parameter . . . . .	5-7
Optional Parameters . . . . .	5-7
Memory Map . . . . .	5-9
Setting the Parameters . . . . .	5-11
<b>Chapter 6. Using the Ring Diagnostic</b> . . . . .	6-1
Starting the Ring Diagnostic . . . . .	6-3
Output of the Ring Diagnostic . . . . .	6-4
The Function Keys . . . . .	6-6
The Ring Status Area . . . . .	6-10
Ring Diagnostic Status Area Messages . . . . .	6-11
Data Area Messages . . . . .	6-14
Format . . . . .	6-14
Descriptions . . . . .	6-15
<b>Appendix A. How to Find Devices and Components</b> . . . . .	A-1
How to Find Devices and Components . . . . .	A-3
Finding a Device Using the Adapter Address . . . . .	A-4
Finding a Device Using Its IBM 8228 . . . . .	A-6
Finding the IBM 8228 for a Device . . . . .	A-10
Finding IBM 8218s, IBM 8219s and IBM 8220s . . . . .	A-15
Finding the Component in a Given Position in the Ring Sequence . . . . .	A-19
Finding the Next Downstream and Upstream IBM 8228 . . . . .	A-21
Finding the First and Last Component in a Wiring Closet . . . . .	A-23
Finding Bridges . . . . .	A-25
How to Bypass an IBM 8228 . . . . .	A-27
How to Identify the Fault Domain . . . . .	A-29
Identifying the Fault Domain of a Beaconing Condition . . . . .	A-29
Identifying the Fault Domain for Beaconing on the Backup Ring . . . . .	A-33
Identifying the Fault Domain of a Soft Error . . . . .	A-37
<b>Appendix B. Return Codes</b> . . . . .	B-1
DLC and Direct Interface Return Codes (CCB_RETCODE) . . . . .	B-3
DLC Status Codes . . . . .	B-20
DLC Status Table . . . . .	B-20
DLC Status Codes . . . . .	B-21
Suggested Actions in Response to DLC Status . . . . .	B-22
NETBIOS Return Codes (NCB_RETCODE) . . . . .	B-24
NETBIOS Return Codes . . . . .	B-26
Adapter Status Parameter Table . . . . .	B-35
Frame Status . . . . .	B-36
Exception Indications . . . . .	B-37
Adapter Check for CCB1 . . . . .	B-37
Adapter Check for CCB2 . . . . .	B-37
Adapter Check for CCB3 . . . . .	B-39



IBM Token-Ring Network Adapter Check Reason Codes for All CCBs . . . . .	B-41
IBM PC Network Adapter Check Reason Codes for All CCBs . . . . .	B-42
Network Status . . . . .	B-43
Network Status for CCB1 . . . . .	B-43
Network Status for CCB2 . . . . .	B-43
Network Status for CCB3 . . . . .	B-44
IBM Token-Ring Network Status Codes for All CCBs . . . . .	B-46
IBM PC Network Status Codes for All CCBs . . . . .	B-47
Bring-Up Errors for All CCBs . . . . .	B-48
Bring-up Error Codes for All CCBs . . . . .	B-48
IBM Token-Ring Network Adapter Open Errors for All CCBs . . . . .	B-49
Open Error Codes for All CCBs . . . . .	B-49
Suggested Actions in Response to Open Errors . . . . .	B-50
IBM PC Network Adapter Open Errors for All CCBs . . . . .	B-53
IBM PC System Detected Errors . . . . .	B-53
IBM PC System Detected Errors for CCB1 . . . . .	B-53
IBM PC System Detected Errors for CCB2 . . . . .	B-54
IBM PC System Detected Errors for CCB3 . . . . .	B-56
System Action Exceptions for OS/2 . . . . .	B-59
System Action Exceptions for CCB2 . . . . .	B-59
System Action Exceptions for CCB3 . . . . .	B-61
<b>List of Abbreviations . . . . .</b>	<b>X-1</b>
<b>Glossary . . . . .</b>	<b>X-3</b>
<b>Index . . . . .</b>	<b>X-5</b>

## **Figures**

1-1.	Two Examples of a Lobe	1-5
1-2.	Signal Transmission through the Main Ring Path	1-6
1-3.	Self-shorting Data Connector	1-7
1-4.	Signal Transmission through the Main Ring Path and Backup Path	1-8
2-1.	Format of the Problem Determination Procedures	2-6
2-2.	Example of a Diagram with Related Installation and Ring Sequence Chart	2-8
A-1.	Tracing a Cable from a Wiring Closet to a Device	A-7
A-2.	Tracing a Cable from a Component Housing to a Device	A-9
A-3.	Finding a Pair of IBM 8218 Copper Repeaters	A-16
A-4.	Finding a Pair of IBM 8219 Optical Fiber Repeaters	A-17
A-5.	Finding a Pair of IBM 8220 Optical Fiber Converters	A-18
A-6.	Identifying the Ring Sequence Using the Ring Sequence Chart	A-20
A-7.	Finding the Next Downstream and Upstream Access Unit	A-22
A-8.	Finding the First and Last Component in a Wiring Closet	A-24
A-9.	A Three-Ring Network Connected by Two Bridges	A-25
A-10.	Example of a Bridge Planning Chart	A-26
A-11.	Identifying the Fault Domain	A-32
A-12.	Identifying the Fault Domain for Beaconing on the Backup Ring	A-36



# **Chapter 1. Introduction**

The Problem Determination Process . . . . .	1-3
IBM Token-Ring Network Design . . . . .	1-4
Error Detection and Removal . . . . .	1-9



---

## The Problem Determination Process

When your IBM Token-Ring Network stops operating or does not operate normally, use this guide to isolate and correct the problem.

Part 1, Problem Determination, tells you how to perform problem determination for the IBM Token-Ring Network. The problem determination process consists of two phases:

1. Ring recovery. (The IBM Token-Ring Network uses what is known as a *ring* topology. For this reason, the network is frequently referred to as the *ring* in this guide.)
2. Repair and reconnection.

The ring recovery phase involves returning the ring to operation. During the ring recovery phase, you will:

1. Isolate the problem to a portion of the ring
2. Remove that portion from the ring.

Once the ring recovery phase is complete, the remainder of the ring should operate, and you can proceed to repair the disconnected portion of the ring. Repair may consist of actually repairing, replacing, or exchanging the defective item at your service supplier or place of purchase. After the repair is accomplished, you can reconnect the repaired portion to the ring.

Part 2, The Ring Diagnostic, tells you how to use the IBM Token-Ring Network Ring Diagnostic, an aid to finding problems on a ring. The Ring Diagnostic is designed for use with an IBM Personal Computer or IBM PERSONAL SYSTEM/2® computer attached to the ring. The problem determination procedures in Part 1 tell you when to use the Ring Diagnostic. Part 2 provides instructions for starting the Ring Diagnostic and interpreting the output.



---

## IBM Token-Ring Network Design

Some understanding of how the IBM Token-Ring Network operates will help you perform the problem determination procedures more easily. This section provides a brief description of the IBM Token-Ring Network design. The *IBM Token-Ring Network Introduction and Planning Guide* contains more detailed information about the design.

The IBM Token-Ring Network allows you to connect up to 260 attaching devices per ring. Each device contains an adapter that allows the device to send and receive data on the ring at a transmission data rate of either 4 or 16 megabits per second (Mbps). The devices are connected in a star-wired ring arrangement using IBM 8228 Multistation Access Units (MSAU). The IBM 8228 is a wiring concentrator.

The section of cable connecting a device to an IBM 8228 is called a *lobe*. As illustrated in Figure 1-1, a lobe may consist of more than one segment of cable (such as a device cable, patch cables, and a cable in the wall). An IBM 8228 may be mounted in a rack or installed in a component housing that is permanently mounted, usually on a wall. All of the IBM 8228s are connected together with cables to form the ring.

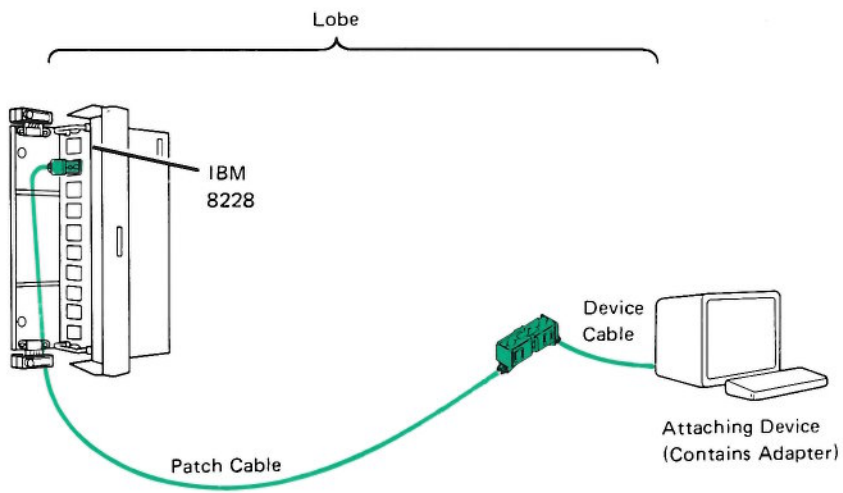
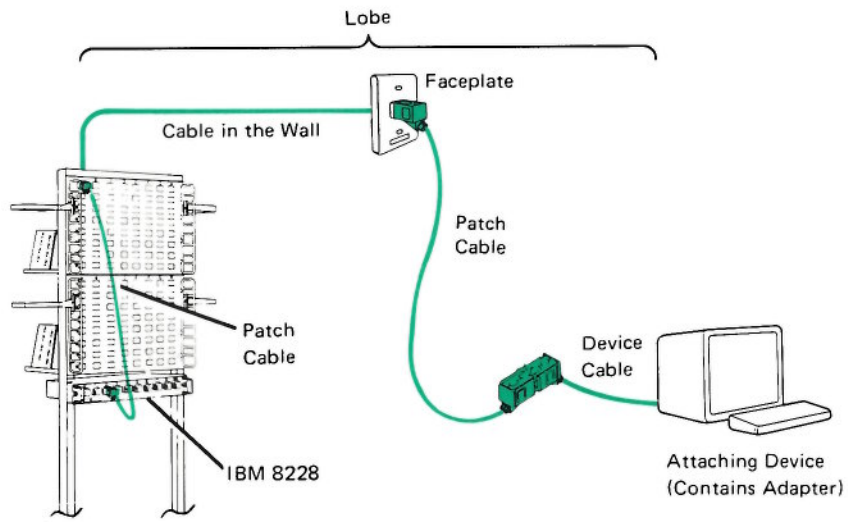

Figure 1-1. Two Examples of a Lobe

When the attaching device wants to communicate on the ring, the adapter tells the IBM 8228 that it wants to access the ring. The IBM 8228 then makes the lobe a part of the ring. We refer to the process of becoming a part of the ring as “attaching.”

Information used to control the IBM Token-Ring Network and to allow devices to communicate is continuously being passed around the ring. The transmission path begins at the adapter of the device that is sending the data. The signal travels through the device’s lobe to the IBM 8228 and onto the main ring path. The main ring path consists of all the IBM 8228s and the cables, repeaters (IBM 8218 Copper Repeaters, IBM 8219 Optical Fiber Repeaters, and IBM 8220 Optical Fiber Converters), and surge suppressors. For each device that is active on the ring, the signal leaves the main ring path to travel through the lobe to the device’s adapter. The signal then travels back to the main ring path. When the signal has completed its route around the ring, it travels back through the lobe to the adapter that sent the data. The data is then removed from the ring.

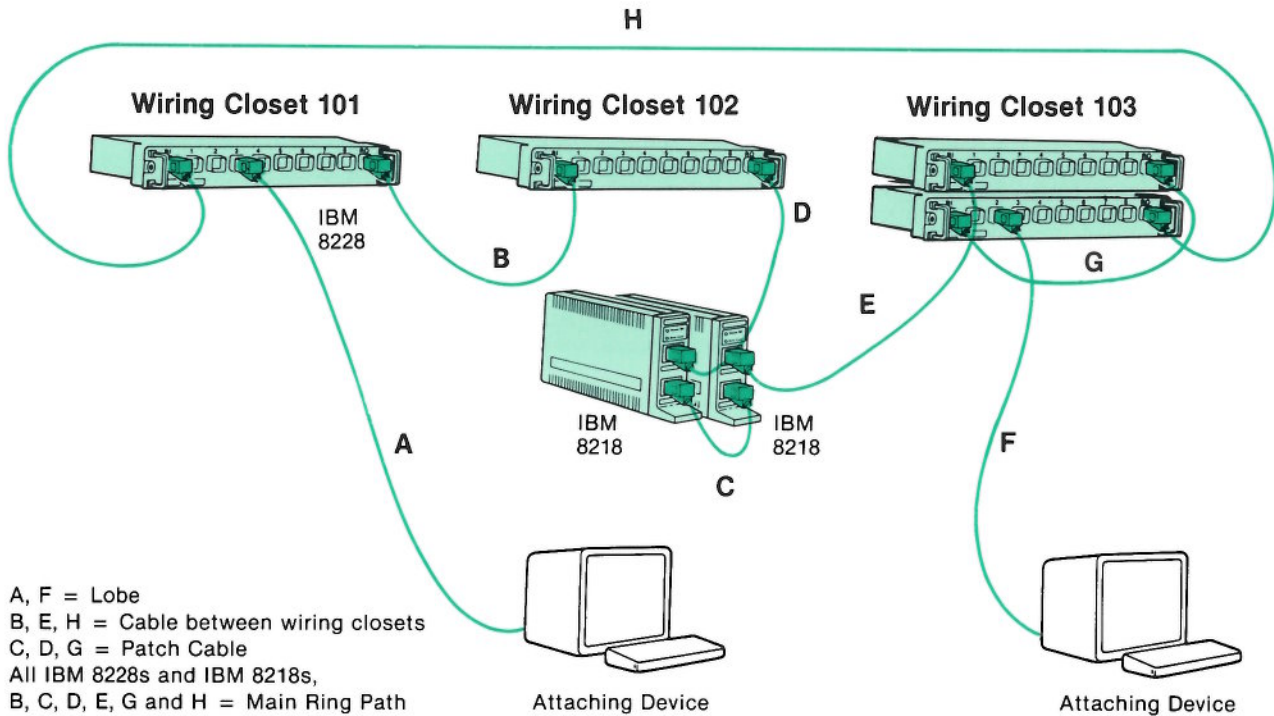

Figure 1-2. Signal Transmission through the Main Ring Path

The self-shorting characteristic of the data connectors on patch cables and on all cables in the IBM Cabling System, and inside the IBM 8228s, makes it possible for a signal to travel on a backup path. When any data connector is disconnected, the shorting bars in the connector are automatically activated. (Disconnecting a data connector can cause disruption of network operation.) Any signal transmitted through the cable will “wrap around” at the disconnected data connector and travel on a different set of wires within the cable. Figure 1-3 shows the operation of the connector’s shorting bars when they are in the closed position.

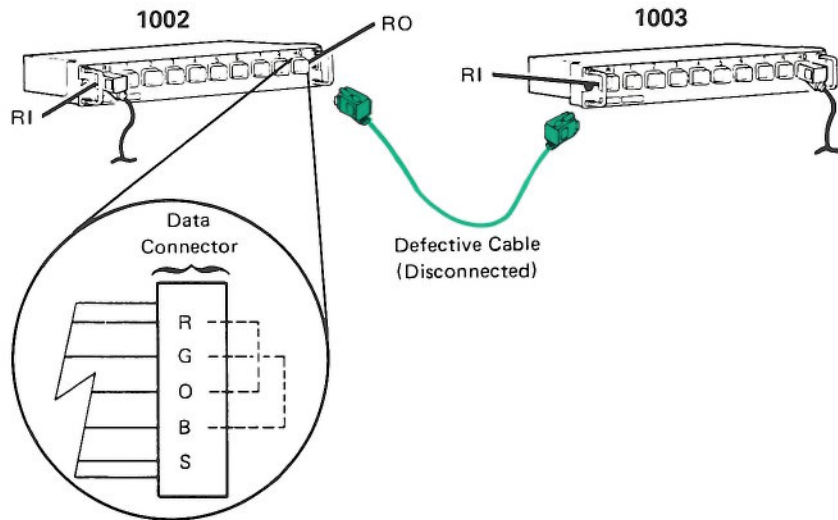

Figure 1-3. Self-shorting Data Connector

When a cable is disconnected from the main ring path, shorting bars inside the data connector of the RO receptacle automatically connect:

- The red wire to the orange wire
- The green wire to the black wire.

To illustrate the significance of the self-shorting feature during problem determination, consider the case shown in Figure 1-4. There is a break in the cable between wiring closets 102 and 103 in a ring having three wiring closets. Cable C is disconnected at both ends until it can be repaired. Consequently, the ring out (RO) receptacle of the IBM 8228 in wiring closet 102 is no longer connected to the ring in (RI) receptacle of the first IBM 8228 in wiring closet 103.

When a device attached to the IBM 8228 in wiring closet 101 sends data on the ring, the signal is transmitted through the device's lobe (Cable A) to the IBM 8228. Then the signal travels on the main ring path through the IBM 8228s, patch cables, and cables between wiring closets 101 and 102. When the signal reaches the RO receptacle of the IBM 8228 in wiring closet 102, it crosses to the backup path. The signal travels on the backup path through all of the IBM 8228s and associated cables in the path through wiring closets 102, 101, and 103. The signal travels from the RO receptacle of the last IBM 8228 in wiring closet 103 until it reaches the RI receptacle of the first IBM 8228 in the closet. At that point, the signal crosses back to the main ring path. The signal travels back through the IBM 8228s and associated cables in the path from wiring closet 103 to wiring closet 101. Finally, the signal travels back through the lobe to the attaching device that sent the signal.

**Note:** The backup path should be used only during problem determination.

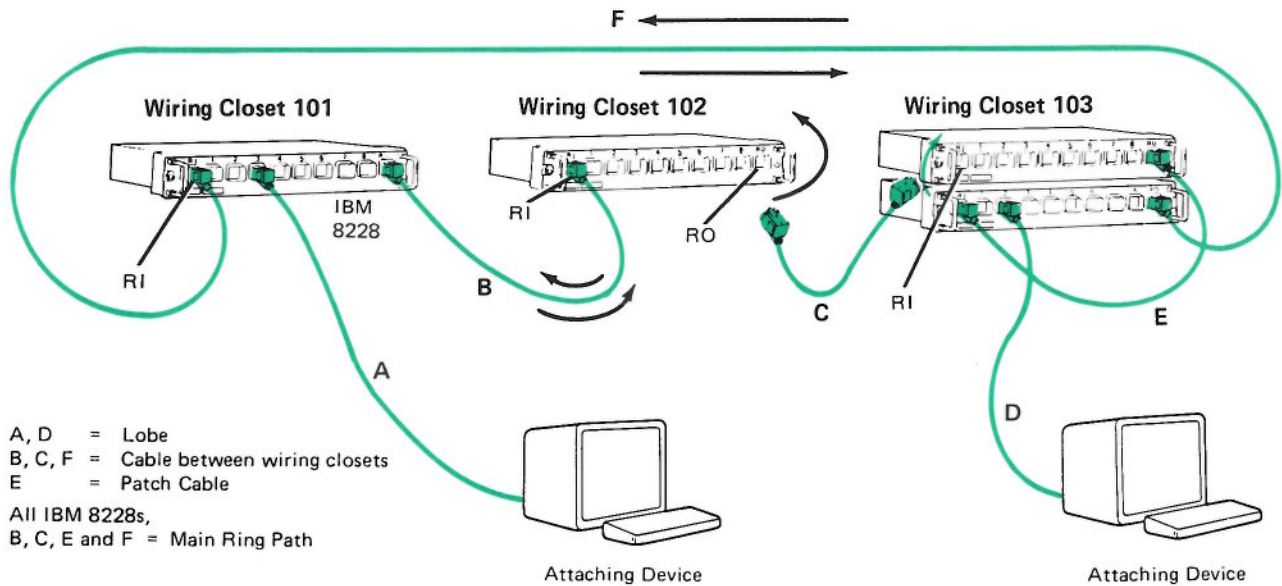

Figure 1-4. Signal Transmission through the Main Ring Path and Backup Path

---

## **Error Detection and Removal**

Before an adapter attaches to the ring, the adapter checks itself. If a problem is detected, the adapter will not allow the device to be attached to the ring. The device or program will indicate to the user that an error has been detected.

Many error conditions involving the IBM Token-Ring Network adapter or its lobe can be detected, isolated, and automatically removed from the ring without the action of a person. Automatic removal of an attached device does not affect the operation of the rest of the ring. Repair can then take place without loss of network function.

Some of the problems that make the network inoperative must be isolated and removed manually. Recurring intermittent errors may also require manual isolation. Use the problem determination procedures that follow to perform manual problem control.





---

## Part 1. Problem Determination



---

## Chapter 2. Preparing for Problem Determination

Using this Chapter . . . . .	2-3
Some Problem Determination Suggestions . . . . .	2-3
What You Need . . . . .	2-4
Records . . . . .	2-4
Equipment . . . . .	2-4
Other Publications . . . . .	2-5
Format of the Problem Determination Procedures . . . . .	2-6
Using the Diagrams . . . . .	2-7



---

## Using this Chapter

This chapter contains some suggestions, a list of items you need, and instructions on how to perform some of the frequently occurring tasks in the problem determination procedures in Chapters 3 and 4.

---

## Some Problem Determination Suggestions

This section provides suggestions for things to do before starting the procedures and things to keep in mind while performing the procedures.

1. An understanding of how the IBM Token-Ring Network operates will help you perform the problem determination procedures. If you have not already done so, read "IBM Token-Ring Network Design" on page 1-4.
2. These procedures can be used most efficiently if two people perform them together. To be most effective, one person should be at the terminal (called the "observer terminal") used to run the IBM Token-Ring Network Ring Diagnostic, the IBM Local Area Network Manager, or a network application program that provides information about the ring status and fault domain. The second person should be in the area where the IBM 8228s are installed. The two persons will need some method of communication between the two locations.
3. Be aware that some of the actions you take while following the problem determination procedures may cause a change in the information about the ring status or the error that is presented at the observer terminal. For example, disconnecting the beaconing adapter in a device could cause a wire fault to be indicated by the device that contained the beaconing adapter. It would also cause a new beaconing adapter to be indicated by the observer terminal. You should follow the procedures exactly as written and perform only those actions that the procedures instruct you to perform.
4. Take notes as you go through the procedures so that you can track your progress from one procedure to another. For example, a step in one procedure will send you to the beginning of another procedure. At the end of that procedure you may have to return to the previous procedure. You should always record the page and step number that sends you to a new procedure.



---

## What You Need

### Records

You will need accurate and complete records of your network to perform these problem determination procedures. When the network was planned and installed, the following charts should have been completed:

- Ring Sequence Chart
- IBM 8228 Cabling Chart
- Adapter Address to Physical Location Locator Chart
- Physical Location to Adapter Address Chart
- IBM 8218 Cabling Chart and/or IBM 8218 Cabling Chart for Telephone Twisted-Pair-Based Rings, if applicable
- IBM 8219 Cabling Chart and/or IBM 8219 Cabling Chart for Telephone Twisted-Pair-Based Rings, if applicable
- IBM 8220 Cabling Chart, if applicable
- Bridge Planning Chart.

Performing these procedures will be very difficult if you do not have a complete set of up-to-date charts. The Ring Sequence Chart, and the Adapter Address to Physical Location Locator Chart are particularly important because they will allow you to find all the components of your network. For a further explanation of how to use these charts, see Appendix A. If you do not already have the charts, see your network administrator. (Refer to the *IBM Token-Ring Network Introduction and Planning Guide* for blank copies of the forms.)

### Equipment

You will need at least one of the following:

- 8-foot (2.4-meter) patch cable
- 30-foot (9.1-meter) patch cable
- Yellow crossover patch cable, if IBM 8218 Copper Repeaters, IBM 8219 Optical Fiber Repeaters, or IBM 8220 Optical Fiber Converters are installed in the ring
- If telephone twisted-pair media are installed in the ring:
  - White Data Grade Media (DGM)-to-Type 3 Filter cable
  - Type 3 Media Filter cable
- If IBM 8219 Optical Fiber Repeaters or IBM 8220 Optical Fiber Converters are installed in the ring:
  - Optical fiber BNC-to-Biconic patch cable
  - Six-inch optical fiber test cable (shipped with the IBM 8219 Optical Fiber Repeater and the IBM 8220 Optical Fiber Converter).

We recommend that you have a spare IBM 8228 Multistation Access Unit.

## Other Publications

The problem determination procedures in this guide may refer you to instructions in the following manuals:

- *IBM Token-Ring Network PC Adapter Technical Reference*
- *IBM Token-Ring Network Manager User's Guide*
- *IBM Token-Ring Network Installation Guide*
- *IBM Cabling System Planning and Installation Guide*
- *Using the IBM Cabling System with Communication Products*
- *IBM Token-Ring Network Telephone Twisted-Pair Media Guide*
- *IBM Token-Ring Network NETBIOS User's Guide*
- *IBM Token-Ring Network Bridge Program User's Guide* (with diskette)
- *IBM Token-Ring Network/PC Network Interconnect User's Guide*
- *IBM Local Area Network Manager's User's Guide* (with diskette).
- *IBM Local Area Network Support Program User's Guide*
- *IBM Local Area Network Technical Reference*

For information about how to obtain these publications, see your IBM representative or local branch office.

## Format of the Problem Determination Procedures

This section explains the format used to present the problem determination procedures in Chapter 3. The items in the explanation are keyed to the example in Figure 2-1.

1. Each problem determination procedure addresses a particular problem or task. The name of the procedure is printed at the top of the first page of the procedure.
2. The steps in a procedure are numbered 1, 2, , ..., n. Start each procedure at step 1.
3. Each step contains two or more conditional statements that tell you the next step to follow. Make sure you have performed all of the tasks in the step before following the instructions in one of the conditional statements. Read the conditional statements carefully and follow the statement that best describes your situation.
4. A conditional statement may contain one or more tasks. Be sure to perform the tasks in the sequence they appear.
5. Many of the steps are illustrated with diagrams. See "Using the Diagrams" on page 2-7 for an explanation of how cables and IBM Token-Ring Network components are represented in the diagrams.

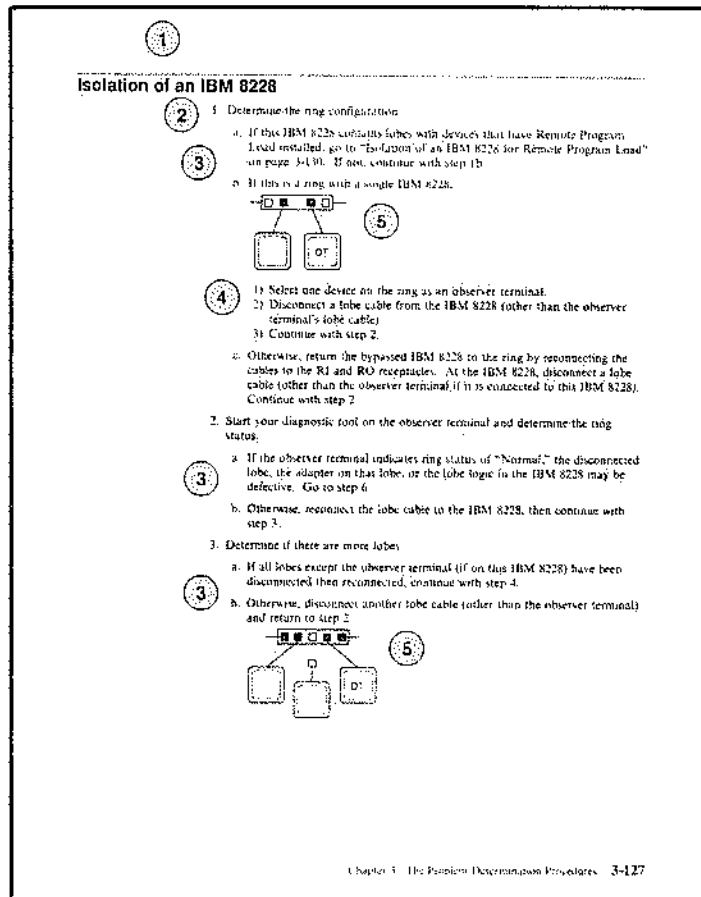

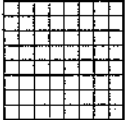
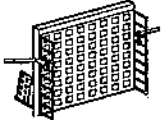

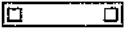



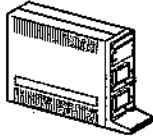

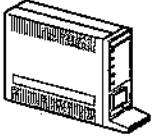

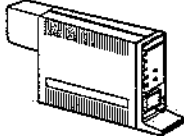

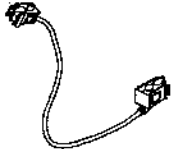
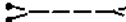
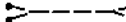
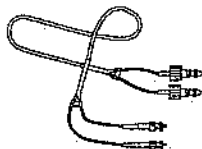





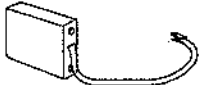



Figure 2-1. Format of the Problem Determination Procedures

## Using the Diagrams

Many of the steps in the procedures in Chapter 4 are illustrated with diagrams designed to make the steps easier to understand. The diagrams show the components, cables, and devices in a portion of a ring. Each diagram is an example; your ring probably will not have the same number of IBM 8228 Multistation Access Units and other components shown in the example. The following are the representations used in the diagrams and their meanings:

	Attaching device		Distribution panel (DP) each panel represents one wiring closet.	
	Observer terminal		IBM 8228 Multistation Access Unit(MSAU)	
	NAUN device		IBM 8218 Copper Repeater (RPTR)	
	Beaconing device		IBM 8219 Optical Fiber Repeater (OFRPTR)	
	First device		IBM 8220 Optical Fiber Converter (OFCVTR)	
	Second device		Copper patch cable (P or YCP)	
	Copper cable between wiring closets		Optical fiber BNC patch cable (OFP)	
	Optical fiber cable between wiring closets		White DGM-to-Type 3 Filter cable	
	Type 3 Media Filter cable			
	Points to the action to be taken			

See Figure 2-2 on page 2-8 for an example of a diagram and the physical installation it represents.

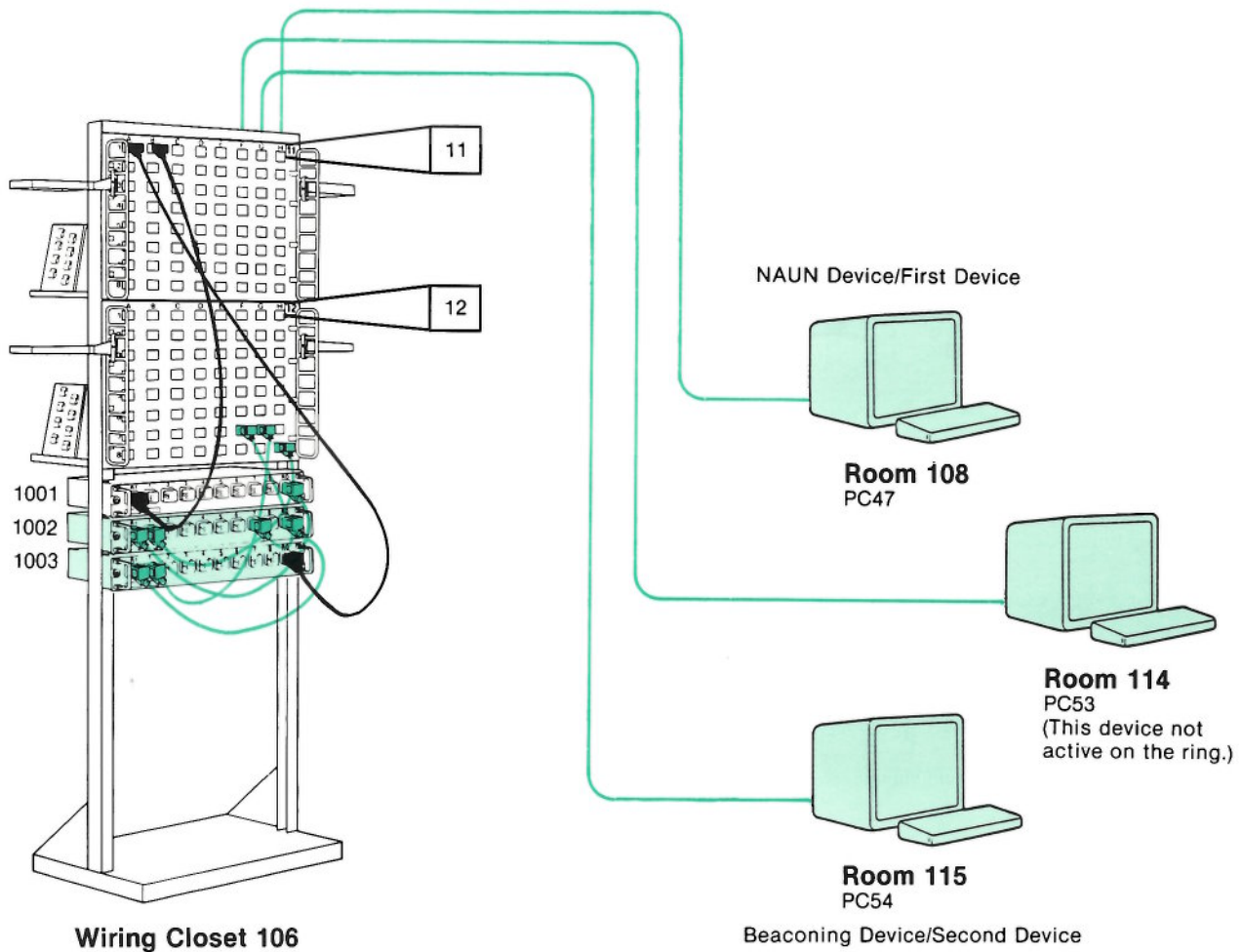

**Fault Domain Includes:**

- Access Units 1002 and 1003, and the patch cables connecting them
- The devices connected to access units 1002 and 1003, and the cables that connect these devices to the access units. For illustrative purposes, all of the devices are not shown.

Figure 2-2 (Part 1 of 2). Example of a Diagram with Related Installation and Ring Sequence Chart

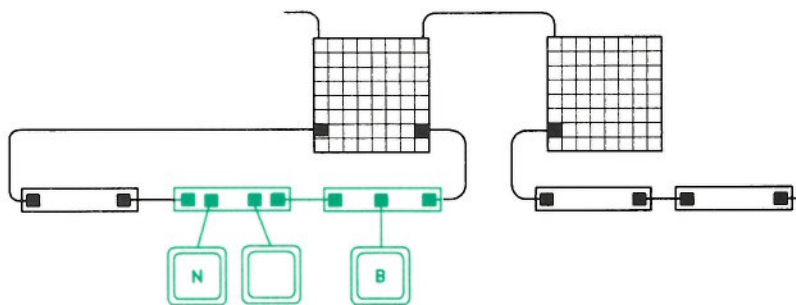
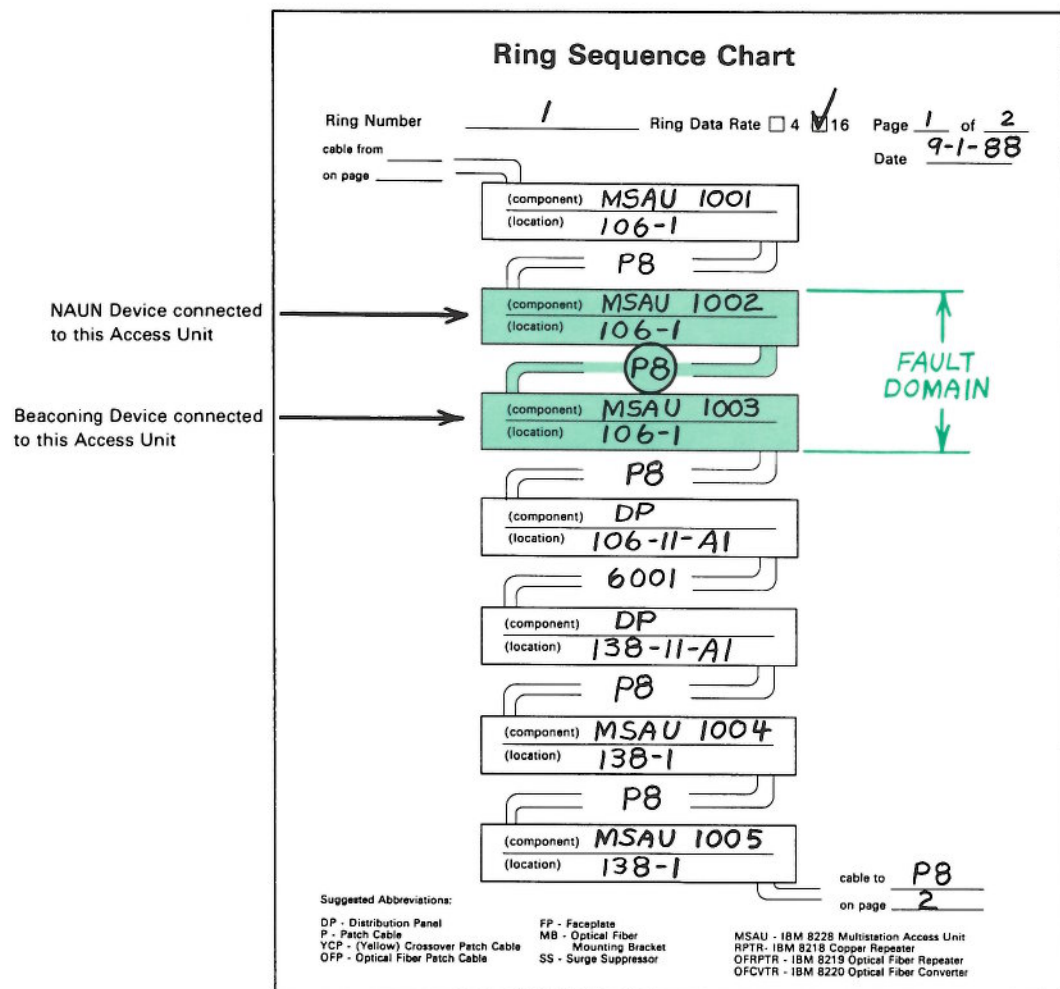

Figure 2-2 (Part 2 of 2). Example of a Diagram with Related Installation and Ring Sequence Chart



## Chapter 3. The Problem Determination Procedures

Using the Procedures	3-3
Starting the Problem Determination Procedures	3-5
Ring Recovery: Beaconsing	3-7
Ring Recovery: Beaconsing on the Backup Ring	3-14
Beacon Isolation - Part 1	3-16
Beacon Isolation - Part 2	3-21
Beacon Isolation - Part 3	3-24
Ring Recovery for Soft Errors, Part 1	3-28
Ring Recovery for Soft Errors, Part 2	3-33
Soft Error Isolation with One Address Known	3-37
Diagnosing Intermittent Beaconsing Conditions	3-39
Diagnosing Intermittent Soft Errors	3-41
Open Errors, Part 1	3-43
Open Errors, Part 2 — Signal Loss	3-44
Open Errors, Part 3 — Time-Out	3-45
Open Errors, Part 4 — Ring Failure or Beaconsing	3-46
Open Errors, Part 5 — Duplicate Address	3-47
Open Errors, Part 1, for Remote Program Load	3-49
Open Errors, Part 2, for Remote Program Load	3-50
Open Errors, Part 3, for Remote Program Load	3-51
Open Errors, Part 4, for Remote Program Load	3-52
Open Errors, Part 5, for Remote Program Load	3-53
Open Errors, Part 6, for Remote Program Load	3-55
Open Errors, Part 7, for Remote Program Load	3-56
Only Adapter on the Ring	3-57
Only Adapter on the Ring for Remote Program Load	3-58
Manual Procedure, Part 1	3-59
Manual Procedure, Part 2	3-62
Manual Procedure, Part 3	3-67
Manual Procedure, Part 4	3-70
Manual Procedure, Part 5	3-78
Manual Procedure, Part 6	3-83
Manual Procedure, Part 7	3-88
Manual Procedure, Part 1, for Remote Program Load	3-89
Manual Procedure, Part 2, for Remote Program Load	3-92
Manual Procedure, Part 3, for Remote Program Load	3-97
Manual Procedure, Part 4, for Remote Program Load	3-100
Manual Procedure, Part 5, for Remote Program Load	3-102
Manual Procedure, Part 6, for Remote Program Load	3-104
Manual Procedure, Part 7, for Remote Program Load	3-107
Testing IBM 8228s	3-108
Testing IBM 8218s and IBM 8219s	3-109
Loss of Critical Resource	3-113
Testing an IBM 8220 Optical Fiber Subsystem	3-114
Isolation of an IBM 8220 Optical Fiber Subsystem	3-115
IBM 8220 Self-Test	3-119
Duplicate Address on an IBM 8220	3-121
Testing Patch Cables	3-122
Testing Ring Segments	3-123
Wire Fault, Auto-Removal, or Open Errors (Function Failure)	3-125
Wire Fault, Auto Removal, or Open Error (Function Failure) for Remote Program Load	3-126



Isolation of an IBM 8228	3-127
Isolation of an IBM 8228 for Remote Program Load	3-130
IBM 8228/Adapter Test	3-132
Lobe Logic Isolation (Beaconing and Open Errors)	3-134
Lobe Logic Isolation (Beaconing and Open Errors) for Remote Program Load	3-136
Lobe Logic Isolation, Soft Errors	3-137
Lobe Logic Isolation, Soft Errors, for Remote Program Load	3-138
Lobe Logic Isolation, NAUN's Lobe	3-139
Device and Lobe Error Isolation	3-140
Adapter/Cable Isolation	3-142
Excessive Ring Error Reports	3-146
Session Errors, Part 1	3-147
Session Errors, Part 2	3-149
Session Errors, Part 3	3-150
Session Errors, Part 4	3-151
Errors When Processing Data Received from Other Devices	3-152
Errors When Processing Data Received from Other Devices for Remote Program Load	3-154
Isolation of an Optical Fiber Ring Segment, Part 1	3-156
Isolation of an Optical Fiber Ring Segment, Part 2	3-159
Isolation of IBM 8218s	3-162
IBM 8218/8219/8220 Power Problems	3-163
Diagnosing Difficult Ring Problems	3-166
Diagnosing Difficult Lobe Problems	3-167
Diagnosing Difficult Lobe Problems for Remote Program Load	3-169
Testing Data Cables	3-171
Repairing a Data Cable	3-176
Replacing a Defective IBM 8228	3-177
Replacing a Defective IBM 8218	3-178
Replacing a Defective IBM 8219	3-179
Replacing a Defective IBM 8220	3-180

---

## Using the Procedures

Use these procedures if your ring is not operating or is not operating in the normal manner. If you are working on a newly installed ring that has never been operational, you should use the procedures in "Resolving Problems in a Newly Installed Ring" in the *IBM Token-Ring Network Installation Guide*.

If you are not familiar with Token-Ring Network operation, you should read the information contained in Chapters 1 and 2 before proceeding further.

You should understand the following rules and terms before starting the procedures:

- Read and follow all problem determination procedures *carefully*. If each step is not executed *exactly* as described, these procedures may not work and problem determination may be unsuccessful.
- To answer questions in these procedures concerning the ring status, use the IBM Token-Ring Network Ring Diagnostic, the IBM Local Area Network Manager, or a network application program (referred to in the procedures as a "diagnostic tool") that will provide ring status messages and identify fault domains. An example of the latter is the IBM Token-Ring Network Bridge Program.
- The "observer terminal" is the device being used to run the diagnostic tool to provide information about the ring status and fault domain. The procedures tell you how to select an observer terminal when one is required. The host or Netview terminal may be used as the observer terminal; however, it is recommended that another terminal on the LAN segment be used.
- All questions about the ring status (for example, "Is the ring operational now?") must be answered from indications at the observer terminal.
- A ring is "operational" if communication via a network application program is normal and excessive soft errors are not occurring, or if the ring status is normal.
- "Beaconing," "ring not working," "soft errors," and equivalent indications mean that the ring is not operational.
- Some of the procedures require that you find a particular device or component (an IBM 8228 Multistation Access Unit, an IBM 8218 Copper Repeater, an IBM 8219 Optical Fiber Repeater, or an IBM 8220 Optical Fiber Converter). See Appendix A for instructions.
- Some of the procedures require that you identify the wiring closets in the ring. If an IBM 8228 is mounted in a component housing or IBM 8218s, IBM 8219s or IBM 8220s are mounted with a bracket, treat the area where the components are located as if it were a wiring closet.
- Certain procedures may require removing power from an IBM 8218, IBM 8219, or an IBM 8220. If the unit is rack mounted, *slide the unit out of the rack* to power the device down. Do NOT remove power from the rack. This may cause the ring to become inoperative. If the device is surface mounted, *remove the power plug* from the IBM 8218, IBM 8219, or the IBM 8220 or the wall to remove power.
- Chapter 4, "Ring Recovery Procedure for the Experienced Trouble-Shooter" can be used for ring recovery during beaconing and soft error conditions if you are an *experienced* troubleshooter and are thoroughly familiar with the procedures as described in Chapter 3. If your situation meets the conditions

indicated at the beginning of Chapter 4, you may begin with that procedure instead of "Starting the Problem Determination Procedures" on page 3-5.

## Starting the Problem Determination Procedures

- The chart below contains many of the possible symptoms of problems that can occur on an IBM token-Ring Network. If you have already started a diagnostic program and have identified the symptom, locate the symptom in the chart and then go to the indicated procedure. Note that two page numbers are given for some procedures. The first number is for rings without devices with the Remote Program Load (RPL) feature installed. The second page number (with RPL in parenthesis) is for rings with devices that have the RPL feature installed.

If you have not identified a symptom or if your symptom is not in the chart, continue with step 2.

Symptom	Go to Procedure	Page
IBM PC or IBM PS/2 Adapter Diagnostic Failure	"Adapter/Cable Isolation"	3-142
Adapter Removed (Adapter Removal Error)	"Wire Fault, Auto-Removal or Open Error (Function Failure)"	3-125 (3-126 RPL)
Unable to open ring adapter	"Open Errors, Part 1"	3-43 (3-49 RPL)
Wire Fault	"Wire Fault, Auto-Removal or Open Error (Function Failure)"	3-125 (3-126 RPL)
Only Adapter on the ring	"Only Adapter on the Ring"	3-57 (3-58 RPL)
Ring Not Working: Beaconing	"Ring Recovery: Beaconing"	3-7
Ring Not Working: Beaconing on Backup Ring	"Ring Recovery: Beaconing on the Backup Ring"	3-14
Error Limit Exceeded: Soft Errors	"Ring Recovery for Soft Errors, Part 1"	3-28
IBM 8220 Errors	"Isolation of an IBM 8220 Optical Fiber Subsystem"	3-115
Soft Errors on a Lobe	"Lobe Logic Isolation, Soft Errors"	3-137 (3-138 RPL)
Session Errors	"Session Errors, Part 1"	3-147
Miscellaneous errors when processing data	"Errors When Processing Data Received from Other Devices"	3-152 (3-154 RPL)
Ring wrapped to backup path or loss of critical resource	"Ring Wrapped or Loss of Critical Resource"	3-113
Device errors (such as printer or disk errors)	Problem determination procedures for the device	
Program error messages	Program documentation	

2. Any program that will provide ring status and fault domain information is referred to in these procedures as a "diagnostic tool." Such programs include:

- IBM Ring Diagnostic
- IBM Local Area Network Manager
- IBM Token-Ring Network Manager
- IBM Token-Ring Bridge Program
- Others

**Note:** Adapter diagnostics do not provide ring status or fault domain information and therefore, can not be used as your diagnostic tool in these procedures except when specifically mentioned.

If one of these diagnostic tools is available to you, continue with step 3. Otherwise, go to "Manual Procedure, Part 1" on page 3-59 if your ring has no devices with the Remote Program Load (RPL) feature or "Manual Procedure, Part 1, for Remote Program Load" on page 3-89 if your ring has devices with the RPL feature.

3. Determine how many devices are affected by the problem. If the "error condition" affects only one device, you must use that device as your observer terminal. If multiple devices are affected, you may use any device capable of running your diagnostic tool as your observer terminal. Continue with step 4.
4. Start your diagnostic tool on your observer terminal. When starting the diagnostic tool, *you may have to wait up to six minutes* for it to determine if soft errors are occurring. If a error is indicated, locate the symptom in the chart in step 1 and go to the indicated procedure. If no error is indicated, the problem may have disappeared. Restart normal operations on the ring. If the problem is intermittent and the symptom is "Beaconing," go to "Diagnosing Intermittent Beaconing Conditions" on page 3-39. If the problem is intermittent and the symptom is "Soft Errors," go to "Diagnosing Intermittent Soft Errors" on page 3-41.

---

## Ring Recovery: Beaconing

This procedure will recover the ring by locating and removing the portion of the ring that contains the fault.

**Note:** Some of these procedures require that you find a particular device or component. See Appendix A for instructions.

1. Using the Ring Sequence Chart, determine number of IBM 8228s.
  - a. If the entire ring contains two or more IBM 8228s, continue with step 2.
  - b. Otherwise, it consists of a single IBM 8228. Go to "Isolation of an IBM 8228" on page 3-127.
2. On a piece of paper, record the adapter addresses of the NAUN (Nearest Active Upstream Neighbor) and beaconing devices indicated in the beaconing error message. Whenever these procedures refer to the NAUN device and beaconing device, use the addresses you recorded in this step to identify those devices. Disregard any changes that may occur as you perform problem determination procedures.
  - a. If the beaconing device is an IBM 8220 optical fiber subsystem, go to step 7.

**Note:** An IBM 8220 optical fiber subsystem is a segment of the main ring path containing only optical fiber cabling with a converter at each end.
  - b. Otherwise, continue with step 3.
3. Testing the beaconing device's lobe.

Disconnect the beaconing device's lobe cable from the IBM 8228.

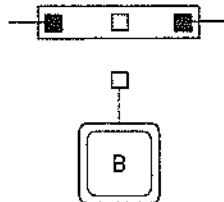

**Note:** If your observer terminal and the NAUN or the beaconing device are the same device, select another device to use as your observer terminal and start your diagnostic tool on the new observer terminal.

- a. If the observer terminal's ring is now operational, the disconnected lobe or its lobe logic in the IBM 8228 may be defective.
  - 1) Leave the lobe cable disconnected.
  - 2) Ring recovery is complete.
  - 3) Go to "Lobe Logic Isolation (Beaconing and Open Errors)" on page 3-134.
- b. Otherwise, reconnect the lobe cable to the IBM 8228, then continue with step 4.

4. Using the Adapter Address to Physical Location Locator Charts, determine the IBM 8228(s) to which the beaconing device and the observer terminal are connected.

- a. If the beaconing device is connected to the same IBM 8228 as the observer terminal, continue with step 5.

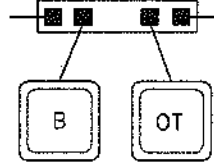

- b. Otherwise, go to step 6.

5. The observer terminal is connected to the same IBM 8228 as beaconing device. Bypass the beacon's IBM 8228. Determine the observer terminal's ring status.

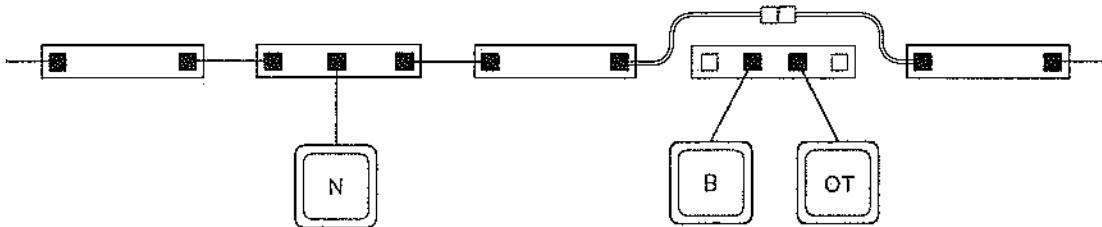

- a. If the observer terminal's ring is now operational, reconnect the cables to the IBM 8228, then go to step 7.
- b. Otherwise, the bypassed IBM 8228 or one of its lobes may be defective. Go to step 28 to isolate the fault.

6. The observer terminal and the beaconing device are connected to different IBM 8228s. Bypass the beacon's IBM 8228. Determine the observer terminal's ring status.

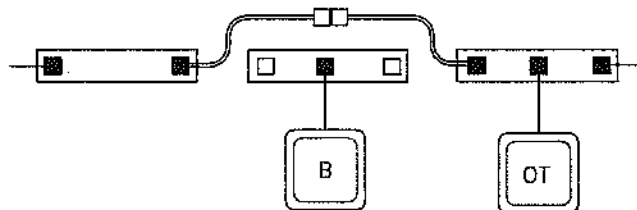

- a. If the observer terminal's ring is now operational, the bypassed IBM 8228 or one of its lobes may be defective. Ring recovery is complete. Go to "Isolation of an IBM 8228" on page 3-127 to isolate the fault.
- b. Otherwise, reconnect the cables to the IBM 8228, then continue with step 7.

7. Determining NAUN device type.

- a. If the NAUN is an IBM 8220 optical fiber subsystem, go to step 14.
- b. Otherwise, continue with step 8.

8. Determining the next step.

- a. If the beaconing device is an IBM 8220 optical fiber subsystem, go to step 10.
- b. Otherwise, continue with step 9.

9. Using the Adapter Address to Physical Location Locator Charts determine the IBM 8228(s) to which the beaconing device and its NAUN are connected.
- If the beaconing device and the NAUN are connected to the same IBM 8228 and the beaconing device is attached to a lower numbered lobe on the IBM 8228 than the NAUN device, then everything except the beacon's and NAUN's 8228 is in the fault domain.

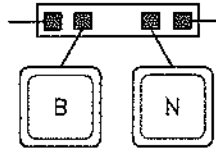

- Unplug the Beacon's and NAUN's RI and RO cables.
- Disconnect the cables from the RI and RO receptacles of the beacon's IBM 8228.
- Remember that the "Removed Ring Segment" is everything in the ring **except** the Beacon's and NAUN's 8228.
- Go to step 22.

b. Otherwise, continue with step 10.

10. Disconnect the NAUN's lobe cable from the IBM 8228

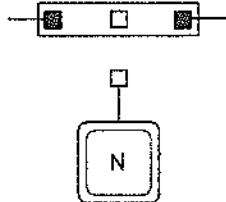

- If the observer terminal's ring is now operational, the disconnected lobe or its lobe logic in the IBM 8228 may be defective.
  - Leave the lobe cable disconnected.
  - Ring recovery is complete.
  - Go to "Lobe Logic Isolation, NAUN's Lobe" on page 3-139.
- Otherwise, reconnect the lobe cable to the IBM 8228, then continue with step 11.

11. Using the Adapter Address to Physical Location Locator Charts, determine the IBM 8228(s) to which the NAUN and the observer terminal are connected.

- If the NAUN is connected to the same IBM 8228 as the observer terminal, continue with step 12.

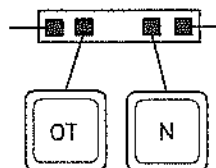

- Otherwise, go to step 13.



12. The observer terminal is connected to the same IBM 8228 as the NAUN.  
Bypass the NAUN's IBM 8228. Determine the observer terminal's ring status.

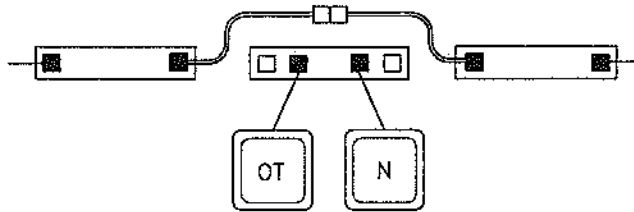

- a. If the observer terminal's ring is now operational, reconnect the cables to the IBM 8228, then go to step 14.
  - b. Otherwise, the bypassed IBM 8228 or one of its lobes may be defective. Go to step 28.
13. The observer terminal and the NAUN are connected to different IBM 8228s.  
Bypass the NAUN's IBM 8228. Determine the observer terminal's ring status.

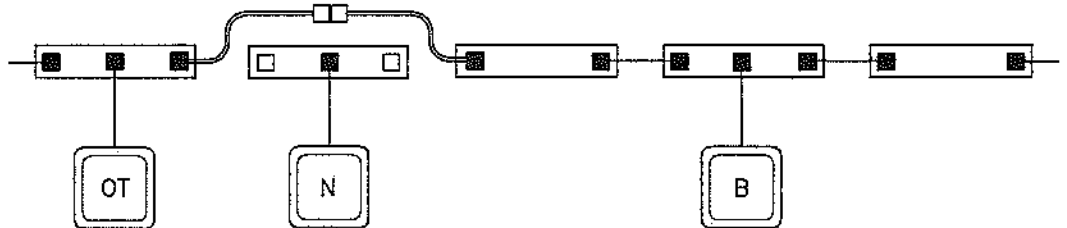

- a. If the observer terminal's ring is now operational, the bypassed IBM 8228 or one of its lobes is defective. Ring recovery is complete. Go to "Isolation of an IBM 8228" on page 3-127 to isolate the fault.
  - b. Otherwise, reconnect the cables to the IBM 8228, then continue with step 14.
14. Determining beaconing device type.
- a. If the beaconing device is an IBM 8220 optical fiber subsystem, continue with step 15.
  - b. Otherwise, go to step 16.
15. Testing the beaconing device (IBM 8220 optical fiber subsystem).

Remove the IBM 8220 optical fiber subsystem from the ring by removing power from the upstream (RI) IBM 8220. (The upstream IBM 8220 is the unit with the RI/RO switch set to the RI position.)

**Note:** Remember to *slide the IBM 8220 out* of the rack if the unit is rack mounted. Do **NOT** power the rack down. If the unit is surface mounted, *unplug the power plug* from the IBM 8220 or the wall to remove power.

- a. If the observer terminal's ring is now operational, the IBM 8220 optical fiber subsystem is defective. Ring recovery is complete.
  - 1) Disconnect the copper patch cable from the data receptacle of the upstream (RI) IBM 8220.
  - 2) Go to the wiring closet containing the downstream (RO) IBM 8220.
  - 3) Disconnect the copper patch cable from the data receptacle of the downstream (RO) IBM 8220.
  - 4) Go to "Isolation of an IBM 8220 Optical Fiber Subsystem" on page 3-115.

- b. Otherwise, restore power to the IBM 8220. The IBM 8220 optical fiber subsystem will not be able to insert into the ring at this time. Disregard any IBM 8220 error indications at this time. Continue with step 16.
- 16. Determining NAUN device type.
  - a. If the NAUN is an IBM 8220 optical fiber subsystem, continue with step 17.
  - b. Otherwise, go to step 18.
- 17. Testing the NAUN device (IBM 8220 optical fiber subsystem).
 

Remove the IBM 8220 optical fiber subsystem from the ring by removing power from the upstream (RI) IBM 8220.

**Note:** Remember to *slide the IBM 8220 out* of the rack if the unit is rack mounted. Do **NOT** power the rack down. If the unit is surface mounted, *unplug the power plug* from the IBM 8220 or the wall to remove power.

  - a. If the observer terminal's ring is now operational, the IBM 8220 optical fiber subsystem is defective. Ring recovery is complete.
    - 1) Disconnect the copper patch cable from the data receptacle of the upstream (RI) IBM 8220.
    - 2) Go to the wiring closet containing the downstream (RO) IBM 8220.
    - 3) Disconnect the copper patch cable from the data receptacle of the downstream (RO) IBM 8220.
    - 4) Go to "Isolation of an IBM 8220 Optical Fiber Subsystem" on page 3-115.
  - b. Otherwise, restore power to the IBM 8220. The IBM 8220 subsystem will not be able to insert into the ring at this time. Disregard any IBM 8220 error indications at this time. Continue with step 18.
- 18. Determining the next step.
 

Using the two addresses you recorded in step 1 of this procedure and the Ring Sequence Charts, determine the fault domain. See "How to Identify the Fault Domain" in Appendix A if assistance is needed.

  - a. If there is an IBM 8228 other than the beacon's or NAUN's IBM 8228 within the fault domain, continue with step 19.
  - b. Otherwise, go to "Beacon Isolation - Part 2" on page 3-21.
- 19. Using the Ring Sequence Charts and the IBM 8228 Cabling Charts, determine if there is a device connected to one of the IBM 8228s within the fault domain that is capable of executing your diagnostic tool or other program that provides ring status.
  - a. If there is a device in the fault domain capable of executing the diagnostic tool, continue with step 20.
  - b. Otherwise, go to "Beacon Isolation - Part 2" on page 3-21.
- 20. In the next two steps you will remove a portion of the fault domain from the ring. In this step, you will disconnect the upstream end of the fault domain.
  - a. If the NAUN device is an IBM 8220 optical fiber subsystem, disconnect the copper patch cable from the data receptacle of the upstream (RI) IBM 8220. This IBM 8220 is the upstream end of the removed ring segment. Continue with step 21.

- b. Otherwise, disconnect the cable from the RO receptacle of the IBM 8228 to which the NAUN is connected. This cable is the upstream end of the removed ring segment. Continue with step 21.
21. Disconnecting the downstream end of the fault domain.
  - a. If the beaconing device is an IBM 8220 optical fiber subsystem, disconnect the copper patch cable from the data receptacle of the downstream (RO) IBM 8220. This IBM 8220 is the downstream end of the removed ring segment. Continue with step 22.
  - b. Otherwise, disconnect the copper patch cable from the RI receptacle of the IBM 8228 to which the NAUN is connected. This cable is the downstream end of the removed ring segment. Continue with step 22.
22. Determining the next step.
  - a. If your observer terminal is connected to an IBM 8228 that is within the removed fault domain, go to step 24.
  - b. Otherwise, continue with step 23.
23. Using your observer terminal, determine ring status.
  - a. If the observer terminal's ring is now operational, there is a problem in the removed ring segment. Ring recovery is complete. Go to step 26.
  - b. Otherwise, there are multiple problems on the ring. Reconnect all cables to their proper receptacles. Notify the network administrator and/or go to "Manual Procedure, Part 1" on page 3-59.
24. Using your observer terminal, determine ring status.
  - a. If the observer terminal's ring is now operational, continue with step 25.
  - b. Otherwise, there is a problem in the removed ring segment. Ring recovery is complete. Go to "Beacon Isolation - Part 1" on page 3-16 to isolate the fault.
25. The problem appears to have disappeared.

Reconnect all cables to their proper receptacles.

  - a. If the observer terminal's ring is now operational, the problem has disappeared. Ring recovery is complete and no further action is required.
  - b. Otherwise, this procedure has failed to locate the problem. Notify the network administrator and/or go to "Manual Procedure, Part 1" on page 3-59.
26. Determining the next step.
  - a. If the removed ring segment contains any components other than a patch cable, go to "Beacon Isolation - Part 1" on page 3-16 to isolate the fault.
  - b. Otherwise, continue with step 27.
27. Testing the removed patch cable.

Replace the disconnected patch cable with a spare and reconnect it to the proper receptacles.

  - a. If the observer terminal's ring is now operational, the removed patch cable is defective. Recovery and isolation are complete and no further action is required.

- b. Otherwise, this procedure has failed to locate the problem. Notify the network administrator and/or go to "Manual Procedure, Part 1" on page 3-59.
28. The observer terminal is connected to the bypassed IBM 8228. Determine if there is a device connected to another IBM 8228 that may be used as an observer terminal in order to determine the status of the remaining ring.

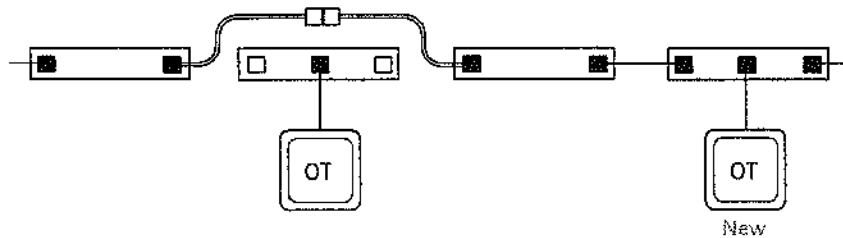

- a. If there is another device capable of being used as an observer terminal, continue with step 29.
  - b. Otherwise, go to "Isolation of an IBM 8228" on page 3-127 and complete isolation of the bypassed IBM 8228.
29. Using the new observer terminal, determine the status of the remaining ring.
- a. If the new observer terminal's ring is operational, ring recovery is complete. Go to "Isolation of an IBM 8228" on page 3-127 to complete isolation of the bypassed IBM 8228.
  - b. Otherwise, there are multiple problems on the ring. Return to "Starting the Problem Determination Procedures" on page 3-5 to find the next problem. Remember to complete isolation of the bypassed IBM 8228, you must go to "Isolation of an IBM 8228" on page 3-127 after locating all the problems on the ring.

---

## Ring Recovery: Beaconing on the Backup Ring

This procedure is used when a fault is causing a downstream (RO) IBM 8220 to beacon on the backup ring while the main ring is operating properly. While you are following this procedure, the main ring will be unavailable for use. Therefore, you should schedule this activity when it will have the least impact on ring users.

**Note:** Some of these procedures will require that you find a certain device or component. See Appendix A for instructions.

1. Determine the fault domain. Refer to "Identifying the Fault Domain" in Appendix A, if necessary.

For this procedure, select an observer terminal that is not located within the fault domain.

You will now remove a portion of the ring between the beaconing IBM 8220 optical fiber subsystem and the NAUN. This portion will be referred to as the "removed ring segment."

**Note:** An IBM 8220 optical fiber subsystem is a segment of the main ring path containing only optical fiber cabling with a converter at each end.

Go to the location of the beaconing IBM 8220 optical fiber subsystem and disconnect the copper patch cable from the data receptacle of the downstream (RO) IBM 8220.

Go to the location of the NAUN IBM 8220 optical fiber subsystem and disconnect the copper patch cable from the data receptacle of the upstream (RI) IBM 8220.

Using the observer terminal, determine ring status.

- a. If the observer terminal's ring is now operational, the problem is in the removed ring segment. Go to "Beacon Isolation - Part 1" on page 3-16.
  - b. Otherwise, the fault is located in one of the IBM 8220 optical fiber subsystems. Continue with step 2.
2. Go to the location of the downstream (RO) IBM 8220 of the NAUN and remove the IBM 8220 optical fiber subsystem from the ring by disconnecting the copper patch cable from the data receptacle of the downstream (RO) IBM 8220.

Using the observer terminal, determine ring status.

- a. If the observer terminal's ring is now operational, the problem is in the IBM 8220 optical fiber subsystem (NAUN). Reconnect the copper patch cable to the beaconing IBM 8220 and then go to "Isolation of an IBM 8220 Optical Fiber Subsystem" on page 3-115.
  - b. Otherwise, reconnect the copper patch cable to the downstream (RO) IBM 8220 and continue with step 3.
3. Go to the location of the upstream (RI) IBM 8220 of the beaconing IBM 8220 and remove the IBM 8220 optical fiber subsystem from the ring by disconnecting the copper patch cable from the data receptacle of the upstream (RI) IBM 8220.

Using the observer terminal, determine ring status.

- a. If the observer terminal's ring is now operational, the problem is in the IBM 8220 optical fiber subsystem (beacon). Reconnect the copper patch cable to the NAUN IBM 8220 and go to "Isolation of an IBM 8220 Optical Fiber Subsystem" on page 3-115.

- b. Otherwise, there appears to be multiple problems on the ring. Reconnect all cables and go to "Manual Procedure, Part 1" on page 3-59.

## Beacon Isolation - Part 1

You have removed the segment of the ring that contains the fault. Now you will perform isolation on the removed portion.

1. Select a device within the removed portion to use as your observer terminal. This device must be capable of executing your diagnostic tool or program. Use this device as your observer terminal until instructed to select a new one.

Go to the wiring closet that contains your observer terminal's IBM 8228.

Bypass the new observer terminal's IBM 8228.

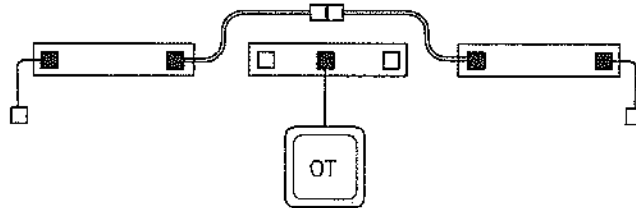

- a. If the new observer terminal's ring is operational, reconnect the cables to the 8228, then continue with step 2.
  - b. Otherwise, the bypassed IBM 8228 or one of its lobes may be defective. Go to "Isolation of an IBM 8228" on page 3-127.
2. Using the Ring Sequence Charts, determine if there are any IBM 8228s in this wiring closet that are in the removed ring segment that have not been bypassed. "This wiring closet" refers to the last wiring closet to which you were sent.
    - a. If so, continue with step 3.
    - b. Otherwise, go to step 4.
  3. Write down step 6 and its page number. Then, go to "Testing IBM 8228s" on page 3-108 and test all IBM 8228s in this wiring closet that are in the removed ring segment. Return to step 6 if all IBM 8228s in this wiring closet that are in the removed ring segment are operational.

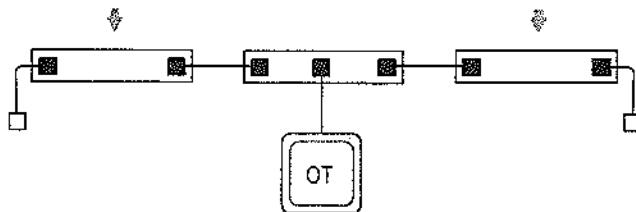

- a. If there are any IBM 8218s in this wiring closet that are in the removed ring segment, go to step 11.
  - b. Otherwise, continue with step 5.
4. Using the Ring Sequence Charts, determine if there are any IBM 8218s in this wiring closet that are in the removed ring segment.

5. Using the Ring Sequence Charts, determine if there are any IBM 8219s in this wiring closet that are in the removed ring segment.
  - a. If there is an IBM 8219 in this wiring closet that is in the removed ring segment, go to step 19.
  - b. Otherwise, continue with step 6.
6. Write down step 7 and its page number. Then, go to "Testing Patch Cables" on page 3-122 and test each of the patch cables including any yellow crossover cables in this wiring closet that are in the removed ring segment.



Return to step 7 after if all patch cables in this wiring closet that are in the removed ring segment are operational.

7. Using the Ring Sequence Charts, determine if there is an IBM 8220 in this wiring closet that is in the removed ring segment.
  - a. If there is an IBM 8220 in this wiring closet and it is the upstream end of the removed ring segment, continue with step 8.
  - b. If there is an IBM 8220 in this wiring closet and it is the downstream end of the removed ring segment, go to step 9.
  - c. Otherwise, go to step 10.
8. The IBM 8220 in this wiring closet is the upstream end of the removed ring segment.

Disconnect the copper patch cable from the data receptacle of the downstream (RO) IBM 8220.

- a. If the observer terminal's ring is now operational, the IBM 8220 optical fiber subsystem that is the upstream end of the removed ring segment is defective. Reconnect the cable at the downstream end of the removed ring segment. Then go to "Isolation of an IBM 8220 Optical Fiber Subsystem" on page 3-115.
  - b. Otherwise, reconnect the copper patch cable to the data receptacle of the IBM 8220, then continue with step 10.
9. The IBM 8220 in this wiring closet is the downstream end of the removed ring segment.

Disconnect the copper patch cable from the data receptacle of the upstream (RI) IBM 8220.

- a. If the observer terminal's ring is now operational, the IBM 8220 optical fiber subsystem that is the downstream end of the removed ring segment is defective. Reconnect the cable at the upstream end of the removed ring segment. Then go to "Isolation of an IBM 8220 Optical Fiber Subsystem" on page 3-115.
- b. Otherwise, reconnect the copper patch cable to the data receptacle of the IBM 8220, then go to step 10.



10. Using the Ring Sequence Charts, determine if any of the components (cables, IBM 8228s, IBM 8218s, etc.) in the removed ring segment are located in another wiring closet. Treat IBM 8218s, IBM 8219s, IBM 8220s, and IBM 8228s located between wiring closets as though they are in wiring closets when performing this procedure.
  - a. If part of the removed ring segment is in another wiring closet and has not been tested, go to that wiring closet and then return to step 2 to test the components in that wiring closet.
  - b. Otherwise, go to "Beacon Isolation - Part 3" on page 3-24.
11. At one pair of IBM 8218s in this wiring closet, observe the power indicator on both IBM 8218s.

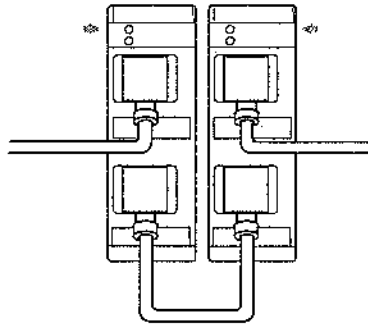

- a. If the power indicators on both IBM 8218s are lit, continue with step 12.
  - b. Otherwise, go to "IBM 8218/8219/8220 Power Problems" on page 3-163.
12. At one pair of IBM 8218s, bypass the first IBM 8218 by disconnecting the cables from the RI and RO receptacles and connecting the cables together.

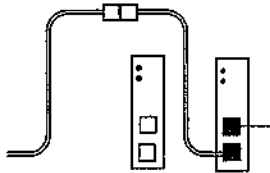

- a. If the observer terminal's ring is operational, the bypassed IBM 8218 may be defective. Go to "Replacing a Defective IBM 8218" on page 3-178.
  - b. Otherwise, reconnect the cables to the IBM 8218, then continue with step 13.
13. Bypass the second IBM 8218 by disconnecting the cables from the RI and RO receptacles and connecting the cables together.

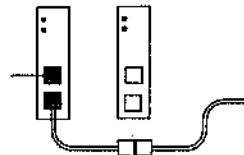

- a. If the observer terminal's ring is operational, the bypassed IBM 8218 is defective. Go to "Replacing a Defective IBM 8218" on page 3-178.
- b. Otherwise, reconnect the cables to the IBM 8218, then continue with step 14.

14. Determine if white Data Grade Media (DGM)-to-Type Filter cables are connected to the IBM 8218s.

a. If DGM-to-Type 3 Filter cables are present, continue with step 15.

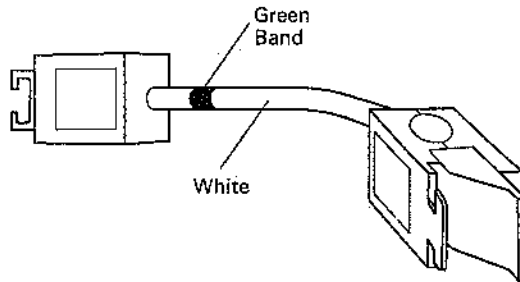

b. Otherwise, go to step 17.

15. Temporarily replace the DGM-to-Type 3 Filter cable connected to the first IBM 8218 with a spare filter cable.

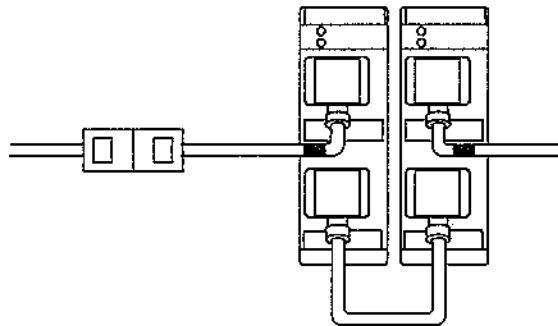

a. If the observer terminal's ring is operational, the filter cable just replaced is defective. Go to step 18.

b. Otherwise, remove the spare filter cable and reconnect the original filter cable, then continue with step 16.

16. Temporarily replace the filter cable connected to the second IBM 8218 with a spare filter cable.

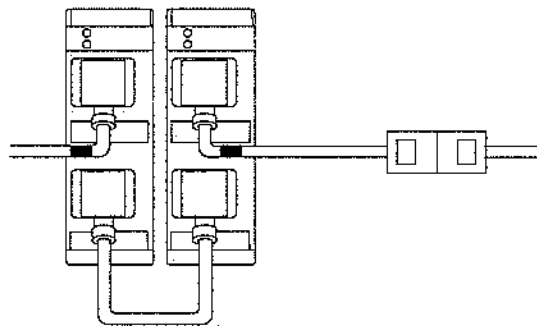

a. If the observer terminal's ring is operational, the filter cable just replaced is defective. Go to step 18.

b. Otherwise, remove the spare filter cable and reconnect the original filter cable, then continue with step 17.

17. Check for more IBM 8218s.
  - a. If there are more IBM 8218s in this wiring closet that are in the removed ring segment that have not been bypassed, go to the next pair and return to step 11 to test the next pair.
  - b. Otherwise, return to step 5.
18. The white DGM-to-Type 3 Filter cable just replaced is defective. Obtain a new filter cable to be used as a spare in the future.

Reconnect any cables that have not been reconnected.

- a. If the observer terminal's ring is operational, the isolation is complete.
  - b. Otherwise, there is another problem on the ring. Go to "Starting the Problem Determination Procedures" on page 3-5 to locate the next problem.
19. At an IBM 8219 in this wiring closet that is in the removed ring segment, observe the power light on the IBM 8219.

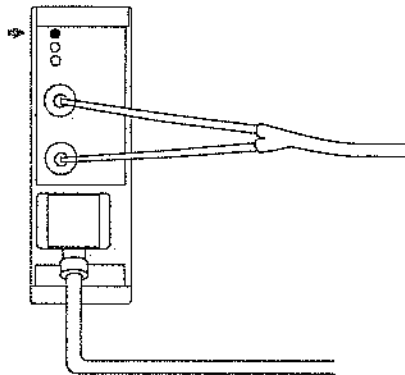

- a. If the power light on the IBM 8219s is on, continue with step 20.
  - b. Otherwise, go to "IBM 8218/8219/8220 Power Problems" on page 3-163.
20. Check for another IBM 8219.
    - a. If there is another IBM 8219 in this wiring closet that is in the removed ring segment and has not had its power indicator checked, go to the next IBM 8219 and return to step 19 to test it.
    - b. Otherwise, return to step 6.

---

## Beacon Isolation - Part 2

1. Since there is no device within the fault domain that is capable of executing the diagnostic tool or program, continued isolation of this fault requires that the fault domain be in the main ring. Be aware that this will cause the entire ring to be inoperative during isolation. At this point, you may continue with isolation while the ring is inoperative or you may remove the fault domain and restore the remaining portion of the ring to operation. In the latter case, isolation can be deferred until a later time.
  - a. If you wish to restore all of the ring except the fault domain to operation at this time, continue with step 2.
  - b. Otherwise, go to the wiring closet that contains the NAUN's IBM 8228 or downstream (RO) IBM 8220 if the NAUN is an IBM 8220 optical fiber subsystem, then go to step 5.

**Note:** An IBM 8220 optical fiber subsystem is a segment of the main ring path consisting only of optical fiber cabling with a converter at each end.
2. In the next two steps you will remove a portion of the fault domain from the ring. In this step, you will disconnect the upstream end of the fault domain.
  - a. If the NAUN device is an IBM 8220 optical fiber subsystem, disconnect the copper patch cable from the data receptacle of the upstream (RI) IBM 8220. This IBM 8220 is the upstream end of the removed ring segment. Continue with step 3.
  - b. Otherwise, disconnect the copper patch cable from the RO receptacle of the IBM 8228 to which the NAUN is connected. This cable is the upstream end of the removed ring segment. Continue with step 3.
3. Disconnect the downstream end of the fault domain.
  - a. If the beaconing device is an IBM 8220 optical fiber subsystem, disconnect the copper patch cable from the data receptacle of the downstream (RO) IBM 8220. This IBM 8220 is the downstream end of the removed ring segment. Continue with step 4.
  - b. Otherwise, disconnect the cable from the RI receptacle of the IBM 8228 to which the NAUN is connected. This cable is the downstream end of the removed ring segment. Continue with step 4.
4. The remaining portion of the ring should be operational. You should record the addresses of the beaconing device and the NAUN along with the location of the two copper patch cables that were disconnected in steps 2 and 3.

When you are ready to continue with the isolation of this problem, return to this step.

- a. Reconnect the copper patch cables at the downstream end of the removed ring segment.
- b. Reconnect the copper patch cables at the upstream end of the removed ring segment.
- c. Restart your diagnostic tool or program on your observer terminal.
- d. Continue with step 5.

5. Use the Ring Sequence Charts to determine if there are any IBM 8228s in this wiring closet that are in the fault domain and have not been bypassed.
  - a. If so, continue with step 6.
  - b. Otherwise, go to step 7.
6. Write down step 7 and its page number. Then go to "Testing IBM 8228s" on page 3-108 and test all IBM 8228s in this wiring closet that are in the removed ring segment. Return to step 7 if all IBM 8228s in this wiring closet that are in the fault domain are operational.
7. Using the Ring Sequence Charts, determine if there are any IBM 8218s or IBM 8219s in this wiring closet that are in the fault domain.
  - a. If there are any IBM 8218s or IBM 8219s in this wiring closet that are in the fault domain, write down step 8 and its page number, then go to "Testing IBM 8218s and IBM 8219s" on page 3-109. Return to step 8 if all IBM 8218s and/or IBM 8219s in this wiring closet that are in the fault domain are operational.
  - b. Otherwise, continue with step 8.
8. Using the Ring Sequence Charts, determine if there are any IBM 8220s in this wiring closet that are in the fault domain.
  - a. If there are any IBM 8220s in this wiring closet that are in the fault domain, write down step 9 and its page number, then go to "Testing an IBM 8220 Optical Fiber Subsystem" on page 3-114.  
  
Return to step 9 if all IBM 8220s in this wiring closet that are in the fault domain are operational.
  - b. Otherwise, continue with step 9.
9. Write down step 10 and its page number. Then go to "Testing Patch Cables" on page 3-122 and test each of the patch cables including any yellow crossover patch cables in this wiring closet that are in the fault domain.  
  
Return to step 10 after if all patch cables in this wiring closet that are in the fault domain are operational.
10. Using the Ring Sequence Charts, determine if the IBM 8228 to which the beaconing device is connected is in this wiring closet.
  - a. If the IBM 8228 to which the beaconing device is connected is in this wiring closet, continue with step 11.
  - b. Otherwise, go to the next downstream wiring closet, then return to step 5 to test the components in that wiring closet. Treat IBM 8228s, IBM 8218s, and IBM 8219s located between wiring closets as though they are in wiring closets when performing this procedure.
11. Determining the next step.
  - a. If the fault domain contains components or patch cables that are located in multiple wiring closets, go to step 12.
  - b. Otherwise, this procedure has failed to locate the problem. Notify the network administrator and/or go to "Manual Procedure, Part 1" on page 3-59.

12. Write down step 13 and its page number. Then go to "Testing Ring Segments" on page 3-123 and test all inter-wiring closet cables.

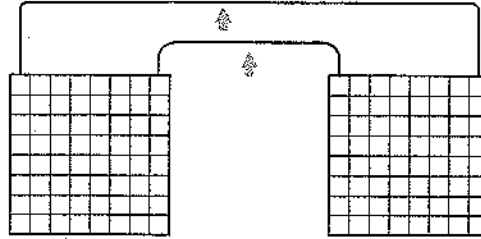

Continue with step 13 if all inter-wiring closet cables in the fault domain are operational.

13. Checking total ring. Be sure all cables have been reconnected.
- If the observer terminal's ring is now operational, the problem has been resolved or has disappeared. No further action is required.
  - Otherwise, this procedure has failed to locate the problem. Notify the network administrator and/or go to "Manual Procedure, Part 1" on page 3-59 to continue.

## Beacon Isolation - Part 3

1. Determining the next step.
  - a. If the removed ring segment contains components that are located in multiple wiring closets, go to the first (in ring sequence) wiring closet that contains any part of the removed ring segment, then continue with step 2.
  - b. Otherwise, this procedure has failed to locate the problem. Notify the network administrator and/or go to "Manual Procedure, Part 1" on page 3-59.
2. Checking the location of the observer terminal's IBM 8228.
  - a. If the observer terminal is connected to an IBM 8228 that is located in this wiring closet, go to step 3.
  - b. Otherwise, go to step 6.
3. Go to the next downstream wiring closet.
  - a. If there is an IBM 8228 in this wiring closet that is in the removed ring segment, continue with step 4.
  - b. Otherwise, go to step 8.
4. Disconnect the patch cable from the RI receptacle of the first IBM 8228 in this wiring closet.

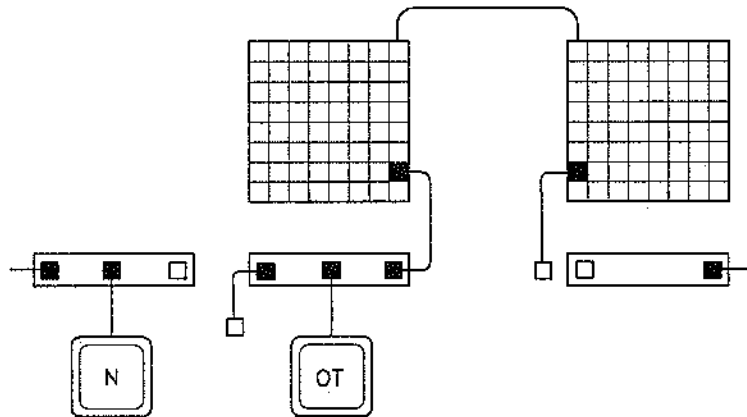

- a. If the observer terminal's ring is now operational, continue with step 5.
  - b. Otherwise, the patch cable between this wiring closet and the next upstream wiring closet is defective. Reconnect the patch cable to the IBM 8228, then go to step 10.
5. Reconnect the patch cable to the first IBM 8228 in this wiring closet.
  - a. If any part of the removed ring segment is located in the next downstream wiring closet, return to step 3.
  - b. Otherwise, go to step 9.

6. Go to the next downstream wiring closet. Disconnect the patch cable from the RI receptacle of the first IBM 8228 in this wiring closet.

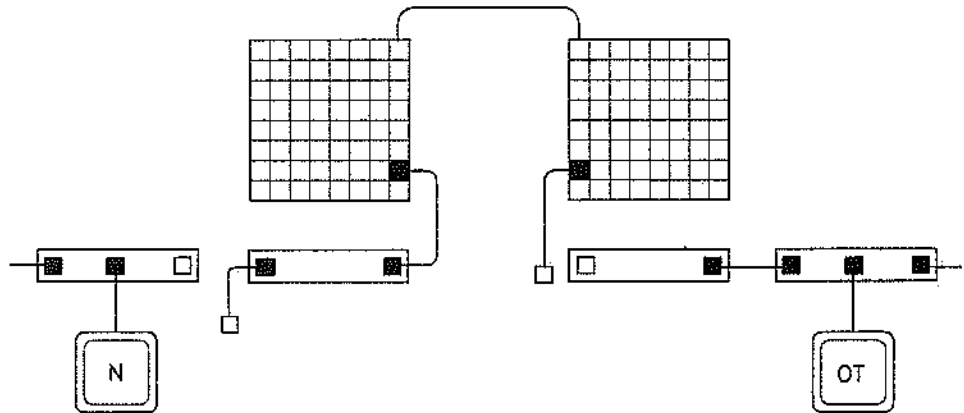

- a. If the observer terminal's ring is now operational, the cable between this wiring closet and the next upstream wiring closet is defective. Reconnect the patch cable to the IBM 8228, then go to step 10.
  - b. Otherwise, continue with step 7.
7. Reconnect the patch cable to the first IBM 8228 in this wiring closet.
    - a. If any part of the removed ring segment is located in the next downstream wiring closet, return to step 2.
    - b. Otherwise, go to step 9.
  8. Determine the ring status.
    - a. If the observer terminal's ring is now operational, continue with step 9.
    - b. Otherwise, the cable between this wiring closet and the next upstream wiring closet is defective. Reconnect the patch cable to the IBM 8228, then go to step 10.
  9. The problem appears to have disappeared or this procedure has failed to locate the problem.
 

Reconnect all cables to the proper receptacles.

    - a. If the observer terminal's ring is now operational, the problem has disappeared. No further actions required.
    - b. Otherwise, this procedure has failed to locate the problem. Notify the network administrator and/or go to "Diagnosing Difficult Ring Problems" on page 3-166.
  10. Using the Ring Sequence Chart, determine whether the defective cable is a copper patch cable or a fiber optic cable.
    - a. If it is a copper patch cable, continue with step 11.
    - b. Otherwise, go to step 12.



11. Disconnect the defective inter-wiring closet copper patch cable by doing the following:

- a. Disconnect the copper patch cable that connects the first IBM 8228 or IBM 8218 in this wiring closet to the distribution panel from the distribution panel.

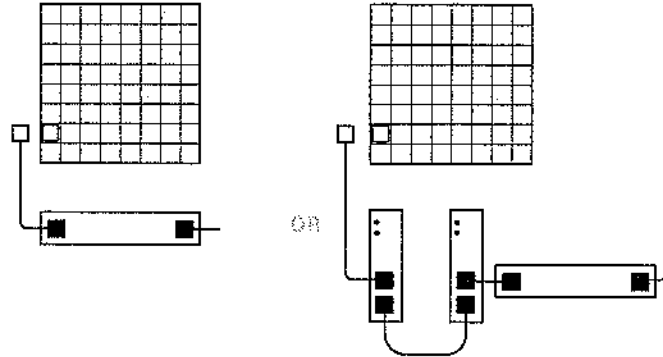

- b. Go to the next upstream wiring closet. Disconnect the copper patch cable that connects the last IBM 8228 or IBM 8218 in this wiring closet to the distribution panel from the distribution panel.

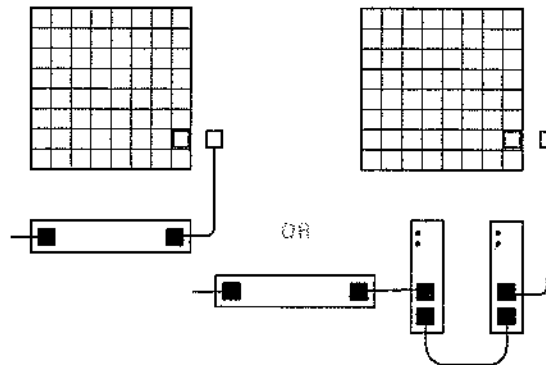

- c. Now reconnect any other cables (other than the defective cable) that have not been reconnected.
- d. Write down step 12 and its page number. Then, go to "Testing Data Cables" on page 3-171 to repair the defective patch cable. Return to step 12 after repairing the defective cable.

12. Disconnect the defective inter-wiring closet cable by doing the following:

Disconnect the copper patch cable from the data receptacle of the first IBM 8219 in this wiring closet.

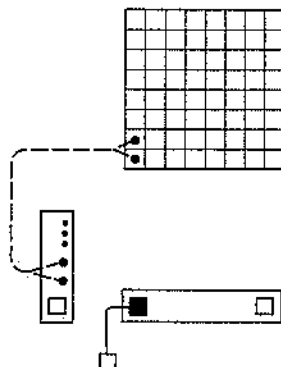

- a. Go to the next upstream wiring closet. Disconnect the copper patch cable from the data receptacle of the last IBM 8219 in this wiring closet.

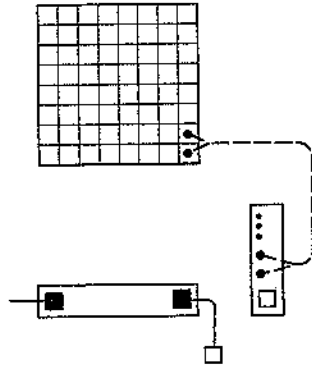

- b. Now reconnect any other cables (other than the defective cable) that have not been reconnected.
- c. Go to "Isolation of an Optical Fiber Ring Segment, Part 1" on page 3-156 to repair the defective segment.

---

## Ring Recovery for Soft Errors, Part 1

Parts 1 and 2 of this procedure will isolate the faulty component that is causing soft errors on the ring.

**Note:** Some of these procedures will require that you find a certain device or component. See Appendix A for instructions.

1. Record the adapter addresses and error counts for the first and second devices indicated in the soft error message. Whenever these procedures refer to the first device and the second device, use these addresses you recorded to identify those devices.

**Note:** Disregard any fault domain changes that may occur during this procedure. Continue to use the original fault domain regardless of changes that may occur.

When resolving soft error problems, *wait six minutes* at the observer terminal in order for the IBM Token-Ring Network Ring Diagnostic or the IBM Token-Ring Network Manager to indicate a decreasing soft error rate.

- a. If the soft error message indicates addresses for both the first and second devices, continue with step 2.
  - b. Otherwise, go to "Soft Error Isolation with One Address Known" on page 3-37.
2. Determining the ring configuration.
    - a. If this ring contains two or more IBM 8228s, continue with step 3.
    - b. Otherwise, it consists of a single IBM 8228. Go to "Isolation of an IBM 8228" on page 3-127.
  3. Determining the network diagnostic tool.
    - a. If you are using the IBM Token-Ring Network Manager and you have performed the actions described in the *IBM Token-Ring Network Manager User's Guide*, continue with step 4.
    - b. If you are using the IBM Token-Ring Network Manager and you have NOT performed the actions described in the *IBM Token-Ring Network Manager User's Guide*, follow those instructions, then continue with step 4.
    - c. Otherwise, go to step 5.
  4. Determining the next step.
    - a. If the Network Manager manual said to use the symptom "Soft Error on a Lobe," and the indicated device is an IBM 8220 optical fiber subsystem, go to "Isolation of an IBM 8220 Optical Fiber Subsystem" on page 3-115.
    - b. If the Network Manager manual said to use the symptom "Soft Errors on a Lobe" and the suspected device is not an IBM 8220 subsystem, go to "Lobe Logic Isolation, Soft Errors" on page 3-137.
    - c. Otherwise, go to "Ring Recovery for Soft Errors, Part 2" on page 3-33.

5. Determining the location of the observer terminal.

- a. If the device containing the first adapter is being used as the observer terminal, go to step 12.

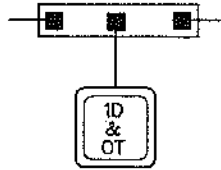

- b. If the device containing the second adapter is being used as the observer terminal, go to step 15.

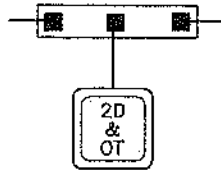

- c. Otherwise, continue with step 6.

6. Determine adapter type.

- a. If the error counts for the first and second adapters are equal and the first adapter is an IBM 8220 optical fiber subsystem, go to step 8.
- b. If the error counts for the first and second adapters are not equal and the adapter with the higher error count is an IBM 8220 optical fiber subsystem, go to step 8.
- c. Otherwise, continue with step 7.

7. Remove the adapter with the higher error count (if the error counts are equal, remove the first adapter) from the ring by terminating the application program or powering the device down.

**Note:** Terminating some application programs will not cause the lobe to be removed from the ring by the IBM 8228. If you choose to terminate the application program, ensure that the lobe is removed from the ring by the IBM 8228. Otherwise, you should remove power from the device.

*Wait six minutes* for the application program to indicate a change in status.

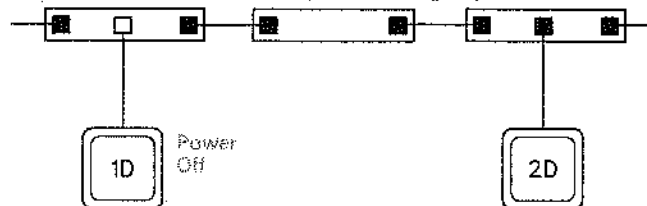

- a. If the observer terminal's ring is now operational, the removed device, its lobe or lobe logic in the IBM 8228 may be defective. Go to "Lobe Logic Isolation, Soft Errors" on page 3-137.
- b. Otherwise, restore power to the removed device, restart the application program on the removed device and go to step 9.

8. Remove power from the upstream (RI) IBM 8220 of the IBM 8220 optical fiber subsystem (with the higher error count or first adapter if counts are equal).

**Note:** To remove power from a rack-mounted IBM 8220, *slide the unit out of the rack*. For surface-mounted installations, *disconnect the power cord from the unit or wall receptacle*.

*Wait six minutes* for the diagnostics to indicate a change in status.

- a. If the observer terminal's ring is now operational, the removed IBM 8220 optical fiber subsystem may be defective. Go to "Isolation of an IBM 8220 Optical Fiber Subsystem" on page 3-115.
  - b. Otherwise, reapply power to the removed IBM 8220 and continue with step 9.
9. Determine adapter type.
    - a. If the error counts for the first and second adapters are equal and the second adapter is an IBM 8220 optical fiber subsystem, go to step 11.
    - b. If the error counts for the first and second adapters are not equal and the adapter with the lower error count is an IBM 8220 optical fiber subsystem, go to step 11.
    - c. Otherwise, continue with step 10.
  10. Remove the adapter with the lower error count (if the error counts are equal, remove the second adapter) from the ring by terminating the application program or powering the device down.

**Note:** Terminating some application programs will not cause the lobe to be removed from the ring by the IBM 8228. If you choose to terminate the application program, ensure that the lobe is removed from the ring by the IBM 8228. Otherwise, you should remove power from the device.

*Wait six minutes* for the diagnostics to indicate a change in status.

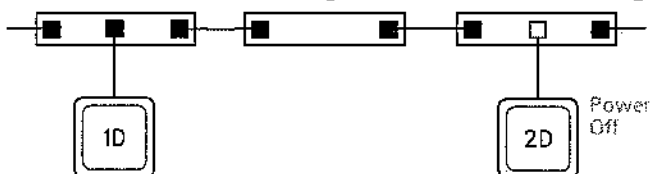

- a. If the observer terminal's ring is now operational, the removed device, its lobe or lobe logic in the IBM 8228 may be defective. Go to "Lobe Logic Isolation, Soft Errors" on page 3-137.
  - b. Otherwise, restart the removed device and go to "Ring Recovery for Soft Errors, Part 2" on page 3-33.
11. Remove power from the upstream (RI) IBM 8220 of the IBM 8220 optical fiber subsystem (with the lower error count or the second adapter if the counts are equal).

**Note:** To remove power from a rack-mounted IBM 8220, *slide the unit out of the rack*. For surface-mounted installations, *disconnect the power cord from the unit or wall*.

*Wait six minutes* for the diagnostics to indicate a change in status.

- a. If the observer terminal's ring is now operational, the removed IBM 8220 subsystem may be defective. Go to "Isolation of an IBM 8220 Optical Fiber Subsystem" on page 3-115.

- b. Otherwise, reapply power to the removed IBM 8220 and go to “Ring Recovery for Soft Errors, Part 2” on page 3-33.
12. Determine adapter type.
    - a. If the second adapter is an IBM 8220 optical fiber subsystem, go to step 14.
    - b. Otherwise, continue with step 13.
  13. Remove the second adapter from the ring by terminating the application program or powering the device down.

**Note:** Terminating some application programs will not cause the lobe to be removed from the ring by the IBM 8228. If you choose to terminate the application program, ensure that the lobe is removed from the ring by the IBM 8228. Otherwise, you should remove power from the device.

*Wait six minutes* for the diagnostics to indicate a change in status.

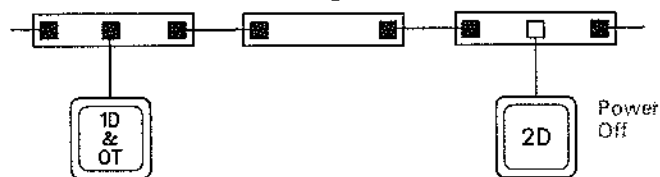

- a. If the observer terminal’s ring is now operational, the removed device, its lobe or lobe logic in the IBM 8228 may be defective. Go to “Lobe Logic Isolation, Soft Errors” on page 3-137.
  - b. Otherwise, restart the removed device and go to “Ring Recovery for Soft Errors, Part 2” on page 3-33.
14. Remove the IBM 8220 optical fiber subsystem (second adapter) from the ring by removing power from its upstream (RI) IBM 8220.

**Note:** To remove power from a rack-mounted IBM 8220, *slide the unit out of the rack*. For surface-mounted installations, *disconnect the power cord from the unit or wall*.

*Wait six minutes* for the diagnostics to indicate a change in status.

- a. If the observer terminal’s ring is now operational, the removed IBM 8220 optical fiber subsystem may be defective. Go to “Isolation of an IBM 8220 Optical Fiber Subsystem” on page 3-115.
  - b. Otherwise, reapply power to the removed IBM 8220 and go to “Ring Recovery for Soft Errors, Part 2” on page 3-33.
15. Determine adapter type.
    - a. If the first adapter is an IBM 8220 optical fiber subsystem, go to step 17.
    - b. Otherwise, continue with step 16.

16. Remove the first adapter from the ring by terminating the application program or powering the device down.

**Note:** Terminating some application programs will not cause the lobe to be removed from the ring by the IBM 8228. If you choose to terminate the application program, ensure that the lobe is removed from the ring by the IBM 8228. Otherwise, you should remove power from the device.

*Wait six minutes* for the diagnostics to indicate a change in status.

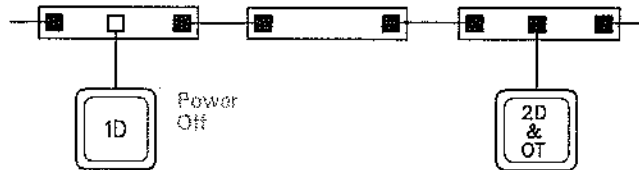

- a. If the observer terminal's ring is now operational, the removed device, its lobe or lobe logic in the IBM 8228 may be defective. Go to "Lobe Logic Isolation, Soft Errors" on page 3-137.
  - b. Otherwise, restart the removed device and go to "Ring Recovery for Soft Errors, Part 2" on page 3-33.
17. Remove the IBM 8220 optical fiber subsystem (first adapter) from the ring by removing power from its upstream (RI) IBM 8220.

**Note:** To remove power from a rack-mounted IBM 8220, *slide the unit out* of the rack. For surface-mounted installations, *disconnect the power cord* from the unit or wall.

*Wait six minutes* for the diagnostics to indicate a change in status.

- a. If the observer terminal's ring is now operational, the removed IBM 8220 subsystem may be defective. Go to "Isolation of an IBM 8220 Optical Fiber Subsystem" on page 3-115.
- b. Otherwise, reapply power to the removed IBM 8220 and go to "Ring Recovery for Soft Errors, Part 2" on page 3-33.

## Ring Recovery for Soft Errors, Part 2

1. Determining the upstream end of the fault domain for this procedure.

If the first adapter address is part of an IBM 8220 optical fiber subsystem, the fault domain starts with the copper patch cable connected to the data receptacle of the downstream (RO) IBM 8220 or the IBM 8220 optical fiber subsystem. Otherwise, it starts with the copper patch cable connected to the RO receptacle of the first adapter's IBM 8228.

**Note:** An IBM 8220 optical fiber subsystem is a segment of the main ring path containing only optical fiber cabling with a converter at each end.

If the second adapter is an IBM 8220 optical fiber subsystem, the fault domain ends with the copper patch cable connected data receptacle of the upstream (RI) IBM 8220 of the subsystem. Otherwise, the fault domain ends with the copper patch cable that connects to the RI receptacle of the second adapter's IBM 8228.

If neither adapter is an IBM 8220 and both adapters are connected to the same IBM 8228, continue with step 2.

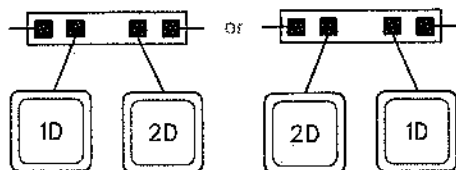

Otherwise, go to step 3.

2. The first adapter and second adapter are on the same IBM 8228.
  - a. If the second adapter is connected to a lower-numbered lobe than the first adapter, then the entire ring is in the fault domain. Go to step 3.
  - b. Otherwise, the fault domain consists only of the IBM 8228 to which the first adapter and second adapter are attached. Bypass the IBM 8228, then go to "Isolation of an IBM 8228" on page 3-127 to complete isolation.
3. Go to the wiring closet that contains the first adapter's IBM 8228 or to the wiring closet immediately downstream of the first adapter if it is an IBM 8220 optical fiber subsystem.
  - a. If the first adapter is an IBM 8220 optical fiber subsystem, go to step 6.
  - b. If the first adapter and your observer terminal are connected to the same IBM 8228 as the first adapter or if the first adapter is an observer terminal, go to step 5.

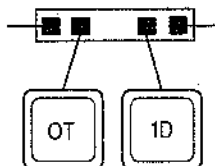

- c. Otherwise, continue with step 4.



4. Bypass the first adapter's IBM 8228.

*Wait six minutes for the diagnostics to indicate a change in status.*

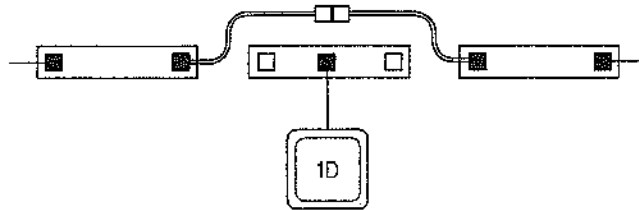

- a. If the observer terminal's ring is now operational, the bypassed IBM 8228 or one of its lobes may be defective. Go to "Isolation of an IBM 8228" on page 3-127 to continue.
- b. Otherwise, reconnect the cables to the IBM 8228 and go to step 6.

5. Bypass the first adapter's IBM 8228.

*Wait six minutes for the diagnostics to indicate a change in status.*

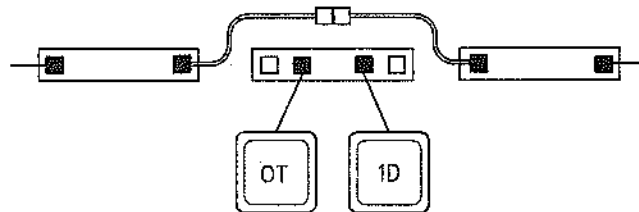

- a. If the observer terminal's ring is now operational, reconnect the cables to the IBM 8228 and continue with step 6.
- b. Otherwise, the bypassed IBM 8228 or one of its lobes may be defective. Go to "Isolation of an IBM 8228" on page 3-127.

6. Checking for the second adapter.

- a. If the second adapter is a device adapter and its IBM 8228 is in this wiring closet, continue with step 7.
- b. Otherwise, go to step 10.

7. Checking location of observer terminal.

- a. If the observer terminal and the second adapter are connected to the same IBM 8228, go to step 9.

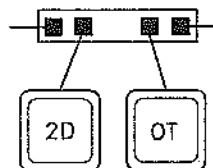

- b. Otherwise, continue with step 8.

8. Bypass the second adapter's IBM 8228.

*Wait six minutes for the diagnostics to indicate a change in status.*

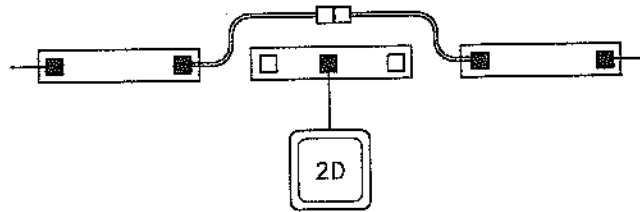

- a. If the observer terminal's ring is now operational, the bypassed IBM 8228 or one of the lobes connected to it may be defective. Go to "Isolation of an IBM 8228" on page 3-127.
- b. Otherwise, reconnect the cables to the IBM 8228 and go to step 10.

9. Bypass the second adapter's IBM 8228.

*Wait six minutes for the diagnostics to indicate a change in status.*

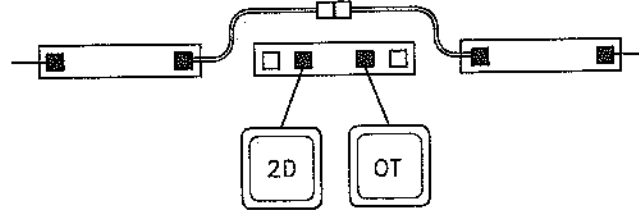

- a. If the observer terminal's ring is now operational, reconnect the cables to the IBM 8228 and continue with step 10.
- b. Otherwise, the bypassed IBM 8228 or one of the lobes connected to it may be defective. Go to "Isolation of an IBM 8228" on page 3-127 to continue.

10. Checking for IBM 8228s.

- a. If there are any IBM 8228s in this wiring closet and in the fault domain that have not been bypassed, write down step 11 and its page number. Then, go to "Testing IBM 8228s" on page 3-108 and test all the other IBM 8228s in this wiring closet that are in the fault domain.

Return to step 11 if all the IBM 8228s in this wiring closet that are in the fault domain are operational.

- b. Otherwise, continue with step 11.

11. Checking for IBM 8218s or IBM 8219s.

- a. If there are any IBM 8218s and/or IBM 8219s in this wiring closet that are in the fault domain, write down step 12 and its page number. Then, go to "Testing IBM 8218s and IBM 8219s" on page 3-109. Return to step 12 if all the IBM 8218s and/or IBM 8219s in this wiring closet that are in the fault domain are operational.

- b. Otherwise, continue with step 12.

12. Test patch cables.

Write down step 13 and its page number. Then go to "Testing Patch Cables" on page 3-122 and test all the patch cables including yellow crossover patch cables in this wiring closet that are in the fault domain.

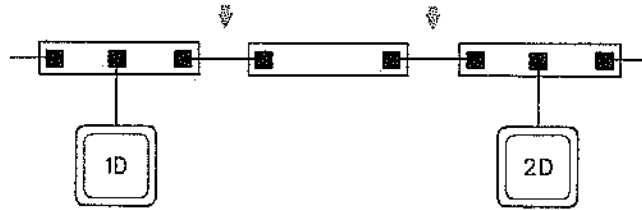

Continue with step 13 if all the patch cables in this wiring closet that are in the fault domain are operational.

13. Check for more wiring closets. Treat IBM 8228s, IBM 8218s and IBM 8219s located between wiring closets as though they are in wiring closets when performing this procedure.
  - a. If the fault domain is contained in a single wiring closet, go to step 15.
  - b. If there is another wiring closet that is in the fault domain, go to the next wiring closet in the fault domain and then return to step 6 of this procedure.
  - c. Otherwise, continue with step 14.

14. Write down step 15 and its page number. Then, go to "Testing Ring Segments" on page 3-123 and test all inter-wiring closet cables in the fault domain.

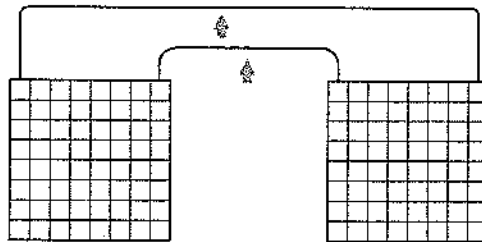

Continue with step 15 if all inter-wiring closet cables in the fault domain are operational.

15. Checking total ring.

Be sure all cables have been reconnected.

- a. If the observer terminal's ring is now operational, the problem has been resolved or has disappeared. No further action is required.
- b. Otherwise, this procedure has failed to locate the problem. Notify the network administrator and/or go to "Manual Procedure, Part I" on page 3-59 to continue.

## Soft Error Isolation with One Address Known

1. If you have not already done so, record the adapter address of the device indicated in the soft error message.

Using the Adapter Address to Physical Location Chart, determine the IBM 8228 to which the device is connected. Record the unit number of the IBM 8228.

<u>Adapter Address</u>	<u>IBM 8228</u>
10005A00000E	1003

- a. If this ring has more than one IBM 8228, continue with step 2.
  - b. Otherwise, go to "Isolation of an IBM 8228" on page 3-127 to isolate the problem on the single IBM 8228.
2. Determining the type of device containing the adapter indicated in the soft error message.
    - a. If the device is an IBM 8220 optical fiber subsystem, go to "Isolation of an IBM 8220 Optical Fiber Subsystem" on page 3-115.

**Note:** An IBM 8220 optical fiber subsystem is a segment of the main ring path containing only optical fiber cabling with a converter at each end.
    - b. Otherwise, continue with step 3.
  3. Remove the adapter's device by disconnecting its lobe cable from the IBM 8228 or turning off the power to the device.

**Note:** When resolving soft error problems and a procedure asks if the observer terminal's ring is operational, *wait six minutes* to allow the diagnostic tool to determine if the soft error rate is decreasing.

    - a. If the observer terminal's ring is now operational, the adapter just removed, its lobe, or the lobe logic in the IBM 8228 may be defective. The remainder of the ring is operational. Go to "Lobe Logic Isolation, Soft Errors" on page 3-137 to continue isolation of the problem.
    - b. Otherwise, return the removed adapter to the ring, and continue with step 4.
  4. Using the IBM 8228 Cabling Charts or the Locator charts, determine the IBM 8228 that the observer terminal is connected to.
    - a. If the observer terminal is connected to the same IBM 8228 as the reported device, continue with step 5.
    - b. Otherwise, go to step 6.

5. Bypass the device's IBM 8228.

*Wait six minutes* for the diagnostics to indicate a change in status.

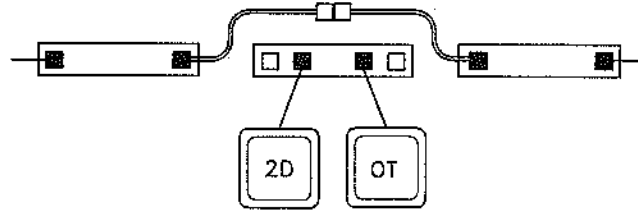

- a. If the observer terminal's ring is now operational, go to step 7.
- b. Otherwise, the bypassed IBM 8228 may be defective.
  - 1) Leave it bypassed.
  - 2) Go to "Isolation of an IBM 8228" on page 3-127.

6. Bypass the device's IBM 8228.

*Wait six minutes* for the diagnostics to indicate a change in status.

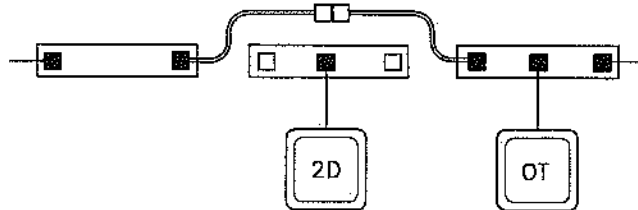

- a. If the observer terminal's ring is now operational, the bypassed IBM 8228 may be defective.
  - 1) Leave it bypassed.
  - 2) Go to "Isolation of an IBM 8228" on page 3-127.
- b. Otherwise, there are multiple problems on the ring.
  - 1) Write down the procedure "Isolation of an IBM 8228" on page 3-127 for use after locating the next problem.
  - 2) Leave the IBM 8228 bypassed.
  - 3) Return to "Ring Recovery for Soft Errors, Part 1" on page 3-28 to locate the next problem.

7. Reconnect the cables to the bypassed IBM 8228.

*Wait six minutes* for the diagnostics to indicate a change in status.

- a. If the observer terminal's ring is now operational, the problem has disappeared. No further action is required.
- b. Otherwise, this procedure has not isolated the problem. Notify the network administrator or go to "Manual Procedure, Part 1" on page 3-59.

---

## Diagnosing Intermittent Beaconing Conditions

This procedure may help in resolving beaconing conditions that disappear before the failing adapter, device, or cable can be found using the other problem determination procedures in this manual, but reappear at a later time. This procedure may require a significant amount of time depending upon the frequency of occurrence of the error condition.

**Note:** This procedure is intended for use by the network administrator or someone else with a considerable knowledge of how the IBM Token-Ring Network operates and a good knowledge of the topology of the failing ring.

1. Record the addresses of the NAUN and beaconing adapters indicated by the ring diagnostic or network monitor for several occurrences of the error condition.
  - a. If the addresses for the NAUN's adapter and beaconing adapter are the same for all occurrences, return to "Ring Recovery: Beaconing" on page 3-7 and increase the time you wait to determine if an action has resolved the problem by an amount approximately equal to the time between previous occurrences of the problem.
  - b. Otherwise, continue with step 2.
2. Determine if there is a portion of the ring that is common to all occurrences of the error. (The common portion consists of the NAUN and the beaconing adapter that are the closest together and the IBM 8228s, IBM 8218s, IBM 8219s, and/or cables between the the two.)
  - a. If there is a common portion, continue with step 3.
  - b. Otherwise, there are multiple faults on the ring. Contact your service supplier for assistance.
3. Perform the following actions if those particular devices are present in the common portion.
  - a. Go to "Testing IBM 8228s" on page 3-108 and test any IBM 8228s that are within the common portion. Return to 3b if all the IBM 8228s in the common portion are operational.
  - b. Go to "Testing IBM 8218s and IBM 8219s" on page 3-109 and test any repeaters that are within the common portion. Return to 3c if all the IBM 8218s and IBM 8219s in the common portion are operational.
  - c. Go to "Testing an IBM 8220 Optical Fiber Subsystem" on page 3-114 and test all IBM 8220 optical fiber subsystems that are in the common portion. Return to 3d if all IBM 8220 optical fiber subsystems are operational.
  - d. Go to "Testing Patch Cables" on page 3-122 and test all patch cables, including any yellow crossover cables, that are within the common portion. Continue with step 4 if all the patch cables in the common portion are operational.

4. Reconnect any cable that may not have been reconnected. Determine the ring status.
  - a. If the ring is now operational, the problem has been resolved or has disappeared.
  - b. Otherwise, this procedure has failed to locate the problem. Notify the network administrator and/or go to "Manual Procedure, Part I" on page 3-59.

## Diagnosing Intermittent Soft Errors

This procedure may help in resolving intermittent soft errors. Intermittent soft errors are those that disappear before the failing adapter, device, or cable can be found using the other problem determination procedures in this manual, but reappear at a later time. This procedure may require a significant amount of time depending upon the frequency of occurrence of the error condition.

**Note:** This procedure is intended for use by the network administrator or someone else with a considerable knowledge of how the IBM Token-Ring Network operates and a good knowledge of the topology of the failing ring.

1. Record the addresses of the first adapter and second adapter indicated by the ring diagnostic or network monitor for several occurrences of the error condition.

<u>Device</u>	<u>Adapter Address</u>	<u>Error Count</u>	<u>IBM 8228</u>
First Device	10005A000007	7F	
Second Device	10005A00000E	6A	

- a. If the addresses for the first adapter and second adapter are the same for all occurrences, return to "Ring Recovery for Soft Errors, Part 1" on page 3-28 and increase the time you wait to determine if an action has resolved the problem. Extend the waiting time by an amount approximately equal to the time between previous occurrences of the problem.
  - b. If the address for the first adapter changes from one occurrence to another and the address for the second adapter remains the same for all occurrences, go to step 3.
  - c. If the address for the second adapter changes from one occurrence to another and the address for the first adapter remains the same for all occurrences, go to step 2.
  - d. Otherwise, both addresses change from one occurrence to another. Go to step 4.
2. From the list of second adapter addresses, select the one that is closest in ring sequence to the first adapter. The first adapter and the second adapter closest in ring sequence to the first adapter identify the "common portion" to be used for the remainder of this procedure.  
Go to step 5.
  3. From the list of first adapter addresses, select the one that is closest in ring sequence to the second adapter. The second adapter and first adapter closest in ring sequence to the second adapter identify the "common portion" to be used for the remainder of this procedure.  
Go to step 5.



4. Determine if there is a "common portion" of the ring that is common to all occurrences of the problem.
  - a. If there is a common portion, go to step 5.
  - b. Otherwise, there are multiple faults on the ring. Notify the network administrator and/or go to "Manual Procedure, Part 1" on page 3-59.
5. Write down this step and page number. Then, perform the following actions if those particular devices are present in the common portion:
  - a. Go to "Testing IBM 8228s" on page 3-108 and test any IBM 8228s that are within the common portion. Continue with 9b if all the IBM 8228s in the common portion are operational.
  - b. Go to "Testing IBM 8218s and IBM 8219s" on page 3-109 and test any repeaters that are within the common portion. Return to 9c if all the IBM 8218s and IBM 8219s in the common portion are operational.
  - c. Go to "Testing an IBM 8220 Optical Fiber Subsystem" on page 3-114 and test all IBM 8220 optical fiber subsystems that are in the fault domain. Continue with 5d if all IBM 8220 optical fiber subsystems are operational.
  - d. Go to "Testing Patch Cables" on page 3-122 and test all patch cables, including any yellow crossover patch cables, that are within the common portion. Continue with step 10 if all the patch cables in the common portion are operational.
6. Reconnect any cable that may not have been reconnected. Determine ring status.
  - a. If the ring is now operational, the problem has been resolved or has disappeared.
  - b. Otherwise, this procedure has failed to locate the problem. Notify the network administrator and/or go to "Manual Procedure, Part 1" on page 3-59 to continue.

## Open Errors, Part 1

This procedure isolates the cause of open errors that occur when an adapter attempts to attach to the ring.

**Note:** These procedures may require that you isolate a certain device or component. See Appendix A for instructions.

1. Determining the ring configuration.
  - a. If this lobe has a device with Remote Program Load installed in it, go to "Open Errors, Part 1, for Remote Program Load" on page 3-49.
  - b. Otherwise, continue with step 2.
2. Using the documentation provided with your diagnostic tool, locate the device address and the "open error code" (sometimes called the "reason code" or the "error message"). Write down the adapter address. Then find the last digit of the open error code in the chart below and proceed to the indicated procedure.

Last Digit of Reason Code	Action to Take
1 — Function Failure	Go to "Wire Fault, Auto-Removal, or Open Errors (Function Failure)" on page 3-125
2 — Signal Loss	Go to "Open Errors, Part 2 — Signal Loss" on page 3-44
3 or 4 — Miscellaneous	Go to "Open Errors, Part 2 — Signal Loss" on page 3-44
5 — Time Out	Go to "Open Errors, Part 3 — Time-Out" on page 3-45
6 — Ring Failure	Go to "Open Errors, Part 4 — Ring Failure or Beaconsing" on page 3-46
7 — Ring Beaconsing	Go to "Open Errors, Part 4 — Ring Failure or Beaconsing" on page 3-46
8 — Duplicate Address	Go to "Open Errors, Part 5 — Duplicate Address" on page 3-47
9 through F — Miscellaneous	Go to "Open Errors, Part 2 — Signal Loss" on page 3-44

## Open Errors, Part 2 — Signal Loss

1. Determine if there are other devices attached and operating on the ring.
  - a. If there are other devices already operating without errors on the ring, there is a problem on this device's lobe. Disconnect the lobe, then go to "Lobe Logic Isolation (Beaconing and Open Errors)" on page 3-134.

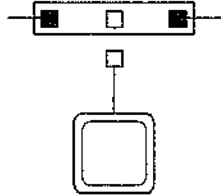

- b. Otherwise, continue with step 2.
2. Start your diagnostic tool on a device other than the one indicating the error.
  - a. If the network diagnostic tool indicates a ring status of "Normal," the device with the error or its lobe is defective. Disconnect the lobe from the IBM 8228, then go to "Lobe Logic Isolation (Beaconing and Open Errors)" on page 3-134.

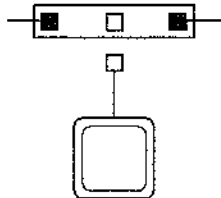

- b. Otherwise, there is a problem with the ring. Go to "Starting the Problem Determination Procedures" on page 3-5 and use the symptom provided by the network diagnostic tool.

---

## Open Errors, Part 3 — Time-Out

1. The problem may be caused by congestion on the ring. Wait 2 or 3 minutes and then try to restart the program on the same device again.
  - a. If the device still indicates an error, go to step 2.
  - b. Otherwise, the problem appears to have disappeared. No further action is required.
2. Attempt to start a network application on another device on the ring.
  - a. If the second device indicates the same error, there is a problem on the ring. Go to "Manual Procedure, Part 1" on page 3-59.
  - b. Otherwise, there is an adapter, lobe, or lobe logic problem on the device that originally reported the open error. Disconnect that device's lobe cable from the IBM 8228, then go to "Lobe Logic Isolation (Beaconing and Open Errors)" on page 3-134.

---

## Open Errors, Part 4 — Ring Failure or Beaconing

1. A condition exists that is causing or would cause beaconing if this adapter is inserted into the ring.

Using another device on the ring, determine if the ring is operational.

- a. If the ring is operational, go to step 3.
  - b. Otherwise, continue with step 2.
2. Select a device to use as an observer terminal. At the observer terminal, start your diagnostic program and determine ring status.
    - a. If the observer terminal indicates an open error with a reason code of 6 or 7, go to "Manual Procedure, Part 1" on page 3-59.
    - b. Otherwise, using the symptom indicated by the observer terminal, go to "Starting the Problem Determination Procedures" on page 3-5 and restart the problem determination procedures.
  3. One possible cause of this error is a mismatch between the ring data rate and the adapter data rate. Verify that the rates are the same.
    - a. If the data rates do not match, go to step 4.
    - b. Otherwise, disconnect the lobe cable of the device with the original error and go to "Lobe Logic Isolation (Beaconing and Open Errors)" on page 3-134.
  4. Correct the data rate mismatch and retry the operation that failed.
    - a. If the error occurs again, disconnect the lobe cable and go to "Lobe Logic Isolation (Beaconing and Open Errors)" on page 3-134.
    - b. Otherwise, the problem is resolved.

## Open Errors, Part 5 — Duplicate Address

1. Determine adapter type.
  - a. If the adapter indicates the open error is an IBM 8220 optical fiber subsystem, go to “Duplicate Address on an IBM 8220” on page 3-121.

**Note:** An IBM 8220 optical fiber subsystem is a segment of the main ring path containing only optical fiber cabling with a converter at each end.
  - b. Otherwise, continue with step 2.
2. Make sure you have recorded the 12-digit hexadecimal adapter address of the adapter in this device.

```
                                RING DIAGNOSTIC
02/20/86 13:06:28 DF1PD040E Ring initialization failed
-----> 0005A000147 000000A33802C 000000A33826C 000000A33826C
02/20/86 13:10:06 DF1PD211E Unable to open ring adapter
-----> 00070009
02/20/86 13:07:10 DF1PD049I Ring diagnostic ended

F1=Help      2=Print      3=End      4=      5=
F6=Ring test 7=Full E.R.  8=Limited E.R. 9=Reset Counts 10=Pause
```

Compare this address with all other addresses recorded on the Adapter Address to Physical Location Locator Chart for this ring.

**Note:** If the locally administered addresses for the devices on this ring are not recorded on the Adapter Address to Physical Location Locator Chart, also determine the locally administered addresses and compare them to the adapter address for this device.

- a. If the adapter address for this device is being used by another device, continue with step 3.
  - b. Otherwise, go to step 4.
3. Determine the type of addressing being used.
    - a. If you are using locally administered addressing on this ring, follow the instructions in the adapter operator's guide to assign a new address to this adapter/device.
    - b. Otherwise, you have two adapters with the same universally administered address. Return one of the adapters to the supplier from which it was obtained.

4. Find the adapter address for this device on the Adapter Address to Physical Location Locator Chart.

Compare the adapter address provided by the device in the error message with the adapter address recorded on the chart.

- a. If the addresses are the same, there is a device on this ring that is recognizing the address of the device reporting the duplicate address. Continue with step 5.
  - b. Otherwise, the adapter in the device indicating the error is defective. Follow local procedures to have the device that reported the duplicate address serviced.
5. Select a device, other than the one reporting the duplicate address, that is running on the ring.
    - a. Remove the selected device from the ring.
    - b. Restart the application on the device that reported the duplicate address.
      - 1) If the duplicate address still occurs, continue with step 6.
      - 2) Otherwise, the adapter in the device just removed from the ring is defective. Follow local procedures to have the device serviced.
  6. Return the removed device to the ring by restarting the network application on that device.
    - a. If there are more devices on the ring that have not been removed from the ring yet, return to step 5.
    - b. Otherwise, the device that reported the original duplicate addressing error is defective. Follow local procedures to have the device serviced.

## Open Errors, Part 1, for Remote Program Load

**Note:** These procedures may require that you find a certain device or component. See Appendix A for instructions.

Record the adapter address and determine the reason code from the Remote Program Load device's screen. Locate last digit of the reason code in the chart below and proceed to the indicated procedure.

Last Digit of Reason Code	Action to Take
1 - Function Failure	Go to "Wire Fault, Auto Removal, or Open Error (Function Failure) for Remote Program Load" on page 3-126
2 - Signal Loss	Go to "Open Errors, Part 2, for Remote Program Load" on page 3-50
3 or 4 - Miscellaneous	Go to "Open Errors, Part 2, for Remote Program Load" on page 3-50
5 - Time Out	Go to "Open Errors, Part 3, for Remote Program Load" on page 3-51
6 - Ring Failure	Go to "Open Errors, Part 4, for Remote Program Load" on page 3-52
7 - Ring Beaconing	Go to "Open Errors, Part 4, for Remote Program Load" on page 3-52
8 - Duplicate Address	Go to "Open Errors, Part 5, for Remote Program Load" on page 3-53
D - First Device on Ring	Go to "Open Errors, Part 6, for Remote Program Load" on page 3-55
E - Adapter Data Rate May Be Different from Ring Data Rate	Go to "Open Errors, Part 7, for Remote Program Load" on page 3-56
All Others	Go to "Open Errors, Part 2, for Remote Program Load" on page 3-50



---

## Open Errors, Part 2, for Remote Program Load

For Signal Loss or Miscellaneous Open Errors:

1. Determine if there are other devices attached and operating on the ring.
  - a. If there are other devices already operating on the ring, there is a problem on this device, its lobe, or its lobe logic. Disconnect the lobe, then go to "Lobe Logic Isolation (Beaconing and Open Errors) for Remote Program Load" on page 3-136.
  - b. Otherwise, continue with step 2.
2. Restart another device on the ring with Remote Program Load.
  - a. If that device also indicates an open error, then the ring has a problem, go to "Manual Procedure, Part 1, for Remote Program Load" on page 3-89.
  - b. Otherwise, the original device with the open error or its lobe is defective. Disconnect its lobe cable from the IBM 8228, then go to "Lobe Logic Isolation (Beaconing and Open Errors) for Remote Program Load" on page 3-136.

---

## Open Errors, Part 3, for Remote Program Load

For Time Out Errors:

1. The problem may be caused by congestion on the ring. Wait 2 or 3 minutes and then try to start the device again.
  - a. If the same error is indicated, continue with step 2.
  - b. Otherwise, the problem appears to have disappeared. No further action is required.

**Note:** Repeated occurrences may require re-planning the ring using the *IBM Token-Ring Network Introduction and Planning Guide*.

2. Attempt to start another device on the ring.
  - a. If the second device indicates the same error, there is a problem on the ring. Go to "Manual Procedure, Part 1, for Remote Program Load" on page 3-89.
  - b. Otherwise, there is an adapter, lobe, or lobe logic problem on the device that originally reported the open error. Disconnect the lobe, then go to "Lobe Logic Isolation (Beaconing and Open Errors) for Remote Program Load" on page 3-136.

---

## Open Errors, Part 4, for Remote Program Load

1. A condition exists that is causing or would cause beaconing if this adapter inserted into the ring.

Using another device on the ring, determine if the ring is operational.

- a. If the ring is operational, go to step 4.
  - b. Otherwise, continue with step 2.
2. Select a device to use as an observer terminal.
    - a. If the only device capable of executing your diagnostic program is the device with the error, use that device as your observer terminal and go to step 3.
    - b. Otherwise, select any device capable of executing your diagnostic program and continue with step 3.
  3. At the observer terminal, start your diagnostic program and determine ring status.
    - a. If the observer terminal indicates an open error with a reason code of 6 or 7, go to "Manual Procedure, Part 1" on page 3-59.
    - b. Otherwise, using the symptom indicated by the observer terminal, go to "Starting the Problem Determination Procedures" on page 3-5 and restart the problem determination procedures.
  4. One possible cause of this error is a mismatch between the ring data rate and the adapter data rate. Verify that the rates are the same.
    - a. If the data rates do not match, continue with step 5.
    - b. Otherwise, disconnect the lobe cable of the device with the original error and go to "Lobe Logic Isolation (Beaconing and Open Errors)" on page 3-134.
  5. Correct the data rate mismatch and retry the operation that failed.
    - a. If the error occurs again, disconnect the lobe cable and go to "Lobe Logic Isolation (Beaconing and Open Errors)" on page 3-134.
    - b. Otherwise, the problem is resolved.

---

## Open Errors, Part 5, for Remote Program Load

### 1. Determine adapter type.

- a. If the adapter indicating the open error is an IBM 8220 optical fiber subsystem, go to "Duplicate Address on an IBM 8220" on page 3-121.

**Note:** An IBM 8220 optical fiber subsystem is a segment of the main ring path consisting only of optical fiber cabling with a converter at each end.

- b. Otherwise, continue with step 2.

### 2. Duplicate Address.

Make sure you have recorded the 12-digit hexadecimal adapter address of the adapter in this device. Compare this address with all other addresses recorded on the Adapter Address to Physical Location Locator Chart for this ring.

**Note:** If the locally administered addresses for all other devices on this ring are not recorded on the Adapter Address to Physical Location Locator Chart, also compare the adapter address for this device with the locally administered address.

- a. If the adapter address for this device is being used by another device, continue with step 3.
- b. Otherwise, go to step 4.

### 3. Determine the type of addressing being used.

- a. If you are using locally administered addressing on this ring, follow the instructions in the adapter operator's guide to assign a new address to this adapter/device.
- b. Otherwise, you have two adapters with the same universally administered address. Return one of the adapters to the supplier from which it was obtained.

### 4. Find the adapter address for this device on the Adapter Address to Physical Location Locator Chart. Compare the adapter address provided by the device with the Open Error with the adapter address recorded on the chart.

- a. If the addresses are the same, there is a device on this ring that is recognizing the address of the device reporting the duplicate address. Continue with step 5.
- b. Otherwise, the adapter in the device with the Open Error is defective. Follow local procedures to have the adapter that reported the duplicate address serviced.

### 5. Select a device, other than the one reporting the duplicate address, that is running on the ring. Remove that device from the ring. Perform a Remote Program Load on the device that reported the duplicate address.

- a. If the duplicate address still occurs, continue with step 6.
- b. Otherwise, the adapter in the device just removed from the ring is defective. Follow local procedures to have the adapter serviced.

6. Return the removed device to the ring by performing a Remote Program Load.
  - a. If there are more devices on the ring that have not yet been removed from the ring, return to step 5.
  - b. Otherwise, the device that reported the original duplicate addressing error is defective. Follow local procedures to have the adapter serviced.

---

## Open Errors, Part 6, for Remote Program Load

1. The device with this error is trying to become the first active device on the ring.

Make sure the loading device has been started and is active on the ring.

Retry the device with the error.

- a. If the loading device is active on the ring and this device continue to get the same error, continue with step 2.
  - b. Otherwise, no further action is required.
2. Disconnect this device's lobe cable from the IBM 8228 receptacle.

Reconnect the cable to a different IBM 8228 receptacle.

Retry the device that previously had the error.

- a. If the device continues to get the same error, the adapter in this device is defective. Follow local procedure and replace the adapter.
- b. Otherwise, the IBM 8228 is defective. Go to "Replacing a Defective IBM 8228" on page 3-177.

---

## Open Errors, Part 7, for Remote Program Load

1. The adapter in the device with this error may be set to the wrong data rate.

Make sure the adapter data rate is set to match the ring data rate.

Retry the device with the error.

- a. If this device continues to get the same error, go to "Open Errors, Part 4, for Remote Program Load" on page 3-52.
- b. Otherwise, no further action is required.

## Only Adapter on the Ring

**Note:** These procedures may require that you find a certain device or component. See Appendix A for instructions.

1. You are here because a device on the ring indicates that it is the only adapter on the ring.
  - a. If this device has the Remote Program Load feature installed, go to "Only Adapter on the Ring for Remote Program Load" on page 3-58.
  - b. Otherwise continue with step 2.
2. Determine if there were any other devices active on the ring when the device on this lobe was trying to insert into the ring. ("Active on the ring" means that a device's adapter was inserted into the ring and an application program was running on that device. The application program may or may not still be running at this time. It may be indicating an error at this time.)
  - a. If other devices were active, continue with step 3.
  - b. Otherwise, it is normal for an adapter to indicate "Only Adapter on the Ring" when it is the only active adapter on the ring. No further action is required.
3. Disconnect the lobe cable of the device with the indication of "Only Adapter on the Ring" from the IBM 8228 and reconnect it to a different receptacle of the IBM 8228.

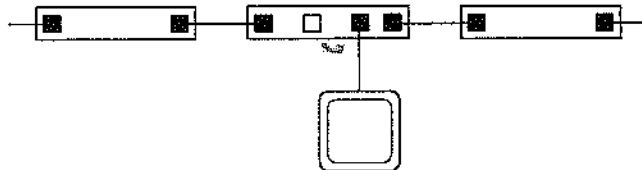

Restart the program that indicated the message before.

- a. If the same device now indicates that it is the only adapter on the ring, the adapter in that device is defective. Follow local procedure and have the device serviced.
- b. Otherwise, the IBM 8228 is defective. Bypass it and go to "Replacing a Defective IBM 8228" on page 3-177.



## Only Adapter on the Ring for Remote Program Load

**Note:** These procedures may require that you find a certain device or component. See Appendix A for instructions.

1. Determine if there were any other devices active on the ring when the device on this lobe was trying to insert into the ring. ("Active on the ring" means that a device's adapter was inserted into the ring and an application program was running on that device. The application program may or may not still be running at this time. It may be indicating an error at this time.)
  - a. If other devices were active, continue with step 2.
  - b. Otherwise, it is normal for an adapter to indicate "Only Adapter on the Ring" when it is the only active adapter on the ring. No further action is required.
2. Disconnect the lobe cable of the device with the indication of "Only Adapter on the Ring" from the IBM 8228 and reconnect it to a different receptacle of the IBM 8228.

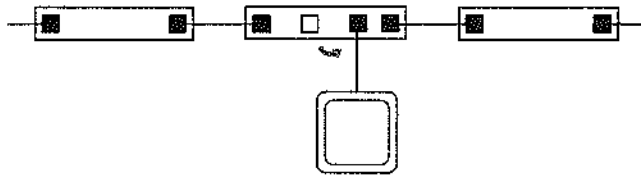

Restart the device that indicated "Only Adapter on the Ring" before.

- a. If the device now indicates that it is the only adapter on the ring, the adapter in this device is defective. Follow local procedure and have the device serviced.
- b. Otherwise, the IBM 8228 is defective. Bypass it and go to "Replacing a Defective IBM 8228" on page 3-177.

## Manual Procedure, Part 1

1. You are in this procedure for one of two reasons:
  - 1) Because the other procedures in this manual were unable to locate the problem or
  - 2) Because network diagnostic tools (IBM Token-Ring Network Ring Diagnostics, IBM Token-Ring Network Manager, or other program) are not available.

If you are here because a network diagnostic tool is not available and your application programs do not provide an indication when soft errors are occurring, this procedure may not locate the problem. In such a situation, you may have to obtain a program (one of the ones listed above or any other available program) that will provide indications of excessive soft errors in order to locate the source of the problem(s) on the ring.

If you were sent to this procedure because the other procedures were unable to locate the problem, and you have the IBM Token-Ring Network Diagnostics, Network Manager, or Bridge program, you should use that program to determine ring status. However, you may also want to start a network application program on the indicated devices to ensure that cables are reconnected correctly as you progress through this procedure. Any previously defined fault domain is no longer to be used or considered.

The Ring Diagnostic, Network Manager, or other program that will provide an indication of ring status is referred to as the "network diagnostic tool(s)" in these procedures.

Select any device capable of running your network diagnostic tool to use as the observer terminal.

- a. If Remote Program Load is installed in devices on this ring, go to "Manual Procedure, Part 1, for Remote Program Load" on page 3-89.
  - b. Otherwise, continue with step 2.
2. Determine ring configuration.
    - a. If all of the IBM 8228s in this ring are located within a single wiring closet, continue with step 3.
    - b. Otherwise go to "Manual Procedure, Part 2" on page 3-62.
  3. Create a "test ring" by disconnecting the cables from the RI and RO receptacles of the observer terminal's IBM 8228. Start your network diagnostic tool on the observer terminal.

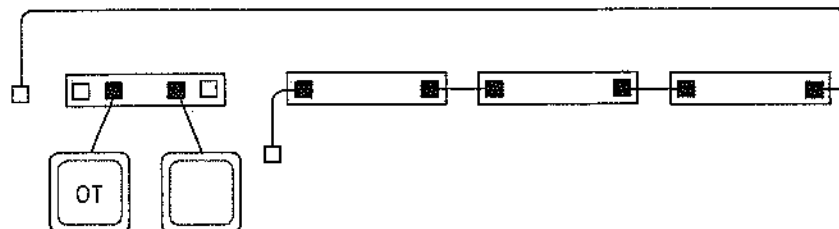

- a. If the observer terminal indicates a ring status of "Normal," reconnect the cable to the RO receptacle of the observer terminal's IBM 8228, then continue with step 4.

- b. Otherwise, the disconnected IBM 8228 or one of the lobes or devices connected to it may be defective.
  - 1) Bypass it.
  - 2) Go to "Isolation of an IBM 8228" on page 3-127.
4. Add another IBM 8228 to the "test ring" by disconnecting the cable from the RO receptacle of the next downstream IBM 8228.

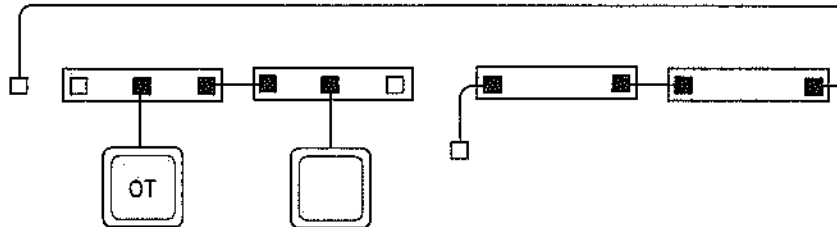

- a. If the observer terminal indicates a ring status of "Normal," reconnect the cable to the RO receptacle of the IBM 8228, then continue with step 5.
- b. Otherwise, go to step 9.
5. Check for more IBM 8228s.
  - a. If the observer terminal is connected to the next downstream IBM 8228, continue with step 6.
  - b. Otherwise return to step 4.
6. Reconnect the cable to the RI receptacle of the observer terminal's IBM 8228.
  - a. If the observer terminal indicates a ring status of "Normal," the problem has disappeared.
    - 1) Recovery and isolation are complete.
    - 2) No further action is required.
  - b. Otherwise, continue with step 7.
7. Check for IBM 8218s.
  - a. If the cable that is connected to the RI receptacle of the observer terminal's IBM 8228 is also connected to a IBM 8218 (or a white filter cable that connects to a IBM 8218), disconnect the cable from the RI receptacle of the observer terminal's IBM 8228. Then, go to "Manual Procedure, Part 6" on page 3-83.
  - b. Otherwise, continue with step 8.
8. Temporarily replace the patch cable connected to the RI of the observer terminal's IBM 8228.
  - a. If the observer terminal indicates a ring status of "Normal," the cable just replaced is defective.
    - 1) Obtain a new cable for future use.
    - 2) No further action is required.
  - b. Otherwise:
    - 1) Disconnect the spare cable and reconnect the original cable.
    - 2) This procedure has failed to locate the problem. Notify the network administrator and/or go to "Diagnosing Difficult Ring Problems" on page 3-166 to continue.

9. Disconnect the cable from the RI receptacle of the last IBM 8228 added to the "test ring".

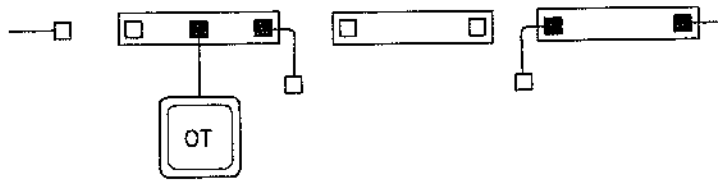

- a. If the observer terminal indicates a ring status of "Normal," the last IBM 8228 added to the "test ring" may be defective.
- 1) Bypass the IBM 8228.

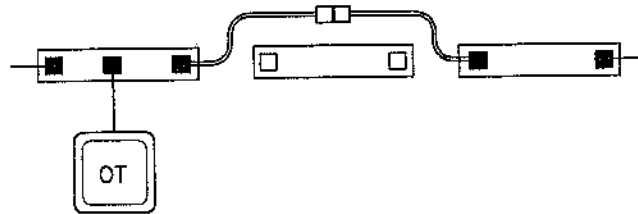

- 2) Reconnect all other cables.
  - 3) Go to "Isolation of an IBM 8228" on page 3-127 to continue.
- b. Otherwise, continue with step 10.
10. Check for IBM 8218s.

- a. If the cable that connects to the RI receptacle of the last IBM 8228 added to the "test ring" also connects to a IBM 8218 (or a white filter cable that connects to a 8218), go to "Manual Procedure, Part 6" on page 3-83.

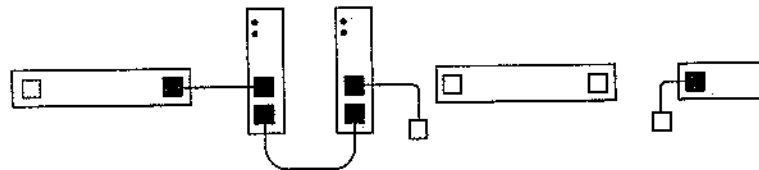

- b. Otherwise, continue with step 11.
11. Temporarily replace the patch cable that was connected to the RI of the last IBM 8228 added to the "test ring."
- a. If the observer terminal indicates a ring status of "Normal," the cable just replaced is defective.
- 1) Obtain a new cable for future use.
  - 2) Reconnect the cable to the RO of the last IBM 8228 added to the "test ring."
  - 3) Reconnect the cable to the RI receptacle of the observer terminal's IBM 8228.
  - 4) Go to "Manual Procedure, Part 7" on page 3-88.
- b. Otherwise:
- 1) Disconnect the spare patch cable and reconnect the original cable.
  - 2) Reconnect any cables that have not been reconnected.
  - 3) This procedure has failed to locate the problem. Notify the network administrator and/or go to "Diagnosing Difficult Ring Problems" on page 3-166 to continue.

## Manual Procedure, Part 2

1. Go to the wiring closet that contains the observer terminal's IBM 8228. Create a "test ring" by following the instructions below. Find the end of the copper patch cable that is connected to the RI receptacle of the first IBM 8228 in this wiring closet.
  - a. If the other end of the copper patch cable is connected to an IBM 8219 (or to a filter cable that connects to the IBM 8219), disconnect the copper patch cable or filter cable from the data receptacle of the IBM 8219. Continue with step 2.

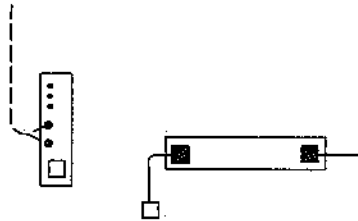

- b. If the other end of the copper patch cable is connected to an IBM 8218 (or to a filter cable that connects to the IBM 8218), disconnect the copper patch cable or filter cable that connects the first IBM 8218 to the distribution panel from the distribution panel. Then continue with step 2.

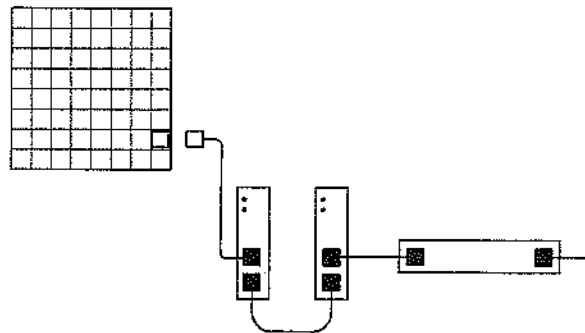

- c. If the other end of the copper patch cable is connected to an IBM 8220, disconnect the copper patch cable from the data receptacle of the IBM 8220. Continue with step 2.

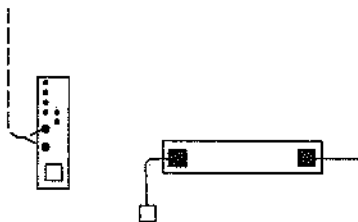

- d. Otherwise, disconnect the cable that connects the first IBM 8228 to the distribution panel from the distribution panel. Then continue with step 2.

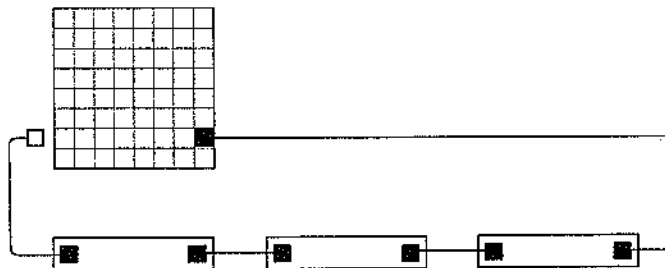

- 2. Find the other end of the cable that is connected to the RO receptacle of the last IBM 8228 in this wiring closet.
  - a. If the other end of the copper patch cable is connected to an IBM 8219 (or to a filter cable that connects to the IBM 8219), disconnect the copper patch cable or filter cable from the IBM 8219. Continue with step 3.

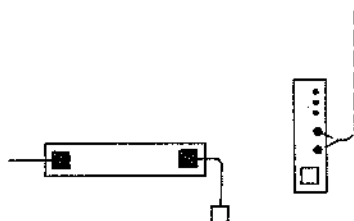

- b. If the other end of the copper patch cable is connected to an IBM 8218 (or to a filter cable that connects to the IBM 8218), disconnect the copper patch cable or filter cable that connects the last IBM 8218 to the distribution panel. Continue with step 3.

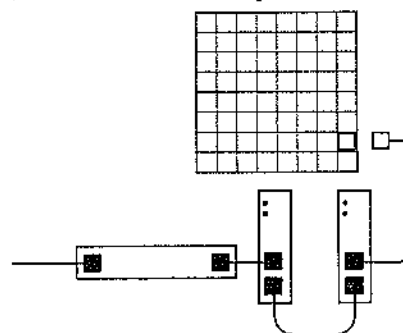

- c. If the other end of the copper patch cable is connected to an IBM 8220, disconnect the copper patch cable from the data receptacle of the IBM 8220. Continue with step 3.

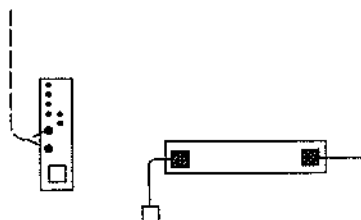

- d. Otherwise, disconnect the cable that connects the last IBM 8228 to the distribution panel from the distribution panel. Continue with step 3.

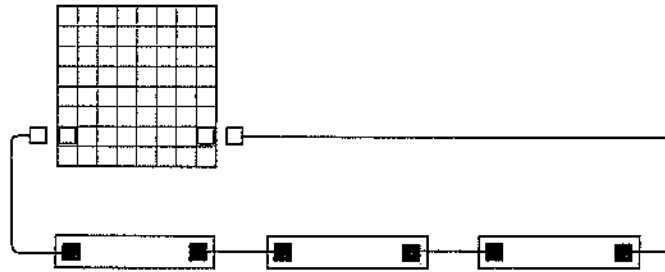

3. Start your network diagnostic tool on the observer terminal.
  - a. If the observer terminal indicates a ring status of "Normal," reconnect the cable from the last IBM 8228 or IBM 8218 in this wiring closet to the distribution panel or reconnect the copper patch cable or filter cable to the last IBM 8219 or IBM 8220 in the wiring closet. Then continue with step 4.
  - b. Otherwise, there is a problem in this wiring closet. Go to "Manual Procedure, Part 4" on page 3-70.
4. Go to the next downstream wiring closet and add it to the "test ring" by finding the other end of the copper patch cable that is connected to the RO receptacle of the last IBM 8228 in this wiring closet.
  - a. If the other end of the copper patch cable is connected to an IBM 8219 (or to a filter cable that connects to the IBM 8219), disconnect the copper patch cable or filter cable from the IBM 8219. Continue with step 5.

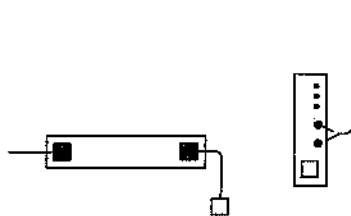

- b. If the other end of the copper patch cable is connected to an IBM 8218 (or to a filter cable that connects to the IBM 8218), disconnect the copper patch cable or filter cable that connects the last IBM 8218 to the distribution panel from the distribution panel. Continue with step 5.

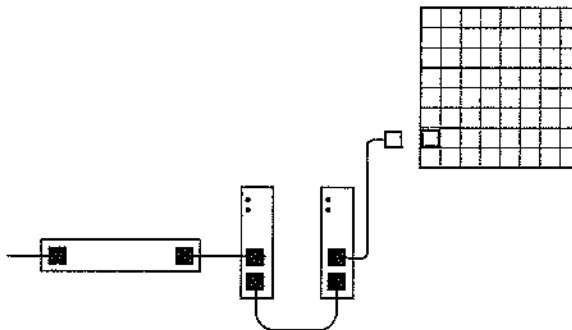

- c. If the other end of the copper patch cable is connected to an IBM 8220, disconnect the copper patch cable from the data receptacle of the IBM 8220. Continue with step 5.

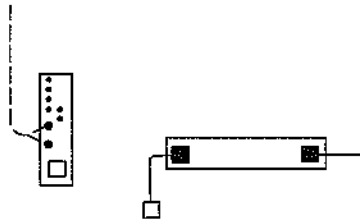

- d. Otherwise, disconnect the copper patch cable or filter cable that connects the last IBM 8228 to the distribution panel from the distribution panel. Continue with step 5.

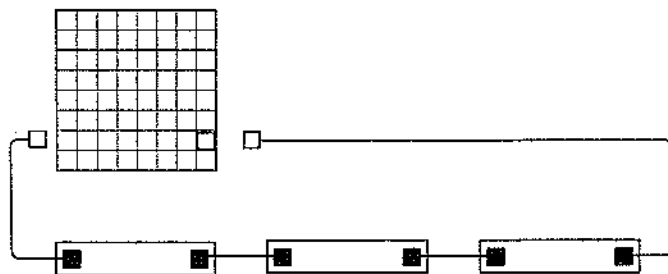

5. Determine status of the "test ring".

- a. If the observer terminal indicates a ring status of "Normal," reconnect the cable from the last 8228 or IBM 8218 in this wiring closet to the distribution panel or reconnect the cable or filter to the last IBM 8219 or IBM 8220 in the wiring closet. Continue with step 6.
- b. Otherwise, there is a problem in the wiring closet or between this wiring closet and the previous upstream wiring closet. Go to "Manual Procedure, Part 3" on page 3-67.

6. Checking for more wiring closets.

- a. If the observer terminal's IBM 8228 is located in the next downstream wiring closet, continue with step 7.
- b. Otherwise, return to step 4 to test the next wiring closet.

7. Return to the observer terminal's wiring closet. Reconnect the cable from the first 8228 or IBM 8218 in this wiring closet to the distribution panel or reconnect the copper patch cable or filter cable to the first IBM 8219 or IBM 8220 in the wiring closet.

- a. If the observer terminal indicates a ring status of "Normal," the problem has disappeared. No further action required.
- b. Otherwise, the segment between the observer terminal's wiring closet and the next upstream wiring closet is defective. Continue with step 8.



8. Find the other end of the copper patch cable that is connected to the RI receptacle of the first IBM 8228 in this wiring closet.
  - a. If the other end of the copper patch cable is connected to an IBM 8219 (or to a filter cable that connects to an IBM 8219):

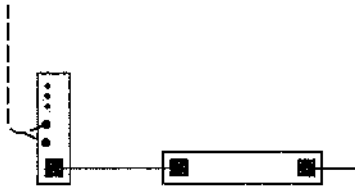

- 1) Disconnect the copper patch cable from the data receptacle of the IBM 8219.
- 2) Go to the wiring closet immediately upstream of the defective segment.
- 3) Disconnect the copper patch cable from the data receptacle of the last IBM 8219 in that wiring closet.

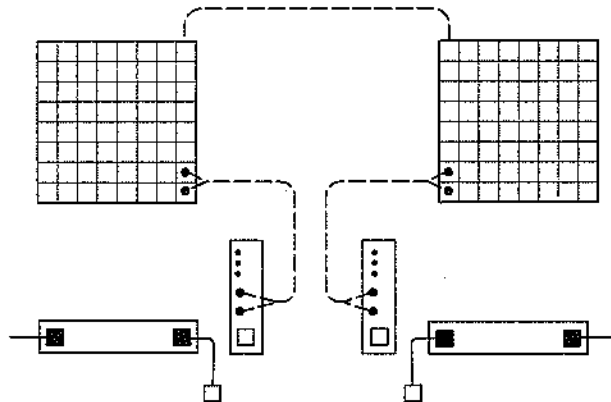

- 4) Then go to "Isolation of an Optical Fiber Ring Segment, Part 1" on page 3-156.
- b. If the other end of the copper patch cable is connected to an IBM 8220:
    - 1) Disconnect the copper patch cable from the data receptacle of the IBM 8220.
    - 2) Go to the wiring closet immediately upstream of the defective segment.
    - 3) Disconnect the cable from the data receptacle of the last IBM 8220 in that wiring closet.
    - 4) Go to "Isolation of an IBM 8220 Optical Fiber Subsystem" on page 3-115.
  - c. Otherwise, do the following:
    - 1) Disconnect the cable from the first IBM 8228 or IBM 8218 in this wiring closet going to the Distribution Panel from the Distribution Panel.
    - 2) Go to "Manual Procedure, Part 5" on page 3-78.

## Manual Procedure, Part 3

1. Find the other end of the copper patch cable that is connected to the RI receptacle of the first IBM 8228 in this wiring closet.
  - a. If the other end of the cable is connected to an IBM 8219 (or to a filter cable that connects to the IBM 8219), disconnect the copper patch cable or filter cable from the IBM 8219. Continue with step 2.

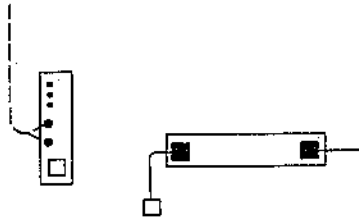

- b. If the other end of the copper patch cable is connected to an IBM 8218 (or to a filter cable that connects to the IBM 8218), disconnect the copper patch or filter cable that connects the first IBM 8218 to the distribution panel. Continue with step 2.

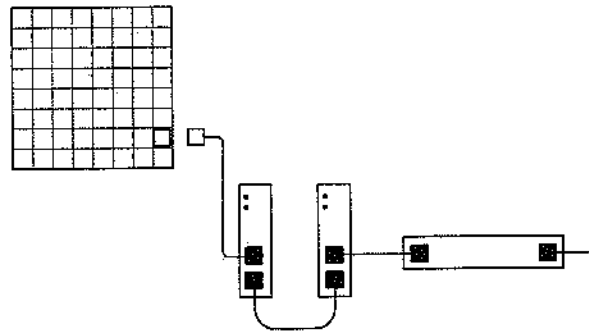

- c. If the other end of the copper patch cable is connected to an IBM 8220, disconnect the copper patch cable from the data receptacle of the IBM 8220. Then-continue with step 2.

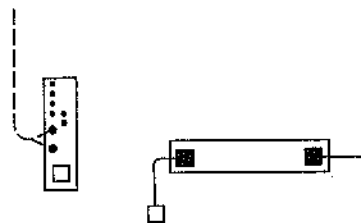

- d. Otherwise, disconnect the cable that connects the first IBM 8228 to the distribution panel from the distribution panel. Continue with step 2.

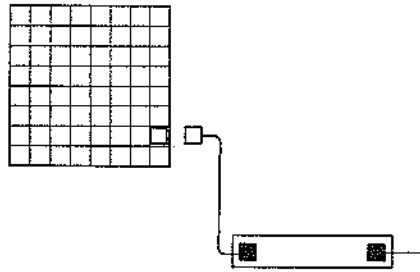

2. Select a device in this wiring closet to use as the observer terminal. Start your network diagnostic tool on the new observer terminal.
  - a. If the new observer terminal indicates a ring status of "Normal," reconnect the cable from the last IBM 8228 or IBM 8218 in this wiring closet to the distribution panel or reconnect the copper patch cable or filter cable to the last IBM 8219 or IBM 8220 in the wiring closet. Then continue with step 3.
  - b. Otherwise, there is a problem in this wiring closet. Go to "Manual Procedure, Part 4" on page 3-70.
3. The segment between this wiring closet and the next upstream wiring closet is defective. Find the other end of the copper patch cable that is connected to the RI receptacle of the first IBM 8228 in this wiring closet.

- a. If the other end of the copper patch cable was connected to an IBM 8219 (or to a filter cable that connects to the IBM 8219), return to the wiring closet that is immediately upstream of the defective segment.
  - 1) Find the other end of the copper patch cable that is connected to the RO receptacle of the last IBM 8228 in that wiring closet.
  - 2) Disconnect the copper patch cable or filter cable from the data receptacle of the last IBM 8219 in that wiring closet.

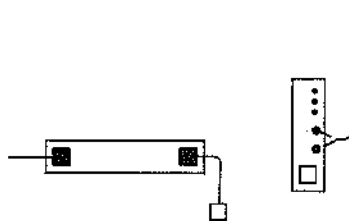

- 3) Return to the observer terminal's wiring closet and reconnect the cable that is connected to the first IBM 8228.
- 4) Then go to "Isolation of an Optical Fiber Ring Segment, Part 1" on page 3-156.
- b. If the other end of the copper patch cable is connected to an IBM 8220:
  - 1) Go to the wiring closet immediately upstream of the defective segment.
  - 2) Disconnect the cable from the data receptacle of the last IBM 8220 in that wiring closet.
  - 3) Return to the observer terminal's wiring closet and reconnect all cables that were left disconnected in that wiring closet.

- 4) Go to "Isolation of an IBM 8220 Optical Fiber Subsystem" on page 3-115.
- 5) Otherwise, at the distribution panel, reconnect the cable that is connected to the last IBM 8228 or IBM 8218 in this wiring closet, then go to "Manual Procedure, Part 5" on page 3-78.

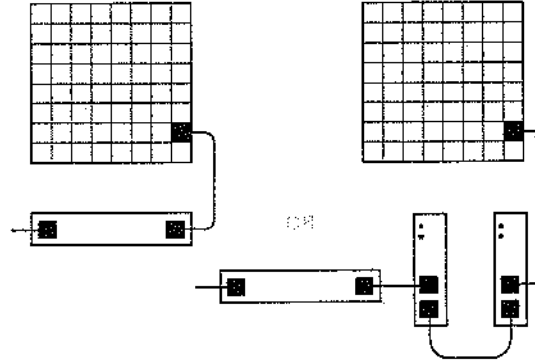

## Manual Procedure, Part 4

1. There is a problem in this wiring closet. Create a new "test ring" by disconnecting the cables from the RI and RO receptacles of the observer terminal's IBM 8228. Start your diagnostic tool on the observer terminal.

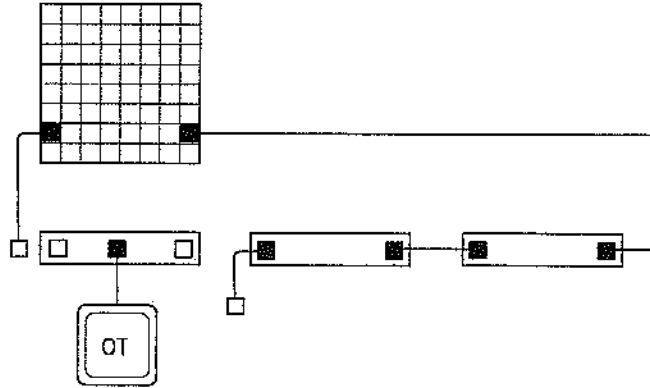

- a. If the observer terminal indicates a ring status of "Normal," reconnect the cable to the RI receptacle of the IBM 8228 then continue with step 2.
- b. Otherwise, the disconnected IBM 8228 or one of the lobes or devices connected to it may be defective.

- 1) Bypass the IBM 8228.

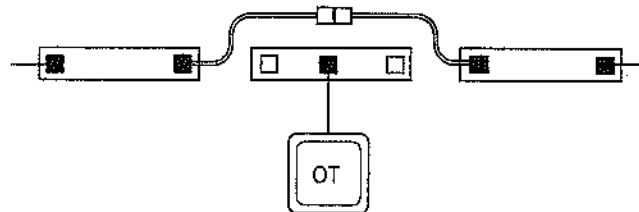

- 2) Reconnect all other cables, including those in other wiring closets, that have not been reconnected.
- 3) Go to "Isolation of an IBM 8228" on page 3-127.

2. Check for upstream IBM 8228s.

- a. If there is an IBM 8228 in this wiring closet that is upstream of the observer terminal, continue with step 3.

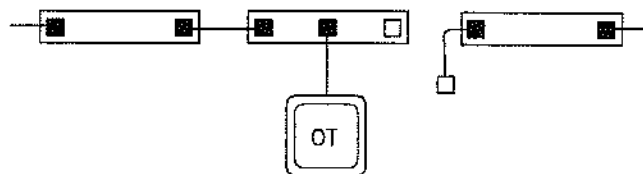

- b. Otherwise, go to step 5.

3. Add another IBM 8228 to the "test ring" by disconnecting the cable from the RI receptacle of the next upstream IBM 8228.

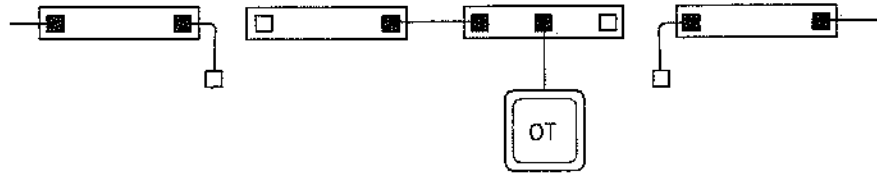

- a. If the observer terminal indicates a ring status of "Normal," reconnect the cable to the RI receptacle of the IBM 8228, then continue with step 4.
  - b. Otherwise, go to step 10.
4. Check for upstream IBM 8228s.
    - a. If there is another IBM 8228 in this wiring closet that is upstream of the observer terminal, then return to step 3 to test the next IBM 8228.
    - b. Otherwise, continue with step 5.
  5. Determine ring status:
    - a. If the observer terminal indicates a ring status of "Normal," continue with step 6.
    - b. Otherwise, the ring segment connected to the RI receptacle of the first IBM 8228 in this wiring closet may be defective. Go to step 12.
  6. Reconnect the cable to the RO receptacle of the observer terminal's IBM 8228.
    - a. If there is an IBM 8228 in this wiring closet that is downstream of the observer terminal, continue with step 7.
    - b. Otherwise, go to step 9.
  7. Add another IBM 8228 to the "test ring" by disconnecting the cable from the RO receptacle of the next downstream IBM 8228.

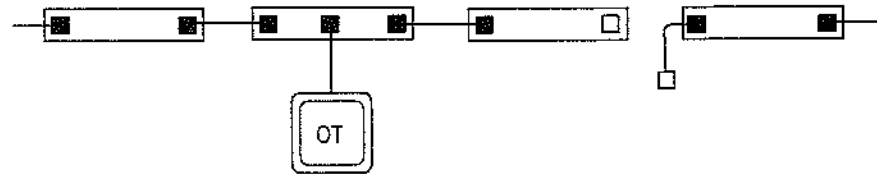

- a. If the observer terminal indicates a ring status of "Normal," reconnect the cable to the RO receptacle of the IBM 8228, then continue with step 8.
  - b. Otherwise, go to step 11.
8. Check for downstream IBM 8228s.
    - a. If there is another IBM 8228 in this wiring closet that is downstream of the observer terminal, return to step 7 to test the next IBM 8228.
    - b. Otherwise, continue with step 9.

9. Determine ring status.

- a. If the observer terminal indicates a ring status of "Normal," this problem has disappeared.
  - 1) Reconnect all cables, including those in other wiring closets.
  - 2) Go to "Manual Procedure, Part 7" on page 3-88.
- b. Otherwise, the ring segment connected to the RO receptacle of the last IBM 8228 in this wiring closet may be defective. Go to step 12.

10. Disconnect the cable from the RO receptacle of the IBM 8228 just added to the "test ring".

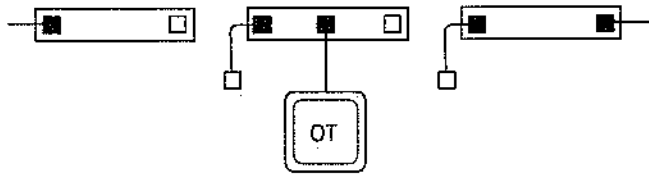

- a. If the observer terminal indicates a ring status of "Normal," the last IBM 8228 (now disconnected) or one of the lobes or devices connected to it may be defective.
  - 1) Bypass the IBM 8228.

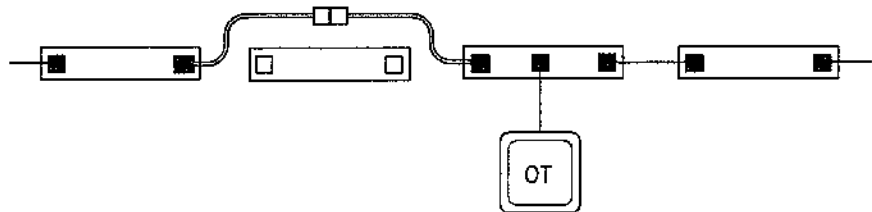

- 2) Reconnect all other cables, including those in other wiring closets, that have not been reconnected.
  - 3) Go to "Isolation of an IBM 8228" on page 3-127.
  - b. Otherwise, the ring segment just disconnected from the last IBM 8228 added to the "test ring" may be defective. Go to step 12.
11. Disconnect the cable from the RI receptacle of the IBM 8228 just added to the "test ring".

- a. If the observer terminal indicates a ring status of "Normal," the last added IBM 8228 (now disconnected) or one of the lobes or devices connected to it may be defective.
  - 1) Bypass the IBM 8228.

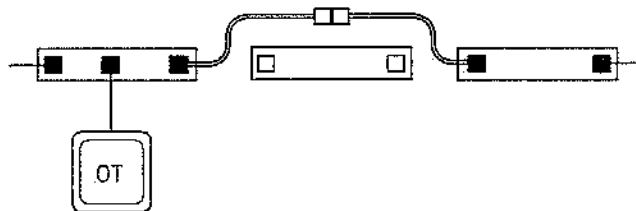

- 2) Reconnect all other cables, including those in other wiring closets, that have not been reconnected.
- 3) Go to "Isolation of an IBM 8228" on page 3-127.
- b. Otherwise, the ring segment just disconnected from the last IBM 8228 added to the "test ring" may be defective. Continue with step 12.

12. Check for IBM 8218s.

- a. If the defective ring segment contains a pair of IBM 8218s, go to step 14.

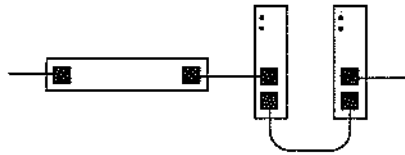

- b. Otherwise, continue with step 13.

13. Temporarily replace the patch cable that makes up the defective ring segment. One end of this cable has previously been disconnected. Do not reconnect this end.

- a. If the observer terminal indicates a ring status of "Normal," the patch cable just removed is defective.

- 1) Obtain a new cable for future use.
- 2) Reconnect any cables, including those in other wiring closets, that have not been reconnected.
- 3) Go to "Manual Procedure, Part 7" on page 3-88.

- b. Otherwise:

- 1) Disconnect the spare cable and reconnect the original cable.
- 2) Reconnect any cables, including those in other wiring closets, that have not been reconnected.
- 3) This procedure has failed to locate the problem. Notify the network administrator and/or go to "Diagnosing Difficult Ring Problems" on page 3-166 to continue.

14. Check power indicators on the IBM 8218s in the defective ring segment.

- a. If the Power On indicators on both IBM 8218s are lit, continue with step 15.

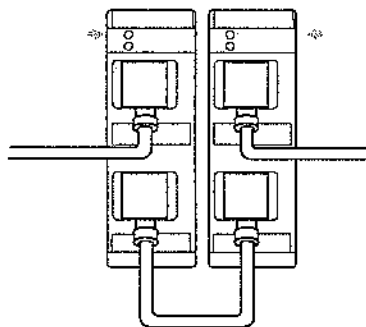

- b. Otherwise:

- 1) Reconnect any cables, including those in other wiring closets, that have not been reconnected.
- 2) Then go to "IBM 8218/8219/8220 Power Problems" on page 3-163.



15. Bypass the first IBM 8218 in the segment.

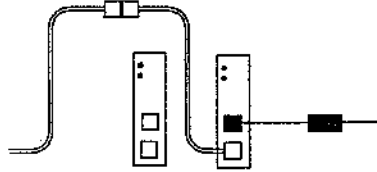

- a. If the observer terminal indicates a ring status of "Normal," the bypassed IBM 8218 is defective.
  - 1) Reconnect any cables, including those in other wiring closets, that have not been reconnected.
  - 2) Go to "Replacing a Defective IBM 8218" on page 3-178.
- b. Otherwise, reconnect the copper patch cables or filter cables to the first IBM 8218, then continue with step 16.

16. Bypass the second IBM 8218 in the segment.

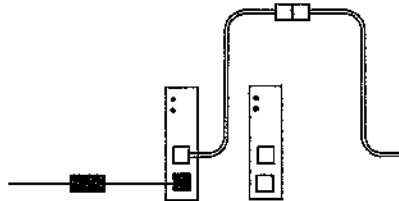

- a. If the observer terminal indicates a ring status of "Normal," the bypassed IBM 8218 is defective.
  - 1) Reconnect any cables that have not been reconnected.
  - 2) Go to "Replacing a Defective IBM 8218" on page 3-178.
- b. Otherwise, reconnect the copper patch cables or filter cables to the second IBM 8218, then continue with step 17.

17. Check for white DGM-to-Type 3 Filter cables.

- a. If there are white DGM-to-Type 3 Filter cables connected to the RI receptacles of the IBM 8218s, continue with step 18.

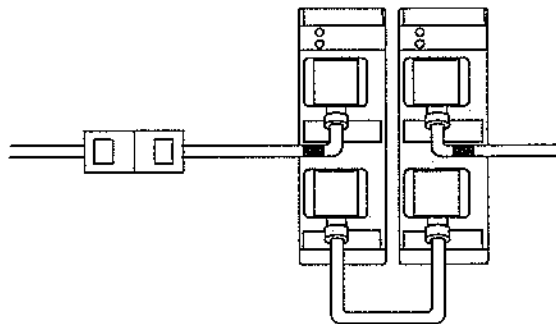

- b. Otherwise, go to step 20.

18. Temporarily replace the white filter cable connected to the RI of the first IBM 8218.
  - a. If the observer terminal indicates a ring status of "Normal," the white filter cable just removed is defective.
    - 1) Obtain a new white filter cable for future use.
    - 2) Reconnect any cables, including those in other wiring closets, that have not been reconnected.
    - 3) Go to "Manual Procedure, Part 7" on page 3-88.
  - b. Otherwise:
    - 1) Disconnect the spare white filter cable and reconnect the original white filter cable.
    - 2) Reconnect any cables, including those in other wiring closets, that have not been reconnected.
    - 3) Continue with step 19.
19. Temporarily replace the white filter cable connected to the RI of the second IBM 8218.
  - a. If the observer terminal indicates a ring status of "Normal," the white filter cable just removed is defective.
    - 1) Obtain a new filter cable for future use.
    - 2) Reconnect any cables, including those in other wiring closets, that have not been reconnected.
    - 3) Go to "Manual Procedure, Part 7" on page 3-88.
  - b. Otherwise:
    - 1) Disconnect the spare white filter cable and reconnect the original white filter cable.
    - 2) Continue with step 20.

20. Using a spare yellow crossover patch cable, temporarily replace the yellow crossover patch cable connected to the RO receptacles of the IBM 8218s.

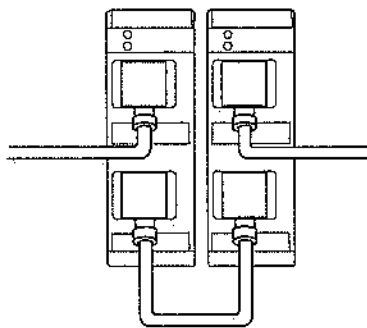

- a. If the observer terminal indicates a ring status of "Normal," the yellow crossover patch cable just removed is defective.
  - 1) Reconnect any cables, including those in other wiring closets, that have not been reconnected.
  - 2) Obtain a new yellow crossover patch cable for future use.
  - 3) Go to "Manual Procedure, Part 7" on page 3-88.

b. Otherwise:

- 1) Disconnect the spare yellow crossover patch cable and reconnect the original yellow crossover patch cable.
- 2) Continue with step 21.

21. Temporarily replace the copper patch cable that is connected to the RI of the first IBM 8218 or to the filter cable that is connected to the first IBM 8218.

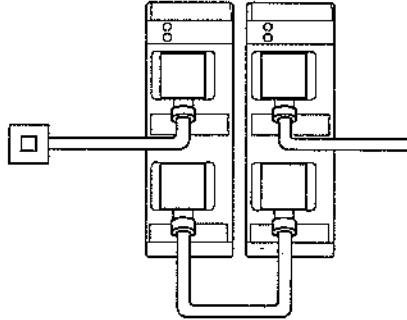

a. If the observer terminal indicates a ring status of "Normal," the copper patch cable just removed is defective.

- 1) Obtain a new copper patch cable for future use.
- 2) Reconnect any cables, including those in other wiring closets, that have not been reconnected.
- 3) Go to "Manual Procedure, Part 7" on page 3-88.

b. Otherwise:

- 1) Disconnect the spare copper patch cable and reconnect the original copper patch cable.
- 2) Continue with step 22.

22. Temporarily replace the yellow crossover patch cable that is connected to the RI of the second IBM 8218 or to the filter cable that is connected to the second IBM 8218.

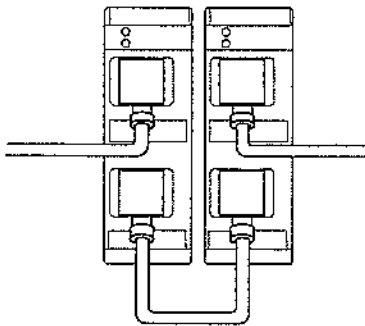

a. If the observer terminal indicates a ring status of "Normal," the yellow crossover patch cable just removed is defective.

- 1) Reconnect any cables, including those in other wiring closets, that have not been reconnected.
- 2) Obtain a new yellow crossover patch cable for future use.
- 3) Go to "Manual Procedure, Part 7" on page 3-88.

b. Otherwise:

- 1) Disconnect the spare yellow crossover patch cable and reconnect the original yellow crossover patch cable.
- 2) Reconnect any cables, including those in other wiring closets, that have not been reconnected.
- 3) This procedure has failed to locate the problem. Notify the network administrator and/or go to "Diagnosing Difficult Ring Problems" on page 3-166.

## Manual Procedure, Part 5

1. You are here because a segment between two wiring closets is defective. Using the Ring Sequence Chart, determine if there are any IBM 8218s in the defective ring segment.
  - a. If there are any IBM 8218s in the defective ring segment, go to the location of the first pair of IBM 8218s. Then continue with step 2.
  - b. Otherwise, disconnect the defective cable by disconnecting the patch cables from the distribution panel in the wiring closet at each end of the inter-wiring closet cable. Then go to "Testing Data Cables" on page 3-171.

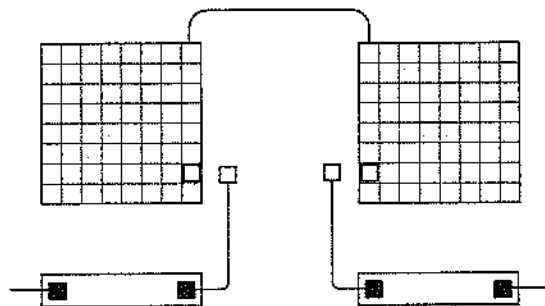

2. Disconnect the yellow crossover patch cable or filter cable from the RI receptacle of the second IBM 8218. Using the original observer terminal, determine ring status.

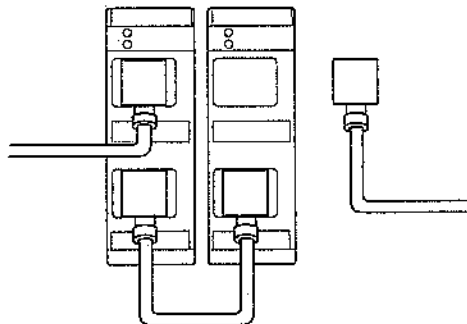

- a. If the observer terminal indicates a ring status of "Normal," continue with step 3.
  - b. Otherwise, go to step 8.
3. Reconnect the yellow crossover patch cable or filter cable to the RI of the second IBM 8218.
  - a. If the cable connected to the RI receptacle of the second IBM 8218 is a filter cable, then continue with step 4.
  - b. If the cable connected to the RI receptacle of the second IBM 8218 is a yellow crossover patch cable, then go to step 6.
  - c. Otherwise, go to step 7.

4. Disconnect the yellow crossover patch cable from the filter cable that is connected to the RI receptacle of the second IBM 8218.

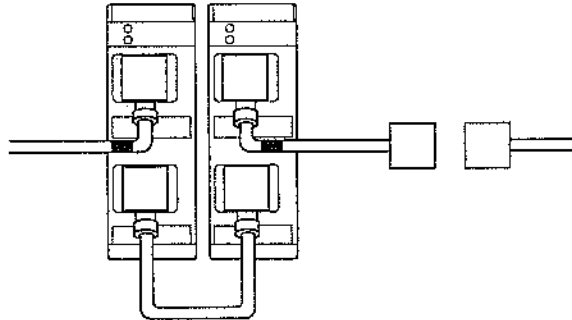

- a. If the observer terminal indicates a ring status of "Normal," continue with step 5.
  - b. Otherwise, the filter cable connected to the RI receptacle of the second IBM 8218 is defective.
    - 1) Replace the filter cable with a spare filter cable.
    - 2) Obtain a new filter cable for future use.
    - 3) Reconnect all other cables, including those in other wiring closets.
    - 4) Go to "Manual Procedure, Part 7" on page 3-88.
5. Reconnect the yellow crossover patch cable to the filter cable that is connected to the RI receptacle of the second IBM 8218.
- a. If the cable connected to the filter cable just tested is a copper patch cable, then continue with step 6.
  - b. Otherwise, go to step 7.
6. Disconnect the yellow crossover patch cable from the distribution panel or other cable.

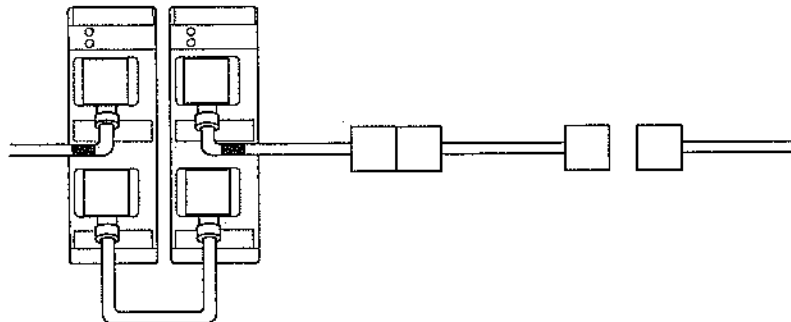

- a. If the observer terminal indicates a ring status of "Normal," reconnect the yellow crossover patch cable to the distribution panel or other cable. Continue with step 7.
- b. Otherwise, the yellow crossover patch cable connected to the filter cable is defective.
  - 1) Replace the yellow crossover patch cable with a spare yellow crossover patch cable.
  - 2) Obtain a new yellow crossover patch cable for future use.
  - 3) Reconnect all other cables, including those in other wiring closets.
  - 4) Go to "Manual Procedure, Part 7" on page 3-88.

7. Check for more IBM 8218s.
  - a. If there is another pair of IBM 8218s in this ring segment, go to the location of the next downstream pair. Then return to step 2.
  - b. Otherwise, the cable between this location and the next downstream wiring closet is defective.
    - 1) Disconnect both ends of the defective cable.
    - 2) Reconnect all other cables, including those in other wiring closets.
    - 3) Go to "Testing Data Cables" on page 3-171.
8. Disconnect the yellow crossover patch cable from the RO receptacle of the first IBM 8218.

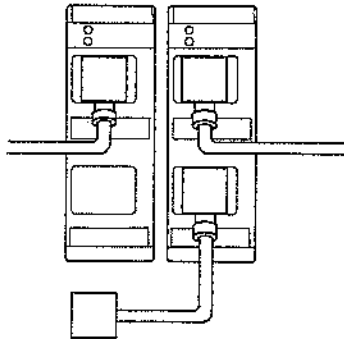

- a. If the observer terminal indicates a ring status of "Normal," continue with step 9.
  - b. Otherwise, go to step 10.
9. Reconnect the yellow crossover patch cable to RO of the first IBM 8218. Temporarily replace the yellow crossover patch cable that is connected to the RO receptacles of the IBM 8218s.
  - a. If the observer terminal indicates a ring status of "Normal," the yellow crossover patch cable just removed is defective.
    - 1) Reconnect all other cables, including those in other wiring closets.
    - 2) Obtain a new yellow crossover patch cable for future use.
    - 3) Go to "Manual Procedure, Part 7" on page 3-88.
  - b. Otherwise, the second IBM 8218 is defective.
    - 1) Reconnect any cables, including those in other wiring closets, that have not been reconnected.
    - 2) Go to "Replacing a Defective IBM 8218" on page 3-178.

10. Disconnect both copper patch cables from the second IBM 8218. Disconnect the copper patch cable or filter cable from the RI receptacle of the first IBM 8218 and connect it to the RI receptacle of the second IBM 8218.

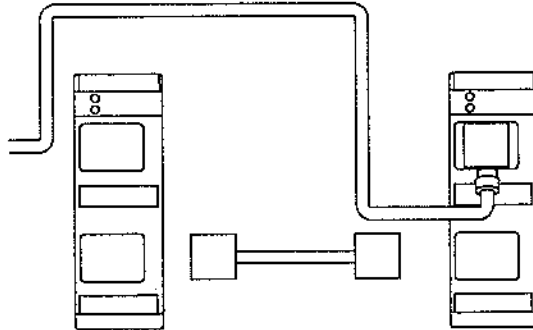

- a. If the observer terminal indicates a ring status of "Normal," the first IBM 8218 is defective.
- 1) Reconnect any cables, including those in other wiring closets, that have not been reconnected.
  - 2) Go to "Replacing a Defective IBM 8218" on page 3-178.
- b. Otherwise, disconnect the copper patch cable from the RI receptacle of the second IBM 8218 and reconnect it to the RI receptacle of the first IBM 8218. Reconnect the cables to the second IBM 8218. Continue with step 11.
11. Check type of copper patch cable or filter cable.

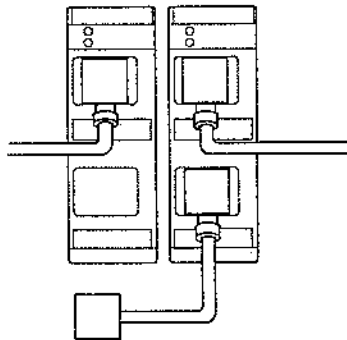

- a. If the cable connected to the RI receptacle of the first IBM 8218 is a filter cable, then continue with step 12.
- b. If the cable connected to the RI receptacle of the first IBM 8218 is a copper patch cable, then go to step 14.
- c. Otherwise, go to step 15.
12. Temporarily replace the filter cable that is connected to the RI receptacle of the first IBM 8218 with a spare filter cable.
- a. If the observer terminal indicates a ring status of "Normal," the filter cable just removed is defective.
- 1) Replace the filter cable with a spare filter cable.
  - 2) Obtain a new filter cable for future use.
  - 3) Reconnect all other cables, including those in other wiring closets.
  - 4) Go to "Manual Procedure, Part 7" on page 3-88.
- b. Otherwise, continue with step 13.



13. Disconnect the spare filter cable and reconnect the original filter cable.
  - a. If the cable connected to the filter cable just tested is a copper patch cable, then continue with step 14.
  - b. Otherwise, go to step 15.
14. Temporarily replace the copper patch cable with a spare copper patch cable.
  - a. If the observer terminal indicates a ring status of "Normal," the copper patch cable just removed is defective.
    - 1) Reconnect all other cables, including those in other wiring closets.
    - 2) Obtain a new copper patch cable for future use.
    - 3) Go to "Manual Procedure, Part 7" on page 3-88.
  - b. Otherwise, continue with step 15.
15. The cable between this location and the next upstream wiring closet is defective.
  - a. Disconnect both ends of the defective cable.

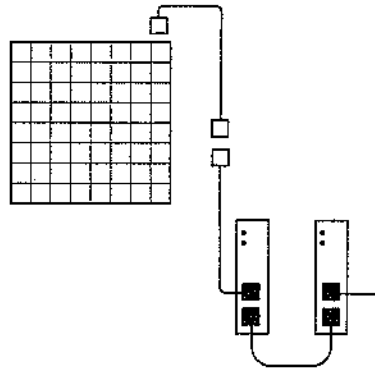

- b. Reconnect all other cables including those in other wiring closets.
- c. Go to "Testing Data Cables" on page 3-171.

## Manual Procedure, Part 6

1. Check the IBM 8218's power indicators.

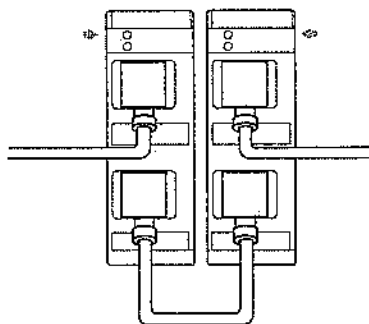

- a. If the Power On indicators on both IBM 8218s are lit, continue with step 2.
  - b. Otherwise:
    - 1) Reconnect any cables that have not been reconnected.
    - 2) Go to "IBM 8218/8219/8220 Power Problems" on page 3-163.
2. Disconnect the copper patch cable or filter cable that is connected to the RI receptacle of the first IBM 8218.

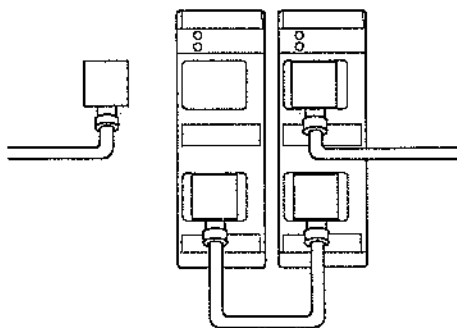

- a. If the observer terminal indicates a ring status of "Normal," reconnect the copper patch cable or filter cable to the RI receptacle of the first IBM 8218, then continue with step 3.
- b. Otherwise, go to step 6.

3. Disconnect the yellow crossover patch cable that is connected to the RO receptacle of the first IBM 8218.

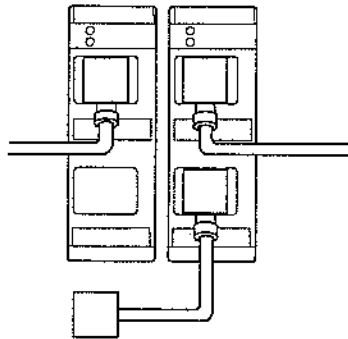

- a. If the observer terminal indicates a ring status of "Normal," reconnect the yellow crossover patch cable to the RO receptacle of the first IBM 8218, then continue with step 4.
  - b. Otherwise, the first IBM 8218 is defective.
    - 1) Reconnect any cables, including those in other wiring closets, that have not been reconnected.
    - 2) Then go to "Replacing a Defective IBM 8218" on page 3-178.
4. Disconnect the copper patch cable or filter cable that is connected to the RI receptacle of the second IBM 8218.

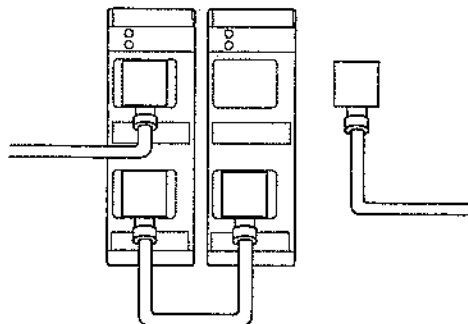

- a. If the observer terminal indicates a ring status of "Normal," reconnect the copper patch cable or filter cable to the RI receptacle of the second IBM 8218, then go to step 9.
  - b. Otherwise, continue with step 5.
5. Using a spare yellow crossover patch cable, temporarily replace the yellow crossover patch cable connected to the RO receptacles of the IBM 8218s.
    - a. If the observer terminal indicates a ring status of "Normal," the yellow crossover patch cable just removed is defective.
      - 1) Obtain a new yellow crossover patch cable for future use.
      - 2) Reconnect any cables, including those in other wiring closets, that have not been reconnected.
      - 3) Go to "Manual Procedure, Part 7" on page 3-88.
    - b. Otherwise, the second IBM 8218 is defective.
      - 1) Reconnect any cables, including those in other wiring closets, that have not been reconnected.
      - 2) Then go to "Replacing a Defective IBM 8218" on page 3-178.

6. Check for a white DGM-to-Type 3 Filter cable.

- a. If there is a white DGM-to-Type 3 Filter cable connected to the first IBM 8218, continue with step 7.

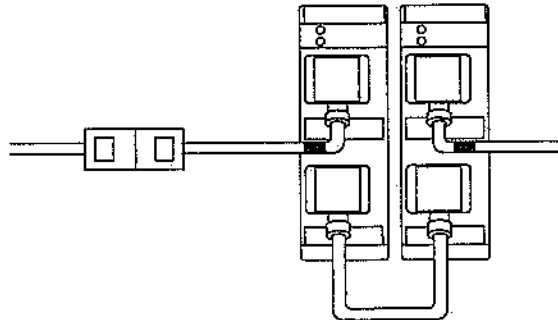

- b. Otherwise, go to step 8.

7. Disconnect the white filter cable that was connected to the first IBM 8218 from the patch cable.

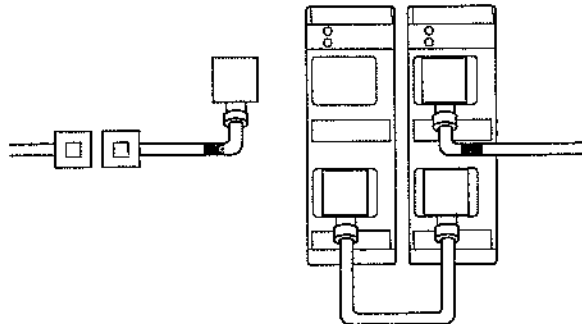

- a. If the observer terminal indicates a ring status of "Normal," the white filter cable just disconnected is defective.

- 1) Replace it with a spare white filter cable.
- 2) Obtain a new white filter cable for future use.
- 3) Reconnect any cables, including those in other wiring closets, that have not been reconnected.
- 4) Go to "Manual Procedure, Part 7" on page 3-88.

- b. Otherwise, the cable that the white filter cable was connected to is defective.

- 1) Replace it with a spare copper patch cable.
- 2) Reconnect any cables, including those in other wiring closets, that have not been reconnected.
- 3) Obtain a new copper patch cable for future use.
- 4) Go to "Manual Procedure, Part 7" on page 3-88.

8. Temporarily replace the copper patch cable that was connected to the RI of the first IBM 8218.
  - a. If the observer terminal indicates a ring status of "Normal," the copper patch cable just removed is defective.
    - 1) Obtain a new copper patch cable for future use.
    - 2) Reconnect any cables, including those in other wiring closets, that have not been reconnected.
    - 3) Go to "Manual Procedure, Part 7" on page 3-88.
  - b. Otherwise:
    - 1) Disconnect the spare copper patch cable and reconnect the original copper patch cable.
    - 2) Reconnect any cables, including those in other wiring closets, that have not been reconnected.
    - 3) This procedure has failed to locate the problem. Notify the network administrator and/or go to "Diagnosing Difficult Ring Problems" on page 3-166 to continue.
9. Check for white DGM-to-Type 3 Filter cables.
  - a. If the cable connected to the RI receptacle of the second IBM 8218 is a white DGM-to-Type 3 Filter cable, continue with step 10.

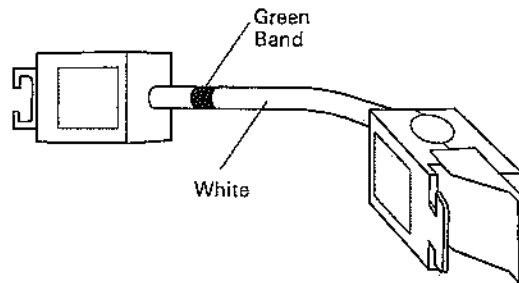

- b. Otherwise, go to step 11.
10. Disconnect the white filter cable that is connected to the second IBM 8218 from the yellow crossover patch cable.

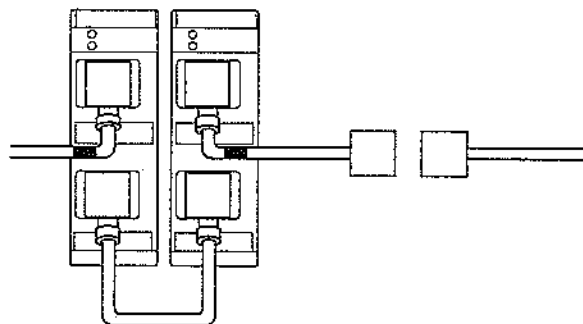

- a. If the observer terminal indicates a ring status of "Normal," the yellow crossover patch cable that the white filter cable was connected to is defective.
    - 1) Replace it with a spare yellow crossover patch cable.
    - 2) Obtain a new yellow crossover patch cable for future use.
    - 3) Reconnect any cables, including those in other wiring closets, that have not been reconnected.
    - 4) Go to "Manual Procedure, Part 7" on page 3-88.

- b. Otherwise, the white filter cable connected to the second IBM 8218 is defective.

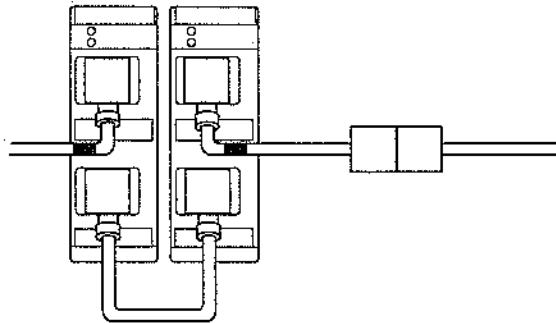

- 1) Replace it with a spare white filter cable.
  - 2) Obtain a new filter cable for future use.
  - 3) Reconnect any cables, including those in other wiring closets, that have not been reconnected.
  - 4) Go to "Manual Procedure, Part 7" on page 3-88.
11. Temporarily replace the yellow crossover patch cable that is connected to the RI of the second IBM 8218.
- a. If the observer terminal indicates a ring status of "Normal," the yellow crossover patch cable just removed is defective.
    - 1) Obtain a new yellow crossover patch cable for future use.
    - 2) Reconnect any cables, including those in other wiring closets, that have not been reconnected.
    - 3) Go to "Manual Procedure, Part 7" on page 3-88.
  - b. Otherwise:
    - 1) Disconnect the spare yellow crossover patch cable and reconnect the original yellow crossover patch cable.
    - 2) Reconnect any cables, including those in other wiring closets, that have not been reconnected.
    - 3) This procedure has failed to locate the problem. Notify the network administrator and/or go to "Diagnosing Difficult Ring Problems" on page 3-166.

---

## Manual Procedure, Part 7

Ensure that all cables have been reconnected to the correct receptacles. Start your network diagnostic tool on the observer terminal.

1. If the ring status is "Normal," the problem has been resolved. No further action is necessary.
2. Otherwise, return to "Starting the Problem Determination Procedures" on page 3-5 to locate the next problem.

## Manual Procedure, Part 1, for Remote Program Load

1. Determine the number of wiring closets in this ring.
  - a. If this ring is contained within a single wiring closet, continue with step 2.
  - b. Otherwise, go to "Manual Procedure, Part 2, for Remote Program Load" on page 3-92.
2. Create a small "test ring" by bypassing the observer terminal's IBM 8228. Start the Ring Diagnostic, Network Manager, or other diagnostic tool on the observer terminal.

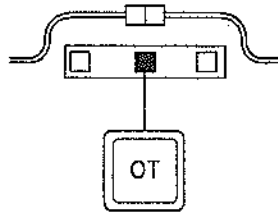

- a. If the observer terminal indicates a ring status of "Normal," reconnect the cable to the RO receptacle of the observer terminal's IBM 8228, then continue with step 3.
  - b. Otherwise, the disconnected IBM 8228 or one of the lobes or devices connected to it may be defective. Go to "Isolation of an IBM 8228 for Remote Program Load" on page 3-130 to continue.
3. Add another IBM 8228 to the test ring by disconnecting the cable from the RO receptacle of the next downstream IBM 8228.

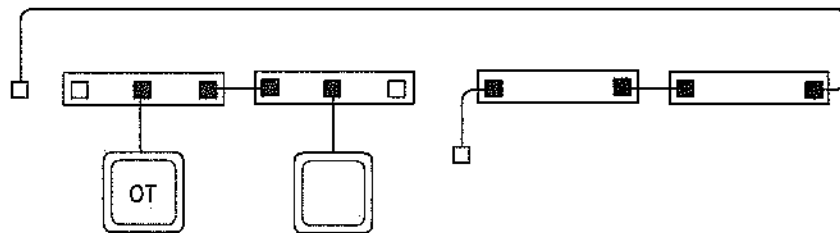

- a. If the observer terminal indicates a ring status of "Normal," reconnect the cable to the RO receptacle of the IBM 8228, then continue with step 4.
  - b. Otherwise, go to step 8.
4. Check for more IBM 8228s.
  - a. If the observer terminal is connected to the next downstream IBM 8228, continue with step 5.
  - b. Otherwise, return to step 3.
5. Reconnect the cable to the RI receptacle of the observer terminal's IBM 8228.
  - a. If the observer terminal indicates a ring status of "Normal," the problem has disappeared. Recovery and isolation are complete. No further action is required.
  - b. Otherwise, continue with step 6.



6. Check for IBM 8218s.
  - a. If the cable that is connected to the RI receptacle of the observer terminal's IBM 8228 is also connected to an IBM 8218 (or a filter cable that is connected to an IBM 8218), go to "Manual Procedure, Part 6, for Remote Program Load" on page 3-104.
  - b. Otherwise, continue with step 7.
7. Temporarily replace the copper patch cable connected to the RI receptacle of the observer terminal's IBM 8228.
  - a. If the observer terminal indicates a ring status of "Normal," the cable just replaced is defective. Obtain a new cable for future use. No further action is required.

- b. Otherwise, disconnect the spare cable and reconnect the original cable.

This procedure has failed to locate the problem. Notify the network administrator and/or go to "Diagnosing Difficult Ring Problems" on page 3-166 to continue.

8. Disconnect the cable from the RI receptacle of the last IBM 8228 added to the test ring.
  - a. If the observer terminal indicates a ring status of "Normal," the last IBM 8228 added to the test ring may be defective. Bypass the IBM 8228. Reconnect any other cables that have not been reconnected. Go to "Isolation of an IBM 8228 for Remote Program Load" on page 3-130.

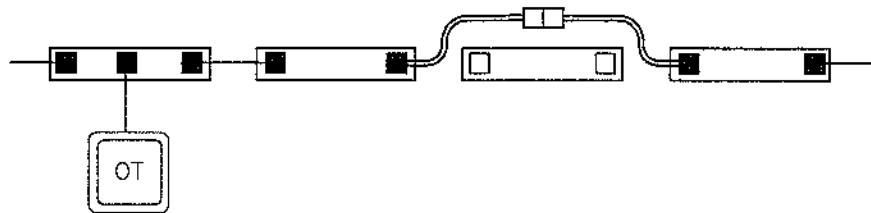

- b. Otherwise, reconnect the cable to the RI receptacle of the last IBM 8228 added to the test ring, and continue with step 9.
9. Check for IBM 8218s.
  - a. If the cable that is connected to the RI receptacle of the last IBM 8228 added to the test ring is also connected to an IBM 8218 (or to a filter cable that is connected to an IBM 8218), go to "Manual Procedure, Part 6, for Remote Program Load" on page 3-104.
  - b. Otherwise, continue with step 10.
10. Temporarily replace the patch cable connected to the RI receptacle of the last IBM 8228 added to the test ring.
  - a. If the observer terminal indicates a ring status of "Normal," the cable just replaced is defective. Obtain a new cable for future use. Reconnect the cable to the RO receptacle of the last IBM 8228 added to the test ring. Reconnect the cable to the RI receptacle of the observer terminal's IBM 8228. Go to "Manual Procedure, Part 7, for Remote Program Load" on page 3-107.
  - b. Otherwise, disconnect the spare cable and reconnect the original cable. Reconnect the cable to the RO receptacle of the last IBM 8228 added to the test ring. Reconnect the cable to the RI receptacle of the observer terminal's IBM 8228.

This procedure has failed to locate the problem. Notify the network administrator and/or go to "Diagnosing Difficult Ring Problems" on page 3-166 to continue.

## Manual Procedure, Part 2, for Remote Program Load

1. Go to the wiring closet that contains the observer terminal's IBM 8228. Create a test ring by following the instructions below.

Find the other end of the copper patch cable that is connected to the RI receptacle of the first IBM 8228 in this wiring closet.

- a. If the other end of the cable is connected to an IBM 8219 (or to a filter cable that is connected to the IBM 8219), disconnect the cable or filter cable from the IBM 8219, then continue with step 2.

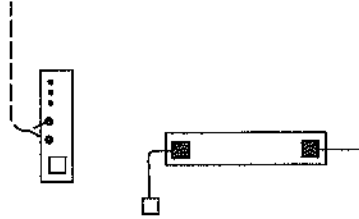

- b. If the other end of the cable is connected to an IBM 8218 (or to a filter cable that is connected to the IBM 8218), disconnect the cable that connects the first IBM 8218 to the distribution panel from the distribution panel, then continue with step 2.

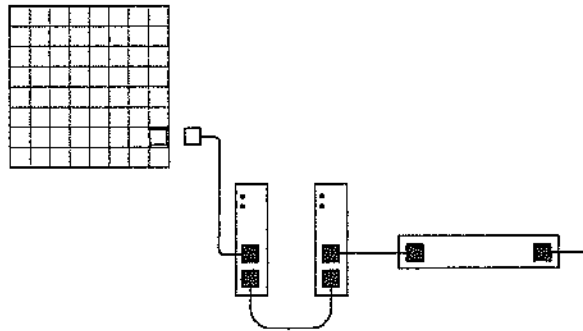

- c. If the other end of the cable is connected to an IBM 8220, disconnect the copper patch cable from the data receptacle of the IBM 8220. Then continue with step 2.

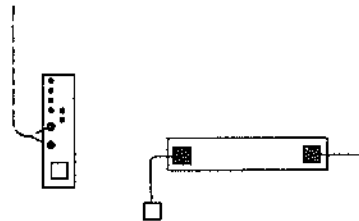

- d. Otherwise, disconnect the cable that connects the first IBM 8228 to the distribution panel from the distribution panel, then continue with step 2.

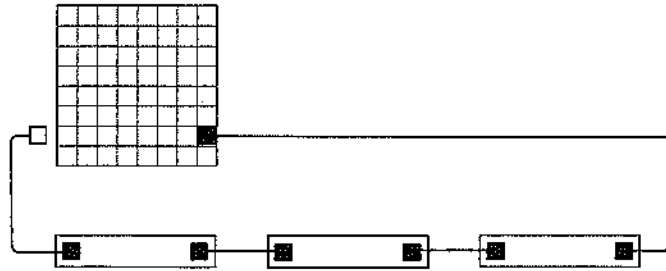

- 2. Find the other end of the cable that is connected to the RO receptacle of the last IBM 8228 in this wiring closet.
  - a. If the other end of the cable is connected to an IBM 8219 (or to a filter cable that is connected to the IBM 8219), disconnect the cable or filter cable from the IBM 8219, then continue with step 3.

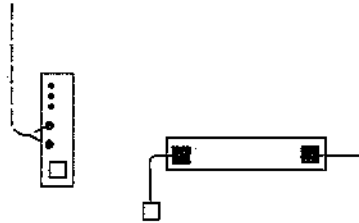

- b. If the other end of the cable is connected to an IBM 8218 (or to a filter cable that is connected to the IBM 8218), disconnect the cable that connects the last IBM 8218 to the distribution panel from the distribution panel, then continue with step 3.

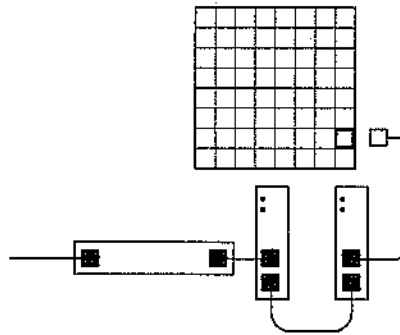

- c. If the other end of the copper patch cable is connected to an IBM 8220, disconnect the cable from the data receptacle of the IBM 8220. Then continue with step 3.

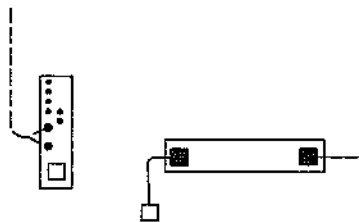



- c. If the other end of the copper patch cable is connected to an IBM 8220, disconnect the copper patch cable from the data receptacle of the IBM 8220. Then continue with step 5.

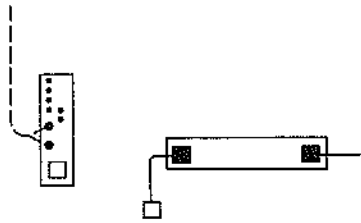

- d. Otherwise, disconnect the cable that connects the last IBM 8228 to the distribution panel from the distribution panel, then continue with step 5.

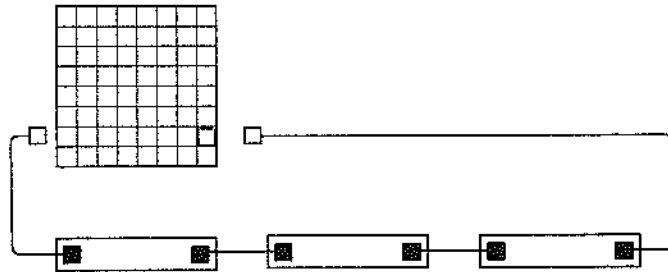

5. Determine the status of the test ring.
  - a. If the observer terminal indicates a ring status of "Normal," reconnect the cable from the last IBM 8228 in this wiring closet to the distribution panel or reconnect the cable or filter cable to the last IBM 8219 or IBM 8220 in the wiring closet. Then continue with step 6.
  - b. Otherwise, go to "Manual Procedure, Part 3, for Remote Program Load" on page 3-97.
6. Check for more wiring closets.
  - a. If the observer terminal's IBM 8228 is located in the next downstream wiring closet, go to step 7.
  - b. Otherwise, return to step 4 to test the next wiring closet.
7. Return to the observer terminal's wiring closet. Reconnect the cable from the first IBM 8228 in this wiring closet to the distribution panel or reconnect the copper patch cable or filter cable to the first IBM 8219 or IBM 8220 in the wiring closet.
  - a. If the observer terminal indicates a ring status of "Normal," the problem has disappeared. No further action is required.
  - b. Otherwise, the segment between the observer terminal's wiring closet and the next upstream wiring closet is defective. Continue with step 8.

8. Find the other end of the cable that is connected to the RI receptacle of the first IBM 8228 in this wiring closet.
  - a. If the other end of the copper patch cable is connected to an IBM 8219 (or to a filter cable that is connected to an IBM 8219).

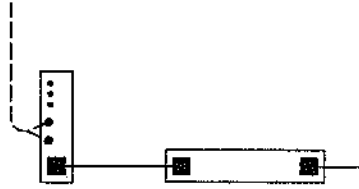

- 1) Disconnect the cable from the data receptacle of the IBM 8219.
- 2) Go to the wiring closet immediately upstream of the defective segment.
- 3) Disconnect the cable from the data receptacle of the last IBM 8219 in that wiring closet, then go to "Isolation of an Optical Fiber Ring Segment."

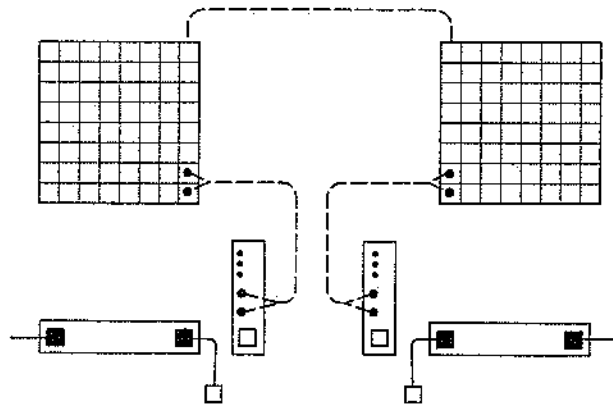

- b. If the other end of the cable is connected to an IBM 8220:
  - 1) Disconnect the copper patch cable from the data receptacle of the IBM 8220.
  - 2) Go to the wiring closet immediately upstream of the defective segment.
  - 3) Disconnect the cable from the data receptacle of the last IBM 8220 in that wiring closet.
  - 4) Go to "Isolation of an IBM 8220 Optical Fiber Subsystem" on page 3-115.
- c. Otherwise, disconnect the cable that connects the first IBM 8228 to the distribution panel or IBM 8218 from the distribution panel or IBM 8218. Go to the next upstream wiring closet and disconnect the cable from the distribution panel.
 

Then go to "Testing Data Cables" on page 3-171.

## Manual Procedure, Part 3, for Remote Program Load

1. Find the other end of the copper patch cable that is connected to the RI receptacle of the first IBM 8228 in this wiring closet.
  - a. If the other end of the copper patch cable is connected to an IBM 8219 (or to a filter cable that is connected to the IBM 8219), disconnect the copper patch cable or filter cable from the IBM 8219. Then continue with step 2.

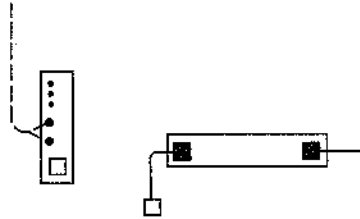

- b. If the other end of the copper patch cable is connected to an IBM 8218 (or to a filter cable that is connected to the IBM 8218), disconnect the cable that connects the first IBM 8218 to the distribution panel from the distribution panel. Then continue with step 2.

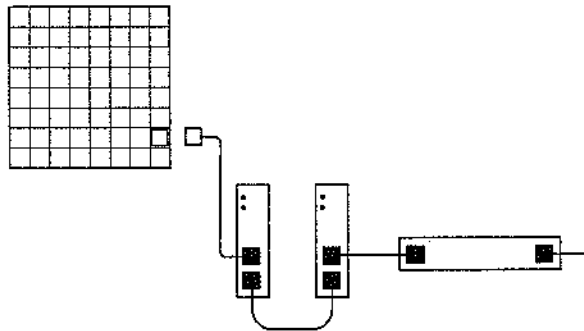

- c. If the other end of the copper patch cable is connected to an IBM 8220, disconnect the copper patch cable from the data receptacle of the IBM 8220. Then continue with step 2.

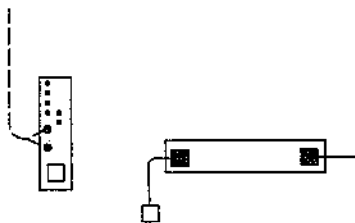



- d. Otherwise, disconnect the cable that connects the first IBM 8228 to the distribution panel from the distribution panel. Then go to step 2.

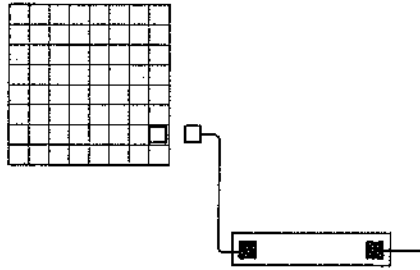

2. Determine the status of the test ring.
  - a. If the observer terminal indicates a ring status of "Normal," there is a problem in this wiring closet. Reconnect the cable from the first IBM 8228 or IBM 8218 in this wiring closet to the IBM 8219, IBM 8220, or distribution panel. Go to "Manual Procedure, Part 4, for Remote Program Load" on page 3-100.
  - b. Otherwise, the segment between this wiring closet and the next upstream wiring closet is defective. Continue with step 3.
3. Reconnect the cable from the last IBM 8228 in this wiring closet to the distribution panel or reconnect the copper patch cable or filter cable to the last IBM 8219 or IBM 8220 in the wiring closet. Return to the wiring closet that is immediately upstream of the defective segment. Find the other end of the cable that is connected to the RO receptacle of the last IBM 8228 in that wiring closet.
  - a. If the other end of the cable is connected to an IBM 8219 (or to a filter cable that is connected to an IBM 8219), disconnect the cable or filter cable from the IBM 8219, then go to "Isolation of an Optical Fiber Ring Segment, Part 1" on page 3-156.

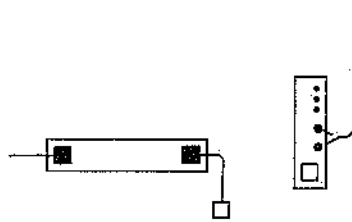

- b. If the other end of the cable is connected to an IBM 8220:
  - 1) Disconnect the cable from the data receptacle of the last IBM 8220 in that wiring closet.
  - 2) Return to the observer terminal's wiring closet and reconnect all cables that were left disconnected in that wiring closet.
  - 3) Go to "Isolation of an IBM 8220 Optical Fiber Subsystem" on page 3-115.

- c. Otherwise, disconnect the cable that connects the last IBM 8228 or IBM 8218 in that wiring closet to the distribution panel from the distribution panel. Return to the observer terminal's wiring closet and reconnect the cable from the first IBM 8228 to the IBM 8219, IBM 8220 or distribution panel, then go to "Testing Data Cables" on page 3-171.

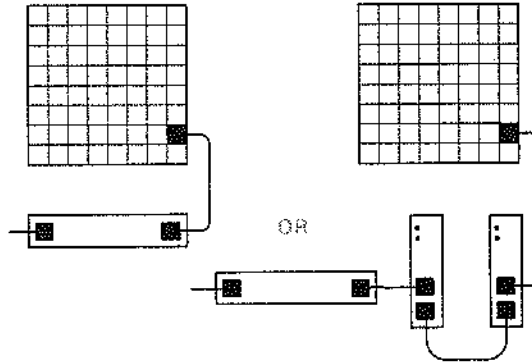

## Manual Procedure, Part 4, for Remote Program Load

1. Determine the location of observer terminal's IBM 8228.
  - a. If the observer terminal's IBM 8228 is in this wiring closet, then continue with step 2.
  - b. Otherwise, go to step 4.
2. Create a new test ring by bypassing the observer terminal's IBM 8228. Start the diagnostic tool on the observer terminal.

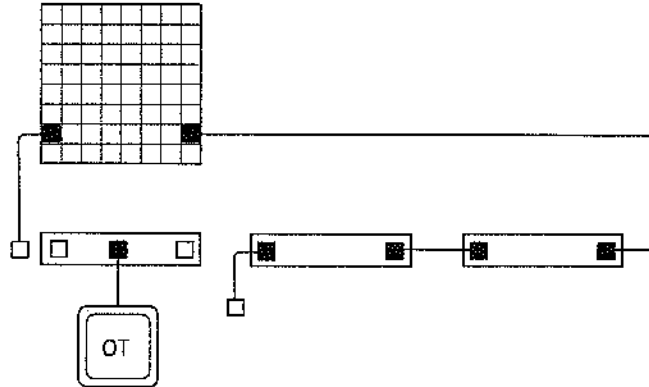

- a. If the observer terminal indicates a ring status of "Normal," then continue with step 3.
  - b. Otherwise, the disconnected IBM 8228 or one of the lobes or devices connected to it is defective. Go to "Isolation of an IBM 8228 for Remote Program Load" on page 3-130.
3. Reconnect the cable to the RI receptacle of the observer terminal's IBM 8228.

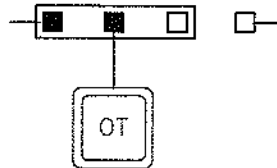

- a. If the observer terminal indicates a ring status of "Normal," reconnect the cable to the RO receptacle of the observer terminal's IBM 8228, then go to "Manual Procedure, Part 5, for Remote Program Load" on page 3-102.
  - b. Otherwise, go to step 6.
4. Add the first IBM 8228 in this wiring closet to the test ring by disconnecting the cable from the RO receptacle of the first IBM 8228 in this wiring closet.
  - a. If the observer terminal indicates a ring status of "Normal," reconnect the cable to the RO receptacle of the first IBM 8228 in this wiring closet, then go to "Manual Procedure, Part 5, for Remote Program Load" on page 3-102.
  - b. Otherwise, continue with step 5.

5. Disconnect the cable from the RI receptacle of the first IBM 8228 in this wiring closet.
  - a. If the observer terminal indicates a ring status of "Normal," the first IBM 8228 in this wiring closet may be defective.
    - 1) Bypass the IBM 8228.
    - 2) Reconnect any other cables that have not been reconnected.
    - 3) Go to "Isolation of an IBM 8228 for Remote Program Load" on page 3-130.
  - b. Otherwise, continue with step 6.
6. Check for IBM 8218s.
  - a. If the cable that is connected to the RI receptacle of the first IBM 8228 in this wiring closet is also connected to an IBM 8218 (or a filter cable that is connected to an IBM 8218), go to "Manual Procedure, Part 6, for Remote Program Load" on page 3-104.
  - b. Otherwise, continue with step 7.
7. Temporarily replace the copper patch cable connected to the RI receptacle of the first IBM 8228 in this wiring closet.



- a. If the observer terminal indicates a ring status of "Normal," the cable just replaced is defective.
  - 1) Obtain a new cable for future use.
  - 2) Reconnect any cables that have not been reconnected.
  - 3) Go to "Manual Procedure, Part 7, for Remote Program Load" on page 3-107.
- b. Otherwise, disconnect the spare cable and reconnect the original cable. Reconnect any cables that have not been reconnected.

This procedure has failed to locate the problem. Notify the network administrator and/or go to "Diagnosing Difficult Ring Problems" on page 3-166.

---

## Manual Procedure, Part 5, for Remote Program Load

1. Check for more IBM 8228s.
  - a. If there is another IBM 8228 in this wiring closet, continue with step 2.
  - b. Otherwise, go to step 3.
2. Add another IBM 8228 to the test ring by disconnecting the cable from the RO receptacle of the next downstream IBM 8228.

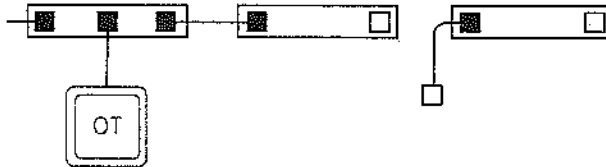

- a. If the observer terminal indicates a ring status of "Normal," reconnect the cable to the RO receptacle of the IBM 8228, then return to step 1.
  - b. Otherwise, go to step 7.
3. Determine the status of the test ring.
  - a. If the observer terminal indicates a ring status of "Normal," go to step 6.
  - b. Otherwise, continue with step 4.
4. Check for IBM 8218s.
  - a. If the cable that is connected to the RO receptacle of the last IBM 8228 in this wiring closet is also connected to an IBM 8218 (or a filter cable that is connected to an IBM 8218), go to "Manual Procedure, Part 6, for Remote Program Load" on page 3-104.
  - b. Otherwise, continue with step 5.
5. Temporarily replace the copper patch cable connected to the RO receptacle of the last IBM 8228.
  - a. If the observer terminal indicates a ring status of "Normal," the copper patch cable just replaced is defective.
    - 1) Obtain a new copper patch cable for future use.
    - 2) Reconnect any cables that have not been reconnected.
    - 3) Go to "Manual Procedure, Part 7, for Remote Program Load" on page 3-107.
  - b. Otherwise, disconnect the spare copper patch cable and reconnect the original copper patch cable. Reconnect any cables that have not been reconnected.

This procedure has failed to locate the problem. Notify the network administrator and/or go to "Diagnosing Difficult Ring Problems" on page 3-166.
6. Reconnect any cables that have not been reconnected.
  - a. If the observer terminal indicates a ring status of "Normal," the problem appears to have disappeared. Go to "Manual Procedure, Part 7, for Remote Program Load" on page 3-107.

- b. Otherwise, this procedure has failed to locate the problem. Notify the network administrator and/or go to "Diagnosing Difficult Ring Problems" on page 3-166.
7. Disconnect the copper patch cable from the RI receptacle of the last IBM 8228 added to the test ring.
- a. If the observer terminal indicates a ring status of "Normal," the last IBM 8228 added to the test ring may be defective.
    - 1) Bypass the IBM 8228.

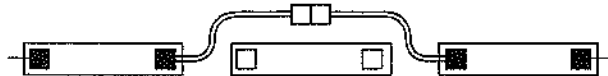

- 2) Reconnect any other cables that have not been reconnected.
  - 3) Go to "Isolation of an IBM 8228 for Remote Program Load" on page 3-130.
- b. Otherwise, continue with step 8.
8. Check for IBM 8218s.
- a. If the copper patch cable that is connected to the RI receptacle of the last IBM 8228 added to the test ring is also connected to an IBM 8218 (or a filter cable that is connected to an IBM 8218), go to "Manual Procedure, Part 6, for Remote Program Load" on page 3-104.
  - b. Otherwise, continue with step 9.
9. Temporarily replace the copper patch cable connected to the RI receptacle of the last IBM 8228 added to the test ring.
- a. If the observer terminal indicates a ring status of "Normal," the copper patch cable just replaced is defective.
    - 1) Obtain a new cable for future use.
    - 2) Reconnect any cables that have not been reconnected.
    - 3) Go to "Manual Procedure, Part 7, for Remote Program Load" on page 3-107.
  - b. Otherwise, disconnect the spare copper patch cable and reconnect the original copper patch cable. Reconnect any cables that have not been reconnected.
- This procedure has failed to locate the problem. Notify the network administrator and/or go to "Diagnosing Difficult Ring Problems" on page 3-166.

## Manual Procedure, Part 6, for Remote Program Load

1. Check the IBM 8218's power light.

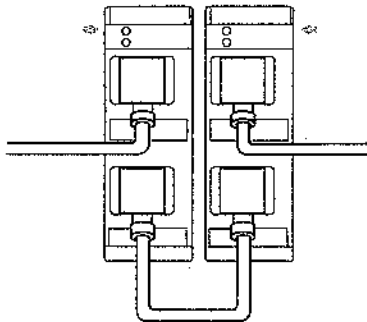

- a. If the Power On indicators on both IBM 8218s are lit, continue with step 2.
  - b. Otherwise, reconnect any cables that have not been reconnected. Then go to "IBM 8218/8219/8220 Power Problems" on page 3-163.
2. Bypass the first IBM 8218 by disconnecting the copper patch cables from the RI and RO receptacles and connecting the cables together.

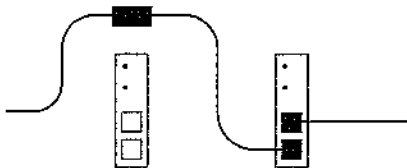

- a. If the observer terminal indicates a ring status of "Normal," the bypassed IBM 8218 is defective.
    - 1) Leave the IBM 8218 bypassed.
    - 2) Reconnect any other cables that have not been reconnected.
    - 3) Then go to "Replacing a Defective IBM 8218" on page 3-178.
  - b. Otherwise, reconnect the cables to the first IBM 8218, then go to step 3.
3. Bypass the second IBM 8218 by disconnecting the copper patch cables from the RI and RO receptacles and connecting the cables together.

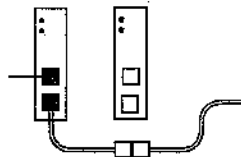

- a. If the observer terminal indicates a ring status of "Normal," the bypassed IBM 8218 is defective.
    - 1) Leave the IBM 8218 bypassed.
    - 2) Reconnect any other cables that have not been reconnected.
    - 3) Go to "Replacing a Defective IBM 8218" on page 3-178.
  - b. Otherwise, reconnect the cables to the second IBM 8218, then go to step 4.
4. Check for white DGM-to-Type 3 Filter cables.
    - a. If the cables connected to the RI receptacles of the IBM 8218s are white filter cables, continue with step 5.
    - b. Otherwise, go to step 7.

5. Temporarily replace the white filter cable connected to the RI receptacle of the first IBM 8218 with a spare white filter cable.
  - a. If the observer terminal indicates a ring status of "Normal," the white filter cable just replaced is defective.
    - 1) Obtain a new white filter cable for future use.
    - 2) Reconnect any cables that have not been reconnected.
    - 3) Go to "Manual Procedure, Part 7, for Remote Program Load" on page 3-107.
  - b. Otherwise, remove the spare filter cable and reconnect the original filter cable. Continue with step 6.
6. Temporarily replace the filter cable connected to the RI receptacle of the second IBM 8218 with a spare filter cable.
  - a. If the observer terminal indicates a ring status of "Normal," the filter cable just replaced is defective.
    - 1) Obtain a new filter cable for future use.
    - 2) Reconnect any cables that have not been reconnected.
    - 3) Go to "Manual Procedure, Part 7, for Remote Program Load" on page 3-107.
  - b. Otherwise, remove the spare filter cable and reconnect the original filter cable and continue with step 7.
7. Temporarily replace the copper patch cable that connects to the RI of the first IBM 8218 (or to a filter cable that connects to the IBM 8218).
  - a. If the observer terminal indicates a ring status of "Normal," the copper patch cable just replaced is defective.
    - 1) Obtain a new copper patch cable for future use.
    - 2) Reconnect any cables that have not been reconnected.
    - 3) Go to "Manual Procedure, Part 7, for Remote Program Load" on page 3-107.
  - b. Otherwise, remove the spare copper patch cable and reconnect the original copper patch cable. Continue with step 8.
8. Temporarily replace the yellow crossover patch cable that is connected to the RO of both IBM 8218s.

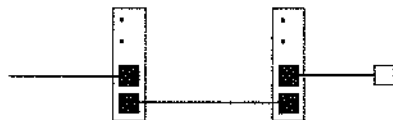

- a. If the observer terminal indicates a ring status of "Normal," the yellow crossover patch cable just replaced is defective.
  - 1) Obtain a new yellow crossover patch cable for future use.
  - 2) Reconnect any cables that have not been reconnected.
  - 3) Go to "Manual Procedure, Part 7, for Remote Program Load" on page 3-107.
- b. Otherwise, remove the spare yellow crossover patch cable and reconnect the original yellow crossover patch cable. Continue with step 9.



9. Temporarily replace the yellow crossover patch cable that is connected to the RI of the second IBM 8218 (or to a filter cable that connects to the IBM 8218). Do not connect the distribution panel end to the distribution panel at this time.
  - a. If the observer terminal indicates a ring status of "Normal," the yellow crossover patch cable just replaced is defective.
    - 1) Obtain a new yellow crossover patch cable for future use.
    - 2) Reconnect any cables that have not been reconnected.
    - 3) Go to "Manual Procedure, Part 7, for Remote Program Load" on page 3-107.
  - b. Otherwise, disconnect the spare yellow crossover patch cable and reconnect the original yellow crossover patch cable. Reconnect any cables that have not been reconnected. This procedure has failed to locate the problem. Notify the network administrator and/or go to "Diagnosing Difficult Ring Problems" on page 3-166.

---

## Manual Procedure, Part 7, for Remote Program Load

1. Ensure that all cables have been reconnected to the correct receptacles. Use the Ring Sequence Chart and appropriate Cabling Charts as a guide.
2. Start the diagnostic tool on the observer terminal. Attempt to communicate with another device that is connected to the observer terminal's IBM 8228.
  - a. If the observer terminal's ring is operational, the problem has been resolved. No further action is required.
  - b. Otherwise, return to "Starting the Problem Determination Procedures" on page 3-5 to isolate the next problem.

## Testing IBM 8228s

1. Bypass any IBM 8228 in this wiring closet that is in the ring segment that has not been bypassed.

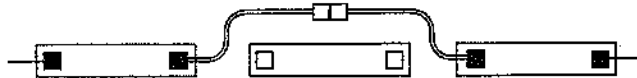

- a. If the observer terminal's ring is operational now, the bypassed IBM 8228 or one of its lobes may be defective.
    - 1) Leave the IBM 8228 bypassed.
    - 2) Go to "Isolation of an IBM 8228" on page 3-127 to continue.
  - b. Otherwise, reconnect cables to the IBM 8228 and continue with step 2.
2. Check for more IBM 8228s.
    - a. If all IBM 8228s in this wiring closet that are in the ring segment have been bypassed:
      - 1) All the IBM 8228s in this wiring closet are operational.
      - 2) Return to the procedure and step you recorded before coming here.
    - b. Otherwise, return to step 1 and test another IBM 8228.

## Testing IBM 8218s and IBM 8219s

1. If there is a pair of IBM 8218s in the ring segment in this wiring closet, continue with step 2.

Otherwise, go to step 8.

2. Observe each IBM 8218's power indicator.

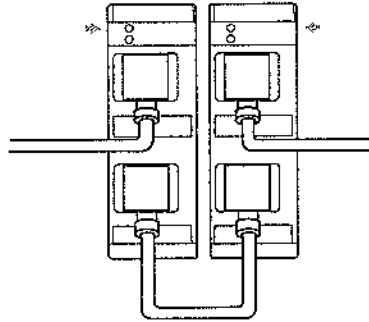

- a. If the Power On indicator on both IBM 8218s is lit, continue with step 3.
  - b. Otherwise, go to "IBM 8218/8219/8220 Power Problems" on page 3-163.
3. At each IBM 8218, disconnect the copper patch cable connected to its RI receptacle and reconnect the cable to the other IBM 8218.

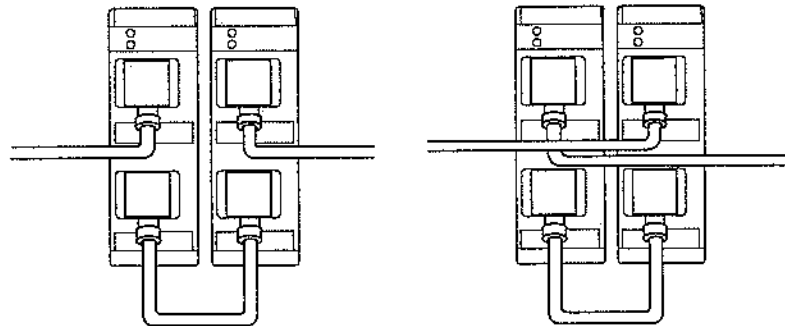

Before

After

- a. If the observer terminal's ring is operational now, one of the IBM 8218 is defective. Go to "Isolation of IBM 8218s" on page 3-162.
- b. Otherwise, reconnect the cables to the proper IBM 8218s. Continue with step 4.

4. Check for white DGM-to-Type 3 Filter cables.
  - a. If the cables connected to the RI receptacles of the IBM 8218s are white DGM-to-Type 3 Filter cables, continue with step 5.

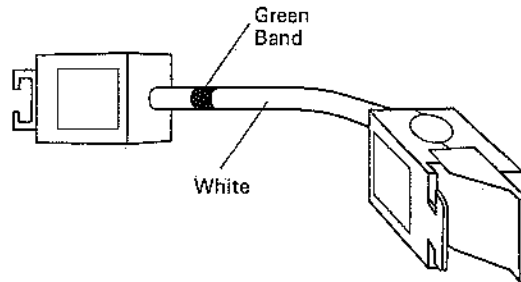

- b. Otherwise, go to step 7.
5. Temporarily replace the white filter cable connected to one of the IBM 8218s with a spare filter cable.

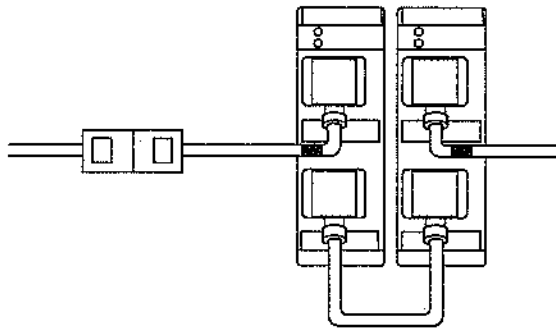

- a. If the observer terminal's ring is now operational, the white filter cable just replaced is defective. Obtain a new white filter cable for future use. No further action is required.
  - b. Otherwise, remove the spare and reconnect the original white filter cable. Continue with step 6.
6. Temporarily replace the white DGM-to-Type 3 Filter cable connected to the other IBM 8218 with a spare white filter cable.

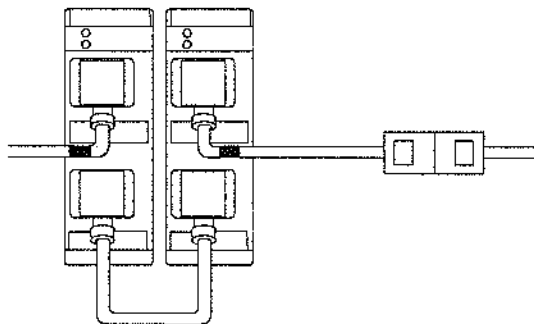

- a. If the observer terminal's ring is now operational, the white filter cable just replaced is defective. Obtain a new white filter cable for future use. No further action is required.
  - b. Otherwise, remove the spare and reconnect the original white filter cable. Continue with step 7.

7. Check for more IBM 8218s.
  - a. If there is another pair of IBM 8218s in the ring segment in this wiring closet, return to step 2 and test that pair.
  - b. Otherwise, continue with step 8.
8. Check for IBM 8219s.
  - a. If there are any IBM 8219s in the ring segment in the wiring closet, continue with step 9.
  - b. Otherwise, ensure all cables have been reconnected to the proper receptacles.
    - 1) All IBM 8218s in this wiring closet that are in the ring segment are operational.
    - 2) Return to the procedure and step you recorded before coming here.
9. Observe the IBM 8219's power indicator.

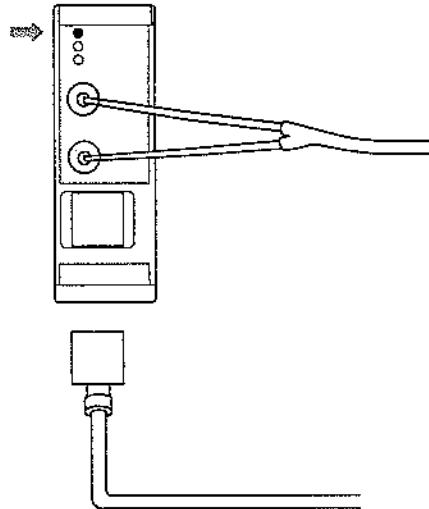

- a. If the Power On indicator on the IBM 8219 is lit, continue with step 10.
  - b. Otherwise, go to "IBM 8218/8219/8220 Power Problems" on page 3-163.
10. Check for white DGM-to-Type 3 Filter cables.

- a. If the cable connected to the data receptacle of the IBM 8219 is a white DGM-to-Type 3 Filter cable, continue with step 11.

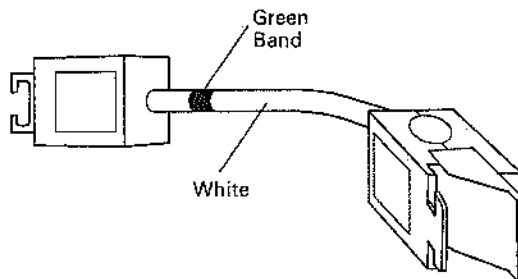

- b. Otherwise, go to step 12.

11. Temporarily replace the white filter cable connected to the data receptacle of the IBM 8219 with a spare white filter cable.

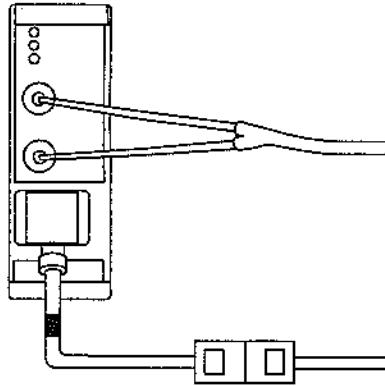

- a. If the observer terminal's ring is now operational, the white filter cable just replaced is defective. Obtain a new white filter cable for future use. No further action is required.
  - b. Otherwise, remove the spare and reconnect the original white filter cable. Continue with step 12.
12. Check for more IBM 8219s.
    - a. If there is another IBM 8219 in the ring segment in this wiring closet, return to step 9 and test it.
    - b. Otherwise, ensure all cables have been reconnected to the proper receptacles.
      - 1) All IBM 8218s and/or IBM 8219s in this wiring closet that are in the ring segment are operational.
      - 2) Return to the procedure and step you recorded before coming here.

---

## Ring Wrapped or Loss of Critical Resource

**Note:** These procedures may require you to find a certain device or component. See Appendix A for instructions.

1. Determine symptom.
  - a. If the symptom is loss of critical resource, continue with step 2.
  - b. Otherwise, go to step 3.
2. Determine the type of device that contains the address reported as a lost resource.
  - a. If the lost resource is an IBM 8220 optical fiber subsystem, go to "Isolation of an IBM 8220 Optical Fiber Subsystem" on page 3-115.

**Note:** An IBM 8220 optical fiber subsystem is a segment of the main ring path containing only optical fiber cabling with a converter at each end.
  - b. Otherwise, go to the lost resource and determine the reason it was removed from the ring. Use that reason as the symptom and return to "Starting the Problem Determination Procedures" on page 3-5.
3. The main ring path has been wrapped to the backup path either by a fault in the IBM 8220 optical fiber subsystem or a disconnected cable.
  - a. If the wrap is caused by an IBM 8220 optical fiber subsystem, go to "Isolation of an IBM 8220 Optical Fiber Subsystem" on page 3-115.

**Note:** An IBM 8220 optical fiber subsystem is a segment of the main ring path containing only optical fiber cabling with a converter at each end.
  - b. Otherwise, use the Ring Sequence Chart to trace the cabling and locate the disconnected cable. Reconnect the disconnected cable. Problem determination is complete.



---

## Testing an IBM 8220 Optical Fiber Subsystem

**Note:** An IBM 8220 optical fiber subsystem is a segment of the main ring path containing only optical fiber cabling with a converter at each end.

1. Perform this step for each of the IBM 8220 optical fiber subsystems in the fault domain.

Remove the IBM 8220 optical fiber subsystem from the ring by disconnecting the copper patch cables from both IBM 8220s in the subsystem.

- a. If the observer terminal's ring is now operational, the IBM 8220 optical fiber subsystem is defective. Ring recovery is complete. Go to "Isolation of an IBM 8220 Optical Fiber Subsystem" on page 3-115.
- b. Otherwise, reconnect the cables to both IBM 8220s.
  - 1) If all IBM 8220 optical fiber subsystems in the fault domain have been tested, return to the procedure that sent you to this procedure.
  - 2) Otherwise, repeat this step to test another IBM 8220 optical fiber subsystem. Then return to the procedure that sent you here.

## Isolation of an IBM 8220 Optical Fiber Subsystem

**Note:** An IBM 8220 optical fiber subsystem is a segment of the main ring path containing only optical fiber cabling with a converter at each end.

1. Determining the next step.
  - a. If the original symptom was Soft Errors, go to step 11.
  - b. Otherwise, continue with step 2.
2. Make sure the copper patch cables have been disconnected from the data receptacles of both IBM 8220s in the subsystem.
  - a. Go to the location of the upstream (RI) IBM 8220.
  - b. Restore power to the IBM 8220, if necessary.
  - c. Make sure the Power On indicator is lit and that the optical fiber cables are correctly connected to the IBM 8220.

**Note:** Check the appropriate IBM 8220 Cabling Chart to determine if cables are connected correctly.

- d. Reset the upstream (RI) IBM 8220 by setting the RI/RO switch from RI to RO, then back to RI.
- e. Wait 35 seconds.
- f. Observe the status of the indicators on the upstream (RI) IBM 8220.
- g. Use the chart below to determine the next step.

Power On	Insert	E1	E2	Go To
Off	Off	Off	Off	Step 18
On	On	Off	Off	Step 15
On	Off	On	Off	Step 3
On	Off	Off	Flashing	Step 4
On	Off	Off	On	Step 4
On	Off	Flashing	Flashing	Step 4
On	Flashing	Flashing	Flashing	Step 4
On	Off	On	On	Step 17
On	Off	Off	Off	Step 20

3. The upstream (RI) IBM 8220 has detected an internal error. Go to "Replacing a Defective IBM 8220" on page 3-180 and replace the upstream (RI) IBM 8220.
4. Checking the switch settings on the upstream (RI) IBM 8220.

Check the IBM 8220 Cabling Chart to determine if switch settings are set correctly.

- a. If the RI/RO and 4/16 switches are set correctly, continue with step 5.
- b. Otherwise, place the switches in the correct positions and return to step 1 and restart the procedure.

5. The upstream (RI) IBM 8220 is unable to establish communication with the downstream (RO) IBM 8220. Write down this step and page number.  
 Go to "IBM 8220 Self-Test" on page 3-119 and test the upstream (RI) IBM 8220. Follow the instructions for that procedure if an error is detected. If instructed to return to this procedure, return to this step.
  - a. If an error was detected and corrected, go to step 15.
  - b. Otherwise, the self test was successful, continue with step 6.
6. Using a spare optical fiber patch cable, temporarily replace the cable between the upstream (RI) IBM 8220 and the distribution panel.
  - a. Reset the upstream (RI) IBM 8220 by setting the RI/RO switch from RI to RO, then back to RI.
  - b. Wait 35 seconds.
  - c. Observe the status of the indicators on the upstream (RI) IBM 8220.
    - 1) If the Insert indicator is lit and E1 and E2 are both off, the original optical fiber patch cable is defective. Go to step 15.
    - 2) Otherwise, remove the spare and reconnect the original optical fiber patch cable. Continue with step 7.
7. Go to the location of the downstream (RO) IBM 8220. Observe the indications on the IBM 8220 and use the chart below to determine the next step.

Power On	Insert	E1	E2	Go To
Off	Off	Off	Off	Step 18
On	Off	On	Off	Step 19
On	Off	On	On	Step 16
All others				Step 8

8. Check the switch settings on the downstream (RO) IBM 8220.  
 Check the appropriate IBM 8220 Cabling Chart to determine if the switch settings are correct.
  - a. If the RI/RO and 4/16 switches are set correctly, continue with step 9.
  - b. Otherwise, correct the switch settings and return to step 1 to retest the IBM 8220 optical fiber subsystem.
9. On a piece of paper, write down step 9 and its page number. Then go to "IBM 8220 Self-Test" on page 3-119 and test the downstream (RO) IBM 8220. Follow the instructions of that procedure if an error is detected. If instructed to return to this procedure, return to step 9.
  - a. If an error was detected and corrected, go to step 18.
  - b. Otherwise, the self test was successful, continue with step 10.
10. Using a spare optical fiber patch cable, temporarily replace the cable between the upstream (RI) IBM 8220 and the distribution panel.
  - a. Reset the upstream (RI) IBM 8220 by setting the RI/RO switch from RO to RI, then back to RO.
  - b. Wait 35 seconds.

- c. Observe the status of the indicators on the upstream (RI) IBM 8220.
  - 1) If the Insert indicator is lit and E1 and E2 are both off, the original optical fiber patch cable is defective. Go to step 15.
  - 2) Otherwise, remove the spare cable and reconnect the original optical fiber patch cable and go to the *IBM Cabling System Planning and Installation Guide* to repair the optical fiber cable between the two distributions panels.

11. Make sure the copper patch cable is connected to the downstream (RO) IBM 8220. Then go to the location of the upstream (RI) IBM 8220.

Disconnect the optical fiber patch cables from the Receive (Rx) and Transmit (Tx) receptacles.

- a. Connect the 6-inch test cable to the Rx and Tx receptacles of the IBM 8220.



- b. Select a device on the ring to use as an observer terminal.
- c. Using your observer terminal, determine ring status.
  - 1) If soft errors are occurring again and the address of the upstream (RI) IBM 8220 is in the fault domain, the upstream (RI) IBM 8220 is defective.
  - 2) Disconnect the copper patch cable from the data receptacle.
  - 3) Go to "Replacing a Defective IBM 8220" on page 3-180.
- d. Otherwise, remove the test cable. Reconnect the original copper patch cables to the Rx and Tx receptacles. Continue with step 13.

12. Using a spare optical fiber patch cable, temporarily replace the optical fiber patch cable between the upstream (RI) IBM 8220 and the distribution panel.

Select a device on the ring to use as an observer terminal.

Using your observer terminal, determine ring status.

- a. If ring status is "Normal," the optical fiber patch cable just removed is defective.

No further action is required.
  - b. Otherwise, remove the spare optical fiber patch cable and reconnect the original optical fiber patch cables to the Rx and Tx receptacles.

Continue with step 13.
13. Go to the location of the downstream (RO) IBM 8220.
    - a. Disconnect the optical fiber cables from the Rx and Tx receptacles.
    - b. Connect the 6-inch test cable to the Rx and Tx receptacles of the IBM 8220.
    - c. Reconnect the copper patch cable to the data receptacle of the downstream (RO) IBM 8220 if it has been disconnected.
    - d. Select a device on the ring to use as an observer terminal.

- e. Using your observer terminal, determine the ring status.
  - 1) If soft errors are occurring again and the address of the upstream IBM 8220 is in the fault domain, the downstream (RO) IBM 8220 is defective. Disconnect the copper patch cable from the data receptacle. Go to "Replacing a Defective IBM 8220" on page 3-180.
  - 2) Otherwise remove the test cable and reconnect the original optical fiber patch cables to the Rx and Tx receptacles. Continue with step 14.
14. Using a spare optical fiber patch cable, temporarily replace the optical fiber patch cable between the downstream (RO) IBM 8220 and the distribution panel. Select a device on the ring to use as an observer terminal. Using your observer terminal, determine ring status.
  - a. If ring status is "Normal," the optical fiber patch cable just removed is defective. No further action is required.
  - b. Otherwise, remove the spare optical fiber patch cable and reconnect the original cables to the Rx and Tx receptacles. Notify the network administrator and/or go to the *IBM Cabling System Planning and Installation Guide* to repair the optical fiber cable between the two distribution panels.
15. The problem appears to have disappeared or has been corrected.

At a convenient time, return the IBM 8220 optical fiber subsystem to the ring by reconnecting the copper patch cables to the data receptacles of both IBM 8220s. Also make sure all other cables are connected correctly.

Using your diagnostic tool, determine ring status.

  - a. If the ring status is "Normal," no further action is required.
  - b. Otherwise, notify the network administrator and/or go to "Manual Procedure, Part 1" on page 3-59.
16. The downstream (RO) IBM 8220 is responding to the address of the upstream IBM 8220. Go to "Replacing a Defective IBM 8220" on page 3-180 to replace the downstream (RO) IBM 8220.
17. The upstream (RI) IBM 8220 is responding to the address of the downstream (RO) IBM 8220. Go to "Replacing a Defective IBM 8220" on page 3-180 to replace the upstream (RI) IBM 8220.
18. The IBM 8220 has a power problem. Go to "IBM 8218/8219/8220 Power Problems" on page 3-163.
19. The downstream (RO) IBM 8220 has detected an internal error. Go to "Replacing a Defective IBM 8220" on page 3-180 and replace the downstream (RO) IBM 8220.
20. The IBM 8220 has received a "force remove" command from an IBM LAN Manager. Contact your network administrator. If no "force remove" command was sent, return to step 4 to continue.

## IBM 8220 Self-Test

1. Disconnect all cables from the IBM 8220 to be tested.
  - a. Restore power to the IBM 8220, if necessary.
  - b. Connect the 6-inch optical fiber test cable to the Receive (Rx) and Transmit (Tx) receptacles of the IBM 8220.
  - c. Make sure the RI/RO switch is set in the RI (upstream) position.
  - d. Reset the IBM 8220 by moving the RI/RO switch from the RI position to the RO position, then back to the RI position.
  - e. Wait 35 seconds for the lights to indicate a change.
  - f. Use the chart below to determine the next step.

Power On	Insert	E1	E2	Go To
Off	Off	Off	Off	Step 2
On	On	Off	Off	Step 6
On	Off	On	Off	Step 3
On	Off	Off	On	Step 4
On	Off	On	On	Step 3
On	Off	Off	Flashing	Step 4
On	Flashing	Flashing	Flashing	Step 4
On	Off	Flashing	Flashing	Step 4
All others				Step 3

2. There is a power related problem with the IBM 8220. Go to "IBM 8218/8219/8220 Power Problems" on page 3-163.
3. An internal error has been detected. The IBM 8220 is defective. Go to "Replacing a Defective IBM 8220" on page 3-180.
4. An optical fiber connector or receptacle may be contaminated with some foreign material.
  - a. Remove the test cable from the IBM 8220 and use the procedure for cleaning fiber optical connectors and receptacles that is located in the *IBM Token-Ring Network Fiber Cable Options* manual or *IBM Token-Ring Network Installation Guide* to clean the optical fiber connectors and receptacles on the IBM 8220.
  - b. Reconnect the test cable to the IBM 8220.
  - c. Reset the IBM 8220 by moving the RI/RO switch from the RI position to the RO position and then back to the RI position.
  - d. Wait 35 seconds for the lights to indicate a change.
    - 1) If the error condition still occurs, the IBM 8220 is defective. Go to "Replacing a Defective IBM 8220" on page 3-180.
    - 2) Otherwise, the problem appears to have been resolved. Remove the test cable from the IBM 8220. Continue with step 5.

5. If you were sent to this procedure by another procedure, return to that procedure and follow the instructions for detecting and correcting an error.

Otherwise, replace the dust covers on the receptacles on the IBM 8220. The test is complete and no further action is required.

6. The self-test was successful. Remove the test cable from the IBM 8220. If you were sent to this procedure by another procedure, return to that procedure and follow the instructions for a successful self-test.

Otherwise, replace the dust covers on the receptacles on the IBM 8220. The test is complete and no further action is required.

---

## Duplicate Address on an IBM 8220

1. The IBM 8220 has detected that its address is being used by another device on the ring.
  - a. If the IBM 8220 indicating the error is a new one, return it to the place of purchase.
  - b. Otherwise, continue with step 2.
2. Check for recently added devices on the ring.
  - a. If there are other devices that were recently added to the ring, continue with step 3.
  - b. Otherwise, go to "Replacing a Defective IBM 8220" on page 3-180 to replace the IBM 8220 that is causing the error.
3. Compare the address of this IBM 8220 to the address of any devices that were recently added to the ring.
  - a. If the address matches that of the new devices, return the new device to the place of purchase and obtain a replacement.
  - b. Otherwise, go to "Replacing a Defective IBM 8220" on page 3-180 to replace the IBM 8220 that is causing the error.



---

## Testing Patch Cables

1. Temporarily replace any patch cable in this wiring closet that is in the ring segment and has not been tested. (This includes any yellow crossover patch cables or optical fiber patch cables that may be in the fault domain.)

*Wait six minutes* for the diagnostics to indicate a change in status.

- a. If the observer terminal's ring is operational now, the cable just removed from the ring is defective.
    - 1) Make the temporary cable permanent by routing it in the cable management brackets and guides.
    - 2) Remember to obtain a new cable to replace the one just used.
    - 3) Make sure that any other cables that have been disconnected have been reconnected.
    - 4) Ring recovery and isolation are complete. No further action is required.
  - b. Otherwise, remove the spare and reconnect the original patch cable before continuing with step 2.
2. Check for more cables.
    - a. If all the patch cables in this wiring closet that are in the ring segment have been tested, all the patch cables in this wiring closet that are in the ring segment are operational. Return to the procedure and step you recorded before coming here.
    - b. Otherwise, return to step 1 and test another cable.

## Testing Ring Segments

1. Test inter-wiring closet cables.

**Note:** The location of any device (IBM 8228, IBM 8218, or IBM 8219) is considered by this procedure to be a "wiring closet." Using the Ring Sequence Chart, determine the type of any inter-wiring closet cable in the ring segment.

- a. If the cable is a copper patch cable, go to step 2.
  - b. Otherwise, go to step 3.
2. Change one of the copper patch cables between the wiring closets by disconnecting the patch cables that connect to the distribution panel in each wiring closet. (For remote devices, disconnect the cable from the faceplate or device, whichever is appropriate.)

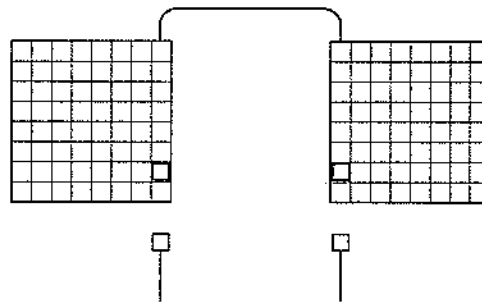

- a. If the observer terminal's ring is operational, the cable just disconnected between wiring closets is defective. Go to "Testing Data Cables" on page 3-171.
  - b. If the observer terminal's ring is still inoperative, reconnect the patch cables, then go to step 4.
3. Test the first fiber link between the wiring closets by disconnecting the copper patch cable from the IBM 8219s connected to it.

**Note:** The fiber link consists of only optical fiber cabling with an IBM 8219 at each end.

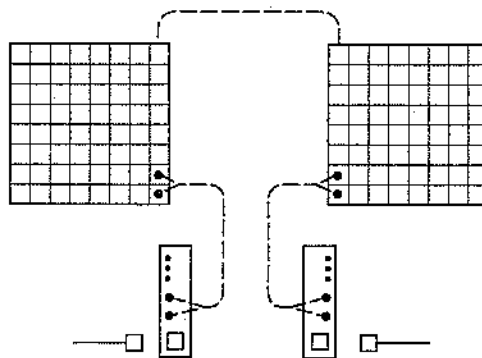

- a. If the observer terminal's ring is operational, the fiber link (including IBM 8219s) just disconnected between wiring closets is defective. Go to "Isolation of an Optical Fiber Ring Segment, Part 1" on page 3-156.
- b. Otherwise, reconnect the copper patch cables to the IBM 8219s, then continue with step 4.

4. Check for more inter-wiring closet cables.
  - a. If there is another inter-wiring closet cable in the ring segment that has not been tested, return to step 1 to test the next one.
  - b. Otherwise, all the inter-wiring closet cables in the ring segment are operational. Return to the procedure and step that you recorded before coming here.

## Wire Fault, Auto-Removal, or Open Errors (Function Failure)

Note: These procedures may require that you find a certain device or component. See Appendix A for instructions.

1. Determining the ring configuration.
  - a. If any of the devices on this ring have Remote Program Load installed, go to "Wire Fault, Auto Removal, or Open Error (Function Failure) for Remote Program Load" on page 3-126.
  - b. Otherwise, continue with step 2.
2. At the IBM 8228, disconnect the lobe cable of the lobe that contains the device with the error. Reconnect the lobe cable to a different receptacle of the IBM 8228.

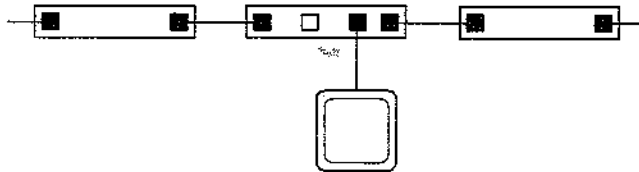

Restart the program on the device that indicated the error.

- a. If the device indicates the error now, the adapter on the lobe just reconnected or its lobe cable is defective. Disconnect the lobe cable from the IBM 8228 again. Go to "Device and Lobe Error Isolation" on page 3-140.
  - b. Otherwise, continue with step 3.
3. Disconnect the lobe cable from the IBM 8228 again. Reconnect it to its original receptacle of the IBM 8228.

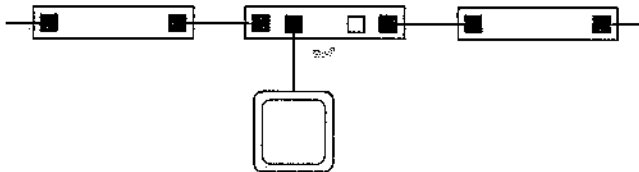

Restart the program on the device connected to the lobe just reconnected.

- a. If the device indicates an error, the IBM 8228 may be defective. Go to "Replacing a Defective IBM 8228" on page 3-177.
- b. Otherwise, the problem has disappeared. No further action is required.

## Wire Fault, Auto Removal, or Open Error (Function Failure) for Remote Program Load

**Note:** These procedures may require that you locate a certain device or component. See Appendix A for instructions.

1. Disconnect the lobe cable of the device with the error from the IBM 8228. Reconnect the lobe cable to a different receptacle of the IBM 8228 and attempt to start the device on this lobe.

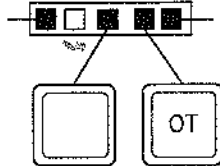

- a. If the device indicates an error, the device's adapter or its lobe cable(s) is defective. Disconnect the lobe cable from the IBM 8228 again and leave it disconnected. Go to "Device and Lobe Error Isolation" on page 3-140.
  - b. Otherwise, continue with step 2.
2. Disconnect the lobe cable from the IBM 8228 again. Reconnect it to its original receptacle of the IBM 8228 and attempt to start the device on this lobe.
    - a. If the device indicates an error, the IBM 8228 may be defective. Bypass the IBM 8228. Go to "Replacing a Defective IBM 8228" on page 3-177.
    - b. Otherwise, the problem has disappeared. No further action is required.

## Isolation of an IBM 8228

1. Determine the ring configuration.
  - a. If this IBM 8228 contains lobes with devices that have Remote Program Load installed, go to "Isolation of an IBM 8228 for Remote Program Load" on page 3-130. If not, continue with step 1b.
  - b. If this is a ring with a single IBM 8228:

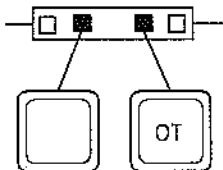

- 1) Select one device on the ring as an observer terminal.
    - 2) Disconnect a lobe cable from the IBM 8228 (other than the observer terminal's lobe cable).
    - 3) Continue with step 2.
  - c. Otherwise, return the bypassed IBM 8228 to the ring by reconnecting the cables to the RI and RO receptacles. At the IBM 8228, disconnect a lobe cable (other than the observer terminal if it is connected to this IBM 8228). Continue with step 2.
2. Start your diagnostic tool on the observer terminal and determine the ring status.
  - a. If the observer terminal indicates ring status of "Normal," the disconnected lobe, the adapter on that lobe, or the lobe logic in the IBM 8228 may be defective. Go to step 6.
  - b. Otherwise, reconnect the lobe cable to the IBM 8228, then continue with step 3.
3. Determine if there are more lobes.
  - a. If all lobes except the observer terminal (if on this IBM 8228) have been disconnected then reconnected, continue with step 4.
  - b. Otherwise, disconnect another lobe cable (other than the observer terminal) and return to step 2.

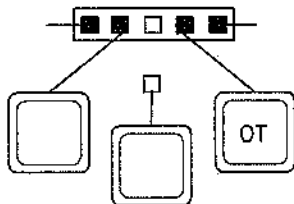

4. Check the location of the observer terminal.

a. If the observer terminal is connected to this IBM 8228, continue with step 5.

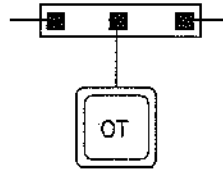

b. Otherwise, the IBM 8228 may be defective.

1) Bypass it again in order for the ring to remain operational.

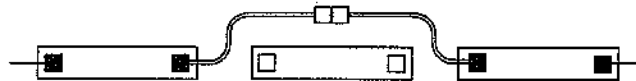

2) Go to "Replacing a Defective IBM 8228" on page 3-177.

5. Disconnect the observer terminal's lobe cable from the IBM 8228. Start your diagnostic tool on a device other than the observer terminal. (This device is the new observer terminal).

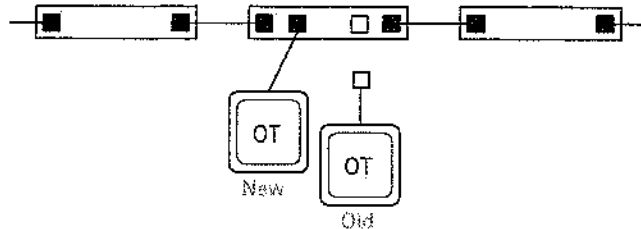

Determine the ring status.

a. If the new observer terminal indicates an error, the IBM 8228 may be defective.

1) Bypass it again (unless this is a single IBM 8228 ring).

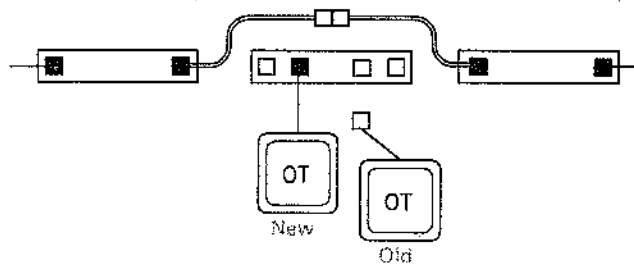

2) Go to "Replacing a Defective IBM 8228" on page 3-177.

b. Otherwise, continue with step 6.

6. Reconnect the disconnected lobe to a different lobe receptacle of the IBM 8228.

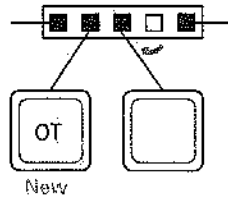

- a. If the observer terminal indicates that the ring is operational, continue with step 7.
- b. Otherwise, the lobe just reconnected to the IBM 8228 or the adapter may be defective.
  - 1) Disconnect the lobe just reconnected from the IBM 8228.

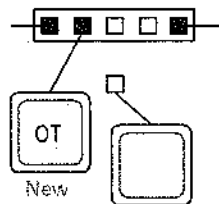

- 2) Reconnect all other cables.
- 3) Go to "Device and Lobe Error Isolation" on page 3-140.

7. Disconnect the lobe from the IBM 8228 and reconnect it to its original receptacle.

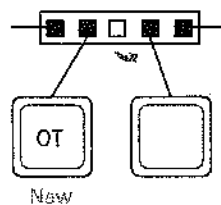

- a. If the observer terminal indicates that the ring is operational, the problem has disappeared. No further action is necessary.
- b. Otherwise, the IBM 8228 may be defective.
  - 1) Bypass it again (unless it is a single IBM 8228 ring).

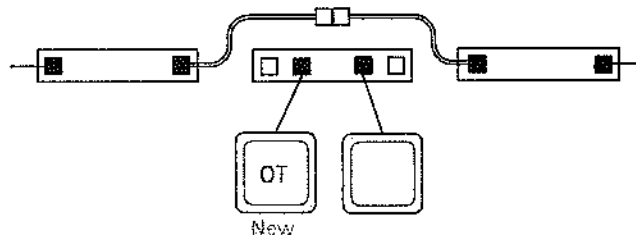

- 2) Go to "Replacing a Defective IBM 8228" on page 3-177.



## Isolation of an IBM 8228 for Remote Program Load

1. You were sent to this procedure because the entire ring consists of a single IBM 8228 or because there was a problem with an IBM 8228 (or one of its lobes) and it was bypassed. The IBM 8228 concerned is referred to below as the "suspected IBM 8228".
  - a. If you were sent here because the entire ring contains only a single IBM 8228, continue with step 2.
  - b. Otherwise, return the bypassed IBM 8228 to the ring by reconnecting the cables to the RI and RO receptacles, then continue with step 2.
2. At the suspected IBM 8228, disconnect a lobe cable (other than the observer terminal) if it is connected to this access unit.

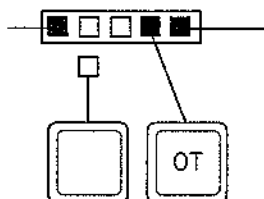

- a. If the observer terminal indicates that the ring is operational, the disconnected lobe, the adapter on that lobe, or its lobe logic in the access unit is defective. Go to step 6.
  - b. Otherwise, reconnect the lobe cable to the access unit, then continue with step 3.
3. Determine if there are more lobes.
  - a. If all lobes except the observer terminal (if on this IBM 8228) have been disconnected and reconnected, continue with step 4.
  - b. Otherwise, return to step 2 to test another lobe.
4. Check the location of the observer terminal.
  - a. If the observer terminal is connected to this IBM 8228, continue with step 5.
  - b. Otherwise, the IBM 8228 may be defective.
    - 1) Bypass it again.

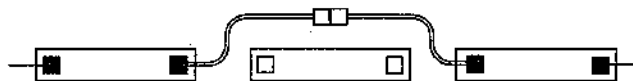

- 2) Go to "Replacing a Defective IBM 8228" on page 3-177.
5. Disconnect the observer terminal's lobe cable from the IBM 8228. Attempt to start another Remote Program Load device on the ring.
  - a. If the Remote Program Load is successful, continue with step 6.
  - b. Otherwise, the IBM 8228 may be defective.
    - 1) Bypass it again.

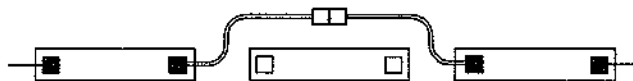

- 2) Go to "Replacing a Defective IBM 8228" on page 3-177.

6. Reconnect the disconnected lobe to a different lobe receptacle of the IBM 8228.

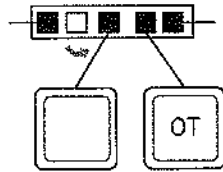

- a. If the observer terminal indicates that the ring is operational, continue with step 7.
  - b. Otherwise, the lobe just reconnected or its adapter is defective. Go to "Device and Lobe Error Isolation" on page 3-140.
7. Disconnect the lobe from the IBM 8228 and reconnect it to its original receptacle.

- a. If the observer terminal indicates that the ring is operational, the problem appears to have disappeared. No further action is necessary.
- b. Otherwise, the IBM 8228 may be defective.
  - 1) Bypass it again.



- 2) Go to "Replacing a Defective IBM 8228" on page 3-177.

---

## IBM 8228/Adapter Test

1. You have located an IBM 8228 that appears to be defective. However, there can be faults on the lobe that can make the IBM 8228 appear defective erroneously. This procedure will locate those faults.
  - a. Remove power from all devices attached to this IBM 8228.
  - b. Disconnect all lobe cables from the IBM 8228.
  - c. Locate an IBM 8228 Setup Aid (a setup aid is shipped with each IBM 8228) and insert into each lobe receptacle of this IBM 8228. You should leave it in each lobe receptacle for *at least 4 seconds*.
  - d. Select one of the devices that was connected to this IBM 8228 as an observer terminal. Reconnect its lobe cable to the proper lobe receptacle of the IBM 8228.
  - e. Apply power and start the diagnostic tool on the observer terminal.
    - 1) If the observer terminal attaches to the ring and indicates a ring status of "Normal," reconnect another lobe cable to the IBM 8228 and start the network application program on the device attached to that lobe. Continue with step 2.
    - 2) Otherwise, the IBM 8228 is defective. Go to "Replacing a Defective IBM 8228" on page 3-177.
2. Determine the ring status.
  - a. If the observer terminal now indicates "Normal," continue with step 3.
  - b. Otherwise, the IBM 8228 is defective. Go to "Replacing a Defective IBM 8228" on page 3-177.
3. Determine if there are any more lobe cables to reconnect.
  - a. If there are any lobe cables that have not been reconnected to this IBM 8228, re-connect another lobe cable to the IBM 8228 and start the network application program on the device attached to that lobe. Return to step 2.
  - b. Otherwise, remove power from one device on this IBM 8228 (other than the observer terminal), then continue with step 4.
4. Determine the ring status.
  - a. If the observer terminal now indicates "Normal," continue with step 5.
  - b. Otherwise, the adapter in the device just powered down or its lobe cabling is defective. Go to step 7.
5. Determine if power has been removed from all devices on this IBM 8228.
  - a. If power has been removed from all devices (except observer terminal), continue with step 6.
  - b. Otherwise, remove power from another device on this IBM 8228 (other than the observer terminal), then return to step 4.

6. Select one of the powered off devices to use as a new observer terminal and turn its power on.

Start the diagnostic tool in the new observer terminal.

Remove power from the old observer terminal.

Using the new observer terminal, determine ring status.

- a. If the ring status is "Normal," the problem has disappeared. Reconnect all cables to the IBM 8228. Restart the application programs on all devices. No further action is required.
  - b. Otherwise, the old observer terminal's adapter or its lobe cabling has a problem. Continue with step 7.
7. The following procedure isolates the problem located in a lobe (adapter or cables). One component of the lobe will be temporarily replaced with a spare or one from another (known to be working) lobe. For example, if a spare adapter is unavailable, swap the adapter with one in another device or swap the device connected to this lobe with one that is attached to a different lobe.

If the ring status on the observer terminal indicated "Normal" after replacing a component, then the component replaced was defective.

- a. Replace one of the lobe components (copper patch cable, white filter cable, if present, adapter, etc.)
- b. Disconnect the cable from IBM 8228 receptacle.
- c. Insert the IBM 8228 Setup Aid into the IBM 8228 receptacle for at least 4 seconds.
- d. Reconnect the lobe cable to the IBM 8228 receptacle.
- e. Start the network application on the device on this lobe.
- f. When the program has initialized and is attached to the ring, turn the device's power off.
  - 1) If the observer terminal now indicates "Normal," the component that was replaced is defective. Replace it permanently. Reconnect all cables to their proper receptacles and restart the programs on all lobes of this IBM 8228.
  - 2) If the observer terminal does not indicate "Normal," replace another component and perform these steps (a through h again) until all components have been replaced.
  - 3) If all components have been replaced and the ring status is still not "Normal," contact your network administrator or service supplier.

## Lobe Logic Isolation (Beaconing and Open Errors)

1. Determine the ring configuration.
  - a. If this ring contains devices with Remote Program Load installed, go to "Lobe Logic Isolation (Beaconing and Open Errors) for Remote Program Load" on page 3-136. If not, continue with step 1b.
  - b. If the ring contains more than one IBM 8228 and one has been bypassed, return the bypassed IBM 8228 to the ring by reconnecting the cables to the RI and RO receptacles, then go to step 2.
  - c. Otherwise, continue with step 2.
2. Connect the disconnected lobe to a different lobe receptacle of the IBM 8228. Restart the program on the device connected to the lobe just reconnected.

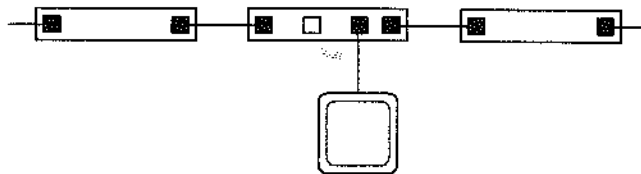

- a. If the program indicates an "Unable to Open Adapter" error, go to "Open Errors, Part I" on page 3-43.
  - b. Otherwise, continue with step 3.
3. Select a device as the observer terminal if one has not been selected. Start your network diagnostic tool on the observer terminal.
  - a. If the observer terminal indicates that the ring is operational, go to step 4.
  - b. Otherwise, the adapter on the lobe just reconnected or its lobe cable is defective.
    - 1) Disconnect the lobe cable from the IBM 8228 again and leave it disconnected.

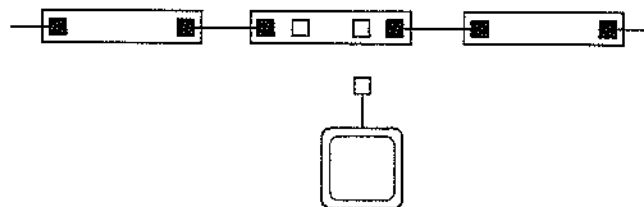

- 2) Go to "Device and Lobe Error Isolation" on page 3-140.

4. Disconnect the suspected lobe's cable from the IBM 8228 again. Reconnect it to its original receptacle and restart the program on the device connected to the lobe just reconnected.

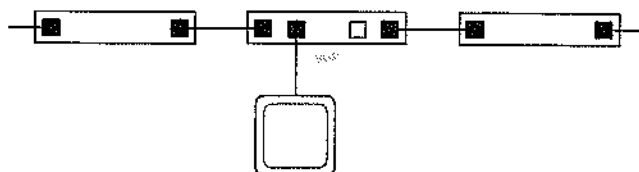

- a. If the observer terminal indicates that the ring is operational, the problem has disappeared. No further action is required.

b. Otherwise, the lobe logic in the IBM 8228 for this receptacle may be defective.

1) Bypass the IBM 8228 (if the ring has more than one IBM 8228).

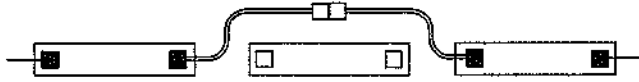

2) Go to "Replacing a Defective IBM 8228" on page 3-177 to replace the defective IBM 8228.

## Lobe Logic Isolation (Beaconing and Open Errors) for Remote Program Load

**Note:** These procedures may require that you find a certain device or component. See Appendix A for instructions.

1. Reconnect the disconnected lobe to a different receptacle on the IBM 8228 and restart the program on the device connected to the lobe just reconnected. Start a diagnostic program on the observer terminal and determine ring status.

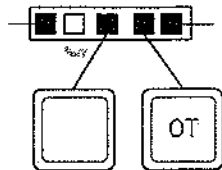

- a. If the observer terminal indicates that the ring is operational, go to step 2.
  - b. Otherwise, the adapter on the lobe just reconnected or its lobe cable is defective.
    - 1) Disconnect the lobe cable from the IBM 8228 again and leave it disconnected.
    - 2) Go to "Device and Lobe Error Isolation" on page 3-140.
2. Disconnect the suspected lobe's cable from the IBM 8228 again. Reconnect it to its original receptacle and restart the program on the device connected to the lobe just reconnected.
    - a. If the observer terminal indicates that the ring is operational, the problem has disappeared. No further action is required.
    - b. Otherwise, the lobe logic in the IBM 8228 for this receptacle is defective.
      - 1) Bypass the IBM 8228.
      - 2) Go to "Replacing a Defective IBM 8228" on page 3-177 to replace the defective IBM 8228.

## Lobe Logic Isolation, Soft Errors

**Note:** These procedures may require you to find a certain device or component. See Appendix A for instructions.

1. Determining the ring configuration.
  - a. If the suspected lobe has a device attached to it with Remote Program Load installed, go to "Lobe Logic Isolation, Soft Errors, for Remote Program Load" on page 3-138.
  - b. Otherwise, continue with step 2.
2. Disconnect the suspected lobe from the IBM 8228. Reconnect the disconnected lobe to a different receptacle of the IBM 8228.

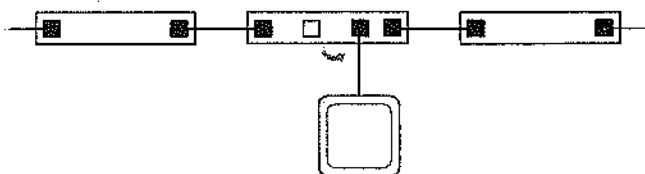

Restart the program on a device connected to the lobe just reconnected. Start your diagnostic tool on the observer terminal and determine ring status.

- a. If the device you have just restarted indicates errors, disconnect its lobe. Then go to "Device and Lobe Error Isolation" on page 3-140.
  - b. If the observer terminal indicates that the ring is operational, continue with step 3.
  - c. Otherwise, the adapter on the lobe just reconnected or its lobe cable is defective. Disconnect the lobe cable from the IBM 8228 again. Go to "Device and Lobe Error Isolation" on page 3-140.
3. Disconnect the suspected lobes cable from the IBM 8228 again. Reconnect it to its original receptacle and restart the program on a device connected to the lobe just reconnected.

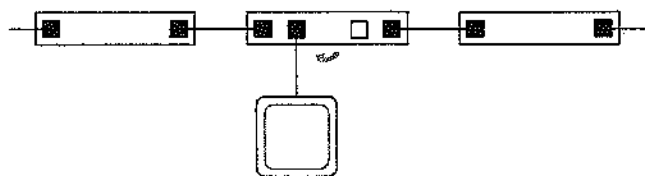

- a. If the observer terminal indicates that the ring is operational, the problem has disappeared. No further action is required.
- b. Otherwise, the lobe logic in the IBM 8228 for this receptacle is defective.
  - 1) Bypass the IBM 8228 if the ring has more than one IBM 8228.

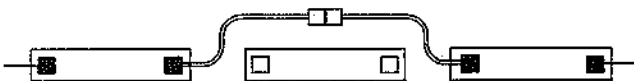

- 2) Go to "Replacing a Defective IBM 8228" on page 3-177 to replace the defective IBM 8228.



## Lobe Logic Isolation, Soft Errors, for Remote Program Load

**Note:** These procedures may require that you find a certain device or component. See Appendix A for instructions.

1. Disconnect the suspected lobe from the IBM 8228. Reconnect the disconnected lobe to a different receptacle of the IBM 8228.

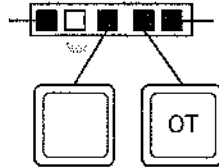

Attempt to start the device attached to the lobe that was reconnected.

- a. If the observer terminal indicates that the ring is operational, continue with step 2.
  - b. Otherwise, the adapter on the lobe just reconnected or its lobe cable is defective. Disconnect the lobe cable from the IBM 8228 again and leave it disconnected. Go to "Device and Lobe Error Isolation" on page 3-140.
2. Disconnect the suspected lobe cable from the IBM 8228 again. Reconnect it to its original receptacle and attempt to start the device attached to this lobe.
    - a. If the observer terminal indicates that the ring is operational, the problem has disappeared. No further action is required.
    - b. Otherwise, the lobe logic in the IBM 8228 for this receptacle is defective. Bypass the IBM 8228. Go to "Replacing a Defective IBM 8228" on page 3-177.



---

## Lobe Logic Isolation, NAUN's Lobe

1. Reconnect the NAUN's lobe cable to the same receptacle of the IBM 8228. Do **NOT** reset or restart the program that was running on the NAUN.
  - a. If the ring begins to beacon again, disconnect the lobe cable again. Then continue with step 2.
  - b. Otherwise, disconnect the cable again and go to "Lobe Logic Isolation (Beaconing and Open Errors)" on page 3-134.
2. The following procedure isolates the problem located in a lobe. One of the components of the lobe will be temporarily replaced with a spare or one from another lobe that is known to be working. For example, if a spare adapter is not available, you may swap one from another device or you may swap the device.
  - a. Insert the IBM 8228 Setup Aid that came with the IBM 8228 into the IBM 8228 receptacle to which the NAUN's lobe cable was connected. Leave it in for at least four seconds, then remove.
  - b. Temporarily replace one of the components in the NAUN's lobe. (Suggested order: adapter, white DGM-to-Type 3 Filter cable (if present), patch cables, in-wall cable).
  - c. Reconnect the NAUN's lobe cable to the same receptacle of the IBM 8228.
  - d. Restart the network application on the NAUN device.
  - e. Terminate the application program on the NAUN or remove power from the NAUN device. If you terminate the application program, make sure that it actually closes the adapter and attempts to de-insert from the ring.
  - f. Check the ring status.
    - 1) If it is beaconing, disconnect the lobe cable from the IBM 8228 and continue with step 2g below.
    - 2) If the ring status is "Normal," the component just replaced is defective. Following local procedures, obtain a permanent replacement and replace the failing component.
  - g. If all components have been tested, go to step 2h. Otherwise, return to step 2a and temporarily replace another component.
  - h. The IBM 8228 is defective. Go to "Replacing a Defective IBM 8228" on page 3-177.

---

## Device and Lobe Error Isolation

1. Check for white DGM-to-Type 3 Filter cables or Remote Program Load.
  - a. If this lobe contains white DGM-to-Type 3 Filter cables and/or the adapter in the device on this lobe has the Remote Program Load feature installed, go to step 6.
  - b. Otherwise, continue with step 2.
2. Make sure the lobe cable is disconnected from the IBM 8228 receptacle.
  - a. If adapter diagnostics are available for the adapter in the device on this lobe, continue with step 3.
  - b. Otherwise, go to step 6.
3. Run the adapter diagnostics and *return here regardless of error indication*.
  - a. If any errors are detected, continue with step 4.
  - b. Otherwise, go to step 6.
4. Disconnect the adapter cable from the faceplate or patch cable and run the adapter diagnostics again. *Return here regardless of error indication*.
  - a. If an error is detected now, the adapter or adapter cable is defective, go to "Adapter/Cable Isolation" on page 3-142.
  - b. Otherwise, reconnect the adapter cable to the faceplate or patch cable. Continue with step 5.
5. Replace one of the components (copper patch cables, adapter cable, DGM-to-Type 3 Filter cables, etc.) in the lobe.
  - a. Run the adapter diagnostics and *return here regardless of error indication*.
  - b. If the adapter diagnostics does not detect an error, the component just replaced is defective. Go to step 7.
  - c. If the adapter diagnostics still detects errors, repeat this step until the defective component is found or all components have been replaced.
  - d. If all components (including the adapter) have been replaced and the adapter diagnostics still fails, contact your network administrator or service supplier.
6. The following procedure isolates the problem located in a lobe. One component of the lobe will be temporarily replaced with a spare or one from another (known to be working) lobe. For example, if a spare adapter is unavailable, swap the adapter with one in another device or swap the device connected to this lobe with one that is attached to a different lobe.
  - a. If the ring status on the observer terminal indicated "Normal" after replacing a component, then the component replaced was defective.
  - b. Select a device to use as an observer terminal and start your diagnostic program on that device.
  - c. Reconnect the lobe cable to the IBM 8228 receptacle.
    - 1) Replace one of the lobe components (copper patch cable, adapter, DGM-to-Type 3 Filter cable, adapter cable, etc.).
    - 2) Start a network application on the device on the lobe.
    - 3) If the observer terminal now indicates "Normal," the component that was replaced is defective. Go to step 7.

- 4) If the observer terminal does not indicate "Normal," replace another component and perform these steps (c1 through 3 again) until all components have been replaced.
  - 5) If all components (including the adapter) have been replaced and the ring status is still not "Normal," contact your network administrator or service supplier.
7. The last component that was replaced is defective. Make the replacement permanent. Reconnect all cables to their proper receptacles. No further action is required.

## Adapter/Cable Isolation

**Note:** These procedures may require that you find a certain device or component. See Appendix A for instructions.

1. If you have already run the adapter diagnostics and have an error code displayed, go to step 3.  
Otherwise, continue with step 2.
2. Make sure that the adapter cable is disconnected from the network.
  - a. For the IBM Token-Ring Network PC Adapter Cable, make sure the other end of the cable is still connected to the adapter.
  - b. For the white DGM-to-Type 3 Filter cable, disconnect the cable from the adapter and connect the wrap plug that came with the cable to the adapter.
  - c. For adapters installed in IBM PS/2 computers, use the tests on the Reference Diskette to test the computer and the adapter.
  - d. For adapters installed in IBM PCs, use the diagnostics contained on the adapter diagnostic diskette to test the adapter.
  - e. If the diagnostics indicate a failure of the adapter tests, go to step 3.
  - f. If an error occurs with some other component of the system, refer to the documentation for the test that failed.
  - g. If no errors are detected by the diagnostics, go to step 17.
3. The five-digit error codes on the display panel begin with 166 if you are testing the primary adapter or 167 if you are testing the alternate adapter. The remaining two digits indicate the type of error. For example, 16690 means an Adapter Card Test failure on the primary adapter. The chart below lists the last two digits of the error code.

The Ax, Cx, Dx, Ex, or Fx codes are for the IBM PC and IBM PS/2 (models with PC I/O bus) adapters. The 8x and 9x codes are for the IBM PS/2 models with MICRO CHANNEL<sup>1</sup> architecture.

Locate the last two digits of your error code in the chart below and determine which step to go to next.

Error Code	Meaning	Go to:
---80	Invalid testing mode requested	Step 4
---81	Primary/alternate adapter not present	Step 5
---84	Incompatible Adapter Support Code	Step 6
---85	Configuration compare failure	Step 7
---90	Adapter card test failure	Step 8
---91	Open phase test failure	Step 9
---92	Computer problem	Step 11
---93	Transmit/receive test failure	Step 9

<sup>1</sup> Micro Channel is a trademark of International Business Machines Incorporated.

Error Code	Meaning	Go to:
---99	General error	Step 8
---F0	Invalid testing mode requested	Step 12
---F1	Primary/alternate adapter not present	Step 13
---F2	Adapter support code not found	Step 14
---F3	Diskette read error	Step 15
---F4	Incompatible adapter support code	Step 16
---E0	Adapter card test failure	Step 8
---D0	Open phase test failure	Step 9
---C0	Computer problem	Step 11
---A0	Transmit/receive test failure	Step 9

4. The adapter diagnostics have received a test request from the Diagnostic Control Program which it cannot interpret. One reason may be that diagnostics or the control program on the backup Reference diskette has been damaged.

Using the adapter Installation and Testing Instructions, repeat the procedure to update the backup copy of the Reference diskette. Then re-run the diagnostics. If the errors still occur, see your place of purchase of the adapter.

5. The selected adapter is not present or cannot be detected by the diagnostics.
  - a. Make sure the adapter is firmly seated in its slot.
  - b. Check the configuration that you have established.
  - c. Run the diagnostics again. If the failure persists, contact your place of purchase of the adapter.

6. The Adapter Support Interface code on the Reference diskette and this version of the diagnostics are incompatible. One reason may be that diagnostics or the control program on the backup Reference diskette has been damaged.

Using the adapter Installation and Testing Instructions, repeat the procedure to update the backup copy of the Reference diskette. Then re-run the diagnostics. If the error still occurs, see your place of purchase of the adapter.

7. The diagnostics have detected an error while verifying the configuration.
  - a. Make sure the adapter is firmly seated in its slot.
  - b. Check the configuration that you have established.
  - c. Run the diagnostics again. If the failure persists, contact your place of purchase of the adapter.
8. The adapter diagnostics have detected a failure during initialization of the adapter.

- a. Make sure the adapter is firmly seated in its slot.
- b. Check the configuration that you have established.
- c. Run the diagnostics again. If the failure persists, replace the adapter.

9. For adapters using the IBM Token-Ring Network PC Adapter Cable, go to step 10.

For those using the white DGM-to-Type 3 Filter cable, the diagnostics have detected a failure of the adapter card. Replace the card.

10. Temporarily replace the adapter cable with a spare working cable.
  - a. Re-run the adapter diagnostics. If the diagnostics fail again, the adapter is defective. Replace the card.
  - b. Otherwise, the adapter cable was defective. Replace the cable.
11. The computer has detected an error. Using the test on the Reference diskette, run diagnostics on the computer and follow the instructions provided by those diagnostics.

12. The adapter diagnostics have received an invalid test request from the Diagnostic Control Program. One reason may be that you have selected Telephone Twisted-Pair while the adapter is set to run at 16 Mbps. This configuration is not supported.

Another reason may be that diagnostics or the control program on your adapter diagnostic diskette has been damaged. If you are using a working copy of the IBM Token-Ring Network PC Adapter Diagnostics, recopy the `DIAGS.COM` file from the original to your working copy diskette. If the problem continues or if you are using the original copy of the IBM Token-Ring Network PC Adapter Diagnostics, see your place of purchase of the adapter.

13. The selected adapter is not present or cannot be detected by the diagnostics.
  - a. Make sure the adapter is firmly seated in its slot.
  - b. Make sure the switches on the card are set correctly.
  - c. Run the diagnostics again. If the failure persists, contact your place of purchase of the adapter.
14. The adapter diagnostics cannot find a copy of the Adapter Support Interface on the default drive.

If you are using a working copy of the IBM Token-Ring Network PC Adapter Diagnostics, recopy the `TOKREUI.COM` file from the original to your working copy diskette. If the problem continues or if you are using the original copy of the IBM Token-Ring Network PC Adapter Diagnostics, run the diagnostics provided with your computer to determine if the diskette drive is operating properly.

15. The adapter diagnostics were unable to load the Adapter Support Interface from the default drive.

If you are using a working copy of the IBM Token-Ring Network PC Adapter Diagnostics, recopy the `TOKREUI.COM` file from the original to your working copy diskette. If the problem continues or if you are using the original copy of the IBM Token-Ring Network PC Adapter Diagnostics, run the diagnostics provided with your computer to determine if the diskette drive is operating properly.

16. The Adapter Support Interface code on the Reference diskette and this version of the diagnostics are incompatible. One reason may be that diagnostics or the control program on your adapter diagnostic diskette has been damaged.

If you are using a working copy of the IBM Token-Ring Network PC Adapter Diagnostics, recopy the `TOKREUI.COM` file from the original to your working

copy diskette. If the problem continues or if you are using the original copy of the IBM Token-Ring Network PC Adapter Diagnostics, run the diagnostics provided with your computer to determine if the diskette drive is operating properly.

17. Run the diagnostics again. If no errors are detected, the adapter appears to be operational.
  - a. If this is a new adapter, it is ready to be connected to the network.
  - b. Otherwise, reconnect the adapter to the network and resume normal operation.



---

## Excessive Ring Error Reports

1. Check ring configuration.
  - a. If this ring has been reconfigured recently for any reason, such as to add new devices, continue with step 2.
  - b. Otherwise, go to step 3.
2. See "Determining Ring Size" in the *IBM Token-Ring Network Introduction and Planning Guide*. Use the ring cabling charts to determine the size of the current ring and verify that it does not exceed the ring size limitations.
  - a. If the current ring does not exceed the ring size limitations, continue with step 3.
  - b. Otherwise, notify the network administrator and/or planner that the ring size exceeds the ring size limits.
3. The excessive ring error reports may be caused by a data receptacle in the main ring path that is not fully seated or that has been disconnected by mistake. Using the Ring Sequence Chart, check that each connector in the main ring path is connected to the correct receptacle and is fully seated.

**Note:** The ring will remain operational while performing this check.

- a. If the excessive ring error reports are still occurring, continue with step 4.
  - b. Otherwise, recovery and isolation are complete.
4. Follow the instructions under "Resolving Problems in a Newly Installed Network" in the *IBM Token-Ring Network Installation Guide*.

**Note:** The ring will not be operational while you are performing that procedure. Return to this step after performing that procedure.

- a. If the excessive ring error reports are still occurring, these procedures have failed to locate the problem. Go to "Manual Procedure, Part 1" on page 3-59 to continue.
- b. Otherwise, recovery and isolation are complete.

## Session Errors, Part 1

**Note:** These procedures may require that you find a certain device or component. See Appendix A for instructions.

1. Check the location of devices involved in the problem.
  - a. If the devices involved in the sessions errors are on the same ring, continue with step 2.

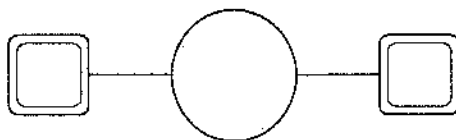

- b. Otherwise, go to "Session Errors, Part 2" on page 3-149.

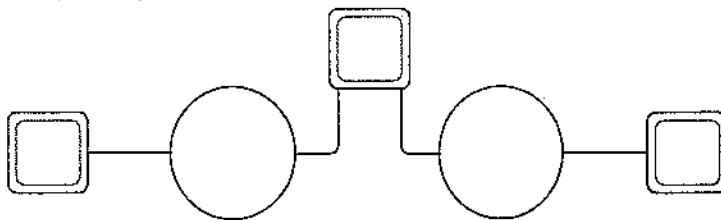

2. Check for Network Manager.
  - a. If the IBM Token-Ring Network Manager is available on the ring involved in the problem, continue with step 3.
  - b. Otherwise, go to "Session Errors, Part 3" on page 3-150.
3. Start the Network Manager on a device on the same ring as the devices involved (unless it is already active on that ring) and determine the ring status.
  - a. If the ring status is "Normal," continue with step 4.
  - b. Otherwise, using the status indicated by the Network Manager, go to "Starting the Problem Determination Procedures" on page 3-5 and restart problem determination.
4. Determine the addresses or symbolic names of the adapters in the devices involved. (Use the locator charts and/or configuration charts.) Using the Path Test function, verify that the adapters can communicate on the hardware level.
  - a. If the Path Test was successful, continue with step 5.
  - b. Otherwise, go to step 6.
5. Verify that the application programs on the devices are properly configured and are using the correct names and/or addresses.
  - a. If the configuration, names and/or addresses are all correct, this procedure has failed to locate the problem. Notify the network administrator and/or contact your software supplier.
  - b. Otherwise, correct the configuration, name, or address and go to "Session Errors, Part 4" on page 3-151.
6. Run all available diagnostics on the adapter in one of the devices.
  - a. If the device indicates an adapter error, follow local procedures and have the device serviced.
  - b. Otherwise, continue with step 7.

7. Check for more devices.
  - a. If the adapter diagnostics have been run on all devices involved in the session errors, go to "Session Errors, Part 4" on page 3-151.
  - b. Otherwise, return to step 6 and run the adapter diagnostics on another adapter.

---

## Session Errors, Part 2

1. Check for the IBM Token-Ring Network Manager on all rings involved in the session errors.
  - a. If the Network Manager is available on ALL rings involved in the session errors, continue with step 2.
  - b. Otherwise, go to "Session Errors, Part 3" on page 3-150
2. Verify that all involved rings are operating. Start the Network Manager on all rings that are involved in the problem.
  - a. If ring status of all involved rings is "Normal," continue with step 3.
  - b. Otherwise, using the symptom indicated by the Network Manager on each failing ring, go to "Starting the Problem Determination Procedures" on page 3-5. and resolve the problem on each failing ring. Then go to "Session Errors, Part 4" on page 3-151.
3. Using the Adapter Profile function of the Network Manager on the ring with each involved device, verify that the involved devices are active on the network.
  - a. If any of the involved devices is not active on the ring, start the application programs in the device(s) that is not active, then go to "Session Errors, Part 4" on page 3-151.
  - b. Otherwise, continue with step 4.
4. Verify that the bridge function in all bridges involved in the problem has been correctly configured.
  - a. If a bridge function has not been configured correctly in any bridge, correct the configuration and retry the operation. Then go to "Session Errors, Part 4" on page 3-151.
  - b. Otherwise, continue with step 5.
5. Using the problem determination procedures provided with each bridge device, run all available diagnostics on the adapter(s) in each of the involved bridge devices.
  - a. If the diagnostics indicates an error, correct the problem following the instructions provided by the diagnostic program or its documentation. Then go to "Session Errors, Part 4" on page 3-151.
  - b. Otherwise, this procedure has failed to locate the problem. Notify the network administrator and/or contact your software supplier.

---

## Session Errors, Part 3

1. Check the configuration tables, files, addresses, and setup of the application programs in the devices involved in the problem.
  - a. If any of the above is not correct, correct the problem and then go to "Session Errors, Part 4" on page 3-151.
  - b. Otherwise, continue with step 2.
2. Run all available diagnostics on the adapter in one of the devices involved.
  - a. If the device indicates an adapter error follow local procedures and have the adapter serviced. Then go to "Session Errors, Part 4" on page 3-151.
  - b. Otherwise, continue with step 3.
3. Run all available diagnostics on the adapter in one of the other devices involved.
  - a. If the device indicates an adapter error, follow local procedures and have the device serviced. Then go to "Session Errors, Part 4" on page 3-151.
  - b. Otherwise, continue with step 4.
4. Check for more devices.
  - a. If the adapter diagnostics have been run on all devices involved in the session errors, go to step 5.
  - b. Otherwise, return to step 3 and run the adapter diagnostics on another adapter.
5. Check for bridges.
  - a. If the involved devices are on the same ring, go to "Session Errors, Part 4" on page 3-151.
  - b. Otherwise, continue with step 6.
6. Verify that the bridge function in all bridges involved in the problem has been correctly configured.
  - a. If a bridge function has not been configured correctly in any bridge, correct the configuration. Then go to "Session Errors, Part 4" on page 3-151.
  - b. Otherwise, continue with step 7.
7. Using the problem determination procedures provided with each bridge device, run all available diagnostics on the adapters in each of the involved bridge devices.
  - a. If the diagnostics indicate an error, correct the problem following the instructions provided by the diagnostics program or its documentation. Then go to "Session Errors, Part 4" on page 3-151.
  - b. Otherwise, go to "Session Errors, Part 4" on page 3-151.

---

## Session Errors, Part 4

Restart your network application program and attempt to communicate on the ring on each of the devices involved in the session errors.

1. If the ring is operational (no errors), the problem has been resolved or has disappeared.
2. If session errors are still occurring, this procedure has failed to locate the problem. Notify the network administrator and/or contact your software supplier.
3. If any of the devices indicate an error other than a session type error ("only adapter on the ring" is an error if other adapters are active on the ring), correct that error by following the instructions in the program documentation and/or go to "Starting the Problem Determination Procedures" on page 3-5. After the problem is resolved, return to this procedure and repeat step 1.

---

## Errors When Processing Data Received from Other Devices

The following procedure may help you resolve miscellaneous errors that occur when a device is processing files or data that was received from another device on the ring. If the files or data are retransmitted or reprocessed, the errors may reoccur at different times and places in the process. These errors may include but are not limited to the following errors:

- Output is formatted incorrectly when data or files received from other devices on the ring are printed.
- Output is incorrect when data or files received from other devices on the ring are processed.
- Output is formatted incorrectly when data or files received from other devices on the ring are displayed.
- Programs received from other devices on the ring do not run correctly.
- Data received from other devices have invalid or incorrect values.

**Note:** These procedures may require that you find a certain device or component. See Appendix A for instructions.

1. Determining the ring configuration.
  - a. If this ring contains devices that have Remote Program Load installed, go to "Errors When Processing Data Received from Other Devices for Remote Program Load" on page 3-154.
  - b. Otherwise, continue with step 2.
2. Checking the source of data.
  - a. If the errors occur when processing data or files received from a single device, continue with step 3.
  - b. Otherwise, go to step 5.
3. Restart the programs on the device that sent the data and the device that received the data.
  - a. If either device indicates any initialization or open errors, follow local procedures and have the adapter and its device with the error serviced.
  - b. Otherwise, continue with step 4.
4. You should suspect the adapter in the device that transmitted the data or files. Transmit the same data or files from the suspected device to a third device on the ring. At the third device, process the data or files.
  - a. If errors occur when processing the data or files on the third device, the suspected transmitting adapter or its device is defective. Follow local procedures and have the device and its adapter serviced.
  - b. Otherwise the adapter or the device that originally received the data or files is defective. Follow local procedures and have the device and its adapter serviced.

5. Suspect the device (or its adapter) that received and processed the data or files. Restart the program on the device.
  - a. If the device indicates any initialization or open errors, follow local procedures and have the adapter and its device serviced.
  - b. Otherwise, continue with step 6.
6. Swap adapters.
  - a. If possible, swap the suspected adapter (or have it swapped) with an adapter in another device on the ring. Then continue with step 7.
  - b. Otherwise, this procedure has failed to locate the problem. Notify the network administrator and/or go to "Manual Procedure, Part 1" on page 3-59.
7. Send data or files from other devices to both of these devices. Process the data received on both devices.
  - a. If the errors reoccur on the same device, this adapter is not the problem. Return the adapters to the correct devices. Contact your service supplier for the device experiencing the errors.
  - b. If the errors now occur on the device that now has the suspected adapter, the suspected adapter is defective. Follow local procedures and have it serviced. Return the other adapter to the correct device.



---

## Errors When Processing Data Received from Other Devices for Remote Program Load

The following procedure may help you resolve miscellaneous errors that occur when a device is processing data or files received from another device on the ring.

If the data or files are retransmitted or reprocessed, the errors may reoccur at different times and places in the process. These errors may include but are not limited to the following errors:

- Output is formatted incorrectly when data or files received from other devices on the ring are printed.
- Output is incorrect when data or files received from other devices on the ring are processed.
- Output is formatted incorrectly when data or files received from other devices on the ring are displayed.
- Programs received from other devices on the ring do not run correctly.
- Data received from other devices have invalid and/or incorrect values.

**Note:** These procedures may require that you find a certain device or component. See Appendix A for instructions.

1. Check source of data.
  - a. If the errors occur when processing data or files received from a single device, continue with step 2.
  - b. Otherwise, go to step 4.
2. Perform Remote Program Load on both devices.
  - a. If the Remote Program Load device indicates any initialization or open errors, follow local procedures to have the adapter/device with the error serviced.
  - b. Otherwise, continue with step 3.
3. Suspect the adapter in the device that transmitted the data or files. Transmit the same data or files from the suspected adapter to a third device on the ring. At the third device, process the data or files.
  - a. If errors occur when processing the data or files on the third device, the suspected adapter is defective. Follow local procedures to have the device and/or adapter serviced.
  - b. Otherwise, the adapter in the device that originally received the data or files is defective. Follow local procedures to have the device and/or adapter serviced.
4. Suspect the device (or its adapter) that received and processed the data or files. Perform a Remote Program Load on that device.
  - a. If the Remote Program Load device indicates any initialization or open errors, follow local procedures to have the adapter and/or device with the error serviced.
  - b. Otherwise, continue with step 5.

5. Swap adapters.
  - a. If possible, swap the suspected adapter (or have it swapped) with an adapter in another device on the ring. Then continue with step 6.
  - b. Otherwise, this procedure has failed to locate the problem. Notify the network administrator and/or go to "Manual Procedure, Part 1" on page 3-59.
6. Send data or files from other devices to both of these devices. Process the data received on both devices.
  - a. If the errors reoccur on the same device, this adapter is not the problem. Return the adapters to the correct devices. Contact your service supplier for the device experiencing the errors.
  - b. If the errors now occur on the device that now has the suspected adapter, the suspected adapter is defective. Follow local procedures to have it serviced. Return the other adapter to the correct device.
  - c. Otherwise, this procedure has failed to locate the problem. Notify the network administrator and/or go to "Diagnosing Difficult Lobe Problems for Remote Program Load" on page 3-169.

## Isolation of an Optical Fiber Ring Segment, Part 1

1. Using the ring sequence charts determine if there are any IBM 8219 Optical Fiber Repeaters that are located between this wiring closet and the next downstream wiring closet.
  - a. If there are no IBM 8219s between the wiring closets, go to "Isolation of an Optical Fiber Ring Segment, Part 2" on page 3-159.
  - b. Otherwise:
    - 1) Return to the first IBM 8219 in the suspected ring segment and reconnect the copper patch cable to the data receptacle of the IBM 8219.
    - 2) Go to the first (in ring sequence) pair of IBM 8219s that are located between the wiring closets. Then continue with step 2.
2. Observe each IBM 8219's power indicator.
  - a. If the Power On indicators on both IBM 8219s are lit, continue with step 3.

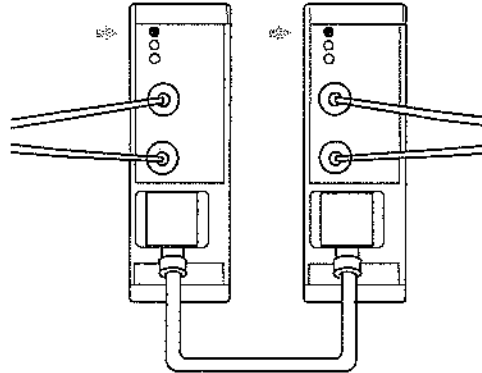

- b. Otherwise, go to "IBM 8218/8219/8220 Power Problems" on page 3-163.
3. Disconnect the yellow crossover patch cable from the data receptacle of the first (upstream) IBM 8219.

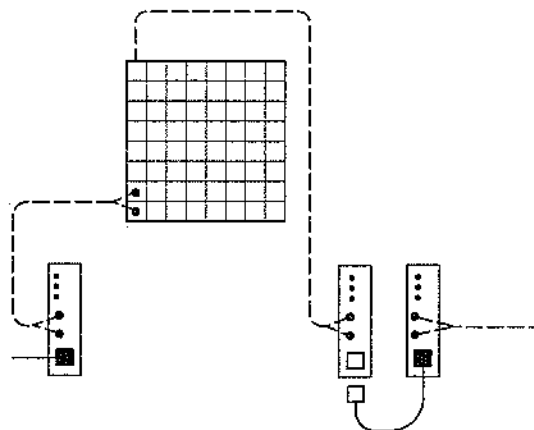

- a. If the ring is now operational, reconnect the yellow crossover patch cable to the data receptacle of the IBM 8219. Then continue with step 4.

- b. Otherwise, the segment between this location and the next upstream IBM 8219 location is defective.
  - 1) Return to the next upstream IBM 8219 location and disconnect the copper patch cable from the data receptacle of the last (in ring sequence) IBM 8219 at that location.
  - 2) The defective segment is now disconnected on both ends. Reconnect all other cables that have been disconnected.
  - 3) Then go to "Isolation of an Optical Fiber Ring Segment, Part 2" on page 3-159.

4. Using a spare yellow crossover patch cable, temporarily replace the yellow crossover patch cable between the two IBM 8219s at this location.

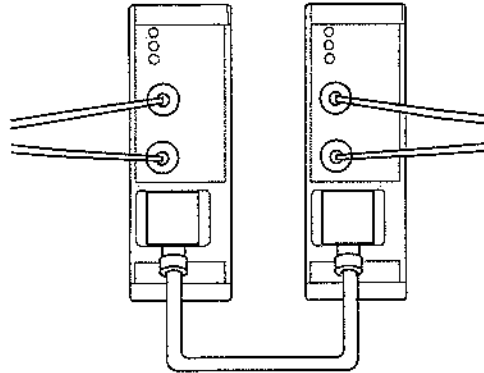

- a. If the ring is now operational, the removed patch cable is defective.
  - 1) Obtain a new one for future use.
  - 2) Reconnect all other cables that were disconnected.
  - 3) No further action is required.
- b. Otherwise, remove the spare patch cable and reconnect the original cable to the first IBM 8219 only.

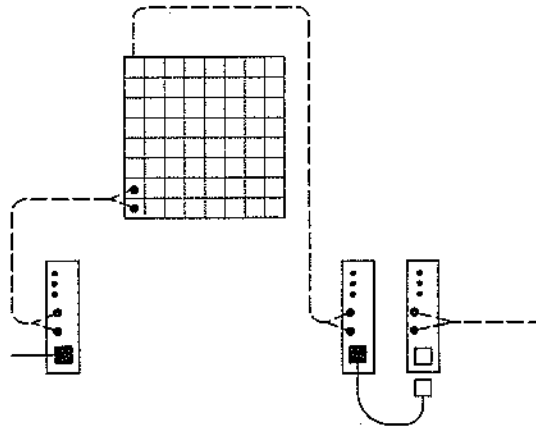

Then continue with step 5.

5. Using the Ring Sequence Charts, determine if there are any more IBM 8219s that are located between this location and the next wiring closet.
  - a. If there are no IBM 8219s between this location and the next wiring closet, the segment between this location and the next wiring closet is defective. Go to "Isolation of an Optical Fiber Ring Segment, Part 2" on page 3-159.
  - b. Otherwise:
    - 1) Reconnect the copper patch cable to the data receptacle of the second IBM 8219 at this location.
    - 2) Go to the next downstream (in ring sequence) pair of IBM 8219s.
    - 3) Return to step 2 to test the next pair of IBM 8219s.

## Isolation of an Optical Fiber Ring Segment, Part 2

1. Go to the first IBM 8219 (in ring sequence) in the suspected ring segment. Reconnect the copper patch cable to the data receptacle of the IBM 8219. Disconnect the optical fiber BNC-to-biconic patch cable from the Transmit (Tx) and Receive (Rx) receptacles on the IBM 8219. Connect an optical fiber test cable to the Tx and Rx receptacles of the IBM 8219.

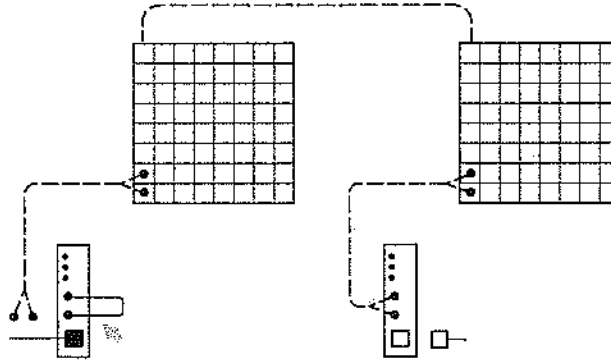

- a. If the observer terminal's ring is now operational, continue with step 2.
  - b. Otherwise, the IBM 8219 is defective.
    - 1) Disconnect the cables from the defective IBM 8219.
    - 2) Go to "Replacing a Defective IBM 8219" on page 3-179 and replace the defective IBM 8219.
2. Remove the optical fiber test cable and reconnect the cable to the Tx and Rx receptacles of the IBM 8219. Using a spare optical fiber BNC-to-biconic patch cable, temporarily replace the cable from the IBM 8219 to the distribution panel.
    - a. If the observer terminal's ring is now operational, the cable just removed is defective.
      - 1) Obtain a new optical fiber BNC-to-biconic patch cable for future use.
      - 2) Reconnect all cables that have been disconnected.
      - 3) No further action is required.
    - b. Otherwise:
      - 1) Remove the spare optical fiber BNC-to-biconic patch cable and reconnect the original cable between the IBM 8219 and the distribution panel.

- 2) Disconnect the copper patch cable from the data receptacle of the IBM 8219.

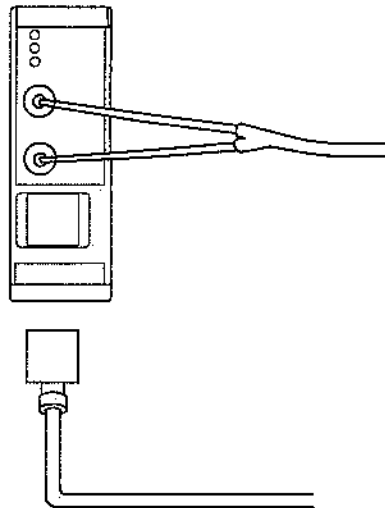

- 3) Continue with step 3.

3. Go to the next downstream IBM 8219 (at the other end of the optical fiber ring segment). Reconnect the copper patch cable to the data receptacle of the IBM 8219. Disconnect the optical fiber cable from the Tx and Rx receptacles of the IBM 8219. Connect the optical fiber test cable to the Tx and Rx receptacles.

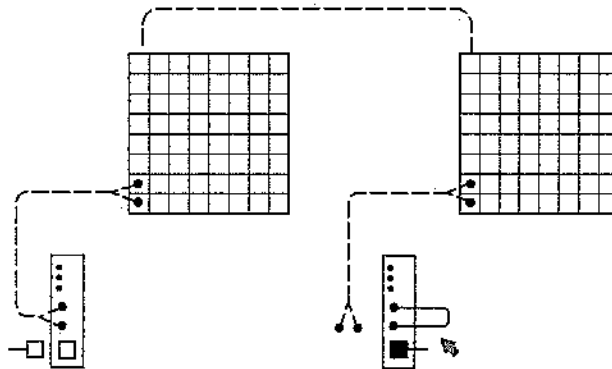

- a. If the observer terminal's ring is now operational, continue with step 4.
  - b. Otherwise, the IBM 8219 is defective.
    - 1) Disconnect the cables from the defective IBM 8219.
    - 2) Go to "Replacing a Defective IBM 8219" on page 3-179 and replace the defective IBM 8219.
4. Remove the optical fiber test cable and reconnect the cables to the Tx and Rx receptacles. Using a spare optical fiber BNC-to-biconic patch cable, temporarily replace the cable from the IBM 8219 and the distribution panel.
    - a. If the observer terminal's ring is operational now, the cable just removed is defective.
      - 1) Obtain a new optical fiber BNC-to-biconic patch cable for future use.
      - 2) Reconnect all other cables that have been disconnected.
      - 3) No further action is required.

b. Otherwise, the optical fiber cable between the two wiring closets is defective.

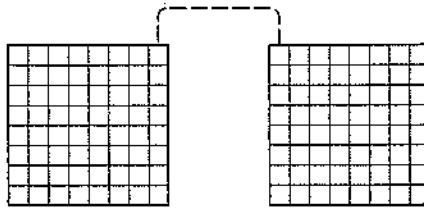

- 1) Remove the spare optical fiber BNC-to-biconic cable and reconnect the original cable between the IBM 8219 and the distribution panel.
- 2) Disconnect the copper patch cable from the data receptacle of the IBM 8219.
- 3) Go to the *IBM Cabling System Planning and Installation Guide* to repair the defective optical fiber cable.



## Isolation of IBM 8218s

1. Bypass the first IBM 8218 by disconnecting the copper patch cables from the RI and RO receptacles and connecting the two cables together.

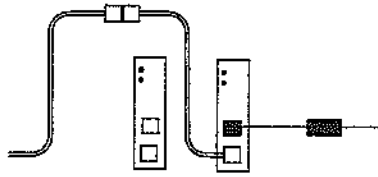

- a. If the observer terminal's ring is now operational, the bypassed IBM 8218 is defective. Go to "Replacing a Defective IBM 8218" on page 3-178 to replace it.
  - b. Otherwise, continue with step 2.
2. Disconnect the copper patch cable from the RI receptacle of the second IBM 8218 and reconnect that cable to the RI receptacle of the first IBM 8218. Disconnect the copper patch cable from the RO receptacle of the second IBM 8218 and reconnect that cable to the RO receptacle of the first IBM 8218.

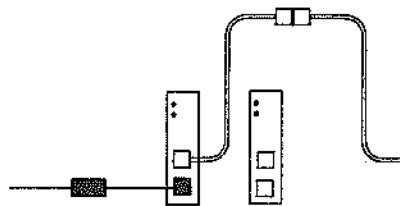

- a. If the observer terminal's ring is now operational, the bypassed IBM 8218 is defective. Go to "Replacing a Defective IBM 8218" on page 3-178 to replace it.
  - b. Otherwise, continue with step 3.
3. Disconnect the two copper patch cables that are connected together and reconnect them to the IBM 8218. Refer to the IBM 8218 Cabling Chart for this pair of IBM 8218s to ensure the cables are properly reconnected. Using a spare yellow crossover patch cable, temporarily replace the cable between the two IBM 8218s.
    - a. If the observer terminal's ring is now operational, the cable just replaced is defective.
      - 1) Make sure all other cables have been reconnected properly.
      - 2) Recovery and isolation are complete.
    - b. Otherwise, this procedure has failed to locate the problem. Notify the network administrator and/or go to "Manual Procedure, Part 1" on page 3-59.

## IBM 8218/8219/8220 Power Problems

1. You have located an IBM 8218, IBM 8219 or an IBM 8220 whose Power On indicator is off.
  - a. If the IBM 8218, IBM 8219 or IBM 8220 is installed in a rack mounting assembly, then go to step 5.
  - b. Otherwise, continue with step 2.
2. Reseat the IBM 8218, IBM 8219 or IBM 8220 power cord in the receptacle on the unit and at the wall power outlet.
  - a. If reseating corrected the problem, go to step 12.
  - b. Otherwise, continue with step 3.
3. Temporarily connect the IBM 8218, IBM 8219 or IBM 8220 to the wall power outlet using a power cord that is known to be good.

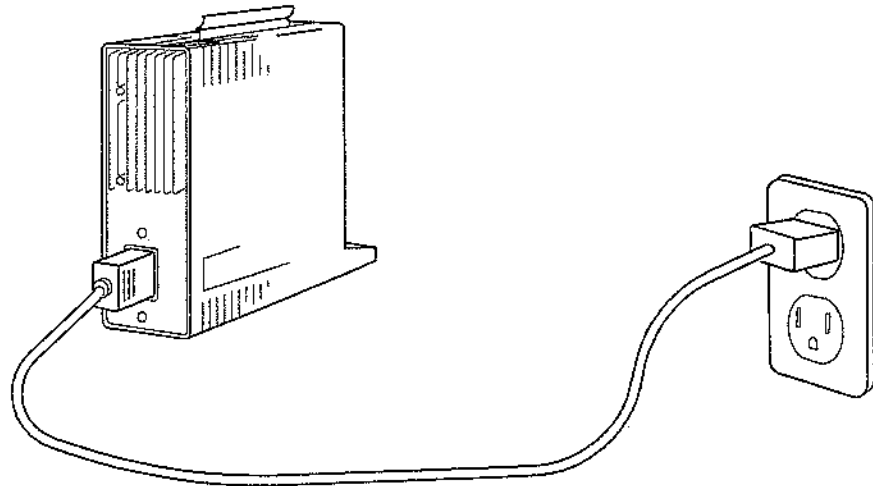

- a. If the Power On indicator comes on when using the good power cord, the original cord is defective.
    - 1) Obtain a new cord and replace the defective cord.
    - 2) Then go to step 12.
  - b. Otherwise, continue with step 4.
4. Have the power source checked by a qualified person. (A lamp or other portable device may be used to check the power source.)
  - a. If the power source is defective, have the power source repaired by a qualified person. Then go to step 12.
  - b. Otherwise, the IBM 8218, IBM 8219 or IBM 8220 is defective.
    - 1) To replace an IBM 8218, go to "Replacing a Defective IBM 8218" on page 3-178. Return to step 12 of this procedure after replacing the defective unit.
    - 2) To replace an IBM 8219, go to "Replacing a Defective IBM 8219" on page 3-179. Return to step 12 of this procedure after replacing the defective unit.
    - 3) To replace an IBM 8220, go to "Replacing a Defective IBM 8220" on page 3-180. Return to step 12 of this procedure after replacing the defective unit.

5. Observe the Power On indicators on any other devices in the same rack mounting assembly.

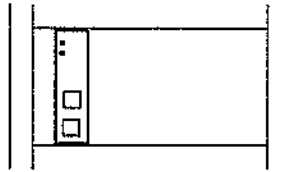

- a. If there are no other devices in the same rack mounting assembly, go to step 7.
  - b. If the Power On indicators on the other devices in the same rack mounting assembly are all lit, go to step 9.
  - c. Otherwise, continue with step 6.
6. Observe the Power switch on the rack mounting assembly.



- a. If the switch is in the On position, continue with step 7.
  - b. Otherwise, go to step 11.
7. Remove one IBM 8218, IBM 8219 or IBM 8220 from the rack mounting assembly. Disconnect the power cord from the rack mounting assembly and connect it directly to the IBM 8218, IBM 8219 or IBM 8220 just removed from the rack mounting assembly.
    - a. If the Power On indicator on the IBM 8218, IBM 8219 or IBM 8220 is lit, the rack mounting assembly is defective. Obtain a new rack mounting assembly and replace the defective one. After replacing the defective rack mounting assembly, return to step 12.
    - b. If the Power On indicator on the IBM 8218, IBM 8219 or IBM 8220 still does not come on, the power cord or power source is defective. Continue with step 8.
  8. Have the power source checked by a trained person. (A lamp or other portable device may be used to check the power source.)
    - a. If the power source is defective, have the power source repaired by a trained person. Then go to step 12.
    - b. Otherwise, the power cord is defective. Obtain a new power cord and replace the defective one. Then go to step 12.
  9. Reseat the IBM 8218, IBM 8219 or IBM 8220 (the one with its Power On indicator off) in the rack mounting assembly.
    - a. If the Power On indicator comes on, go to step 12.
    - b. Otherwise, continue with step 10.

10. Remove the IBM 8218, IBM 8219 or IBM 8220 (the one with its Power On indicator off) from the rack mounting assembly and move it to another position in the rack mounting assembly.
  - a. If the Power On indicator still does not come on, the IBM 8218 or IBM 8219 is defective.
    - 1) To replace an IBM 8218, go to "Replacing a Defective IBM 8218" on page 3-178. Return to step 12 after replacing the defective unit.
    - 2) To replace an IBM 8219, go to "Replacing a Defective IBM 8219" on page 3-179. Return to step 12 after replacing the defective unit.
    - 3) To replace an IBM 8220, go to "Replacing a Defective IBM 8220" on page 3-180. Return to step 12 after replacing the defective unit.
  - b. Otherwise, the rack mounting assembly is defective. Obtain a new rack mounting assembly and replace the defective one. After replacing the defective rack mounting assembly, go to step 12.
11. Check with the network administrator before turning the switch on. If the network administrator approves, turn the switch to the On position.
  - a. If the Power On indicators on all IBM 8218, IBM 8219, and IBM 8220s in this rack mounting assembly are now lit, continue with step 12.
  - b. Otherwise, return to step 1 of this procedure.
12. Make sure all cables have been reconnected correctly as indicated by the appropriate cabling charts. Using the IBM Token-Ring Network Ring Diagnostic, IBM Token-Ring Network Manager, or an application program, determine the ring status.
  - a. If the ring is operational, recovery, isolation, and repair are complete. No further action is required.
  - b. Otherwise, using the current ring status, go to "Starting the Problem Determination Procedures" on page 3-5.

---

## Diagnosing Difficult Ring Problems

This procedure is intended to provide assistance when all the other procedures in this manual have failed to locate the fault(s) causing the ring to fail.

1. Verify that your network configuration meets all of the cabling rules listed in the *IBM Token-Ring Network Introduction and Planning Guide*.
2. Perform the procedure under "Finding Difficult Problems" in the manual *Using the IBM Cabling System with Communication Products*.
3. If optical fiber cabling is used in the failing ring, perform the procedure under "Testing Optical Fiber Cable" in the manual *IBM Cabling System Planning and Installation Guide*.
4. If you have completed the above steps and the ring is still not operating correctly, contact your service supplier for assistance.

---

## Diagnosing Difficult Lobe Problems

1. Determine the cable types.
  - a. If this lobe has a device attached to it with Remote Program Load installed, go to "Diagnosing Difficult Lobe Problems for Remote Program Load" on page 3-169.
  - b. If this lobe contains any copper patch cables, cables in the wall, or undercarpet cables, continue with step 2.
  - c. Otherwise, contact your service supplier.
2. Changing lobe cables.
  - a. If possible:
    - 1) Disconnect the suspected device's adapter cable from the faceplate or cable of the suspected lobe.
    - 2) Disconnect the adapter cable of another device that is known to be operational on the ring.
    - 3) Reconnect the suspected device's adapter cable to the faceplate or cable of the lobe to which the operational device was connected.
    - 4) Continue with step 3.
  - b. Otherwise, go to step 6.
3. Start your network diagnostic tool on the observer terminal. Restart the program on the device on this lobe.
  - a. If the ring is now operational, neither the suspected device nor its adapter is the problem. Continue with step 4.
  - b. Otherwise, the suspected device, its adapter, or its adapter cable is defective. Follow local procedures and have the device serviced.
4. Connect the operational device to the faceplate or cable of the suspected lobe. Restart the program on the device on this lobe.
  - a. If the ring is now operational, continue with step 5.
  - b. Otherwise, one of the lobe cables in the suspected lobe is defective. Go to "Testing Data Cables" on page 3-171.
5. Reconnect the devices to their original lobes. Restart the program on both devices.
  - a. If the ring is now operational, the problem has disappeared. No further action is required.
  - b. Otherwise, continue with step 6.
6. Go to the manual *Using the IBM Cabling System with Communication Products* and perform the procedure "Finding Difficult Problems." Return to this step if that procedure does not find a problem or after correcting the problem if one is found.
  - a. If no problem was found, contact your service supplier.
  - b. Otherwise, continue with step 7.

7. Make sure all cables have been correctly reconnected as indicated by the appropriate cabling chart. Restart the program on the device on this lobe.
  - a. If the ring is now operational, the problem has been corrected or has disappeared. No further action is required.
  - b. Otherwise, contact your service supplier for assistance.

## Diagnosing Difficult Lobe Problems for Remote Program Load

1. Determine cable types.
  - a. If this lobe contains any patch cables, cables in the wall, or undercarpet cables, continue with step 2.
  - b. Otherwise, contact your service supplier.
2. Changing lobe cables.
  - a. If possible:
    - 1) Disconnect the suspected device's device cable from the faceplate or cable of the suspected lobe.
    - 2) Disconnect the device cable of another device that is known to be operational on the ring.
    - 3) Reconnect the suspected device's device cable to another faceplate or cable of the lobe that is known to be operational. Continue with step 3.

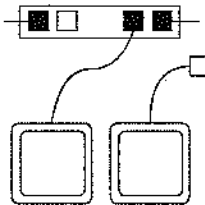

- b. Otherwise, go to step 6.
3. Start the Ring Diagnostic or Network Manager on the observer terminal and attempt to start the suspected device.
  - a. If the ring is now operational, the suspected device/adaptor is not the problem. Continue with step 4.
  - b. Otherwise, the suspected device, its adaptor, or device cable is defective. Follow local procedures to have the device serviced.
4. Connect the device that is known to be operational to the faceplate or cable of the suspected lobe and attempt to start it.
  - a. If the ring is now operational, continue with step 5.
  - b. Otherwise, one of the lobe cables in the suspected lobe is defective, go to "Testing Data Cables" on page 3-171.
5. Reconnect the devices back to their original lobes and attempt to start both devices.
  - a. If the ring is now operational, the problem has disappeared. No further actions are required.
  - b. Otherwise, continue with step 6.



6. Go to *Using the IBM Cabling System with Communication Products* and perform the procedure "Finding Difficult Problems." Return to this step if that procedure does not find a problem or after correcting the problem if one is found.
  - a. If no problem was found, contact your service supplier.
  - b. Otherwise, continue with step 7.
7. Make sure all cables have been correctly reconnected as indicated on the appropriate cabling chart. and attempt to start the suspected device.
  - a. If the ring is now operational, the problem has been corrected or has disappeared. No further actions are required.
  - b. Otherwise, contact your service supplier for assistance.

## Testing Data Cables

1. Determine the number of cables in the ring segment to be tested.
  - a. If there is only one cable in the ring segment to be tested, continue with step 2.
  - b. Otherwise, disconnect the first cable to be tested from the other cables, then continue with step 2.
2. Determine the test method.
  - a. If an IBM Cabling System Tester (P/N 4760500) is available, continue with step 3.

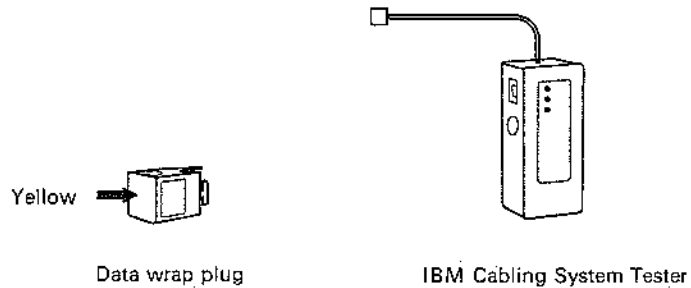

- b. Otherwise, you will need an ohmmeter and two data test cables. Refer to "Making a Data Wire Test Cable" in the *IBM Cabling System Planning and Installation Guide*. Go to step 7.
3. Connect the tester to one end of the cable to be tested. Set the tester mode switch to position 1. Press the test button and observe the indicator lights.

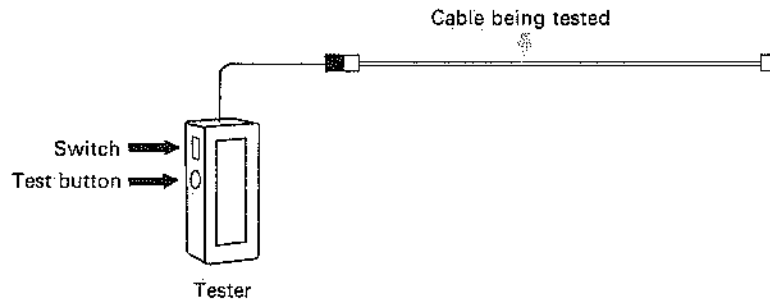

- a. If the green light came on and stayed on while the button was pressed, continue with step 4.
    - b. Otherwise, the cable is defective. Go to "Repairing a Data Cable" on page 3-176.

4. Disconnect the tester and reconnect it to the other end of the cable. Set the tester mode switch to position 1. Press the test button and observe the indicator lights.

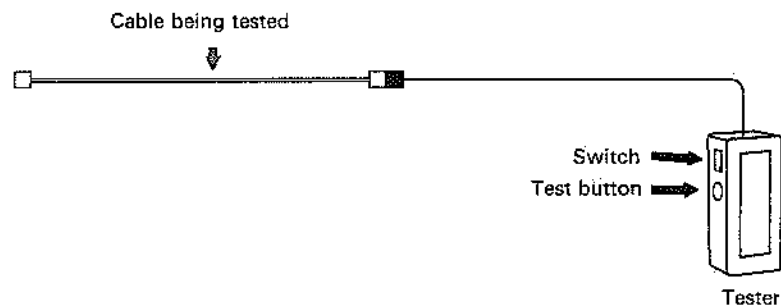

- a. If the green light came on and stayed on while the button was pressed, continue with step 5.
  - b. Otherwise, the cable is defective. Go to "Repairing a Data Cable" on page 3-176.
5. Connect the data wrap plug to the other end of the cable. Set the tester mode switch to position 2. Press the test button and observe the indicator lights.

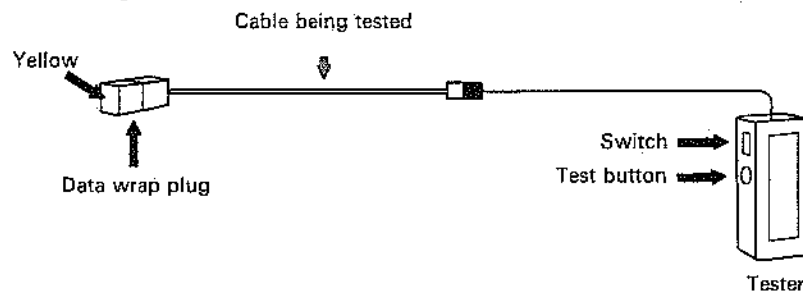

- a. If the green light came on and stayed on while the button was pressed, continue with step 6.
  - b. Otherwise, the cable is defective. Go to "Repairing a Data Cable" on page 3-176.
6. The cable appears to be defect free. Disconnect the data wrap plug and the tester from the cable.
    - a. If there are more cables to test, disconnect the next cable and return to step 3.
    - b. Otherwise, go to step 13.

7. Connect one data wire test cable to the cable to be tested. Check for continuity between:

- The red wire and the orange wire
- The green wire and the black wire.

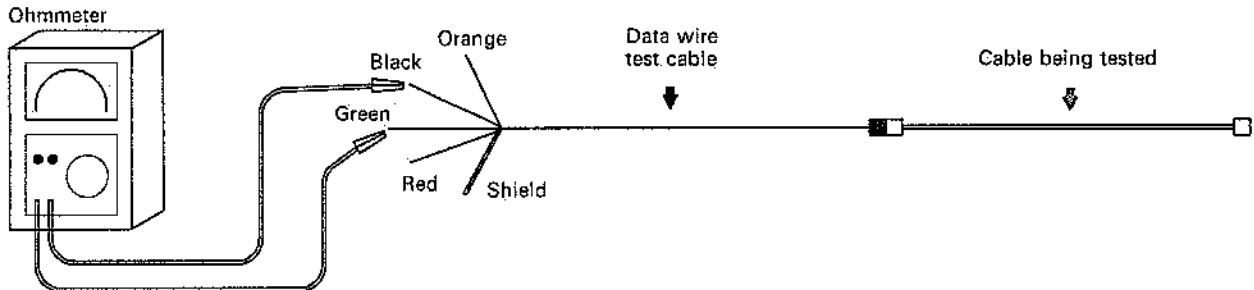

a. If the resistance measured was equal to or less than that shown in the chart below, continue with step 8.

Cable Length	With Surge Suppressor	Without Surge Suppressor
50 m (165 ft)	55 ohms	7 ohms
100 m (330 ft)	62 ohms	14 ohms
200 m (660 ft)	76 ohms	28 ohms
700 m (2300 ft)	146 ohms	98 ohms

b. Otherwise, the cable is defective. Go to "Repairing a Data Cable" on page 3-176.

8. Check for an open (resistance greater than 10,000 ohms) between:

- The red wire and the green wire
- The red wire and the shield
- The orange wire and the black wire
- The orange wire and the shield.

a. If all four checks indicated an open, continue with step 9.

b. Otherwise, the cable is defective. Go to "Repairing a Data Cable" on page 3-176.

9. Connect the other data wire test cable to the other (second) end of the cable being tested. Twist, tape, or clip the red wire to the shield on this data wire test cable. At the first end of the cable being tested, check for continuity between the red wire and the shield.

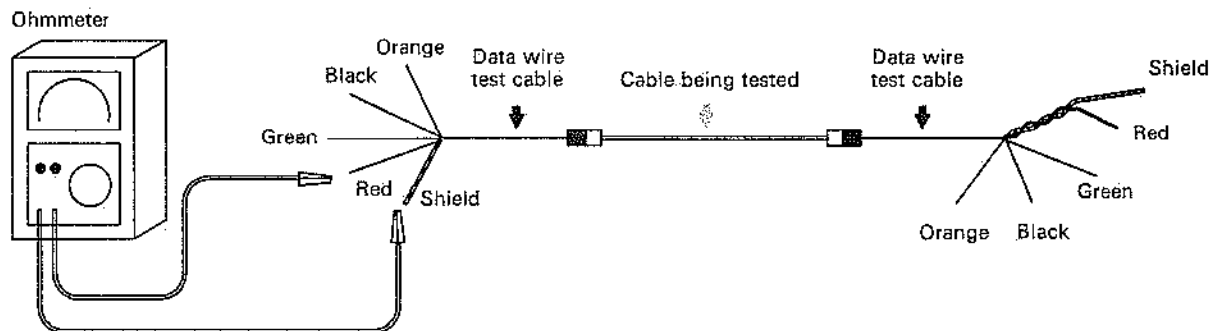

- a. If the resistance measured was equal to or less than that shown in the chart below, continue with step 10.

Cable Length	With Surge Suppressor	Without Surge Suppressor
50 m (165 ft)	28 ohms	4.2 ohms
100 m (330 ft)	32 ohms	8.3 ohms
200 m (660 ft)	41 ohms	16.6 ohms
700 m (2300 ft)	82 ohms	58 ohms

- b. Otherwise, the cable is defective. Go to "Repairing a Data Cable" on page 3-176.

10. At the second end of the cable being tested, disconnect the red wire from the shield.

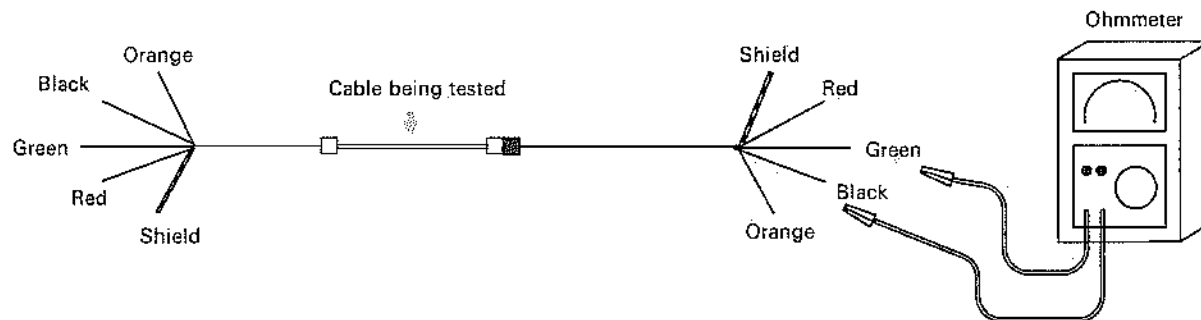

Check for an open (resistance greater than 10,000 ohms) between:

- The red wire and the orange wire
- The green wire and the black wire.

- a. If both checks indicated an open, continue with step 11.  
 b. Otherwise, the cable is defective. Go to "Repairing a Data Cable" on page 3-176.

11. Disconnect the first data wire test cable.

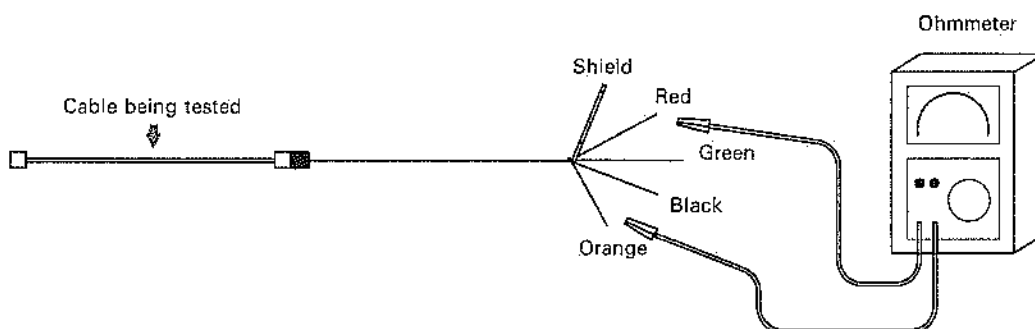

At the second data wire test cable, check for continuity between:

- The red wire and the orange wire
  - The green wire and the black wire.
- a. If the resistance measured was equal to or less than that shown in the chart below, continue with step 12.

Cable Length	With Surge Suppressor	Without Surge Suppressor
50 m (165 ft)	55 ohms	7 ohms
100 m (330 ft)	62 ohms	14 ohms
200 m (660 ft)	76 ohms	28 ohms
700 m (2300 ft)	146 ohms	98 ohms

- b. Otherwise, the cable is defective. Go to "Repairing a Data Cable" on page 3-176.
12. The cable appears to be free of defects. Disconnect both data test wires from the cable being tested.
- a. If there are more cables to test, disconnect the next cable and return to step 7.
- b. Otherwise, continue with step 13.
13. The problem has been corrected or has disappeared.
- a. Make sure that all cables and surge suppressors have been properly reconnected.
- b. At a convenient time, follow local procedures and reconnect this ring segment back into the ring. Use your Ring Sequence Chart and cabling charts to ensure that the cables are connected to the proper receptacles.

---

## Repairing a Data Cable

1. Refer to the Cable Schedule for your IBM Cabling System to determine if the defective cable contains any surge suppressors.
  - a. If the defective cable contains surge suppressors, go to the "Data Path Problem Determination Procedure" in *Using the IBM Cabling System with Communication Products* to test and repair the cabling system.
  - b. If the defective cable is a copper patch cable, obtain a replacement by following the instructions in the *IBM Cabling System Planning and Installation Guide* or continue with step 2 to repair it.
  - c. Otherwise, continue with step 2.
2. Replace the data connectors on each end of the cable. Go to "Testing Data Cables" on page 3-171 and retest this cable. After testing, return to this step.
  - a. If the cable now appears to be defect free, go to step 4.
  - b. Otherwise, continue with step 3.
3. Using the *IBM Cabling System Planning and Installation Guide*, replace the defective cable. Then continue with step 4.
4. The problem has been corrected.
  - a. Make sure that all cables and/or surge suppressors have been properly reconnected.
  - b. At a convenient time, follow local procedures and reconnect this ring segment back into the ring. Use your Ring Sequence Chart and cabling charts to ensure that the cables are connected to the proper receptacles.

---

## Replacing a Defective IBM 8228

1. You have located a defective IBM 8228 Multistation Access Unit and are ready to replace it.
  - a. If a spare IBM 8228 is available, continue with step 2.
  - b. Otherwise, follow local procedures and obtain a replacement. Then continue with step 2.
2. Remove and replace the defective IBM 8228 by following the instructions in the *IBM Token-Ring Network Installation Guide*. Continue with step 3 to check the operation of the ring after the new IBM 8228 has been connected to the ring.
3. Using the Ring Sequence Charts and IBM 8228 Cabling Charts, make sure that all cables have been reconnected to the proper receptacles. Use the your diagnostic tool or your network application program to determine the ring status.
  - a. If the ring is operational, ring recovery, isolation, and repair are complete. No further action is required.
  - b. Otherwise, there may be another problem on the ring. Continue with step 4.
4. Bypass the IBM 8228 just installed.
  - a. If the ring is operational now, the new IBM 8228 may be defective. Obtain a new IBM 8228, then return to step 1.
  - b. Otherwise, there is another problem on the ring.
    - 1) Reconnect the cables to RI and RO receptacles of the bypassed IBM 8228.
    - 2) Notify the network administrator and/or go to "Starting the Problem Determination Procedures" on page 3-5.



---

## Replacing a Defective IBM 8218

1. You have located a defective IBM 8218 and are ready to replace it.
  - a. If a spare IBM 8218 is available, continue with step 2.
  - b. Otherwise, follow local procedures and obtain a replacement. Then continue with step 2.
2. Remove and replace the defective IBM 8218 by following the instructions in the *IBM Token-Ring Network Installation Guide*. Continue with step 3 to check the operation of the ring after the new IBM 8218 is connected to the ring.
3. Using the Ring Sequence Charts and IBM 8218 Cabling Charts, make sure that all cables have been reconnected to the proper receptacles. Use your diagnostic tool or your network application program to determine the ring status.
  - a. If the ring is operational, ring recovery, isolation and repair are complete. No further action is required.
  - b. Otherwise, there may be another problem on the ring. Continue with step 4.
4. Determine the new fault domain.
  - a. If the new IBM 8218 is located within the new fault domain, the new IBM 8218 is defective. Obtain a new IBM 8218, then return to step 1.
  - b. Otherwise, there is another problem on the ring. Notify the network administrator and/or go to "Starting the Problem Determination Procedures" on page 3-5.

---

## Replacing a Defective IBM 8219

1. You have located a defective IBM 8219 Optical Fiber Repeater and are ready to replace it.
  - a. If a spare IBM 8219 is available, continue with step 2.
  - b. Otherwise, follow local procedures and obtain a replacement, then continue with step 2.
2. Remove and replace the defective IBM 8219 by following the instructions in the *IBM Token-Ring Network Installation Guide*. Continue with step 3 to check the operation of the ring after the new IBM 8219 is connected to the ring.
3. Using the Ring Sequence Charts and IBM 8219 Cabling Charts, make sure that all cables have been reconnected to the proper receptacles. Use your diagnostic tool or your network application program to determine the ring status.
  - a. If the ring is operational, ring recovery, isolation, and repair are complete. No further action is required.
  - b. Otherwise, there may be another problem on the ring. Continue with step 4.
4. Determine the new fault domain.
  - a. If the new IBM 8219 is located within the new fault domain, the new IBM 8219 is defective: Obtain another new IBM 8219, then return to step 1.
  - b. Otherwise, there is another problem on the ring. Notify the network administrator and/or go to "Starting the Problem Determination Procedures" on page 3-5.

---

## Replacing a Defective IBM 8220

1. You have located a defective IBM 8220 Optical Fiber Converter and are ready to replace it.
  - a. If a spare IBM 8220 is available, continue with step 2.
  - b. Otherwise, follow local procedures and obtain a replacement. Then continue with step 2.
2. Remove and replace the defective IBM 8220 by following the instructions in the *IBM Token-Ring Network Installation Guide*. Continue with step 3 to check the operation of the ring after the new IBM 8220 is connected to the ring.
3. Using the Ring Sequence Charts and the IBM 8220 Cabling Charts, make sure that all cables have been reconnected to the proper receptacles. Use your diagnostic tool to determine the ring status.
  - a. If the ring is operational, ring recovery, isolation, and repair are complete. No further action is required.
  - b. Otherwise, there may be another problem on the ring. Continue with step 4.
4. Determine the fault domain.
  - a. If the new IBM 8220 is located within the new fault domain, the new IBM 8220 is defective. Obtain a new IBM 8220 to replace the defective one, and then return to step 1 above.
  - b. Otherwise, there is another problem on the ring. Notify the network administrator and/or go to "Starting the Problem Determination Procedures" on page 3-5.

---

## Chapter 4. Ring Recovery Procedure for the Experienced Trouble-Shooter

Using the Procedures . . . . .	4-3
What You Need . . . . .	4-4
Getting Started . . . . .	4-4
Fast Path Procedures for Beacons and Soft Errors . . . . .	4-5



---

## Using the Procedures

The information in this chapter will help the *experienced* trouble-shooter locate and circumvent the problem for ring recovery of an IBM Token-Ring Network. An experienced trouble-shooter is one who has a good working knowledge of how the IBM Token-Ring Network is configured and how it operates. This person also has a good understanding of the procedures contained in Chapter 3.

Chapter 4 contains little explanation of where, how, or why these procedures are done. The experienced trouble-shooter is expected to understand network problem determination well enough so as not to need such explanations. If you are not an experienced trouble-shooter, do not use the procedures in this chapter. You should use the procedures in Chapter 3 instead.

After ring recovery is complete, you will need to isolate and fix the specific problem in the failing portion of the ring. Chapter 3 of this manual contains the procedures you will need.

Chapter 4 deals with two ring failure areas: Beaconing and Soft Errors. If your ring symptoms are not either of these two types, this chapter will not help you. Instead, go to Chapter 3 of this manual, beginning with "Starting the Problem Determination Procedures" on page 3-1.

While performing the ring recovery process, you may want to remove this chapter to carry with you. If so, be sure you return the chapter to its appropriate place in this manual when finished.

---

## What You Need

The following charts will help you locate the ring components you need to check. Completed versions of these charts should be available from your network administrator.

- Adapter Address to Physical Location Chart
- Physical Location to Adapter Address Chart
- Ring Sequence Chart
- IBM 8228 Cabling Chart
- IBM 8218 Cabling Chart and/or IBM 8218 Cabling Chart for Telephone Twisted-Pair-Based Rings, if applicable
- IBM 8219 Cabling Chart and/or IBM 8219 Cabling Chart for Telephone Twisted-Pair-Based Rings, if applicable
- IBM 8220 Cabling Chart, if applicable
- Bridge Planning Chart.

The following spare parts are needed at certain points in the trouble-shooting process:

- Patch cable (black)
- Crossover patch cable (yellow)
- DGM-to-Type 3 Filter cable (white)
- Optical fiber BNC-to-biconic patch cable (orange and black).

---

## Getting Started

Start your diagnostic program on some device on the ring. Determine the ring status.

- If the ring status is "BEACONING," record the addresses of the NAUN and beaconing device, then go to "Fast Path Procedures for Beaconing and Soft Errors."
- If the ring status is "SOFT ERRORS," record the addresses of the First and Second Adapters, then go to "Fast Path Procedures for Beaconing and Soft Errors."
- For any other status, go to the beginning of Chapter 3.

## Fast Path Procedures for Beaconsing and Soft Errors

**Note:** The following procedures are for *experienced troubleshooters only*. If you are not thoroughly familiar with the problem determination procedures as contained in Chapter 3, return to the beginning of Chapter 3 and continue there.

Refer to "Identifying the Fault Domain of a Beaconsing Condition" or "Identifying the Fault Domain of a Soft Error" in Appendix A of this manual to determine the fault domain. Using the Ring Sequence Chart, and the sample drawing as an example, draw a rough sketch of the fault domain to use as an aid in trouble-shooting. Using the sketch, select a device to use as a new observer terminal that is *not* in the fault domain. Then, perform the following steps, checking the ring status at the points indicated. If the status changes to "Normal," go to the procedure indicated or perform the action suggested. Otherwise, continue with this procedure.

**Note:** For soft error problems, the diagnostic program may take up to *six minutes* to show a change in ring status.

1. Determining the fault domain.

Using the procedure "Identifying the Fault Domain of a Beaconsing Condition" or "Identifying the Fault Domain of a Soft Error" in Appendix A of this manual, determine the fault domain for the error condition.

For the remainder of this procedure, your observer terminal must not be connected to an IBM 8228 that is located within the fault domain.

- a. For a beaconsing condition, go to step 6.
- b. For soft errors, continue with step 2.

2. Using the address of the first adapter, locate and determine the type of device containing that adapter.

- a. If the device is an IBM 8220, go to step 4.

**Note:** An optical fiber subsystem as referred to in these procedures is a segment of the main ring containing only optical fiber cabling with a converter at each end.

- b. Otherwise, continue with step 3.

3. Disconnect the first adapter's lobe cable from its IBM 8228.

Remember that the diagnostic program may require up to *six minutes* to show a change in ring status when soft errors are occurring.

- a. If the ring status returns to "Normal," the disconnected lobe may be defective. Go to "Lobe Logic Isolation, Soft Errors" on page 3-137.
- b. Otherwise, reconnect the first adapter's lobe cable to the IBM 8228, then continue with step 4.

4. Using the address of the second adapter, locate and determine the type of device containing that adapter.

- a. If the device is an IBM 8220, go to step 6.
- b. Otherwise, continue with step 5.



5. Disconnect the second adapter's lobe cable from its IBM 8228.

Remember that the diagnostic program may require up to *six minutes* to show a change in ring status when soft errors are occurring.

- a. If the ring status returns to "Normal," the disconnected lobe may be defective. Go to "Lobe Logic Isolation, Soft Errors" on page 3-137.
  - b. Otherwise, reconnect the second adapter's lobe cable to the IBM 8228, then continue with step 6.
6. Test all IBM 8228s in the fault domain.
    - a. Bypass an IBM 8228 in the Fault Domain.
    - b. Check the ring status. If the status has returned to "Normal" after beaconing or soft errors, go to "Isolation of an IBM 8228" on page 3-127.
    - c. Reconnect the cables to the IBM 8228.
    - d. Repeat this step for each IBM 8228 in the fault domain, or until the ring status returns to "Normal."
  7. Test all IBM 8218s present in the fault domain.
    - a. Test one pair of IBM 8218s by disconnecting the copper patch cables from the RI receptacle of both IBM 8218s, then reconnecting the cables to the RI receptacle of the opposite IBM 8218.
    - b. Check the ring status. If the status has returned to "Normal" after beaconing or soft errors, go to "Isolation of IBM 8218s" on page 3-162.
    - c. Reconnect the cables to the proper IBM 8218.
    - d. Repeat this step for each pair of IBM 8218s in the fault domain, or until the ring status returns to "Normal."
  8. Test all IBM 8219s in the fault domain.
    - a. Disconnect the copper patch cable from the IBM 8219 on the upstream end of the cable to be tested.
    - b. Disconnect the copper patch cable from the IBM 8219 on the downstream end of the cable to be tested.
    - c. Check the ring status. If the status has returned to "Normal" after beaconing or soft errors, go to "Isolation of an Optical Fiber Ring Segment, Part 1" on page 3-156.
    - d. Reconnect the copper patch cables to the IBM 8219s on each end of the cable just tested.
    - e. Repeat this step for each optical fiber cable between wiring closets that is in the fault domain.
  9. Test any IBM 8220 optical fiber subsystem in the fault domain.

**Note:** An optical fiber subsystem is a segment of the main ring path containing only optical fiber cabling with a converter at each end.

    - a. Remove power from the upstream (RI) IBM 8220.

**Note:** To remove power from a rack-mounted IBM 8220, *slide the unit out* of the rack. For surface-mounted installations, *disconnect the power cord* from the unit or wall.

- b. Check ring status. If the status has returned to "Normal," go to "Isolation of an IBM 8220 Optical Fiber Subsystem" on page 3-115.
  - c. Return power to the IBM 8220 just tested.
  - d. Repeat this step for each optical fiber subsystem in the fault domain.
10. Test patch cables.
- a. Replace a copper patch cable in the fault domain with a spare.
  - b. Check the ring status. If the status has returned to "Normal" after beaconing or soft errors, obtain a new copper patch cable for future use. No further action is required.
  - c. Remove the spare copper patch cable and reconnect the original.
  - d. Repeat this step for each copper patch cable in the fault domain (including any yellow crossover patch cables and any optical fiber patch cables) or until the ring status returns to "Normal."
11. Test all white DGM-to-Type 3 Filter cables present in the fault domain:
- a. Test one DGM-to-Type 3 Filter cables by replacing it temporarily with a spare filter cable.
  - b. Check the ring status. If the status has returned to "Normal" after beaconing or soft errors, obtain a new filter cable for future use. No further action is required.
  - c. Remove the spare filter cable and reconnect the original.
  - d. Repeat this step for each DGM-to-Type 3 Filter cable that is in the fault domain or until the ring status returns to "Normal."
12. Test all copper patch cables between wiring closets present in the fault domain.
- a. Disconnect the copper patch cable from the distribution panel at the upstream end of the cable to be tested.
  - b. Similarly, disconnect the copper patch cable from the distribution panel at the downstream end of the cable to be tested.
  - c. Check the ring status. If the status has returned to "Normal" after beaconing or soft errors, go to "Testing Data Cables" on page 3-171.
  - d. Reconnect the copper patch cables to the distribution panels at each end of the cable just tested.
  - e. Repeat this step for each copper patch cable between wiring closets that is in the fault domain.
13. If the above steps did not locate the problem, all cables should be reconnected to their proper locations according to the appropriate cabling chart. You should now go to the beginning of Chapter 3 and follow the procedures there.



---

## Part 2. The Ring Diagnostic



---

## Chapter 5. Preparing a Diskette for the Ring Diagnostic

Introduction .....	5-3
What You Need .....	5-4
Preparing to Run Ring Diagnostics .....	5-5
Preparing the Diskette .....	5-6
The Ring Diagnostic Parameters .....	5-7
Required Parameter .....	5-7
Optional Parameters .....	5-7
Memory Map .....	5-9
Setting the Parameters .....	5-11



---

## Introduction

There are two versions of the Ring Diagnostic: one version is shipped with the IBM Token-Ring Network PC Adapter, IBM Token-Ring Network 16/4 Adapter and Adapter II, and the other is shipped with the IBM Token-Ring Network Adapter/A and IBM Token-Ring Network 16/4 Adapter/A. You can use both without preparing a working diskette. To begin, insert the diskette in the A drive and restart your computer (hold Ctrl and Alt and press Del). Then follow the instructions on the display.

If you have DOS 3.3 or later, you can still prepare your own working diskette or fixed disk, if you wish.



---

## What You Need

The Ring Diagnostic analyzes events on the network and displays information about the ring to determine if it is working and to aid in ring problem determination. The Ring Diagnostic software is located on the diskette supplied with the the IBM Token-Ring Network Adapter, IBM Token-Ring Network 16/4 Adapter or IBM Token-Ring Network Adapter II. For computers that use IBM Token-Ring Network Adapter/A or IBM Token-Ring 16/4 Adapter/A, the software is located on the diskettes supplied with the *IBM Token-Ring Network Adapter/A Installation and Testing Instructions* or the *IBM Token-Ring Network 16/4 Adapter/A*.

**Note:** Before you can use the Ring Diagnostic, you must connect your computer to the IBM Token-Ring Network. Instructions for installing the IBM Token-Ring Network Adapter/A are in the *IBM Token-Ring Network Adapter/A Installation and Testing Instructions*. Instructions for installing the IBM Token-Ring Network 16/4 Adapter/A are in the *IBM Token-Ring Network 16/4 Adapter/A Installation and Testing Instructions*. Instructions for installing the other components in the network are in the *IBM Token-Ring Network Installation Guide*.

To use the Ring Diagnostic, you need the following items:

- The IBM Token-Ring Network PC Adapter Diskette or Adapter/A
- One of the following computers with a minimum of 256 KB memory:
  - An IBM Personal Computer (IBM PC, IBM PC XT, IBM Personal Computer AT, or IBM *Portable* Personal Computer) or an IBM Personal System/2 Computer with a PC I/O channel with the IBM Token-Ring Network PC Adapter or Adapter II installed and connected to the IBM Token-Ring Network
  - An IBM 7531 or 7532 Industrial Computer with the IBM Token-Ring Network PC Adapter II installed and connected to the IBM Token-Ring Network
  - An IBM Personal System/2 computer with Micro Channel architecture with a Token-Ring Network Adapter/A installed.
- An IBM monochrome display or color/graphics monitor
- DOS version 3.3 or later, if you want to prepare a working diskette or fixed disk
- An IBM Personal Computer Printer, or its equivalent, if you want printer output
- Another blank formatted diskette for the “Dump” function.

---

## Preparing to Run Ring Diagnostics

It is not necessary to build a working diskette. This is a stand alone diskette. To begin the diagnostics, insert the Diskette in the A drive and restart your computer (hold the Ctrl and Alt and press Del). Then follow the instructions on the display.

If you have DOS 3.3 or later and want to prepare you own working diskette or fixed disk, follow the procedure "Preparing the Diskette."

---

## Preparing the Diskette

The diskettes provided with the adapters are write-protected. You can prepare your own working diskette or fixed disk for the Ring Diagnostic using DOS. (A *working diskette* is a computer diskette to which files are copied from an original diskette for use in everyday operation.) For more information on DOS, see your DOS manual. Format your working diskette with DOS using the DOS FORMAT command with the /S option. See below for a list of the files that need to be copied (use the DOS COPY command) onto the working diskette or fixed disk to use the Ring Diagnostic.

**Note:** If TOKREUI.COM is not on the provided diskette it is not needed.

1. If you have the IBM Token-Ring PC Adapter or Adapter II, copy the Adapter Support Interface file TOKREUI.COM onto your working diskette or fixed disk, unless it has already been copied. If you have the Adapter/A this adapter support is not necessary.
2. Copy the following files onto your working diskette or fixed disk from the adapter diskette:

DFIRUN.BAT  
DFIPDPM.EXE  
DFIPDPO.EXE  
DFIDMSG.DAT  
DFIHMSG.DAT

3. Create a CONFIG.SYS file on the working diskette or fixed disk and add the DEVICE=ANSI.SYS (found on one of the DOS diskettes) command. If your diskette or fixed disk already has a CONFIG.SYS file, update it to include the DEVICE=ANSI.SYS command.

**Warning:** If the CONFIG.SYS file already has a DEVICE= line in it, be sure to leave it. Replacing an already existing DEVICE= line could cause the computer to stop working.

If you are using directories, the files named CONFIG.SYS and ANSI.SYS must be in the root directory of your working diskette or fixed disk. The Ring Diagnostic files must all be in the same directory. This directory must be the current directory when the Ring Diagnostic is started. For an explanation of root directories, see the DOS manual.

**Note:** You must restart the computer (press and hold Ctrl and Alt and press Del) before starting the Ring Diagnostic for the first time. This executes the DEVICE=ANSI.SYS command that was added in the last step of the above procedure.

Continue with "The Ring Diagnostic Parameters" on page 5-7 to set the parameters as required for your installation. After setting the parameters, go to Chapter 6, "Using the Ring Diagnostic" on page 6-1, to use the Ring Diagnostic.

---

## The Ring Diagnostic Parameters

You will need to use an IBM Personal Computer file editor to set the parameters.

### Required Parameter

**DFIPDPM 0**

Above is the parameter line in the DFIRUN.BAT file as it will appear when edited the first time you set the parameters.

The zero indicates you want to run the Ring Diagnostic on the primary adapter. A one indicates you want to run the Ring Diagnostic on the alternate adapter. See the adapter operator's guide to determine whether the adapter is designated as primary or alternate.

### Optional Parameters

In addition to the required parameter, there are five optional parameters (/P, /F, /L, /I and /S=xxxx).

These parameters allow the program to be started with the following options enabled:

**/P**

This parameter enables the printer as soon as the Ring Diagnostic is started.

**/F**

This parameter enables the Full Error Reporting function of the Ring Diagnostic.

**/L**

This parameter enables the Limited Error Reporting function of the Ring Diagnostic.

**Note:** Limited Error Reporting is a subset of the Full Error Reporting function. If both are selected, you will get the Full Error Reporting function. When you turn off Full Error Reporting, Limited Error Reporting will go into effect immediately. See Chapter 6, "Using the Ring Diagnostic" on page 6-1, for a complete description.

**/I**

This parameter allows you to initialize the adapter regardless of other application programs. If another application program is using the adapter at the time that the Ring Diagnostic is started, its session will be terminated when this parameter is used.

/S = XXXX

If you are using the Token-Ring Network Adapter or Adapter II, this parameter allows you to change the shared RAM locations from the default values. You cannot change the shared RAM values if you are using the Token-Ring Network Adapter/A. The default shared RAM location for the primary adapter is D800. For the alternate adapter it is D400. If the features that your system unit has installed use these locations, you will need to assign other locations that are not used. Valid locations must consist of four hexadecimal digits that represent the upper four digits of a five-digit hexadecimal address. This location should be on a 16K boundary. To find locations that can be used, check the memory map that follows.

## Memory Map

The following table provides a list of all 8K boundaries above A0000 for the IBM Token-Ring Network Adapter and Adapter II. Also included are some of the devices that use those addresses.

If you are not sure where 8K of unused addressable space is located in your IBM PC, see the *Technical Reference* for your IBM PC or consult your sales representative.

Address	Product
A0000	640K
A2000	648K
A4000	656K
A6000	664K
A8000	672K
AA000	680K
AC000	688K
AE000	796K
B0000	704K--Monochrome Display Adapter
B2000	712K--Monochrome Display Adapter
B4000	720K--Monochrome Display Adapter
B6000	728K--Monochrome Display Adapter
B8000	736K--Color Graphics Adapter
BA000	744K--Color Graphics Adapter
BC000	752K--Color Graphics Adapter
BE000	760K--Color Graphics Adapter
C0000	768K--3270 Personal Computer Adapter
C2000	776K
C4000	784K
C6000	792K
C8000	800K--Fixed Disk
CA000	808K--3270 Personal Computer Adapter
CC000	816K--PC Network Adapter (Primary)
CE000	824K--3278/3279 Emulator Adapter
D0000	832K--PC Cluster
D2000	840K--PC Cluster
D4000	848K--PC Cluster
D6000	856K--PC Cluster
D8000	864K

Address	Product
DA000	872K
DC000	880K--5250 Emulator Adapter
DE000	888K
E0000	896K--Personal Computer AT Read Only Memory
E2000	904K--Personal Computer AT Read Only Memory
E4000	912K--Personal Computer AT Read Only Memory
E6000	920K--Personal Computer AT Read Only Memory
E8000	928K--Personal Computer AT Read Only Memory
EA000	936K--Personal Computer AT Read Only Memory
EC000	944K--Personal Computer AT Read Only Memory
EE000	952K--Personal Computer AT Read Only Memory
F0000	960K--Personal Computer AT Read Only Memory
F2000	968K--Personal Computer AT Read Only Memory
F4000	976K--PC, XT, and Personal Computer AT Read Only Memory
F6000	984K--PC, XT, and Personal Computer AT Read Only Memory
F8000	992K--PC, XT, and Personal Computer AT Read Only Memory
FA000	1000K-PC, XT, and Personal Computer AT Read Only Memory
FC000	1008K-PC, XT, and Personal Computer AT Read Only Memory
FE000	1016K-PC, XT, and Personal Computer AT Read Only Memory

The first three of these parameters allow you to start the Ring Diagnostic with the following function key options already enabled (see “The Function Keys” on page 6-6):

- /P (F2)
- /F (F7)
- /L (F8)

To use the optional parameters, code them after the required parameter. Separate the parameters with a blank and precede the optional parameters with a /. Below is a sample parameter line with all the optional parameters included.

```
DFIPDPM 0 /P /F /L /I /S=D400
```

## Setting the Parameters

1. Edit the `DFIRUN.BAT` file.
2. Find the parameter line at the bottom of the file.
3. Set the adapter number in the parameter line (see “The Ring Diagnostic Parameters” on page 5-7) to 0 or 1 depending on whether this is the primary or alternate adapter respectively in this computer.

**Note:** If you don’t know whether this is the primary or alternate adapter, see the adapter guide to operations.

4. Set any optional parameters that you desire. (See “The Function Keys” on page 6-6 for more information on the optional parameters.)
5. File `DFIRUN.BAT` with the no-tabs option, if your editor has one, to prevent the editor from taking out the blanks in the file.

You are now ready to go to Chapter 6, “Using the Ring Diagnostic” on page 6-1.





---

## Chapter 6. Using the Ring Diagnostic

Starting the Ring Diagnostic	6-3
Output of the Ring Diagnostic	6-4
The Function Keys	6-6
The Ring Status Area	6-10
Ring Diagnostic Status Area Messages	6-11
Data Area Messages	6-14
Format	6-14
Descriptions	6-15



---

## Starting the Ring Diagnostic

Run the Ring Diagnostic when the problem determination procedures in Part I tell you to. The Ring Diagnostic must be run on an IBM Personal Computer or Personal System/2 computer with an IBM Token-Ring Network adapter installed. If you haven't already done so, see Chapter 5, "Preparing a Diskette for the Ring Diagnostic" on page 5-1 before using the Ring Diagnostic.

**Note:** For soft errors, the ring diagnostic may take up to *six minutes* to indicate a change in status. Be sure to allow the diagnostic a full six minutes for soft error reporting.

1. To start the Ring Diagnostic:
  - a. If using the stand alone diskette, insert the diskette in the A drive and restart your computer (hold Ctrl and Alt and press Del). Then follow the instructions on the display.
  - b. If using the prepared diskette, type DFIRUN and press enter.

**Note:** Make sure the Ring Diagnostic files are located on the default drive.

The Ring Diagnostic panel will appear on the computer display.

2. When certain Ring Diagnostic functions are selected, the associated function key descriptions are highlighted. To ensure correct display of the highlighted description, do the following:
  - a. When the Ring Diagnostic panel appears on your computer display, press F10 (Pause).
  - b. Adjust the intensity knob on your computer to highlight "10 = Pause" on the screen. A little experimentation may be required to get an adjustment that works for you.
3. After you have set the highlight level, press F10 (Pause) again to end the Pause mode.

Now that the Ring Diagnostic is running, continue reading this chapter for complete information about the output of the Ring Diagnostic.

## Output of the Ring Diagnostic

The Ring Diagnostic analyzes events on the ring and displays information about the ring to determine if it is working and to aid in problem determination. The information is supplied in three categories, each of which is displayed in a separate area of the screen.

**Ring Status:** This is the most significant information, indicating a variety of conditions ranging from normal ring operation to a wire fault.

**Ring Diagnostic Status:** This information indicates the functional status of the Ring Diagnostic itself.

**Data Area Messages:** This is the most detailed information supplied by the Ring Diagnostic. Some of this information will be supplied to find a problem on the ring, and some will be provided for your service supplier if the problem is beyond the scope of the normal user.

The Ring Diagnostic's output is displayed on the screen. If a permanent record of the data area messages is needed, the Ring Diagnostic can also send the data area messages to the printer. Data area messages are displayed in the upper portion of the screen. Ring Status and Ring Diagnostic Status are displayed on the bottom line of the screen and are separated by a vertical bar (|). Between the data area and the status indicators are two lines of function key descriptions. The function keys allow you to operate the Ring Diagnostic.

```
                                RING DIAGNOSTIC
09/21/84 13:06:28 DFIPD001I Ring diagnostic started
-----> 10005A000133 000000A33832 000000A33832 000000A33832
09/21/84 13:06:49 DFIPD003I Printer enabled
09/21/84 13:09:30 DFIPD015I Ring test 1 started
09/21/84 13:10:06 DFIPD101E Ring error limit exceeded
-----> 10005A0002C2 00000000 7F 10005A00311F 00000000 6A

F1=Help          2=Print          3=End          4=          5=
F6=Ring test     7=Full E.R.      8=Limited E.R. 9=Reset Counts 10=Pause
Soft Error      |DFIPD005I Ring test in progress - please wait|

Ring Status | Ring Diagnostic Status
```

On the following page is an example of the Ring Diagnostic being used on a ring. It is indicating a fault domain that includes the first adapter's address and the second adapter's address. For an explanation of fault domains, see "How to Identify the Fault Domain" on page A-29 in Appendix A, "Preparing for Problem Determination." The adapter or adapters causing a problem on the ring are always located inside the fault domain of a data area message that has two adapter addresses. In the data area messages, the terms *first* and *second* adapter address indicate the boundaries of the fault domain.

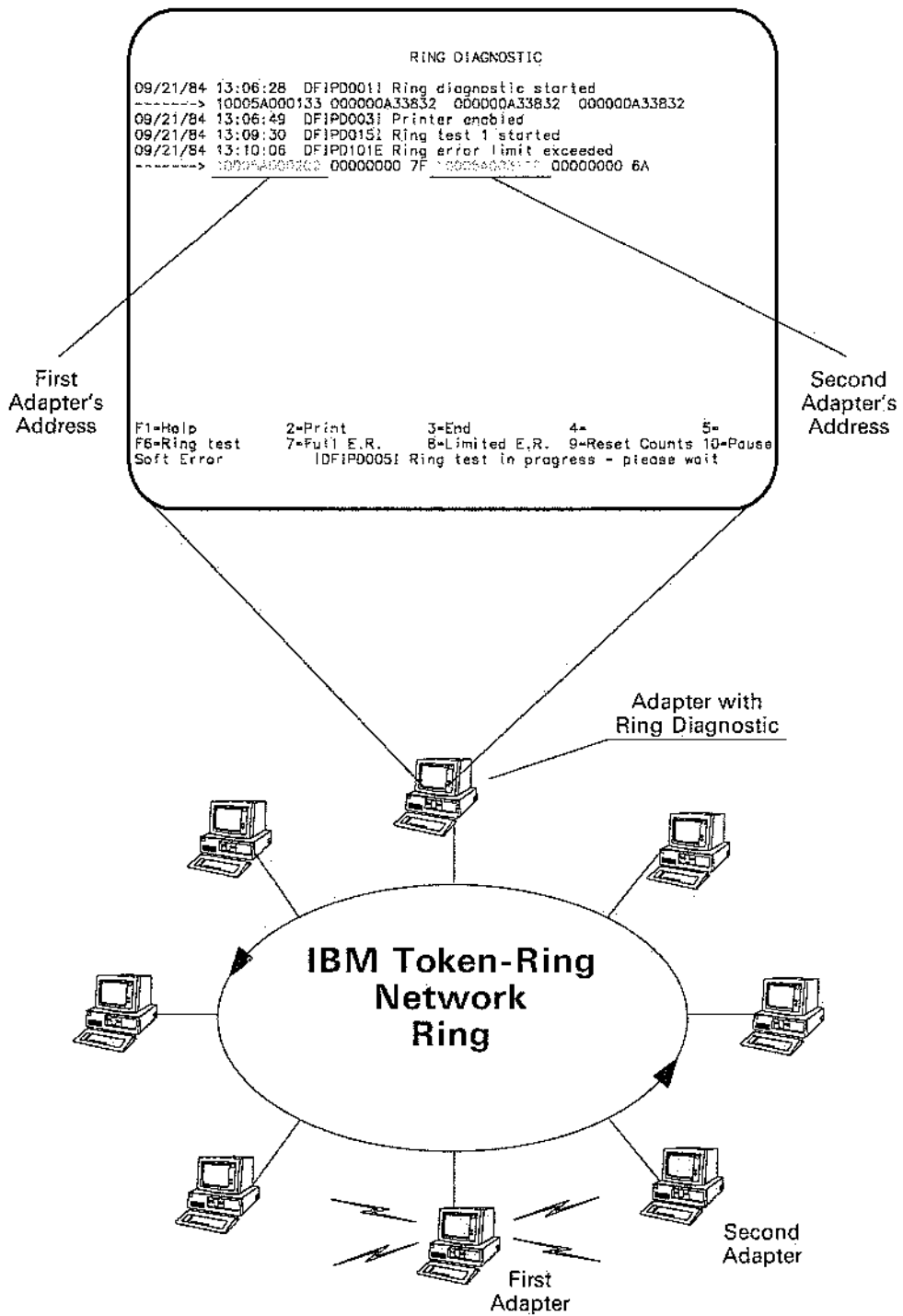

## The Function Keys

The function keys are the only active Ring Diagnostic keys, with the exception of any keys activated by other application programs and the following:

- Shift-PrtSc (prints contents of the screen)
- Ctrl-Alt and Del (restarts the computer)
- Ctrl-Num Lock (stops and starts screen updates). (Use F10 [Pause] instead of Ctrl-Num Lock if you wish to observe Ring Status or Ring Diagnostic Status updates. Using Ctrl-Num Lock may halt these updates.)

Pressing any other keys will result in a *beep* from your computer.

```
                                RING DIAGNOSTIC
09/21/84 13:06:28 DFIPD001I Ring diagnostic started
-----> 10005A000133 000000A33832 000000A33832 000000A33832
09/21/84 13:06:49 DFIPD003I Printer enabled
09/21/84 13:09:30 DFIPD015I Ring test 1 started
09/21/84 13:10:06 DFIPD101E Ring error limit exceeded
-----> 10005A0002C2 00000000 7F 10005A00311F 00000000 6A

F1=Help      2=Print      3=End      4=      5=
F6=Ring test 7=Full E.R.  8=Limited E.R. 9=Reset Counts 10=Pause
Soft Error   DFIPD005I Ring test in progress - please wait
```

Function Key Descriptions



### Help

Press this key to view Help. The Help panels provide a general description of the function keys. They also show you the address of the adapter running the Ring Diagnostic and the code level of the adapter, the Adapter Support Interface, and the Ring Diagnostic. When you are viewing the Help panels, only two function keys are available and displayed on the screen:

- F3 (End)
- F10 (Pause).

After each Help panel is displayed, the screen will be in Pause mode. To view the next Help panel, press F10 to cancel Pause. Pressing F3 (End) cancels Help and returns you to the Ring Diagnostic in the same mode that you were in before using the Help function.



## Print

Press this key to print all data area messages as they are displayed. Press it again to cancel printing. Data area messages continue to be displayed while this function is enabled. The function key description "2 = Print" will be highlighted while the Print function is enabled. If the printer is not ready, F4 (Retry Print) will be displayed (see below).



## End

Press this key to end the Ring Diagnostic and return to DOS. If you are looking at the Help panels, this key will return you to the Ring Diagnostic.



## Retry Print

This key is displayed only if there is a printer error. Use it to restart the printer after the cause of the printer failure has been removed.

For example:

If F2 (Print) is pressed and the printer is offline or disconnected, nothing will be printed. Information will, however, begin to be accumulated in the print buffer. To start the printer while saving this information, do the following:

1. Prepare the printer for printing.
2. Press F4 (Retry Print).



## Dump

This key is displayed only if an error occurs while you are trying to start the Ring Diagnostic or if an error occurs that will not allow the Ring Diagnostic to continue. Pressing this key will result in a series of messages that prompt you to write a portion of the computer memory to a diskette. (You will need to insert a blank, formatted diskette at this time.) This information can be used by your service supplier to diagnose your problem.





## Ring Test

Press this key to test the Adapter Support Interface and the ring's ability to pass data. The Ring Diagnostic performs a two-step test. At the completion of each step, a message indicates the test result.



## Full E.R.

In Full Error Reporting, all error report messages are sent to the data area of the display. This is the most detailed way to monitor activity on the ring. In addition, this mode displays all beacon status updates as manual recovery actions are performed. To cancel Full Error Reporting, press this key again. The function key description "7=Full E.R." will be highlighted while the Full Error Reporting function is enabled.

**Note:** Because all error report messages are displayed, fault domain information can be overwritten by less critical data. When using Full Error Reporting, you should print the messages or observe the screen to ensure that you capture the fault domain information.



## Limited E.R.

In Limited Error Reporting, only soft error reports from those adapters that meet a predefined error level are sent to the data area of the display. The point at which messages begin to be sent to the data area is the half-way point to the ring error limit. (When this limit is reached, ring response may be slow.) To cancel Limited Error Reporting, press the key again. The function key description "8=Limited E.R." will be highlighted while the Limited Error Reporting function is enabled.

**Note:** Limited E.R. is a subset of Full E.R. If both Full E.R. and Limited E.R. are enabled, the result will be Full E.R.



## Reset Counts

Press this key to reset the error counts maintained by the error reporter function of the Ring Diagnostic. Any messages in the print or display buffers are saved.

This key should be pressed if you receive message 120.



## Pause

Messages sent to the data area on the screen begin to scroll when the data area is filled. Press this key to stop the scrolling. To cancel Pause and restart scrolling, press this key again. The function key description "10=Pause" will be highlighted while Pause is in effect.

This key should be used instead of the Ctrl-Num Lock function provided by DOS. Using Ctrl-Num-Lock may halt the display of Ring Status or Ring Diagnostic Status updates.

When viewing the Help panels, Pause is enabled. Press F10 (Pause) to view the next Help panel.

**Note:** While Pause is in effect, new messages are sent to a display buffer. If this buffer should fill to 80% of its capacity, a message will be displayed in the Ring Diagnostic status area. You can bring the messages from the display buffer into the data area of the screen by canceling Pause.

## The Ring Status Area

The ring status information indicates the condition of the ring.

```
                                RING DIAGNOSTIC
09/21/84 13:06:28 DFIPD001 Ring diagnostic started
-----> 10005A000133 000000A33832 000000A33832 000000A33832
09/21/84 13:06:49 DFIPD003 Printer enabled
09/21/84 13:09:30 DFIPD015 Ring test 1 started
09/21/84 13:10:06 DFIPD101E Ring error limit exceeded
-----> 10005A0002C2 00000000 7F 10005A00311F 00000000 6A

F1=Help      2=Print      3=End      4=      5=
F6=Ring test 7=Full E.R.  8=Limited E.R. 9=Reset Counts 10=Pause
Soft Error   DFIPD005 Ring test in progress - please wait
```

**Ring Status**

All ring status conditions are listed below. All ring status conditions except **Normal** are highlighted on the screen and remain highlighted until the ring status returns to normal. Whenever the ring status changes, a data area message is generated. These messages are described later in this chapter.

### Normal

The Ring Diagnostic is processing information, and the ring is operating normally.

### Soft Error

The ring is experiencing intermittent failures that cause data to be transmitted on the ring more than once to be received correctly.

### Beaconing

The ring is not operational. This could be caused by a broken wire or a faulty adapter. When the problem is isolated to one adapter, its logical address is displayed to the operator in a data area message.

### Adapter Closed

This IBM Token-Ring Network PC Adapter is no longer actively attached to the network.

### Wire Fault

There is a problem with the lobe between the attaching device and the access unit to which it is attached.

## Ring Diagnostic Status Area Messages

The Ring Diagnostic status area messages are displayed with the message number and message text.

```
                                RING DIAGNOSTIC
09/21/84 13:06:28 DFIPD001I Ring diagnostic started
-----> 10005A000133 000000A33832 000000A33832 000000A33832
09/21/84 13:06:49 DFIPD003I Printer enabled
09/21/84 13:09:30 DFIPD015I Ring test 1 started
09/21/84 13:10:06 DFIPD101E Ring error limit exceeded
-----> 10005A0002C2 00000000 7F 10005A00311F 00000000 6A

F1=Help      2=Print      3=End      4=      5=
F6=Ring test 7=Full E.R. 8=Limited E.R. 9=Reset Counts 10=Pause
Soft Error   [DFIPD005I Ring test in progress - please wait]
```

Ring Diagnostic Status

The following Ring Diagnostic status messages are listed by their message number. The message number is the three numeric digits in the message identifier. See the example of a data area message on page 6-14.

### DFIPD002I Operation in progress - please wait

**Meaning:** The program is performing an operation. This message usually appears briefly while the Ring Diagnostic is performing an operation as the result of a function key being pressed.

**Action:** Wait for the operation to complete.

### DFIPD005I Ring test in progress - please wait

**Meaning:** F6 (Ring Test) has been pressed to initiate a ring test. This message is displayed until the ring test is complete.

**Action:** Wait for the ring test to be completed and look for the results in the data area.

### DFIPD008I Ring adapter open in progress - please wait

**Meaning:** The program is in the process of opening the ring adapter. This message will remain displayed until initialization has been completed or data area message DFIPD040E is displayed.

**Action:** Wait for the adapter to open.



### DFIPD080W Display buffer 80% full

**Meaning:** The display buffer is 80% full. The display buffer is an area in memory that holds the Ring Diagnostic output until it can be sent to the display. The display buffer can hold up to 100 lines of data. When the buffer becomes full, new data will be lost. This message is usually caused by the data area being in Pause mode too long.

**Action:** If in the Help mode, return to the Ring Diagnostic by pressing F3 (End). Otherwise, deactivate Pause, Full E.R., or Limited E.R. functions if active.

### DFIPD081E Display buffer overflow - data lost

**Meaning:** The display buffer is full, and the most recent data is being lost.

**Action:** If in the Help mode, return to the Ring Diagnostic by pressing F3 (End). Otherwise, deactivate Pause, Full E.R., or Limited E.R. functions if active.

### DFIPD090W Printer needs attention

**Meaning:** There is no response from the printer, because it is disconnected, offline, jammed, or out of paper.

**Action:** Check to see if the printer is:

- Powered on
- Online
- Supplied with paper
- Connected to the computer.

Correct the print problem and press F4 (Retry Print) to retry the printer.

If this doesn't correct the printer error, press F2 (Print) to disable the printer and allow continued use of the Ring Diagnostic. When you have finished using the Ring Diagnostic, go to the printer problem determination procedures in the *Guide to Operations* for your computer.

### DFIPD091W Printer buffer overflow - data lost

**Meaning:** Information is being processed too fast for the printer. The most recent information is being lost.

**Action:** If "4 = Retry Print" is displayed, check to see if the printer is:

- Powered on
- Online
- Supplied with paper
- Connected to the computer.

Correct the print problem and press F4 (Retry Print) to retry the printer.

If this doesn't correct the printer error, press F2 (Print) to disable the printer and allow continued use of the Ring Diagnostic. When you have finished using the Ring Diagnostic, go to the printer problem determination procedures in the *Guide to Operations* for your computer.

If "4 = Retry Print" is not displayed, no action is required.

DFID990E XX

**Meaning:** (The two Xs represent an error code in the form of two hexadecimal digits.) This code indicates an abnormal end has occurred.

**Action:** If the error code is 45, press F3 (End) and make sure that the file DFIDMSG.DAT is in the same directory as the rest of the Ring Diagnostic files. If the error code is not 45, press F3 (End) and do the following:

1. Restart the computer (press and hold Ctrl and Alt and then press Del).
2. Start the Ring Diagnostic as described in "Starting the Ring Diagnostic" on page 6-3.
3. If the same message occurs, recopy the files if you are using a working diskette or fixed disk and restart as described in the two previous steps. To recopy the files, see Chapter 5, "Preparing a Diskette for the Ring Diagnostic" in this manual.
4. If that doesn't correct the problem, press F5 (Dump). Then follow the actions described in the messages displayed.

# Data Area Messages

## Format

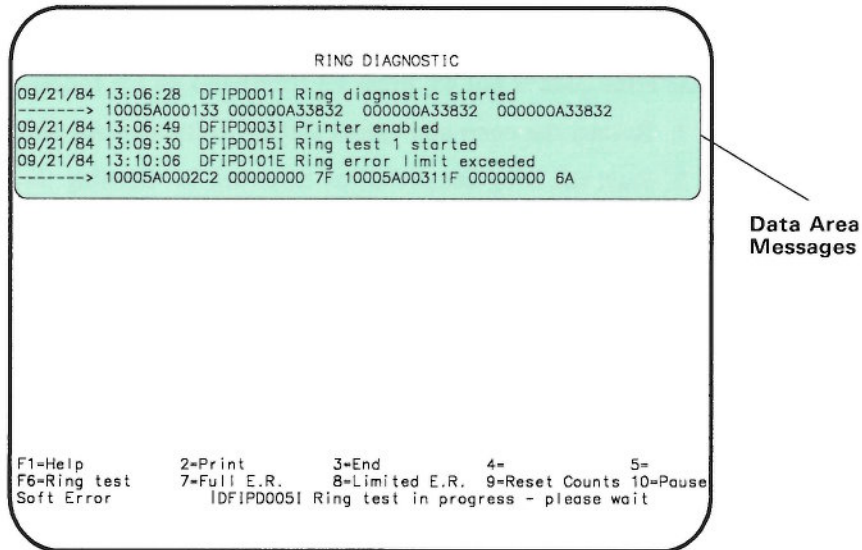

Below is an example of a data area message with its separate parts identified. Data area messages have one or two lines depending on whether there is variable data associated with the message. When two lines are displayed, the second line is variable data.

The three types of messages are:

- I — Information
- W — Warning
- E — Error

The rest of this chapter lists the various data area messages.

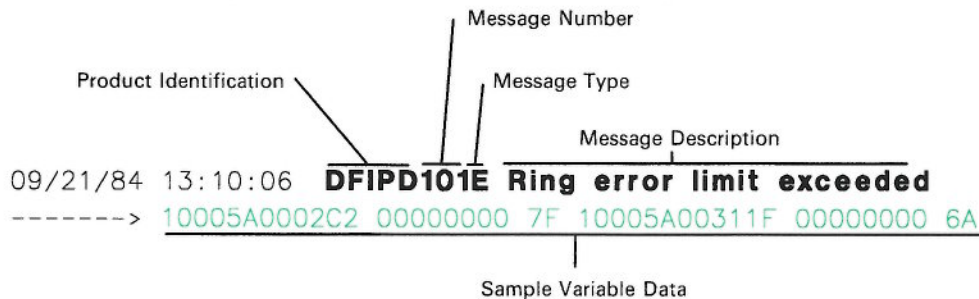





#### DFIPD011I Full error reporting disabled

**Meaning:** Full Error Reporting has been disabled by pressing F7 (Full E.R.) while Full E.R. was in effect.

**Action:** None

**Variable Data:** None

#### DFIPD012I Limited error reporting enabled

**Meaning:** Limited Error Reporting has been enabled by pressing F8 (Limited E.R.) or by starting the Ring Diagnostic with the /L parameter in effect.

**Action:** None

**Variable Data:** None

#### DFIPD013I Limited error reporting disabled

**Meaning:** Limited Error reporting has been disabled by pressing F8 (Limited E.R.) while Limited E.R. was in effect.

**Action:** None

**Variable Data:** None

#### DFIPD014I Error counters reset

**Meaning:** The error counters for the soft error reporter function of the Ring Diagnostic have been reset by pressing F9 (Reset Counts). When this message is displayed, a ring status of **Soft Error** will change to **Normal**.

**Action:** None

**Variable Data:** None

#### DFIPD015I Ring test 1 started

**Meaning:** Ring test 1 has been started by pressing F6 (Ring Test). The Ring Diagnostic is sending a message to test the Adapter Support Interface and the adapter in this computer.

**Action:** Wait for another message indicating the result of ring test 1.

**Variable Data:** None

### DFIPD016I Ring test 1 successful - test 2 started

**Meaning:** Ring test 1 has been completed successfully and ring test 2 has started. The Ring Diagnostic is sending a message to complete the test of the Adapter Support Interface in this computer. This message appears only after message number DFIPD015I.

**Action:** Wait for a message indicating the result of ring test 2.

**Variable Data:** None

### DFIPD017E Ring test 1 failed - test stopped

**Meaning:** The Ring Diagnostic could not complete ring test 1.

**Action:** When the ring status is **Normal**, test the adapter according to the instructions in the adapter operator's guide. If the diagnostics indicate that the adapter is operable and you still get this message, contact your place of purchase.

When the ring status is not **Normal**, record the ring status. If you came from the problem determination procedures in this guide, return to the step that sent you here. If you didn't, go to Chapter 2, "Preparing for Problem Determination."

**Variable Data:** None

### DFIPD018I Ring test 2 successful - test complete

**Meaning:** Ring test 2 has been completed successfully. The Adapter Support Interface and adapter successfully sent out a message that returned correctly. This message appears only after message number DFIPD016I.

**Action:** None

**Variable Data:** None

### DFIPD019E Ring test 2 failed - test complete

**Meaning:** Ring test 2 failed to send a message around the ring. The Adapter Support Interface or this adapter is failing to send or receive the message properly.

**Note:** This message will appear if message DFIPD230E is displayed when the Ring Diagnostic is started.

**Action:** When the ring status is **Normal**, run the Adapter Diagnostics. If the diagnostics indicate that the adapter is okay and you still get this message, contact your place of purchase.

When the ring status is not **Normal**, record the ring status. If you came from the problem determination procedures in this guide, return to the step that sent you here. If you didn't, go to Chapter 2, "Preparing for Problem Determination."

**Variable Data:** None

## DFIPD040E Ring diagnostic initialization failed

**Meaning:** The Ring Diagnostic was not able to start successfully. The problem could be an internal program error or an error from creating the working diskette.

**Action:** See the variable data and refer to the chart below to determine the reason for failure.

### Variable Data:

09/21/84 13:10:06 DFIPD040E Ring diagnostic initialization failed

-----> 0010 10005A000133 000000A33832 000000A33832 000000A33832

Reason Code	This Adapter's Address	This Adapter's Code Level	Adapter Support Interface Code Level	Ring Diagnostic Code Level
----------------	------------------------------	---------------------------------	-----------------------------------------------	----------------------------------

Reason Code	Reason	Action
0002	Initialize command failed.	See Action #1 after this table.
0003	Open command failed.	See Action #1 after this table.
0007	Status command failed.	See Action #1 after this table.
0008	Adapter already in use.	Use optional parameter /I when invoking the Ring Diagnostic.
000A	No parameters were passed to the Ring Diagnostic.	See Action #2 after this table.
000E	Wrong optional parameter.	See Action #2 after this table.
000F	Printer initialization failed.	Check the printer.
0010	Help initialization failed.	Make sure that the file named DFIHMSG.DAT is in the same directory as the rest of the Ring Diagnostic files.
0015	Error reporter failed.	Make sure that the file named DFIPDPO.EXE is in the same directory as the rest of the Ring Diagnostic files.
0018	The wrong level of DOS is being used.	Make sure you use the DOS version 3.2 or higher.
001A	Formatter initialization failed.	Make sure that the file named DFIDMSG.DAT is in the same directory as the rest of the Ring Diagnostic files.
All other numbers		See Action #3 after this table.

**Action #1:** This message will be followed by another message providing additional information. Take the action indicated for the other message.

**Action #2:** Correct the parameters as described in Chapter 5, "Preparing a Diskette for the Ring Diagnostic" on page 5-1 of this manual.

**Action #3:**

1. Restart the computer (press and hold Ctrl and Alt and then press Del).
2. Restart the Ring Diagnostic by typing DFIRUN and pressing **Enter**.
3. If the message continues to be displayed, run the Adapter Diagnostics supplied with your adapter.
4. If the message continues to be displayed, recopy the files if using a working diskette. See Chapter 5, "Preparing a Diskette for the Ring Diagnostic" in this book.
5. If the problem is still not corrected, record the variable data and call your place of purchase.

#### **DFIPD049I Ring diagnostic ended**

**Meaning:** Either F3 (End) was pressed or the initialization failed, causing the Ring Diagnostic to end. When this message is displayed as a result of F3 (End) being pressed, the ring status is either **Adapter Closed** or **Wire Fault**.

**Action:** If F3 (End) was not pressed, look at the previous messages for more information.

**Variable Data:** None

#### **DFIPD081E Display buffer overflow - data lost**

**Meaning:** The area for storing display messages has reached 100% of its capacity and new data is being lost. This may be caused by the Ring Diagnostic remaining in Pause or Help too long, or by messages being generated too fast for the display.

Fast generation of messages can be caused by enabling Full E.R. or Limited E.R. on a ring with a high error rate.

**Action:** If in the Help mode, return to the Ring Diagnostic by pressing F3 (End). Otherwise, deactivate Pause, Full E.R., or Limited E.R. functions if active.

**Variable Data:** None



### DFIPD085W Receive congestion - data lost

**Meaning:** Messages are being received too fast for the Ring Diagnostic to process and data is being lost.

**Action:** No action is required. When the rate at which messages are being received decreases to a level that can be processed by the Ring Diagnostic, normal processing will resume.

**Variable Data:** None

### DFIPD090W Printer needs attention

**Meaning:** An error occurred while printing or while the Print function was being enabled.

**Action:** Check to see if the printer is:

- Powered on
- Online
- Supplied with paper
- Connected to the computer.

Correct the print problem and press F4 (Retry Print) to retry the printer.

If this doesn't correct the printer error, press F2 (Print) to disable the printer and allow continued use of the Ring Diagnostic. When you have finished using the Ring Diagnostic, go to the printer problem determination procedures in the *Guide to Operations* for your computer.

**Variable Data:** None

### DFIPD091W Printer buffer overflow - data lost

**Meaning:** The print buffer is full. New data is being lost. This message may be generated if message DFIPD090W is not corrected promptly or if messages are being generated at a rate too fast for the printer.

**Action:** If the "4 = Retry Print" message is displayed, check to see if the printer is:

- Powered on
- Online
- Supplied with paper
- Connected to the computer.

Correct the print problem and press F4 (Retry Print) to retry the printer.

If this doesn't correct the printer error, press F2 (Print) to disable the printer and allow continued use of the Ring Diagnostic. When you have finished using the Ring Diagnostic, go to the printer problem determination procedures in the *Guide to Operations* for your computer. If the "4 = Retry Print" message is not displayed, no action is required.

**Variable Data:** None





### DFIPD106I Ring error report

**Meaning:** A soft error has been detected. This message can be expected as a normal function of the ring. It will occur only if Full E.R. or Limited E.R. is enabled. When this message is displayed, the ring status is **Normal** or **Soft Error**.

**Action:** None

#### Variable Data:

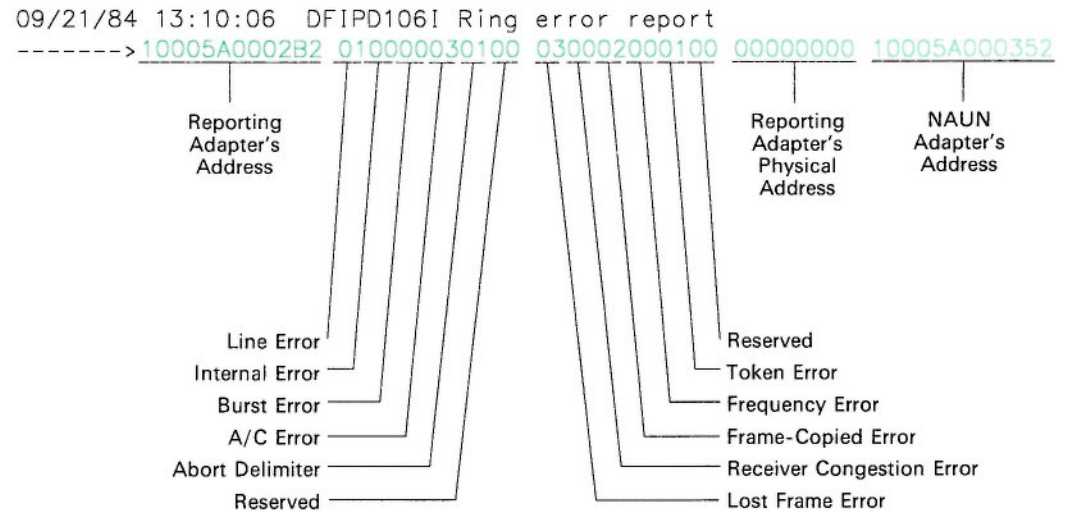

**Note:** For more information about the meaning of the variable data, see the index of the *IBM Token-Ring Network Architecture Reference*.

### DFIPD108I Ring poll failure

**Meaning:** The ring poll, also called neighbor notification, process has encountered an error and recovery has taken place. This message is displayed only when Full E.R. is enabled. When this message is displayed, the ring status is **Normal** or **Soft Error**.

**Action:** None

#### Variable Data:

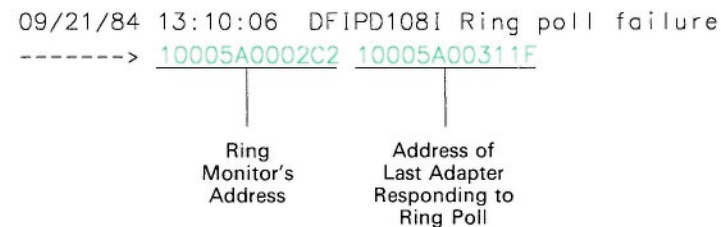





### DFIPD14II Additional adapter(s) on ring

**Meaning:** The Ring Diagnostic has detected that at least one other adapter on the ring has become active.

**Action:** None

**Variable Data:** None

### DFIPD190W Invalid message length

**Meaning:** The length of a message received by the Ring Diagnostic does not agree with the length specified in the message. This message is displayed only when Full E.R. is enabled.

**Action:** Run the Adapter Diagnostics on the adapter generating the message. If the diagnostics indicate that the adapter generating the message is okay, run the diagnostics on this adapter (the adapter receiving the message). If the diagnostics indicate that this adapter is okay and you still get this message, do the following:

1. Restart the computer (press and hold Ctrl and Alt and then press Del) containing the adapter generating the message.
2. Start the Ring Diagnostic as described in Chapter 6, "Using the Ring Diagnostic."
3. If the same message occurs, recopy the files for the working diskette and restart as described in the two previous steps. To recopy the files, go to the adapter operator's guide and Chapter 5, "Preparing a Diskette for the Ring Diagnostic," in this manual.
4. If that doesn't correct the problem, record the variable data and call your place of purchase.

**Variable Data:**

```
09/21/84 13:10:06 DFIPD190W Invalid message length  
-----> 000010005A0002C210005A00311F000000010200
```

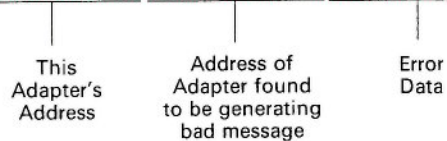

### DFIPD191W Duplicate data in message

**Meaning:** Duplicate data was detected in a message received by the Ring Diagnostic. This message is displayed only when Full E.R. is enabled.

**Action:** Run the Adapter Diagnostics on the adapter generating the message, as described in the adapter operator's guide. If the diagnostics indicate that the adapter generating the message is okay, run the diagnostics on this adapter (the adapter receiving the message). If the diagnostics indicate that this adapter is okay and you still get this message, do the following:

1. Restart the computer (press and hold Ctrl and Alt and then press Del) containing the adapter generating the message.
2. Start the Ring Diagnostic as described in Chapter 6, "Using the Ring Diagnostic."
3. If the same message occurs, recopy the files for the working diskette and restart as described in the two previous steps. To recopy the files, go to the adapter operator's guide and Chapter 5, "Preparing a Diskette for the Ring Diagnostic," in this manual.
4. If that doesn't correct the problem, record the variable data and call your place of purchase.

#### Variable Data:

09/21/84 13:10:06 DFIPD191W Duplicate data in message

-----> 000010005A0002C210005A00311F000000010200

This  
Adapter's  
Address

Address of  
Adapter found  
to be generating  
bad message

Error  
Data

## DFIPD192W Missing data in message

**Meaning:** Required data was missing in a message received by the Ring Diagnostic. This message is displayed only when Full E.R. is enabled.

**Action:** Run the Adapter Diagnostics on the adapter generating the message, as described in the adapter operator's guide. If the diagnostics indicate that the adapter generating the message is okay, run the diagnostics on this adapter (the adapter receiving the message). If the diagnostics indicate that this adapter is okay and you still get this message, do the following:

1. Restart the computer (press and hold Ctrl and Alt and then press Del) containing the adapter generating the message.
2. Start the Ring Diagnostic as described in Chapter 6, "Using the Ring Diagnostic."
3. If the same message occurs, recopy the files for the working diskette and restart as described in the two previous steps. To recopy the files, go to the adapter operator's guide and Chapter 5, "Preparing a Diskette for the Ring Diagnostic," in this manual.
4. If that doesn't correct the problem, record the variable data and call your place of purchase.

### Variable Data:

09/21/84 13:10:06 DFIPD192W Missing data in message

-----> 000010005A0002C210005A00311F000000010200

This  
Adapter's  
Address

Address of  
Adapter found  
to be generating  
bad message

Error  
Data





### DFIPD203I Ring recovered

**Meaning:** The ring has recovered and is operating normally. When this message is displayed, the ring status is **Normal** or **Soft Error**.

**Action:** If you came from the problem determination procedures in this guide, record the ring status and return to the step that sent you here. If you didn't, no action is required.

**Variable Data:** None

### DFIPD204I Ring recovered - adapter removed

**Meaning:** The adapter indicated in the variable data below was logically removed from the active ring. The ring was then recovered. When this message is displayed, the ring status is **Normal** or **Soft Error**.

**Action:** Record the ring status. If you came from the problem determination procedures in this guide, return to the step that sent you here. If you didn't, go to Chapter 2, "Preparing for Problem Determination."

**Variable Data:**

09/21/84 13:10:06 DFIPD204I Ring recovered - adapter removed

-----> 10005A0002C2

Removed  
Adapter's  
Address

### DFIPD210E Unable to initialize ring adapter

**Meaning:** This adapter did not respond to the Ring Diagnostic's attempt to initialize it.

**Action:** Verify that the indicated adapter is installed and that the switches, if any, are set properly. Correct any errors found. If you still get this message, do the following:

Run the adapter diagnostics described in the adapter operator's guide. If the diagnostics indicate that the adapter is operational and you still get this message, record the variable data and contact your place of purchase.

**Variable Data:**

09/21/84 13:10:06 DFIPD210E Unable to initialize ring adapter

-----> 00070007

Bring Up Error  
Return Code  
Adapter Number

**Note:** For more information about the meaning of the variable data, see "DIR.INITIALIZE" in the index of the *IBM Token-Ring Network PC Adapter Technical Reference*.

## DFIPD211E Unable to open ring adapter

**Meaning:** This adapter did not respond to the Ring Diagnostic's attempt to open the adapter.

**Action:** Determine the return code from the variable data as shown below. When the return code is 07 or FF, record the symptom described in the data area message. If you came here from the problem determination procedures in this guide, return to the step that sent you here. If you didn't, go to Chapter 2, "Preparing for Problem Determination."

When the return code is 27, verify the adapter data rate. If the return code is still 27 on a retry, you may be attempting to insert into the fault domain. Attempt to enter the ring from another physical location.

When the return code is other than 07 or FF, do the following:

1. Verify that the indicated adapter is installed and that the switches, if any, are set properly. Correct any errors found. If the problem still exists, continue with the next step.
2. Restart the computer (press and hold Ctrl and Alt and then press Del).
3. Start the Ring Diagnostic as described in Chapter 6, "Using the Ring Diagnostic."
4. If the same message occurs, recopy the files for the working diskette or fixed disk and restart as described in the two previous steps. To recopy the files, see the adapter operator's guide and Chapter 5, "Preparing a Diskette for the Ring Diagnostic" in this manual.
5. If that doesn't correct the problem, record the variable data and contact your place of purchase.

### Variable Data:

```
09/21/84 13:10:06 DFIPD211E Unable to open ring adapter
```

```
-----> 00070007
```

Open Error Code

Return Code

Adapter Number

**Note:** For more information about the meaning of the variable data, see "DIR.OPEN.ADAPTER" in the index of the *IBM Token-Ring Network PC Adapter Technical Reference*.



### DFIPD212E Ring adapter hardware failed

**Meaning:** The adapter hardware failed.

**Action:** Run the Adapter Diagnostics described in the adapter operator's guide. If the diagnostics indicate that the adapter is okay and you still get this message, record the variable data and contact your place of purchase.

**Variable Data:**

09/21/84 13:10:06 DFIPD212E Ring adapter hardware failed

-----> 00000001004000000200000103



**Note:** For more information about the meaning of the variable data, see “errors, adapter check” in the index of the *IBM Token-Ring Network PC Adapter Technical Reference*.

### DFIPD213E Ring adapter microcode failed

**Meaning:** The Adapter Support Interface code failed.

**Action:** Do the following:

1. Verify that the indicated adapter is installed and that the switches, if any, are set properly. Correct any errors found.
2. Restart the computer (press and hold Ctrl and Alt and then press Del).
3. Start the Ring Diagnostic as described in Chapter 6, “Using the Ring Diagnostic.”
4. If the same message occurs, copy the files for the working diskette or fixed disk and restart as described in the two previous steps. To copy the files, refer to the adapter operator's guide and Chapter 5, “Preparing a Diskette for the Ring Diagnostic,” in this manual.
5. If that doesn't correct the problem, record the variable data and call your place of purchase.

**Variable Data:**

09/21/84 13:10:06 DFIPD213E Ring adapter microcode failed

-----> 002604



09/21/84 13:10:06 DFIPD213E Ring adapter microcode failed

-----> FF000001

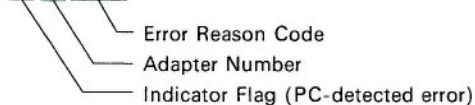

**Note:** For more information about the meaning of the variable data in the first example, see Appendix A in the *IBM Token-Ring Network PC Adapter Technical Reference*. For more information about the variable data in the second example, see “error, PC-detected” in that manual.



### DFIPD214E Unable to close ring adapter

**Meaning:** This adapter did not correctly respond to the Ring Diagnostic's attempt to close the adapter.

**Action:** Run the Adapter Diagnostics on this adapter. If the diagnostics indicate that the adapter is okay and you still get this message, do the following:

1. Restart the computer (press and hold Ctrl and Alt and then press Del) containing the adapter generating the message.
2. Start the Ring Diagnostic as described in Chapter 6, "Using the Ring Diagnostic."
3. If the same message occurs, recopy the files if using a working diskette or fixed disk and restart as described in the two previous steps. To recopy the files, go to Chapter 5, "Preparing a Diskette for the Ring Diagnostic" in this manual.
4. If that doesn't correct the problem, record the variable data and call your place of purchase.

**Variable Data:**

09/21/84 13:10:06 DFIPD214E Unable to close ring adapter

-----> 0011  
                  Return Code  
                  Adapter Number

### DFIPD215E Ring adapter or lobe failed

**Meaning:** The Ring Diagnostic determined there was a wire fault. When this message is displayed, the ring status is **Wire Fault**.

**Action:** Record the ring status. If you came from the problem determination procedures in this guide, return to the step that sent you here. If you didn't, go to Chapter 2, "Preparing for Problem Determination."

**Note:** To get more ring status from the Ring Diagnostic, restart the Ring Diagnostic.

**Variable Data:** None

### DFIPD216I Ring adapter closed

**Meaning:** This message is a result of pressing F3 (End) or as a result of an error that forced the adapter to close. When this message is displayed, the ring status is **Adapter Closed**.

**Action:** If the reason code is 00, no action is required. If the reason code is 01, go to the beginning of Part 1 of this manual. If the reason code is 03, contact your network administrator.

**Variable Data:**

09/21/84 13:10:06 DFIPD216I Ring adapter closed

-----> 0001  
                  Reason Code  
                  Adapter Number

### DFIPD230E Unable to open ring adapter interface

**Meaning:** The Adapter Support Interface code did not accept the open command from the Ring Diagnostic.

**Note:** It is also possible to use the Ring Diagnostic after getting this message. If the return code is 46, ring test 2 will fail but all other Ring Diagnostic functions will work. The reason for this message can be that another application program did not correctly use the Adapter Support Interface. (To use the Adapter Support Interface correctly, see “Service Access Points” in Chapter 3 of the *IBM Token-Ring Network NETBIOS User’s Guide*.)

**Action:** If the return code in the variable data is 46, no action is required. The Ring Diagnostic can still be used; follow the actions for subsequent messages. If the return code is other than 46, run the Adapter Diagnostics on this adapter. If the diagnostics indicate that the adapter is okay and you still get this message, do the following:

1. Restart the computer (press and hold Ctrl and Alt and then press Del) containing the adapter generating the message.
2. Start the Ring Diagnostic as described in Chapter 6, “Using the Ring Diagnostic.”
3. If the same message occurs, recopy the files if you are using a working diskette or fixed disk and restart as described in the two previous steps. To recopy the files, go to Chapter 5, “Preparing a Diskette for the Ring Diagnostic,” in this manual.
4. If that doesn’t correct the problem, record the variable data and call your place of purchase.

**Variable Data:**

09/21/84 13:10:06 DFIPD230E Unable to open ring adapter interface

-----> 0046  
                  Return Code  
                  Adapter Number

**Note:** For more information about the meaning of the variable data, see “DLC.OPEN.SAP” in the index of the *IBM Token-Ring Network PC Adapter Technical Reference*.

### DFIPD231E Unable to close ring adapter interface

**Meaning:** The Adapter Support Interface code did not accept the close command from the Ring Diagnostic.

**Action:** Run the Adapter Diagnostics on this adapter, as described in the adapter operator's guide. If the diagnostics indicate that the adapter is okay and you still get this message, do the following:

1. Restart the computer (press and hold Ctrl and Alt and then press Del) containing the adapter generating the message.
2. Start the Ring Diagnostic as described in Chapter 6, "Using the Ring Diagnostic."
3. If the same message occurs, recopy the files for the working diskette or fixed disk and restart as described in the two previous steps. To recopy the files, refer to the adapter operator's guide and Chapter 5, "Preparing a Diskette for the Ring Diagnostic," in this manual.
4. If that doesn't correct the problem, record the variable data and call your place of purchase.

**Variable Data:**

```
09/21/84 13:10:06 DFIPD231E Unable to close ring adapter interface
```

```
-----> 0001
```

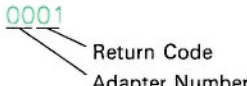

Return Code  
Adapter Number

**Note:** For more information about the meaning of the variable data, see "DLC.CLOSE.SAP" in the index of the *IBM Token-Ring Network PC Adapter Technical Reference*.

### DFIPD991I Insert formatted diskette in drive A

**Meaning:** You have pressed F5 (Dump) to request a dump of Ring Diagnostic information in memory. This information can then be given to your service supplier. This message will be followed by message number DFIPD992I.

**Action:** Insert a formatted diskette with at least 150 K bytes of free space into drive A.

**Variable Data:** None

### DFIPD992I Press any key when ready

**Meaning:** The Ring Diagnostic is ready to create a file on the diskette in drive A.

**Action:** Press any key.

**Variable Data:** None

**DFIPD993I Memory image file created**

**Meaning:** The file was created.

**Action:** Take or send the diskette to your service supplier.

**Variable Data:** None

**DFIPD994I Memory image file not created**

**Meaning:** The file was not created.

**Action:** None

**Variable Data:** None



---

## Appendix A. How to Find Devices and Components

How to Find Devices and Components .....	A-3
Finding a Device Using the Adapter Address .....	A-4
Finding a Device Using Its IBM 8228 .....	A-6
Finding the IBM 8228 for a Device .....	A-10
Finding IBM 8218s, IBM 8219s and IBM 8220s .....	A-15
Finding the Component in a Given Position in the Ring Sequence .....	A-19
Finding the Next Downstream and Upstream IBM 8228 .....	A-21
Finding the First and Last Component in a Wiring Closet .....	A-23
Finding Bridges .....	A-25
How to Bypass an IBM 8228 .....	A-27
How to Identify the Fault Domain .....	A-29
Identifying the Fault Domain of a Beaconsing Condition .....	A-29
Identifying the Fault Domain for Beaconsing on the Backup Ring .....	A-33
Identifying the Fault Domain of a Soft Error .....	A-37



---

## How to Find Devices and Components

In some instances, the problem determination procedures require that you find a particular device or component (an IBM 8228 Multistation Access Unit, an IBM 8218 Copper Repeater, an IBM 8219 Optical Fiber Repeater, an IBM 8220 Optical Fiber Converter, or a bridge). The following sections explain how to use the IBM Token-Ring Network and the IBM Cabling System charts to find such items in the ring. Read the instructions before you start, or refer to them when needed.

**Note:** If the labeling scheme used to label the components and cables in your IBM Token-Ring Network is different from the method described in the *IBM Token-Ring Network Introduction and Planning Guide*, see your network administrator for an explanation of how to interpret the charts for your network.



## Finding a Device Using the Adapter Address

The problem determination procedures may require you to find a device associated with an adapter address. Adapter addresses always consist of 12 hexadecimal digits. The adapter address may be displayed by the IBM Token-Ring Network Ring Diagnostic, the IBM Local Area Network Manager, or by the network application program you are using to provide information about the ring status and fault domain. Follow these steps to find a device by using its adapter address:

1. Carefully record the adapter address as displayed on the screen.

In the example, the adapter address displayed by the Ring Diagnostic is 10005A000007.

Adapter Address

```
                                RING DIAGNOSTIC
02/20/86 13:06:28 DFIP0040E Ring diagnostic initialization failed
-----> 10005A000007 000000A33802C 000000A33826C 000000A33826C
02/20/86 13:06:34 DFIP0211E Unable to open ring adapter
-----> 00070018
02/20/86 13:07:10 DFIP0049I Ring diagnostic ended

F1=Help      2=Print      3=End      4=      5=
F6=Ring test 7=Full E.R. 8=Limited E.R. 9=Reset Counts 10=Pause
```

2. Refer to your Adapter Address to Physical Location Locator Chart. Find the adapter address in the left-hand column of the chart.
3. Beside the adapter address (under the column "Physical Location"), find the room number and identification number of the device. (The chart also indicates the ring number and the number of the IBM 8228 that the device is connected to.)

In the example, device PC47 is in room 108.

### Adapter Address to Physical Location Locator Chart

Adapter Address	Physical Location	Device Identification	Ring Number	IBM 8228 Unit Number
10005A000000	100	PC40	1	1001
10005A000001	101	PC41	1	1001
10005A000002	102	PC42	1	1001
10005A000003	103	PC43	1	1001
10005A000004	104	PC44	1	1001
10005A000005	105	PC45	1	1001
10005A000006	107	PC46	1	1001
10005A000007	108	PC47	1	1002
10005A000008	109	PC48	1	1002
10005A000009	110	PC49	1	1002
10005A00000A	111	PC50	1	1002
10005A00000B	112	PC51	1	1002
10005A00000C	113	PC52	1	1002
10005A00000D	114	PC53	1	1002
10005A00000E	115	PC54	1	1003
10005A00000F	116	PC55	1	1003
10005A000010	117	PC56	1	1003
10005A000011	118	PC57	1	1003

## Finding a Device Using Its IBM 8228

The problem determination procedures may require that you find a device when you know which lobe receptacle of a particular IBM 8228 Multistation Access Unit the device is connected to. In such cases, you can use the IBM 8228 Cabling Chart for the unit to find the device. Start where the device's IBM 8228 is located and follow these steps to find the device:

1. How to find the device depends on where the IBM 8228 is mounted.
  - a. If the IBM 8228 is mounted in an equipment rack, follow steps 2 and 3 of this procedure.
  - b. If the IBM 8228 is mounted in a component housing, follow steps 4 to 6 of this procedure.
2. Find the lobe receptacle that the device is connected to. Note the cable label on the cable bracket.

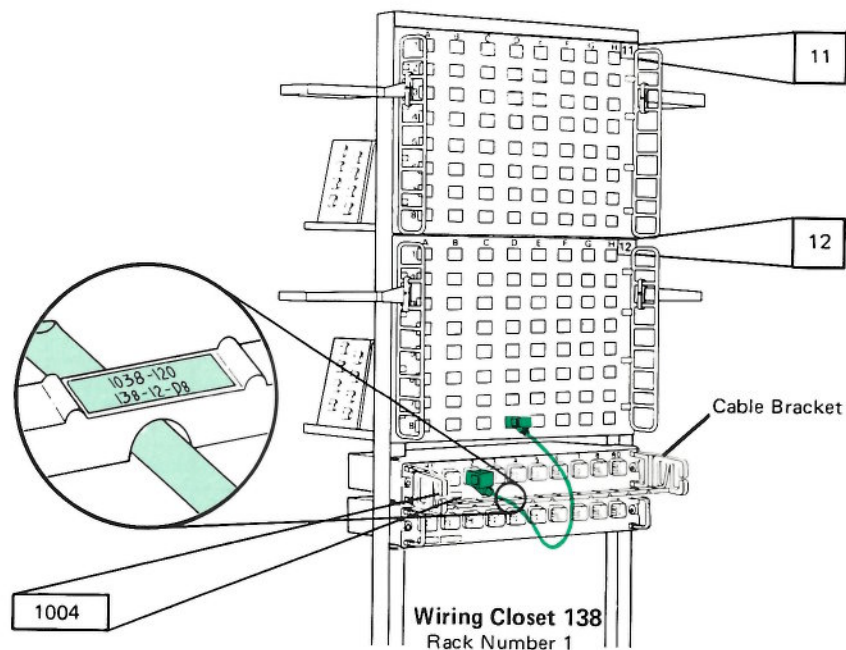

3. Use the cable label to determine the location of the device you are trying to find. The numbers on the top line indicate the cable number and the location of the faceplate at the other end of the cable. The device should be connected by an adapter cable to the faceplate.

In the example in Figure A-1 on page A-7, cable number 1038 terminates at a faceplate in room 120. Device PC59 is connected to the faceplate.

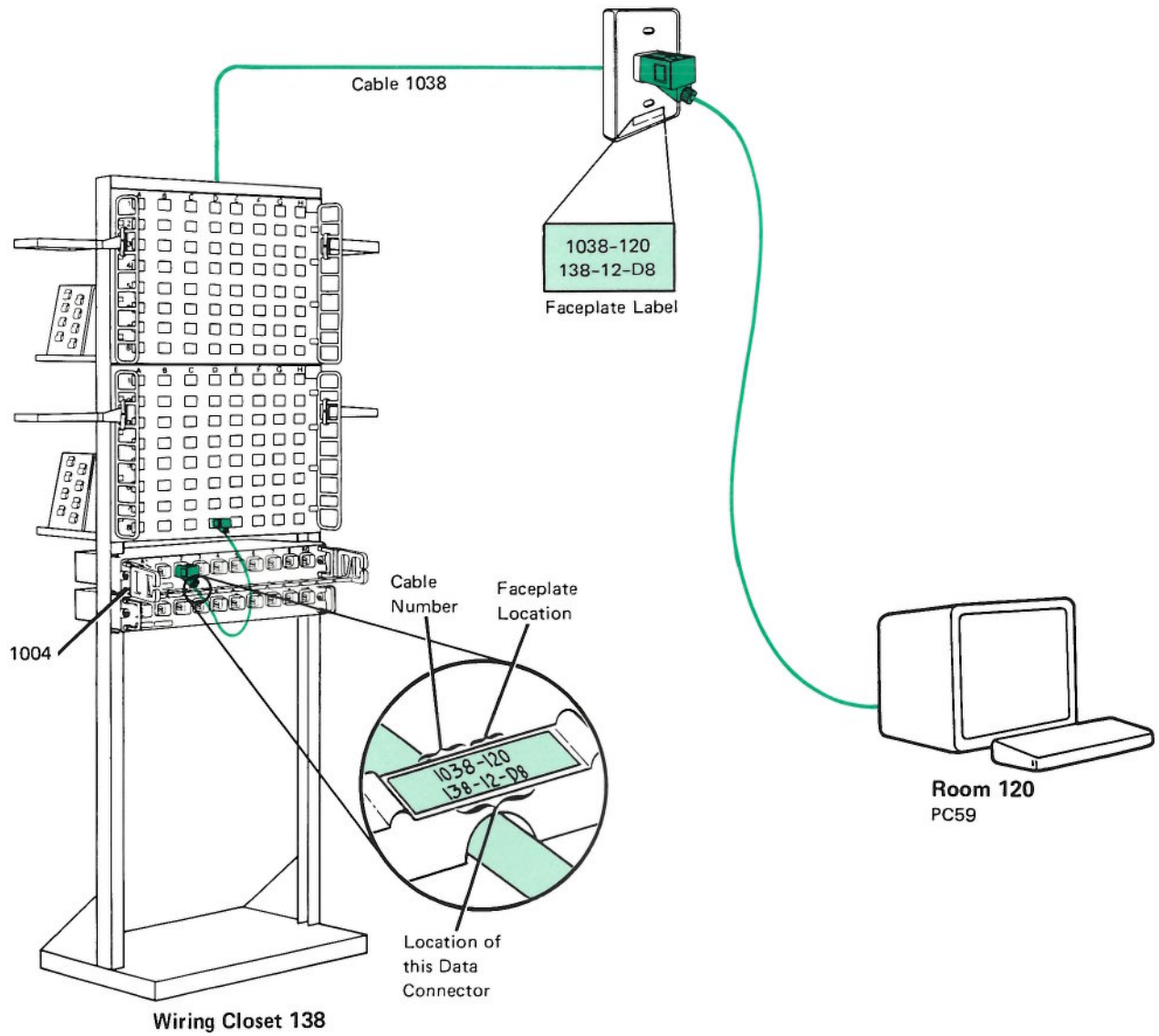

Figure A-1. Tracing a Cable from a Wiring Closet to a Device

4. If the IBM 8228 is mounted in a component housing, trace the cable from the lobe receptacle of the IBM 8228 that the device is connected to.
  - a. If possible, visually trace the cable from the lobe receptacle of the IBM 8228 to the device.
  - b. If it is not possible to visually trace the cable, continue with step 5.
5. Using the unit number of the IBM 8228, find its IBM 8228 Cabling Chart. The unit number is on the label under receptacle 1 of the IBM 8228 and on the label on the cover of the component housing.
6. In Section 2 of the IBM 8228 Cabling Chart, find the column for the lobe receptacle that the device is connected to.

The first line in the "Connect to" row indicates the room where the device is located. The second line indicates the length of the patch cable used to connect the device to the IBM 8228.

The "Device" row indicates the identification number for the device.

In the example in Figure A-2 on page A-9, receptacle 1 of IBM 8228 number 1006 is connected to a device (PC70) in room 119A. It is connected to the device by a 150-foot patch cable.

## IBM 8228 Cabling Chart

Date 8-1-86

### Section 1 Identification

Unit Number	<u>1006</u>	Building Location	<u>119H</u>	Rack-mounted <input type="checkbox"/>	Wall-mounted <input checked="" type="checkbox"/>	Ring	<u>1</u>
-------------	-------------	-------------------	-------------	---------------------------------------	--------------------------------------------------	------	----------

### Section 2 Receptacle Connections

Receptacle	1	2	3	4	5	6	7	8
Connect to:	<u>119A</u>	<u>119B</u>	<u>119C</u>	<u>119D</u>	<u>119H</u>	<u>119G</u>		
	<u>P150</u>	<u>P75</u>	<u>P75</u>	<u>P30</u>	<u>P8</u>	<u>P75</u>		

Device	<u>PC70</u>	<u>PC71</u>	<u>PC72</u>	<u>PC73</u>	<u>PC74</u>	<u>PC75</u>		
--------	-------------	-------------	-------------	-------------	-------------	-------------	--	--

### Section 3 Ring Connections

A. Connect RI of this 8228 to:	<u>13B-12-A8</u>
B. Connect RO of this 8228 to:	<u>13B-12-B8</u>

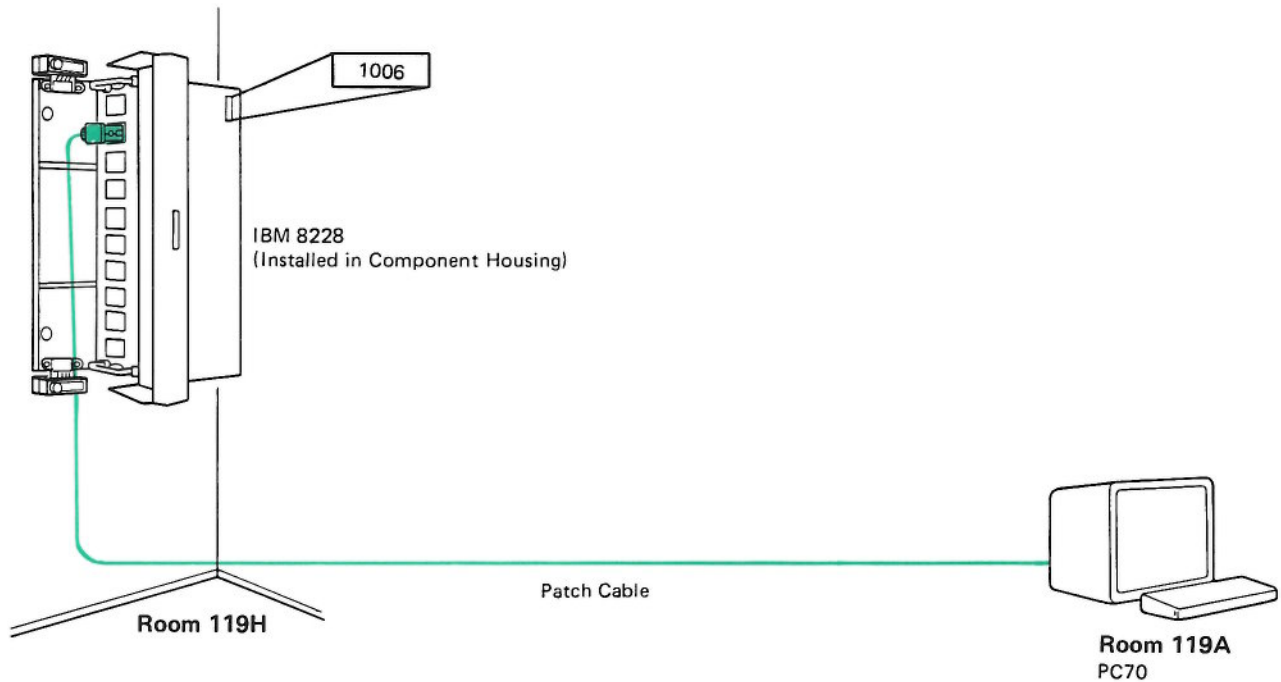
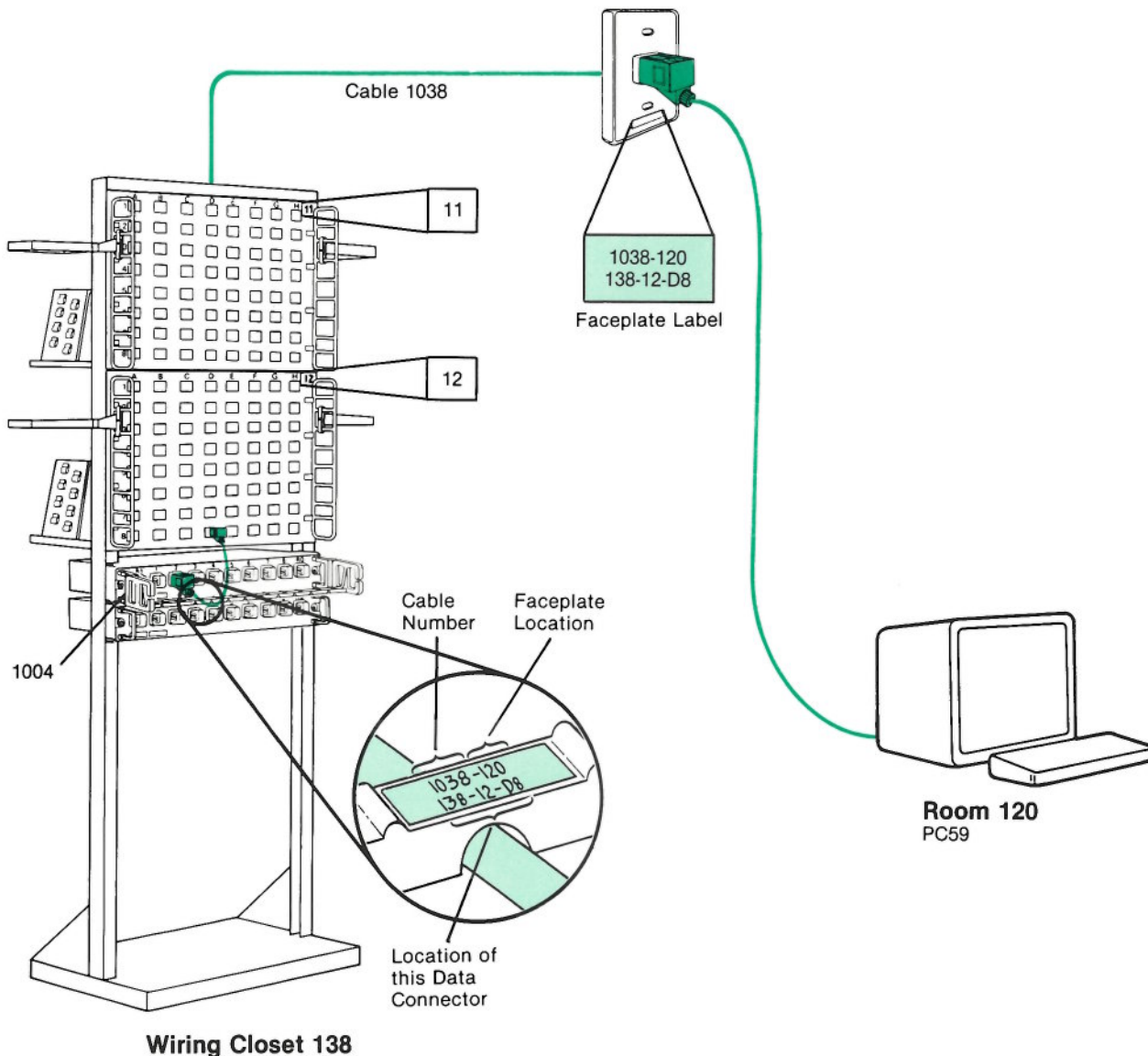

Figure A-2. Tracing a Cable from a Component Housing to a Device

## Finding the IBM 8228 for a Device

In some cases, you may need to find the IBM 8228 Multistation Access Unit to which a device is connected. For IBM Token-Ring Networks that use permanently installed IBM Cabling System cable, one method of finding the IBM 8228 is to start with the faceplate that the device is connected to. The second line of the faceplate label indicates the location of the other end of the cable.

In the example below, the cable terminates in wiring closet 138. It is connected to coordinate D8 of the second distribution panel in rack number 1. To find the IBM 8228, you will have to trace the patch cable from the distribution panel to the IBM 8228. This method is essentially the reverse of the procedure described in "Finding a Device Using Its IBM 8228" on page A-6.



Another method, which can be used with any IBM Token-Ring Network, involves using your Adapter Address to Physical Location Locator and Ring Sequence Charts. If you know the adapter address for the device's adapter and have these charts, follow these steps to find the device's IBM 8228:

1. Refer to the Adapter Address to Physical Location Locator Chart. Find the adapter address in the left-hand column of the chart. In the example, the adapter address is 10005A000007.
2. In the column marked "IBM 8228 Unit Number," find the number of the IBM 8228 that the device is connected to. In the example, the unit number is 1002.

Adapter Address	Physical Location	Device Identification	Ring Number	IBM 8228 Unit Number
10005A000000	100	PC40	1	1001
10005A000001	101	PC41	1	1001
10005A000002	102	PC42	1	1001
10005A000003	103	PC43	1	1001
10005A000004	104	PC44	1	1001
10005A000005	105	PC45	1	1001
10005A000006	107	PC46	1	1001
10005A000007	108	PC47	1	1002
10005A000008	109	PC48	1	1002
10005A000009	110	PC49	1	1002
10005A00000A	111	PC50	1	1002
10005A00000B	112	PC51	1	1002
10005A00000C	113	PC52	1	1002
10005A00000D	114	PC53	1	1002
10005A00000E	115	PC54	1	1003
10005A00000F	116	PC55	1	1003
10005A000010	117	PC56	1	1003
10005A000011	118	PC57	1	1003



3. Find an entry for the IBM 8228 on your Ring Sequence Chart. The rectangle containing the IBM 8228's number also contains its location.
  - a. If the IBM 8228 is mounted in an equipment rack, the chart will indicate the location of the wiring closet and the number of the rack. In the following example, IBM 8228 number 1004 is mounted in rack number 1 in wiring closet 138. Continue with step 4.
  - b. If the IBM 8228 is mounted in a component housing, the chart will indicate the room number or area where the housing is mounted. Continue with step 4.

# Ring Sequence Chart

Ring Number 1 Ring Data Rate  4  16 Page 1 of 2  
 cable from P8 Date 9-1-88  
 on page 2

(component) MSAU 1001  
 (location) 106-1

P8

(component) MSAU 1002  
 (location) 106-1

P8

(component) MSAU 1003  
 (location) 106-1

P8

(component) DP  
 (location) 106-11-A1

6001

(component) DP  
 (location) 138-11-A1

P8

(component) MSAU 1004  
 (location) 138-1

← ACCESS UNIT 1004  
 ← WIRING CLOSET 138  
 RACK NUMBER 1

P8

(component) MSAU 1005  
 (location) 138-1

cable to P8  
 on page 2

**Suggested Abbreviations:**

DP - Distribution Panel  
 P - Patch Cable  
 YCP - (Yellow) Crossover Patch Cable  
 OFP - Optical Fiber Patch Cable

FP - Faceplate  
 MB - Optical Fiber  
 Mounting Bracket  
 SS - Surge Suppressor

MSAU - IBM 8228 Multistation Access Unit  
 RPTR - IBM 8218 Copper Repeater  
 OFRPTR - IBM 8219 Optical Fiber Repeater  
 OFCVTR - IBM 8220 Optical Fiber Converter

4. Find the IBM 8228 in the location you identified in step 3. Verify that you have found the correct IBM 8228 by checking the unit number under receptacle 1.

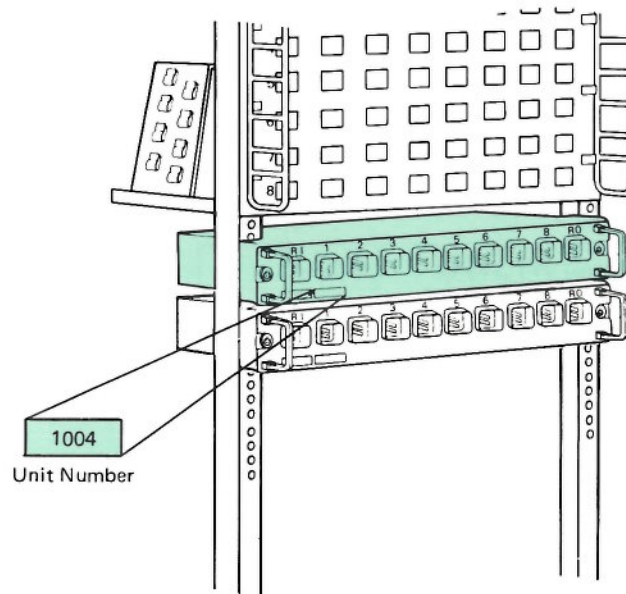

---

## Finding IBM 8218s, IBM 8219s and IBM 8220s

The procedures may ask if there are any IBM 8218s, IBM 8219s or IBM 8220s in the fault domain or in a particular wiring closet. The IBM 8218 Copper Repeater is a copper wire-to-copper wire repeater. It is installed on copper cables to compensate for signal loss caused by the cables and IBM 8228s in the signal path. IBM 8218s are used in pairs. The two units are connected together with a yellow crossover patch cable. IBM 8218s may be installed in an equipment rack or on a wall.

IBM 8219 Optical Fiber Repeaters and IBM 8220 Optical Fiber Converters are also used in pairs. The first unit in the pair converts a signal from an electrical impulse on copper wire to a light signal on optical fiber cable. The second unit converts the light signal back to an electrical impulse for transmission on copper wire. IBM 8219s or IBM 8220s may be installed in an equipment rack or on a wall.

Use the Ring Sequence Chart to determine if there are IBM 8218s, IBM 8219s or IBM 8220s in a given portion of a ring. IBM 8218s and IBM 8219s are recorded in the rectangles on the chart. The abbreviation "RPTR" on the Ring Sequence Chart indicates an IBM 8218. "OFRPTR" indicates an IBM 8219. The abbreviation "OFCVTR" on the Ring Sequence Chart indicates an IBM 8220 Optical Fiber Converter. The unit number for each component is recorded beside the abbreviation, and the location is recorded on the second line.

In the example in Figure A-3 on page A-16, an IBM 8218 (unit number 2001) is installed in rack number 1 in wiring closet A140. The other unit in the pair (2002) is installed in the same rack. A yellow crossover patch cable (YCP) connects the two units.

In the example in Figure A-4 on page A-17, an IBM 8219 Optical Fiber Repeater (unit number 2005) is installed in rack number 1 in wiring closet C170. The other unit in the pair (2006) is installed in rack number 1 in wiring closet A100.

In the example in Figure A-5 on page A-18, an IBM 8220 Optical Fiber Converter (unit number 2007) is installed in rack number 1 in wiring closet C175. The other unit in the pair (2008) is installed in rack number 1 in wiring closet A107.

# Ring Sequence Chart

Ring Number 1 Ring Data Rate  4  16 Page 4 of 8  
 cable from PB Date 9-1-88  
 on page 3

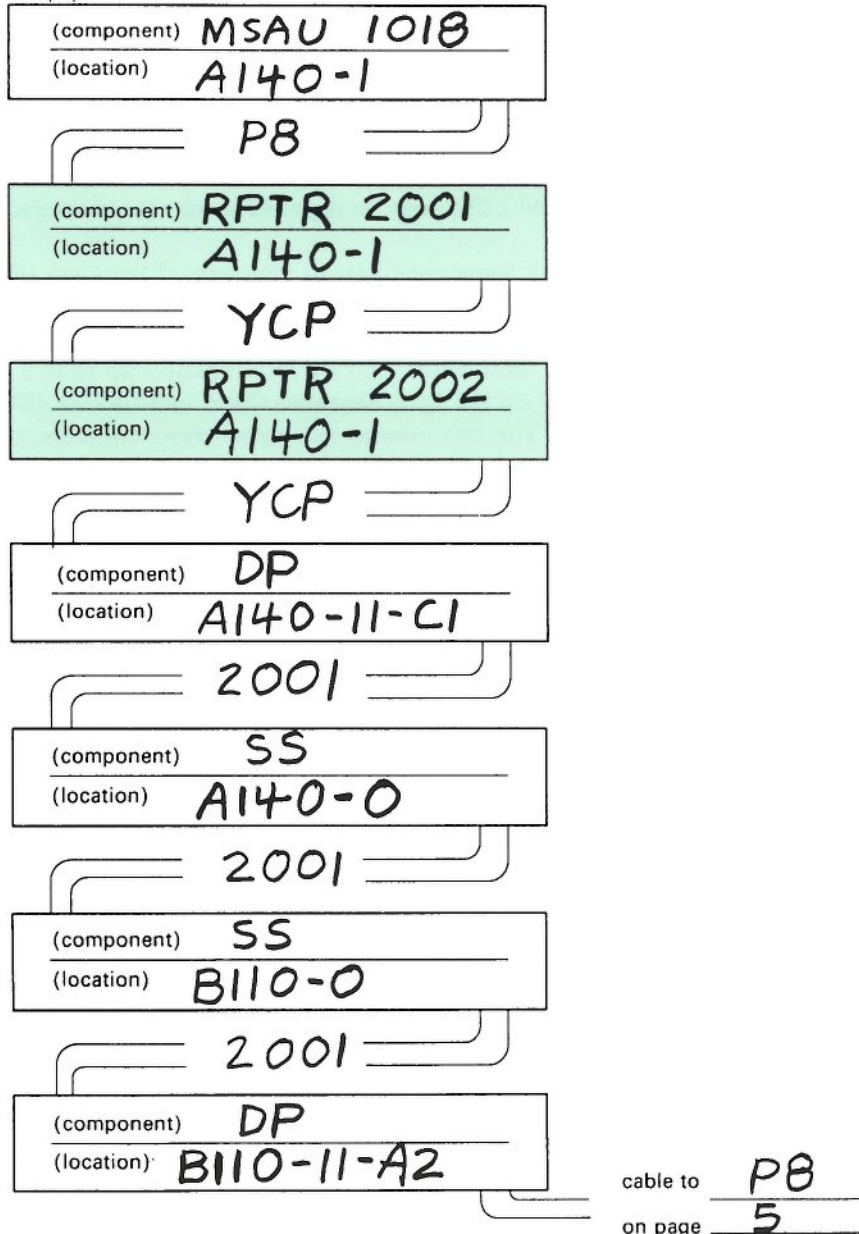

**Suggested Abbreviations:**

DP - Distribution Panel  
 P - Patch Cable  
 YCP - (Yellow) Crossover Patch Cable  
 OFP - Optical Fiber Patch Cable

FP - Faceplate  
 MB - Optical Fiber Mounting Bracket  
 SS - Surge Suppressor

MSAU - IBM 8228 Multistation Access Unit  
 RPTR - IBM 8218 Copper Repeater  
 OFRPTR - IBM 8219 Optical Fiber Repeater  
 OFCVTR - IBM 8220 Optical Fiber Converter

Figure A-3. Finding a Pair of IBM 8218 Copper Repeaters

# Ring Sequence Chart

Ring Number 1 Ring Data Rate  4  16 Page 8 of 8  
 cable from P8 Date 9-1-88  
 on page 7

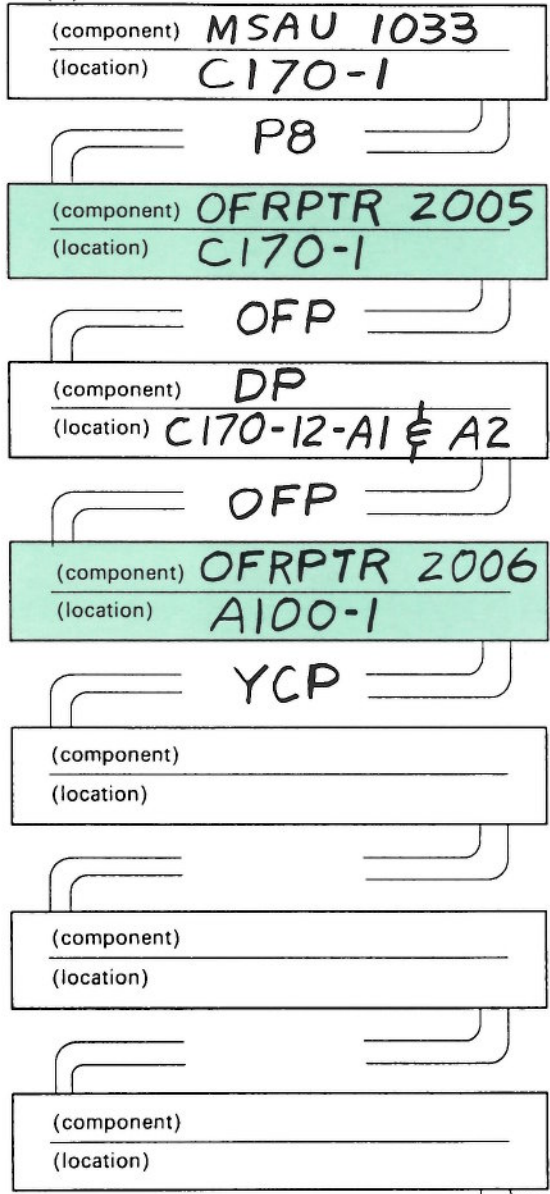

**Suggested Abbreviations:**

DP - Distribution Panel  
 P - Patch Cable  
 YCP - (Yellow) Crossover Patch Cable  
 OFP - Optical Fiber Patch Cable

FP - Faceplate  
 MB - Optical Fiber Mounting Bracket  
 SS - Surge Suppressor

MSAU - IBM 8228 Multistation Access Unit  
 RPTR - IBM 8218 Copper Repeater  
 OFRPTR - IBM 8219 Optical Fiber Repeater  
 OFCVTR - IBM 8220 Optical Fiber Converter

Figure A-4. Finding a Pair of IBM 8219 Optical Fiber Repeaters

# Ring Sequence Chart

Ring Number 1 Ring Data Rate  4  16 Page 9 of 9  
 cable from P8 on page 8 Date 9-1-88

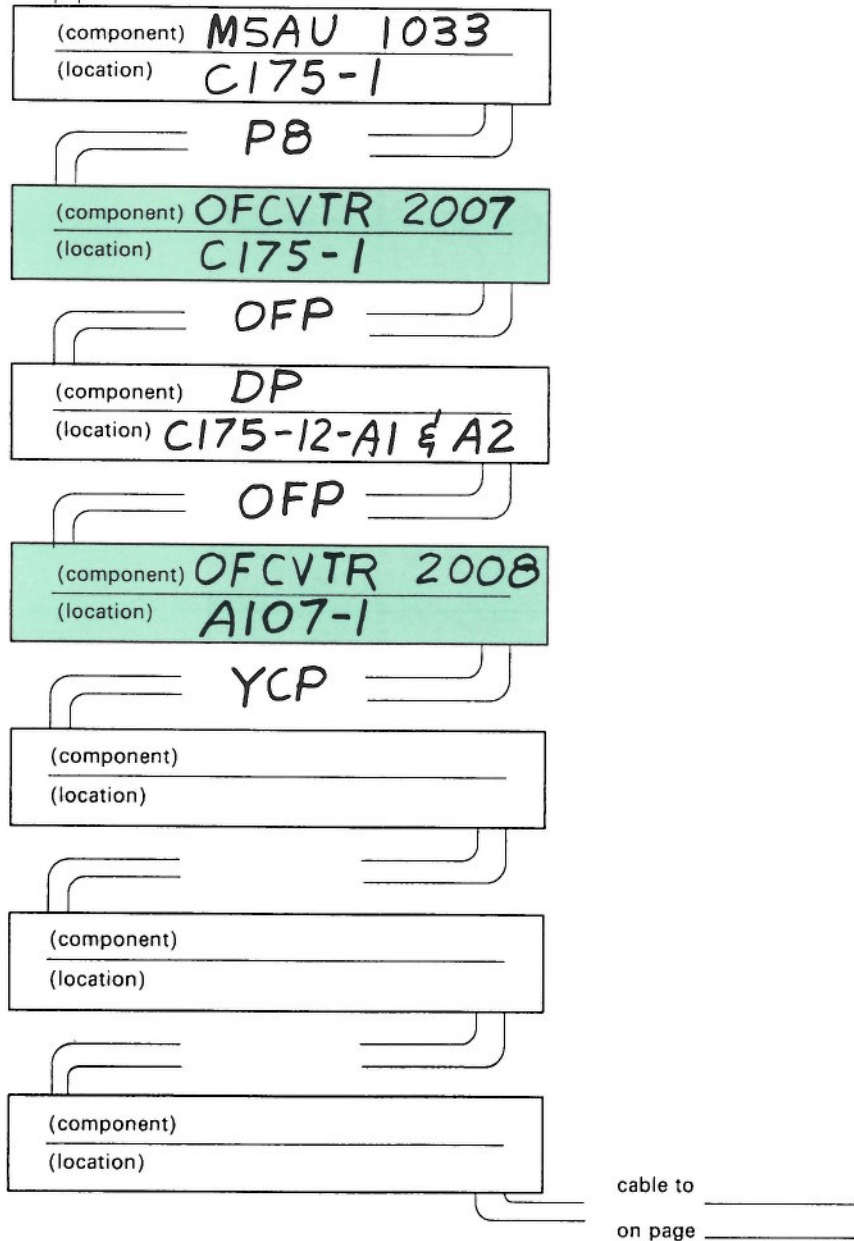

**Suggested Abbreviations:**

DP - Distribution Panel  
 P - Patch Cable  
 YCP - (Yellow) Crossover Patch Cable  
 OFP - Optical Fiber Patch Cable

FP - Faceplate  
 MB - Optical Fiber Mounting Bracket  
 SS - Surge Suppressor

MSAU - IBM 8228 Multistation Access Unit  
 RPTR - IBM 8218 Copper Repeater  
 OFRPTR - IBM 8219 Optical Fiber Repeater  
 OFCVTR - IBM 8220 Optical Fiber Converter

Figure A-5. Finding a Pair of IBM 8220 Optical Fiber Converters



---

## Finding the Component in a Given Position in the Ring Sequence

The problem determination procedures may require you to find a component in a particular position in the ring sequence. For example, you may have to find the “next downstream IBM 8228”, the “next upstream IBM 8228,” or the “last component in the wiring closet.” Whenever you are asked to perform such tasks, refer to the Ring Sequence Chart for the ring (see Figure A-6). The instructions on the following pages tell how to use the Ring Sequence Chart to perform such tasks.

If the Ring Sequence Chart is accurate and up-to-date, each IBM 8228, IBM 8218, IBM 8219, IBM 8220, patch cable, distribution panel, surge suppressor, and cable between wiring closets in the main ring path is recorded on the chart. Each IBM 8228 (MSAU), IBM 8218 Copper Repeater (RPTR), IBM 8219 Optical Fiber Repeater (OFRPTR), IBM 8220 Optical Fiber Converter (OFCVTR), distribution panel (DP), surge suppressor (SS), and cabling system faceplate (FP) is recorded in a separate rectangle on the chart. The patch cables and cables between wiring closets are recorded in the space between the rectangles. Patch cables are recorded with their length. For example, “P8” indicates an 8-foot patch cable. “YCP” indicates a yellow crossover patch cable. Cables between wiring closets are indicated by their cable number.

The “Ring Number” recorded at the top of the chart should be the same on all pages of the Ring Sequence Chart for a particular ring. There may be more than one page to the Ring Sequence Chart. The page number and the total number of pages are recorded at the top of each page.

The signal flow through the network is from the component recorded at the top of the page to the component at the bottom. In this guide, the order of the components on the chart is referred to as the “ring sequence.”



# Ring Sequence Chart

Ring Number 1 Ring Data Rate  4  16 Page 4 of 8  
 cable from P8 Date 9-1-88  
 on page 3

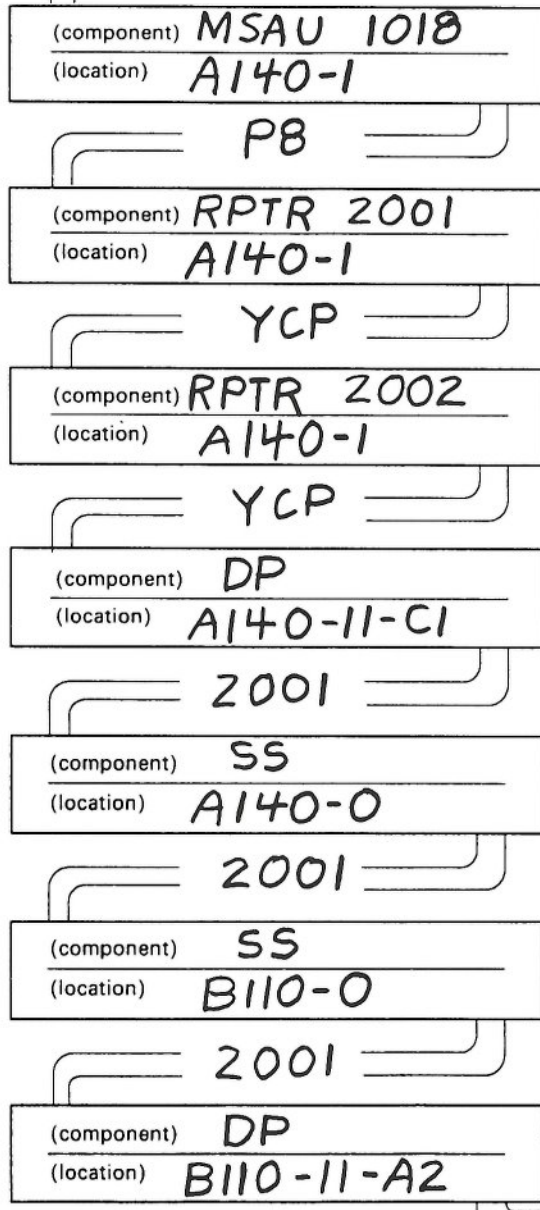

RING SEQUENCE



cable to P8  
on page 5

**Suggested Abbreviations:**

- |                                      |                       |                                           |
|--------------------------------------|-----------------------|-------------------------------------------|
| DP - Distribution Panel              | FP - Faceplate        | MSAU - IBM 8228 Multistation Access Unit  |
| P - Patch Cable                      | MB - Optical Fiber    | RPTR - IBM 8218 Copper Repeater           |
| YCP - (Yellow) Crossover Patch Cable | Mounting Bracket      | OFRPTR - IBM 8219 Optical Fiber Repeater  |
| OFP - Optical Fiber Patch Cable      | SS - Surge Suppressor | OFCVTR - IBM 8220 Optical Fiber Converter |

Figure A-6. Identifying the Ring Sequence Using the Ring Sequence Chart

## Finding the Next Downstream and Upstream IBM 8228

If you are working with a given IBM 8228 Multistation Access Unit and are instructed to find the next downstream or upstream IBM 8228, follow these steps:

1. Refer to the Ring Sequence Chart for the ring. Locate the rectangle indicating the IBM 8228 you are working with. The rectangle should contain the unit number of the IBM 8228 and its location. In the example in Figure A-7, the unit number of the target IBM 8228 is 1016. The IBM 8228 is mounted in rack number 1 in the wiring closet in location A140.

2. Proceed according to your instructions:

- a. To find the “next downstream” IBM 8228, move down the chart (downstream in the ring sequence) to the next rectangle. If the component recorded in the rectangle is a distribution panel (DP), move down the chart until you reach a rectangle that indicates an IBM 8228 (MSAU). (If you have to go to another page of the chart, be sure to go to the correct page.)

The number of the IBM 8228 and its location should be recorded in the rectangle. In the example in Figure A-7, IBM 8228 number 1017 is the next downstream IBM 8228 in the ring sequence. It is mounted in rack number 1 in the wiring closet in location A140.

- b. To find the “next upstream” IBM 8228, move up the chart (upstream in the ring sequence) to the preceding rectangle. If the component recorded in the rectangle is a distribution panel (DP), move up the chart until you reach a rectangle that indicates an IBM 8228 (MSAU). (If you have to go to another page of the chart, be sure to go to the correct page.)

The rectangle should contain the unit number of the IBM 8228 and its location. In the example, IBM 8228 number 1015 is the previous IBM 8228 in the ring sequence. It is mounted in rack number 1 in the wiring closet in location A140.

# Ring Sequence Chart

Ring Number 1 Ring Data Rate  4  16 Page 3 of 8  
 cable from P8 on page 2 Date 9-1-88

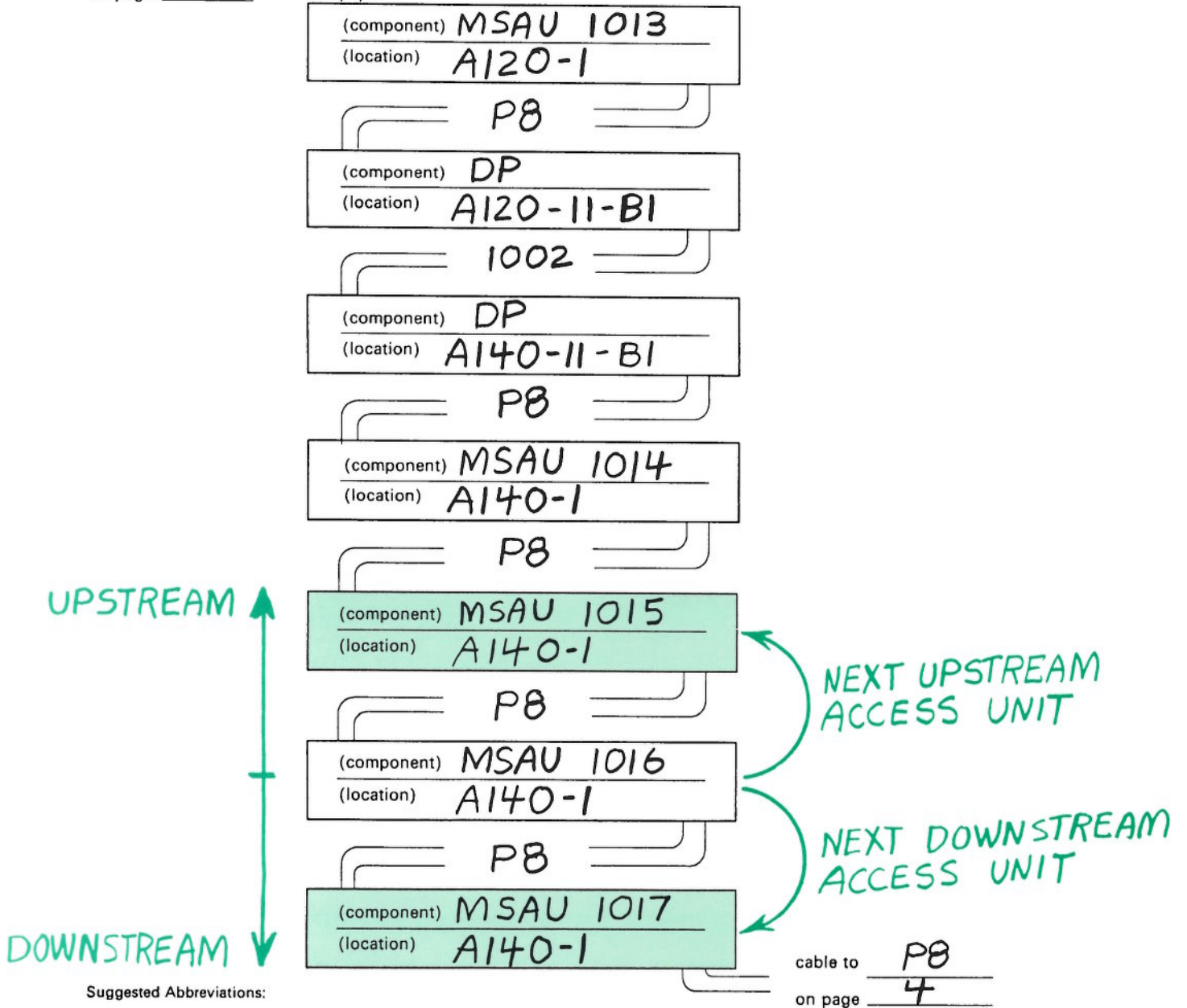

**Suggested Abbreviations:**

DP - Distribution Panel  
 P - Patch Cable  
 YCP - (Yellow) Crossover Patch Cable  
 OFP - Optical Fiber Patch Cable

FP - Faceplate  
 MB - Optical Fiber Mounting Bracket  
 SS - Surge Suppressor

MSAU - IBM 8228 Multistation Access Unit  
 RPTR - IBM 8218 Copper Repeater  
 OFRPTR - IBM 8219 Optical Fiber Repeater  
 OFCVTR - IBM 8220 Optical Fiber Converter

Figure A-7. Finding the Next Downstream and Upstream Access Unit

## Finding the First and Last Component in a Wiring Closet

The procedures may require you to find the first or last component in a particular wiring closet. In those cases, the term "component" means an IBM 8228 Multistation Access Unit, an IBM 8218 Copper Repeater, an IBM 8219 Optical Fiber Repeater, or an IBM 8220 Optical Fiber Converter. Follow these steps to locate the component in the designated position:

1. Refer to the Ring Sequence Chart for the ring. Start at the top of the page (or page 1 if there is more than one page) and move down the page until you reach a rectangle that indicates a distribution panel (DP) in a rack in the target wiring closet.

The location of the rack is recorded on the second line of the rectangle. Make sure that the location matches the location of the target wiring closet.

In the example in Figure A-8, the target wiring closet is in location A140. The first entry for a distribution panel in wiring closet A140 is recorded on page 3 of the Ring Sequence Chart. The rectangle indicates that the distribution panel is mounted in rack number 1 in wiring closet A140.

2. Proceed according to your instructions:
  - a. To find the "first" component in the wiring closet, move down the page to the next rectangle. The first component in the target wiring closet is recorded in that rectangle.

The rectangle should contain the unit number of the component and its location. In the example, the first component in wiring closet A140 is IBM 8228 (MSAU) number 1014, mounted in rack number 1.

- b. To find the "last" component in the wiring closet:
    - 1) Move down the page(s) until you reach the rectangle that indicates the last entry for the wiring closet. In the example, the last entry for the wiring closet is a distribution panel on page 4 of the Ring Sequence Chart.
    - 2) Move back up the page to the preceding rectangle. The last component in the target wiring closet is recorded in that rectangle.

The rectangle should contain the unit number of the component and its location. In the example, the last component in wiring closet A140 is IBM 8218 Copper Repeater (RPTR) number 2002, mounted in rack number 1.

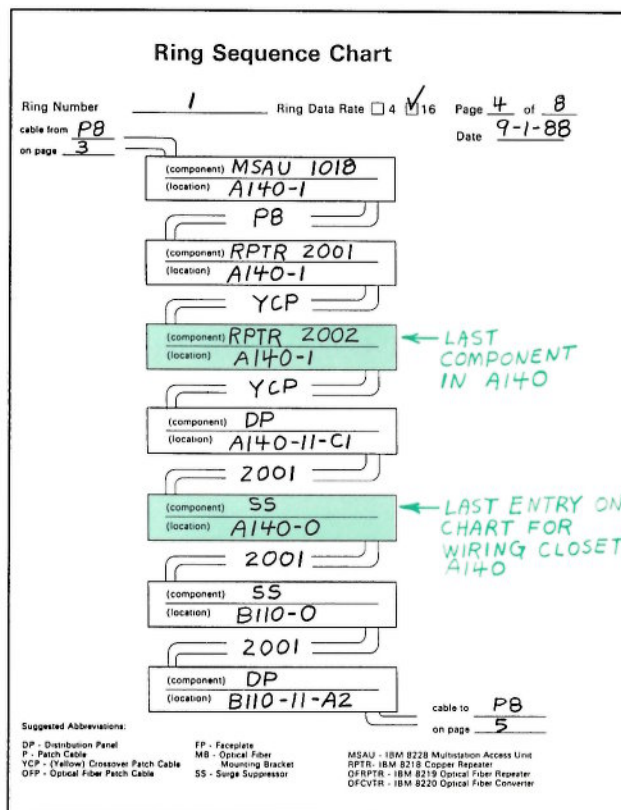
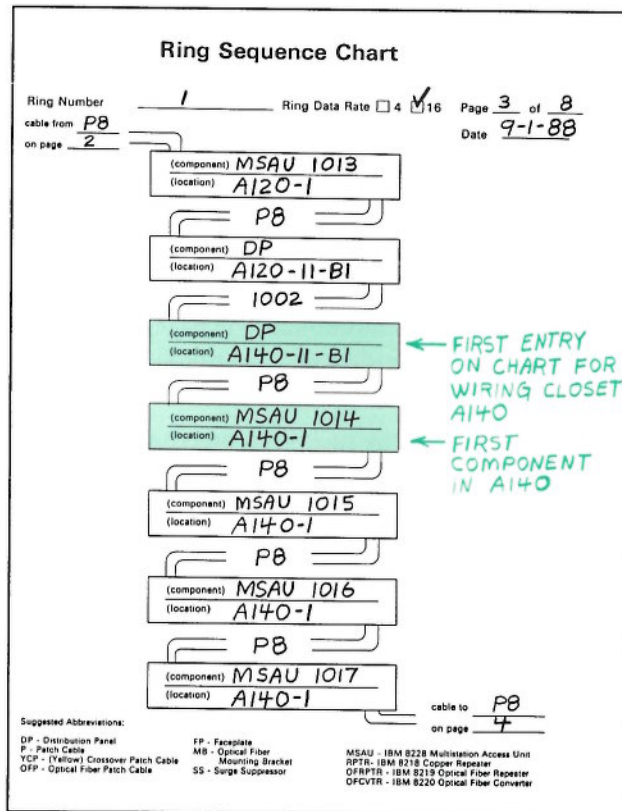

Figure A-8. Finding the First and Last Component in a Wiring Closet

## Finding Bridges

Use the instructions in this section whenever you must find a bridge. A bridge permits devices on one ring to communicate with devices on another. An IBM Token-Ring Network can consist of one or more rings joined together by bridges. In Figure A-9, three rings are connected by two bridges.

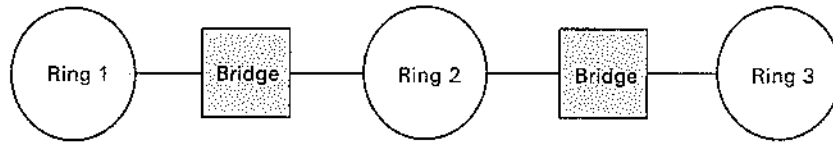

Figure A-9. A Three-Ring Network Connected by Two Bridges

Each bridge consists of one of the following computers:

- IBM Personal Computer AT
- IBM 7531/7532 Industrial Computers
- IBM Personal System/2 computers

with two IBM Token-Ring Network adapters of the same type and the IBM Token-Ring Network Bridge Program installed. The supported adapter types are:

- IBM Token-Ring Network PC Adapter II
- IBM Token-Ring Network Adapter/A.

Any of the devices connected to one of the rings can communicate with any of the other devices by sending data across the bridges and around the rings until the destination device is reached.

Follow these instructions to determine if there is a bridge connected to a particular ring:

1. Check the Bridge Planning Charts for the network. The ring number is recorded in Section 2 of the chart.
2. Section 2 indicates the physical location of the computer that contains the bridge adapters. Find the box in the middle of Section 2. The location of the device is recorded above the box. The number of the device is recorded below the box.

In Figure A-10 on page A-26, an IBM Token-Ring Network Bridge is connected to ring number 1 and ring number 2. The personal computer is in room number B111.

# Bridge Planning Chart

Date 1-2-86

Bridge Identification \_\_\_\_\_

## Section 1- Bridge Configuration Parameters

Bridge Number (default = 1) 1

Dump on Error (default = 0) 0

Restart on Error (default = 1) 1

### Primary Adapter

001 (001) Ring Number (002) (Default)

7 Hop Count Limit (Default = 7)

1 Limited Broadcast (Default = 1)

D800 (D800) Shared RAM (D400) (Default)

N/A Locally Administered Address

### Alternate Adapter

002 (002) Ring Number (Default)

7 Hop Count Limit (Default = 7)

1 Limited Broadcast (Default = 1)

D400 (D400) Shared RAM (Default)

N/A Locally Administered Address

## Section 2 - Physical Connections

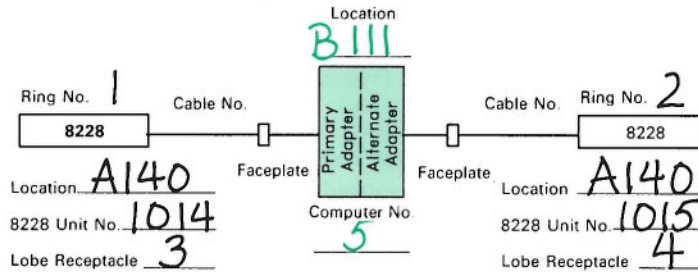

Figure A-10. Example of a Bridge Planning Chart



## How to Bypass an IBM 8228

Bypassing an IBM 8228 Multistation Access Unit permits the remainder of the ring to continue to function without the IBM 8228. However, any devices connected to the bypassed IBM 8228 will be separated from the ring. Any functions, such as file server or print server, performed by the devices attached to the IBM 8228 will be removed from the ring. Whenever an IBM 8228 must be bypassed, follow local procedures for temporarily suspending a device from the network.

To bypass an IBM 8228:

1. Disconnect the cables from the ring in (RI) and the ring out (RO) receptacles of the IBM 8228. (The RI receptacle is color-coded orange, and the RO is color-coded blue.) Continue with step 2.

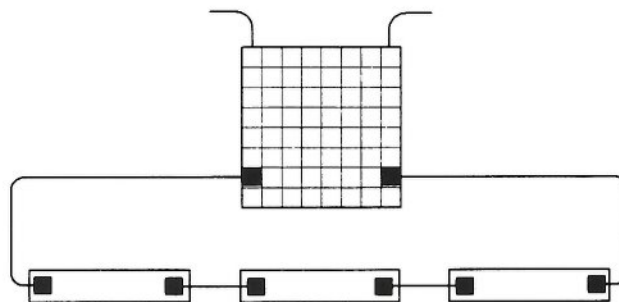
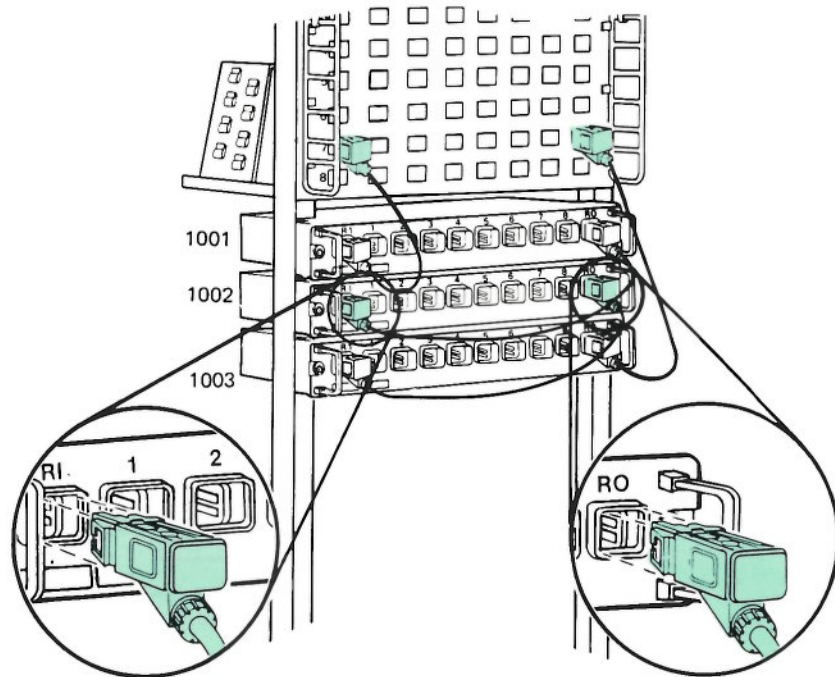



2. Connect the two cables together. If they will not reach one another, use a patch cable between them. This completes bypassing an IBM 8228.

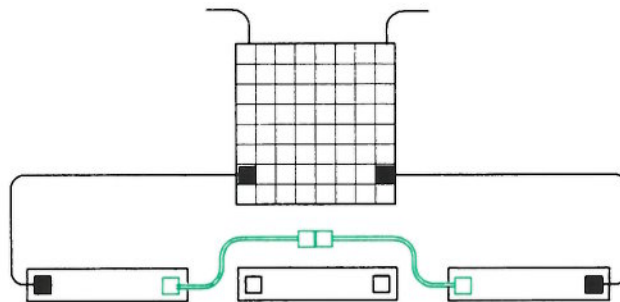
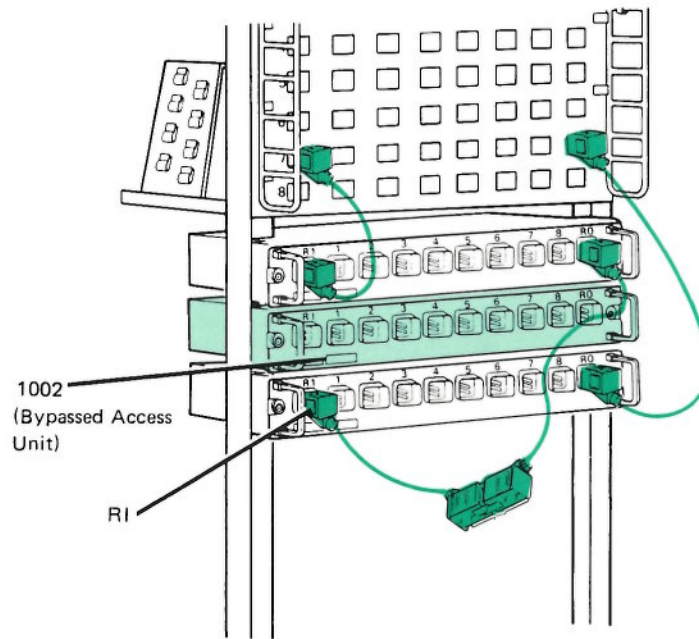

## How to Identify the Fault Domain

The problem determination procedures may require you to identify the "fault domain" for a soft error or a beaconing condition. Simply stated, the fault domain is the portion of the ring involved in the indicated error. The instructions below tell how to identify the fault domain depending on the indicated error. To identify the fault domain, you will need the IBM Token-Ring Network Ring Diagnostic, the IBM Local Area Network Manager, or the IBM LAN Manager, or the IBM Token-Ring Network Bridge Program and your Adapter Address to Physical Location Locator Chart and Ring Sequence Chart.

### Identifying the Fault Domain of a Beaconing Condition

A *beacon* is a frame sent by an adapter indicating a serious ring problem, such as a broken cable. An adapter is said to be *beaconing* if it is sending such a frame. Follow these instructions to identify the fault domain of a beaconing condition. The steps are keyed to the illustration.

1. Record the 12-character addresses for the beaconing device and its NAUN (Nearest Active Upstream Neighbor) displayed. The NAUN device is the first device (in the ring sequence) involved with the error. The beaconing device is the last device (in the ring sequence) involved with the error.

The sample screen below shows only one of the data area messages that may be displayed by the Ring Diagnostic when the ring status is "Beaconing". Refer to Chapter 5 for a description of the other possible messages. If you are using the IBM Local Area Network Manager, refer to the *IBM Token-Ring Network Manager User's Guide*. If you are using the IBM Token-Ring Network Bridge Program, refer to the *IBM Token-Ring Network Bridge Program User's Guide*. Continue with step 2.

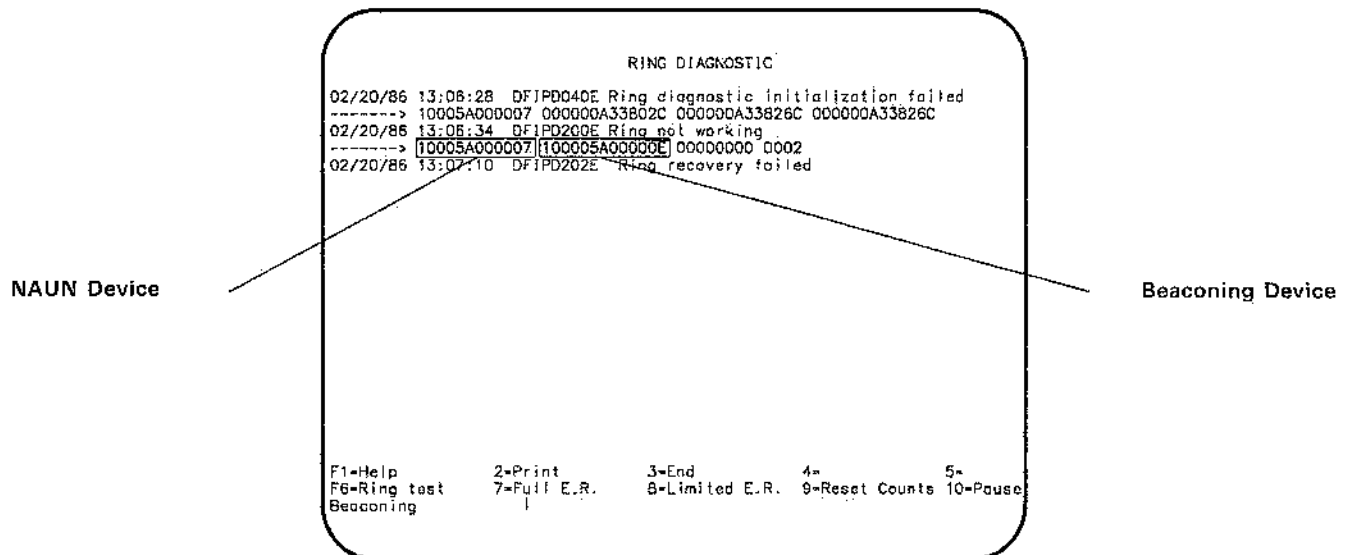

2. Find both adapter addresses on the Adapter Address to Physical Location Locator Charts. Continue with step 3.
3. Find the number of the IBM 8228 that each device is connected to. Continue with step 4.

### Adapter Address to Physical Location Locator Chart

Adapter Address	Physical Location	Device Identification	Ring Number	IBM 8228 Unit Number
10005A000000	100	PC40	1	1001
10005A000001	101	PC41	1	1001
10005A000002	102	PC42	1	1001
10005A000003	103	PC43	1	1001
10005A000004	104	PC44	1	1001
10005A000005	105	PC45	1	1001
10005A000006	107	PC46	1	1001
② 10005A000007	108	PC47	1	1002 ③
10005A000008	109	PC48	1	1002
10005A000009	110	PC49	1	1002
10005A00000A	111	PC50	1	1002
10005A00000B	112	PC51	1	1002
10005A00000C	113	PC52	1	1002
10005A00000D	114	PC53	1	1002
② 10005A00000E	115	PC54	1	1003 ③
10005A00000F	116	PC55	1	1003
10005A000010	117	PC56	1	1003
10005A000011	118	PC57	1	1003

- Use the Ring Sequence Chart to define the limits of the fault domain. Start at the NAUN's IBM 8228 and follow the Ring Sequence Chart *in ring sequence order* until you reach the beaconing device's IBM 8228.

The fault domain consists of all of the IBM 8228s in the ring sequence from the NAUN device's IBM 8228 to the beaconing device's IBM 8228, and all of the devices and cables connected to those IBM 8228s. The fault domain also includes any IBM 8218 Copper Repeaters, IBM 8219 Optical Fiber Repeaters, and IBM 8220 Optical Fiber Converters in the ring sequence between the NAUN device's IBM 8228 and the beaconing device's IBM 8228.

Figure A-11 on page A-32 illustrates the fault domain in this example. The fault domain consists of two IBM 8228s (numbers 1002 and 1003), and all of the devices and cables connected to those IBM 8228s. For illustrative purposes, all of the devices in the fault domain are not shown.

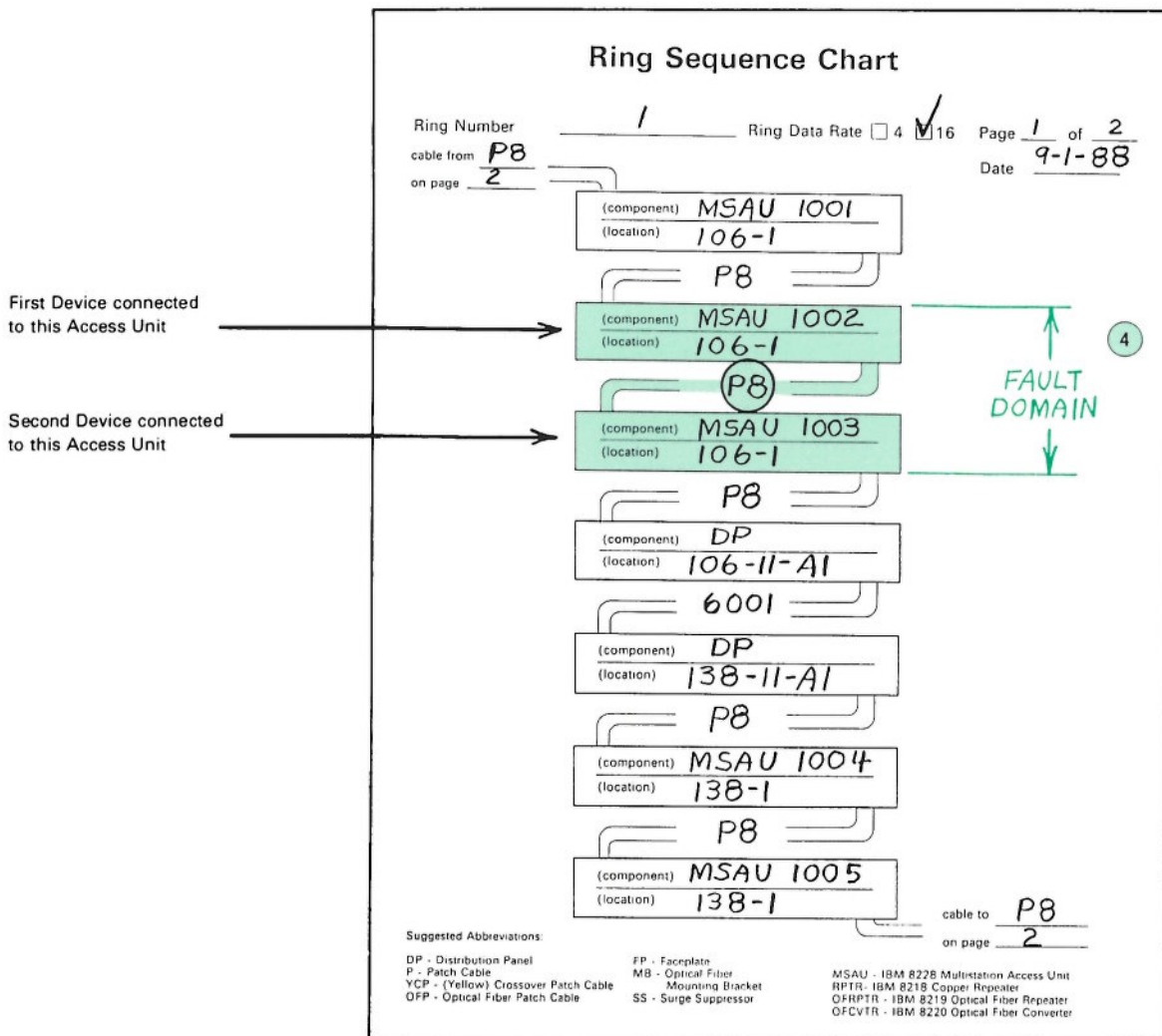

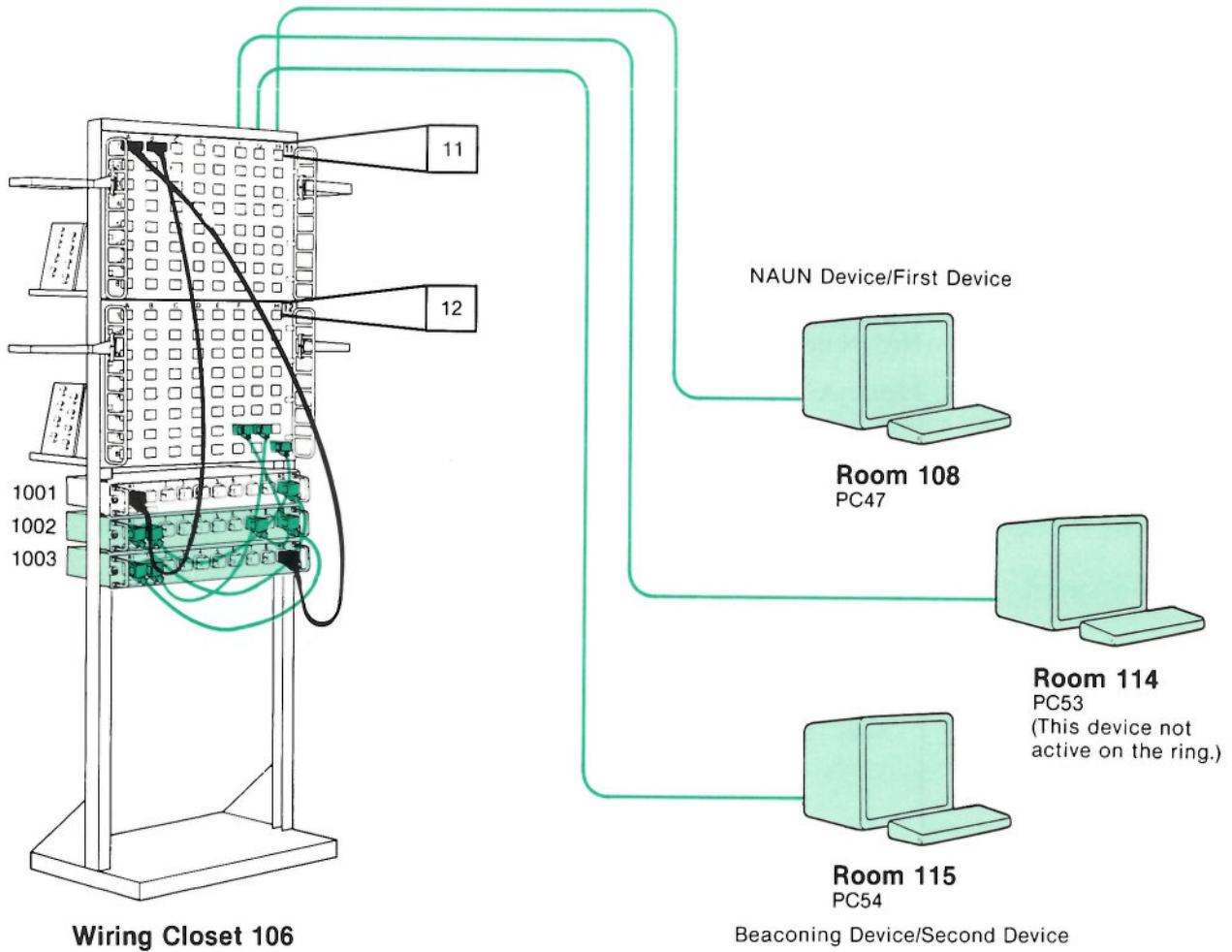

**Fault Domain Includes:**

- Access Units 1002 and 1003, and the patch cables connecting them
- The devices connected to access units 1002 and 1003, and the cables that connect these devices to the access units.  
For illustrative purposes, all of the devices are not shown.

Figure A-11. Identifying the Fault Domain



## Identifying the Fault Domain for Beaconing on the Backup Ring

When beaconing occurs on the backup ring, the beaconing device and its Next Active Upstream Neighbor (NAUN) are both IBM 8220 optical fiber subsystems. An IBM 8220 optical fiber subsystem is a segment of the main ring path containing only optical fiber cabling with a converter at each end. In this case, the addresses indicated by the error message are the addresses of the downstream (RO) IBM 8220s in the two subsystems (the downstream IBM 8220 is the one with the RI/RO switch set to the RO position). Follow these instructions to identify the fault domain for a beaconing condition on the backup ring.

1. Record the 12-character addresses for the beaconing device (IBM 8220) and its NAUN (IBM 8220).
2. Find both adapter (IBM 8220) addresses on the Adapter Address to Physical Location Locator Charts.
3. Find the device identification for each IBM 8220.

### Adapter Address to Physical Location Locator Chart

Adapter Address	Physical Location	Device Identification	Ring Number	IBM 8228 Unit Number
10005A000000	100	PC40	1	1001
10005A000001	101	PC41	1	1001
10005A000002	102	PC42	1	1001
10005A000003	103	PC43	1	1001
10005A000004	104	PC44	1	1001
10005A000005	105	PC45	1	1001
10005A000006	107	PC46	1	1001
10005A000007	108	PC47	1	1002
10005A000008	109	PC48	1	1002
10005A000009	110	PC49	1	1002
10005A00000A	111	PC50	1	1002
10005A00000B	112	PC51	1	1002
10005A00000C	113	PC52	1	1002
10005A00000D	114	PC53	1	1002
10005A29001E	106-1		1	4001
10005A29001F	208-1		1	4002
10005A290010	208-1		1	4003
10005A290011	106-1		1	4004

Beaconing Device →  
Naun →

4. Using the Ring Sequence Chart, locate the device identification number of the beaoning IBM 8220. The fault domain starts with this device. Now, following ring sequence on the chart, locate the device identification number of the NAUN. This is the last component in the fault domain.

The fault domain consists of three IBM 8220s (numbered 4002, 4003, and 4004), two IBM 8228s (1004 and 1005) and all of the cables connecting these devices.

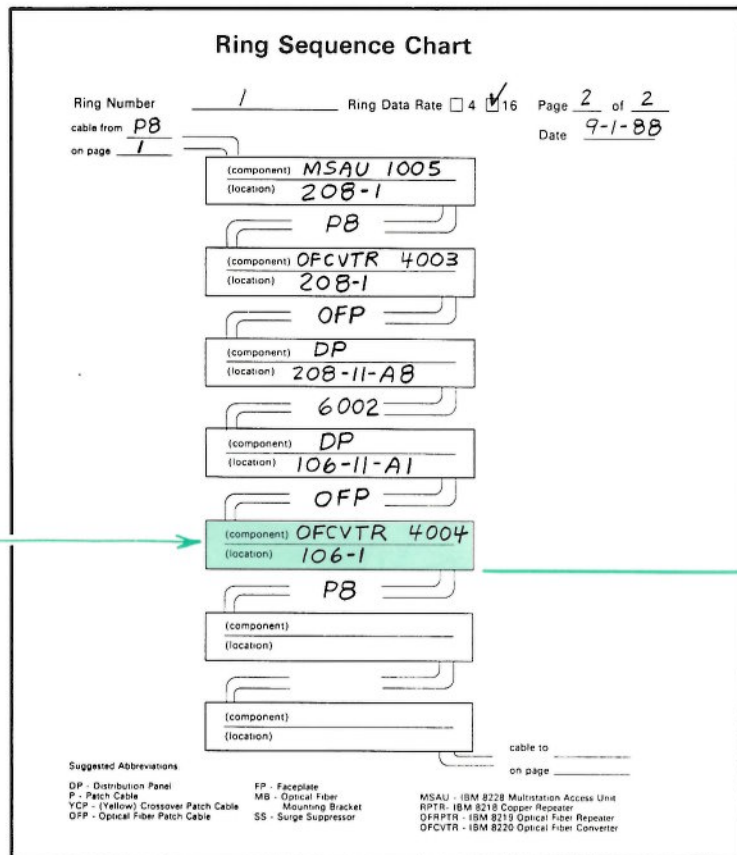
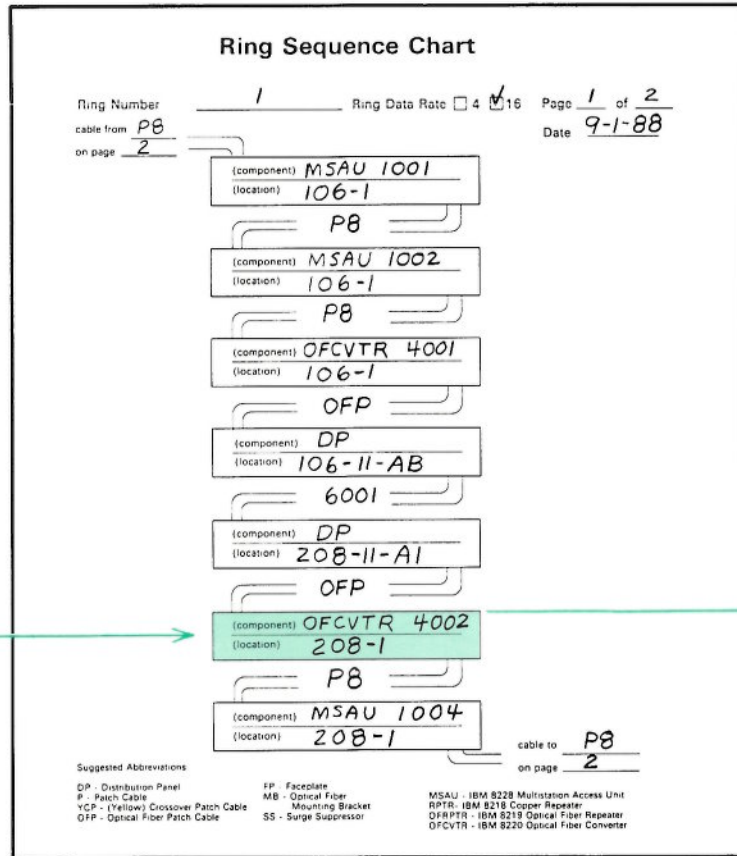



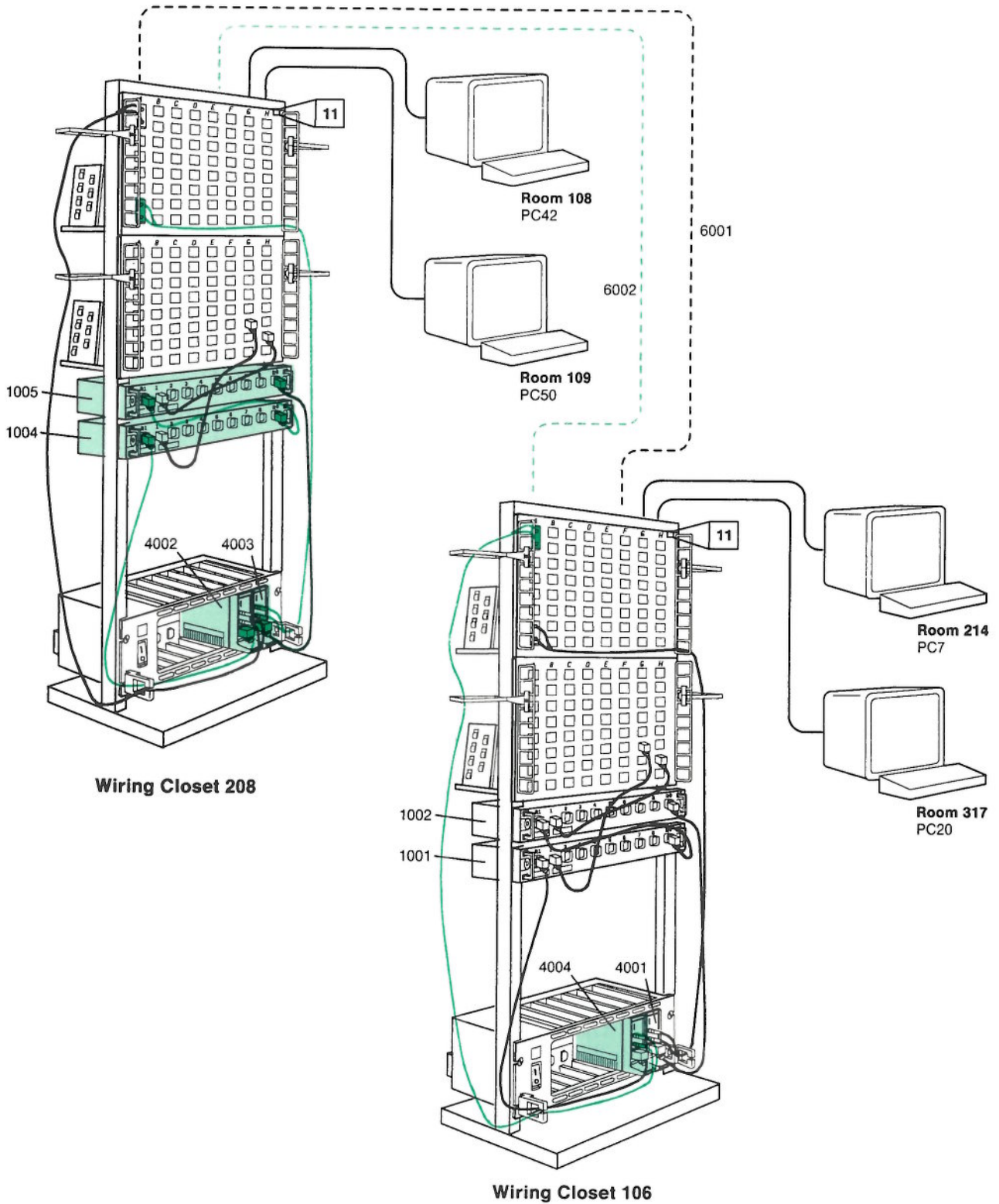

Figure A-12. Identifying the Fault Domain for Beaconing on the Backup Ring

## Identifying the Fault Domain of a Soft Error

A *soft error* is an error on the network that affects the network's performance but does not, by itself, affect its overall reliability. (If the number of soft errors reaches the *ring error limit*, reliability is affected. See Chapter 5 for an explanation of the "DFIPD101E Ring error limit exceeded" data area message displayed by the Ring Diagnostic.) Follow these instructions to identify the fault domain of a soft error. The steps are keyed to the illustration.

1. Record the 12-character addresses and the error counts for the first device and second device displayed. The first device is the device containing the "First Adapter's Address" and is the first device (in the ring sequence) involved with the error. The second device is the device containing the "Second Adapter's Address" and is the second device (in the ring sequence) involved with the error. The error count for a device is the two-digit hex code value that immediately follows its adapter address.

The sample screen below shows one of the data area messages that may be displayed by the Ring Diagnostic when the ring status is "Soft Error". Refer to Chapter 5 for a description of the other possible messages. If you are using the IBM Local Area Network Manager, refer to the *IBM Token-Ring Network Manager User's Guide*. If you are using the IBM Token-Ring Network Bridge Program, refer to the *IBM Token-Ring Network Bridge Program User's Guide*. Continue with step 2.

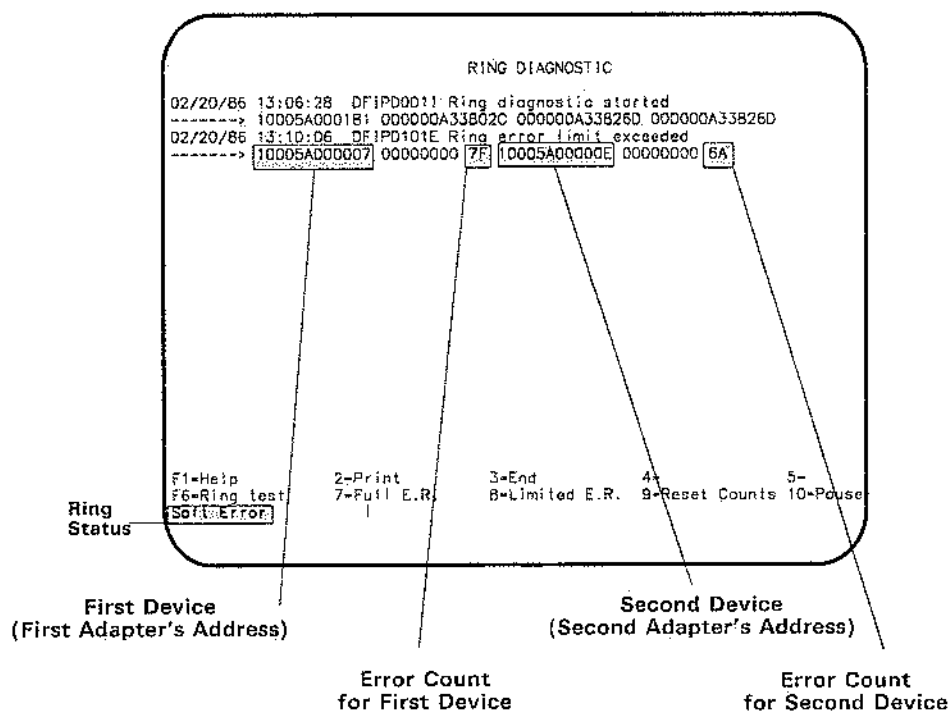

2. Find both adapter addresses on the Adapter Address to Physical Location Locator Charts. Continue with step 3.
3. Find the number of the IBM 8228 that each device is connected to. Continue with step 4.

### Adapter Address to Physical Location Locator Chart

Adapter Address	Physical Location	Device Identification	Ring Number	IBM 8228 Unit Number
10005A000000	100	PC40	1	1001
10005A000001	101	PC41	1	1001
10005A000002	102	PC42	1	1001
10005A000003	103	PC43	1	1001
10005A000004	104	PC44	1	1001
10005A000005	105	PC45	1	1001
10005A000006	107	PC46	1	1001
② 10005A000007	108	PC47	1	1002 ③
10005A000008	109	PC48	1	1002
10005A000009	110	PC49	1	1002
10005A00000A	111	PC50	1	1002
10005A00000B	112	PC51	1	1002
10005A00000C	113	PC52	1	1002
10005A00000D	114	PC53	1	1002
② 10005A00000E	115	PC54	1	1003 ③
10005A00000F	116	PC55	1	1003
10005A000010	117	PC56	1	1003
10005A000011	118	PC57	1	1003

- Use the Ring Sequence Chart to define the limits of the fault domain. Start at the first device's IBM 8228 and follow the Ring Sequence Chart *in ring sequence order* until you reach the second device's IBM 8228.

The fault domain consists of all of the IBM 8228s in the ring sequence from the first device's IBM 8228 to the second device's IBM 8228, and all of the devices and cables connected to those IBM 8228s. The fault domain also includes any IBM 8218 Copper Repeaters and IBM 8219 Optical Fiber Repeaters in the ring sequence between the first device's IBM 8228 and the second device's IBM 8228.

Figure A-11 on page A-32 illustrates the fault domain in this example. The fault domain consists of two IBM 8228s (numbers 1002 and 1003), and all of the devices and cables connected to those IBM 8228s. For illustrative purposes, all of the devices in the fault domain are not shown.

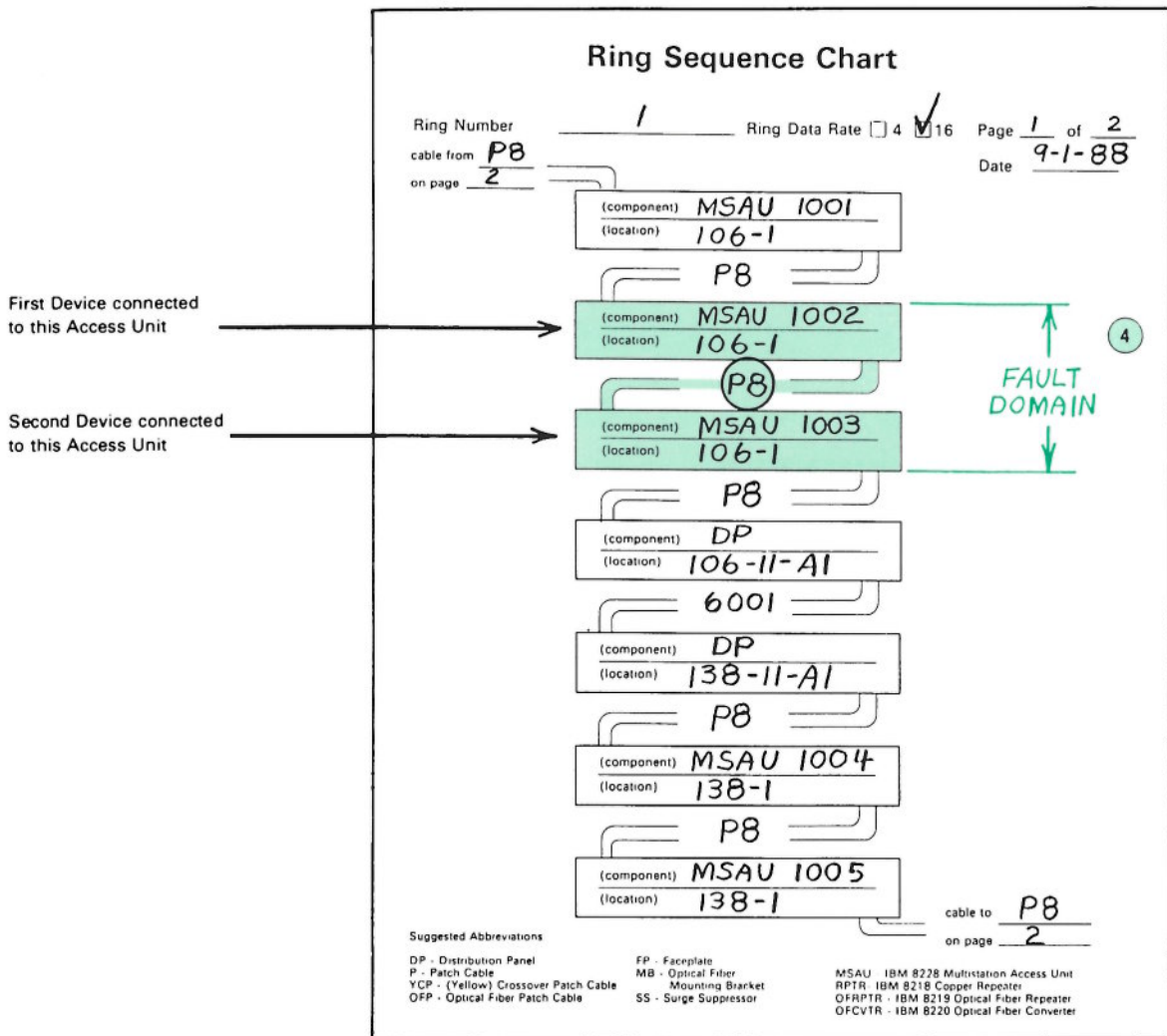



## Appendix B. Return Codes

DLC and Direct Interface Return Codes (CCB_RETCODE)	B-3
DLC and Direct Interface Return Codes	B-5
DLC Status Codes	B-20
DLC Status Table	B-20
DLC Status Codes	B-21
Suggested Actions in Response to DLC Status	B-22
NETBIOS Return Codes (NCB_RETCODE)	B-24
NETBIOS Return Codes	B-26
Adapter Status Parameter Table	B-35
Frame Status	B-36
Exception Indications	B-37
Adapter Check for CCB1	B-37
Adapter Check for CCB2	B-37
Adapter Check for CCB3	B-39
IBM Token-Ring Network Adapter Check Reason Codes for All CCBs	B-41
IBM PC Network Adapter Check Reason Codes for All CCBs	B-42
Network Status	B-43
Network Status for CCB1	B-43
Network Status for CCB2	B-43
Network Status for CCB3	B-44
IBM Token-Ring Network Status Codes for All CCBs	B-46
IBM PC Network Status Codes for All CCBs	B-47
Bring-Up Errors for All CCBs	B-48
Bring-up Error Codes for All CCBs	B-48
IBM Token-Ring Network Adapter Open Errors for All CCBs	B-49
Open Error Codes for All CCBs	B-49
Phases	B-49
Errors	B-49
Suggested Actions in Response to Open Errors	B-50
Recommended Actions Table	B-52
IBM PC Network Adapter Open Errors for All CCBs	B-53
IBM PC System Detected Errors	B-53
IBM PC System Detected Errors for CCB1	B-53
IBM PC System Detected Errors for CCB2	B-54
IBM PC System Detected Errors for CCB3	B-56
System Action Exceptions for OS/2	B-59
System Action Exceptions for CCB2	B-59
System Action Exceptions for CCB3	B-61



**DLC and Direct Interface Return Codes (CCB\_RETCODE)**

Code	Meaning	CCB1	CCB2	CCB3
00	Operation completed successfully	X	X	X
01	Invalid command code	X	X	X
02	Duplicate command, one already outstanding	X	X	X
03	Adapter open, should be closed	X	X	X
04	Adapter closed, should be open	X	X	
05	Required parameter(s) not provided	X	X	X
06	Option(s) invalid or incompatible	X	X	X
07	Command canceled, unrecoverable failure	X	X	X
08	Unauthorized access priority	X	X	X
09	Adapter not initialized, should be initialized	X		
0A	Command canceled by user request	X	X	X
0B	Command canceled, adapter closed while command in progress	X	X	X
0C	Command completed successfully, adapter not open	X		
10	Adapter open, NETBIOS not operational	X		
11	DIR.TIMER.SET or DIR.TIMER.CANCEL error	X	X	X
12	Available work area exceeded	X		
13	Invalid LOG.ID	X	X	X
14	Invalid shared RAM segment or size	X		
15	Lost log data, inadequate buffer space, log reset	X	X	X
16	Requested buffer size exceeds pool length	X	X	X
17	Command invalid, NETBIOS operational	X		
18	Invalid buffer length	X	X	X
19	Inadequate buffers available for request	X	X	X
1A	User length too large for buffer length	X	X	X
1B	The CCB_PARM_TAB pointer is invalid	X	X	X
1C	A pointer in the CCB parm table is invalid	X	X	X
1D	Invalid CCB_ADAPTER value	X	X	X
20	Lost data on receive, no buffers available	X	X	X
21	Lost data on receive, inadequate buffer space	X	X	X
22	Error on frame transmission, check TRANSMIT.FS data	X	X	X
23	Error in frame transmit or strip process	X	X	X
24	Unauthorized MAC frame	X	X	X
25	Maximum commands exceeded	X	X	X
26	Unrecognized command correlator	X		
27	Link not transmitting I frames, state changed from link opened	X	X	X
28	Invalid transmit frame length	X	X	X
30	Inadequate receive buffers for adapter to open	X	X	X
32	Invalid NODE_ADDRESS	X	X	X
33	Invalid adapter receive buffer length defined	X	X	X
34	Invalid adapter transmit buffer length defined	X	X	X



## CCB Return Codes

Code	Meaning	CCB1	CCB2	CCB3
40	Invalid STATION_ID	X	X	X
41	Protocol error, link in invalid state for command	X	X	X
42	Parameter exceeded maximum allowed	X	X	X
43	Invalid SAP_VALUE or value already in use	X	X	X
44	Invalid routing information field	X	X	X
45	Requested group membership in non-existent group SAP	X	X	X
46	Resources not available	X	X	X
47	SAP cannot close unless all link stations are closed	X	X	X
48	Group SAP cannot close, individual SAPs not closed	X	X	X
49	Group SAP has reached maximum membership	X	X	X
4A	Sequence error: incompatible command in progress	X	X	X
4B	Station closed without remote acknowledgment	X	X	X
4C	Sequence error, cannot close, DLC commands outstanding	X	X	X
4D	Unsuccessful link station connection attempted	X	X	X
4E	Member SAP not found in group SAP list	X	X	X
4F	Invalid remote address, may not be a group address	X	X	X
50	Invalid pointer in CCB_POINTER field		X	
52	Invalid application program ID		X	X
53	Invalid application program key code		X	X
54	Invalid system key code		X	X
55	Buffer is smaller than buffer size given on DLC.OPEN.SAP		X	X
56	Adapter's system process is not installed		X	
57	Inadequate stations available		X	X
58	Invalid CCB_PARAMETER_1 parameter		X	X
59	Inadequate queue elements to satisfy request		X	X
5A	Initialization failure, cannot open adapter		X	X
5B	Error detected in chained READ command		X	
5C	Direct stations not assigned to application program		X	X
5D	Device Driver Interface not installed		X	
5E	Requested adapter is not installed		X	X
5F	Chained CCBs must all be for the same adapter		X	
60	Adapter initializing, command not accepted		X	X
61	Number of allowed application programs has been exceeded		X	X
62	Command cancelled by system action		X	X
63	Direct stations not available		X	X
64	Invalid DDNAME parameter		X	X
65	Inadequate GDT selectors to satisfy request		X	X
67	Command cancelled, CCB resources purged			X
68	Application ID not valid for interface		X	X
69	Segment associated with request cannot be locked		X	

Code	Meaning	CCB1	CCB2	CCB3
FF	Command in progress	X	X	X

### DLC and Direct Interface Return Codes

---

#### Hex 00

**Explanation:** Operation completed successfully.

---

#### Hex 01

**Explanation:** Invalid command code.

**Cause:** CCB\_COMMAND did not contain a recognized command code.

**Action:** Try again, using a valid command.

---

#### Hex 02

**Explanation:** Duplicate command--one already outstanding.

**Cause:** Only one command of this type may be outstanding at one time.

**Action:** Wait for the previously issued command to complete.

---

#### Hex 03

**Explanation:** Adapter open--should be closed.

**Cause:** This command may only be issued when the adapter is not open.

**Action:** Close the adapter or issue the correct command.

**Note:** For an exception to the above, see the DIR.OPEN.ADAPTER command in the *IBM Local Area Network Technical Reference*.

---

#### Hex 04

**Explanation:** Adapter closed--should be open.

**Cause:** This command may only be issued when the adapter is open.

**Action:** Open the adapter.

---

#### Hex 05

**Explanation:** Required parameter(s) not provided.

**Cause:** At least one required parameter for which no default is available is coded as zero.

**Action:** Correct the value and try again.

---

**Hex 06**

**Explanation:** Option(s) invalid, or incompatible.

**Cause:** The options selected are not a valid combination. For example, this return code can occur if an attempt is made to open a SAP if that SAP has an XID command handling option different from that of the GSAP with which it is associated. In that case the command will have completed up to the point where the failing item in the GSAP list was encountered. Otherwise, no action will have been taken for the command.

**Action:** Correct the options and try again or issue a DLC modify for the remaining GSAP list members.

---

**Hex 07**

**Explanation:** Command canceled--unrecoverable failure.

**Cause:** The adapter has been closed because of an error condition.

**Action:** Analyze the error indications. If the error is not permanent, issue DIR.INITIALIZE (for DOS) and DIR.OPEN.ADAPTER (for DOS and OS/2).<sup>1</sup>

---

**Hex 08**

**Explanation:** Unauthorized access priority.

**Cause:** The requested access priority has not been authorized.

**Action:** Lower the priority specified with either the OPTIONS\_PRIORITY or the ACCESS\_PRIORITY value and reissue the command.

---

**Hex 09**

**Explanation:** Adapter not initialized--should be initialized.

**Cause:** This command may be completed only if the adapter is initialized.

**Action:** Issue the DIR.INITIALIZE command.

---

**Hex 0A**

**Explanation:** Command canceled by user request.

**Cause:** This is the expected response when a command is canceled by an application program command.

**Action:** None.

---

**Hex 0B**

**Explanation:** Command canceled--adapter closed while command in progress.

**Cause:** A DIR.CLOSE.ADAPTER command was issued while this command was in process.

**Action:** As appropriate for the application program.

---

<sup>1</sup> OS/2 is a trademark of the IBM Corporation.

---

**Hex 0C**

**Explanation:** Command completed successfully—adapter not open.

**Cause:** Information only. The command may execute even though the adapter is not open.

**Action:** None.

---

**Hex 10**

**Explanation:** Adapter open—NETBIOS not operational.

**Cause:** One of the following:

- The DIR.OPEN.ADAPTER command has been passed NETBIOS parameters and NETBIOS code is not loaded.
- One or more NETBIOS parameters in the DIR.OPEN.ADAPTER command was incorrect.

**Note:** This can occur if the NCB\_MAX\_NAMES or NCB\_MAX\_SESSIONS values are not less than 255, or if there is insufficient work space available to satisfy the values of NCB\_STATIONS, NCB\_MAX\_NAMES, NCB\_MAX, and NCB\_MAX\_SESSIONS.

**Action:**

- To continue without NETBIOS, do nothing. The adapter is open.
  - To use NETBIOS, close the adapter, make appropriate changes, and reissue DIR.OPEN.ADAPTER.
- 

**Hex 11**

**Explanation:** DIR.TIMER.SET or DIR.TIMER.CANCEL error.

DIR.TIMER.SET:

**Cause:** The TIMER\_VALUE is not in the 0 - 13107 range.

**Action:** Set a valid value and try again.

DIR.TIMER.CANCEL:

**Cause:** The DIR.TIMER.SET command to be canceled was not found.

**Action:** None

---

**Hex 12**

**Explanation:** Available work area exceeded.

**Cause:** Requested parameters exceeded allotted memory. Either the adapter support software work area or the work area provided by the application program is not adequate.

**Action:** Reduce MAX.STATION and/or MAX.SAP values or increase memory to the value returned in parameter DLC.WORK.LEN.ACT.

---

**Hex 13**

**Explanation:** Invalid LOG.ID.

**Cause:** The requested LOG.ID is not defined.

**Action:** Adjust the value accordingly.

---

**Hex 14**

**Explanation:** Invalid shared RAM segment or size.

**Cause:** The value is not an allowable value.

**Action:** Adjust the value accordingly.

---

**Hex 15**

**Explanation:** Lost log data, inadequate buffer space—log reset.

**Cause:** The buffer pointed to by DIR.READ.LOG or DLC.STATISTICS was too short to continue the entire log contents. The information that could not be placed in the buffer was *lost* if the command indicated “reset.”

**Action:** The next time the command is issued, increase the size of the buffer.

---

**Hex 16**

**Explanation:** Requested buffer size exceeds pool length.

**Cause:** The buffer pool is not large enough to hold one buffer.

**Action:** Issue the command with either smaller buffers or larger pool.

---

**Hex 17**

**Explanation:** Command invalid—NETBIOS operational.

**Cause:** The command being issued would cause a change to NETBIOS parameters that are currently operational.

**Action:** To issue the command, the adapter must be closed and then re-opened, either without NETBIOS, or with NETBIOS parameters that avoid the conflict.

---

**Hex 18**

**Explanation:** Invalid SAP buffer length.

**Cause:** The specified buffer size must be at least 80 bytes and a multiple of 16.

**Action:** Specify the buffer size accordingly.

---

**Hex 19**

**Explanation:** Inadequate buffers available for request.

**Cause:** A request was made for more buffers than were available.

**Action:** Either issue the command requesting fewer buffers, or wait until more buffers become available and try again.

---

---

**Hex 1A**

**Explanation:** USER LENGTH too large for buffer length.

**Cause:** The user requested area is too large.

**Action:** Reduce the user space specified by the USER\_LENGTH field.

---

**Hex 1B**

**Explanation:** The CCB\_PARM\_TAB pointer is invalid.

**Cause:** The CCB\_PARM\_TAB field value is either pointing into the PC system interrupt vector area or the offset is too near the end of the segment and wrap-around will occur on some of the fields.

**Action:** Re-issue the command with the CCB\_PARM\_TAB field corrected.

---

**Hex 1C**

**Explanation:** A pointer in the CCB Parm table is invalid.

**Cause:** A pointer value in the CCBs parameter table is either pointing into the PC system interrupt vector area or the offset is too near the end of the segment and wrap-around will occur on some of the fields.

**Action:** Re-issue the command with the CCB\_PARM\_TAB field corrected.

---

**Hex 1D**

**Explanation:** Invalid CCB\_ADAPTER value.

**Cause:** The value is outside the prescribed range.

**Action:** Set an acceptable value.

---

**Hex 20**

**Explanation:** Lost data on receive, no buffers available.

**Cause:** There were no available buffers in the SAP's buffer pool. The frame was lost. This return code will not occur if the frame was an I frame.

**Action:** Free some buffers via BUFFER.FREE, then reissue the receive command. The frame was lost if it was for a link station.

---

**Hex 21**

**Explanation:** Lost data on receive--inadequate buffer space.

**Cause:** There was inadequate buffer space in the SAP's buffer pool to contain the entire frame. As much of the frame as possible was placed into receive buffers. The remainder of the message was lost. This return code will not occur if the frame was an I frame.

**Action:** Free some buffers via BUFFER.FREE and reissue the receive command.

---

---

**Hex 22**

**Explanation:** Error on frame transmission—check TRANSMIT\_FS data.

**Cause:** The frame may or may not have been received by the destination adapter, as indicated by the FS byte.

**Action:** As appropriate for the application program.

---

**Hex 23**

**Explanation:** Error in frame transmit or read back checking

**Cause:** An error was detected either during the frame transmission or when the frame was read back and checked.

**Action:** As appropriate for the application program.

---

**Hex 24**

**Explanation:** Unauthorized MAC frame.

**Cause:** Possible causes:

- The adapter is not authorized to send a MAC frame with the specified source class.
- The source class was zero.
- An attempt has been made to transmit a MAC frame via a SAP.

**Action:** Adjust the value and try again.

---

**Hex 25**

**Explanation:** Maximum commands exceeded.

**Cause:** The maximum number of transmit commands that may be outstanding for a given station at any time (128) has been exceeded.

**Action:** Issue the transmit command at some later time.

---

**Hex 26**

**Explanation:** Unrecognized command correlator.

**Cause:** The command correlation sent to the adapter during ASB communications is invalid.

**Action:** The application program will never see this return code, since the adapter support software will assume a PC Hard Error state.

---

**Hex 27**

**Explanation:** Link not transmitting I frames—state changed from link opened.

**Cause:** This return code will be set in a transmit CCB whenever the link station leaves link-opened state because of a received frame (for instance, DISC), or because of a timeout. It will *not* be set if the link leaves link-opened state because of receipt of a CCB (for instance, DLC.CLOSE.STATION).

**Action:** The LINK STATION may be closed via DLC.CLOSE.STATION, or an attempt may be made to re-establish the connection via

DLC.CONNECT.STATION. If the remote station is on a different ring, a different route may be required in order to re-establish the link.

---

**Hex 28**

**Explanation:** Invalid transmit frame length.

**Cause:** The frame length, as specified, is either too short to contain sufficient header information, or too long for the adapter's transmit buffer. If the transmit was for a link station, it has entered the disconnected state.

**Action:** Transmit frames must be no longer than the maximum transmit length, as defined by DIR.OPEN.ADAPTER.

---

**Hex 30**

**Explanation:** Inadequate receive buffers for adapter to open.

**Cause:** The requested DIR.OPEN.ADAPTER parameters have not allowed adequate receive buffer space in the adapter's shared RAM.

**Action:** Reduce the RAM requirements by reconfiguring with either the configuration aid (OS/2) or the DIR.OPEN.ADAPTER command (PC DOS). Resources that may be reduced first to free up larger amounts of Shared RAM space are Data Hold buffers (if more than one is specified), and the number of queue elements. In addition, if the number of receive buffers can be reduced without affecting the expected performance level, the number of receive buffers may also be reduced.

---

**Hex 32**

**Explanation:** Invalid NODE\_ADDRESS.

**Cause:** The defined node address is invalid.

**Action:** Adjust the value accordingly. Refer to the *IBM Token-Ring Network Architecture Reference* for node address restrictions.

---

**Hex 33**

**Explanation:** Invalid adapter receive buffer length defined.

**Cause:** The value is either greater than the allowable maximum, less than the allowable minimum, or not a multiple of 8.

**Action:** Adjust the value accordingly.

---

**Hex 34**

**Explanation:** Invalid adapter transmit buffer length defined.

**Cause:** The value is either greater than the allowable maximum, less than the allowable minimum, or not a multiple of 8.

**Action:** Adjust the value accordingly.



---

**Hex 40**

**Explanation:** Invalid STATION\_ID.

**Cause:** Either the requested station ID does not exist or the command code is invalid for the station type.

**Action:** Make the appropriate changes and reissue the command.

---

**Hex 41**

**Explanation:** Protocol error--link in invalid state for command.

**Cause:** The requested command cannot be accepted because of the existing primary link state of the link station. A DLC.CONNECT.STATION command will not be accepted if the link is in the disconnected or closed state. A transmit command will not be accepted if the link is in any state other than opened.

**Action:** According to the situation.

---

**Hex 42**

**Explanation:** Parameter exceeded maximum allowed.

**Cause:** One of the parameter values is greater than acceptable.

**Action:** Use an acceptable value.

---

**Hex 43**

**Explanation:** Invalid SAP\_VALUE or value already in use.

**Cause:** For a DLC.OPEN.SAP command, this return code indicates that the SAP\_VALUE has already been used or the specified SAP is the Null or Global SAP.

For a DLC.OPEN.STATION command, this return code indicates that this SAP already has a link to the specified RSAP\_VALUE and DESTINATION\_ADDR combination, or that the remote SAP specified was the Null SAP, Global SAP, or a group SAP.

**Action:** Use an acceptable value. (Do not use X'00'.)

---

**Hex 44**

**Explanation:** Invalid routing field length.

**Cause:** The indicated routing field is either too short, greater than 18 bytes long, or is an odd number of bytes long.

**Action:** Set the length field to a correct value.

---

**Hex 45**

**Explanation:** Requested group membership in non-existent group SAP.

**Cause:** Membership has been requested in a group SAP which is not open.

**Note:** The command has been completed up to the point at which the adapter encountered the error. Other parameters have been changed if the command was DLC.MODIFY. However, the SAP has not been added as a member to a group SAP.

**Action:** Either change the group SAP value to a group SAP that has been opened or open the group SAP prior to requesting its membership.

---

**Hex 46**

**Explanation:** Inadequate link stations.

**Cause:**

- **DLC.OPEN.SAP:** There are inadequate link stations or SAPs available to satisfy the open.
- **DLC.OPEN.STATION:** All link stations assigned to this SAP are in use.

**Action:**

- **DLC.OPEN.SAP:** Close other SAPs, reduce the number of link stations being requested for the SAP, or wait for these resources to be freed.
  - **DLC.OPEN.STATION:** Close other link stations for the SAP, reallocate some link stations using the **DLC.REALLOCATE** command, close the SAP and reserve additional link stations, or wait for these resources to be freed.
- 

**Hex 47**

**Explanation:** SAP cannot close unless all link stations are closed.

**Cause:** At least one link station is open for this SAP.

**Action:** Close all link stations and try again.

**Note:** If a 47 error code results when a **DLC.CLOSE.SAP** command closely follows a **DLC.CLOSE.STATION** command for the last open station for that SAP, reissue the **DLC.CLOSE.SAP** command.

---

**Hex 48**

**Explanation:** Group SAP cannot close--all member SAPs not closed

**Cause:** At least one individual member SAP of this group SAP is open.

**Action:** Delete all SAPs in the group using the **DLC.MODIFY** command and try again.

---

**Hex 49**

**Explanation:** Group SAP has reached maximum membership

**Cause:** As stated.

**Note:** The command has completed up to the point at which the adapter encountered the error. Other parameters have been changed if the command was **DLC.MODIFY**.

**Action:** According to the application program.

---

**Hex 4A**

**Explanation:** Sequence error—incompatible command in progress.

**Cause:** The station is in the process of closing or establishing a connection.

**Action:** Await completion or issue a DLC.RESET command.

---

**Hex 4B**

**Explanation:** Station closed without remote acknowledgment.

**Cause:** The adapter issued a DISC command to the remote station as a result of receiving a DLC.CLOSE.STATION SRB. No acknowledgment has been received from the remote adapter and the link station has been closed.

**Action:** According to the application program.

---

**Hex 4C**

**Explanation:** Sequence error—cannot close while commands are outstanding.

**Cause:** Commands are in process. This prevents closing the SAP or link station.

**Action:** Wait until all outstanding commands are complete, or issue a reset.

---

**Hex 4D**

**Explanation:** Unsuccessful link station connection attempt.

**Cause:** The DLC.CONNECT.STATION command could not establish a requested connection.

**Action:** Determine the cause for the failure (for example, verify RSAP values, routing information, MAC address, and connection between the two work stations) and try again when resolved.

---

**Hex 4E**

**Explanation:** Member SAP not found in group SAP list.

**Note:** The command has completed up to the point at which the adapter encountered the error. Other parameters have been changed if the command was DLC.MODIFY.

**Cause:** A request was issued to delete an individual member SAP from a group SAP. The SAP was not found to be assigned to the group.

**Action:** Verify the SAP value.

---

**Hex 4F**

**Explanation:** Invalid remote address—may not be a group address.

**Cause:** The remote address parameter has the high bit of the high byte set to 1, which indicates a group address. A group address is not allowed to be specified for this command.

**Action:** Correct the remote address and reissue the command.

---

---

**Hex 50**

**Explanation:** Invalid pointer in the CCB\_POINTER field.

**Cause:** As stated.

**Action:** Check to ensure that all 4 byte pointers in the CCB's pointer field are accessible to the Operating System/2 process issuing the command.

---

**Hex 52**

**Explanation:** Invalid application program ID.

**Cause:** As stated.

**Action:** Use the CCB\_APPL\_ID field returned on the DIR.OPEN.ADAPTER command.

---

**Hex 53**

**Explanation:** Invalid application program key code.

**Cause:** As stated.

**Action:** Use the CCB\_APPL\_KEY field provided on DIR.OPEN.ADAPTER command.

---

**Hex 54**

**Explanation:** Invalid system key code.

**Cause:** As stated.

**Action:** Use the system key code as defined in the configuration file.

---

**Hex 55**

**Explanation:** Buffer is smaller than buffer size given on the DIR.OPEN.SAP command.

**Cause:** As Stated.

**Action:** Increase the size of the buffer being used to at least that of the buffers in the SAP buffer pool.

---

**Hex 56**

**Explanation:** The adapter's system process is not installed.

**Cause:** As stated.

**Action:** Load the adapter support software's system process. Insert the DETACH command into STARTUP.BAT file specifying the system process load module name.

---

---

**Hex 57**

**Explanation:** Inadequate stations are available.

**Cause:** Command has completed, however only a portion of the stations requested have been reserved. No more stations are available for reservation.

**Action:** None

---

**Hex 58**

**Explanation:** Invalid CCB\_PARAMETER\_1.

**Cause:** As stated.

**Action:** Adjust the parameter defined in the CCB\_PARAMETER\_1 field and reissue the command.

---

**Hex 59**

**Explanation:** Inadequate queue elements to satisfy request.

**Cause:** As stated open.

**Action:** On a short term basis wait for other requests to complete. Otherwise, increase queue elements using the configuration aid.

---

**Hex 5A**

**Explanation:** Initialization failure, cannot open the adapter.

**Cause:** As stated.

**Action:** Check Bring-up error code for details of initialization failure.

---

**Hex 5B**

**Explanation:** Error detected in chained READ command.

**Cause:** Bad return code given on a chained READ command.

**Action:** Correct READ command problem and reissue the command.

---

**Hex 5C**

**Explanation:** Direct stations are not assigned to this application program.

**Cause:** The invoking application program must request ownership of direct stations before issuing any requests involving the direct stations.

**Action:** Issue a DIR.OPEN.DIRECT command to gain ownership of the direct stations.

---

**Hex 5D**

**Explanation:** The Device Driver Interface is not installed.

**Cause:** As stated.

**Action:** Insert the DEVICE command into CONFIG.SYS file specifying the device driver load module name.

---

---

**Hex 5E**

**Explanation:** The requested adapter is not installed.

**Cause:** As stated.

**Action:** Install the adapter into the system. Check that the adapter is configured correctly for the primary or alternate adapter.

---

**Hex 5F**

**Explanation:** Chained commands must all be for the same adapter.

**Cause:** As stated.

**Action:** Only chain multiple command requests that are for the same adapter. Do not mix primary and alternate adapter requests.

---

**Hex 60**

**Explanation:** Adapter initializing, command not accepted.

**Cause:** As stated.

**Action:** Reissue the DIR.OPEN.ADAPTER command until command completes successfully.

---

**Hex 61**

**Explanation:** The number of allowed application programs has been exceeded.

**Cause:** As stated.

**Action:** On a short term basis, terminate one of the applications using the adapter support software. Otherwise, adjust the configuration file parameter: MAX\_USERS.

---

**Hex 62**

**Explanation:** Command cancelled, system action.

**Cause:** The system administrator has issued a command using the SYSTEM KEY.

**Action:** Re-establish session with the adapter support software if necessary.

---

**Hex 63**

**Explanation:** Direct stations are not available.

**Cause:** Direct stations have already been assigned.

**Action:** The application program owning the direct stations must issue the DIR.OPEN.DIRECT command to relinquish ownership of direct stations in order for the command to complete successfully.

---

**Hex 64**

**Explanation:** Invalid DDNAME parameter.

**Cause:** Either the device driver name given was invalid or the device driver did not provide the proper inter-device driver communication information in its device driver header.

**Action:** Make sure the device driver is loaded and has a valid header.

---

**Hex 65**

**Explanation:** Inadequate GDT selectors to satisfy request.

**Cause:** The number of GDT selectors defined during configuration is not adequate to support the number of control blocks and buffers passed to the adapter support software.

**Action:** Increase the number of GDT selectors when configuring the adapter support software using the configuration aid.

---

**Hex 67**

**Explanation:** Command cancelled, CCB resources purged

**Cause:** The command has been cancelled as a result of the PURGE.RESOURCES command.

**Action:** None

---

**Hex 68**

**Explanation:** The application program ID is not valid.

**Cause:** The application program ID provided was not obtained from the interface used for the command request.

**Action:** The application program ID can only be used at the interface where it was obtained, use the other interface (For example, Dynamic Link Routine Interface or Device Driver Interface).

---

**Hex 69**

**Explanation:** The segment associated with the request cannot be locked.

**Cause:** Too many processes are running concurrently and the system has run out of the resources. The segment cannot be locked.

**Action:** Reduce the number of Operating System/2 processes (the overall number of different segments controlled by the adapter support software), or wait until the resources are available. Memory references that are passed to the application program that contain control blocks that will be accessed when the adapter support software processes an adapter interrupt (for example, CCBs and buffers in the SAP buffer pool) are locked so they will not be moved or swapped by OS/2. By canceling processes using the application program or reducing the amount of control blocks passed to the application program, more memory will be available for other requests that require their control blocks locked. Adding memory to your system may also alleviate this problem.

---

---

**Hex FF**

**Explanation:** Command in process.

**Cause:** As stated.

**Action:** None.



## DLC Status Codes

For CCB1 and CCB3: Certain conditions that arise in the DLC function of the adapter (for IBM Token-Ring Network) or the DLC function of the adapter support software in the PC system (for PC Network), are reported to a DLC Status Appendage. DLC status codes are presented to the appendage in the AX register. The CX register contains the adapter number (0 or 1). Register SI contains a user value as defined in the USER\_STAT\_VALUE parameter of the DLC.OPEN.SAP command. Registers ES and BX point to the DLC status table that contains additional data for certain status codes. See the *IBM Local Area Network Technical Reference* for more about providing an appendage to use these codes.

For CCB3: The DI register contains the offset of the DLC appendage. The DS register contains the application program device driver protect mode data segment. An invocation code of X'0001' has been pushed onto the stack. Before returning the adapter support software, the application program must remove the invocation code from the stack.

For CCB2: Certain conditions that occur in the DLC function are returned in the READ command for DLC status change events. The format of the DLC Status table in the READ command's CCB is shown below. This table starts at offset 10 in the READ command's parameter table.

### DLC Status Table

OFF-SET	PARAMETER NAME	BYTE LEN	8086 TYPE	DESCRIPTION
0	STATION_ID	2	DW	STATION.ID
2	DLC_STATUS_CODE	2	DW	DLC status Code
4	FRMR_DATA	5	DB	5 bytes of reason code that are applicable when an FRMR is either transmitted or received.
9	ACCESS_PRIORITY	1	DB	The new access priority that is applicable when status bit 5 is on. The format is: B'nnn00000' where "nnn" is the access priority. This byte is not used and set to zero when used on the PC Network.
10	REMOTE_NODE	6	DB	The 6-byte remote node value of a newly opened link station. Applicable when status bit 10 is on.
16	REMOTE_SAP	1	DB	The 1-byte remote SAP value of a newly opened link station. Applicable when status bit 10 is on.
<b>For CCB2 and CCB3:</b>				
17		1	DB	Reserved
18	USER_STAT_VALUE	2	DB	User value as defined in the DLC.OPEN.SAP command.

## DLC Status Codes

BIT	FUNCTION	ADDITIONAL DATA
15	Link lost	
14	DM or DISC received, or DISC acknowledged	
13	FRMR received	Five bytes of reason code data are contained in the area pointed to by the address in the ES:BX register (FRMR_DATA).
12	FRMR sent	Five bytes of reason code data are contained in the area pointed to by the address in the ES:BX register (FRMR_DATA).
11	SABME received for an open link station	
10	SABME received, link station opened	A new link station has been opened by the adapter. A DLC.OPEN.STATION command should NOT be issued for that link station. A DLC.CONNECT.STATION command must be issued to accept the SABME or a DLC.CLOSE.STATION command to reject it. The local STATION_ID, remote node address (DESTINATION_ADDR), and remote SAP value (RSAP_VALUE) are provided in the status table pointed to by the address in the ES and BX registers.
9	Remote station has entered a "local busy" condition	
8	Remote station has left a "local busy" condition	
7	Ti has expired	
6	DLC counter overflow	One or more of the DLC LINK STATION's DLC log counters has reached half of the maximum value. A DLC.STATISTICS command should be issued.
5	Access Priority lowered	The new access priority (ACCESS_PRIORITY) is in the area pointed to by the address in the ES:BX register.
4-1	Reserved	
0	Local station has entered a "local busy" condition	This code is reported only when the state has changed because of a buffer pool (out-of-buffers) condition when the adapter support software cannot accept an I-frame. It is not reported because of a DLC.FLOW.CONTROL command being issued by the network application program.  It is the responsibility of the application program to issue a "flow control on" command to reset the "local busy" condition.

## Suggested Actions in Response to DLC Status

- **Link Lost**  
It appears that the connection to the remote partner has been lost, or that the remote station has been closed. A `DLC.CLOSE.STATION` command may be issued to free the control block, or a `DLC.CONNECT.STATION` command (possibly with different routing information) may be issued to attempt to reestablish the connection. Any outstanding transmit commands will be returned with a `CCB_RETCODE` of `X'27'`.
- **DM or DISC received**  
The remote partner is attempting to terminate the connection. A `DLC.CLOSE.STATION` command should be issued. Any outstanding transmit commands will be returned with a `CCB_RETCODE` of `X'27'`.
- **FRMR Received**  
The remote partner has detected a DLC protocol error in the frame received from this station. Either a `DLC.CLOSE.STATION` or `DLC.CONNECT.STATION` command should be issued. Any outstanding transmit commands will be returned with a `CCB_RETCODE` of `X'27'`.
- **FRMR Sent**  
The local link station has detected a DLC protocol error in a frame received from the remote partner. However, if a Ti Timer-expired DLC Status interrupt is received after receipt of this interrupt, a `DLC.CLOSE.STATION` or `DLC.CONNECT.STATION` command should be issued to the local station. Any outstanding transmit commands will be returned with a `CCB_RETCODE` of `X'27'`.
- **SABME Received for an Open Link Station**  
The remote station wishes to reset an existing connection. A `DLC.CONNECT.STATION` command may be issued to reestablish the connection, or a `DLC.CLOSE.STATION` command may be issued to terminate it. Any outstanding transmit commands will be returned with a `CCB_RETCODE` of `X'27'`.
- **SABME Received, Link Station Opened**  
A control block has been allocated and a station has been opened, in disconnected state, in response to a SABME received from a remote station. The connection request may be accepted by issuing a `DLC.CONNECT.STATION` command, or rejected by issuing a `DLC.CLOSE.STATION` command.
- **Remote Station Has Entered Local Busy**  
The remote station has temporarily stopped receiving I frames, probably because of buffer congestion. The local station will stop sending I frames. The application program may choose to issue transmit commands for the affected station, up to the maximum number accepted by the adapter, but they will be queued until the remote station leaves the local busy state.
- **Remote Station Has Left Local Busy**  
The local station will resume I-frame transmission.
- **Ti Timer Expired**  
This status is not returned while the link is in link-opened state. In other states it is returned to indicate that there is no activity on the link, and that the PC system may therefore wish to close the link to free up the control block.

- **DLC Counter Overflow**  
One or more of the error counters maintained for the link station has reached half of its maximum value. The counter will wrap back to zero when it reaches its maximum value. The application program should issue a `DLC.STATISTICS` command to read and reset the counters.
- **Access Priority Reduced**  
The access priority requested for this SAP or link station was greater than that authorized for the adapter and it has been reduced. The new priority is in the Adapter Status Table or if the adapter is being operated without the adapter support software, in ARB byte 13. There is no PC system application program action required as this is for information only. However, a `DLC.MODIFY` command may be issued to change the access priority.

## NETBIOS Return Codes (NCB\_RETCODE)

Code	Meaning
00	Good return
01	Illegal buffer length
03	Invalid command
05	Command timed out
06	Message incomplete
07	Data for one or more SEND type NO.ACK commands was not received
08	Illegal local session number
09	No resource available
0A	Session closed
0B	Command canceled
0D	Duplicate name in local name table
0E	Name table full
0F	Command completed--name has active session and is now de-registered
11	Local session table full
12	Session open rejected
13	Illegal name number
14	Cannot find name called
15	Name not found or cannot specify "*" or null
16	Name in use on remote NETBIOS
17	Name deleted
18	Session ended abnormally
19	Name conflict detected
21	Interface busy
22	Too many commands outstanding
23	Invalid number in NCB_LANA_NUM field
24	Command completed while cancel occurring
26	Command not valid to cancel
30	Name defined by another environment
34	Environment not defined, RESET must be issued
35	Required operating system resources exhausted. retry later.
36	Maximum applications exceeded
37	No SAPs available for NETBIOS.
38	Requested resource(s) not available.
39	Invalid NCB address or length does not fit in segment.
3A	RESET may not be issued from a NETBIOS adapter appendage.
3B	Invalid NCB_DD_ID value.
3C	NETBIOS attempted to lock user storage and the lock failed.
3F	NETBIOS Device Driver open error.
40	OS/2 error detected.
4E	Network status--one or more of bits 12, 14, 15 on for longer than 60 seconds
4F	Network status--one or more of bits 8-11 on
F6	Unexpected error on CCB completion
F7	Error on implicit DIR.INITIALIZE

Code	Meaning
F8	Error on implicit DIR.OPEN.ADAPTER
F9	adapter support software internal error
FA	Adapter check
FB	NETBIOS program not loaded in PC
FC	DIR.OPEN.ADAPTER or DLC.OPEN.SAP failed, check parameters
FD	Unexpected adapter close
FE	NETBIOS not operational and application program explicitly opened the adapter.

## NETBIOS Return Codes

---

### Hex 00

**Explanation:** Operation completed successfully.

---

### Hex 01

**Explanation:** Illegal buffer length.

**Cause:** The requested buffer length (or invalid buffer selector if using NETBIOS 3.0) is illegal for the NCB.SEND.DATAGRAM, NCB.SEND.BROADCAST, NCB.STATUS, or NCB.SESSION.STATUS command.

**Action:** Specify the correct size for the buffer and retry.

---

### Hex 03

**Explanation:** Invalid command.

**Cause:** As stated.

**Action:** Issue the correct command.

---

### Hex 05

**Explanation:** Command timed out.

**Cause:** As stated.

**Action:** Reissue the same command or another command. If a send timed out, there may not be a receive outstanding from the other name.

---

### Hex 06

**Explanation:** Message incomplete.

**Cause:** The application program received part of a message because the specified buffer length is not large enough to receive the full message.

**Action:**

- NCB.RECEIVE and NCB.RECEIVE.ANY: Issue another receive to get the rest of the message before the remote side times out.
- NCB.STATUS, NCB.SESSION.STATUS, NCB.RECEIVE.DATAGRAM, and NCB.RECEIVE.BROADCAST.DATAGRAM: The remaining data is lost.

**Note:** If the command was a NCB.STATUS, this error code could occur because the remote side could not transmit the entire status update if the data was of greater length than the maximum length UI-frame that may be transmitted.

---

### Hex 07

**Explanation:** Data for one or more SEND type NO.ACK commands was not received.

**Cause:** Data sent by a previous NCB.SEND.NO.ACK or NCB.CHAIN.SEND.NO.ACK command was either not received at all or only partially received by the remote application program.

**Action:** The application program will need to initiate any data recovery needed.

---

**Hex 08**

**Explanation:** Illegal local session number.

**Cause:** The session number specified is not one of the active sessions.

**Action:** Reissue the command with the correct active session number.

---

**Hex 09**

**Explanation:** No resource available.

**Cause:** Trying to establish a session with a remote application program that has no more room in the session table.

**Action:** Reissue the command at a later time.

---

**Hex 0A**

**Explanation:** Session closed.

**Cause:** The name from the transmitting side closed the session. The session has terminated normally.

**Action:** None.

---

**Hex 0B**

**Explanation:** Command canceled.

**Cause:** As stated.

**Action:** None.

---

**Hex 0D**

**Explanation:** Duplicate name in local name table.

**Cause:** Tried to specify a name that is currently in the name table.

**Action:** Reissue the command and specify another name.

---

**Hex 0E**

**Explanation:** Name table full.

**Cause:** The number of names defined has exceeded the number defined at initialization (default = 17).

**Action:** Wait until a delete name is issued so an entry will become available.

---

**Hex 0F**

**Explanation:** Command completed, name has active session and is now de-registered.

**Cause:** The name to be deleted is active in a session now, but is de-registered. When the name is marked de-registered and has active sessions, it still occupies a slot in the table. The name is unusable for any new sessions.

**Action:** Close all the sessions using this name.



---

**Hex 11**

**Explanation:** Local session table full.

**Cause:** There are no available entries on the session table. (The number of sessions is user-specified in NCB.RESET).

**Action:** Wait until a session has closed so an entry will become available.

---

**Hex 12**

**Explanation:** Session open rejected.

**Cause:** No LISTEN command is outstanding on the remote NETBIOS.

**Action:** Wait until a LISTEN is issued on the remote NETBIOS.

---

**Hex 13**

**Explanation:** Illegal name number

**Cause:** The number of the name has been changed or was never specified.

**Action:** Must use the most recent number that was assigned to the name.

---

**Hex 14**

**Explanation:** Cannot find name called or no answer.

**Cause:** No response to the NCB.CALL command received.

**Action:** Try again later.

---

**Hex 15**

**Explanation:** Name not found or cannot specify "\*" or null.

**Cause:** The name specified is not in the table, or the first character of the name is either an ASCII asterisk or "00."

**Action:** Try again with another name that has been verified to be correct.

---

**Hex 16**

**Explanation:** Name in use on remote NETBIOS.

**Cause:** Name found in another table. Names used in the network are unique and can only be used in one place. The name is already defined on another node.

**Action:** Either specify another name or have the name changed at the remote end.

---

**Hex 17**

**Explanation:** Name deleted.

**Cause:** As stated.

**Action:** Add the name to the table and reissue the command.

---

---

**Hex 18**

**Explanation:** Session ended abnormally.

**Cause:** The most probable cause is that a send-type NCB timed-out because no receive command was available in the remote node.

**Action:**

- If a send timed-out, re-establish the session and ensure that the remote node has issued a receive.
- If the session cannot be re-established, maintenance procedures should be initiated for the node in question.

---

**Hex 19**

**Explanation:** Name conflict detected.

**Cause:** Network protocol has detected two or more identical names on the network.

**Action:** Identical names on the network should be removed.

---

**Hex 21**

**Explanation:** Interface busy.

**Cause:** NETBIOS is either busy or out of local resources.

**Note:** This condition can also be caused by any of the network status bits 12, 14, or 15 being on.

**Action:** Try again later.

---

**Hex 22**

**Explanation:** Too many commands outstanding.

**Cause:** As stated.

**Action:** Try again later.

---

**Hex 23**

**Explanation:** Invalid number in NCB\_LANA\_NUM field.

**Cause:** Tried to specify a value other than "00" or "01," or the adapter is not present.

**Action:** Verify that the adapter is present, or correct the value and try the command again. Use "00" for the primary adapter and "01" for the alternate.

---

**Hex 24**

**Explanation:** Command completed while cancel occurring.

**Cause:** Tried to cancel a command that had already been completed.

**Action:** None.

---

**Hex 26**

**Explanation:** Command not valid to cancel.

**Cause:** Tried to cancel a command that is invalid to cancel.

**Action:** Verify the correctness of the cancel command.

---

**Hex 30**

**Explanation:** Name defined by another environment.

**Cause:** Another environment has already defined the name.

**Action:** Choose another name.

---

**Hex 34**

**Explanation:** Environment not defined, RESET must be issued.

**Cause:** As stated.

**Action:** Issue RESET.

---

**Hex 35**

**Explanation:** Required operating system resources exhausted, retry later.

**Cause:** As stated.

**Action:** Retry command later.

---

**Hex 36**

**Explanation:** Maximum applications exceeded.

**Cause:** The maximum number of applications defined at NETBIOS 3.0 load-time are executing.

**Action:** Wait until another application terminates.

---

**Hex 37**

**Explanation:** No SAPs available for NETBIOS.

**Cause:** The adapter has no SAPs available for NETBIOS.

**Action:** Wait until an application using SAPs relinquishes use of a SAP.

---

**Hex 38**

**Explanation:** Requested resource(s) not available.

**Cause:** As stated.

**Action:** Operate with the smaller number of resources or terminate.

---

---

**Hex 39**

**Explanation:** Invalid NCB address or length does not fit in segment.

**Cause:** As stated.

**Action:** Application error. Correct NCB address and selector length.

**Note:** In the case of this return code, since the NCB is in doubt, the value is returned only in register AL. No attempt is made to place the return code into the NCB.

---

**Hex 3A**

**Explanation:** RESET may not be issued from a NETBIOS adapter appendage.

**Cause:** The RESET command was issued when the NETBIOS 3.0 adapter was processing a hardware interrupt.

**Action:** Application error. Do not issue RESET in this situation.

**Note:** Return code applies only to the Device Driver (DD) interface.

---

**Hex 3B**

**Explanation:** Invalid NCB\_DD\_ID value.

**Cause:** The value in NCB\_DD\_ID is not identical to the value returned by NETBIOS 3.0 in the first RESET issued by the device driver application program. Note that NCB\_DD\_ID must be X'0000' in the first RESET issued for a given device driver application program.

**Action:** Application error. Correct NCB\_DD\_ID value.

**Note:** Return code applies only to the Device Driver (DD) interface.

---

**Hex 3C**

**Explanation:** NETBIOS attempted to lock user storage and the lock failed.

**Cause:** As stated.

**Action:** Try the command at a later time.

---

**Hex 3F**

**Explanation:** NETBIOS Device Driver open error.

**Cause:** Either the device driver had an actual problem in its open process or the NETBIOS device driver was not loaded.

**Action:** Load the appropriate code before executing NETBIOS applications.

---

**Hex 40**

**Explanation:** OS/2 error detected.

**Cause:** During processing, an unexpected error was indicated by OS/2.

**Action:** Issue RESET and restart. If failure continues, notify IBM.

---

---

**Hex 4F**

**Explanation:** Network status—one or more of bits 8 - 11 on.

**Cause:** As stated.

**Action:** Check the extended status last network status code. The only NETBIOS command that may be issued is NCB.RESET.

---

**Hex F6**

**Explanation:** Unexpected error on CCB completion.

**Cause:** This is a NETBIOS 2.X return code that indicates that a CCB has completed with an unexpected bad return code. NETBIOS 1.X returned a X'FA' in these situations.

**Action:** The only NETBIOS command that may be issued is NCB.RESET.

---

**Hex F7**

**Explanation:** Error on implicit DIR.INITIALIZE.

**Cause:** As stated.

**Action:** Check the extended status bring-up error code. The only NETBIOS command that may be issued is NCB.RESET.

---

**Hex F8**

**Explanation:** Error on implicit DIR.OPEN.ADAPTER.

**Cause:** As stated.

**Action:** Check the extended status bring-up error code. The only NETBIOS command that may be issued is NCB.RESET.

**Notes:**

1. There is a possibility that a DIR.OPEN.ADAPTER could fail because of a temporary timing condition. Because of this, before reporting this return code, the DIR.OPEN.ADAPTER is retried twice at thirty-second intervals.
  2. This error could be caused by an attempt to open on an IBM Token-Ring Network with the adapter set to the wrong data rate. Check the data rate setting.
- 

**Hex F9**

**Explanation:** adapter support software internal error.

**Cause:** As stated.

**Action:** Check the PC System detected error code. The only NETBIOS command that may be issued is NCB.RESET.

---

**Hex FA**

**Explanation:** Adapter check.

**Cause:** As stated.

**Action:** Check the adapter check reason code. The only NETBIOS command that may be issued is NCB.RESET.

---

**Hex FB**

**Explanation:** NETBIOS code not loaded in the PC system.

**Cause:** NETBIOS is not loaded or is loaded and not operational due to an error at load time, but a control block has been received by the adapter support software with a value greater than X'03' in the first field.

**Action:** Load and start NETBIOS or correct the conditions that cause a load error and reissue the command or correct the control block.

---

**Hex FC**

**Explanation:** DIR.OPEN.ADAPTER or DLC.OPEN.SAP failed—check parameters.

**Cause:** As stated.

**Action:** Correct the parameters in error and execute the DIR.OPEN.ADAPTER command again. Note that the DLC.OPEN.SAP command is executed on initial start and restart of NETBIOS. The parameters used are obtained from the DIR.OPEN.ADAPTER command (executed either explicitly or implicitly).

**Note:** There is a possibility that a DIR.OPEN.ADAPTER could fail because of a temporary timing condition. Because of this, before reporting this return code, the DIR.OPEN.ADAPTER is tried again twice at thirty-second intervals.

---

**Hex FD**

**Explanation:** Unexpected adapter close.

**Cause:** The adapter was closed while NETBIOS was executing.

**Action:** Issue a NCB.RESET command.

---

**Hex FE**

**Explanation:** NETBIOS not operational and application program explicitly opened the adapter.

**Cause:** The adapter has been explicitly opened by the application program and NETBIOS is not operational.

**Action:** Close the adapter and re-issue the NETBIOS command.

---

## NETBIOS Return Codes

### Notes:

For the following codes 'F7' to 'FD':

1. The condition to be reported via `NCB_RETCODE` is the last to have occurred.
2. Extended status information, with the exception of adapter counters, is available in the `NCB_RESERVE` field of the command block. In the case of the `NCB.RESET` command, it is the status prior to the `NCB.RESET`.
3. Network status information:
  - Any network status bits 8 - 11 on, cause error code '4F'.
  - Any network status bits 12, 14, or 15 on, for longer than 60 seconds, cause error code '4E'. Code '4F' has priority over code '4E'.
  - Network status bits 6 and 7 do not cause errors. If bit 7 (counter overflow) is on, nothing is reported. If no network status appendage is defined, the local NETBIOS counters will be updated via the `DIR.READ.LOG` command. Bit 6 (single station) is ignored.

## Adapter Status Parameter Table

This information is placed in PC system memory by the adapter support software in response to a DIR.STATUS command. The adapter support software places a pointer address in the ADAPTER\_PARMS\_ADDR field of the DIR.STATUS command's parameter table.

OFF-SET	PARAMETER NAME	BYTE LEN	8086 TYPE	DESCRIPTION
0	PHYS_ADDR	4	DB	Adapter physical address
4	UP_NODE_ADDR	6	DB	The upstream node address
10	UP_PHYS_ADDR	4	DB	The upstream physical address
14	POLL_ADDR	6	DB	Last poll address
20	AUTH_ENV	2	DB	Authorized environment
22	ACC_PRIORITY	2	DB	Transmit access priority
24	SOURCE_CLASS	2	DB	Source class authorization
26	ATT_CODE	2	DB	Last attention code
28	SOURCE_ADDR	6	DB	Last source address
34	BEACON_TYPE	2	DB	Last beacon type
36	MAJOR_VECTOR	2	DB	Last major vector
38	NETW_STATUS	2	DB	Network status
40	SOFT_ERROR	2	DB	Soft error timer value
42	FE_ERROR	2	DB	Front end error counter
44	LOCAL_RING	2	DB	Ring number
46	MON_ERROR	2	DB	Monitor error code
48	BEACON_TRANSMIT	2	DB	Beacon transmit type
50	BEACON_RECEIVE	2	DB	Beacon receive type
52	FRAME_CORREL	2	DB	Frame correlation save
54	BEACON_NAUN	6	DB	Beaconing station NAUN
60		4	DB	Reserved
64	BEACON_PHYS	4	DB	Beaconing station physical address



---

## Frame Status

The frame status (FS) byte is returned to the application program for some commands on the IBM Token-Ring Network only.

**Note:** This FS byte is also referred to as the TRANSMIT\_PCFE field for transmit commands. Some values and their meanings are:

- X'CC' The frame was copied
- X'00' The address was not received and the frame was not copied (the destination adapter must not be on the ring)
- X'88' The destination adapter recognized the frame, but did not copy it (possibly due to being overloaded).

See the *IBM Token-Ring Network Architecture Reference* for more about the FS byte.

## Exception Indications

The exception indications include:

- Adapter Check
- Network Status
- Bring-Up Errors
- PC System Detected Errors
- System Action Exceptions for OS/2

### Adapter Check for CCB1

When an adapter check occurs, the adapter support software will close the adapter, all ring communication will cease. The adapter support software will assume the adapter has encountered an unrecoverable error. An adapter check appendage (ADAPTER\_CHECK\_EXIT), if defined by these commands (DIR.INITIALIZE, DIR.OPEN.ADAPTER, DIR.MODIFY.OPEN.PARMS, DIR.SET.USER.APPENDAGE), will be taken. On entry, the CX register will contain the adapter number, the AX will contain the adapter check reason code, and the ES and BX registers will point to the following table. While interrogating the information, the application program should either move the data to private memory or keep all interrupts masked off.

OFF-SET	8086 TYPE	CONTENTS
0	DD	A pointer to the first of a queue of commands that were outstanding when the adapter closed
4	DW	Adapter check reason code
6	DW	Parameter 0: Set per reason-code
8	DW	Parameter 1: Set per reason-code
10	DW	Parameter 2: Set per reason-code

### Adapter Check for CCB2

In some instances, the adapter hardware or software is in such a state that operation is not possible. If this is the case, the following will occur.

1. If possible, the adapter will close and all network communications will cease.
2. All adapters will assume a closed state.
3. SAPs and link stations are closed due to the adapter closing and SAP and direct station buffer pools, outstanding receive frames, and CCBs may be returned to the application. If the ADAPTER\_CHECK\_FLAG is set.
4. If the ADAPTER\_CHECK\_FLAG is set the application program can be notified of this event. In order for an application to receive notification of an adapter check, a READ command must be issued before the event occurs requesting notification of Critical Exceptions. When the event occurs the READ command will be posted using a semaphore. The information listed in the following table will be copied into the READ command's CCB parameter table.

OFF-SET	PARAMETER NAME	BYTE LEN	8086 TYPE	DESCRIPTION
0	NOTIFICATION_FLAG	4	DD	User exception flag
4	CCB_COUNT	2	DW	Count of CCBs chained to EVENT_CCB_POINTER

## Adapter Check

OFF-SET	PARAMETER NAME	BYTE LEN	8086 TYPE	DESCRIPTION
6	EVENT_CCB_POINTER	4	DD	Pointer to the first of a queue of commands which were outstanding when the adapter closed
10	BUFFER_COUNT	2	DW	Count of buffers chained to FIRST_BUFFER_ADDR
12	FIRST_BUFFER_ADDR	4	DD	Address of first buffer in SAP and direct station buffer pools.
16	RCV_FRAME_COUNT	2	DW	Count of received frames chained to RCV_FRAME_ADDR
18	RCV_FRAME_ADDR	4	DD	Address of the first received frame of a possible chain of frames
22	REASON_CODE	2	DW	Adapter check reason-code
<b>Note:</b> The next three fields are event error data.				
24	PARAMETER_0	2	DW	Parameter 0: set per reason-code
26	PARAMETER_1	2	DW	Parameter 1: set per reason-code
28	PARAMETER_2	2	DW	Parameter 2: set per reason-code

---

### NOTIFICATION\_FLAG

**Explanation:** This user exception flag is ADAPTER\_CHECK\_FLAG as defined using the DIR.SET.EXCEPTION.FLAGS command.

---

### FIRST\_BUFFER\_ADDR

**Explanation:** Address of the first buffer in the SAP or Direct buffer pool.

Buffers provided with the DLC.OPEN.SAP or DIR.OPEN.DIRECT commands are returned to the application program when the adapter closes as a result of entering the closed state.

---

### RCV\_FRAME\_ADDR

**Explanation:** Address of the first received frame.

All received frames for this application program that were on the completion list at the time of the exception will be queued to this field when the adapter enters the closed state. The first buffer of each frame will point to the next frame.

---

**REASON\_CODE**

**Explanation:** Reason code for the adapter check.

**Note:** Only one reason code will be reported at a time.

See the table above for the values returned.

---

**PARAMETERS - 0,1,2**

**Explanation:** PARAMETER\_0, PARAMETER\_1 and PARAMETER\_2 provide additional information on a per reason-code basis. The information may be useful for maintenance purposes and is not intended for application program use.

**Adapter Check for CCB3**

In some instances, the adapter hardware or software is in such a state that operation is not possible. If this is the case, the following will occur.

1. If possible, the adapter will close and all network communications will cease.
2. All adapters will assume a closed state.
3. If SAPs and link stations are closed due to the adapter closing and the adapter check appendage (ADAPTER\_CHECK\_APPNDG\_OFFSET) is defined, the SAP and direct station buffer pools and CCBs may be returned to the application program in the information table pointed to by registers ES and BX. When the adapter support software calls the application program's device driver, the appropriate event appendage offset is passed in register DI. See the DIR.SET.EXCEPTION.FLAGS command in the *IBM Local Area Network Technical Reference*.
4. If the adapter check appendage offset is specified, the application program can be notified of this event. Once the adapter check occurs, the adapter support software notifies the application program of the event by calling the application program's device driver with the appropriate event appendage offset passed in register DI. The information listed in the following table will be provided in the table pointed to by registers ES and BX when the adapter support software calls the application program's device driver.

**Application Calls**

When the adapter support software calls the application program's device driver entry point, the following information is provided to the application program.

- An Invocation code of X'0001' has been pushed onto the stack. Before returning to the adapter support software the application program must remove the invocation code from the stack.
- Register DI contains the offset of the adapter check appendage as defined by the DIR.SET.EXCEPTIONS.FLAG command
- Register DS contains the application program's device driver protect mode data segment.
- Register CX contains the adapter number.
- Registers ES and BX contain the address of a 20 byte information table.
- Register AX contains the error code.

## Adapter Check

OFF-SET	PARAMETER NAME	BYTE LEN	8086 TYPE	DESCRIPTION
0	CCB_COUNT	2	DW	Count of CCBs chained to EVENT_CCB_POINTER
2	EVENT_CCB_POINTER	4	DD	Pointer to the first of a queue of commands which were outstanding when the adapter closed
6	BUFFER_COUNT	2	DW	Count of buffers chained to FIRST_BUFFER_ADDR
8	FIRST_BUFFER_ADDR	4	DD	Address of first buffer in SAP and direct station buffer pools.
12	REASON_CODE	2	DW	Adapter check reason-code
Note: The next three fields are event error data.				
14	PARAMETER_0	2	DW	Parameter 0: set per reason-code
16	PARAMETER_1	2	DW	Parameter 1: set per reason-code
18	PARAMETER_2	2	DW	Parameter 2: set per reason-code

---

### FIRST\_BUFFER\_ADDR

**Explanation:** Address of the first buffer in the SAP and direct station buffer pool.

Buffers provided with the DLC.OPEN.SAP or DIR.OPEN.DIRECT commands are returned to the application program when the adapter closes as a result of entering the closed state.

---

### REASON\_CODE

**Explanation:** Reason code for the adapter check. See the table above for returned values.

---

### PARAMETERS - 0,1,2

**Explanation:** PARAMETER\_0, PARAMETER\_1 and PARAMETER\_2 provide additional information on a per reason-code basis. The information may be useful for maintenance purposes only and is not intended for application program use.

## IBM Token-Ring Network Adapter Check Reason Codes for All CCBs

VALUE	FUNCTION	MEANINGS/PARAMETERS
8000	Adapter inoperative	See note.
<p><b>Note:</b> Adapter inoperative (8000)</p> <p>When a machine check occurs in the adapter processor, it is reported to the adapter support software via an "adapter check interrupt." The PC system may receive this interrupt before the adapter processor is able to set the adapter check bits. Therefore the adapter support software does the following:</p> <ol style="list-style-type: none"> <li>1. If a reason code is set, that code is passed to the application program.</li> <li>2. If a reason code is not set, the adapter support software goes into a tight loop for 250 milliseconds. The adapter support software then checks the reason code set by the adapter processor and does one of the following: <ol style="list-style-type: none"> <li>a. If a code is set, the adapter support software passes that code to the application program.</li> <li>b. If no code is set, the adapter support software assumes that the adapter processor's machine check handler was not capable of executing because of the severity of the processor's problem. The adapter support software then sets a value of (8000) in the adapter check reason code and passes that code to the application program.</li> </ol> </li> </ol>		
4000	Reserved	
2000	Reserved	
1000	Illegal op code	The adapter detected an illegal op code (micro failure).
0800	Local bus parity error	The adapter local bus detected a parity error.
0400	External Parity error	
0200	Reserved	
0100	Internal parity error	
0080	Parity error, Ring transmit	The adapter local bus detected a parity error while transmitting on the ring.
0040	Parity error, Ring receive	The adapter local bus detected a parity error while receiving from the ring.
0020	Transmit underrun	
0010	Receive overrun	
0008	Unrecognized interrupt	
0004	Unrecognized error interrupt	
0003	Adapter detected no PC system service	
0002	Unrecognized supervisory request	
0001	Program detected error	

---

## IBM PC Network Adapter Check Reason Codes for All CCBs

The values shown for the reason codes are as if the values were contained in the AX register.

Code	Meaning
X'0100'	Program Detected Error
X'0200'	Reserved
X'0300'	Invalid Supervisor Request Code
X'0400'	Invalid Task ID on Supervisor Call
X'0500'	Invalid Ready Task Request
X'0600'	Invalid Adapter Number on Supervisor Call
X'0700'	Invalid ES Value on Supervisor Call

## Network Status

### Network Status for CCB1

Whenever network status changes, the application program will be notified if the network status appendage has been defined in the NETW\_STATUS\_EXIT field of the CCB for a DIR.INITIALIZE or in the NETW\_STATUS\_EXIT field of the DIRECT\_PARMS table of the DIR.OPEN.ADAPTER command.

The AX register contains the network status code and the CX register contains the adapter number. Registers ES and BX point to the chain of outstanding CCBs if the adapter was closed.

### Network Status for CCB2

In some instances the Network Status will indicate that the adapter closed (Critical Network Status). When the adapter support software will assume an unrecoverable error. When link stations are closed due to the adapter closing, the SAP buffer pools, outstanding receive frames, and CCBs may be returned to the application program if the NETWORK\_STATUS\_FLAG is set, see the DIR.SET.EXCEPTION.FLAGS command in the *IBM Local Area Network Technical Reference*. Also, see the DLC.OPEN.SAP command in the *IBM Local Area Network Technical Reference* for the SAP buffer pool definition.

Whenever Network Status changes, the application program can be notified if the NETWORK\_STATUS\_FLAG is set. In order for an application program to receive notification of a Network Status (non-critical) a READ command must be issued. If a READ command is already outstanding, it will be posted immediately using a semaphore.

In order for an application to receive notification of a Critical Network Status (the adapter closes) a READ command must be issued before the event occurs requesting notification of Critical Exceptions. When the event occurs the READ command will be posted using a semaphore.

The information in the following table will be copied into the READ command's parameter table.

PARAMETER NAME	BYTE LEN	8086 TYPE	DESCRIPTION
NOTIFICATION_FLAG	4	DD	User exception flag
CCB_COUNT	2	DW	Count of CCBs chained to EVENT_CCB_POINTER *
EVENT_CCB_POINTER	4	DD	Pointer to the first of a queue of commands which were outstanding when the adapter closed *
BUFFER_COUNT	2	DW	Count of buffers chained to FIRST_BUFFER_ADDR *
FIRST_BUFFER_ADDR	4	DD	Address of first buffer in SAP and direct station buffer pools *
RCV_FRAME_COUNT	2	DW	Count of received frames chained to RCV_FRAME_ADDR *
* Indicates that this value is only returned when the adapter is closed as a result of entering a closed unconditional state.			



PARAMETER NAME	BYTE LEN	8086 TYPE	DESCRIPTION
RCV_FRAME_ADDR	4	DD	Address of the first received frame of a possible chain of frames *
NETWORK_STATUS_CODE	2	DW	Network Status Code
* Indicates that this value is only returned when the adapter is closed as a result of entering a closed unconditional state.			

---

### NOTIFICATION\_FLAG

**Explanation:** User Notification Flag.

This user exception flag is NETWORK\_STATUS\_FLAG as defined using the DIR.SET.EXCEPTION.FLAGS command.

---

### FIRST\_BUFFER\_ADDR

**Explanation:** Address of the first buffer in the SAP and direct station buffer pools.

Buffers provided with the DLC.OPEN.SAP and DIR.OPEN.DIRECT commands are returned to the application program if the adapter closes.

---

### RCV\_FRAME\_ADDR

**Explanation:** Address of the first received frame.

All received frames for this application program that were on the completion list at the time of the exception will be queued to this field if the adapter closes. The first buffer of each frame will point to the next frame.

---

### NETWORK\_STATUS\_CODE

**Explanation:** Network Status Code being reported.

See "IBM Token-Ring Network Status Codes for All CCBs" on page B-46 when using an IBM Token-Ring Network adapter, and "IBM PC Network Status Codes for All CCBs" on page B-47 when using a PC Network adapter.

## Network Status for CCB3

In some instances the Network Status will indicate that the adapter is closed (Critical Network Status). When the adapter support software is closed link stations are closed due to the adapter closing, the SAP and direct station buffer pools and CCBs may be returned to the application program if the NETWORK\_STATUS\_APPENDAGE is set, see the DIR.SET.EXCEPTION.FLAGS command in the *IBM Local Area Network Technical Reference*. Also, see the DLC.OPEN.SAP command in the *IBM Local Area Network Technical Reference* for the SAP buffer pool definition.

Whenever the network status changes, the application program is notified by a NETWORK\_STATUS\_APPENDG\_OFFSET defined using the DIR.SET.EXCEPTION.FLAGS command. In order for an application program to receive notification of a network status exception (critical/non-critical), the DIR.SET.EXCEPTION.FLAGS command must have been executed and the adapter support software must have been supplied with an appendage offset for network status.

When the event occurs the adapter support software calls the application program's device driver entry point with the appropriate event appendage offset passed in register DI. The information listed in the following table will be supplied to the application program by the registers ES and BX. ES and BX point to the information table when the adapter support software calls to the application program's device driver.

**Application Calls:** When the adapter support software calls the application program at the address obtained by the ATTACHDD function, the following information is provided to the application program.

- An Invocation code of X'0001' has been pushed onto the stack. Before returning to the adapter support software the application program must remove the invocation code from the stack.
- Register DI contains the offset of the network status appendage as defined by the DIR.SET.EXCEPTIONS.FLAGS command.
- Register DS contains the application program device driver's protect mode data segment.
- Register CX contains the adapter number.
- Registers ES and BX contain the address of the following 14 byte information table.
- Register AX contains the network status code.

PARAMETER NAME	BYTE LEN	8086 TYPE	DESCRIPTION
CCB_COUNT	2	DW	Count of CCBs chained to EVENT_CCB_POINTER *
EVENT_CCB_POINTER	4	DD	Pointer to the first of a queue of commands which were outstanding when the adapter closed *
BUFFER_COUNT	2	DW	Count of buffers chained to FIRST_BUFFER_ADDR *
FIRST_BUFFER_ADDR	4	DD	Address of first buffer in SAP buffer pools *
NETWORK_STATUS_CODE	2	DW	Network Status Code
* Indicates that this value is only returned when the adapter is closed as a result of entering an unrecoverable error.			

---

**FIRST\_BUFFER\_ADDR**

**Explanation:** Address of the first buffer in the SAP and direct station buffer pools. Buffers provided with the DLC.OPEN.SAP and DIR.OPEN.DIRECT commands are returned to the application program if the adapter closes.

---

**NETWORK\_STATUS\_CODE**

**Explanation:** Network Status Code being reported.

See "IBM Token-Ring Network Status Codes for All CCBs" on page B-46 when using an IBM Token-Ring Network adapter, and "IBM PC Network Status Codes for All CCBs" on page B-47 when using a PC Network adapter.

**IBM Token-Ring Network Status Codes for All CCBs**

BIT	FUNCTION	MEANING
15	Signal loss	Absence of any received signal detected.
14	Hard error	Beacon frames are being transmitted or received.
13	Soft error	This adapter has transmitted a soft error report MAC frame.
12	Transmit beacon	The adapter is transmitting beacon frames.
11	Lobe wire fault	An open or short circuit has been detected in the lobe data path. The adapter will be closed.
10	Auto-removal error 1	An adapter hardware error has been detected following the beacon auto-removal process. The adapter has been removed from the ring. The adapter will be closed.
9	Reserved	
8	Remove received	A remove MAC frame has been received. The adapter will be closed.
7	Counter overflow	One of the adapter error log counters has been incremented from 254 to 255. The DIR.READ.LOG command should be issued.
6	Single station	The adapter has opened and is the only station on the ring. The bit will be reset when another station is detected.
5	Ring Recovery	The adapter is transmitting or receiving Monitor Contention (claim token) MAC frames. This bit will be reset upon receipt of a Ring Purge MAC frame.
0 - 4	Reserved	

Multiple bits may be set when a network status change is posted.

For a beaconing condition the following network status events will be reported in the following order:

- For the station that will initially be transmitting the beacon frames
  - Ring Recovery (bit 5) set
  - Then after 1 second
    - Signal Loss (bit 15) set
    - Hard Error (bit 14) set
    - Transmit Beacon (bit 12) set

- For the station that will initially be receiving the beacon frames
  - Ring Recovery (bit 5) set
  - Then after 1 second
    - Hard Error (bit 14) set

The Ring Recovery bit will remain on for the entire time that the ring is beaconing. When using OS/2, if the ring is beaconing when an application program issues the DIR.OPEN.ADAPTER command and then issues the DIR.STATUS command the Ring Recovery bit will be set. However, bits 15, 14, and 12 may toggle depending on the immediate state of the ring seen by each adapter as a result of adapters doing diagnostic testing. When the ring stops beaconing all bits including the Ring Recovery bit will be zero.

### IBM PC Network Status Codes for All CCBs

BIT	FUNCTION	MEANING
15	No Carrier	No carrier on this card during transmit.
14	Reserved	
13	Reserved	
12	Hot Carrier	The adapter has detected Hot carrier on the network for more than 30 seconds.
11	Reserved	
10	Hot Carrier	This adapter is generating Hot Carrier. (The adapter will be closed.)
9	Reserved	
8	Remove Received	A network management REMOVE frame has been received. (The adapter will be closed.)
7	Counter Overflow	One of the Error Log Counters has incremented from 254 to 255.
0-6	Reserved	

## Bring-Up Errors for All CCBs

For CCB1: Bring-up testing is done when the DIR.INITIALIZE command is executed. If these tests are not completed successfully indicating an adapter failure, the bring-up error code will be returned in the BRING\_UP field of the DIR.INITIALIZE parameter table. The CCB\_RETCODE in the CCB will also contain '07' (command canceled: unrecoverable failure) when the command is terminated.

For CCB2 and CCB3: Bring-up testing is done during initialization when the adapter support software is loaded and when the DIR.INITIALIZE command is issued with the correct system key. The results of the bring-up tests are returned to application programs when the DIR.OPEN.ADAPTER and DIR.INITIALIZE commands are executed.

The bring-up error code is included in the ADAPTER\_PARMS table of the DIR.OPEN.ADAPTER command.

If during system initialization bring-up testing is not successful, error messages are displayed and logged in the ACSLAN.LOG file.

The values shown for the bring-up codes are as if the values were contained in the AX register.

## Bring-up Error Codes for All CCBs

Code	8086 Type	Meaning
'0020'	DW	Diagnostics could not execute
'0022'	DW	ROM (ROS) diagnostics failed
'0024'	DW	Shared RAM diagnostics failed
'0026'	DW	Processor instruction test failed
'0028'	DW	Processor interrupt test failed
'002A'	DW	Shared RAM interface register diagnostics failed
'002C'	DW	Protocol-handler diagnostics failed
'0040'	DW	Adapter's programmable timer for the PC system failed (set by the PC system code)
'0042'	DW	Cannot write to shared RAM (set by the PC system code)
'0044'	DW	Reading from shared RAM read-only area caused an invalid error indication (interrupt) (set by the PC system code)
'0046'	DW	Writing into shared RAM read-only area did not cause an error indication (interrupt) (set by the PC system code)
'0048'	DW	Initialization timed out

## IBM Token-Ring Network Adapter Open Errors for All CCBs

**For CCB1:** Adapter open testing is done when the DIR.OPEN.ADAPTER command is executed. If these tests do not complete successfully indicating either an adapter failure or a ring problem, the open error codes will be returned in the OPEN\_ERROR\_CODE field of the DIR.OPEN.ADAPTER parameter table. The CCB\_RETCODE in the CCB will also contain '07' (command canceled--unrecoverable failure) when the command is terminated.

**For CCB2 and CCB3:** Adapter open testing is done at system initialization or when a physical open is issued as a result of the DIR.OPEN.ADAPTER command being issued. If these tests do not execute successfully, the DIR.OPEN.ADAPTER command will be terminated with a return code of X'07'.

The open error codes are passed back to the user in the DIR.OPEN.ADAPTER ADAPTER\_PARMS table.

### Open Error Codes for All CCBs

The open errors are returned in 2 bytes. The high-order byte is always zero and the low-order byte contains:

1. The phase of testing in which the error was encountered is in the high-order nibble (half-byte) of the low-order byte.
2. The error condition is in the low-order nibble of the low-order byte.

### Phases

VALUE	MEANING
'1n'	Lobe media test
'2n'	Physical insertion
'3n'	Address verification
'4n'	Roll call poll (neighbor notification)
'5n'	Request parameters

### Errors

Value	Meaning
'n1'	Function failure
'n2'	Signal loss
'n3'	Reserved
'n4'	Reserved
'n5'	Timeout
'n6'	Ring failure
'n7'	Ring beaconing
'n8'	Duplicate node address
'n9'	Parameter request
'nA'	Remove received
'nB'	Reserved
'nC'	Reserved
'nD'	No monitor detected
'nE'	Monitor contention failed for RPL

### Suggested Actions in Response to Open Errors

When the following *Phase - Error* combination values are presented, they are the result of certain specific occurrences. Explanation of the occurrences follow with recommended actions listed. A list of recommended actions for both the application program and the PC system operator is provided following the explanations.

#### Explanations of Occurrences

- **X'11' Lobe Media, Function Failure**

*Failure Definition:* The testing of the lobe between the adapter and the access unit has been unsuccessful because the lobe has a bit-error rate that is too high or the adapter cannot receive successfully.

*Recommended Actions* 1, 3, and 5

- **X'26' Physical Insertion, Ring Failure**

*Failure Definition:* The adapter, acting as an active monitor, was unable to complete the ring purge function successfully indicating an error condition has occurred since the successful completion of monitor contention (claim token), when this adapter became the active monitor.

*Recommended Actions* 1 and 2a

- **X'27' Physical Insertion, Ring Beaconing**

*Failure Definition:* The adapter has detected one of the following conditions.

- The adapter tried to insert on a ring that was operating at a different data rate.
- A monitor contention (claim token) failure occurred.
- The adapter received a beacon MAC frame from the ring.

*Recommended Actions* 1, 2, and 2b

- **X'2A' Physical Insertion, Timeout**

*Failure Definition:* The adapter has received a remove ring station MAC frame indicating that a network management function has directed this adapter to get off the ring.

*Recommended Actions* 2a and 4

- **X'2D'**

*Failure Definition:* RPL station is the first station attempting to insert onto the ring.

*Recommended Actions* 1 and 2a

- **X'2E'**

*Failure Definition:* Physical insertion failure of RPL station.

*Recommended Action* 2

- **X'32' Address Verification, Signal Loss**

*Failure Definition:* The adapter has detected a 250-millisecond signal loss (receiver cannot recognize signal) indicating that an error condition has occurred since the adapter successfully completed the ring signal recognition phase of the open operation.

*Recommended Actions* 1 and 2a

- **X'35' Address Verification, Timeout**

*Failure Definition:* The insertion timer has expired before this function completed, indicating that the ring may be congested, experiencing a high bit-error rate, or losing an abnormally high number of tokens or frames, thus preventing successful Address Verification MAC frame transmissions.

*Recommended Actions* 1 and 2a

- **X'36' Address Verification, Ring Failure**  
*Failure Definition:* The adapter, acting as an active monitor, was unable to complete the ring purge function successfully indicating an error condition has occurred since the successful completion of monitor contention (claim token), when this adapter became the active monitor.  
*Recommended Actions* 1 and 2a
- **X'37' Address Verification, Ring Beaconsing**  
*Failure Definition:* The adapter has either detected a monitor contention (claim token) failure or received a beacon MAC frame from the ring.  
*Recommended Actions* 1 and 2b
- **X'38' Address Verification, Duplicate Node Address**  
*Failure Definition:* The adapter has detected that another station on the ring has an adapter address equal to the adapter address being tested.  
*Recommended Action* 4
- **X'3A' Address Verification, Remove Received**  
*Failure Definition:* The adapter has received a remove ring station MAC frame indicating that a network management function has directed this specific address to get off the ring.  
*Recommended Actions* 2a and 4
- **X'42' Ring Poll, Signal Loss**  
*Failure Definition:* The adapter has detected a 250-millisecond signal loss (receiver can not recognize signal) indicating that an error condition has occurred since the adapter successfully completed the ring signal recognition phase of the open operation.  
*Recommended Actions* 1 and 2a
- **X'45' Ring Poll, Timeout**  
*Failure Definition:* The insertion timer has expired before this function completed, indicating that the ring may be congested, experiencing a high bit error rate, or losing an abnormally high number of tokens or frames. This prevents the adapter's successful reception of either the ring poll request or response MAC frame, or transmission of the required ring poll response MAC frame.  
*Recommended Actions* 1 and 2a
- **X'46' Ring Poll, Ring Failure**  
*Failure Definition:* The adapter, acting as an active monitor, was unable to complete the ring purge function successfully indicating an error condition has occurred since the successful completion of monitor contention (claim token), when this adapter became the active monitor.  
*Recommended Actions* 1 and 2a
- **X'47' Ring Poll, Ring Beaconsing**  
*Failure Definition:* The adapter has either detected a monitor contention (claim token) failure or received a beacon MAC frame from the ring.  
*Recommended Actions* 1 and 2b
- **X'4A' Ring Poll, Remove Received**  
*Failure Definition:* The adapter has received a remove ring station MAC frame, indicating that a network management function has directed this adapter to get off the ring.  
*Recommended Actions* 2a and 4
- **X'55' Request Parameters, Timeout**



## Adapter Open Errors

*Failure Definition:* The insertion timer has expired before this function completed, indicating that the ring may be congested, experiencing a high bit-error rate, or losing an abnormally high number of tokens or frames. This prevents successful transmission of the request parameter MAC frame or reception of either the set parameters 1 or set parameters 2 MAC frame (required response to the adapter's request).

*Recommended Actions* 1 and 2a

- **X'56' Request Parameters, Ring Failure**

*Failure Definition:* The adapter, acting as an active monitor, was unable to complete the ring purge function successfully, indicating an error condition has occurred since the successful completion of monitor contention (claim token), when this adapter became the active monitor.

*Recommended Actions* 1 and 2a

- **X'57' Request Parameters, Ring Beaconing**

*Failure Definition:* The adapter has received a beacon MAC frame from the ring.

*Recommended Actions* 1 and 2b

- **X'59' Request Parameters, Parameter Request**

*Failure Definition:* The adapter has detected that the ring parameter server is present on the ring, but that the required response (set parameters 1 or set parameter 2 MAC frame) has not been received in the allotted time. This indicates that the ring may be congested, experiencing a high bit-error rate, or losing an abnormally high number of tokens or frames.

*Recommended Actions* 1 and 2a

- **X'5A' Request Parameters, Remove Received**

*Failure Definition:* The adapter has received a remove ring station MAC frame, indicating that a network management function has directed this adapter to get off the ring.

**The Recommended Actions** 2a and 4

### Recommended Actions Table

NUM	Description
1	After delaying at least 30 seconds, retry the open two times, inserting the same delay between each retry.
2	After delaying at least 30 seconds, check the adapter configuration (especially the adapter data rate) and retry the open.
2a	If this error persists, direct the PC system operator to contact the network administrator for assistance and provide "Open Error" information.
2b	If this error persists, direct the PC system operator to contact the network administrator for assistance and provide information from the "Adapter Status Parameter Table" on page B-35.
3	Direct the PC system operator to contact the network administrator for assistance and provide "Open Error" information.
4	Direct the PC system operator to contact the network administrator for assistance and provide "Node Address" information and try attaching to the ring after 6 minutes.
5	If this error persists, problem determination of the adapter or lobe is necessary. Contact your network administrator for problem determination assistance.

## IBM PC Network Adapter Open Errors for All CCBs

The open error codes are returned in a DW, the high order byte is always zero:

VALUE	MEANING
X'0022'	No Carrier
X'0023'	Hot Carrier
X'0033'	Unable to Transmit
X'0038'	Duplicate Node Address
X'003A'	REMOVE frame Received

## IBM PC System Detected Errors

### IBM PC System Detected Errors for CCB1

This appendage is defined by the DIR.OPEN.ADAPTER, DIR.SET.USER.APPENDAGE, DIR.INITIALIZE, and DIR.MODIFY.OPEN.PARMS commands.

**Note:** The PC System Detected Error is not intended as a substitute for normal PC system error detection, for example, a divide check.

If the adapter support software code detects an error condition in the PC system, the sequence of events will be determined by the type of error, which is passed to the appendage in register AL.

The following information is passed to the appendage:

1. Register AL contains the error code.
2. Register AH contains information on a per error code basis.  
If register AH is used, it is indicated in the status code explanation.
3. Register CX contains the adapter number.
4. Registers ES and BX:

If both registers are not X'0000', they are pointers to a queue of commands that were outstanding when the error occurred.

If both registers were X'0000', either the command executing could not be determined or it is not applicable.

The error code is passed to the appendage in register AX.

The PC System detected error codes are:

<i>Code</i>	<i>Meaning</i>
X'0000'	Spurious interrupt detected
X'0001'	Access violation. An attempt to write into the read-only portion of shared RAM has occurred.
X'01xx'	An ARB command code error, where xx is the command code.

## PC System Detected Errors

- X'02xx'** An ARB return code error, where xx is the return code from the adapter.
- X'03xx'** An SRB/SSB command code error, where xx is the CCB command code.
- X'04xx'** ARB transmit data request error, (the transmit CCB was not found) where xx is the command correlator from the adapter.

## IBM PC System Detected Errors for CCB2

These types of errors are errors encountered by the adapter support software during operation.

**Note:** The PC System Detected Error is not intended as a substitute for normal PC system error detection, for example, a divide check.

If the adapter support software detects an error condition in the PC system or OS/2 generates a return code that is not acceptable for the given situation, an error code is passed to the application program via the READ command.

In these cases the adapter will be closed, adapter support software will assume the adapter has encountered an unrecoverable error.

When the unrecoverable error is entered link stations are closed and SAP and direct station buffer pools, outstanding receive frames, and CCBs may be returned to the application program if the PC\_ERROR\_FLAG is set, see DIR.SET.EXCEPTION.FLAGS in the *IBM Local Area Network Technical Reference*.

Whenever a PC System Detected error occurs, the application program can be notified if the PC\_ERROR\_FLAG is set. In order for an application program to receive notification of a PC System Detected error a READ command must be issued before the event occurs requesting notification of critical exceptions. When the event occurs the READ command will be posted using a semaphore.

The information listed in the table below will be copied into the READ commands parameter table.

PARAMETER NAME	BYTE LEN	8086 TYPE	DESCRIPTION
NOTIFICATION_FLAG	4	DD	User exception flag
CCB_COUNT	2	DW	Count of CCBs chained to EVENT_CCB_POINTER
EVENT_CCB_POINTER	4	DD	Pointer to the first of a queue of commands which were outstanding when the adapter closed
BUFFER_COUNT	2	DW	Count of buffers chained to FIRST_BUFFER_ADDR
FIRST_BUFFER_ADDR	4	DD	Address of first buffer in SAP and direct station buffer pools.
RCV_FRAME_COUNT	2	DW	Count of received frames chained to RCV_FRAME_ADDR
RCV_FRAME_ADDR	4	DD	Address of the first received frame of a possible chain of frames
ERROR_CODE	1	DB	Error Code

PARAMETER NAME	BYTE LEN	8086 TYPE	DESCRIPTION
ERROR_DATA	1	DB	Error Data
FUNCTION_CODE	1	DB	Operating System/2 command code that failed
	1	DB	Reserved
	2	DW	Reserved
PROCESS_ID	2	DW	Process ID

---

#### NOTIFICATION\_FLAG

**Explanation:** User Notification Flag

This user exception flag is the PC\_ERROR\_FLAG as defined using the DIR.SET.EXCEPTIONS.FLAG command.

---

#### FIRST\_BUFFER\_ADDR

**Explanation:** Address of the first buffer in SAP and direct station buffer pools

Buffers provided with the DLC.OPEN.SAP and DIR.OPEN.DIRECT commands are returned to the application program when the adapter closes as a result of an unrecoverable error.

---

#### RCV\_FRAME\_ADDR

**Explanation:** Address of the first received frame

All received frames for this application that were on the completion list at the time of the exception will be queued to this field when the adapter encounters an unrecoverable error. The first buffer of each frame will point to the next frame.

---

#### ERROR\_CODE/ERROR\_DATA

**Explanation:** These two fields contain the error code and associated data for the PC System Detected error.

The list below indicates both the ERROR\_CODE and the ERROR\_DATA. The ERROR\_CODE is the first byte and the ERROR\_DATA is the second byte.

- X'0000' An IBM Token-Ring Network adapter interrupt has occurred and the interrupt was unexpected. For example, the adapter is not open.
- X'0001' Access violation: an attempt was made to write to the read-only portion of shared RAM.
- X'01xx' ARB command code error: an undefined ARB was returned from the adapter. The "xx" indicates the command code.
- X'02xx' ASB return code error: there was an unexpected ASB interrupt from the adapter as a result of an ARB command. The "xx" will be set to the return code from the adapter.
- X'03xx' SRB/SSB command code error. The "xx" will be set to the CCB command code.
- X'04xx' ARB transmit data request error: the transmit CCB was not found. The "xx" is the command correlator from the adapter.

## PC System Detected Errors

### X'05xx'

Unacceptable error conditions resulting from Operating System/2 return code values.

If while processing on the thread of an application program in the adapter support software device driver, an Operating System/2 return code is generated that is not acceptable for a given situation the return code in the AX register will contain X'04'.

X'06xx' An adapter support software internal error. The "xx" will be set to an internal error code.

**Note:** Codes not shown (X'07' through X'7F') are reserved.

---

### FUNCTION\_CODE

**Explanation:** The Operating System/2 command code that failed

This field is only used for an ERROR\_CODE of X'05'.

This field will contain the Function Code of a Device Help command that resulted in this PC System Detected error.

---

### PROCESS\_ID

**Explanation:** The Operating System/2 Process ID

This field is only used for the ERROR\_CODES X'05' and X'06' and will contain the Operating System/2 Process ID that was dispatched while the error occurred. A Process ID of X'0000' is used when an error occurs while processing an interrupt.

## IBM PC System Detected Errors for CCB3

These types of errors are errors encountered by the adapter support software during operation.

**Note:** The PC System Detected Error is not intended as a substitute for normal PC system error detection, for example, a divide check.

If the adapter support software detects an error condition in the PC system or OS/2 generates a return code that is not acceptable for the given situation, an error code is passed to the application program when the adapter support software calls the application program's device driver with the appropriate event appendage offset passed in register DI. Upon entry into the application program's device driver, the AX register will contain the error code.

In these cases the adapter will be closed, the adapter support software will assume the adapter has encountered an unrecoverable error.

When the unrecoverable error is entered, link stations are closed and SAP and direct station buffer pools and CCBs may be returned to the application program if the PC detected error appendage (PCERROR\_APPNDG\_OFFSET) has been defined using the DIR.SET.EXCEPTION.FLAGS command, see DIR.SET.EXCEPTION.FLAGS in the *IBM Local Area Network Technical Reference*. If the appendage has been defined, the adapter support software will call the application program's device driver with the PC system detected appendage offset passed in register DI to notify the user of the error.

Whenever a PC system detected error occurs, the application program can be notified if the PC detected error appendage has been defined using the DIR.SET.EXCEPTION.FLAGS command.

The information listed in the table below will be contained in the table pointed to by registers ES and BX, when the adapter support software calls the application program's device driver with the appropriate event appendage offset passed in register DI.

**Application Calls:** When the adapter support software calls the application program at the address obtained by the ATTACHDD function, the following information is provided to the using application.

- An Invocation code of X'0001' has been pushed onto the stack. Before returning to the adapter support software the application must remove the invocation code from the stack.
- Register DI contains the offset of the adapter check appendage as defined by the DIR.SET.EXCEPTIONS.FLAG command.
- Register DS contains the application program device driver's protect mode data segment.
- Register CX contains the adapter number.
- Registers ES and BX contain the address of the following 20 byte information table.
- Register AX contains the error code.

PARAMETER NAME	BYTE LEN	8086 TYPE	DESCRIPTION
CCB_COUNT	2	DW	Count of CCBs chained to EVENT_CCB_POINTER
EVENT_CCB_POINTER	4	DD	Pointer to the first of a queue of commands which were outstanding when the adapter closed
BUFFER_COUNT	2	DW	Count of buffers chained to FIRST_BUFFER_ADDR
FIRST_BUFFER_ADDR	4	DD	Address of first buffer in SAP buffer pools
ERROR_CODE	1	DB	Error Code
ERROR_DATA	1	DB	Error Data
FUNCTION_CODE	1	DB	Operating System/2 command code that failed
	1	DB	Reserved
	2	DW	Reserved
	2	DW	Reserved

---

**FIRST\_BUFFER\_ADDR**

**Explanation:** Address of the first buffer in SAP and direct station buffer pools

Buffers provided with the DLC.OPEN.SAP and DIR.OPEN.DIRECT commands are returned to the application program when the adapter closes as a result of an unrecoverable error.

---

**ERROR CODE/ERROR DATA**

**Explanation:** These two fields contain the error code and associated data for the PC System Detected error.

The list below indicates both the ERROR\_CODE and the ERROR\_DATA. The ERROR\_CODE is the first byte and the ERROR\_DATA is the second byte.

**X'0000'** An IBM Token-Ring Network adapter interrupt has occurred and the interrupt was unexpected. For example, the adapter is not open.

**X'0001'** Access violation: an attempt was made to write to the read-only portion of shared RAM.

**X'01xx'** ARB command code error: an undefined ARB was returned from the adapter. The "xx" indicates the command code.

**X'02xx'** ASB return code error: there was an unexpected ASB interrupt from the adapter as a result of an ARB command. The "xx" will be set to the return code from the adapter.

**X'03xx'** SRB/SSB command code error. The "xx" will be set to the CCB command code.

**X'04xx'** ARB transmit data request error: the transmit CCB was not found. The "xx" is the command correlator from the adapter.

**X'05xx'** Unacceptable error conditions resulting from Operating System/2 return code values.

If while processing on the thread of an application program in the adapter support software device driver, an Operating System/2 return code is generated that is not acceptable for a given situation the immediate return code in the AX register will contain X'04'.

**X'06xx'** An adapter support software internal error. The "xx" will be set to an internal error code.

**Note:** Codes not shown (X'07' through X'7F') are reserved.

---

**FUNCTION\_CODE**

**Explanation:** The Operating System/2 command code that failed

This field is only used for an ERROR\_CODE of X'05'.

This field will contain the Function Code of a Device Help command that resulted in this PC System Detected error.

---

## System Action Exceptions for OS/2

### System Action Exceptions for CCB2

This exception is the result of a system administrator issuing commands using the `SYSTEM.KEY` defined in the configuration file. The following commands when issued with the `SYSTEM.KEY` will result in a System Action exception.

```
DIR.CLOSE.ADAPTER
DIR.CLOSE.DIRECT
DIR.INITIALIZE
DIR.READ.LOG
DIR.SET.FUNCTIONAL.ADDRESS
DIR.SET.GROUP.ADDRESS
DLC.RESET
```

System Action exceptions result in an adapter closing, an adapter initializing, reading of either the adapter or direct interface logs, modification of the functional or group addresses, resetting link stations, or forced availability (closed) of the direct stations. When link stations are closed or the direct stations are closed due to a System Action exception the link and direct station's buffer pools, the outstanding receive frames, and CCBs may be returned to the application program if the `SYSTEM_ACTION_FLAG` is set, see the `DIR.SET.EXCEPTION.FLAGS` in the *IBM Local Area Network Technical Reference*.

Whenever a System Action occurs, the application program will be notified if the `SYSTEM_ACTION_FLAG` is set and the using code has a `READ` outstanding. To receive notification of a System Action Exception resulting from the `DIR.CLOSE.ADAPTER` and `DIR.INITIALIZE` commands, the `READ` command must be issued before the event occurs. The information listed in the following table is copied into the `READ` command's parameter table and the `READ` command's semaphore is cleared to post the application program.

For the commands and associated application programs listed below, if the `SYSTEM_ACTION_FLAG` is set, the adapter support software will notify the application program of system action exceptions.

- `DIR.CLOSE.ADAPTER` for all application programs
- `DIR.CLOSE.DIRECT` for an application program owning the Direct Interface (a previously issued `DIR.OPEN.DIRECT` command was successful)
- `DIR.INITIALIZE` for all application programs
- `DIR.READ.LOG` for an application program owning the Direct Interface (a previously issued `DIR.OPEN.DIRECT` command was successful)
- `DIR.SET.FUNCTIONAL.ADDRESS` for all application programs
- `DIR.SET.GROUP.ADDRESS` for all application programs
- `DLC.RESET` for application programs owning the affected SAPs



## System Action Exceptions

PARAMETER NAME	BYTE LEN	8086 TYPE	DESCRIPTION
NOTIFICATION_FLAG	4	DD	User exception flag
CCB_COUNT	2	DW	Count of CCBs chained to EVENT_CCB_POINTER
EVENT_CCB_POINTER	4	DD	Pointer to the first of a queue of commands which were outstanding when the adapter closed or when direct stations are closed
BUFFER_COUNT	2	DW	Count of buffers chained to FIRST_BUFFER_ADDR
FIRST_BUFFER_ADDR	4	DD	Address of first buffer in SAP or DIRECT buffer pools
RCV_FRAME_COUNT	2	DW	Count of received frames chained to RCV_FRAME_ADDR
RCV_FRAME_ADDR	4	DD	Address of the first received frame of a possible chain of frames
SYSTEM_ACTION_ID	1	DB	System action identifier
SAP_STATION_RESET	1	DB	link station reset

---

### NOTIFICATION\_FLAG

**Explanation:** User Notification Flag

This user exception flag is SYSTEM\_ACTION\_FLAG as defined using the DIR.SET.EXCEPTION.FLAGS command.

---

### FIRST\_BUFFER\_ADDR

**Explanation:** Address of the first buffer in SAP and direct station buffer pools.

Buffers provided with the DLC.OPEN.SAP and DIR.OPEN.DIRECT commands are returned to the application program if link stations are closed or reset.

---

### RCV\_FRAME\_ADDR

**Explanation:** Address of the first received frame.

All received frames for the affected link stations that were on the completion list at the time of the exception will be queued to this field. The first buffer of each frame will point to the next frame.

---

### SYSTEM\_ACTION\_ID

**Explanation:** System action identifier code.

The system action identifier code is passed to the user in the SYSTEM\_ACTION\_ID field. This code identifies the command issued that generated the system action exception.

- X'01' DIR.CLOSE.ADAPTER command issued resulting in the adapter closing.
- X'02' DIR.INITIALIZE command issued reinitializing the adapter
- X'03' DIR.READ.LOG command issued reading the adapter and/or direct interface logs

- X'04'** DIR.SET.FUNCTIONAL.ADDRESS command issued modifying the functional address
- X'05'** DIR.SET.GROUP.ADDRESS command issued modifying the group address
- X'06'** DLC.RESET command issued resetting a single link station  
When SAP is reset the SAP\_STATION\_RESET field will contain the link station that was reset.
- X'07'** DLC.RESET command issued resetting all link stations.  
When all link stations are reset no link station values are returned.
- X'08'** DIR.CLOSE.DIRECT command issued resulting in the direct stations closing and becoming available.

---

#### SAP\_STATION\_RESET

**Explanation:** Link station reset.

If the SYSTEM\_ACTION\_ID is set to X'06' then this value contains the SAP station number that was reset.

### System Action Exceptions for CCB3

This exception is the result of a system administrator issuing commands using the SYSTEM.KEY defined in the configuration file. The following commands when issued with the SYSTEM.KEY will result in a System Action exception.

DIR.CLOSE.ADAPTER  
DIR.CLOSE.DIRECT  
DIR.INITIALIZE  
DIR.READ.LOG  
DIR.SET.FUNCTIONAL.ADDRESS  
DIR.SET.GROUP.ADDRESS  
DLC.RESET

System Action exceptions result in an adapter closing, an adapter initializing, reading of the either the adapter or direct interface logs, modification of the functional or group addresses, resetting link stations, or forced availability (closed) of the direct stations. When link stations are closed or the direct stations are closed due to a System Action exception, the link and direct station's buffer pools and CCBs may be returned to the application program. If the user has passed the system action appendage (SYSTEM\_ACTION\_APPNDG\_OFFSET) to the adapter support software by issuing the DIR.SET.EXCEPTION.FLAGS command, see the DIR.SET.EXCEPTION.FLAGS in the *IBM Local Area Network Technical Reference*.

Whenever a System Action occurs, the application program will be notified if the SYSTEM\_ACTION\_APPNDG\_OFFSET has been defined to the adapter support software. Once the exception has occurred, the information listed in the table below is copied into the table referenced by the ES and BX registers when the adapter support software calls the application program's device driver with the appropriate event appendage offset passed in register DI.

## System Action Exceptions

For the commands and associated application programs listed below, if the `SYSTEM_ACTION_FLAG` is set, the adapter support software will be notified of system action exceptions.

- `DIR.CLOSE.ADAPTER` for all application programs
- `DIR.CLOSE.DIRECT` for an application program owning the Direct Interface (a previously issued `DIR.OPEN.DIRECT` command was successful)
- `DIR.INITIALIZE` for all application programs
- `DIR.READ.LOG` for an application program owning the Direct Interface (a previously issued `DIR.OPEN.DIRECT` command was successful)
- `DIR.SET.FUNCTIONAL.ADDRESS` for all application programs
- `DIR.SET.GROUP.ADDRESS` for all application programs
- `DLC.RESET` for application programs owning the affected SAPs

**Application Calls:** When the adapter support software calls the application program device driver entry point the following information is provided to the using application.

- An Invocation code of `X'0001'` has been pushed onto the stack. Before returning to the adapter support software the application must remove the invocation code from the stack.
- Register `DI` contains the offset of the adapter check appendage as defined by the `DIR.SET.EXCEPTIONS.FLAG` command.
- Register `DS` contains the application program device driver's protect mode data segment.
- Register `CX` contains the adapter number.
- Registers `ES` and `BX` contain the address of the following 20 byte information table.
- Register `AL` contains the System Action ID.
- Register `AH` contains the SAP value associated with the System Action ID.

PARAMETER NAME	BYTE LEN	8086 TYPE	DESCRIPTION
<code>CCB_COUNT</code>	2	DW	Count of CCBs chained to <code>EVENT_CCB_POINTER</code>
<code>EVENT_CCB_POINTER</code>	4	DD	Pointer to the first of a queue of commands which were outstanding when the adapter closed or when the direct stations are closed
<code>BUFFER_COUNT</code>	2	DW	Count of buffers chained to <code>FIRST_BUFFER_ADDR</code>
<code>FIRST_BUFFER_ADDR</code>	4	DD	Address of first buffer in SAP or direct station buffer pools
<code>SYSTEM_ACTION_ID</code>	1	DB	System action identifier
<code>SAP_STATION_RESET</code>	1	DB	link station reset

---

**FIRST\_BUFFER\_ADDR**

**Explanation:** Address of the first buffer in SAP and direct station buffer pools.

Buffers provided with the DLC.OPEN.SAP and DIR.OPEN.DIRECT commands are returned to the application program if link stations are closed or reset.

---

**SYSTEM\_ACTION\_ID**

**Explanation:** System action identifier code.

The system action identifier code is passed to the user in the SYSTEM\_ACTION\_ID field. This code identifies the command issued that generated the system action exception.

- X'01' DIR.CLOSE.ADAPTER command issued resulting in the adapter closing.
- X'02' DIR.INITIALIZE command issued reinitializing the adapter
- X'03' DIR.READ.LOG command issued reading the adapter and/or &dirif. logs
- X'04' DIR.SET.FUNCTIONAL.ADDRESS command issued modifying the functional address
- X'05' DIR.SET.GROUP.ADDRESS command issued modifying the group address
- X'06' DLC.RESET command issued resetting a single SAP  
When a single SAP is reset the SAP\_STATION\_RESET field will contain the link station that was reset.
- X'07' DLC.RESET command issued resetting all link stations  
When all link stations are reset no link station values are returned.
- X'08' DIR.CLOSE.DIRECT command issued resulting in the direct stations closing.

---

**SAP\_STATION\_RESET**

**Explanation:** Link station reset.

If the SYSTEM\_ACTION\_ID is set to X'06' then this value contains the SAP number that was reset.

## System Action Exceptions

---

## List of Abbreviations

<b>DGM</b>	data grade media	<b>OFCVTR</b>	IBM 8220 Optical Fiber Converter
<b>DP</b>	distribution panel	<b>OFP</b>	optical fiber patch cable
<b>DOS</b>	Disk Operating System	<b>OFRPTR</b>	IBM 8219 Optical Fiber Repeater
<b>E.R.</b>	Error Reporting	<b>P</b>	patch cable
<b>FP</b>	faceplate	<b>PC</b>	Personal Computer
<b>ft</b>	foot (or feet)	<b>P/N</b>	part number
<b>K</b>	1024	<b>RI</b>	Ring In
<b>KB</b>	kilobyte	<b>RO</b>	Ring Out
<b>m</b>	meter (or meters)	<b>RPTR</b>	IBM 8218 Copper Repeater
<b>Mbps</b>	megabits per second	<b>SS</b>	surge suppressor
<b>MSAU</b>	Multistation Access Unit	<b>YCP</b>	(yellow) crossover patch cable
<b>NETBIOS</b>	Network Basic Input/Output System		



# Glossary

## A

**access unit.** In the IBM Token-Ring Network, a wiring concentrator. See *wiring concentrator*.

**adapter.** In the IBM Token-Ring Network, the circuit card within a communicating device, and its associated software, that enable the device to communicate over the network.

**attach.** To connect a device logically to a ring network.

**attaching device.** Any device that is physically connected to a network and can communicate over the network.

**auto removal.** The action, performed by an adapter, of removing a device from the ring.

## B

**beacon.** A frame sent by an adapter indicating a serious ring problem, such as a broken cable. An adapter is said to be *beaconing* if it is sending such a frame.

**bridge.** An attaching device connected to two rings simultaneously to allow the transfer of information from one ring to the other. Rings joined together by bridges form multiple-ring networks.

**buffer.** A portion of storage for temporarily holding input or output data.

**bypass.** To eliminate an attaching device or component from a ring network by allowing the data to flow in a path around it.

## C

**closed network.** A network in which all the cable paths and wiring closets are directly or indirectly connected.

**component.** Any part of a network other than an attaching device, such as an access unit.

## D

**data link.** Any physical link, such as a wire or a telephone circuit, that connects one or more devices or communication controllers.

**device.** An input/output unit such as a terminal, display, or printer.

**distribution panel.** A wiring board that provides a patch panel function and mounts in a rack.

**downstream.** On a ring network, the direction of data flow. Contrast with *upstream*.

## F

**faceplate.** A plate for connecting data and voice connectors to a cabling system. It may be wall-mounted or surface-mounted.

**frame.** The unit of transmission in some local area networks, including the IBM Token-Ring Network. It may include delimiters, control characters, information, and checking characters.

## H

**hard error.** An error condition on a ring network that requires that the ring be reconfigured or that the source of the error be removed before the ring can resume reliable operation.

## L

**lobe.** In the IBM Token-Ring Network, the section of cable (which may consist of several segments) that connects a device to an access unit.

**lobe logic.** The portion of the circuitry within the IBM 8228 that is associated with a single lobe receptacle on the IBM 8228.

**lobe receptacle.** An outlet on an IBM 8228 for connecting a lobe. On the IBM 8228 Multistation Access Unit, the lobe receptacles are numbered 1 to 8.

**local area network.** A network in which communications are limited to a moderate-sized geographic area such as a single office building, warehouse, or campus and which do not generally extend across public rights-of-way.

## M

**main ring path.** The part of the ring made up of IBM 8228 Multistation Access Units, IBM 8218 Copper Repeaters, IBM 8219 Optical Fiber Repeaters, IBM 8220 Optical Fiber Converters, and the cables connecting them.



## N

**NAUN.** Nearest active upstream neighbor. For any given adapter on a ring network, the nearest active adapter that is directly preceding it.

**network administrator.** A person who manages the use and maintenance of a network.

## O

**observer terminal.** The device used to run the IBM Token-Ring Network Ring Diagnostic or a network application program that is capable of providing ring status information.

**open.** A break in an electrical circuit.

## P

**patch cable.** In the IBM Cabling System, a length of type 6 cable with data connectors on both ends.

## R

**remove.** To take a station off the ring.

**ring error limit.** In the IBM Token-Ring Network Ring Diagnostic, the point at which the number of soft errors makes ring operation unreliable.

**ring (network).** A network configuration where a series of attaching devices are connected by unidirectional transmission links to form a closed path.

**Ring In.** On an access unit, the receive or input receptacle.

**Ring Out.** On an access unit, the transmit or output receptacle.

**ring sequence.** The order in which stations are attached on a ring network.

**ring status.** The condition of the ring.

## S

**soft error.** An error on a network that affects the network's performance but does not, by itself, affect its overall reliability. If the number of soft errors reaches the ring error limit, reliability is affected.

**star.** A wiring arrangement in which an individual cable runs from each work area to a concentration point.

**station.** (1) A work station. (2) A communication device attached to a network. See attaching device.

## T

**terminal.** A device or work station.

**token.** A sequence of bits passed from one device to another along the network. When the token has data appended to it, it becomes a *frame*.

## U

**upstream.** On a ring network, the direction opposite to that of data flow. Contrast with downstream.

## W

**wire fault.** An error condition caused by a break in the wires or a short between the wires (or shield) in a segment of cable.

**wiring closet.** A room that contains one or more equipment racks and distribution panels that are used to connect cables together to form physical networks.

**wiring concentrator.** A lobe concentrator that allows multiple attaching devices access to the ring at a central point such as a wiring closet or in an open work area.

**work area.** An area in which terminal devices (such as displays, keyboards, and printers) are located. Access units may also be located in work areas.

**work station.** An input/output device that allows transmission of data or reception of data as needed to perform a job.

**working diskette.** A computer diskette to which files are copied from an original diskette. The working diskette is used in everyday operation.

# Index

## A

- access unit X-3
- adapter X-3
- Adapter Address to Physical Location Locator Chart 2-4
  - use, how to A-4
- attach X-3
- attaching device X-3
- auto removal X-3
  - of errors 1-9

## B

- backup path 1-7, 1-8
- beacon X-3
- beaconing device, definition of A-29
- bridge X-3
  - find, how to A-25
- Bridge Planning Chart 2-4
  - use, how to A-25
- buffer X-3
- bypass X-3
  - IBM 8228 A-27

## C

- charts
  - Adapter Address to Physical Location Locator Chart 2-4
  - Bridge Planning Chart 2-4
  - IBM 8218 Cabling Chart 2-4
  - IBM 8218 Cabling Chart for Telephone Twisted-Pair-Based Rings 2-4
  - IBM 8219 Cabling Chart 2-4
  - IBM 8219 Cabling Chart for Telephone Twisted-Pair-Based Rings 2-4
  - IBM 8220 Cabling Chart 2-4
  - IBM 8228 Cabling Chart 2-4
  - Physical Location to Adapter Address Chart 2-4
  - Ring Sequence Chart 2-4
    - use, how to A-3
- closed network X-3
- component X-3

## D

- Data Area Messages, Ring Diagnostic
  - explanations 6-14
  - general description 6-4
- data link X-3
- device X-3
- distribution panel X-3

downstream X-3

## E

- errors
  - auto removal 1-9
  - intermittent 1-9
  - manual removal 1-9

## F

- faceplate X-3
- fault domain, beaconing condition
  - find, how to A-29
- fault domain, beaconing on backup ring
  - fault domain, beaconing on backup ring A-33
  - find, how to A-33
- fault domain, soft error
  - find, how to A-37
- find, how to
  - a device A-4, A-6
  - an IBM 8228 A-11
  - fault domain, beaconing condition A-29
  - fault domain, soft error A-37
- first device, definition of A-37
- frame X-3
- function keys
  - Ring Diagnostic 6-6

## H

- hard error X-3

## I

- IBM Token-Ring Network, design of 1-4
- IBM 8218 Cabling Chart 2-4
  - use, how to A-15
- IBM 8218 Cabling Chart for Telephone Twisted-Pair-Based Rings 2-4
- IBM 8218 Copper Repeater
  - find, how to A-15
- IBM 8219 Cabling Chart 2-4
  - use, how to A-15
- IBM 8219 Cabling Chart for Telephone Twisted-Pair-Based Rings 2-4
- IBM 8219 Optical Fiber Repeater
  - find, how to A-15
- IBM 8220 Cabling Chart 2-4
- IBM 8220 Optical Fiber Cabling Chart
  - use, how to A-15
- IBM 8220 Optical Fiber Converter
  - find, how to A-15

IBM 8228  
find, how to A-10, A-19  
IBM 8228 Cabling Chart 2-4  
use, how to A-6

## L

lobe X-3  
example 1-5  
lobe logic X-3  
lobe receptacle X-3  
local area network X-3

## M

main ring path 1-6, X-3  
Megabits per second  
four iii  
sixteen iii

## N

NAUN X-4  
NAUN device, definition of A-29  
needs 5-4  
network administrator X-4

## O

observer terminal X-4  
observer terminal, definition of 3-3  
open X-4  
output of the Ring Diagnostic 6-4

## P

parameters, Ring Diagnostic 5-7  
patch cable X-4  
Physical Location to Adapter Address Chart 2-4  
problem determination procedures  
format, explanation of 2-6  
phases 1-3  
ring recovery procedure 4-3  
rules and terms 3-3  
start 3-3  
suggestions 2-3  
what you need 2-4  
publications, related v  
obtain, how to v

## R

remove X-4  
return codes  
adapter check B-41  
bring-up B-48  
CCB\_RETCODE B-3  
Direct B-3  
DLC B-3

return codes (*continued*)

exception B-37  
open errors B-49  
Ring Diagnostic  
data area messages  
explanations 6-14  
general description 6-4  
displayed output 6-4  
function keys 6-6  
optional parameters 5-7  
preparing diskette for 5-3  
required parameter 5-7  
ring status 6-4  
ring status area 6-10  
setting parameters 5-7  
start, how to 6-3  
status area messages 6-11  
use, how to 6-3  
ring error limit X-4  
ring errors  
adapter check B-37  
adapter open B-49  
bring-up B-48  
PC System detected B-53  
ring B-36, B-43  
ring in X-4  
ring out X-4  
ring sequence X-4  
Ring Sequence Chart 2-4  
use, how to A-19  
ring status X-4  
ring (network) X-4

## S

second device, definition of A-37  
soft error X-4  
star X-4  
station X-4

## T

terminal X-4  
token X-4

## U

upstream X-4  
use, how to  
diagrams 2-7

## W

wire fault X-4  
wiring closet X-4  
wiring concentrator X-4  
work area X-4

work station X-4  
working diskette X-4

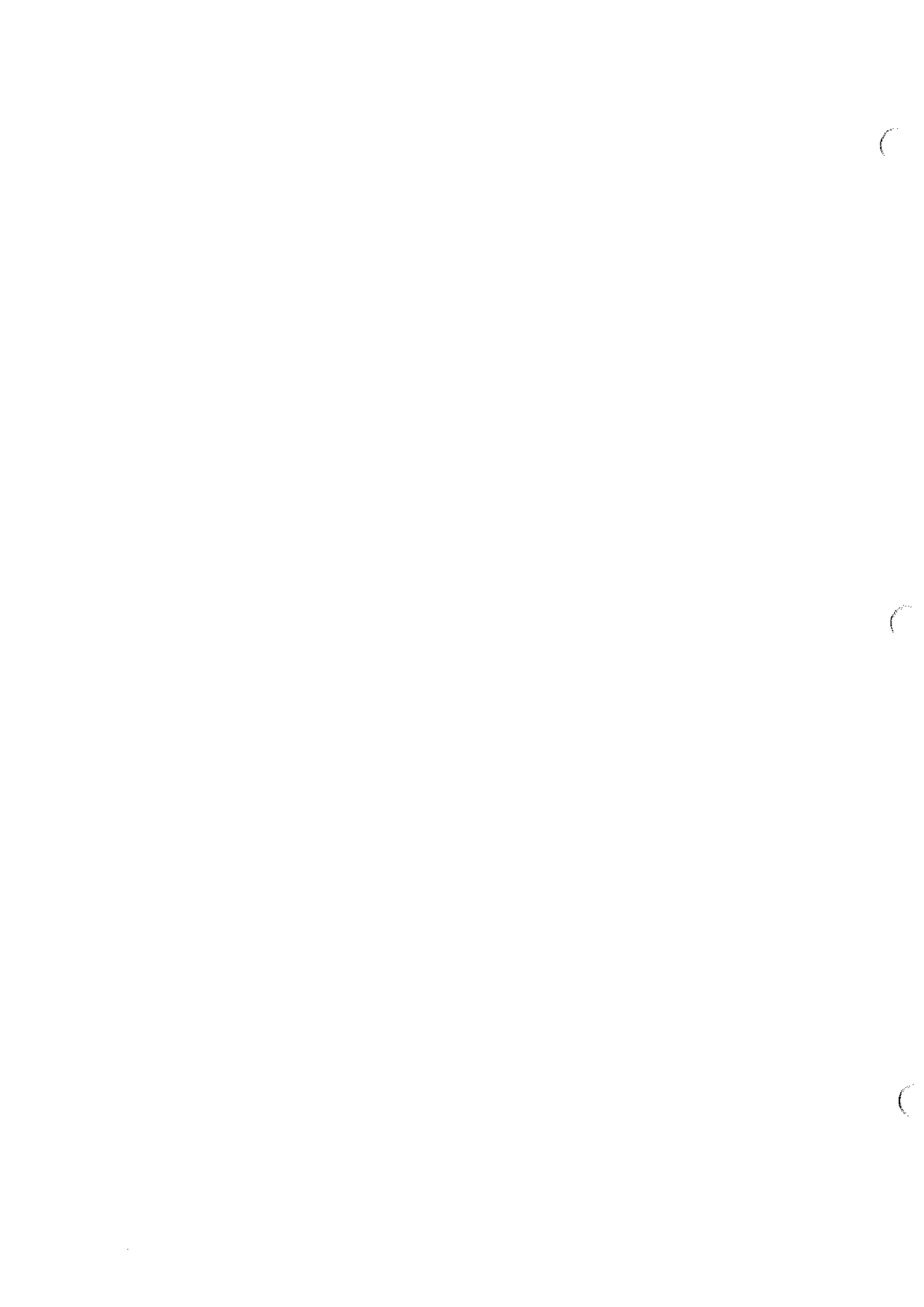

Publication No. SX27-3710-3

This manual is part of a library that serves as a reference source for systems analysts, programmers, and operators of IBM systems. You may use this form to communicate your comments about this publication, its organization, or subject matter, with the understanding that IBM may use or distribute whatever information you supply in any way it believes appropriate without incurring any obligation to you.

**Note:** Copies of IBM publications are not stocked at the location to which this form is addressed. Please direct any requests for copies of publications, or for assistance in using your IBM system, to your IBM representative or to the IBM branch office serving your locality.

Possible topics for comment are:

Clarity    Accuracy    Completeness    Organization    Coding    Retrieval    Legibility

If you wish a reply, give your name, company, mailing address, date, and location of your local IBM branch office:

---

---

---

---

---

What is your occupation? \_\_\_\_\_

Number of latest Newsletter associated with this publication: \_\_\_\_\_

Thank you for your cooperation. No postage stamp necessary if mailed in the U.S.A. (Elsewhere, an IBM office or representative will be happy to forward your comments or you may mail directly to the address in the Edition Notice on the back of the title page.)

**Reader's Comment Form**

Fold and tape

Please Do Not Staple

Fold and tape

**BUSINESS REPLY MAIL**  
FIRST CLASS PERMIT NO. 40 ARMONK, N.Y.

POSTAGE WILL BE PAID BY ADDRESSEE

International Business Machines Corporation  
Dept. E02  
P.O. Box 12195  
Research Triangle Park, N.C. 27709-9990

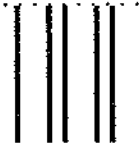

NO POSTAGE  
NECESSARY  
IF MAILED  
IN THE  
UNITED STATES

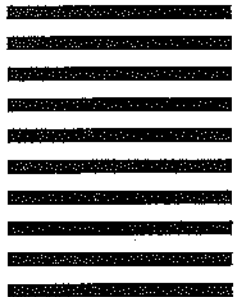

Fold and tape

Please Do Not Staple

Fold and tape



Publication No. SX27-3710-3

This manual is part of a library that serves as a reference source for systems analysts, programmers, and operators of IBM systems. You may use this form to communicate your comments about this publication, its organization, or subject matter, with the understanding that IBM may use or distribute whatever information you supply in any way it believes appropriate without incurring any obligation to you.

**Note:** Copies of IBM publications are not stocked at the location to which this form is addressed. Please direct any requests for copies of publications, or for assistance in using your IBM system, to your IBM representative or to the IBM branch office serving your locality.

Possible topics for comment are:

Clarity    Accuracy    Completeness    Organization    Coding    Retrieval    Legibility

If you wish a reply, give your name, company, mailing address, date, and location of your local IBM branch office:

---

---

---

---

---

What is your occupation? \_\_\_\_\_

Number of latest Newsletter associated with this publication: \_\_\_\_\_

Thank you for your cooperation. No postage stamp necessary if mailed in the U.S.A. (Elsewhere, an IBM office or representative will be happy to forward your comments or you may mail directly to the address in the Edition Notice on the back of the title page.)



**Reader's Comment Form**

Fold and tape

Please Do Not Staple

Fold and tape

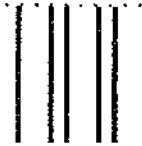

NO POSTAGE  
NECESSARY  
IF MAILED  
IN THE  
UNITED STATES

**BUSINESS REPLY MAIL**

FIRST CLASS PERMIT NO. 40 ARMONK, N.Y.

POSTAGE WILL BE PAID BY ADDRESSEE

International Business Machines Corporation  
Dept. E02  
P.O. Box 12195  
Research Triangle Park, N.C. 27709-9990

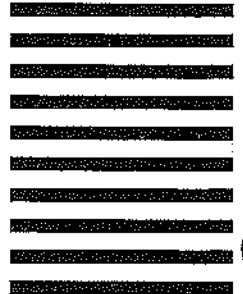

Fold and tape

Please Do Not Staple

Fold and tape





Part Number  
25F8885

SX27-3710-3

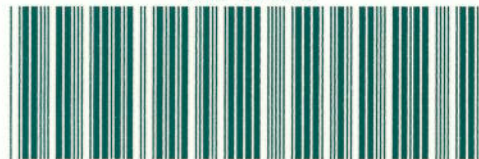

Printed in U.S.A.