 **HITACHI** HD63484 ACRTC
ADVANCED CRT CONTROLLER
USER'S MANUAL

#U75

**HD63484 ACRTC
ADVANCED CRT CONTROLLER
USER'S MANUAL**

#U75



November 1984

Printed in USA

When using this manual, the reader should keep the following in mind:

1. This manual may, wholly or partially, be subject to change without notice.
2. All rights reserved: No one is permitted to reproduce or duplicate, in any form, the whole or part of this manual without Hitachi's permission.
3. Hitachi will not be responsible for any damage to the user that may result from accidents or any other reasons during operation of his unit according to this manual.
4. This manual neither ensures the enforcement of any industrial properties or other rights, nor sanctions the enforcement right thereof.

TABLE OF CONTENTS

1. ACRTC INTRODUCTION	
1.1 Applications	3
1.2 System Configuration.....	5
1.3 Block Diagram.....	6
1.4 Signal Description.....	8
1.5 Address Space.....	10
1.6 Registers.....	12
1.7 Commands.....	15
1.8 Graphic Drawing.....	16
2. SYSTEM INTERFACE	
2.1 Basic Clock.....	17
2.2 CRT Interface.....	17
2.3 MPU Interface.....	28
3. DISPLAY FUNCTION	
3.1 Logical Display Screens.....	30
3.2 Cursor Control.....	37
3.3 Scrolling.....	40
3.4 Raster Scan Modes.....	43
3.5 Zooming.....	45
3.6 Light Pen.....	46
4. SIGNAL DESCRIPTION	
4.1 Pin Arrangement.....	47
4.2 Signal Functions.....	48
5. REGISTER DESCRIPTION	
5.1 Internal Register Access.....	57
5.2 Address Register.....	60
5.3 Status Register.....	61
5.4 FIFO Entry.....	64
5.5 Command Control Register.....	65
5.6 Operation Mode Register.....	69
5.7 Display Control Register.....	75
5.8 Timing Control RAM.....	79
5.9 Display Control RAM.....	96
5.10 Drawing Control Registers.....	113

6. COMMANDS

6.1 Command Overview 125
6.2 Command Format 125
6.3 Command Transfer Modes 126
6.4 Register Access Commands 127
6.5 Data Transfer Commands 128
6.6 Graphic Drawing Commands 135
6.7 Graphic Drawing Processor 162
6.8 Graphic Drawing Operation 166

FUNCTION OF COMMANDS 171

USE OF ARC AND ELLIPSE ARC COMMAND 301

ELECTRICAL SPECIFICATION 309

Abbreviations

Name	Description
AARC	Absolute Arc
ABT	Abort
ACM	Access Mode
ACP	Access Priority
ADR	Area Definition Register
AEARC	Absolute Ellipse Arc
AFRCT	Absolute Filled Rectangle
AGCPY	Absolute Graphic Copy
ALINE	Absolute Line
AMOVE	Absolute Move
APLG	Absolute Polygon
APLL	Absolute Poly Line
AR	Address Register
ARCT	Absolute Rectangle
ARD	Area Detect
ARE	Area Detect Interrupt Enable
AREA	Area Detect Mode
ATC	Attribute Code
ATR	Attribute Control
BCA	Block Cursor Address
BCA1	Block Cursor Address 1
BCA2	Block Cursor Address 2
BCER1	Block Cursor End Raster 1
BCER2	Block Cursor End Raster 2
BCR	Blink Control Register
BCSR1	Block Cursor Start Raster 1
BCSR2	Block Cursor Start Raster 2
BCUR1	Block Cursor Register 1
BCUR2	Block Cursor Register 2
BCW1	Block Cursor Width 1
BCW2	Block Cursor Width 2
BLINK1	Blink 1
BLINK2	Blink 2
BOFF1	Blink Off 1
BOFF2	Blink Off 2
BON1	Blink On 1
BON2	Blink On 2

Abbreviations

Name	Description
CCR	Command Control Register
CDM	Command DMA Mode
CDR	Cursor Definition Register
CED	Command End
CEE	Command End Interrupt Enable
CER	Command Error
CHR	Character
CLR	Clear
CL0	Color 0 Register
CL1	Color 1 Register
CM	Cursor Mode
CCMP	Color Comparison Register
COFF1	Cursor Off 1
COFF2	Cursor Off 2
CON1	Cursor On 1
CON2	Cursor On 2
CP	Current Pointer
CPY	Copy
CRCL	Circle
CRE	Command Error Interrupt Enable
CSK	Cursor Display Skew
CXE	Cursor X End
CXS	Cursor X Start
CYE	Cursor Y End
CYS	Cursor Y Start
DCR	Display Control Register
DDM	Data DMA Mode
DMOD	DMA Modify
DN	Display Number
DOT	Dot
DP	Drawing Pointer
DPAH	Drawing Pointer Address High
DPAL	Drawing Pointer Address Low
DPD	Drawing Pointer Dot
DRC	DMA Request Control
DRD	DMA Read
DSD	Destination Scan Direction

Abbreviations

Name	Description
DSK	DISP Skew
DSP	DISP Signal Control
DWT	DMA Write
EDG	Edge Color Register
ELPS	Ellipse
FE	FIFO Entry
FRA	First Raster Address
FRA0	First Raster Address 0
FRA1	First Raster Address 1
FRA2	First Raster Address 2
FRA3	First Raster Address 3
GAI	Graphic Address Increment Mode
GBM	Graphic Bit Mode
GCR	Graphic Cursor Register
HC	Horizontal Cycle
HDR	Horizontal Display Register
HDS	Horizontal Display Start
HDW	Horizontal Display Width
HSD	Horizontal Scroll Dot
HSR	Horizontal Sync Register
HSW	Horizontal Sync Width
HWR	Horizontal Window Display Register
HWS	Horizontal Window Start
HWW	Horizontal Window Width
HZ	Horizontal Zoom
HZF	Horizontal Zoom Factor
IE	Interrupt Enable
LPAH	Light Pen Address High
LPAL	Light Pen Address Low
LPAR	Light Pen Address Register
LPD	Light Pen Strobe Detect
LPE	Light Pen Strobe Interrupt Enable
LRA	Last Raster Address
LRA0	Last Raster Address 0
LRA1	Last Raster Address 1
LRA2	Last Raster Address 2
LRA3	Last Raster Address 3

Abbreviations

Name	Description
M/S	Master/Slave
MM	Modify Mode
MOD	Modify
MASK	Mask Register
MW	Memory Width
MW0	Memory Width 0
MW1	Memory Width 1
MW2	Memory Width 2
MW3	Memory Width 3
MWR	Memory Width Register
MWR0	Memory Width Register 0
MWR1	Memory Width Register 1
MWR2	Memory Width Register 2
MWR3	Memory Width Register 3
OMR	Operation Mode Register
OPM	Operation Mode
ORG	Origin
PAINT	Paint
PE	Pattern End
PEX	Pattern End X
PEY	Pattern End Y
PP	Pattern Pointer
PPX	Pattern Pointer X
PPY	Pattern Pointer Y
PRA	Pattern RAM Address
PRC	Pattern RAM Control Register
PS	Pattern Start
PSE	Pause
PSX	Pattern Start X
PSY	Pattern Start Y
PTN	Pattern
PZCX	Pattern Zoom Count X
PZCY	Pattern Zoom Count Y
PZX	Pattern Zoom X
PZY	Pattern Zoom Y
RAM	RAM Mode
RARC	Relative Arc

Abbreviations

Name	Description
RAR	Raster Address Register
RAR0	Raster Address Register 0
RAR1	Raster Address Register 1
RAR2	Raster Address Register 2
RAR3	Raster Address Register 3
RC	Raster Count
RCR	Raster Count Register
RD	Read
REARC	Relative Ellipse Arc
RFE	Read FIFO Full Interrupt Enable
RFF	Read FIFO Full
RFR	Read FIFO Ready
RFRCT	Relative Filled Rectangle
RGCPY	Relative Graphic Copy
RLINE	Relative Line
RMOVE	Relative Move
RN	Register Number
RPLG	Relative Polygon
RPLL	Relative Poly Line
RPR	Read Parameter Register
RPTN	Read Pattern RAM
RRCT	Relative Rectangle
RRE	Read FIFO Ready Interrupt Enable
RSM	Raster Scan Mode
RWP	Read/Write Pointer
RWPH	Read/Write Pointer High
RWPL	Read/Write Pointer Low
S	Source Scan Direction
SAH	Start Address High
SAL	Start Address Low
SAR	Start Address Register
SAR0	Start Address Register 0
SAR1	Start Address Register 1
SAR2	Start Address Register 2
SAR3	Start Address Register 3
SCLR	Selective Clear
SCPY	Selective Copy

Abbreviations

Name	Description
SD	Scan Direction
SDA	Start Dot Address
SE	Split Screen Enable
SE0	Split Screen 0 Enable
SE1	Split Screen 1 Enable
SE2	Split Screen 2 Enable
SE3	Split Screen 3 Enable
SL	Slant
SPL	Split
SP0	Split Screen 0 Width
SP1	Split Screen 1 Width
SP2	Split Screen 2 Width
SR	Status Register
SRA	Start Raster Address
SSW	Split Screen Width
STR	Start
VC	Vertical Cycle
VDR	Vertical Display Register
VDS	Vertical Display Start
VSR	Vertical Sync Register
VSW	Vertical Sync Width
VWR	Vertical Window Register
VWS	Vertical Window Start
VWW	Vertical Window Width
VZF	Vertical Zoom Factor
WEE	Write FIFO Empty Interrupt Enable
WFE	Write FIFO Empty
WFR	Write FIFO Ready
WPR	Write Parameter Register
WPTN	Write Pattern RAM
WRE	Write FIFO Ready Interrupt Enable
WSS	Window Smooth Scroll
WT	Write
XMAX	X Maximum
XMIN	X Minimum
YMAX	Y Maximum
YMIN	Y Minimum
ZFR	Zoom Factor Register

HD63484 ACRTC
(Advanced CRT Controller)

Powerful visual interfaces are a key component of advanced system architectures. A proven technique uses raster scanned CRT technology for the display of graphics and text information.

Systems which use first generation CRT Controllers (CRTC's) are constrained by hardware/software design time, manufacturing cost, and limited MPU bandwidth.

To meet the functional requirements for powerful visual interfaces, and to support their use in high volume, cost sensitive applications, advanced circuit design and VLSI CMOS manufacturing technologies have been used to create a next generation CRTC, the HD63484 ACRTC (Advanced CRT Controller).

The ACRTC concept is to incorporate major functionality, formerly requiring external hardware and software, on-chip. In this way, both higher performance and reduced system cost benefits are achieved.

- * High Level Command Language Increases Performance and Reduces Software Development Cost.
 - ACRTC Converts Logical X-Y Coordinates to Physical Frame Buffer Addresses.
 - 38 Commands including 23 Graphic Drawing Commands — LINE, RECTANGLE, POLYLINE, POLYGON, CIRCLE, ELLIPSE, ARC, ELLIPSE ARC, FILLED RECTANGLE, PAINT, PATTERN and COPY.
 - On-chip 32 Byte Pattern RAM.
 - Conditional Drawing function (8 conditions) for Drawing Patterns, Color Mixing and Software Windowing.
 - Drawing Area Control with Hardware Clipping and Hitting.
 - Maximum Drawing Speed of 2 Million Logical Pixels per Second is the same for Monochrome and Color applications.

- * High Resolution Display with Advanced Screen Control
 - Up to 4096 by 4096 Bit Map GRAPHIC Display and/or 256 Line by 256 Character by 32 Raster CHARACTER Display.
 - Separate Bit Map GRAPHIC (2M byte) and CHARACTER (128K byte) Address Spaces with Combined GRAPHIC/CHARACTER Display.
 - Three Horizontal Split Screens and One Window Screen. Size and Position Fully Programmable.
 - Independent Horizontal and Vertical Smooth Scroll for each Screen.
 - 1 to 16 Zoom Magnitude – Independent X and Y Zoom Factors.
 - Logical Pixel Specification as 1, 2, 4, 8 or 16 Bits for Monochrome, Gray Scale and Color Displays.
 - Programmable Address Increment Supports Frame Buffer Memory Widths to 128 Bits for Video Bit Rates > 500 MHz.
 - Unique Interleaved Access Mode for Screen Superimposition or ‘Flashless’ Displays.
 - ACRTC provides Dynamic RAM Refresh Address.
- * High Performance MPU Interface
 - Optimized Interface with the HD68000 MPU and HD68450 DMAC.
 - 8 or 16 Bit Bus – Compatible With Other MPUs.
 - Separate on-chip 16 Byte READ and WRITE FIFOs.
 - Maskable Interrupts Including FIFO status.
- * Versatile CRT Interface
 - Full Programmability of CRT Timing Signals.
 - Three Raster Scanning Modes.
 - Master or Slave Synchronization to Multiple ACRTCs or Other Video Generating Devices.
 - Two Hardware Cursors. Three Cursor Modes.
 - Programmable Cursor and Display Timing Skew.
 - Eight User Defineable Video Attributes.
 - Light Pen Detection.
- * VLSI CMOS Process

1. ACRTC INTRODUCTION

1.1 Applications

The overall function of a visual interface is logically partitioned into layers. At the lowest layer are CRT timing and control signal generation. At the top layer are general purpose drawing procedures which provide a high-level interface to the users OS or application software. At this layer, a number of popular standards have emerged including GKS, Core, NAPLP, GSX and others.

Figure 1.1 shows how the ACRTC performs the key functions or logical drawing algorithm and physical drawing execution. Formerly, these function were performed by external hardware and/or MPU software.

Drawing Procedures	MPU Soft- ware	MPU Soft- ware
Co-ordinates		
Conversion		
Drawing Pre-process		
Drawing Process (Algorithms)	CRTC	ACRTC
Drawing Execution		
Display Control		
Synchronizing		
Signals Generation		
Others		

Figure 1.1 ACRTC vs. CRTC

As shown, the ACRTC reduces the 'gap' between device functionality and high level graphics procedures. Since the ACRTC device itself provides capabilities closely related to those of high level graphics packages, the effort (hardware and software design time and cost) required to develop a visual interface is significantly reduced.

Noting the traditional and emerging applications for visual interfaces, figure 1.2 shows that a single ACRTC is suitable for a broad range of products in both alphanumeric and graphics areas.

Multiple ACRTCs can achieve performance beyond that of any first generation CRTC configuration.

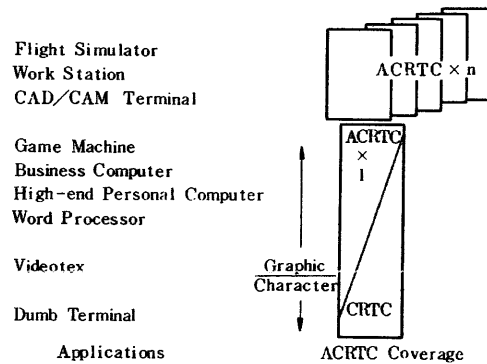


Figure 1.2 Application Spectrum

1.2 System Configuration

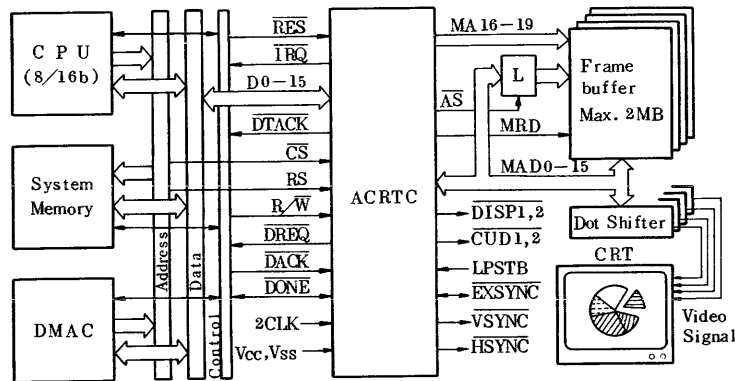


Figure 1.3 System Configuration

Existing CRTCs provide a single bus interface to the frame buffer which must be shared with the host MPU. However, the refresh of large frame buffers and the requirement to access the frame buffer for drawing operations can quickly saturate this shared bus bandwidth.

As shown, the ACRTC uses separate host MPU and frame buffer bus interfaces. This allows the ACRTC full access to the frame buffer for display refresh, DRAM refresh and drawing operations while minimizing the ACRTC's usage of the MPU system bus. Thus, overall system performance is maximized. A related benefit is that a large frame buffer (2M byte for each ACRTC) is useable even if the host MPU has a smaller address space or segment size restriction.

The ACRTC can utilize an external DMA Controller. This increases system throughput when large amounts of command, parameter and data information must be transferred to the ACRTC. Also, advanced DMAC features, such as the HD68450 DMACs 'chaining' modes, can be used to develop powerful graphics system architectures.

However, more cost sensitive or less performance sensitive applications do not require a DMAC. The interface to the ACRTC can be handled completely under MPU software control.

While both ACRTC bus interfaces (Host MPU and Frame Buffer) exploit 16 bit data paths for maximum performance, the ACRTC also offers an 8 bit MPU mode for easy connection to popular 8 bit bus structures.

1.3 Block Diagram

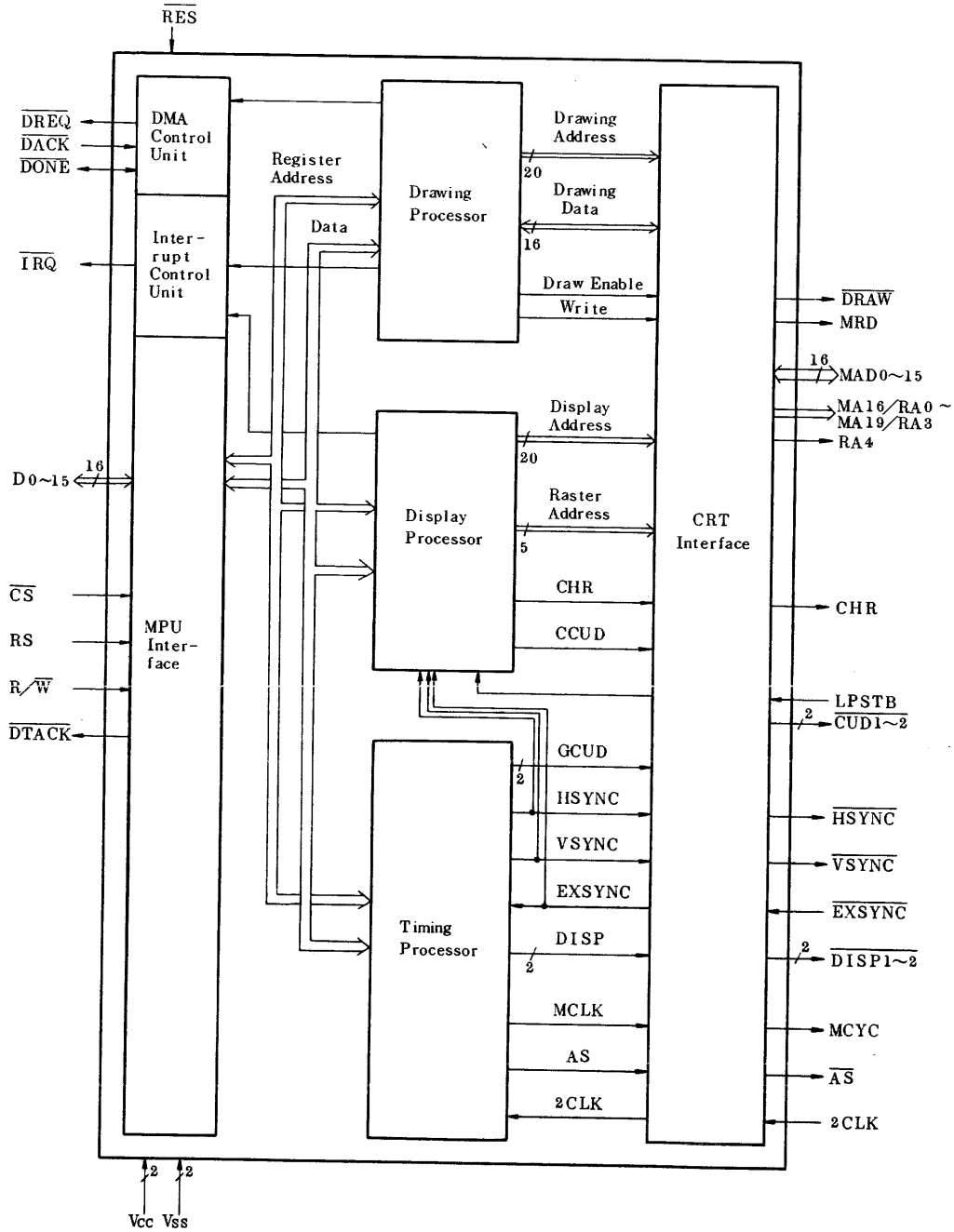


Figure 1.4 Block Diagram

The ACRTC consists of five major functional blocks. These functional blocks operate in parallel to achieve maximum performance. Two of the blocks perform the external bus interface for the host MPU and CRT respectively.

- MPU Interface
Manages the asynchronous host MPU interface including the programmable interrupt control unit and DMA handshaking control unit.
- CRT Interface
Manages the frame buffer bus and CRT timing input and output control signals. Also, the selection of either display refresh address or drawing address outputs is performed.
The other three blocks are separately microprogrammed processors which operate in parallel to perform the major functions of drawing, display control and timing.
- Drawing Processor
Interprets commands and command parameters issued by the host bus (MPU and/or DMAC) and performs the drawing operations on the frame buffer memory. This processor is responsible for the execution of ACRTC drawing algorithms and conversion of logical pixel X-Y addresses to physical frame buffer addresses.
Communication with the host bus is via separate 16 byte read and write FIFOs.
- Display Processor
Manages frame buffer refresh addressing based on the user programmed specification of display screen organization. Combines and displays as many as 4 independent screen segments (3 horizontal splits and 1 window) using an internal high speed address calculation unit. Controls display refresh address outputs based on GRAPHIC (physical frame buffer address) or CHARACTER (physical frame buffer address + row address) display modes.
- Timing Processor
Generates the CRT synchronization signals and other timing signals used internally by the ACRTC.
The ACRTC's software visible registers are similarly partitioned and reside in the appropriate internal processor depending on function. The registers in the Display and Timing processors are loaded with basic display parameters during system initialization. During operation, the host primarily communicates with the ACRTC's Drawing processor via the on-chip FIFOs.

1.4 Signal Description

Following is a brief description of the ACRTC pin functions organized as MPU Interface, DMAC Interface, CRT Interface and Power Supply. The detailed signal description is provided in section 4.

MPU Interface

$\overline{\text{RES}}$ – Input

Hardware reset input to the ACRTC.

D0 – D15 – Input/Output

The bidirectional data bus for communication with the host MPU or DMAC. In 8 bit data bus mode, DO-D7 are used.

$\text{R}/\overline{\text{W}}$ – Input

Controls the direction of host \longleftrightarrow ACRTC transfers.

$\overline{\text{CS}}$ – Input

Enables data transfers between the host and the ACRTC.

RS – Input

Selects the ACRTC register to be accessed and is normally connected to the least significant bit of the host address bus.

$\overline{\text{DTACK}}$ – Output

Provides asynchronous bus cycle timing and is compatible with the HD68000 MPU $\overline{\text{DTACK}}$ input.

$\overline{\text{IRQ}}$ – Output

Generates interrupt service requests to the host MPU.

DMAC Interface

$\overline{\text{DREQ}}$ – Output

Generates DMA service requests to the host DMAC.

$\overline{\text{DACK}}$ – Input

Receives DMA acknowledge timing from the host DMAC.

$\overline{\text{DONE}}$ – Input/Output

Terminates DMA transfer and is compatible with the HD68450 DMAC $\overline{\text{DONE}}$ signal.

CRT Interface

2CLK – Input

Basic ACRTC operating clock derived from the dot clock.

MAD0-15 – Input/Output

Multiplexed frame buffer address/data bus.

\overline{AS} – Output

Address strobe for demultiplexing the frame buffer address/data bus (MAD0-15).

MA16/RA0-MA19/RA3 – Output

The high order address bits for graphic screens and the raster address outputs for character screens.

RA4 – Output

Provides the high order raster address bit (up to 32 rasters) for character screens.

CHR – Output

Indicates whether a graphic or character screen is being accessed.

MCYC – Output

Frame buffer memory access timing – one half the frequency of 2CLK.

MRD – Output

Frame Buffer data bus direction control.

\overline{DRAW} – Output

Differentiates between drawing cycles and CRT display refresh cycles.

$\overline{DISP1}$, $\overline{DISP2}$ – Output

Programmable display enable timing used to selectively enable, disable and blank logical screens.

$\overline{CUD1}$, $\overline{CUD2}$ – Output

Provides cursor timing determined by ACRTC programmed parameters such as cursor definition, cursor mode, cursor address, etc.

$\overline{\text{VSYNC}}$ – Output

CRT device vertical synchronization pulse.

$\overline{\text{HSYNC}}$ – Output

CRT device horizontal synchronization pulse.

$\overline{\text{EXSYNC}}$ – Input/Output

For synchronization between multiple ACRTCs and other video signal generating devices.

LPSTB – Input

Connection to an external light pen.

1.5 Address Space

The ACRTC allows the host to issue commands using logical X-Y coordinate addressing. The ACRTC converts these to physical linear word addresses with bit field offsets in the frame buffer.

Figure 1.5 shows the relationship between a logical X-Y screen address and the frame buffer memory, organized as sequential 16 bit words. The host may specify that a logical pixel consists of 1, 2, 4, 8 or 16 physical bits in the frame buffer. In the example, 4 bits per logical pixel is used allowing 16 colors or tones to be selected.

Up to four logical screens (Upper, Base, Lower and Window) are mapped into the ACRTC physical address space. The host specifies a logical screen physical start address, logical screen physical memory width (number of memory words per raster), logical pixel physical memory width (number of bits per pixel) and the logical origin physical address. Then, logical pixel X-Y addresses issued by the host or by the ACRTC Drawing processor are converted to physical frame buffer addresses. The ACRTC also performs bit extraction and masking to map logical pixel operations (in the example, 4 bits) to 16 bit word frame buffer accesses.

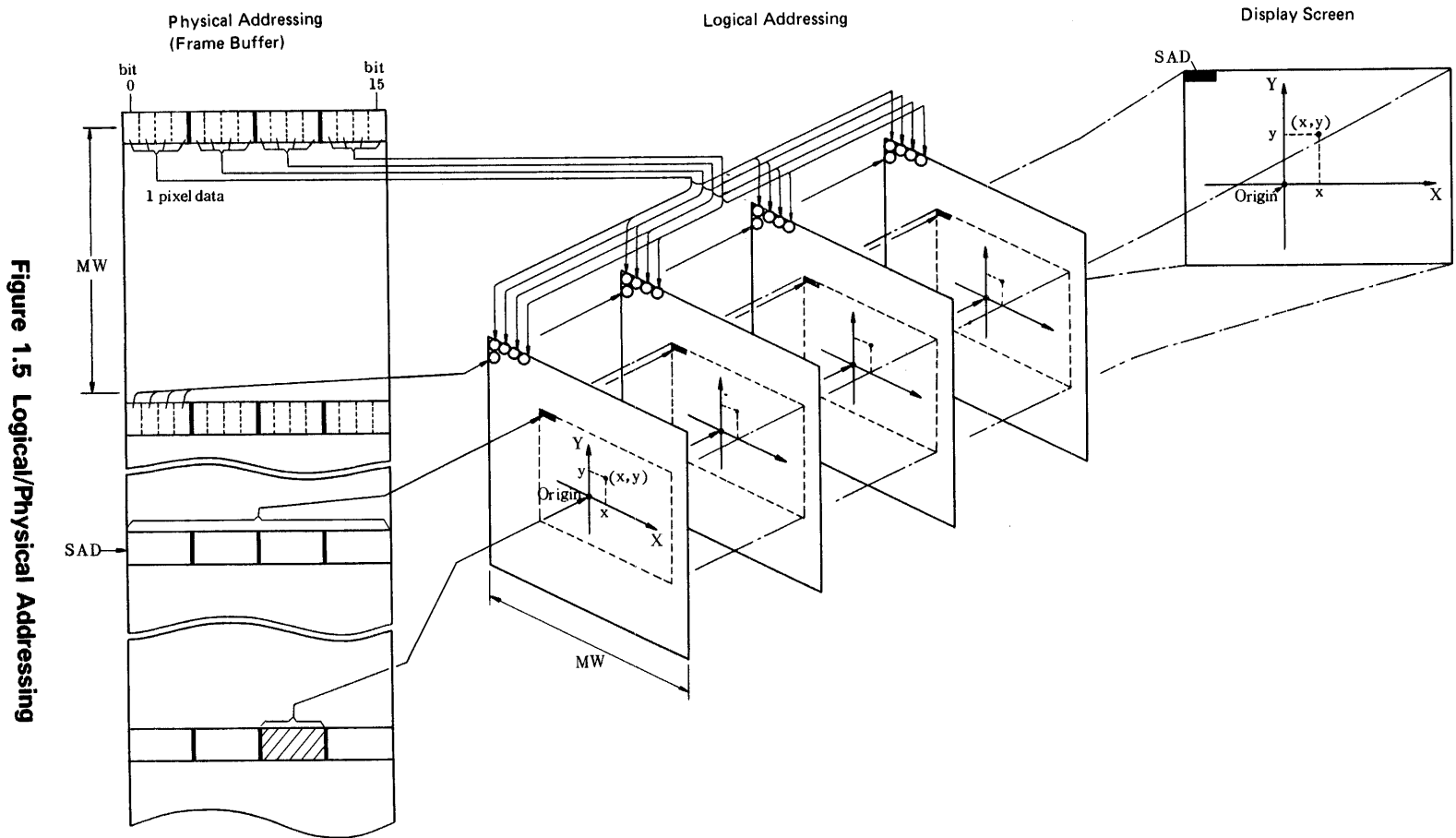


Figure 1.5 Logical/Physical Addressing

1.6 Registers

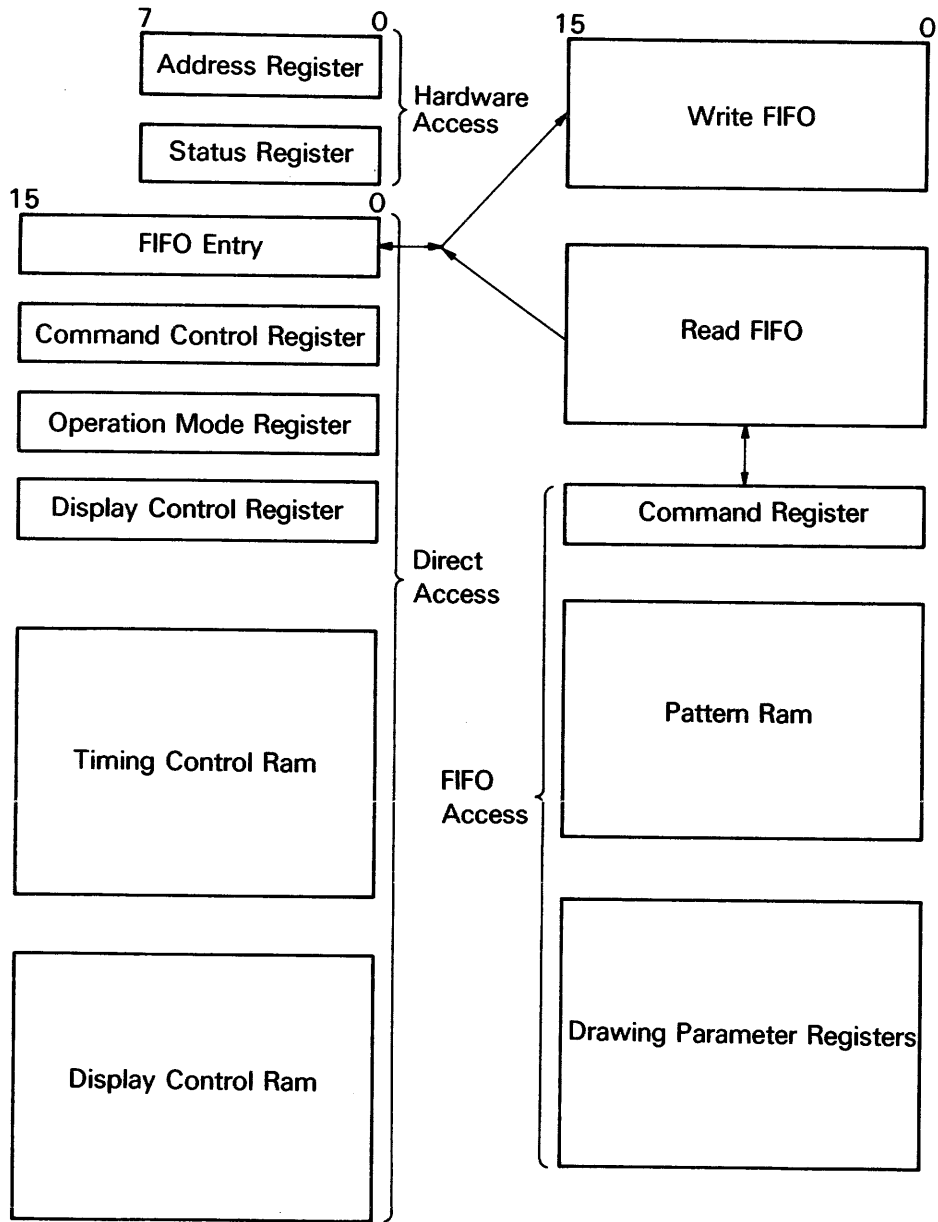


Figure 1.6 Accessible Registers

The ACRTC has over two hundred bytes of accessible registers. These are organized as Hardware, Directly and FIFO accessible.

○ Hardware Accessible

The ACRTC is connected to the host MPU as a standard peripheral which occupies two word locations of the host address space. The RS (Register Select) pin selects one of these two locations. When RS is low, reads access the Status Register and writes access the Address Register.

The Status Register summarizes the ACRTC state and is used by the MPU to monitor the overall operation of the ACRTC. The Address Register is used to program the ACRTC with the address of the specific directly accessible register which the MPU wishes to access.

○ Directly Accessible

These registers are accessed by prior loading of the Address Register with the chosen register address. Then, when the MPU accesses the ACRTC with RS=1, the chosen register is accessed.

The FIFO entry enables access to FIFO accessible registers using the ACRTC read and write FIFOs.

The Command Control Register is used to control overall ACRTC operation such as aborting or pausing commands, defining DMA protocols, enabling/disabling interrupt sources, etc.

The Operation Mode Register defines basic parameters of ACRTC operation such as frame buffer access mode, display or drawing priority, cursor and display timing skew factors, raster scan mode, etc.

The Display Control Register allows the independent enabling and disabling of each of the four ACRTC logical display screens (Base, Upper, Lower and Window). Also, this register contains the 8 bits of user defineable video attributes.

The Timing Control RAM contains registers which define ACRTC timing. This includes timing specification for CRT control signals (e.g. \overline{HSYNC} , \overline{VSYNC}), logical display screen size and display period, blink timing, etc.

The Display Control RAM contains registers which define logical screen display parameters such as start addresses, raster addresses and memory width. Also included are the cursor(s) definition, zoom factor and light pen registers.

○ FIFO Accessible

For high performance drawing, key Drawing Processor registers are coupled to the host via the ACRTCs separate 16 byte read and write FIFOs.

ACRTC commands are sent from the MPU via the write FIFO to the Command register. As the ACRTC completes command execution, the next command is automatically fetched from the FIFO into the Command register.

The Pattern RAM is used to define drawing and painting 'patterns'. The Pattern RAM is accessed using the ACRTCs Read Pattern RAM (RPTN) and Write Pattern RAM (WPTN) register access commands.

The Drawing Parameter Registers define detailed parameters of the drawing process, such as color control, area control (hitting/clipping) and Pattern RAM pointers. The Drawing Parameter Registers are accessed using the ACRTCs Read Parameter Register (RPR) and Write Parameter Register (WPR) register access commands.

1.7 Commands

Type	Mnemonic	Function
Register Access Commands	ORG RPR,WPR RPTN,WPTN	Set Origin Point Read/Write Parameter Registers Read/Write Pattern RAM
Data Transfer Commands	DRD,DWT,DMOD RD,WT,MOD CLR CPY,SCPY	DMA Read/Write/Modify Read/Write/Modify Clear Copy
Graphic Drawing Commands	AMOVE,RMOVE ALINE,RLINE ARCT,RRCT APLL,RPLL APLG,RPLG CRCL ELPS AARC,RARC AEARC,REARC AFRCT,RFRCT PAINT DOT PTN AGCPY,RGCPY	Move Line Rectangle Polyline Polygon Circle Ellipse Arc Ellipse Arc Filled Rectangle Paint Dot Pattern Graphic Copy

Figure 1.7 Commands

The ACRTC has 38 commands classified into three groups – REGISTER ACCESS, DATA TRANSFER and GRAPHIC DRAWING.

Five REGISTER ACCESS commands allow access to Drawing processor Drawing Parameter Registers and the Pattern RAM.

Ten DATA TRANSFER commands are used to move data between the host system memory and the frame buffer, or within the frame buffer.

Twenty three GRAPHIC DRAWING commands cause the ACRTC to perform drawing operations. Parameters for these commands are specified using logical X-Y addressing.

All the above commands, parameters and data are transferred via the ACRTC read and write FIFOs.

1.8 Graphic Drawing

Assuming the ACRTC has been properly initialized, the MPU must perform two steps to cause graphic drawing.

First, the MPU must specify certain drawing parameters which define a number of details associated with the drawing process. For example, to draw a figure or paint an area, the MPU must specify the drawing or painting 'pattern' by initializing the ACRTC Pattern RAM and related pointers. Also, if clipping and hitting control are desired, the MPU specifies the 'arera' to be monitored during drawing by initializing area definition registers. Other drawing parameters include color, edge definition, etc.

After the drawing parameters have been specified, the MPU issues a graphic drawing command and any required command parameters, such as the CRCL (Circle) command with a radius parameter. The ACRTC then performs the specified drawing operation by reading, modifying and rewriting the contents of the frame buffer.

2. SYSTEM INTERFACE

2.1 Basic Clock

The ACRTC basic clock is 2CLK. 2CLK controls all primary ACRTC display and logic timing parameters.

2CLK, along with the specification of number of bits per logical pixel, the Graphic Address Increment mode and the Display Access mode, also determines the video data rate.

2.2 CRT Interface

2.2.1 Frame Buffer Access

2.2.1.1 Access Modes

The three ACRTC display memory access modes are Single, Interleaved and Superimposed.

(a) Single Access Mode

A display (or drawing) cycle is defined as two cycles of 2CLK. During the first 2CLK cycle, the frame buffer display or drawing address is output. During the second 2CLK cycle, the frame buffer data is read (display cycles and/or drawing cycles) or written (drawing cycles).

In this mode, display and drawing cycles contend for access to the frame buffer. The ACRTC allows the priority to be defined as display priority or drawing priority. If display priority, drawing cycles are only allowed to occur during vertical retrace. So, a 'flashless' display is obtained at the expense of slower drawing. If drawing priority, drawing may occur during display so high speed drawing is obtained, however the display may flash.

(b) Interleaved Access Mode (Dual Access Mode 0)

In this mode, display cycles and drawing cycles are interleaved. A display/drawing cycle is defined as four cycles of 2CLK. During the first 2CLK cycle, the frame buffer display address is output. During the second 2CLK cycle, the display data is read from the frame buffer. During the third 2CLK cycle, the frame buffer drawing address is output. During the fourth 2CLK cycle, the drawing data is read or written.

Since there is no contention between display and drawing cycles, a 'flashless' display is obtained while maintaining full drawing speed. However, for a given configuration, frame buffer memory access time must be twice as fast as an equivalent Single Access Mode configuration.

(c) Superimposed Access Mode (Dual Access Mode 1)

In this mode, two separate logical screens are accessed during each display cycle. The display cycle is defined as four 2CLK cycles. During the first 2CLK cycle, the Background (Upper, Base or Lower) screen frame buffer address is output. During the second 2CLK cycle, the Background screen display or drawing data is read (display or drawing) or written (drawing). During the third 2CLK cycle, the window screen frame buffer address is output. During the fourth 2CLK cycle, the window screen display or drawing data is read (display or drawing) or written (drawing). Note that the third and fourth cycles can be used for Background screen drawing (similar to Interleaved mode) when these cycles are not used for Window display.

SA (SINGLE ACCESS MODE)

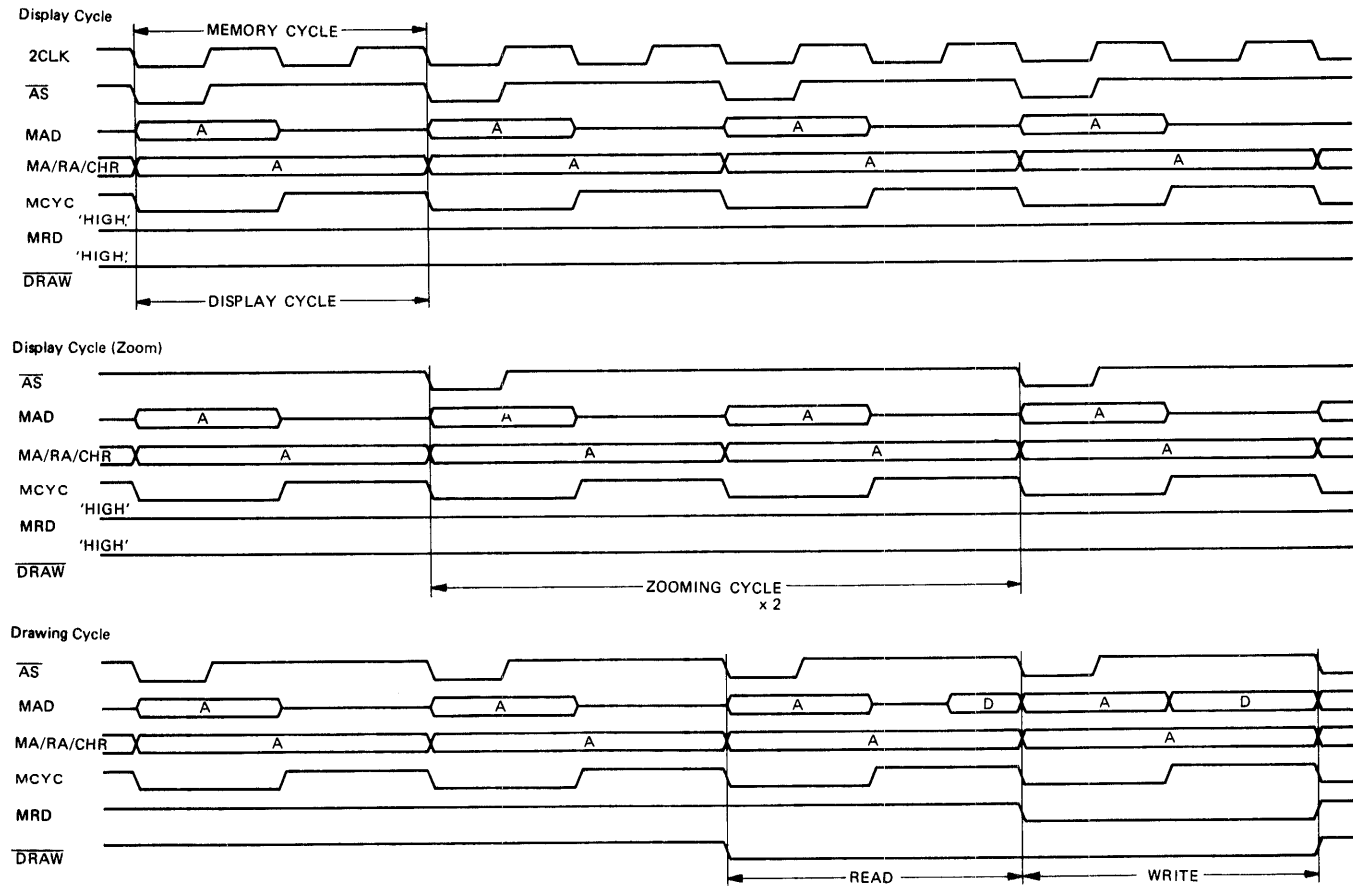


Figure 2.1(a) Access Mode Timing

INTERLEAVED ACCESS MODE

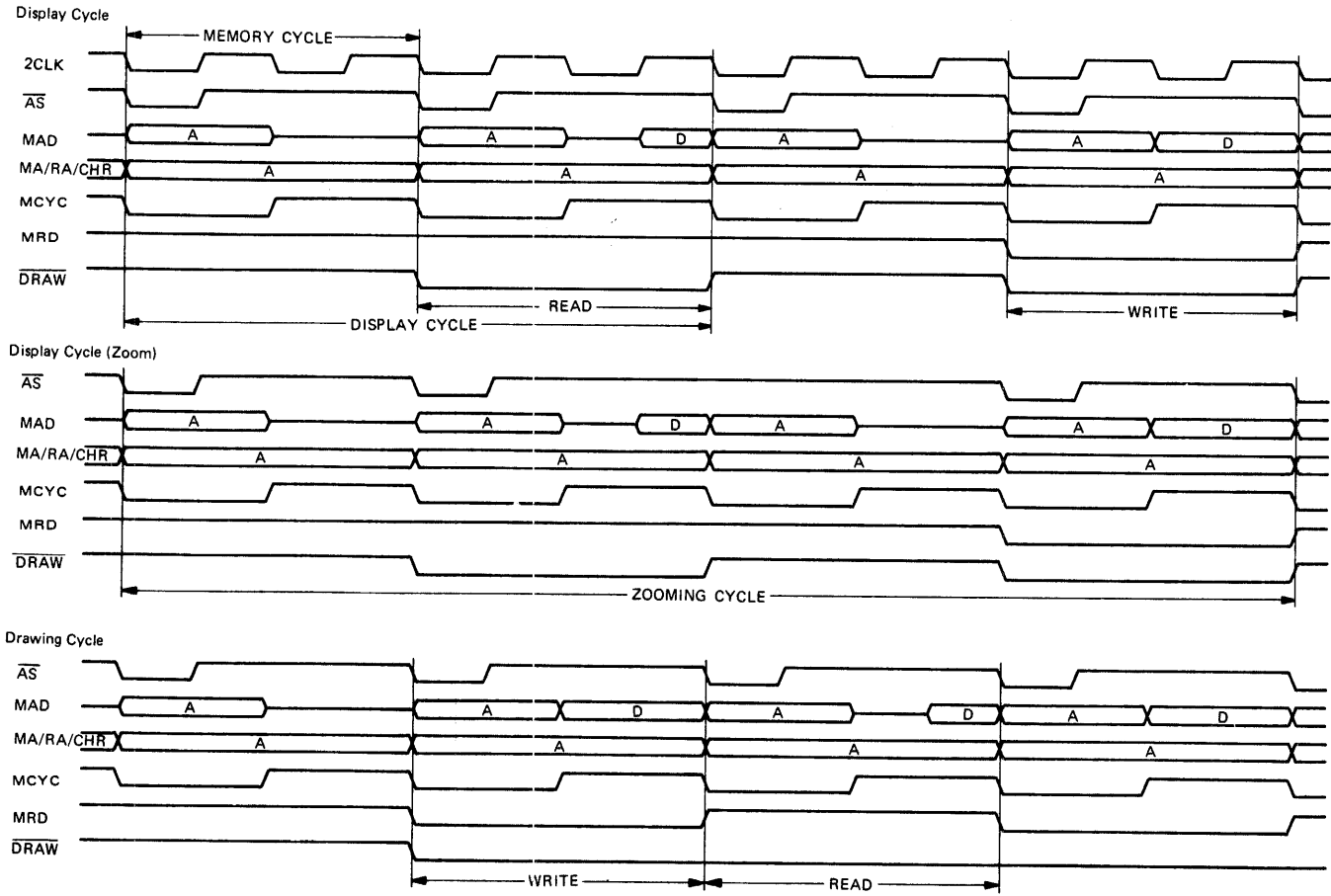
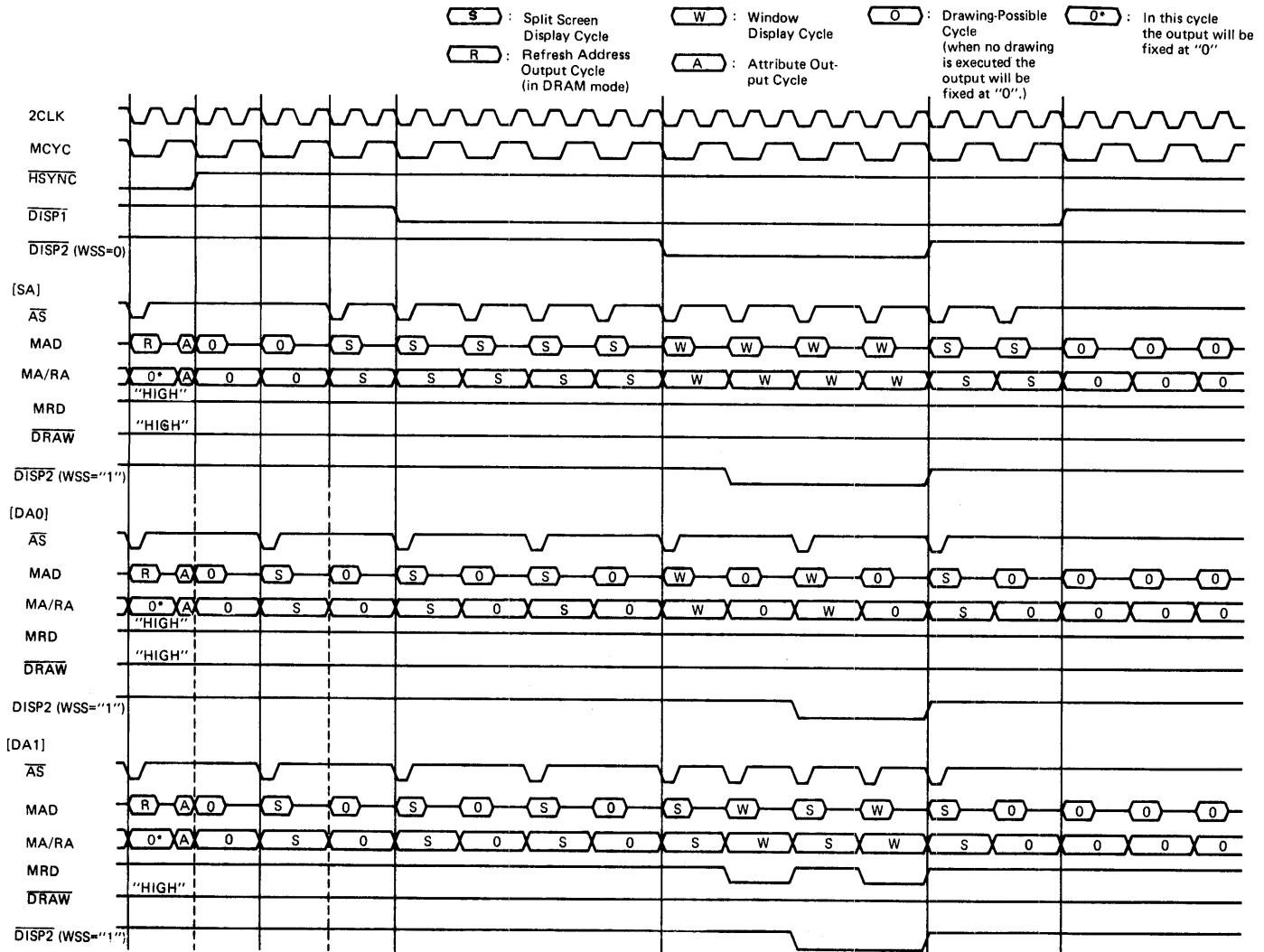


Figure 2.1(b) Access Mode Timing

Figure 2.1 (d) Access Mode Timing



SUPERIMPOSED ACCESS MODE

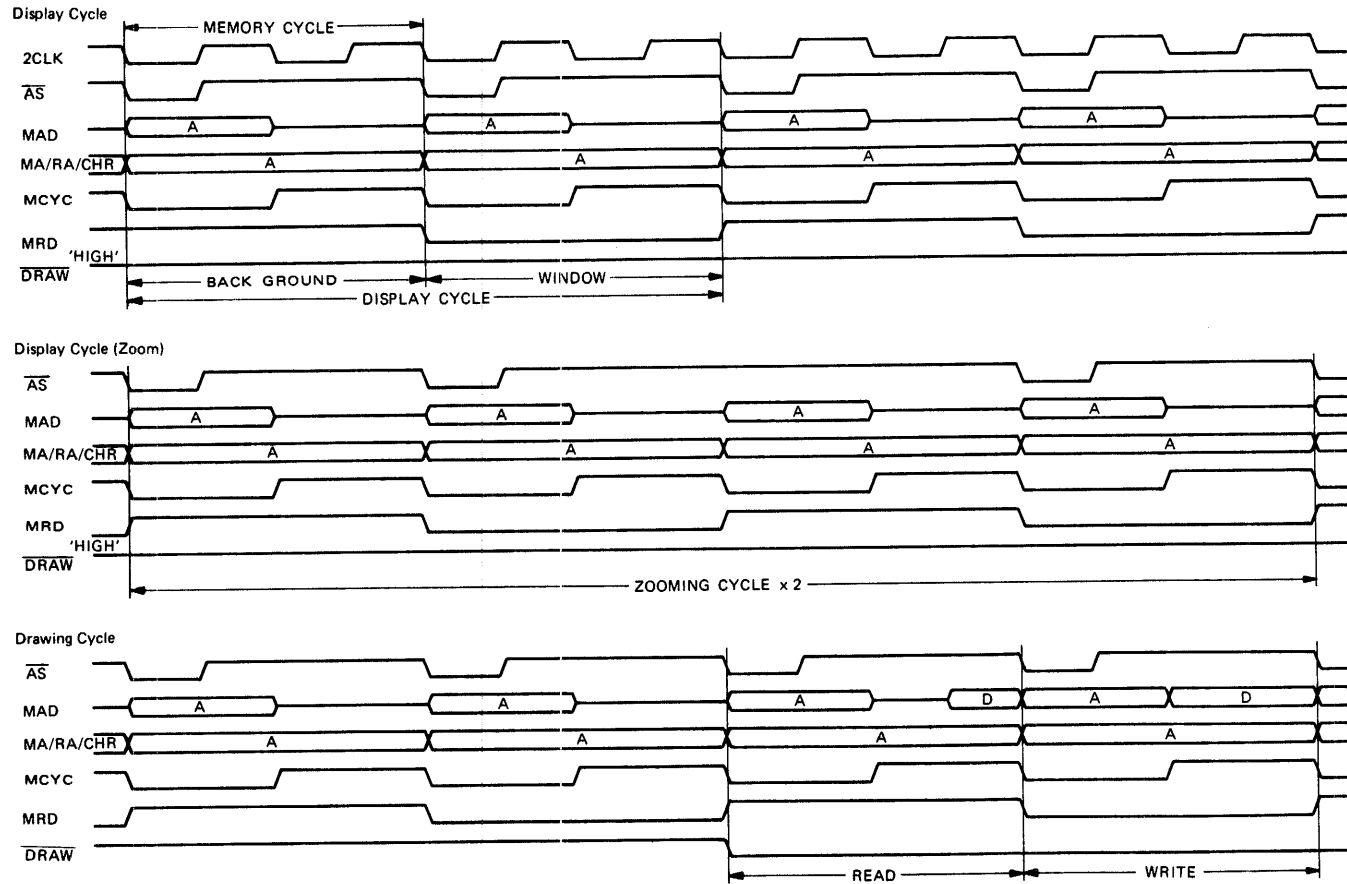


Figure 2.1(c) Access Mode Timing

2.2.1.2 Graphic Address Increment Mode

During display operation, the ACRTC can be programmed to control the graphic display address in six ways including increment by 1, 2, 4 and 8 words, 1 word every two display cycles and no increment.

Setting GAI to increment by 2, 4 or 8 words per display cycle achieves linear increases in the video data rate i.e. for a given configuration setting GAI to 2, 4 or 8 words will achieve 2, 4 or 8 times the video data rate corresponding to GAI=1. This allows increasing the number of bits/logical pixel and logical pixel resolution while meeting the 2CLK maximum frequency constraint.

Figure 2.2 shows the summary relationship between 2CLK, Display Access Mode, Graphic Address Increment, # bits/logical pixel, memory access time and video data rate. The frame buffer cycle frequency (F_c) is shown by the following equation where:

- F_v = Dot Clock
- N = # bits/logical pixel
- D = Display Access Mode
1 for Single Access Mode
2 for interleaved and Superimposed Access Modes
- A = Graphic Address Increment (1/2, 1, 2, 4, 8)
- F_c = $(F_v \times N \times D)/(A \times 16)$

Dot Rate		16MHz		32MHz		64MHz		128MHz	
Color No. (bit/pixel)	Access Mode	S	D	S	D	S	D	S	D
	Memory Cycle								
1	250ns	—	+1/2	+1/2	+1	+1	+2	+2	+4
	500ns	+1/2	+1	+1	+2	+2	+4	+4	+8
2	250ns	+1/2	+1	+1	+2	+2	+4	+4	+8
	500ns	+1	+2	+2	+4	+4	+8	+8	—
4	250ns	+1	+2	+2	+4	+4	+8	+8	—
	500ns	+2	+4	+4	+8	+8	—	—	—
8	250ns	+2	+4	+4	+8	+8	—	—	—
	500ns	+4	+8	+8	—	—	—	—	—
16	250ns	+4	+8	+8	—	—	—	—	—
	500ns	+8	—	—	—	—	—	—	—

Figure 2.2 Graphic Address Increment Modes

2.2.2 Dynamic RAM Refresh

When dynamic RAMs (DRAMs) are used for the frame buffer memory, the ACRTC can automatically provide DRAM refresh addressing.

The ACRTC maintains an 8 bit DRAM refresh counter which is decremented on each frame buffer access. During $\overline{\text{HSYNC}}$ low, the ACRTC will output the sequential refresh addresses on MAD. The refresh address assignment depends on Graphic Address Increment (GAI) mode as shown in figure 2.3(a).

Address Increment Mode	Refresh Address Output Terminal
+ 1 (GAI=000)	MAD0-7
+ 2 (GAI=001)	MAD1-8
+ 4 (GAI=010)	MAD2-9
+ 8 (GAI=011)	MAD3-10
+ 1/2 (GAI=111)	MAD0-7

Figure 2.3(a) GAI and DRAM Refresh Addressing

The ACRTC provides "0" output on the remaining address line of MAD and MA/RA.

DRAM refresh cycle timing must be factored into the determination of $\overline{\text{HSYNC}}$ low pulse width (HSW – specified in units of frame buffer memory cycles).

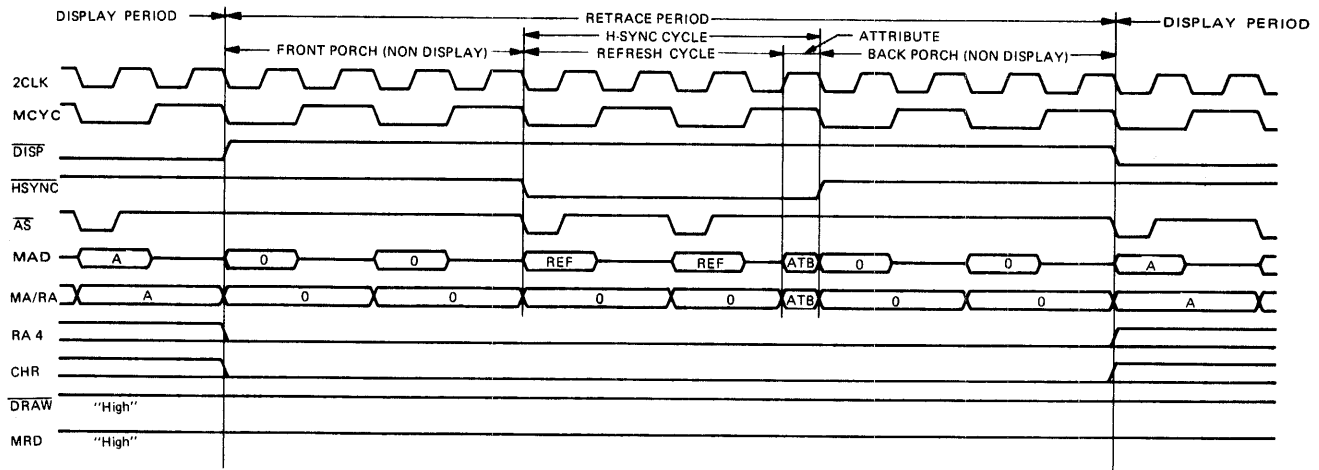
If the horizontal scan rate is Fh (kHz), number of DRAM refresh cycles is N and the DRAM refresh cycle time is Tr (msec) then horizontal sync width (HSW) is specified by the following equation:

$$\text{HSW} \geq N / (\text{Tr} \times \text{Fh})$$

For example, if the scan rate is 15.75 kHz and the DRAMS have 128 refresh cycles of 2 msec, HSW must be greater than or equal to 5.

$$\text{HSW} \geq 128 / (2 \times 15.75) = 4.06$$

Figure 2.3(b) DRAM Refresh Timing



2.2.3 External Synchronization

The ACRTC $\overline{\text{EXSYNC}}$ pin allows synchronization of multiple ACRTCs or other video signal generators. The ACRTC may be programmed as a single Master device, or as one of a number of Slave devices.

To synchronize multiple ACRTCs, simply connect all the $\overline{\text{EXSYNC}}$ pins together.

For synchronizing to other video signals, the connection scheme depends on the raster scan mode. In Non-Interlace mode, $\overline{\text{EXSYNC}}$ corresponds to $\overline{\text{VSYNC}}$. In Interlace modes, $\overline{\text{EXSYNC}}$ corresponds to $\overline{\text{VSYNC}}$ of the odd field.

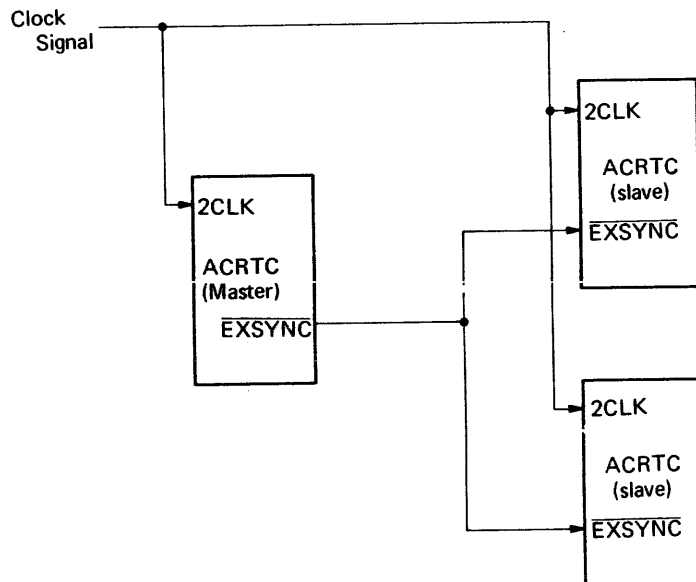


Figure 2.4(a) External Synchronization

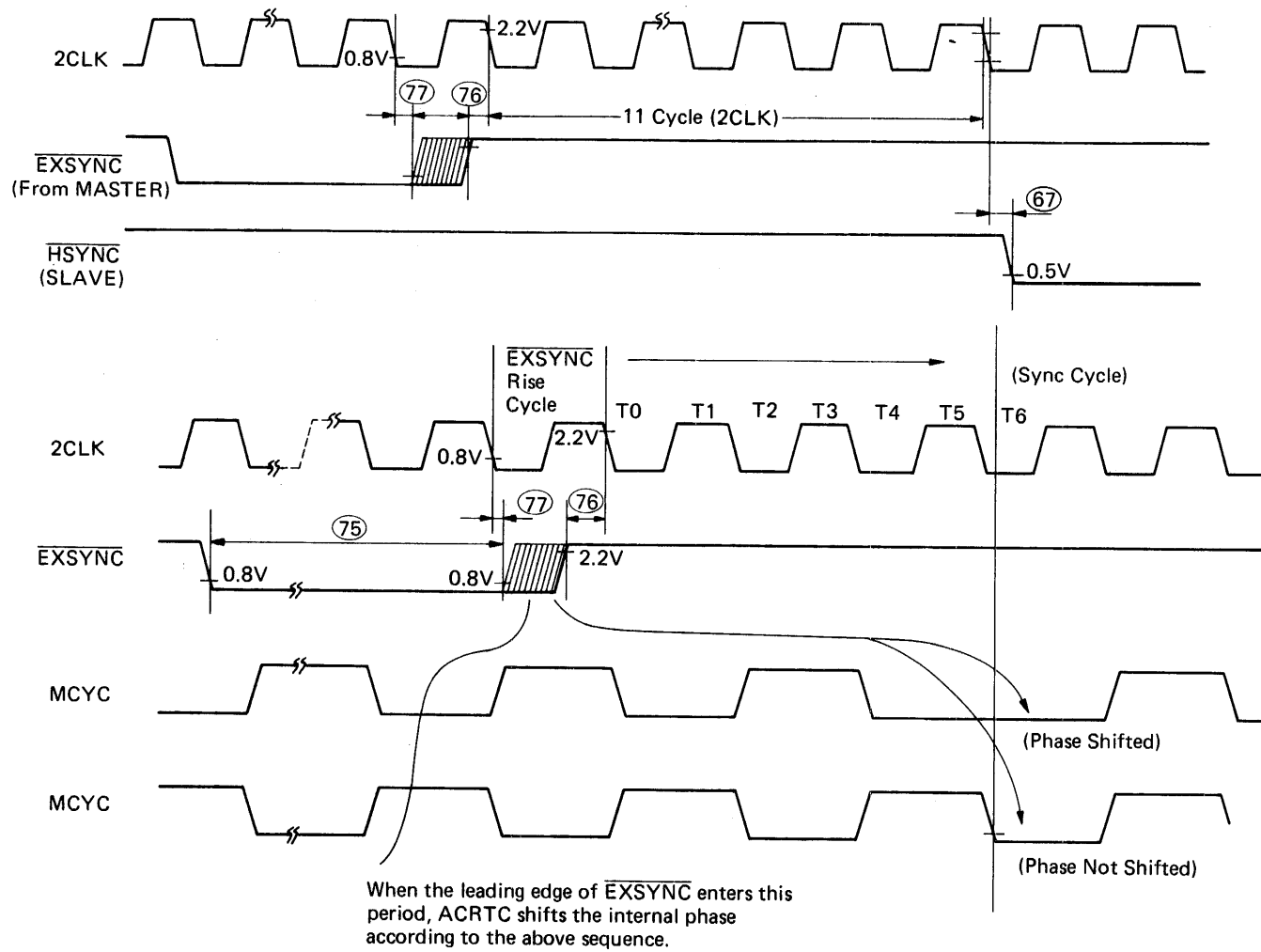


Figure 2.4(b) EXSYNC Timing

2.3 MPU Interface

2.3.1 MPU Bus Cycle

The ACRTC interfaces to the MPU as a peripheral occupying two addresses in the MPU address space. The ACRTC can operate as an 8 or 16 bit peripheral as configured during $\overline{\text{RES}}$.

An MPU bus cycle is initiated when $\overline{\text{CS}}$ is asserted (following the assertion of $\overline{\text{RS}}$ and $\overline{\text{R/W}}$). The ACRTC responds to $\overline{\text{CS}}$ low by asserting $\overline{\text{DTACK}}$ low to complete the data transfer. $\overline{\text{DTACK}}$ will be returned to the MPU in between 1 and 1.5 2CLK cycles.

MPU WAIT states will be added in the following two cases.

- (a) If the ACRTC 2CLK input is much slower than the MPU clock, continuous ACRTC accesses may be delayed due to internal processing of the previous bus cycle.
- (b) If an ACRTC read cycle immediately follows an ACRTC write cycle, a WAIT state may occur due to ACRTC preparation for bus 'turn-around'. However, MPUs normally have no instructions which immediately follow a write cycle with a read cycle.

For connection to synchronous bus interface MPUs, $\overline{\text{DTACK}}$ can simply be left open assuming the system design guarantees that WAIT states cannot occur as described above. If WAIT states may occur, $\overline{\text{DTACK}}$ can be used with external logic to synthesize a READY signal.

2.3.2 DMA Transfer

The ACRTC can interface with an external DMA controller using three handshake signals, DMA Request ($\overline{\text{DREQ}}$), DMA Acknowledge ($\overline{\text{DACK}}$) and DMA Done ($\overline{\text{DONE}}$).

The ACRTC uses the external DMAC for two types of transfers, Command/Parameter DMA and Data DMA. For both types, DMA transfers use the ACRTC read and write FIFOs.

2.3.2.1 Command/Parameter DMA

The MPU initiates this mode by setting bit 12 (CDM) in the ACRTC Command Control Register to 1. Then, the ACRTC will automatically request DMA transfer for commands and their associated parameters as long the write FIFO has space. Only cycle steal request mode ($\overline{\text{DREQ}}$ pulses low for each data transfer) can be used. Command/Parameter DMA is terminated when the MPU resets bit 12 in CCR to 0 or the external $\overline{\text{DONE}}$ input is asserted.

2.3.2.2 Data DMA

Data DMA is used to move data between the MPU system memory and the ACRTC frame buffer.

The MPU sets-up the transfer by specifying the frame buffer transfer address (and other parameters of the transfer, such as 'on-the fly' logical operations) to the ACRTC. Next, when the MPU issues a Data Transfer Command to the ACRTC, the ACRTC will request DMA transfer to and from system memory. The ACRTC will request DMA, automatically monitoring FIFO status, until the DMA Transfer Command is completed.

Data DMA request mode can be cycle steal (as in Command/Parameter DMA) or burst mode in which \overline{DREQ} is a low level control output to the DMAC which allows multiple data transfers during each acquisition of the MPU bus.

2.3.3 Interrupts

The ACRTC recognizes eight separate conditions which can generate an interrupt including command error detection, command end, drawing edge detection, light pen strobe and four FIFO status conditions. Each condition has an associated mask bit for enabling/disabling the associated interrupt. The ACRTC removes the interrupt request when the MPU performs appropriate interrupt service by reading or writing to the ACRTC.

3. DISPLAY FUNCTION

3.1 Logical Display Screens

The ACRTC allows division of the frame buffer into four separate logical screens.

Screen Number	Screen Name	Screen Group Name
0	Upper Screen	} Background Screens
1	Base Screen	
2	Lower Screen	
3	Window Screen	

In the simplest case, only the Base screen parameters must be defined. Other screens may be selectively enabled, disabled and blanked under software control.

The Background (Upper, Base and Lower) screens partition the display into three horizontal splits whose position is fully programmable. A typical application might use the Base screen for the bulk of user interaction, using the Lower screen for a 'status line(s)' and the Upper screen for 'pull-down menu(s)'.

The Window screen is unique, since the ACRTC gives the Window screen higher priority than Background screens. Thus, when the Window, whose size and position is fully programmable, overlaps a Background screen, the Window screen is displayed. One exception is the ACRTC Superimposed Access Mode, in which the Window has the same display priority as Background screens. In this case, the Window and Background screen are 'superimposed' on the display.

The ACRTC logical screen organization can be programmed to best suit a number of display applications.

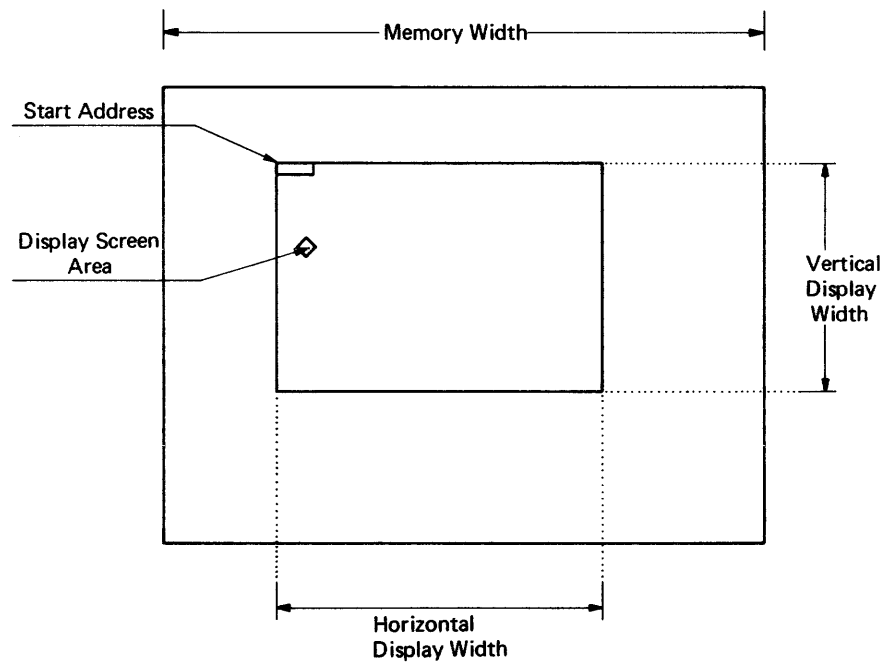


Figure 3.1 Display Screen/Frame Buffer Relationship

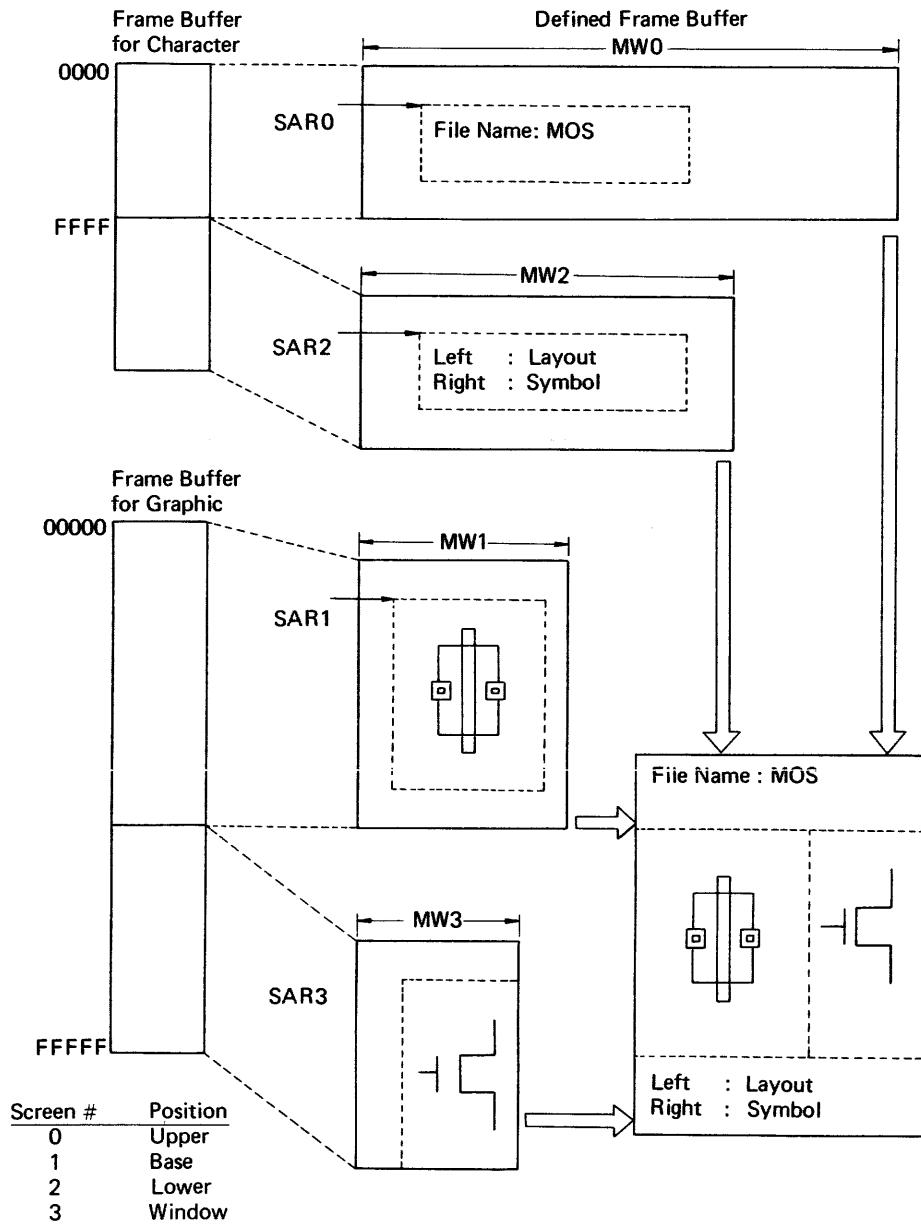


Figure 3.2 Display Screen Combination

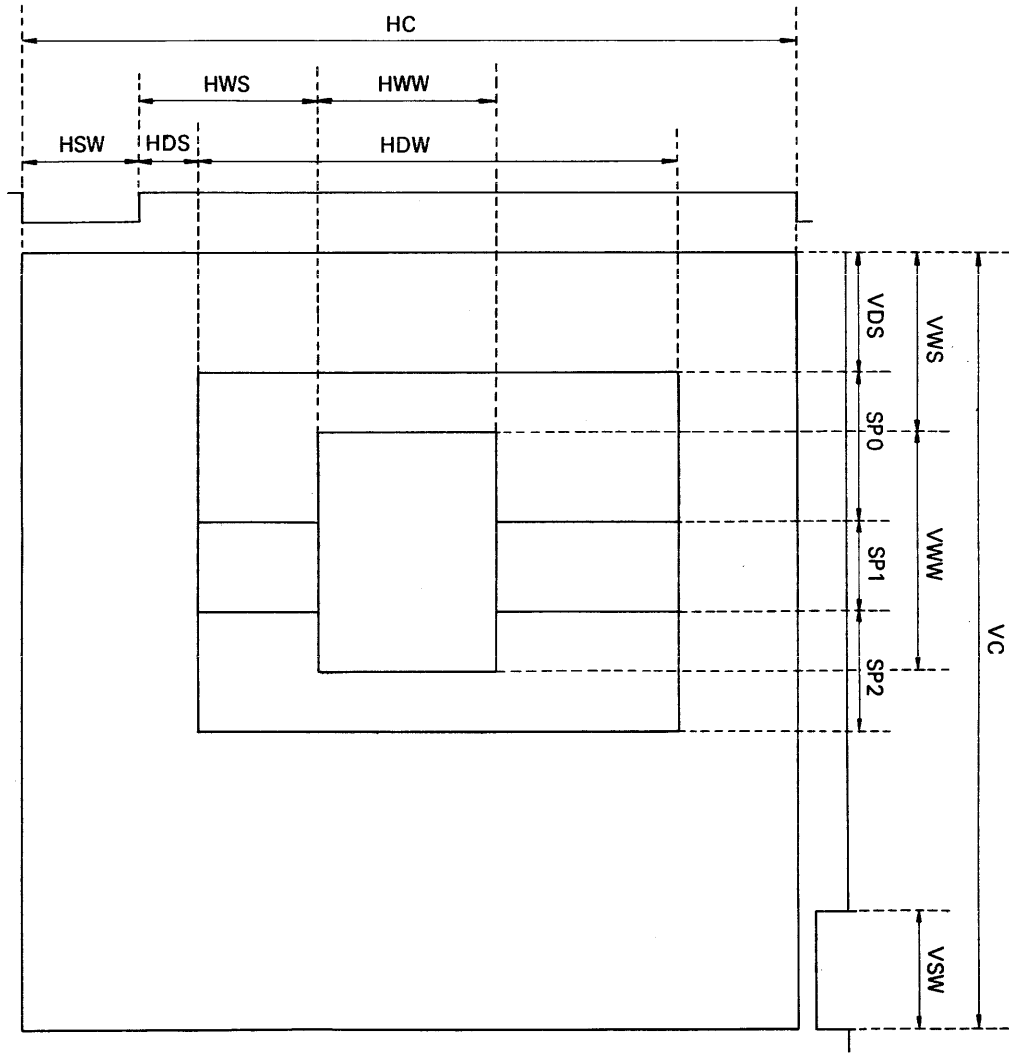
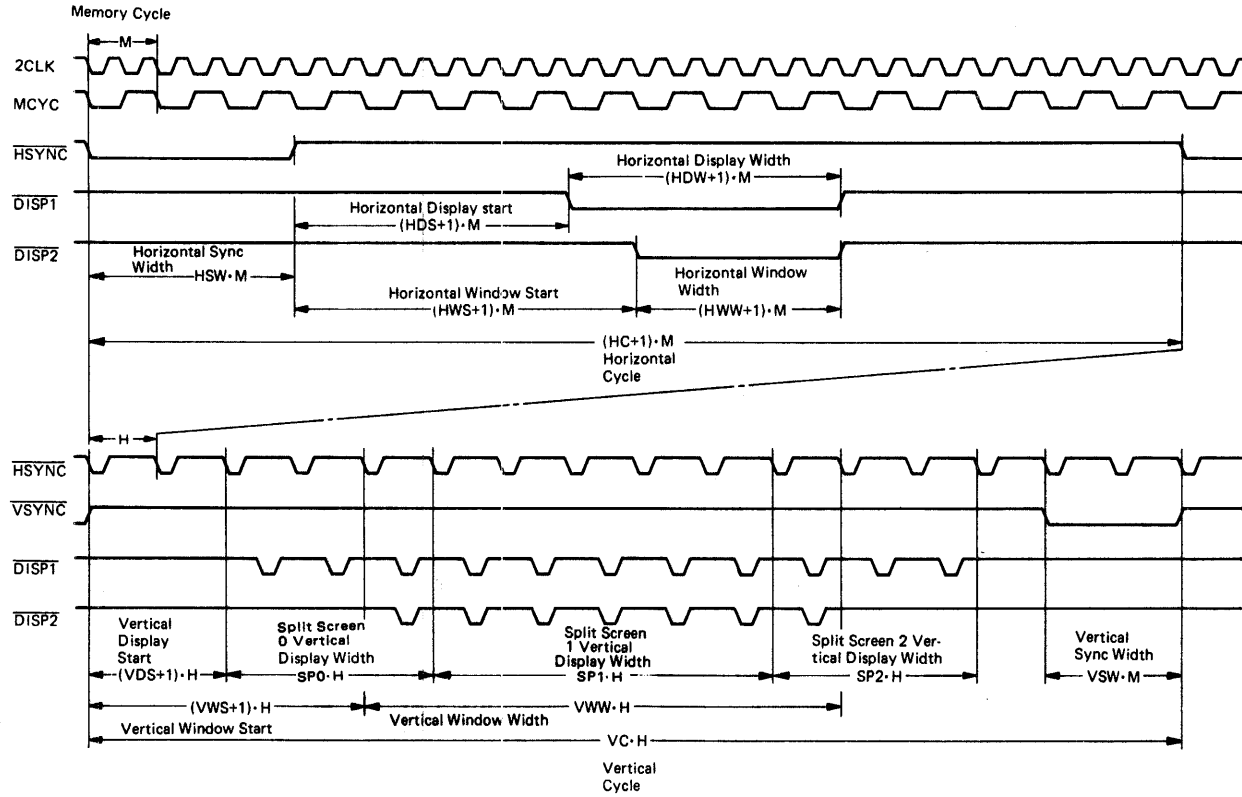


Figure 3.3 Display Screen Specification

Figure 3.4 Display Screen Timing



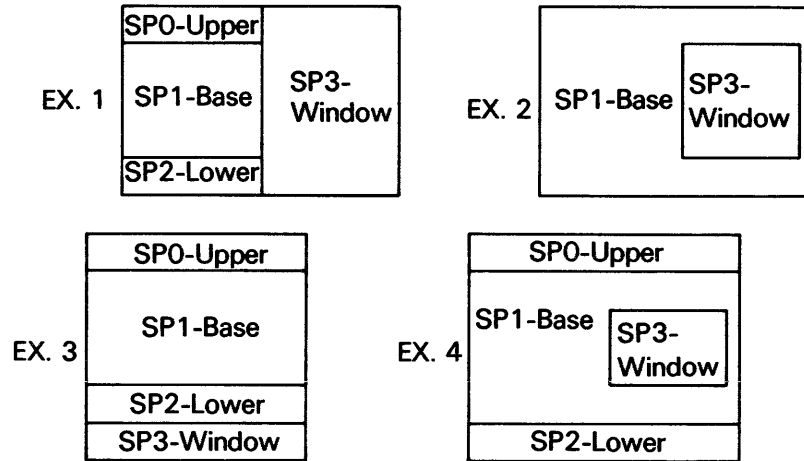


Figure 3.5 Example Screen Combinations

3.1.1 Graphic/Character Address Spaces

The ACRTC controls two separate logical address spaces. The CHR pin allows external decoding if physically separate frame buffers are desired.

Each of the four logical screens (Upper, Base, Lower and Window) is programmed as residing in the Graphics address space or the Character address space.

ACRTC accesses to Graphics screens are treated as bit mapped using a 20 bit frame buffer address, with an address space of one megaword (1M by 16 bit).

ACRTC accesses to Character screens are treated as character generator mapped. In this case, a 64K word address space is used and 5 bits of raster address are output to an external character generator.

Multiple logical screens defined as Character can be externally decoded to use separate character generators or different addresses within a combined character generator. Also, each Character screen may be defined with separate line spacing, separate cursors, etc.

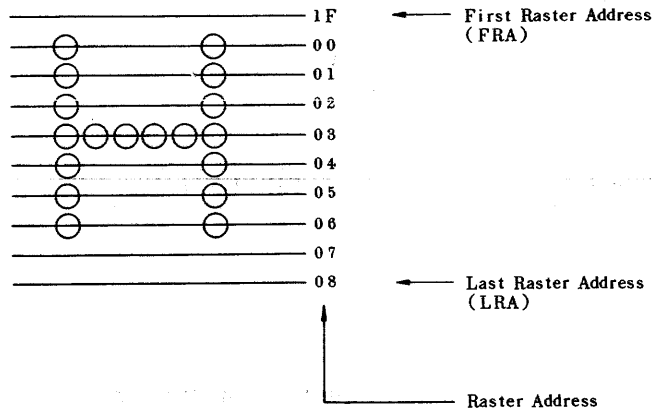


Figure 3.6 Character Screen Raster Addressing

3.2 Cursor Control

The ACRTC has two Block Cursor Registers and a Graphics Cursor Register.

A Block cursor is used with Character screens. The cursor start and ending raster addresses are fully programmable. Also, the cursor width can be defined as one to eight memory cycles.

A Graphics cursor is defined by specifying the start and end addresses in both the X and Y dimensions.

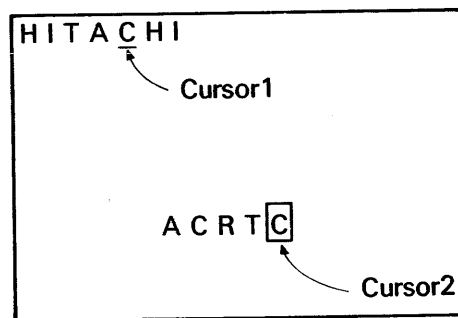


Figure 3.7(a) Two Separate Block Cursors

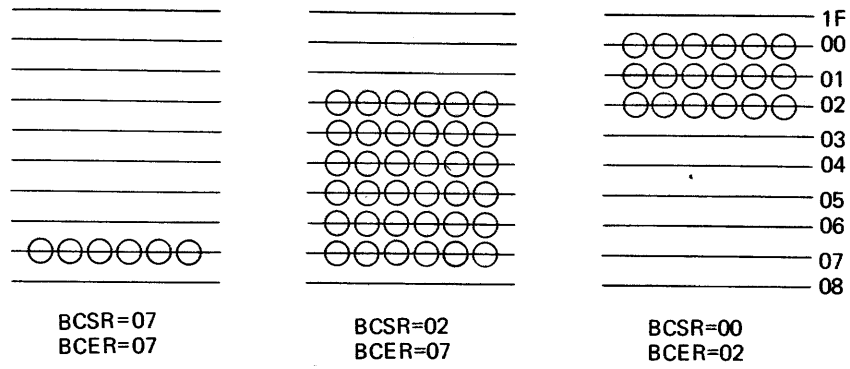


Figure 3.7(b) Block Cursor Examples

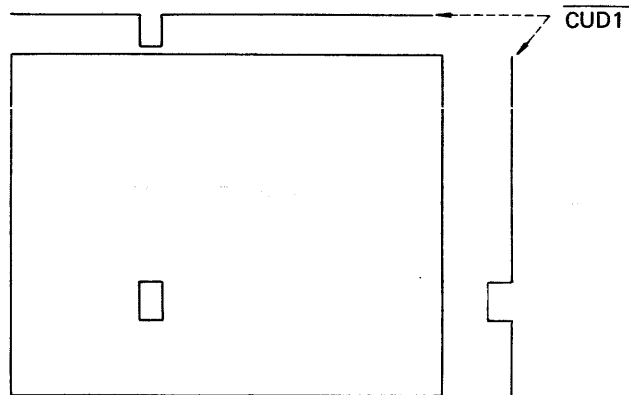


Figure 3.8 Graphic Cursor

The ACRTC provides two separate cursor outputs, $\overline{\text{CUD1}}$ and $\overline{\text{CUD2}}$. These are combined with two character cursor registers and a graphics cursor register to provide three cursor modes.

3.2.1 Block Mode

Two Block cursors are output on $\overline{\text{CUD1}}$ and $\overline{\text{CUD2}}$ respectively.

3.2.2 Graphic Mode

The Graphic cursor is output on $\overline{\text{CUD1}}$. Using an external cursor pattern memory allows a graphic cursor of various shapes. Two Block cursors are multiplexed on $\overline{\text{CUD2}}$.

3.2.3 Crosshair Mode

The horizontal and vertical components of the Graphic cursor are output on $\overline{\text{CUD1}}$ and $\overline{\text{CUD2}}$ respectively. This allows simple generation of a crosshair cursor control signal.

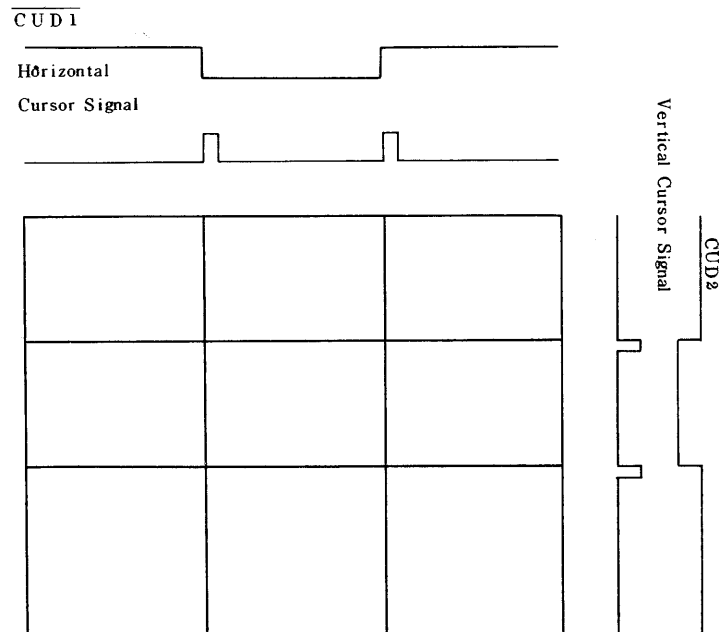


Figure 3.9 Crosshair Cursor

3.3 Scrolling

3.3.1 Vertical Scroll

Each logical screen performs independent vertical scroll. On Character Screens, vertical smooth scroll is accomplished using the programmable Start Raster Address (SRA). Line by line scroll is accomplished by increasing or decreasing the screen start address by one unit of horizontal memory width.

On Graphics screens, vertical smooth scroll is accomplished by increasing or decreasing the screen start address by one unit of horizontal memory width.

3.3.2 Horizontal Scroll

Horizontal scroll can be performed in units of characters for Character screens and units of words (multi logical pixels) for Graphic screens by increasing or decreasing the screen start address by 1.

For smooth horizontal scroll, the ACRTC has dot shift video attributes which can be used with an external circuit which conditions shift register load/clocking.

Since this dot shift information is output each raster, horizontal smooth scroll is limited to either the Background screens or the Window screen at any given time. However, horizontal smooth scroll is independent for each of the Background screens (Upper, Base, Lower).

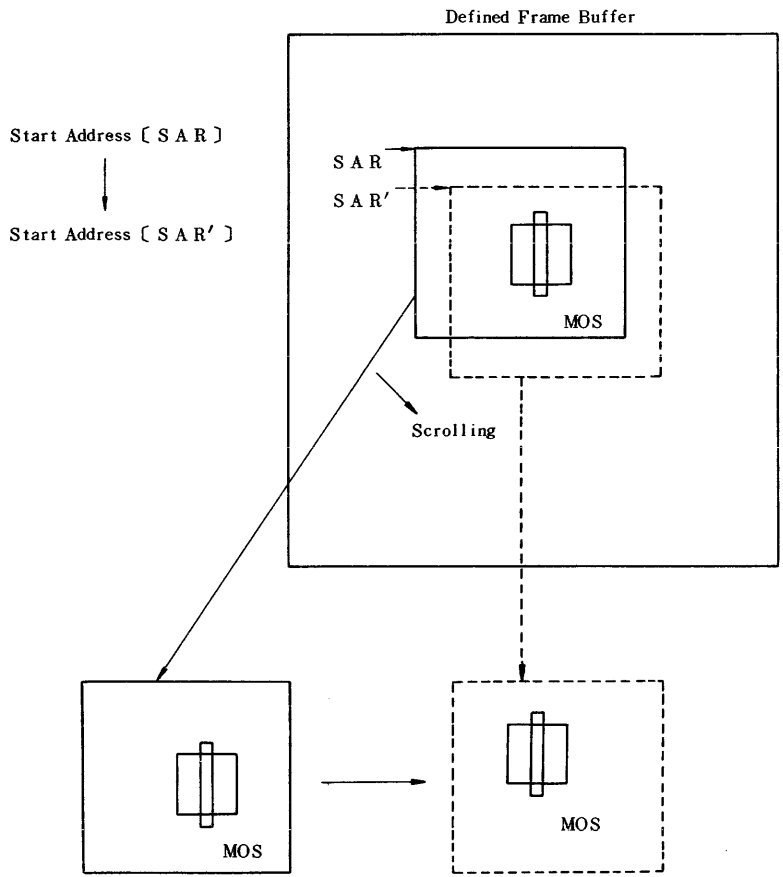


Figure 3.10 Scrolling By SAR (Start Address Register) Rewrite

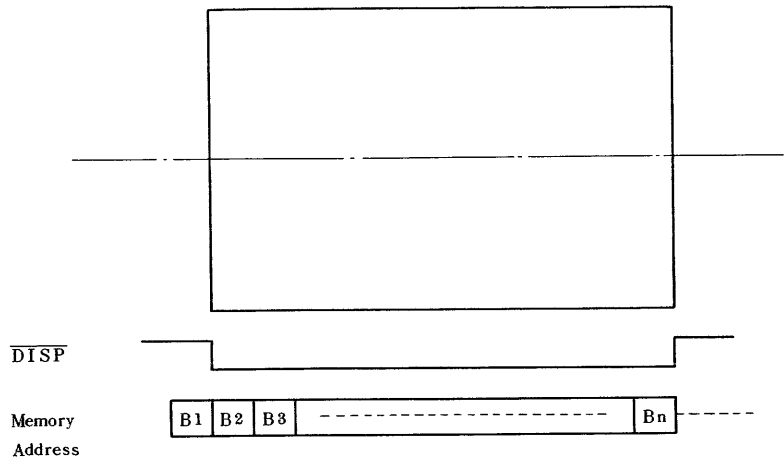


Figure 3.11 Horizontal Smooth Scroll – Base Screen

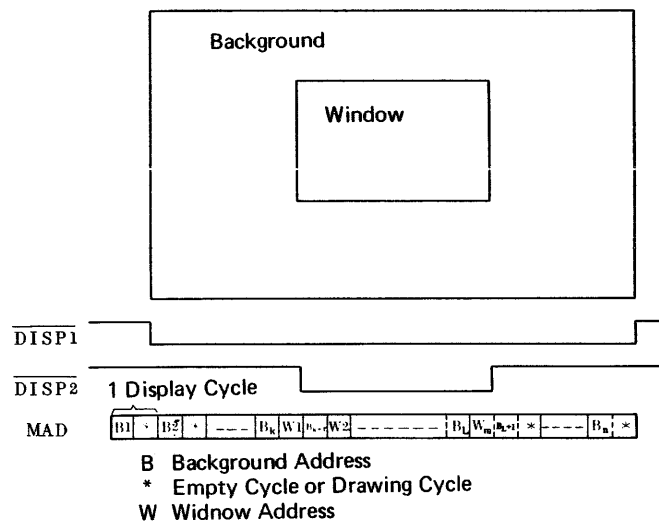


Figure 3.12 Horizontal Smooth Scroll – Window Screen

3.4 Raster Scan Modes

The ACRTC has three software selectable raster scan modes — Non-Interlace, Interlace Sync and Interlace Sync & Video. In Non-Interlace mode a frame consists of one field. In the Interlace modes, a frame consists of two fields, the even and odd fields.

The Interlace modes allow increasing screen resolution while avoiding limits imposed by the CRT display device, such as maximum horizontal scan frequency or maximum video dot rate.

Interlace Sync mode simply repeats each raster address for both the even and odd fields. This is useful for increasing the quality of a displayed figure when using an interlaced CRT device such as a Television Set with RF modulator.

Interlace Sync & Video mode displays alternate even and odd rasters on alternate even and odd fields. For a given number of rasters/character, this mode allows twice as many characters to be displayed in the vertical direction as Non-Interlace mode.

Note that for Interlace modes, the refresh frequency for a given dot on the screen is one-half that of the Non-Interlace mode. Interlace modes normally require the use of a CRT with a more persistent phosphor to avoid a flickering display.

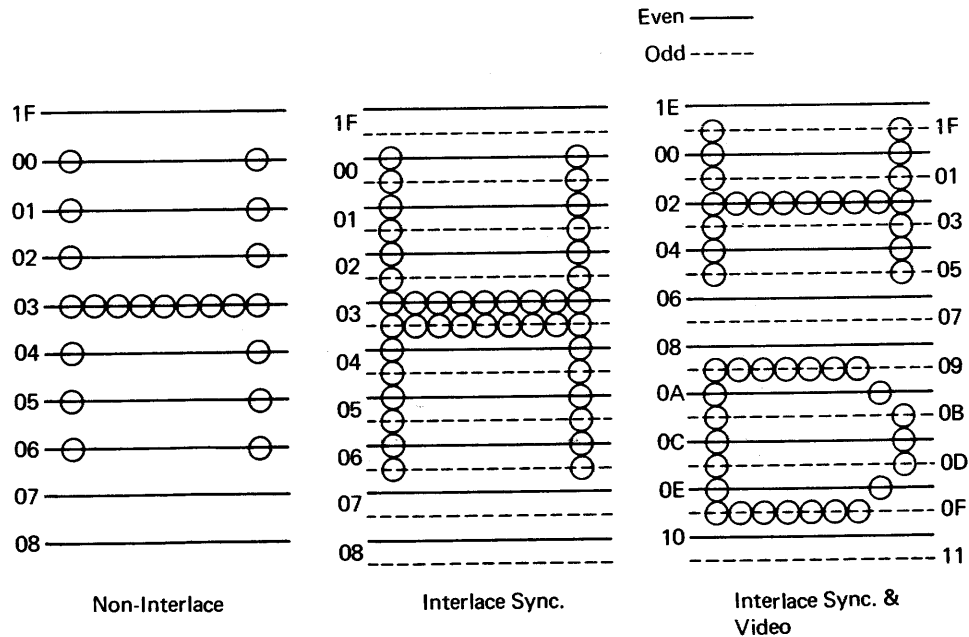
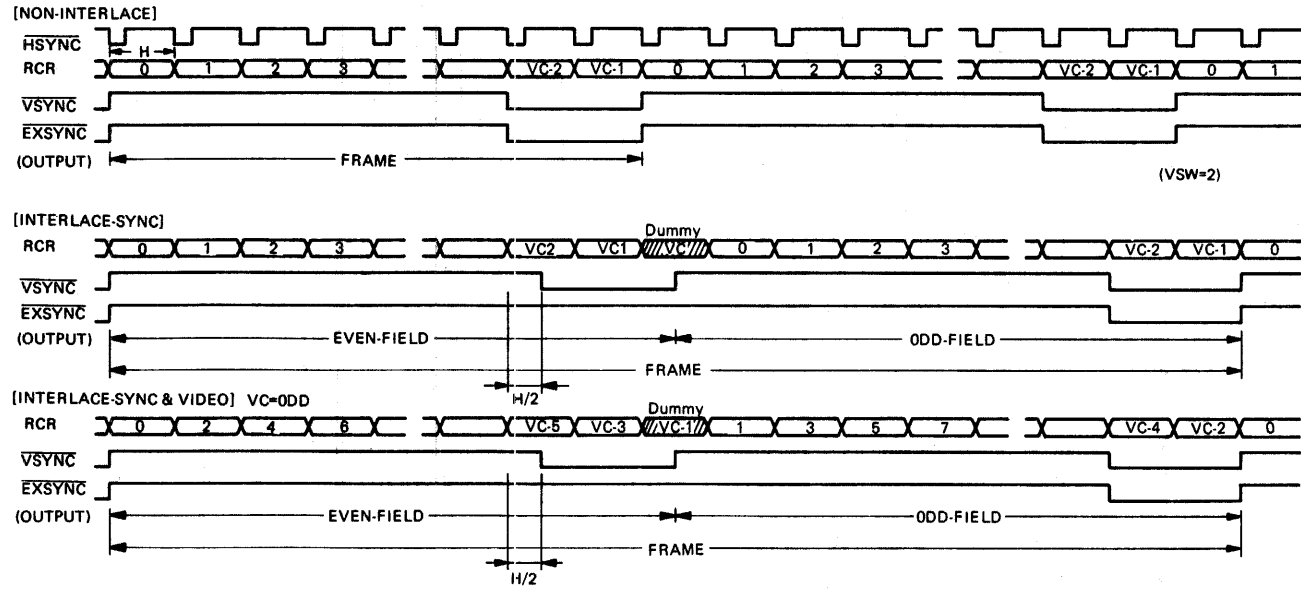


Figure 3.13 Raster Scan Modes

Figure 3.14 Raster Scan Timing



3.5 Zooming

The Base screen (Screen 1) is supported by the ACRTC zooming function. Note that ACRTC zooming is performed by controlling the CRT timing signals. The contents of the frame buffer area being zoomed are not changed.

The ACRTC allows specification of a zoom factor (1 to 16) independently in the X and Y directions.

For horizontal zoom, the programmed zoom factor is output as video attributes. An external circuit uses this factor to condition the external shift register clock to accomplish horizontal zooming.

For vertical zoom, no external circuit is required. The ACRTC will scan a single raster multiple times to accomplish vertical zooming.

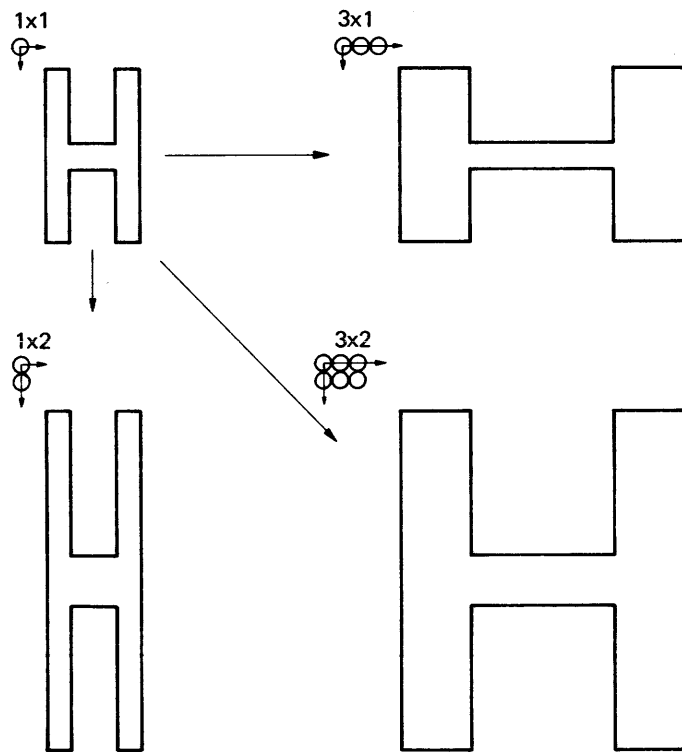


Figure 3.15 Zooming

3.6 Light Pen

The ACRTC provides a 20 bit Light Pen Address Register and a Light Pen Strobe (LPSTB) input pin for connection with a light pen.

A light pen strobe pulse will occur when the CRT electron beam passes under the light pen during display refresh. When this pulse occurs, the contents of the ACRTC display refresh address counter will be latched into the Light Pen Address Register along with a logical screen (Character or Graphic screen) designator. Also, an ACRTC status flag indicating light pen activity is set, generating an optional (maskable) MPU interrupt. Note that for Superimposed access mode, when the light pen strobe occurs in an area in which the Window overlaps a Background (Upper, Base or Lower) screen, the Background screen address will be latched.

Various system and ACRTC delays will cause the latched address to differ slightly from the actual light pen position. the light pen address can be corrected using software, based upon system specific delays. Or, if the application does not require the highest light pen pointing resolution, software can 'bound' the light pen address by specifying a range of values associated with a given area of the screen.

4. SIGNAL DESCRIPTION

4.1 Pin Arrangement

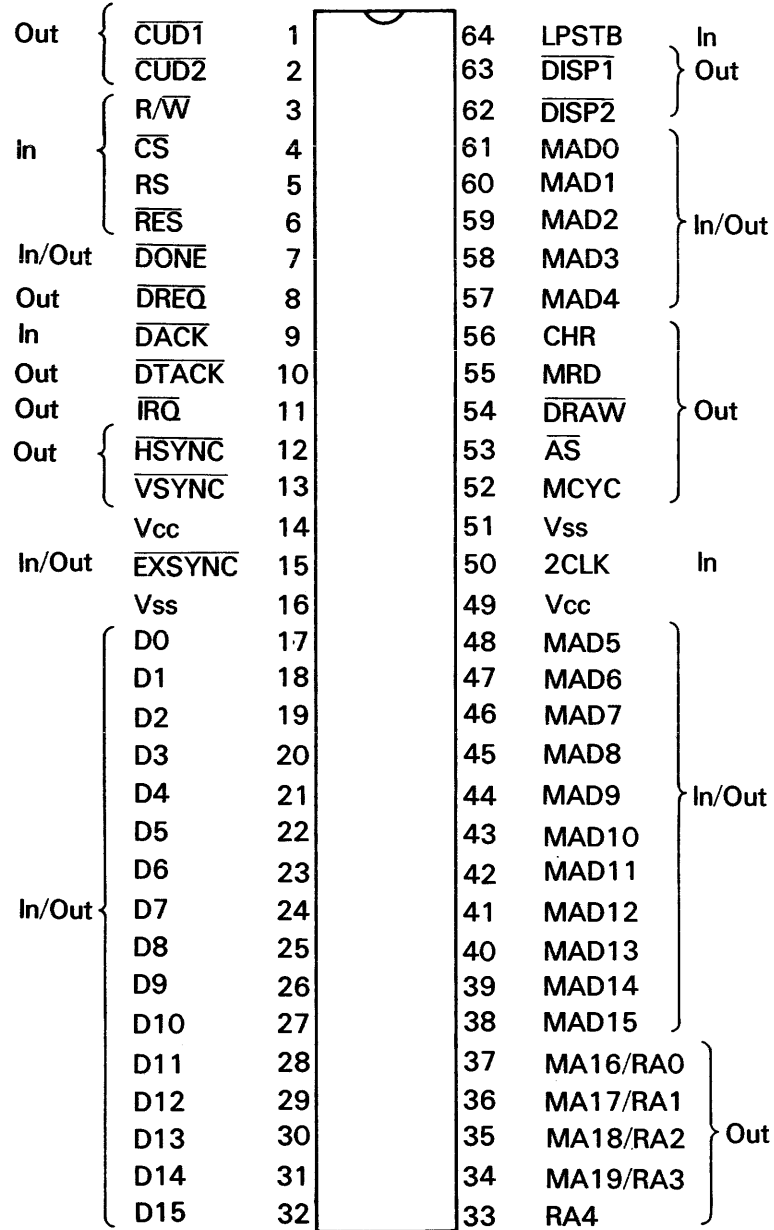


Figure 4.1 Pin Arrangement

4.2 Signal Functions

The ACRTC signal functions are grouped into 4 functional categories, MPU Interface, DMAC Interface, CRT Interface and Power Supply. All signals are TTL compatible.

4.2.1 MPU Interface

4.2.1.1 Reset ($\overline{\text{RES}}$:INPUT)

A low level on the $\overline{\text{RES}}$ input forces the ACRTC into the following state.

- (a) Drawing and Display operation is stopped.
- (b) ACRTC registers are initialized as follows.
 - Status register (SR) – CED, WFR and WFE bits are set to 1, all other bits reset to 0.
 - Command Control Register (CCR) – The ABT bit is set to 1. All other bits are reset to 0.
 - Operation Mode Register (OMR) – The M/S and STR bits are reset to 0. All other bits are unaffected.
 - All other ACRTC registers are unaffected by $\overline{\text{RES}}$.
- (c) The DRAM refresh address is placed on the MAD lines determined by the graphic address increment (GAI) mode. This remains the case until the start bit (STR) in the Operation Mode Register (OMR) is set to 1. $\overline{\text{HSYNC}}$ is also held low during the period from $\overline{\text{RES}}$ until the start bit in OMR is set to 1 by the host.

4.2.1.2 Bi-directional Host System Data Bus (D0-D15:INPUT/OUTPUT:3-STATE)

These lines are used for data transfer between the ACRTC and the host system data bus (MPU and/or DMAC). D0-D15 outputs are three state buffers and remain in the high impedance state except during host reads of ACRTC registers.

During reset, depending on the state of the $\overline{\text{DACK}}$ input, the ACRTC can be configured for an 8 bit data bus using D0-D7. In this case, D8-D15 should be left open.

4.2.1.3 Read/Write ($\overline{\text{R/W}}$:INPUT)

$\overline{\text{R/W}}$ controls the direction of transfer between the host system bus and the ACRTC. During non-DMA transfers, when $\overline{\text{R/W}}$ is high, data is transferred from the ACRTC to the host, and when low, data is transferred from the host to the ACRTC.

When the ACRTC executes a DMA transfer using an external DMAC, the polarity of R/\overline{W} is reversed. In this case, when R/\overline{W} is high, data is transferred from the host to the ACRTC, and when low, data is transferred from the ACRTC to the host.

4.2.1.4 Chip Select (\overline{CS} :INPUT)

The Chip Select, when low, enables access of the ACRTC by the host MPU. Note that Chip Select must not be low during DMA transfers ($\overline{DACK} = \text{low}$). RS and R/\overline{W} must be valid when \overline{CS} is asserted and write data must be valid prior to the trailing (rising) edge of \overline{CS} .

When the ACRTC host data bus mode is 16 bit data bus, 8 bit data transfers are not allowed.

4.2.1.5 Register Select (RS : INPUT)

RS is used to select ACRTC hardware accessed registers. When RS is low, reads ($R/\overline{W} = \text{high}$) access the Status register and writes ($R/\overline{W} = \text{low}$) access the Address register. When RS is high, reads and writes access the particular ACRTC Control register with address defined in the previous write to the Address register. If the accessed register is in the range of $r80 - rFF$, the address register will automatically be incremented to allow access to the next sequential register address. This allows high speed initialization of registers in the address range of $r80 - rFF$ without requiring the MPU to reload the address register for each sequential access. Note that the address increment is 1 for 8 bit host interface mode and 2 for 16 bit host interface mode.

Normally, RS is connected to the least significant bit of the MPU address bus.

4.2.1.6 Data Transfer Acknowledge (\overline{DTACK} :OUTPUT:OPEN DRAIN)

The ACRTC will drive \overline{DTACK} low to indicate completion of a data transfer cycle. \overline{DTACK} is compatible with asynchronous bus interface hosts including the HD68000 MPU and HD68450 DMAC.

4.2.1.7 Interrupt Request (\overline{IRQ} :OUTPUT:OPEN DRAIN)

This open drain output is driven low when the ACRTC requires interrupt service. In order to generate an \overline{IRQ} , the interrupting condition must be enabled in the Command Control Register (CCR).

The action required to clear the interrupting condition is specified in the Status Register description (section 5.3).

4.2.2 DMAC Interface

Three DMA handshaking lines allow the ACRTC to use an external DMA controller. The DMA protocol is directly compatible with HD68450 DMAC single address mode transfers.

4.2.2.1 DMA Request ($\overline{\text{DREQ}}$:OUTPUT)

During DMA transfer mode, $\overline{\text{DREQ}}$ is used to request data transfer service from the host bus DMAC. $\overline{\text{DREQ}}$ is asserted to active low level by ACRTC execution of a Data DMA transfer command (when the Data DMA Mode bit (DDM) in CCR is set to 1) or by setting the Command/Parameter DMA transfer mode bit (CDM) in the CCR to 1. Data DMA can be programmed as burst or cycle steal, while Command/Parameter DMA can only be burst mode.

4.2.2.2 DMA Acknowledge ($\overline{\text{DACK}}$:INPUT)

$\overline{\text{DACK}}$ is an answer back signal from the DMAC to which $\overline{\text{DREQ}}$ has been issued and indicates that the host bus has been acquired, and data transfer can occur. Note that when $\overline{\text{DACK}}$ is asserted low, $\overline{\text{CS}}$ must not be low and the R/ $\overline{\text{W}}$ signal polarity is reversed.

RS and R/ $\overline{\text{W}}$ must be valid prior to $\overline{\text{DACK}}$ assertion and data written to the ACRTC must be valid prior to the trailing (rising) edge of $\overline{\text{DACK}}$.

$\overline{\text{DACK}}$ is also used to define whether an 8 or 16 bit host data bus is used. During reset, if $\overline{\text{DACK}}$ is low, 8 bit mode is used and if $\overline{\text{DACK}}$ is high, 16 bit mode is used. In the case of 8 bit mode, host-ACRTC communication occurs on the D0-D7 portion of the data bus, while D8-D15 are disabled and driven high. When 8 bit bus mode is selected the automatic increment mode for the Address Register is set to '+1' (alternating even and odd register addresses), while 16 bit bus mode sets it to '+2' (even addresses only).

When 16 bit host data bus mode is used, 8 bit transfers are not allowed. When DMA is not used, $\overline{\text{DACK}}$ should be pulled up to a high level.

4.2.2.3 Done ($\overline{\text{DONE}}$:INPUT/OUTPUT:OPEN DRAIN)

$\overline{\text{DONE}}$ is used to terminate DMA transfers. During Data DMA transfers, $\overline{\text{DONE}}$ is an output and when asserted low indicates DMA termination to the external DMAC. During Command/Parameter DMA transfers, $\overline{\text{DONE}}$ is an input asserted low by the external DMAC to terminate DMA. Note that Data DMA cannot be terminated by externally forcing $\overline{\text{DONE}}$ low.

$\overline{\text{DONE}}$ is open drain when in the output state, and should be pulled up to high level when not used.

4.2.3 CRT Interface

4.2.3.1 Clock (2CLK:INPUT)

This is the basic operating clock for the ACRTC which is derived from the external dot clock. The ACRTC internally divides 2CLK by 2 to generate the MCYC Memory Cycle Clock. Thus, 2CLK is twice the frequency of the frame buffer memory access timing. 2CLK must be a continuous clock input.

4.2.3.2 Vertical Synchronization ($\overline{\text{VSYNC}}$:OUTPUT)

$\overline{\text{VSYNC}}$ is used to output the active low Vertical Synchronization timing signal required by the CRT display device.

4.2.3.3 Horizontal Synchronization ($\overline{\text{HSYNC}}$:OUTPUT)

$\overline{\text{HSYNC}}$ is used to output the active low Horizontal Synchronization timing signal required by the CRT display device.

$\overline{\text{HSYNC}}$ is also used when the ACRTC performs DRAM refresh addressing of the frame buffer. In the case that the STR start bit or the RAM bit in the Operation Mode Register (OMR) are set to 0, $\overline{\text{HSYNC}}$ asserted low indicates that the DRAM refresh addresses are present on MAD frame buffer address/data bus.

4.2.3.4 External Synchronization ($\overline{\text{EXSYNC}}$:INPUT/OUTPUT)

$\overline{\text{EXSYNC}}$ is an active low input and output signal used for synchronizing multiple ACRTCs or synchronizing the ACRTC with other video generating devices. The ACRTC is programmed as a master or slave by the state of the M/S bit in the Operation Mode Register (OMR). When the ACRTC is master, $\overline{\text{EXSYNC}}$ is an output which may be used to drive a slave video generating devices $\overline{\text{VSYNC}}$ input or a slave ACRTCs $\overline{\text{EXSYNC}}$ input. When the ACRTC is slave, $\overline{\text{EXSYNC}}$ is an input which receives the masters $\overline{\text{EXSYNC}}$ (master is another ACRTC) or $\overline{\text{VSYNC}}$ (master is another video generating device).

In both master and slave configurations, the timing of $\overline{\text{EXSYNC}}$ depends on the interlace mode. For example, in interlaced modes, $\overline{\text{EXSYNC}}$ timing corresponds to $\overline{\text{VSYNC}}$ of the odd field.

4.2.3.5 Light Pen Strobe (LPSTB:INPUT)

LPSTB input accepts a positive strobe pulse generated by an external light pen. When asserted high, the current frame buffer display refresh address is latched into the Light Pen Address Register and the LPD (Light Pen Detect) bit in the Status Register is set to 1, generating an interrupt if enabled to do so by the MPU. The stored address will be different from the actual address due to the following delays.

- (a) ACRTC address output delay
- (b) Address output to video signal output delay
- (c) Light pen detection to LPSTB delay
- (d) LPSTB to internal recognition delay

The actual address should be calculated by adjusting the stored address considering the above delays. Also note that, for Superimposed access mode, when the light pen strobe occurs in the Window screen, the overlapped Background (Upper, Base, Lower) screen address is latched.

4.2.3.6 Memory Cycle (MCYC:OUTPUT)

MCYC frequency is one-half that of the ACRTC 2CLK input and is output continuously. MCYC determines frame buffer memory access timing. MCYC low indicates the address portion of the memory access while MCYC high indicates the data portion of the memory access.

4.2.3.7 Address Strobe (\overline{AS} :OUTPUT)

\overline{AS} output is used to latch the frame buffer address. When \overline{AS} is low, the MAD outputs contain the frame buffer address. \overline{AS} is also used to load the external parallel to serial (shift register) converter with the data from frame buffer during the display cycle.

4.2.3.8 Memory Read (MRD:OUTPUT)

During a frame buffer access, MRD indicates the direction of data transfer between the ACRTC and the frame buffer. When MRD is high, a frame buffer read cycle occurs, and when MRD is low, a frame buffer write cycle occurs. In superimposed mode, MRD low indicates the read cycle of window screen data (second phase).

4.2.3.9 Draw (\overline{DRAW} :OUTPUT)

The \overline{DRAW} signal differentiates between ACRTC drawing and CRT display refresh cycles. When \overline{DRAW} is low, the MAD outputs contain multiplexed drawing address and data information. When \overline{DRAW} is high, the MAD outputs contain a display refresh address during the address portion of the cycle, and are high impedance during the data portion of the cycle.

4.2.3.10 Frame Buffer Memory Address/Data (MAD0-MAD15:INPUT/OUTPUT:3-STATE)

MAD0-MAD15 are the time multiplexed, bi-directional frame buffer memory address and data bus. When \overline{AS} is low, MAD contains the lower 16 bits of the drawing or display address. When \overline{AS} is high and \overline{DRAW} is low, MAD transfers the drawing data to and from the frame buffer.

When no frame buffer access is occurring, the MAD bus is 3-stated.

When the RAM bit in the Operation Mode Register (OMR) is set to 0, the 8 bit DRAM refresh address is output on MAD during \overline{HSYNC} low. The particular bits of MAD used for this 8 bit refresh address depend on the programmed Graphic Address Increment (GAI) mode.

4.2.3.11 Memory Address/Raster Address (MA16/RA0-MA19/RA3:OUTPUT)

These lines output either the 4 most significant bits of the frame buffer address (MA16-MA19) or the 4 least significant bits of the raster address (RA0-RA3). In Character mode (CHR = high), these lines are used as a raster address for connection to an external character generator. In Graphic mode (CHR = low) these lines are used with MAD0-MAD15 to provide a 20 bit linear frame buffer address.

4.2.3.12 Raster Address 4 (RA4:OUTPUT)

In Character mode (CHR = high), RA4 output the most significant bit of the raster address. Thus, 5 bits (RA0-RA4) provide up to 32 rasters per character.

In Graphic mode (CHR = low), the state of this output is undefined.

4.2.3.13 Character (CHR:OUTPUT)

CHR is an output indicating whether the current frame buffer address on MAD has been defined as corresponding to character (CHR = high) or graphic (CHR = low). When high, MAD0-MAD15 contains a 16 bit frame buffer address, while other MAD lines contain raster address information. When low, MAD0-MAD15, MA16-MA19 contains a 20 bit linear frame buffer address. CHR can be used to enable an external character generator. Also, CHR can be used to enable the appropriate memory bank in the case that character and graphic memory are separated.

4.2.3.14 Display Timing ($\overline{\text{DISP1}}, \overline{\text{DISP2}}$:OUTPUT)

These active low outputs indicate the active display period of the screen. They can be used in one of two ways.

- (a) Background screen/window screen display timing signal
- (b) Vertical/horizontal display timing signal

4.2.3.15 Cursor Display ($\overline{\text{CUD1}}, \overline{\text{CUD2}}$:OUTPUT)

These outputs are externally logically combined with the video signal to produce the cursor display on the screen. Three modes of cursor display are selectable by setting the cursor mode (CM) bits in the Cursor Definition Register (CDR).

Cursor Mode	Description	CUD1	CUD2
BLOCK	The separate display of two BLOCK cursors	Block cursor 1	Block cursor 2
GRAPHIC	The display of a GRAPHIC cursor and two multiplexed BLOCK cursors	Graphic cursor	Block cursor 1&2
CROSSHAIR	The X and Y portions of a CROSSHAIR cursor	X portion	Y portion

4.2.4 Power Supply

4.2.4.1 Vcc, Vss

These pins supply power to the ACRTC. V_{CC} is specified as $5V \pm 10\%$ (4.5V~5.5V).

4.2.5 Video Attributes

The ACRTC outputs 20 bits of video attributes on MAD0-MAD15 and MA16/RA0-MA19/RA3. These attributes are output at the last cycle prior to the rising edge of $\overline{\text{HSYNC}}$ and should be latched externally. Thus, video attributes can be set on a raster by raster basis.

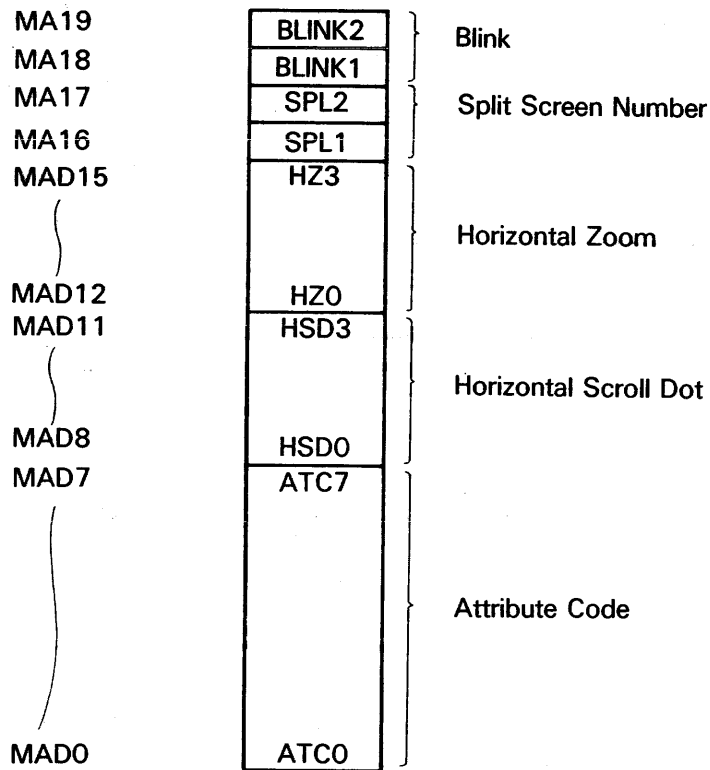


Figure 4.2 Video Attributes

4.2.5.1 Attribute Code (ATC0-ATC7:MAD0-MAD7)

These are user defined attributes. The programmed contents of the Attribute Control bits (ATR) of the Display Control Register (DCR) are output on these lines.

4.2.5.2 Horizontal Scroll Dot (HSD0-HSD3:MAD8-MAD11)

These are used in conjunction with external circuitry to implement smooth horizontal scroll. These lines contain the encoded start dot address which is used to control the external shift register load timing and data. HSD usually corresponds to the start dot address of the background screens. However, if the window smooth scroll (SWS) bit of OMR (Operation Mode Register) is set to 1, HSD outputs the start dot address of the window screen segment.

4.2.5.3 Horizontal Zoom Factor (HZ0-HZ3:MAD12-MAD15)

These lines output the encoded (1-16) horizontal zoom factor as stored in the Zoom Factor Register (ZFR). Horizontal zoom is accomplished by the ACRTC repeating a single display address and using the HZ outputs to control the external shift register clock. Horizontal zoom can only be applied to the Base screen.

4.2.5.4 Split Position (SPL1-SPL2:MA16-MA17)

These lines present the encoded information showing the enabled background screen currently being displayed by the ACRTC.

SPL2	SPL1	
0	0	Background Screen not enabled or displayed
0	1	Base Screen
1	0	Upper Screen
1	1	Lower Screen

4.2.5.5 Blink (BLINK1-BLINK2:MA18-MA19)

The lines alternate from high to low periodically as defined in the Blink Control Register (BCR). the blink frequency is specified in units of 4 field times. A field is defined as the period between successive \overline{VSYNC} pulses. These lines are used to implement character and screen blink.

5. REGISTER DESCRIPTION

5.1 Internal Register Access

The ACRTC incorporates more than 200 bytes of internal Control registers and Control RAM which are accessible by the host MPU. The programming model is shown in figure 5.1.

For the detailed register descriptions in this section, the following terminology is used.

Hexadecimal numbers are denoted by a leading \$ i.e. \$1234, \$FF, etc.

For directly accessible registers, the register address is shown as 'rNN' where NN is interpreted as an 8 bit hexadecimal value. For example, the Zoom Factor Register address is OEA hexadecimal, so ZFRs register address is shown as 'rEA'.

For FIFO accessible Drawing Parameter Registers, the register address is shown as 'PrNN'. For example, the Color Comparison Register is addressed as parameter register 2 hex, so the CMP register address is shown as 'Pr02'.

Bit subfields within the register are denoted using decimal bit numbers in which bit 0 is the least significant bit and bit 15 the most significant bit.

When the register diagram is shown, unused bits will be shaded. Unless stated otherwise, unused bits may be freely written with any value, and that value will be returned on subsequent reads of the register.

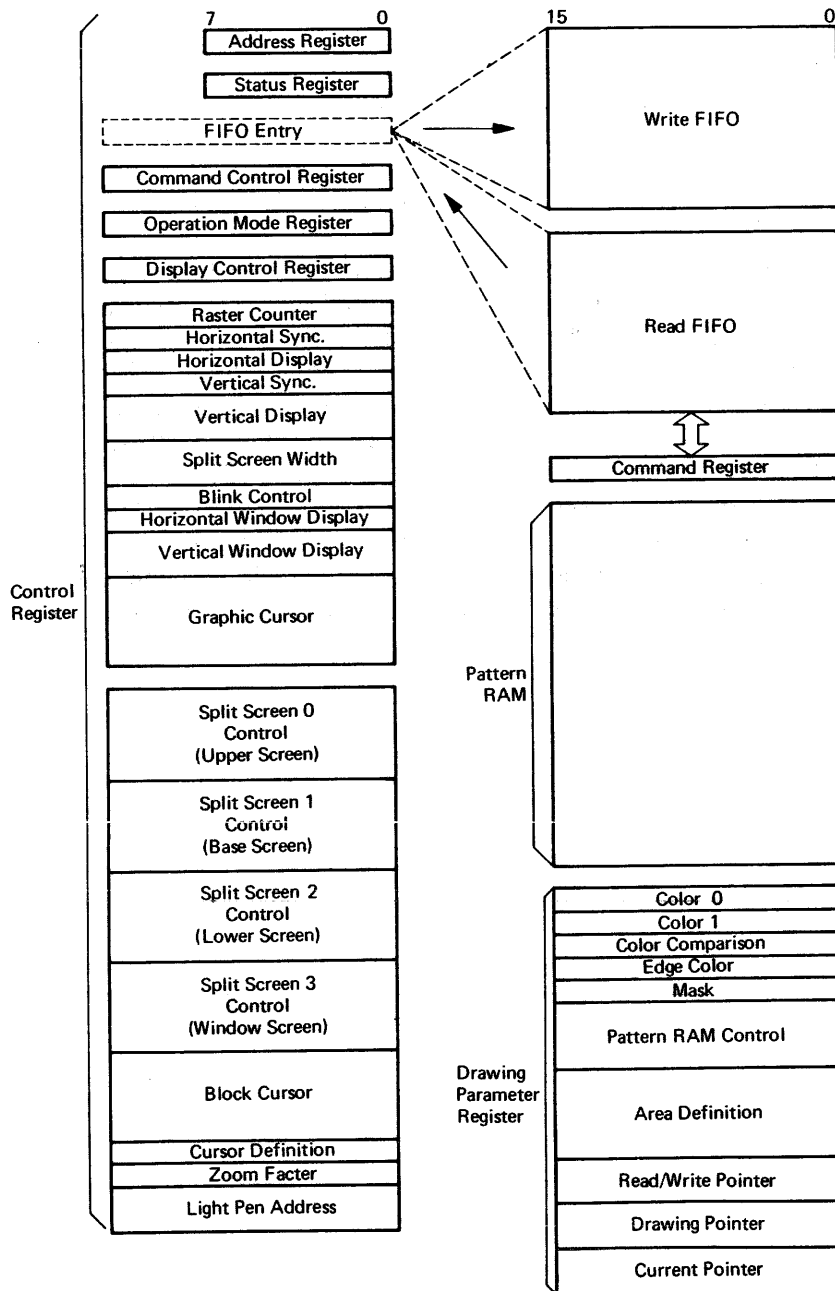


Figure 5.1 Programming Model

C	S	R/W	Reg. No.	Register Name	Abbr.	DATA (H)								DATA (L)													
						15	14	13	12	11	10	9	8	7	6	5	4	3	2	1	0						
1	—	—	—	—	—	Address																					
0	0	0	AR	Address Register	AR	Address																					
0	0	1	SR	Status Register	SR	CER ARD CED LPD RFF RFR WFR WFE																					
1/0	—	—	r00	FIFO Entry	FE	FE																					
1/0	—	—	r02	Command Control	CCR	ABT	PSE	DDM	CDM	DRC	GBM	CRE	ARE	CEE	LPE	RFE	RRE	WRE	WEE								
1/0	—	—	r04	Operation Mode	OMR	M/S	STR	ACP	WSS	CSK	DSK	RAM	GAI	ACM	RSM												
1/0	—	—	r06	Display Control	DCR	DSP	SE1	SE0	SE2	SE3	ATR																
—	—	—	r08	No USE and RESERVED																							
—	—	—	r7E	No USE and RESERVED																							
1	—	—	r80	Raster Count	RCR	—										RC											
1/0	—	—	r82	Horizontal Sync.	HSR	—										HSW											
1/0	—	—	r84	Horizontal Display	HDR	HDS										HDW											
1/0	—	—	r86	Vertical Sync.	VSR	—										VC											
1/0	—	—	r88	Vertical Display	VDR	VDS										VSW											
1/0	—	—	r8A	—																							
1/0	—	—	r8C	Split Screen Width	SSW	—										SP1											
1/0	—	—	r8E	—																							
1/0	—	—	r90	Blink Control	BCR	BON1				BOFF1				BON2				BOFF2									
1/0	—	—	r92	Horizontal Window Display	HWR	HWS										HWW											
1/0	—	—	r94	Vertical Window Display	VWR	—										VWS											
1/0	—	—	r96	—																							
1/0	—	—	r98	Graphic Cursor	GCR	CXE										CXS											
1/0	—	—	r9A	—																							
1/0	—	—	r9C	—																							
—	—	—	r9E	ACRTC Work Area	—	—										CYS CYE											
—	—	—	rA0	No USE and RESERVED																							
—	—	—	rBE	No USE and RESERVED																							
1/0	—	—	rC0	UPPER	Raster Address 0	RAR0	—				LRA0				—				FRA0								
1/0	—	—	rC2	(Back	Memory Width 0	MWR0	CHR	—				—				MW0											
1/0	—	—	rC4	Ground)	Start Address 0	SAR0	—				SDA0				SAOH/SAR0												
1/0	—	—	rC6	SA0L																							
1/0	—	—	rC8	BASE	Raster Address 1	RAR1	—				LRA1				—				FRA1								
1/0	—	—	rCA	(Back	Memory Width 1	MWR1	CHR	—				—				MW1											
1/0	—	—	rCC	Ground)	Start Address 1	SAR1	—				SDA1				SA1H/SRA1												
1/0	—	—	rCE	SA1L																							
1/0	—	—	rD0	LOWER	Raster Address 2	RAR2	—				LRA2				—				FRA2								
1/0	—	—	rD2	(back	Memory Width 2	MWR2	CHR	—				—				MW2											
1/0	—	—	rD4	Ground)	Start Address 2	SAR2	—				SDA2				SA2H/SRA2												
1/0	—	—	rD6	SA2L																							
1/0	—	—	rD8	Window	Raster Address 3	RAR3	—				LRA3				—				FRA3								
1/0	—	—	rDA	—																							
1/0	—	—	rDC	—																							
1/0	—	—	rDE	—																							
1/0	—	—	rE0	Block Cursor 1	BCUR1	BCW1				BCSR1				—				BCER1									
1/0	—	—	rE2	—																							
1/0	—	—	rE4	Block Cursor 2	BCUR2	BCW2				BCSR2				—				BCER2									
1/0	—	—	rE6	—																							
1/0	—	—	rE8	Cursor Definition	CDR	CM	CON1				COFF1				—				CON2				COFF2				
1/0	—	—	rEA	Zoom Factor	ZFR	HZF				VZF				—				—									
1	—	—	rEC	Light Pen Address	LPAR	—										CHR				—				LPAH			
1	—	—	rEE	LPAL																							
—	—	—	rF0	No USE and RESERVED																							
—	—	—	rFE	No USE and RESERVED																							

Figure 5.1 (cont.) Programming Model

5.2 Address Register

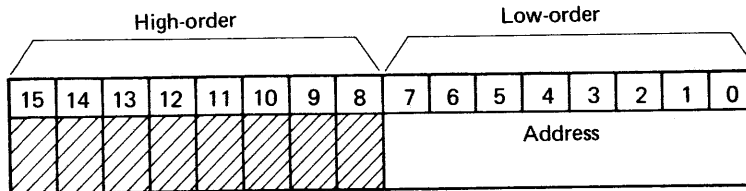


Figure 5.2 Address Register (AR)

AR is a write only register used to specify the address (0-\$FF) of the ACRTC control register to be accessed. AR is written during MPU write cycles in which \overline{CS} and RS are both low.

In the 16 bit mode, the least significant bit of AR is always recognized as 0, and thus the AR provides a word register address. In the 8 bit bus mode, if AR is even, the most significant byte of the control register is accessed. If odd, the least significant byte of the control register is accessed. Independent of 8 or 16 bit bus mode, AR should be loaded with 0 to access the read and write FIFOs.

The Timing Control RAM and Display Control RAM occupy the register address space from r80-r9F and rC0-rEF respectively. To support block move type initialization/access of these registers, reads and writes to the register address space r80-rFF result in automatic incrementing of AR. Thus, the programmer need not explicitly address each register for sequential access. AR is incremented by 1 in 8 bit bus mode, and by 2 in 16 bit bus mode.

AR is not incremented for accesses of r00-r7F.

5.3 Status Register (SR: \overline{CS} , \overline{RS} = low, R/ \overline{W} = high)

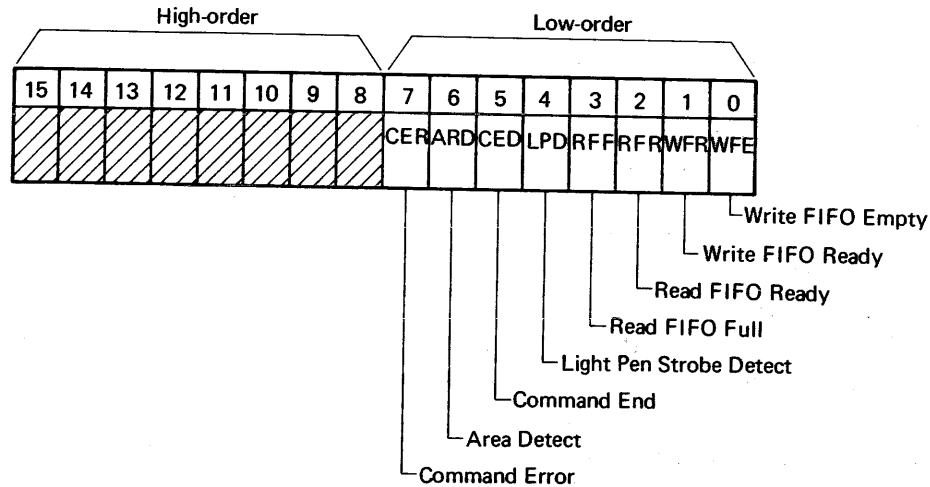


Figure 5.3 Status Register (SR)

SR is a read-only register containing 8 bits which reflect the state of internal status flags. If enabled by an interrupt enable bit in the CCR, a 1 bit in the corresponding SR flag will cause an interrupt (\overline{IRQ}) to be generated.

When hardware \overline{RES} is asserted, the CED, WFE and WFR bits are set to 1 and all other bits are reset to 0.

- Command Error Flag (CER: bit 7)
CER set to 1 indicates that the ACRTC has detected an undefined command or invalid parameter.
CER is cleared by setting the ABT bit in CCR = 1.
- Area Detect Flag (ARD: bit 6)
ARD is set to 1 depending on the AREA mode programmed for ACRTC graphic drawing commands. The ARD flag allows the MPU to detect whether the ACRTC has performed clipping or hitting during graphic drawing.
ARD is cleared by execution of the RPR (Read Parameter Register) command or setting the ABT bit in CCR = 1.

- Command End (CED: bit 5)
CED set to 1 indicates that the ACRTC is able to accept a new command.
CED is cleared by writing a command to the write FIFO.
- Light Pen Detect (LPD: bit 4)
LPD set to 1 indicates that the light pen strobe (LPSTB) has occurred and the Light Pen Address Register contains the latched address.
LPD is cleared by reading the Light Pen Address Register or setting the ABT bit in CCR = 1.
- Read FIFO Full (RFF: bit 3)
RFF set to 1 indicates that the read FIFO is full (contains 8 words/16 bytes of data).
RFF is cleared by reading at least one 16 bit word from the read FIFO or setting the ABT bit in CCR = 1.
- Read FIFO Ready (RFR: bit 2)
RFR set to 1 indicates that the read FIFO contains one or more words of data.
RFR is cleared by reading all data from the read FIFO.
- Write FIFO Ready (WFR: bit 1)
WFR set to 1 indicates that the write FIFO is not full, and MPU writes can occur. WFR is also set to 1 when the ABT bit in CCR is set to 1.
WFR is cleared when the write FIFO contains 8 words/16 bytes of data.
- Write FIFO Empty (WFE: bit 0)
WFE set to 1 indicates that the write FIFO is empty. WFE is also set to 1 when the ABT bit in CCR is set to 1.
WFE is cleared when a 16 bit word data is written to the write FIFO.

Table 5.1 Setting and Resetting of Status Register

Bit	Status Register	Set	Reset
7	CER (Command Error)	<ul style="list-style-type: none"> • An undefined command has been detected 	<ul style="list-style-type: none"> • Abort
6	ARD (Area Detect)	<ul style="list-style-type: none"> • An area has been detected according to the AREA mode command 	<ul style="list-style-type: none"> • Execute a Read Parameter Register (RPR) command • Abort
5	CED (Command End)	<ul style="list-style-type: none"> • A command has been executed • Abort 	<ul style="list-style-type: none"> • Write a command to the write FIFO
4	LPD (Light Pen Strobe Detect)	<ul style="list-style-type: none"> • LPSTB has occurred 	<ul style="list-style-type: none"> • Read the Light Pen Address Register after reading the Status Register • Abort
3	RFF (Read FIFO Full)	<ul style="list-style-type: none"> • The read FIFO is full 	<ul style="list-style-type: none"> • Read data from the read FIFO
2	RFR (Read FIFO Ready)	<ul style="list-style-type: none"> • The read FIFO contains data 	<ul style="list-style-type: none"> • Read all data from the read FIFO • Abort
1	WFR (Write FIFO Ready)	<ul style="list-style-type: none"> • The write FIFO is not full • Abort 	<ul style="list-style-type: none"> • The write FIFO is full
0	WFE (Write FIFO Empty)	<ul style="list-style-type: none"> • The write FIFO is empty • Abort 	<ul style="list-style-type: none"> • Write data into the write FIFO

5.4 FIFO Entry (FE: r00-r01)

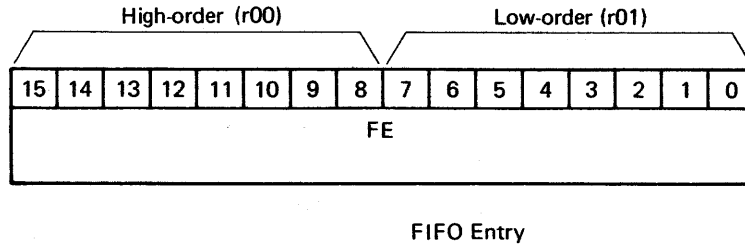


Figure 5.4 FIFO Entry (FE)

When the AR contains the FIFO Entry address (r00), reads and writes to the ACRTC (\overline{CS} = low, RS = high) utilize the corresponding 16 byte read or write FIFOs.

In 16 bit bus mode, 16 bit words are written and read to/from the appropriate FIFO. In 8 bit bus mode, FIFO writes are in the order of high byte-low byte, while FIFO reads are in the order of high byte-low byte.

In DMA transfer mode, the read and write FIFOs are selected regardless of the contents of AR and AR remains unchanged.

5.5 Command Control Register (CCR: r02-r03)

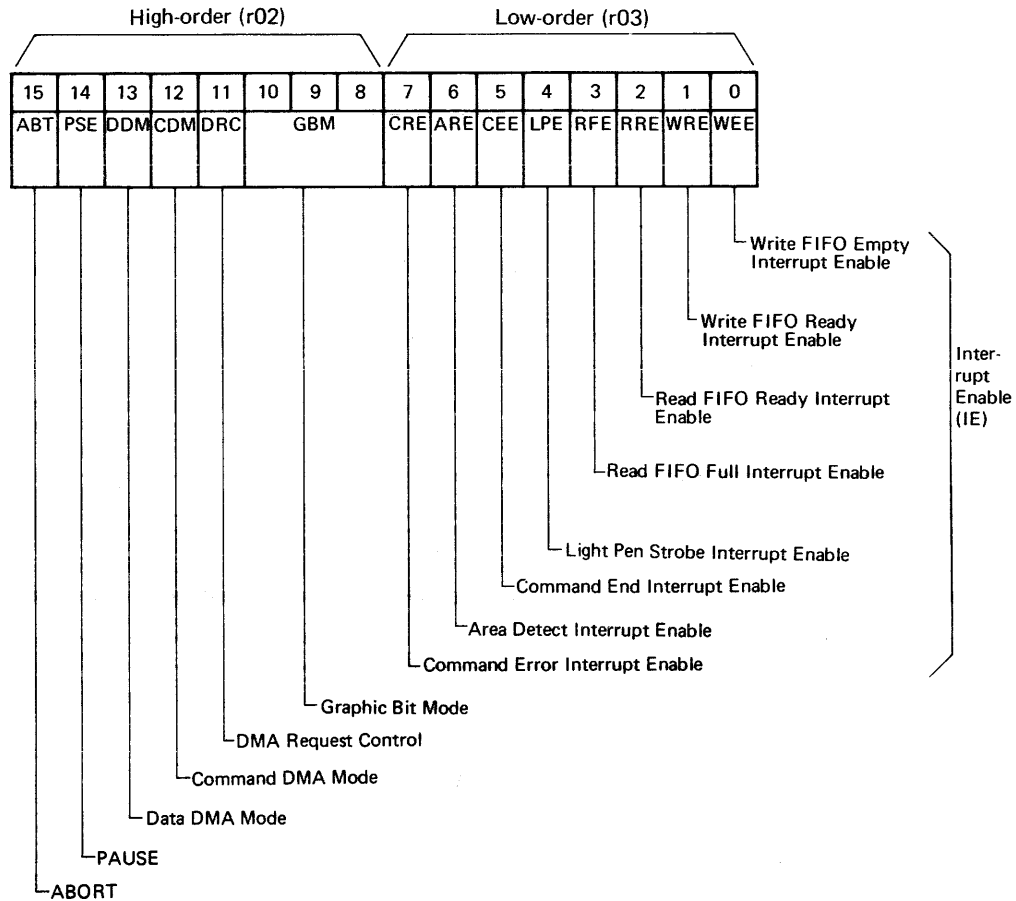


Figure 5.5 Command Control Register

CCR controls command processing and enabling and disabling of interrupt requests. The 8 interrupt enable bits in the low byte of CCR correspond directly to the 8 status flags in the Status register.

When \overline{RES} is asserted, the ABT (abort) bit is initialized to 1 and all other CCR bits are initialized to 0.

○ Abort (ABT: bit 15)

ABT	Functions
0	ACRTC command execution is enabled. When ABT is changed from 0 to 1, the ACRTC cannot access the FIFOs.
1	ACRTC command execution is aborted and the read/write FIFOs are cleared. The status register (SR) is set to \$23.

○ Pause (PSE: bit 14)

PSE	Functions
0	ACRTC command execution is resumed.
1	ACRTC command execution is halted until PSE is reset to 0. ACRTC DMA (Data and Command/Parameter) is halted until PSE is reset to 0.

○ Data DMA Mode (DDM: bit 13)

DDM	Functions
0	Data DMA transfer mode is disabled. \overline{DREQ} is not asserted even if the MPU issues DMA transfer commands.
1	Data DMA transfer mode is enabled. Whether DMA is burst or cycle steal mode is determined by DRC (bit 11 this register). DDM must be set before DMA data transfer commands are issued.

Note: MPU must not access ACRTC FIFOs during cycle steal transfer.

○ Command DMA Mode (CDM: bit 12)

CDM	Functions
0	Command/Parameter DMA transfer mode is disabled. Commands and parameters are issued under MPU program control.
1	Command/Parameter DMA transfer mode is enabled. Command/Parameter DMA mode is terminated when (a) the MPU resets CDM to 0 or (b) the \overline{DONE} input is asserted (which also resets CDM to 0).

Note: (a) Command/Parameter DMA transfers use cycle stealing DMA regardless of the state of DRC (bit 11 this register).
 (b) Data DMA transfer commands cannot be issued using Command/Parameter DMA. In-
 sure that the Commands and Parameters transferred by Command/Parameter DMA do
 not include DMA data transfer commands.

○ DMA Request Control (DRC: bit 11)

DRC	Functions
0	<p>Burst Mode: \overline{DREQ} is designated as a level signal (burst mode). DRC = 0 is only valid for data DMA transfer commands. A maximum of 8 words/16 bytes data is transferred per DMA request. The ACRTC controls \overline{DREQ} by monitoring the empty state of the read/write FIFOs. Burst mode can only be used for Data DMA.</p>
1	<p>Cycle Steal Mode: \overline{DREQ} is designated as a pulse signal (cycle steal mode). \overline{DREQ} is output once for each word (16 bit data bus mode) or once for each byte (8 bit data bus mode) transfer. In the data DMA transfer mode, the ACRTC controls \overline{DREQ} as described above. In the command/parameter DMA transfer mode, the ACRTC will issue \overline{DREQ} when 1 word (byte) space remains in the FIFO. Thus, when \overline{DREQ} stops, the MPU can immediately make at least one access of the ACRTC write FIFO.</p>

○ Graphic Bit Mode (GBM: bit 10 - bit 8)

GBM defines the number of physical bits of frame buffer memory associated with a logical pixel. 1 bit per pixel is monochrome, while 16 bits per pixel allows a logical pixel to assume 1 of 64K possible colors or tones.

GBM			Mode	Number of colors displayed per pixel	Pixels/16 bit word
10	9	8			
0	0	0	1 bit/pixel	1	16
0	0	1	2 bits/pixel	4	8
0	1	0	4 bits/pixel	16	4
0	1	1	8 bits/pixel	256	2
1	0	0	16 bits/pixel	64K	1
.	.	.	←-----INVALID-----→		
1	1	1			

○ Interrupt Enable Bit (IE: bit 7 - bit 0)

An \overline{IRQ} is generated when an event flag in the Status register and the corresponding interrupt enable bit are both set to 1.

Bit		Name	Set to 1 to enable interrupt for...
7	Command Error	CRE	Command Error
6	Area Detect	ARE	Clipping and Hitting detection
5	Command End	CEE	Command Termination
4	Light Pen Detect	LPE	LPSTB Asserted
3	Read FIFO Full	RFE	Read FIFO Full
2	Read FIFO Ready	RRE	Read FIFO Ready
1	Write FIFO Ready	WRE	Write FIFO Ready
0	Write FIFO Empty	WEE	Write FIFO Empty

5.6 Operation Mode Register (OMR: r04-r05)

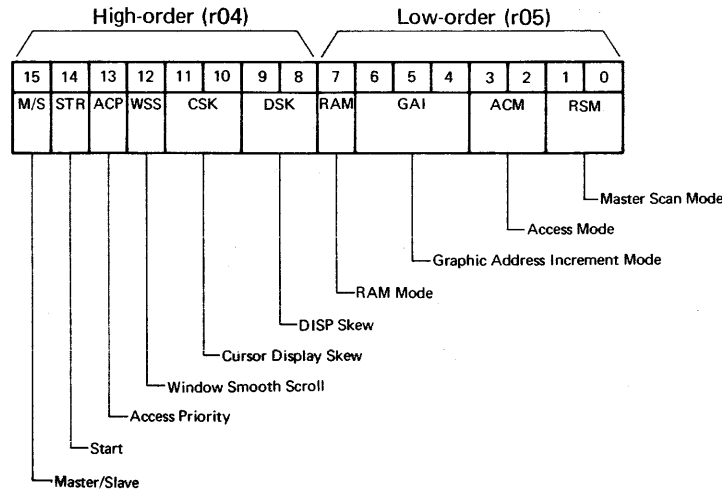


Figure 5.6 Operation Mode Register (OMR)

OMR determines major operating parameters and modes of the ACRTC. The 2 most significant bits (M/S and STR) are reset to 0 and all other bits are unaffected by $\overline{\text{RES}}$.

- Master/Slave (M/S: bit 15)
M/S defines whether the ACRTC operates as a master or slave when combined with other ACRTCs or video generating devices. M/S is reset to 0 during $\overline{\text{RES}}$. When a single ACRTC is used, M/S should be set to 1 and the $\overline{\text{EXSYNC}}$ pin left open.

M/S	Functions
0	<p>Slave Mode: $\overline{\text{EXSYNC}}$ is defined as an input. ACRTC internal operations are reset on the rising edge of the $\overline{\text{EXSYNC}}$ input. For non-interlace modes, the masters $\overline{\text{VSYNC}}$ should be connected to the $\overline{\text{EXSYNC}}$ input. For interlaced modes, the $\overline{\text{VSYNC}}$ of the masters odd field should be connected to the $\overline{\text{EXSYNC}}$ input. In the specific case of multiple ACRTC synchronization, the master and all slaves ACRTCs $\overline{\text{EXSYNC}}$ pins should be connected independent of interlace mode.</p>
1	<p>Master Mode: $\overline{\text{EXSYNC}}$ is defined as an output. For non-interlace modes, the $\overline{\text{EXSYNC}}$ output timing is the same as $\overline{\text{VSYNC}}$ output timing. For interlace modes, the $\overline{\text{EXSYNC}}$ output timing is generated by the $\overline{\text{VSYNC}}$ output for the odd field.</p>

Note: $\overline{\text{HSYNC}}$ and $\overline{\text{VSYNC}}$ are always outputs regardless of the state of the M/S bit.

○ Start (STR: bit 14)

The STR bit is used to start and stop ACRTC operation. STR is reset to 0 by ACRTC hardware \overline{RES} . Initializing of registers which control basic ACRTC operation should only be performed when STR is reset to 0.

STR	Functions
0	ACRTC display control and drawing operations are halted. \overline{DISP} , \overline{CUD} , \overline{VSYNC} , etc. go to the inactive high level. \overline{HSYNC} is set to low level, and the DRAM refresh address is output on the MAD lines regardless of the state of the RAM mode bit (bit 7 of this register). The internal time base for CRT control signals is reset.
1	ACRTC starts display and drawing operations. Drawing commands halted when STR was reset to 0 are resumed.

○ Drawing Access Priority (ACP: bit 13)

ACP determines whether or not the ACRTC executes drawing operations on the frame buffer during the display refresh period.

ACP	Functions
0	<p>Display priority mode:</p> <p>During the display period, the ACRTC halts drawing operations. thus, flashing due to simultaneous display and drawing access of the frame buffer is eliminated. Drawing operations are performed during horizontal and vertical retrace. If DRAM refresh mode is enabled (RAM bit is reset to 0) drawing is inhibited during the DRAM refresh period.</p> <p>In Interleaved Access Mode drawing can occur simultaneously with display, without 'flashing', since drawing and display access to the frame buffer is interleaved. In Superimposed Access Mode, flashless Background screen drawing may occur during idle Window display cycles.</p>
1	<p>Drawing priority mode:</p> <p>Drawing is performed during the display period. To reduce the 'flashing' effect caused by drawing-display contention the ACRTC may be programmed to drive the \overline{DISP} signals to the inactive high level during drawing operations.</p> <p>If the RAM bit is reset to 0 (DRAM refresh mode), drawing is inhibited during the DRAM refresh period.</p> <p>If the RAM bit is set to 1 (Static RAM mode), drawing is also performed during the DRAM refresh period.</p>

Note: Since the last cycle of \overline{HSYNC} low time is used as a video attribute output period, this cycle is never used for drawing regardless of the state of ACP and RAM bits.

- Window Smooth Scroll (WSS: bit 12)
WSS determines whether horizontal smooth scroll is applied to the Window screen. Window smooth scroll is only available in the Superimposed access mode. Therefore, if the Window screen is disabled, or the access mode is Single or Interleaved, WSS must be reset to 0. The horizontal smooth scroll is implemented by using four bits of SDA (Start Dot Address) programmed in the Window Start Address Register (SAR3). These bits are output on MAD12-MAD15 during the video attribute output period (last cycle of HSYNC low) and are used to control an external circuit which modifies the parallel to serial converter (shift register) timing.

WSS	Functions
0	Horizontal smooth scroll is not performed for the Window screen. One cycle Window screen prefetch does not occur.
1	Horizontal smooth scroll is performed for the Window screen. The Window display refresh cycle starts one cycle earlier than programmed in the Horizontal Window Register (HWR) Horizontal Display Start (HDS) field.

- Cursor Display Skew (CSK: bit 11 - bit 10)
CSK defines the delay time for $\overline{CUD1}$ and $\overline{CUD2}$ in units of memory cycle independent of frame buffer access mode (i.e. Single, Interleaved or Superimposed). The $\overline{CUD1}$ and $\overline{CUD2}$ skew allows compensating for delays due to frame buffer memory, character generator or other external logic access time. In the Crosshair cursor mode, CSK = 00 should not be used.

CSK		Functions
11	10	
0	0	No skew. $\overline{CUD2}$ output is always high.
0	1	$\overline{CUD1}$, $\overline{CUD2}$ are skewed by one memory cycle.
1	0	$\overline{CUD1}$, $\overline{CUD2}$ are skewed by two memory cycles.
1	1	$\overline{CUD1}$, $\overline{CUD2}$ are skewed by three memory cycles.

- DISP Skew (DSK: bit 9 - bit 8)
DSK defines the $\overline{DISP1}$, $\overline{DISP2}$ delay in units of memory cycle independent frame buffer access mode.

DSK		Functions
9	8	
0	0	No skew.
0	1	$\overline{DISP1}$, $\overline{DISP2}$ are skewed by one memory cycle.
1	0	$\overline{DISP1}$, $\overline{DISP2}$ are skewed by two memory cycles.
1	1	$\overline{DISP1}$, $\overline{DISP2}$ are skewed by three memory cycles.

○ RAM Mode (RAM: bit 7)

The RAM bit determines whether or not the ACRTC will place an 8 bit DRAM refresh address on the MAD outputs during $\overline{\text{HSYNC}}$ low. In this context, $\overline{\text{HSYNC}}$ low time is also referred to as the 'DRAM refresh period' except for the last cycle of $\overline{\text{HSYNC}}$ low, which is referred to as the 'Attribute output period'. The refresh addressing mechanism is compatible with standard 16K, 64K and 256K bit DRAMs.

RAM	Functions
0	Dynamic RAM mode: During the DRAM refresh period, the ACRTC outputs the 8 bit refresh address on MAD. Note that the particular MAD lines used for the DRAM refresh address are determined by the Graphic Address Increment (GAI) mode. The DRAM refresh address is decremented by 1 every refresh cycle.
1	Static RAM mode: No DRAM refresh address is placed on MAD. Drawing is performed during the DRAM refresh period ($\overline{\text{HSYNC}}$ low - except the attribute output period) regardless of the Access Priority (ACP) definition.

○ Graphic Address Increment mode (GAI: bit 6 - bit 4)

As described earlier, using the Graphic Bit Mode field in the Command Control Register (GBM in CCR), the number of physical frame buffer bits associated with a logical pixel can be selected as 1, 2, 4, 8 or 16.

However, when the frame buffer organization is fixed as 16 bit words, if 1 bit per pixel GBM is specified, each word contains 16 logical pixels. If 4 bits per pixel GBM is specified, each word contains only 4 logical pixels. thus, a '16 color' display compared to a monochrome display will require a 2CLK input which is 4 times faster to achieve the same logical pixel resolution.

A simple technique for solving this problem is to increase the number of frame buffer bits output for each display cycle. In the above example, if 4 words (64 bits) of frame buffer are accessed each display refresh cycle, the 'color' system 2CLK input is the same frequency as the 'monochrome' system which has equivalent logical pixel resolution.

GAI accommodates this technique and other special cases by modifying the frame buffer address increment used for each successive graphic screen display access.

GAI allows the display address increment to be 1, 2, 4 or 8 words (16-128 bits), 0 increment (display constant pattern) and increment every two display cycles (used when superimposing screens character and graphic screens).

GAI applies only to graphic screen display accesses. Graphic screen drawing accesses and character screen accesses used a fixed increment of 1 word.

GAI			Functions
6	5	4	
0	0	0	Graphic screen display address incremented by 1 every display cycle.
0	0	1	Graphic screen display address incremented by 2 every display cycle.
0	1	0	Graphic screen display address incremented by 4 every display cycle.
0	1	1	Graphic screen display address incremented by 8 every display cycle.
1	0	0	Graphic screen display address not incremented.
1	0	1	
1	1	0	
1	1	1	Graphic screen display address incremented by 1 every two display cycles.

○ Access Mode (ACM: bit 3 - bit 2)

The ACRTC provides three frame buffer access modes – Single, Interleaved and Superimposed.

ACM		Functions
3	2	
0	x	Single Access Mode: The frame buffer is accessed once every display cycle. The Window screen access has higher priority than overlapped Background screen accesses. When $ACP = 0$ (display priority mode), drawing is not performed during the display period.
1	0	Interleaved Access Mode (Dual Access Mode 0): The frame buffer is accessed twice every display cycle. Display and drawing cycles are interleaved during each phase of the display cycle. Even if $ACP = 0$ (Display priority mode), 'flashless' drawing will occur during display period. The Window screen has highest priority as in Single Access Mode.
1	1	Superimposed Access Mode (Dual Access Mode 1): The frame buffer is accessed twice every display cycle. The first phase accesses the Background screen, the second phase accesses the Window screen. In this case the Background and Window screens have equal priority, and are superimposed. Drawing is performed during the second phase in which the Window screen is not being displayed even when $ACP = 0$.

x = Don't care

Note: In Interleaved and Superimposed access modes the horizontal display width of the Background screen and the Window screen must be even. Also, for these modes, the relation between the starting position of the horizontal display on the Background screen and the starting position of the horizontal display on the Window screen must be even number/even number or odd number/odd number.

○ Raster Scan Mode (RSM: bit 1 - bit 0)

RSM selects the ACRTC raster scan mode.

RSM		Functions
1	0	
0	0	Non-Interlace Mode
0	1	
1	0	Interlace Sync Mode
1	1	Interlace Sync & Video Mode

5.7 Display Control Register (DCR: r06-r07)

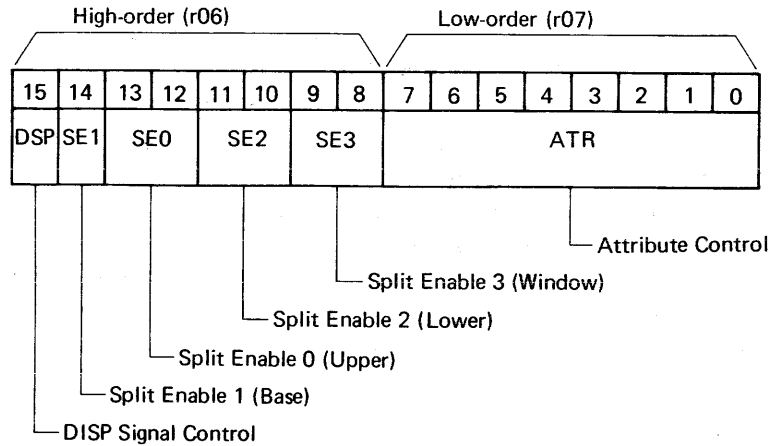


Figure 5.7 Display Control Register (DCR)

DCR controls ACRTC screen organization and 8 bits of user defined video attributes.

Logically, the ACRTC has a Background screen (Upper, Base and Lower split screens) and a Window screen. When overlapping occurs, either the Window screen has priority (Single Access Mode, Interleaved Access Mode) or the Window screen and the Background screen have equal priority (Superimposed Access Mode).

DCR allows screens to be enabled, disabled and blanked. If the Upper, Lower and Window screens are disabled, they need not be defined. The Base screen must always be defined. When screens are blanked ($\overline{\text{DISP}}$ timing output held inactive high), the display address is also inhibited. The ACRTC uses the idle frame buffer bus (MAD0-15 and MA16-19) for drawing operations.

○ $\overline{\text{DISP}}$ Signal Control (DSP: bit 15)

DSP defines the output mode of the $\overline{\text{DISP1}}$ and $\overline{\text{DISP2}}$ display timing signals.

DSP	Functions
0	$\overline{\text{DISP1}}$ is driven active low during the display period of the Background screen (combined horizontal and vertical display). $\overline{\text{DISP2}}$ is controlled similarly for the Window screen.
1	$\overline{\text{DISP1}}$ is driven active low during the horizontal display of both the Background and Window screens. $\overline{\text{DISP2}}$ is driven active low during the vertical display period of both the Background and Window screens. Thus, $\overline{\text{DISP2}}$ is high during vertical retrace. This allows another device which shares direct access to the frame buffer with the ACRTC to determine when the frame buffer is available.

○ Split Enable 1 (SE1: bit 14)

SE1 allows the Base screen (screen 1) to be blanked. Drawing can occur when the Base screen is blanked since frame buffer display access is suppressed. Note that the Base screen parameters must be defined, even if the Base screen is always blanked.

SE1	Functions
0	The ACRTC inhibits the display enable timing ($\overline{\text{DISP1}}$ and/or $\overline{\text{DISP2}}$) and display address outputs associated with the Base screen. The area of the Base screen, though blanked, remains on the CRT screen.
1	The ACRTC outputs display enable timing and display addresses for the Base screen.

○ Split Enable 0 (SE0: bit 13 - bit 12)

SE0 allows the Upper split screen (screen 0) to be enabled, disabled and blanked. If always disabled, the Upper screen parameters need not be defined. When the Upper screen is blanked, drawing may occur since frame buffer display access is suppressed.

SE0		Functions
13	12	
0	x	The ACRTC disables the Upper screen. Therefore, the Background screen contains two parts maximum – the Base and Lower screens. The Base screen is moved upward by the number of rasters in the disabled Upper screen.
1	0	The display enable timing outputs and display address outputs are inhibited for the Upper screen. The area of the Upper screen, though blanked, remains on the CRT screen.
1	1	The ACRTC outputs display enable timing and display addresses for the Upper screen.

x = Don't care

○ Split Enable 2 (SE2: bit 11 - bit 10)

SE2 allows the Lower split screen (screen 2) to be enabled, disabled and blanked. If always disabled, the Lower screen parameters need not be defined. When the Lower screen is blanked, drawing may occur since frame buffer display access is suppressed.

SE2		Functions
11	10	
0	x	The ACRTC disables the Lower screen. Therefore, the Background screen contains two parts maximum – the Base and Upper screens.
1	0	The display enable timing and display address outputs are inhibited for the Lower screen. The area of the Lower screen, though blanked, remains on the CRT screen.
1	1	The ACRTC outputs display enable timing and display addresses for the Lower screen.

x = Don't care

- Split Enable 3 (SE3: bit 9 - bit 8)
SE3 allows enabling, disabling and blanking of the Window screen (screen 3).
When disabled or blanked, the overlapped Background screens are displayed.

SE3		Functions
9	8	
0	x	The ACRTC disables the Window screen and overlapped Background screens (as defined by SE0, SE1 and SE2) are displayed. If always disabled, the Window screen parameters need not be defined. For Superimposed access mode the second (Window) phase of the display cycle is not used. The ACRTC may execute drawing operations during this second phase.
1	0	The ACRTC disables the display enable timing and display address outputs for the Window screen. The area of the Window screen, though blanked, remains on the CRT. However, Window screen parameters must be defined. For superimposed access modes, the overlapped Background screens are displayed. For Single and Interleaved access modes, the ACRTC may perform drawing during the display time for the blanked Window screen.
1	1	The ACRTC outputs the display enable timing and display addresses for the Window screen.

x = Don't care

- Attribute Control (ATR: bit 7 - bit 0)
These 8 bits can be freely programmed as user defined video attributes. These bits are output on MAD7 – MAD0 prior to the rising edge of $\overline{\text{HSYNC}}$.
When programmed dynamically, ATR allows video attributes to be controlled on a raster by raster basis.

5.8 Timing Control RAM (r80-9F)

These registers are used to define the overall screen and CRT timing signal characteristics, and parameters associated with the Base, Upper, Lower and Window screens.

- Raster Count Register (RCR)
- Horizontal Sync Register (HSR)
- Horizontal Display Register (HDR)
- Horizontal Window Register (HWR)
- Vertical Sync Register (VSR)
- Vertical Display Register (VDR)
- Split Screen Width Register (SSW)
- Vertical Window Display Register (VWR)
- Blink Control Register (BCR)
- Graphic Cursor Register (GCR)

5.8.1 Raster Count Register (RCR: r80-r81)

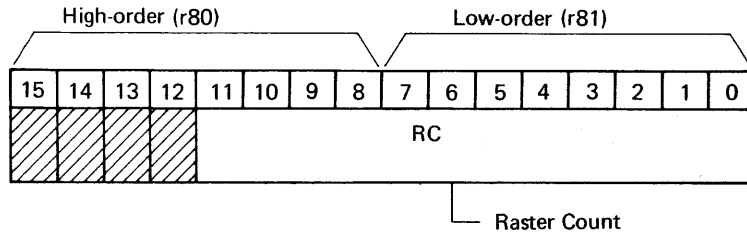


Figure 5.8 Raster Count Register (RCR)

RCR is a read-only register which contains the number of the raster currently being scanned on the CRT. Note that the initial RCR value after hardware RES is undefined. If RCR read operation is desired, the HSW (Horizontal Sync Width) should be set greater than or equal to 3. RCR should only be read when HSYNC is high.

The high order 4 bits of RCR are always 0.

RCR is updated depending on the ACRTC raster scan modes as shown.

Scan Mode	Functions
Non-Interlace	RCR starts counting at 0 and increments by 1 sequentially.
Interlace Sync	RCR starts counting at 0 and increments by 1 sequentially in both the even and odd fields. Because a dummy raster is added to the even field, the maximum raster number for the even field is one greater than that for the odd field.
Interlace Sync and Video	RCR starts counting at 0 in the even field and at 1 in the odd field, and increments by 2 sequentially in both fields. The even field always has even raster numbers and the odd field always has odd raster numbers. A dummy raster is added to the even field as in the Interlace Sync Mode.

5.8.2 Horizontal Sync Register (HSR: r82-r83)

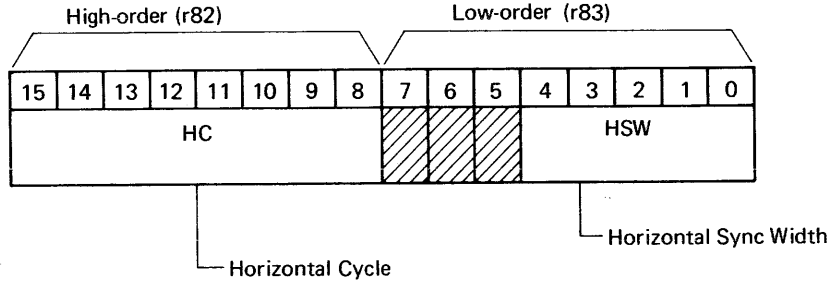


Figure 5.9 Horizontal Sync Register (HSR)

HSR defines the Horizontal Cycle (HC) and Horizontal Sync Width (HSW).

○ Horizontal Cycle (HC: bit 15 - bit 8)

HC specifies the horizontal scan time (including the horizontal retrace period) in units of memory cycles. HC is set depending on the specifications of the CRT display device. If H memory cycles are to be specified, HC should be set to H-1. When using interlaced scan modes, H should be an even number.

H C		Display (Memory cycle No.)
MSB	LSB	
0	0	1
0	1	2
}		}
1	0	255
1	1	256

○ Horizontal Sync Width (HSW: bit 4 - bit 0)

HSW specifies the HSYNC active low time in units of memory cycles. HSW is set depending on the specifications of the CRT display device. Valid values for HSW are 2 - 31. When using the RCR register, HSW must be 3 or greater. When the ACRTC DRAM refresh feature is used, DRAM refresh timing should be factored into the choice of HSW.

H S W		Pulse width (Memory cycle No.)
MSB	LSB	
0	0 0 0 0	*1
	0 0 0 1	*2
	0 0 0 1 0	2
	0 0 0 1 1	3
))
	1 1 1 1 0	30
	1 1 1 1 1	31

*1 Not used.

*2 Two memory cycles are assumed.

5.8.3 Horizontal Display Register (HDR: r84-r85)
 Horizontal Window Display Register (HWR: r92-r93)

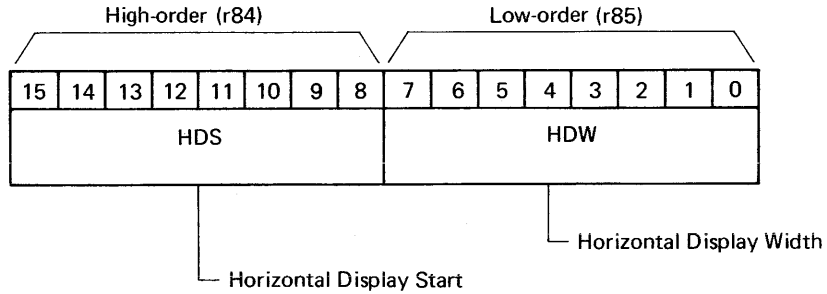


Figure 5.10 Horizontal Display Register (HDR)

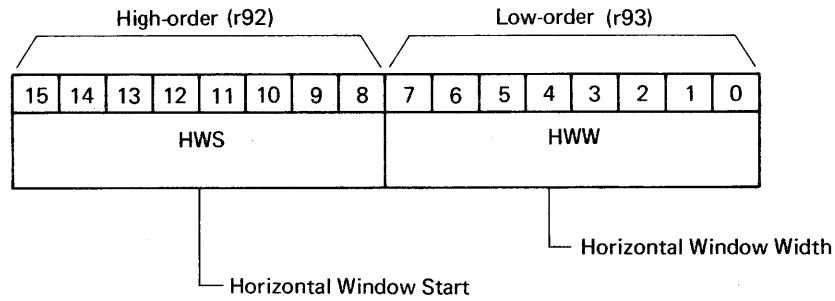


Figure 5.11 Horizontal Window Display Register (HWR)

HDR specifies the horizontal display start position and horizontal display width in units of memory cycles.

HWR specifies the horizontal Window start position and horizontal Window width in units of memory cycles.

- Horizontal Display Start (HDS: r84)
HDS defines the interval between the rising edge of $\overline{\text{HSYNC}}$ (Horizontal Front Porch) and the horizontal display starting point in units of memory cycles. If the Horizontal Display Start is HS memory cycles, HDS should be set to HS-1.
- Horizontal Window Start (HWS: r92)
HWS defines the interval between the rising edge of $\overline{\text{HSYNC}}$ and the horizontal Window display starting point in units of memory cycles. If the Horizontal Window Start is HS memory cycles, HWS should be set to HS-1.

HDS/HWS		Display width (Memory cycle No.)
MSB	LSB	
0	0	1
0	1	2
}		}
1	0	255
1	1	256

- Horizontal Display Width (HDW: r85)
HDW defines the display period for one raster in units of memory cycles. If the Horizontal Display Width is HW memory cycles, HDW should be set to HW-1.
- Horizontal Window Width (HWW: r93)
HWW defines the Window display period for one raster in units of memory cycles. If the Horizontal Window Width is HW memory cycles, HWW should be set to HW-1.

HDW/HWW		Display width (Memory cycle No.)
MSB	LSB	
0	0	1
0	1	2
}		}
1	0	255
1	1	256

5.8.4 Vertical Sync Register (VSR: r86-r87)

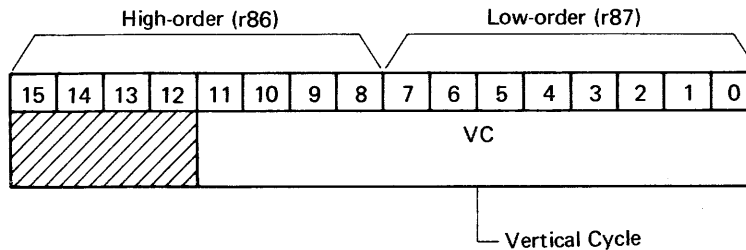


Figure 5.12 Vertical Sync Register (VSR)

VSR defines the period of the vertical scan cycle in units of rasters.

- Vertical Cycle (VC: bit 11 - bit 0)
VC defines the vertical scan cycle period (including vertical retrace) in units of rasters. VC is set depending on the specifications of the CRT display device. The way VC is programmed depends on the ACRTC raster scan mode. VC should be programmed with a non-zero value.
- Non-Interlace Mode
When the number of rasters in one frame is V , VC is set to V .
- Interlace Sync Mode
When the number of rasters in one field (even or odd) is V , VC is set to V .
The total rasters in one frame is $2V + 1$ due to one dummy raster operation.
- Interlace Sync & Video Mode
When the number of rasters in one frame (even field + odd field + dummy raster) is V , VC is set to V .

MSB	V C	LSB	Vertical cycle (Number of rasters)
	0 0 0 0 0 0 0 0 0 0 0 0 0 0 0 0		*
	0 0 0 0 0 0 0 0 0 0 0 0 0 0 0 1		1
	0 0 0 0 0 0 0 0 0 0 0 0 0 0 1 0		2
))
	1 1 1 1 1 1 1 1 1 1 1 1 1 1 1 0		4094
	1 1 1 1 1 1 1 1 1 1 1 1 1 1 1 1		4095

* VC = 0 cannot be used.

5.8.5 Vertical Display Register (VDR: r88-r89)

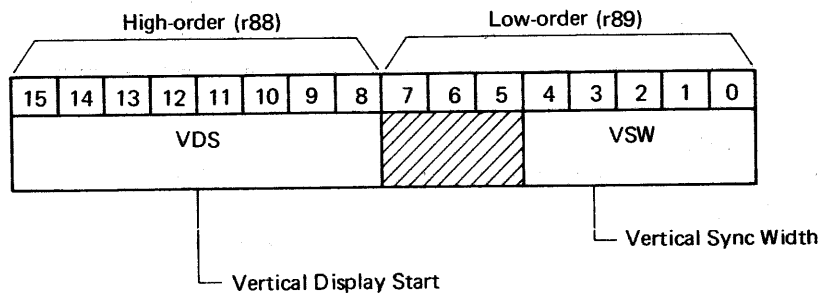


Figure 5.13 Vertical Display Register (VDR)

VDR defines vertical sync width ($\overline{\text{VSYNC}}$ low period) and vertical display start and width in units of rasters.

- Vertical Sync Width (VSW: r89 bit 4 - bit 0)
VSW defines $\overline{\text{VSYNC}}$ low pulse width in units of rasters. VSW is set depending on the CRT display device specification. VSW should be set to a non-zero value.

V S W		Pulse width (Number of raster)
MSB	LSB	
0	0 0 0 0	*
	0 0 0 0 1	1
	0 0 0 1 0	2
	}	}
	1 1 1 1 0	30
	1 1 1 1 1	31

* VSW = 0 cannot be used.

○ Vertical Display Start (VDS: r88)

VDS defines the period from the rising edge of \overline{VSYNC} to the vertical display start position in units of rasters. If the vertical display start position is the VS raster, VDS is set to VS-1. The way to program VDS depends on ACRTC raster scan modes as described for VSR (r86-r87).

V D S		Display start (Number of rasters)
MSB	LSB	
0	0 0 0 0 0 0 0 0	1
	0 0 0 0 0 0 0 1	2
	}	}
	1 1 1 1 1 1 1 0	255
	1 1 1 1 1 1 1 1	256

5.8.6 Vertical Window Display Register
(VWR: r94-r97)

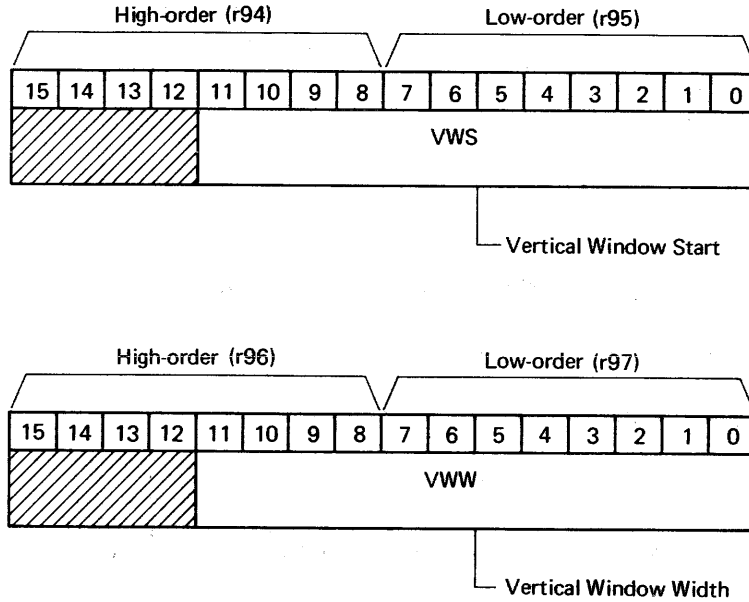


Figure 5.14 Vertical Window Display Register (VWR)

VWR is a read/write register that defines the vertical Window start position and width in units of rasters.

○ Vertical Window Start (VWS: r94-r95)

VWS defines the period from the rising edge of $\overline{\text{VSYNC}}$ to the vertical Window start position in units of rasters. When the vertical Window start position is the VS raster, VWS is set to VS-1. Note that VWS must be greater than or equal to VDS.

V W S		Display start position (Number of rasters)
MSB	LSB	
0	0	1
0	1	2
}		}
1	0	4095
1	1	4096

- Vertical Window Width (VWW; r96-r97)
VWW defines the vertical display period of the Window screen in units of rasters. When the vertical window width is VW rasters, VWW is set to VW.

MSB	V W W	LSB	Display width (Number of rasters)
0	0 0 0	0 0 0 0 0 0 0 0 0 0 0 0	*
0	0 0 0	0 0 0 0 0 0 0 0 0 0 0 1	1
0	0 0 0	0 0 0 0 0 0 0 0 0 0 1 0	2
))
1	1 1 1	1 1 1 1 1 1 1 1 1 1 1 0	4094
1	1 1 1	1 1 1 1 1 1 1 1 1 1 1 1	4095

* VWW = 0 cannot be used.

5.8.7 Split Screen Width Register (SSW: r8A-r8F)

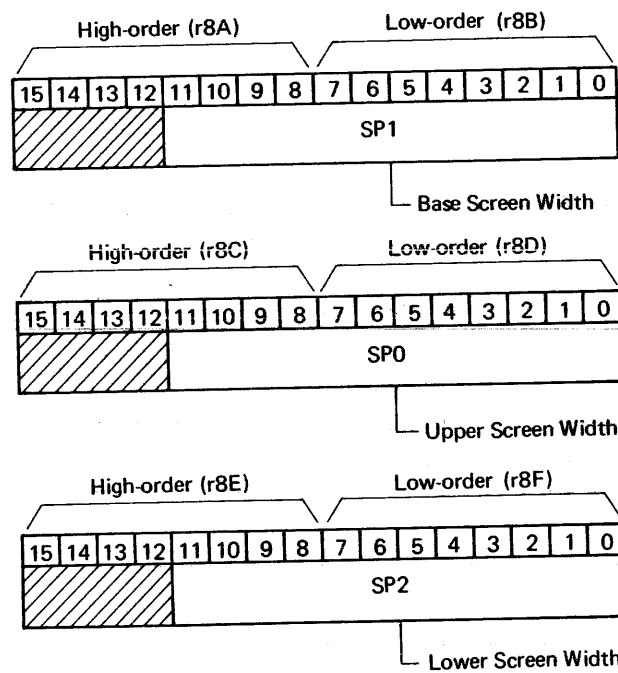


Figure 5.15 Split Screen Width Register (SSW)

SSW defines the vertical width of the Upper (split screen 0), Base (split screen 1) and Lower (split screen 2) screens.

- Split Screen Width (SP0: r8C-r8D bit 11 - bit 0)
 (SP1: r8A-r8B bit 11 - bit 0)
 (SP2: r8E-r8F bit 11 - bit 0)

SP0, SP1 and SP2 define the vertical display period of the Upper, Base and Lower screens respectively in units of rasters. If the vertical screen width is SW rasters, SP0/SP1/SP2 are set to SW.

SP0/SP1/SP2		Display width (Number of rasters)
MSB	LSB	
0 0 0 0 0 0 0 0 0 0 0 0		*
0 0 0 0 0 0 0 0 0 0 0 1		1
0 0 0 0 0 0 0 0 0 0 1 0		2
))
1 1 1 1 1 1 1 1 1 1 1 0		4094
1 1 1 1 1 1 1 1 1 1 1 1		4095

* SP0/SP1/SP2 = 0 cannot be used.

5.8.8 Blink Control Register (BCR: r90-r91)

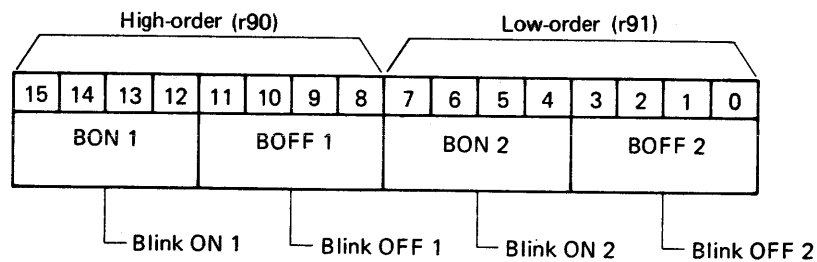


Figure 5.16 Blink Control Register (BCR)

BCR defines the blink on and off period for the BLINK1 and BLINK2 video attributes. BLINK1 and BLINK2 are output on MA18 and MA19 during each rasters video attribute output cycle.

- Blink ON (BON1: r90 bit 15 - bit 12)
(BON2: r91 bit 7 - bit 4)

BON(1/2) defines the BLINK(1/2) attribute active high (ON) period. The unit is 4 field periods. BLINK(1/2) is always low (OFF) when BON(1/2) = 0 is programmed.

BON1				Blink "High" level (Field)
15	14	13	12	
0	0	0	0	*
0	0	0	1	8
0	0	1	0	12
0	0	1	1	16
0	1	0	0	20
0	1	0	1	24
0	1	1	0	28
0	1	1	1	32
1	0	0	0	36
1	0	0	1	40
1	0	1	0	44
1	0	1	1	48
1	1	0	0	52
1	1	0	1	56
1	1	1	0	60
1	1	1	1	64

BON2				Blink "High" level (Field)
7	6	5	4	
0	0	0	0	*
0	0	0	1	8
0	0	1	0	12
0	0	1	1	16
0	1	0	0	20
0	1	0	1	24
0	1	1	0	28
0	1	1	1	32
1	0	0	0	36
1	0	0	1	40
1	0	1	0	44
1	0	1	1	48
1	1	0	0	52
1	1	0	1	56
1	1	1	0	60
1	1	1	1	64

* BLINK is always "Low"

- Blink OFF (BOFF1: r90 bit 11 - bit 8)
(BOFF2: r91 bit 3 - bit 0)

BOFF(1/2) defines the BLINK(1/2) attribute active low (OFF) period. the unit is 4 field periods. BLINK(1/2) is always high (ON) when BON(1/2) \neq 0 and BOFF(1/2) = 0 are programmed.

BOFF1				Blink "Low" level (Field)
11	10	9	8	
0	0	0	0	*
0	0	0	1	8
0	0	1	0	12
0	0	1	1	16
0	1	0	0	20
0	1	0	1	24
0	1	1	0	28
0	1	1	1	32
1	0	0	0	36
1	0	0	1	40
1	0	1	0	44
1	0	1	1	48
1	1	0	0	52
1	1	0	1	56
1	1	1	0	60
1	1	1	1	64

BOFF2				Blink "Low" level (Field)
3	2	1	0	
0	0	0	0	*
0	0	0	1	8
0	0	1	0	12
0	0	1	1	16
0	1	0	0	20
0	1	0	1	24
0	1	1	0	28
0	1	1	1	32
1	0	0	0	36
1	0	0	1	40
1	0	1	0	44
1	0	1	1	48
1	1	0	0	52
1	1	0	1	56
1	1	1	0	60
1	1	1	1	64

* In the case of BON(1/2) \neq 0, BLINK(1/2) will always become "HIGH" level.

5.8.9 Graphic Cursor Register (GCR: r98-r9D)

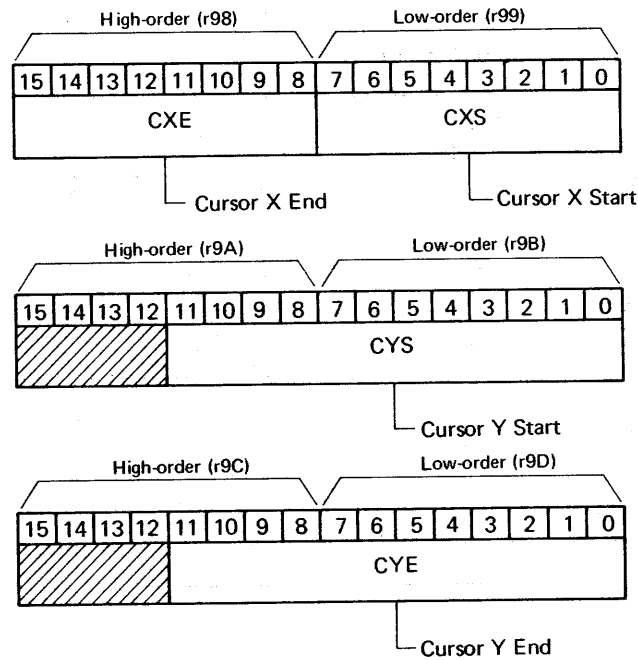


Figure 5.17 Graphic Cursor Register (GCR)

GCR defines the horizontal and vertical start and end positions for displaying a graphic cursor.

- **Cursor X Start (CXS: r99)**
CXS defines the horizontal cursor start position from the falling edge of $\overline{\text{HSYNC}}$ in units of memory cycles.
- **Cursor X End (CXE: r98)**
CXE defines the horizontal cursor end position from the falling edge of $\overline{\text{HSYNC}}$ in units of memory cycles.
- **Cursor Y Start (CYS: r9A, r9B bit 11 - bit 0)**
CYS defines the vertical cursor start position from the rising edge of $\overline{\text{VSYNC}}$ in units of rasters.
- **Cursor Y End (CYE: r9C, r9D bit 11 - bit 0)**
CYE defines the vertical cursor end position from the rising edge of $\overline{\text{VSYNC}}$ in units of rasters.

5.8.10 ACRTC Working Register (r9E-9F)

Internal ACRTC work area. The host MPU must never access this register.

5.9 Display Control RAM (rCO-rEF)

The Display Control RAM are registers containing parameters used by the ACRTC address generation logic. There are four sets of Raster Address, Memory Width and Start Address registers providing independent control for each of the four logical screens (Upper, Base, Lower and Window). Also, the Cursor Definition Register contains information for two separate cursors.

- Raster Address Registers (RAR0-RAR3)
- Memory Width Registers (MWR0-MWR3)
- Start Address Registers (SAR0-SAR3)
- Block Cursor Register (BCR)
- Cursor Definition Register (CDR)
- Zoom Factor Register (ZFR)
- Light Pen Address Register (LPAR)

5.9.1 Raster Address Register

(RAR0: rC0-rC1) (RAR1: rC8-rC9)

(RAR2: rD0-rD1) (RAR3: rD8-rD9)

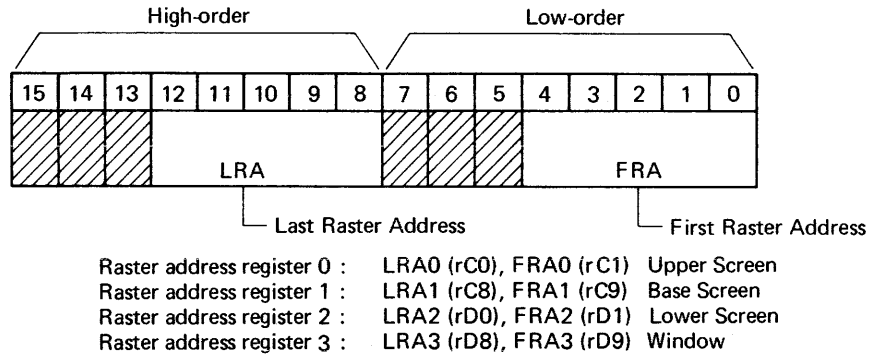


Figure 5.18 Raster Address Register (RAR)

RAR specifies the raster addressing per character row (including line spacing) for character screens (CHR = high). RAR0-3 apply to screens 0-3, the Upper, Base, Lower and Window screens respectively.

○ First Raster Address (FRA: bit 4 - bit 0)

FRA determines the first raster line address of the character row, and can be set to any value between 0 and 31.

FRA					Raster address
4	3	2	1	0	
0	0	0	0	0	0
0	0	0	0	1	1
}					}
1	1	1	1	0	30
1	1	1	1	1	31

- Last Raster Address (LRA: bit 12 - bit 8)
LRA determines the last raster line address of the character row, and can be set to any value between 0 and 31.

LRA					Raster address
12	11	10	9	8	
0	0	0	0	0	0
0	0	0	0	1	1
}					}
1	1	1	1	0	30
1	1	1	1	1	31

The number of raster lines per character row is determined by the relation between FRA and LRA and also depends on the raster scan mode. In the following examples, FRA (=3) represents the first raster address in the even field. Note that the relation between FRA and LRA is not restricted. FRA can be less, equal or greater than LRA as shown below. In this example, non-interlace mode is used.

i) Non-interlace mode

03 _____ FRA:03
 04 _____ LRA:08
 05 _____ Number of rasters:6
 06 _____
 07 _____
 08 _____

ii) Interlace sync mode

Even field	Odd field	
03 _____	_____ 03	FRA:03
04 _____	_____ 04	LRA:08
05 _____	_____ 05	Number of rasters:12
06 _____	_____ 06	
07 _____	_____ 07	
08 _____	_____ 08	

iii) Interlace sync & Video mode

Even field	Odd field	
03 _____	_____ 04	FRA:03
05 _____	_____ 06	LRA:08
07 _____	_____ 08	Number of rasters:6

FRA < LRA

03 _____ FRA
 04 _____
 05 _____
 06 _____
 07 _____
 08 _____ LRA

FRA = LRA

10 _____ FRA
 LRA

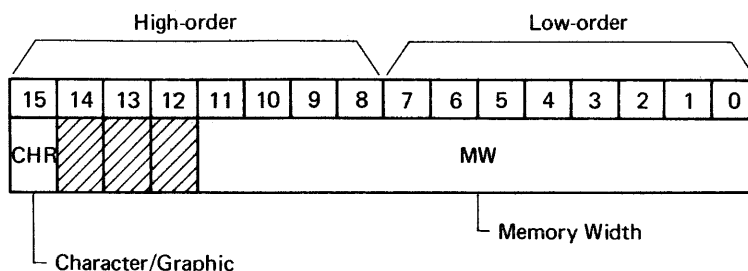
FRA > LRA

30 _____ FRA
 31 _____
 00 _____
 01 _____
 02 _____
 03 _____ LRA

5.9.2 Memory Width Register

(MWR0: rC2-rC3) (MWR1: rCA-rCB)

(MWR2: rD2-rD3) (MWR3: rDA-rDB)



Memory Width Register 0 rC2 rC3 : Upper Screen
 Memory Width Register 1 rCA rCB : Base Screen
 Memory Width Register 2 rD2 rD3 : Lower Screen
 Memory Width Register 3 rDA rDB : Window Screen

Figure 5.19 Memory Width Register (MWR)

MWR defines the number of physical 16 bit frame buffer words which comprise all logical pixel X addresses for a single Y address. For example, if a screen is defined with 1024 logical pixel range in the X direction (X may vary from 0 to 1023), and 4 bits per pixel are assumed, that screen's MWR value should be 256.

MWR also determines whether the defined screen is a Character (CHR = high) or Graphic (CHR = low) screen. MWR0-3 apply to screens 0-3, the Upper, Base, Lower and Window screen respectively.

MWR should be greater than or equal to Horizontal Display Width (HDW - r85). MWR must be greater than HDW to perform horizontal smooth scroll. MWR maximum value is 4096.

○ Character/Graphic (CHR: bit 15)

CHR	Functions
0	The screen is defined as GRAPHIC
1	The screen is defined as CHARACTER

○ Memory Width (MW: bit 11 - bit 0)

11	M W	0	Memory width (Number of words)
	0 0 0 0 0 0 0 0 0 0 0 0		0
	0 0 0 0 0 0 0 0 0 0 0 1		1
))
	1 1 1 1 1 1 1 1 1 1 1 0		4094
	1 1 1 1 1 1 1 1 1 1 1 1		4095

5.9.3 Start Address Register
 (SAR0: rC4-rC7) (SAR1: rCC-rCF)
 (SAR2: rD4-rD7) (SAR3: rDC-rDF)

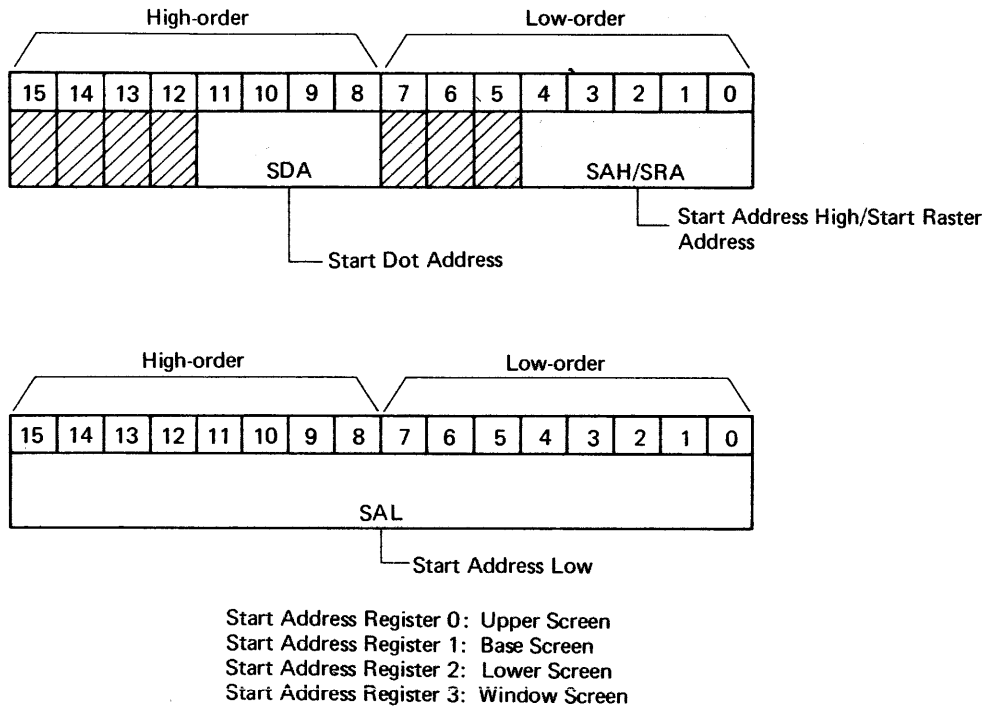


Figure 5.20 Start Address Register (SAR)

SAR defines the first frame buffer address for each screen. SAR0-3 apply to screens 0-3, the Upper, Base, Lower and Window screens respectively.

Screens defined as Character have a 64K by 16 bit physical address space. Screens defined as Graphic have a 1M by 16 bit physical address space. In either case, SAR can take on any address. Frame Buffer addresses will 'wraparound' to 0 when the physical address space limit is reached independent of split screen position.

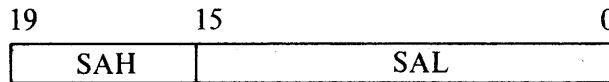
- Start Address Low (SAL: bit 15 - bit 0)
For Character screens, SAL contains the 16 bit start address. For Graphic screens, SAL contains the least significant 16 bits of the 20 bit start address.
- Start Address High (SAH: bit 3 - bit 0)
Start Raster Address (SRA: bit 4 - bit 0)
For Character screens, SRA provides the 5 bit (0-31) start raster address.

i) Character Screen

04 _____ SRA
 05 _____
 06 _____
 07 _____ LRA
 02 _____ FRA
 03 _____
 04 _____
 05 _____
 06 _____
 07 _____ LRA
 02 _____ FRA

For Graphic screens, SAH provides the most significant 4 bits of the 20 bit start address.

ii) Graphic Screen



Increment or decrement of SRA provides vertical smooth scroll with no additional external hardware.

- Start Dot Address (SDA: bit 11 - bit 8)
SDA is used to define a start dot horizontal offset (0-15). the contents of SDA are output on HSD0-3 (MAD8-11) during the video attribute output cycle of each horizontal scan. External circuitry which controls the parallel-serial converter (shift register) load and clock based on SDA and the corresponding HSD outputs allows horizontal smooth scroll for both Character and Graphic screens.

5.9.4 Block Cursor Register (BCUR: rE0-rE7)

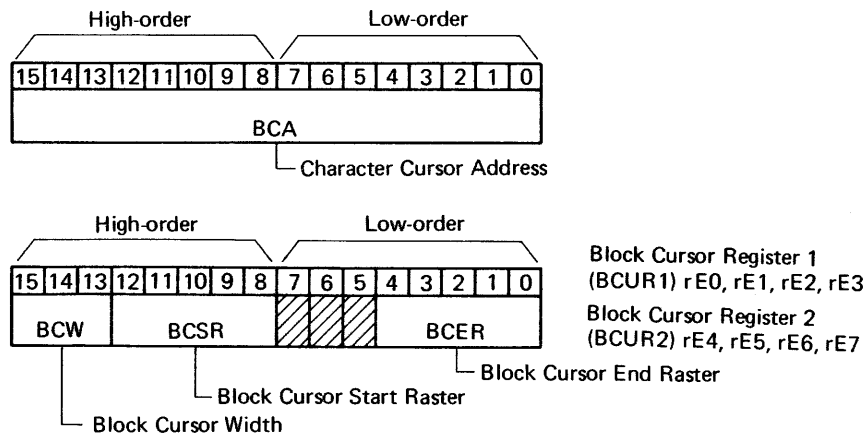


Figure 5.21 Block Cursor Register (BCUR)

BCUR defines the block cursor location (frame buffer physical memory address), start and end raster and block cursor length for two independent cursors. Depending on cursor mode, the ACRTC CUD1 and CUD2 lines can support the simultaneous display of both block cursors.

Should two (or more) screens be defined to contain the same frame buffer memory address, if the block cursor is located at that address, it will be displayed on both screens.

- Block Cursor Address (BCA1: rE2-rE3) (BCA2: rE6-rE7)
BCA defines the 16 bit address for the block cursor. Note that the block cursor is only enabled for Character screens (CHR = high).

- Block Cursor Start Raster (BCSR: bit 12 - bit 8)
BCSR determines the 5 bit block cursor start raster address (0-31).
- Block Cursor Width (BCW: bit 15 - bit 13)
BCW defines the block cursor width (1-8) in units of memory cycles.

B C W			Cursor width (Memory cycle)
15	14	13	
0	0	0	1
0	0	1	2
	}		}
1	1	0	7
1	1	1	8

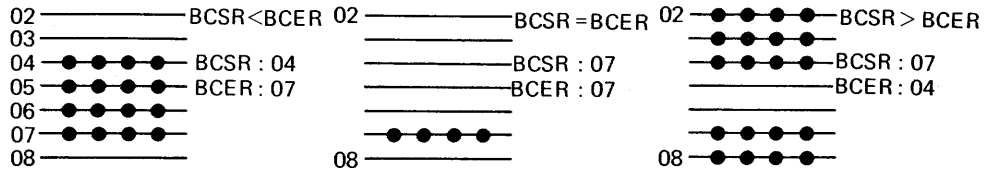
B C S R					Raster address
12	11	10	9	8	
0	0	0	0	0	0
0	0	0	0	1	1
		}			}
1	1	1	1	0	30
1	1	1	1	1	31

- Block Cursor End Raster (BCER: bit 4 - bit 0)
BCER determines the 5 bit block cursor end raster address (0-31).

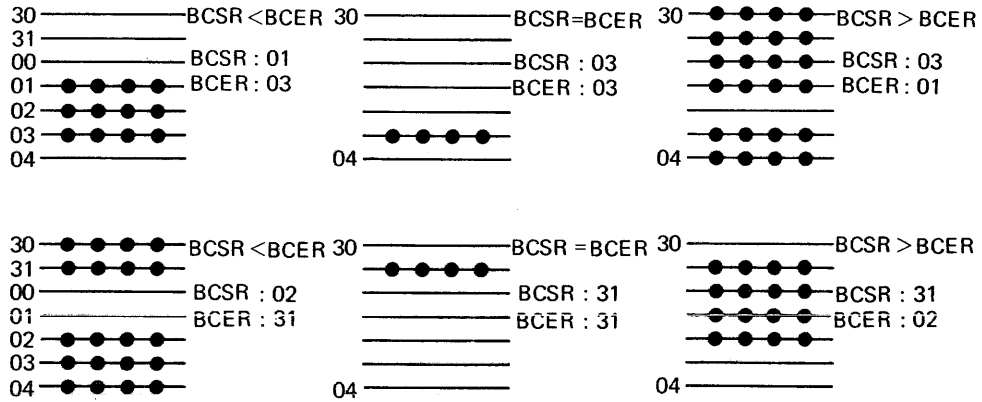
B C E R					Raster address
4	3	2	1	0	
0	0	0	0	0	0
0	0	0	0	1	1
		}			}
1	1	1	1	0	30
1	1	1	1	1	31

Based on FRA, LRA, BCSR and BCER, the block cursor can take on a number of different configurations as shown below.

FRA ≤ LRA (FRA:02, LRA:08)



FRA > LRA (FRA:30, LRA:04)



5.9.5 Cursor Definition Register (CDR: rE8-rE9)

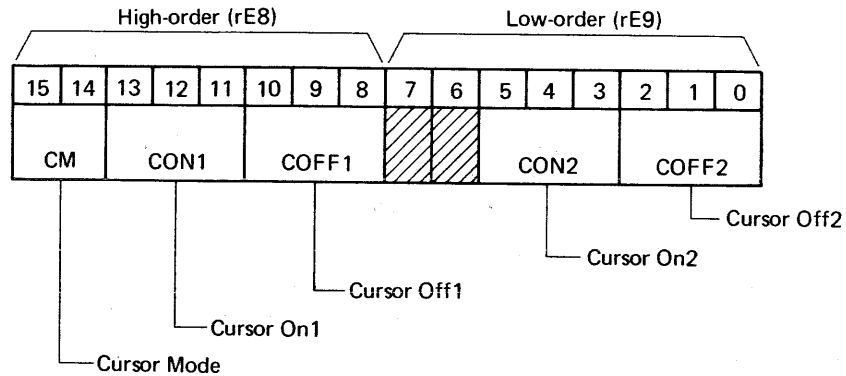


Figure 5.22 Cursor Definition Register

CDR defines the cursor types and the way in which the $\overline{CUD1}$ and $\overline{CUD2}$ outputs are controlled. Depending on CDR, up to three cursors may be simultaneously displayed. Cursor types are defined as follows.

BLOCK – The standard ‘block’ type (including underline) cursor typically used on alphanumeric displays.

GRAPHIC – The ACRTC may generate a rectangular cursor area of arbitrary X and Y dimension. Normally, this is used to enable an external cursor bit map circuit. In this case, the cursor may take on any user defined graphic shape.

CROSSHAIR – The ACRTC can display a crosshair cursor. The X and Y (horizontal and vertical) dimensions are independently programmable.

- Cursor Mode (CM: rE8 bit 15 - bit 14)
CM defines the type of cursor(s) to be displayed and the way in which the $\overline{\text{CUD1}}$ and $\overline{\text{CUD2}}$ outputs are interpreted.

CM		Functions
15	14	
0	x	Block Cursor Mode: Block cursor 1 (defined in BCR1) is output on $\overline{\text{CUD1}}$. Block cursor 2 (defined in BCR2) is output on $\overline{\text{CUD2}}$. The Graphic cursor (defined in GCR) is not used.
1	0	Graphic Cursor Mode: Graphic Cursor (GCR) is output on $\overline{\text{CUD1}}$. Block cursor 1 and 2 are combined and output on $\overline{\text{CUD2}}$.
1	1	Crosshair Cursor Mode: The horizontal element is output on $\overline{\text{CUD1}}$. The vertical element is output on $\overline{\text{CUD2}}$. The Block cursor (BCR) is not used.

x = Don't care.

- Cursor ON (CON1: rE8 bit 13 - bit 11)
(CON2: rE9 bit 5 - bit 3)

Cursor OFF (COFF1: rE8 bit 10 - bit 8)
(COFF2: rE9 bit 2 - bit 0)

CON and COFF determine the cursor blink timing. CON1/COFF1 apply to $\overline{CUD1}$ and CON2/COFF2 apply to $\overline{CUD2}$. The unit time is 4 field periods. In Crosshair Cursor Mode, CON1/COFF1 is used for blink timing and CON2/COFF2 are not used.

CON1			Blink "High" level (Field period)
13	12	11	
0	0	0	*
0	0	1	8
0	1	0	12
0	1	1	16
1	0	0	20
1	0	1	24
1	1	0	28
1	1	1	32

CON2			Blink "High" level (Field period)
5	4	3	
0	0	0	*
0	0	1	8
0	1	0	12
0	1	1	16
1	0	0	20
1	0	0	24
1	1	0	28
1	1	1	32

* Cursor is output at "Low" level.

COFF1			Blink "Low" level (Field period)
10	9	8	
0	0	0	*
0	0	1	8
0	1	0	12
0	1	1	16
1	0	0	20
1	0	1	24
1	1	0	28
1	1	1	32

COFF2			Blink "Low" level (Field period)
2	1	0	
0	0	0	*
0	0	1	8
0	1	0	12
0	1	1	16
1	0	0	20
1	1	0	24
1	1	0	28
1	1	1	32

* If "CON=000" is set, cursor is output at "High" level.

5.9.6 Zoom Factor Register (ZFR: rEA)

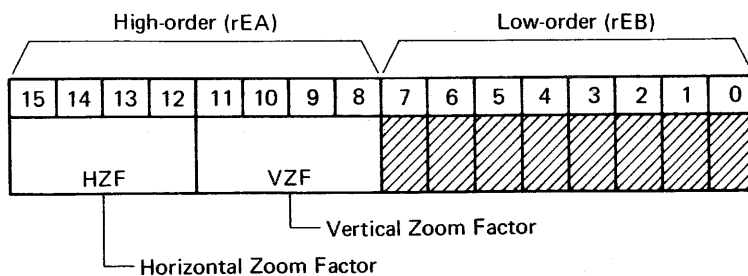


Figure 5.23 Zoom Factor Register (ZFR)

ZFR determines the horizontal (memory cycle) and vertical (raster) multipliers (1 to 16) for zooming up. Zooming can only be applied to the Base screen. HZF and VZF should be set to 0 for no-zoom, and \$F for 16 times zoom.

- Horizontal Zoom Factor (HZF: bit 15 - bit 12)
HZF defines the horizontal zoom factor in units of memory cycles. The ACRTC will output a same display address by HZF times. HZF is output as video attributes on MAD12-15 lines for use by an external circuit which controls shift clock timing.

H Z F				Factor of zooming up in the horizontal director (Magnitude)
15	14	13	12	
0	0	0	0	1
0	0	0	1	2
				}
1	1	1	0	15
1	1	1	1	16

- Vertical Zoom Factor (VZF: bit 11 - bit 8)
VZF defines the vertical zoom factor. The ACRTC performs the vertical zoom by modifying its frame buffer address (Graphic screens) or raster address (Character screens) so that multiples of the same raster data are displayed.

V Z F				Factor of zooming up in the vertical director (Magnitude)
11	10	9	8	
0	0	0	0	1
0	0	0	1	2
				}
1	1	1	0	15
1	1	1	1	16

5.9.7 Light Pen Address Register (LPAR: rEC-rEF)

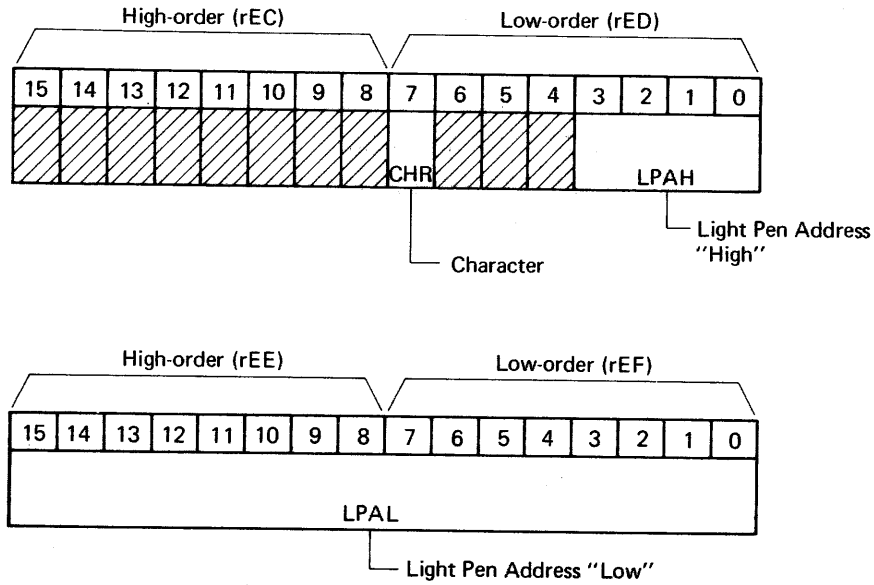


Figure 5.24 Light Pen Address Register (LPAR)

LPAR is a read only register. When the ACRTC LPSTB input is asserted, the current display address is latched into LPAR. The value in LPAR will differ from the actual display address under the light pen depending on various hardware delay times. Thus, the LPAR value should be adjusted by MPU software depending on system configuration. In Superimposed access mode, light pen strobes which occur within a superimposed Window/Background display cause the Background address to be latched.

- Character/Graphic (CHR: rED bit 7)

CHR indicates whether the latched display address corresponds to a screen defined as Character or Graphic.

CHR	Functions
0	LPAR contains Graphic screen address
1	LPAR contains Character screen address

- Light Pen Address High (LPAH: rED bit 3 - bit 0)
LPAH is only valid if CHR = 0 and contains the most significant 4 bits of the 20 bit Graphic screen display address.
- Light Pen Address Low (LPAL: rEE-rEF)
If CHR = 0, LPAL contains the least significant 16 bits of the 20 bit Graphic screen display address. If CHR = 1, LPAL contains the 16 bit Character screen display address.

5.10 Drawing Control Registers

The ACRTC refers to a number of registers during graphic drawing operations.

- a) Pattern RAM
- b) Drawing Parameter Registers
 - Color 0 Register (CL0)
 - Color 1 Register (CL1)
 - Color Comparison Register (CCMP)
 - Edge Color Register (EDG)
 - Mask Register (MASK)
 - Pattern RAM Control Register (PRC)
 - Area Definition Register (ADR)
 - Read/Write Pointer (RWP)
 - Drawing Pointer (DP)
 - Current Pointer (CP)

The Pattern RAM is accessed using the Read and Write Pattern (RPTN, WPTN) commands. The Drawing Parameter Registers are accessed using the Read and Write Parameter Register (RPR, WPR) commands.

5.10.1 Pattern RAM

The ACRTC includes 32 byte pattern RAM. The Pattern RAM is used for pre-defining data for the graphic drawing operations.

A 16 by 16 bit pattern (or 16 sets of 16 by 1 bit) can be stored in the Pattern RAM as a binary representation of screen data. In this case, a two entry color 'palette' corresponding to 0 and 1 data values is defined using the Color 0 (CL0) and Color 1 (CL1) registers.

To store color patterns in the Pattern RAM it is divided into four equal segments of either 4 by 4 bit patterns or 4 sets of 4 by 1 bit patterns. In this case, during drawing the color coded contents of the Pattern RAM are directly written to the frame buffer. The particular segment used is defined by the Pattern RAM Control register (PRC).

When multiple drawing commands use a common pattern, pattern continuity can be achieved by adjusting the pattern scanning pointer.

5.10.2 Drawing Parameter Registers

Register No.	Read/Write	Name of Register	Abbr.	Data (H)								Data (L)							
				15	14	13	12	11	10	9	8	7	6	5	4	3	2	1	0
Pr00	R/W	Color 0	CLO	CLO															
Pr01	R/W	Color 1	CL1	CL1															
Pr02	R/W	Color Comparison	CCMP	CCMP															
Pr03	R/W	Edge Color	EDG	EDG															
Pr04	R/W	Mask	MASK	MASK															
Pr05	R/W	Pattern RAM Control	PRC	PPY	PZCY				PPX	PZCX									
↓				PSY					PSX										
Pr07				PSE	PZY				PEX	PZX									
Pr08	R/W	Area Definition **	ADR	XMIN															
↓				YMIN															
				XMAX															
Pr0B				YMAX															
Pr0C	R/W	Read Write Pointer	RWP	DN					RWPH										
Pr0D				RWPL															
Pr0E	—	—	—															
Pr0F	—	—	—															
Pr10	R	Drawing Pointer	DP	DN					DPAH										
Pr11				DPAL								DPD							
Pr12	R	Current Pointer **	CP	X															
Pr13				Y															
Pr14	—	—	—															
Pr15	—	—	—															

- * R Register readable by a Read Parameter Register (RPR) command
- W Register writable by a Write Parameter Register (WPR) command
- Access is not allowed
- ▒ Always set to "0"
- ** Set binary complements for negative values of X and Y axis.

Figure 5.25 Drawing Parameter Registers

5.10.2.1 Color 0 Register (CL0: Pr00)

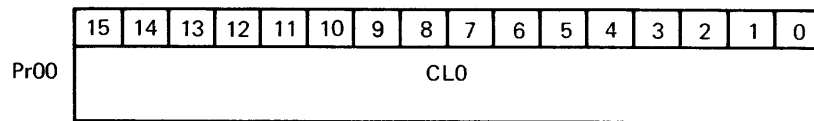


Figure 5.26 Color Register 0 (CL0)

When logical drawing data = 0 in the pattern RAM, the contents of CL0 are stored in the frame buffer.

5.10.2.2 Color 1 Register (CL1: Pr01)

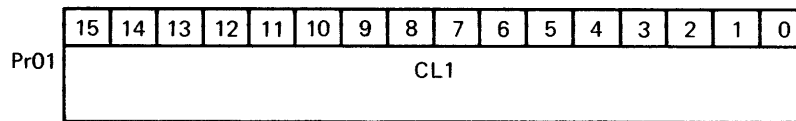


Figure 5.27 Color Register 1 (CL1)

When logical drawing data = 1 in the pattern RAM, the contents of CL1 are stored in the frame buffer.

5.10.2.3 Color Comparison Register (CCMP: Pr02)

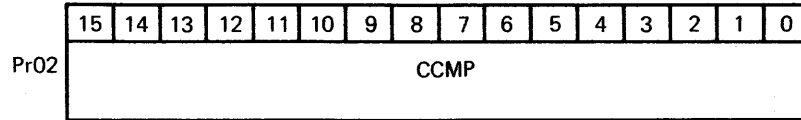


Figure 5.28 Color Comparison Register (CCMP)

CCMP defines a comparison color for use with conditional drawing operations. Conditional drawing applies various logical comparisons between the drawing data and CCMP to determine if drawing should occur.

5.10.2.4 Edge Color Register (EDG: Pr03)

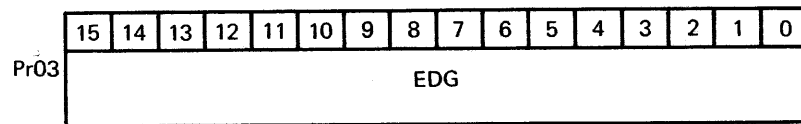


Figure 5.29 Edge Color Register (EDG)

EDG defines the boundary edge color for use by the PAINT command. In one mode, the edge is defined as the color contained in EDG. In another mode, the edge is defined as any color except the color contained in EDG.

5.10.2.5 Mask Register (MASK: Pr04)

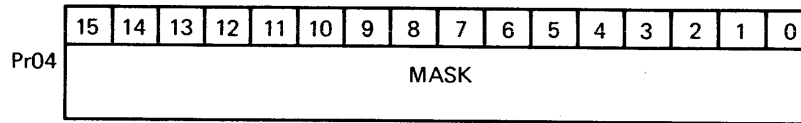


Figure 5.30 Mask Register (MASK)

When performing data transfer and drawing of the frame buffer, MASK is used to mask bits upon which drawing and other logical operations should not be performed. If MASK bit is 0, the corresponding frame buffer bit is excluded from logic operation.

Note: Only DMOD, MOD, SCLR and SCPY command can use the MASK Register.

5.10.2.6 Pattern RAM Control Register (PRC: Pr05 - Pr07)

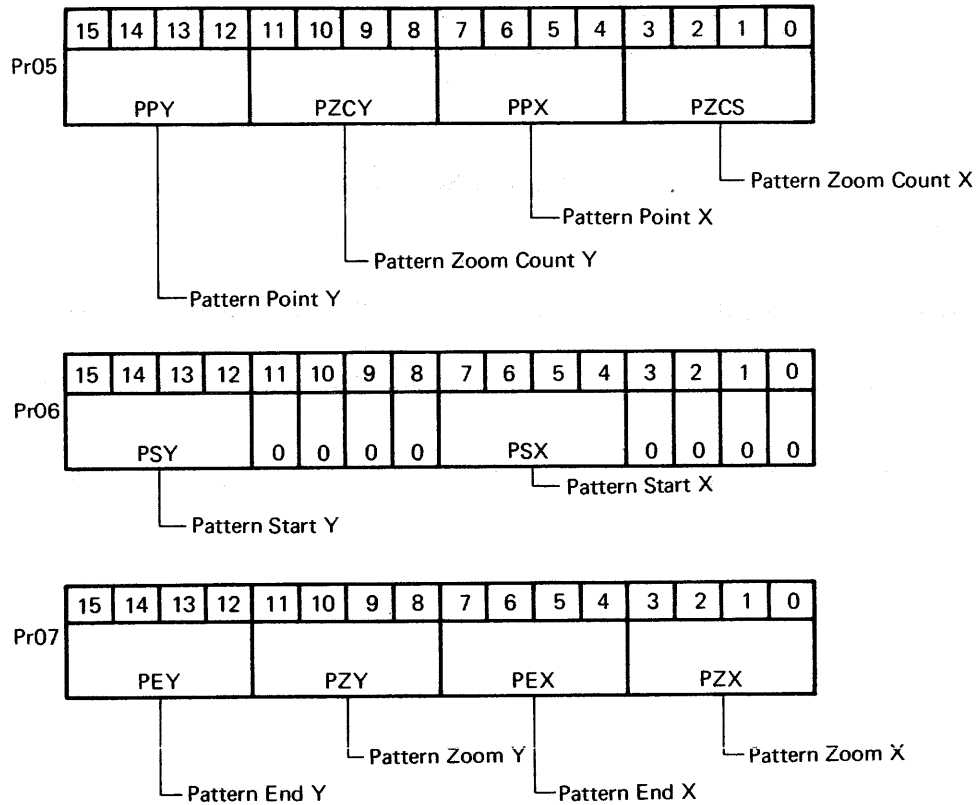


Figure 5.31 Pattern RAM Control Register (PRC)

PRC specifies the size of the patterns used for drawing and the start point within the Pattern RAM for the pattern scan. The pattern size can be independently specified in the X and Y dimensions (maximum 16 by 16 bits).

- Pattern Start X (PSX: Pr06 bit 7 - bit 4)
 Pattern Start Y (PSY: Pr06 bit 15 - bit 12)
 PSX and PSY specify the pattern scan starting point horizontal and vertical addresses respectively. These should be set to between 0-15 for Color Register indirect drawing and between 0-3 for Pattern RAM direct drawing.
- Pattern End X (PEX: Pr07 bit 7 - bit 4)
 Pattern End Y (PEY: Pr07 bit 15 - bit 8)
 PEX and PEY specify the pattern scan ending point horizontal and vertical addresses respectively. These should be set to between 0-15 for Color Register indirect drawing and between 0-3 for Pattern RAM direct drawing.
- Pattern Zoom X (PZX: Pr07 bit 3 - bit 0)
 Pattern Zoom Y (PZY: Pr07 bit 11 - bit 8)
 PZX and PZY specify the magnification coefficient applied to the contents of the Pattern RAM. PZX, PZY = 0 specifies by 1 magnification (no magnification) while PZX, PZY = \$F specifies by 16 magnification.
- Pattern Zoom Count X (PZCX: Pr05 bit 3 - bit 0)
 Pattern Zoom Count Y (PZCY: Pr05 bit 11 - bit 8)
 PZCX and PZCY specify the initial magnification counter values in the horizontal and vertical dimensions respectively.
 Normally, PZCX and PZCY should be set to 0.
- Pattern Pointer X (PPX: Pr05 bit 7 - bit 4)
 Pattern Pointer Y (PPY: Pr05 bit 15 - bit 8)
 The current reference point within the Pattern RAM is specified by PPX and PPY. When using PPX, PPY to define a pattern scan starting point, the relationship $PSX \leq PPX \leq PEX$ and $PSY \leq PPY \leq PEY$ must be maintained.

5.10.2.7 Area Definition Register (ADR: Pr08 - Pr0B)

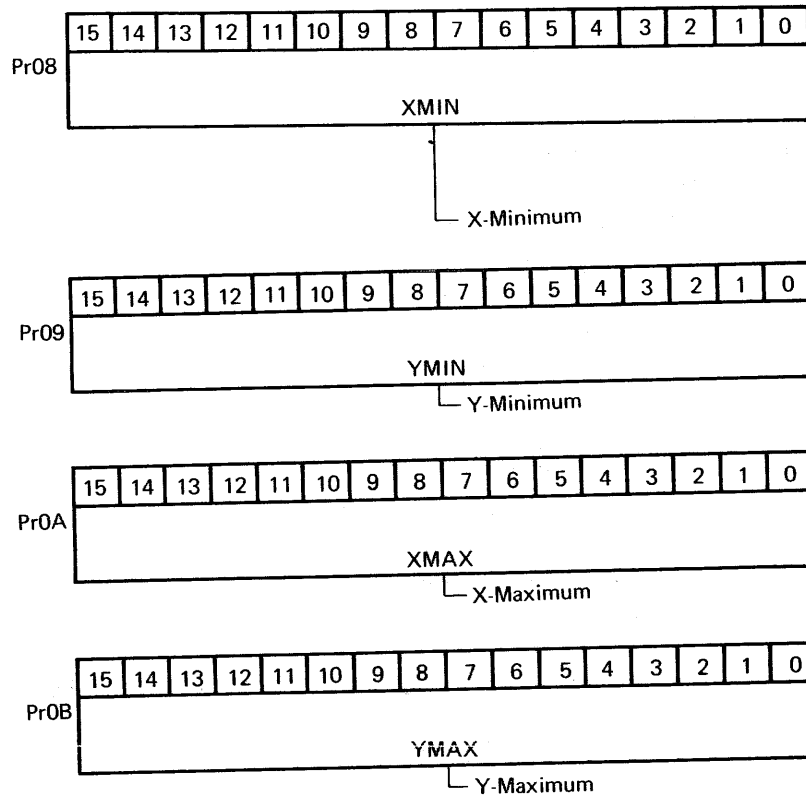


Figure 5.32 Area Definition Register (ADR)

ADR is used to define a drawing area using logical X-Y addresses relative to the origin defined with the ORG command. The ACRTC will check logical drawing addresses against ADR depending on the AREA mode specified in the graphic drawing command.

5.10.2.8 Read Write Pointer (RWP: Pr0C - Pr0D)

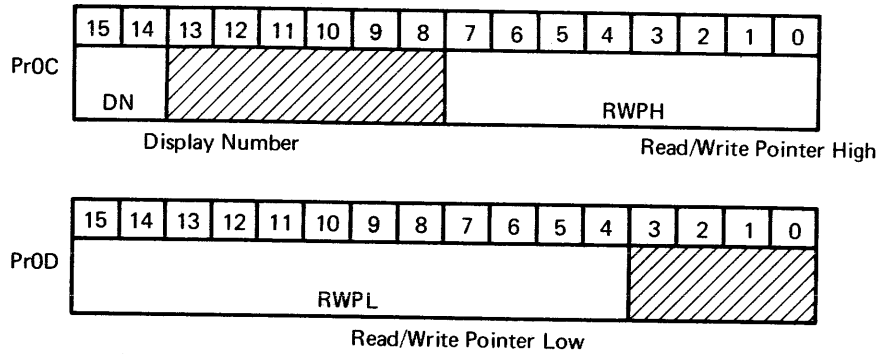


Figure 5.33 Read Write Pointer (RWP)

RWP specifies a 20 bit physical frame buffer for use with the data transfer commands.

- Display Number (DN: Pr0C bit 15 - bit 14)

DN specifies the logical screen containing the data to be transferred.

DN		Functions
15	14	
0	0	Upper Screen
0	1	Base Screen
1	0	Lower Screen
1	1	Window Screen

- Read Write Pointer High (RWPH: Pr0C bit 7 - bit 0)
Read Write Pointer Low (RWPL: Pr0D bit 15 - bit 4)
RWPH and RWPL define the initial 20 bit frame buffer address used with the data transfer commands.

5.10.2.9 Drawing Pointer (DP: Pr10 - Pr11)

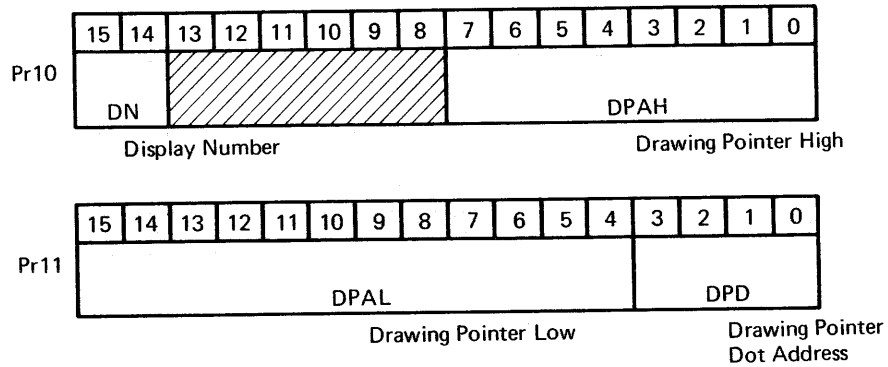


Figure 5.34 Drawing Pointer (DP)

The ACRTC uses DP for containing the physical drawing address calculated during drawing commands. When executing a drawing command, DP is updated as the Current Pointer (CP), specifying the current logical X-Y drawing address, is moved.

- Display Number (DN: Pr10 bit 15 - bit 14)
DN specifies the screen for graphic drawing. Interpretation is the same as DN in the Read Write Pointer (RWP) register.
- Drawing Pointer Address High (DPAH: Pr10 bit 7 - bit 0)
Drawing Pointer Address Low (DPAL: Pr11 bit 15 - bit 4)
DPAH and DPAL specify the 20 bit physical drawing pointer address.

- Drawing Pointer Dot (DPD: Pr11 bit 3 - bit 0)
DPD specifies the physical pixel address to locate a logical pixel within the 16 bit word addressed by DPAH, DPAL. Interpretation depends on the specified relationship between logical pixels and physical frame buffer bits as determined by the Graphic Bit Mode (GBM).

GBM	Function of DPD
1 bit/pixel	DPD specifies 1 of 16 logical pixels
2 bits/pixel	DPD specifies 1 of 8 logical pixels using most significant 3 bits of DPD. The least significant bit is not used.
4 bits/pixel	DPD specifies 1 of 4 logical pixels using most significant 2 bits of DPD. The 2 least significant bits are not used.
8 bits/pixel	DPD specifies 1 of 2 logical pixels using the most significant bit of DPD. The 3 least significant bits are not used.
16 bits/pixel	DPD is not used.

5.10.2.10 Current Pointer (CP: Pr12 - Pr13)

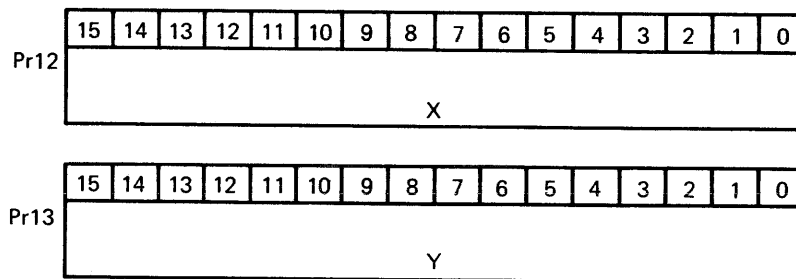


Figure 5.35 Current Pointer (CP)

CP specifies the logical X-Y coordinates of the current drawing address. As drawing proceeds, the ACRTC calculates the physical frame buffer address for each X-Y addressed logical pixel. The physical address corresponding to CP is stored in the Drawing Pointer (DP) register. Two-complement format is used to indicate positive and negative values.

Figure 6.1 Command Set

TYPE	MNEMONIC	COMMAND NAME	OPERATION CODE	PARAMETER	# (words)	~ (cycles)	
Register Access Command	ORG	Origin	0 0 0 0 0 1 0 0 0 0 0 0 0 0 0 0	DPH DPL	3	8	
	WPR	Write Parameter Register	0 0 0 0 1 0 0 0 0 0 0 0 0 0 0 0	RN D	2	6	
	RPR	Read Parameter Register	0 0 0 0 1 1 0 0 0 0 0 0 0 0 0 0	RN	1	6	
	WPTN	Write Pattern RAM	0 0 0 1 1 0 0 0 0 0 0 0 0 0 0 0	PRA n D ₁ , ..., D _n	n+2	4n+8	
	RPTN	Read Pattern RAM	0 0 0 1 1 1 0 0 0 0 0 0 0 0 0 0	PRA n	2	4n+10	
Data Transfer Command	DRD	DMA Read	0 0 1 0 0 1 0 0 0 0 0 0 0 0 0 0	AX AY	3	(4x+8)y+12[x·y/8↑]+(62~68)	
	DWT	DMA Write	0 0 1 0 1 0 0 0 0 0 0 0 0 0 0 0	AX AY	3	(4x+8)y+16[x·y/8↑]+34	
	DMOD	DMA Modify	0 0 1 0 1 1 0 0 0 0 0 0 0 0 0 0	AX AY	3	(4x+8)y+16[x·y/8↑]+34	
	RD	Read	0 1 0 0 0 1 0 0 0 0 0 0 0 0 0 0		1	12	
	WT	Write	0 1 0 0 1 0 0 0 0 0 0 0 0 0 0 0	D	2	8	
	MOD	Modify	0 1 0 0 1 1 0 0 0 0 0 0 0 0 0 0	D	2	8	
	CLR	Clear	0 1 0 1 1 0 0 0 0 0 0 0 0 0 0 0	D AX AY	4	(2x+8)y+12	
	SCLR	Selective Clear	0 1 0 1 1 1 0 0 0 0 0 0 0 0 0 0	D AX AY	4	(4x+6)y+12	
	CPY	Copy	0 1 1 0 0 S DSD 0 0 0 0 0 0 0 0 0 0	SAH SAL AX AY	5	(6x+10)y+12	
	SCPY	Selective Copy	0 1 1 1 0 S DSD 0 0 0 0 0 0 0 0 0 0	SAH SAL AX AY	5	(6x+10)y+12	
	Graphic Command	AMOVE	Absolute Move	1 0 0 0 0 0 0 0 0 0 0 0 0 0 0 0	X Y	3	56
		RMOVE	Relative Move	1 0 0 0 0 1 0 0 0 0 0 0 0 0 0 0	dX dY	3	56
ALINE		Absolute Line	1 0 0 0 1 0 0 0 0 0 0 0 0 0 0 0	AREA;COL;OPM X Y	3	P·L+18	
RLINE		Relative Line	1 0 0 0 1 1 0 0 0 0 0 0 0 0 0 0	AREA;COL;OPM dX dY	3	P·L+18	
ARCT		Absolute Rectangle	1 0 0 1 0 0 0 0 0 0 0 0 0 0 0 0	AREA;COL;OPM X Y	3	2P(A+B)+54	
RRCT		Relative Rectangle	1 0 0 1 0 1 0 0 0 0 0 0 0 0 0 0	AREA;COL;OPM dX dY	3	2P(A+B)+54	
APLL		Absolute Polyline	1 0 0 1 1 0 0 0 0 0 0 0 0 0 0 0	AREA;COL;OPM n X ₁ , Y ₁ , ..., X _n , Y _n	2n+2	Σ[P·L+16]+8	
RPLL		Relative Polyline	1 0 0 1 1 1 0 0 0 0 0 0 0 0 0 0	AREA;COL;OPM n dX ₁ , dY ₁ , ..., dX _n , dY _n	2n+2	Σ[P·L+16]+8	
APLG		Absolute Polygon	1 0 1 0 0 0 0 0 0 0 0 0 0 0 0 0	AREA;COL;OPM n X ₁ , Y ₁ , ..., X _n , Y _n	2n+2	Σ[P·L+16]+P·Lo+20	
RPLC		Relative Polygon	1 0 1 0 0 1 0 0 0 0 0 0 0 0 0 0	AREA;COL;OPM n dX ₁ , dY ₁ , ..., dX _n , dY _n	2n+2	Σ[P·L+16]+P·Lo+20	
CRCL		Circle	1 0 1 0 1 0 0 0 0 0 0 0 0 0 0 0	AREA;COL;OPM r	2	8d+66	
ELPS		Ellipse	1 0 1 0 1 1 0 0 0 0 0 0 0 0 0 0	AREA;COL;OPM a b dX	4	10d+90	
AARC		Absolute Arc	1 0 1 1 0 0 0 0 0 0 0 0 0 0 0 0	AREA;COL;OPM Xc Yc Xc Ye	5	8d+18	
RARC		Relative Arc	1 0 1 1 0 1 0 0 0 0 0 0 0 0 0 0	AREA;COL;OPM dXc dYc dXe dYe	5	8d+18	
AEARC		Absolute Ellipse Arc	1 0 1 1 1 0 0 0 0 0 0 0 0 0 0 0	AREA;COL;OPM a b Xc Yc Xc Ye	7	10d+96	
REARC		Relative Ellipse Arc	1 0 1 1 1 1 0 0 0 0 0 0 0 0 0 0	AREA;COL;OPM a b dXc dYc dXe dYe	7	10d+96	
AFRCT		Absolute Filled Rectangle	1 1 0 0 0 0 0 0 0 0 0 0 0 0 0 0	AREA;COL;OPM X Y	3	(P·A+B)B+18	
RFRCT		Relative Filled Rectangle	1 1 0 0 0 1 0 0 0 0 0 0 0 0 0 0	AREA;COL;OPM dX dY	3	(P·A+B)B+18	
PAINT		Paint	1 1 0 0 1 0 0 0 0 0 0 0 0 0 0 0	AREA;COL;OPM	1	(18A+102)B-58 *1)	
DOT		Dot	1 1 0 0 1 1 0 0 0 0 0 0 0 0 0 0	AREA;COL;OPM	1	8	
PTN		Pattern	1 1 0 1 SL SD	AREA;COL;OPM SZ	2	(P·A+10)B+20 *2)	
AGCPY		Absolute Graphic Copy	1 1 1 0 S DSD	AREA;0 0;OPM Xs Ys DX DY	5	((P+2)A+10)B+70	
RGCPY	Relative Graphic Copy	1 1 1 1 S DSD	AREA;0 0;OPM dXs dYs DX DY	5	((P+2)A+10)B+70		

*1) In case of rectangular filling

*2) SZ: $\begin{matrix} 15 & & 87 & & 0 \\ \hline \text{SZy} & & & & \text{SZx} \end{matrix}$ SZy, SZx: Pattern Size

n: number of repetition x/y: drawing words of x-direction/y-direction L/Lo/d: sum of drawing dots A/B: drawing dots of main/sub direction P= {4: OPM-000 ~ 011
6: OPM-100 ~ 111
E: [E=0 (stop at Edge color), E=1 (stop at excepting Edge color)] C: [C=1 (clock wise), C=0 (reverse)] [↑]: rounding up

6.1 Command Overview

The ACRTC interprets and processes commands issued by the MPU. These commands are classified into three groups.

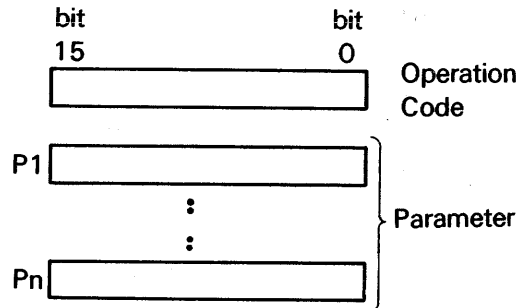
- 1) Register Access Commands
- 2) Data Transfer Commands
- 3) Graphic Drawing Commands

6.2 Command Format

ACRTC commands consist of a 16 bit op-code, optionally followed by 1 or more 16 bit parameters. When 8 bit MPU mode is used, commands, parameters and data are sent to and from the ACRTC in the order of high byte, low byte.

(a) 16 bit interface

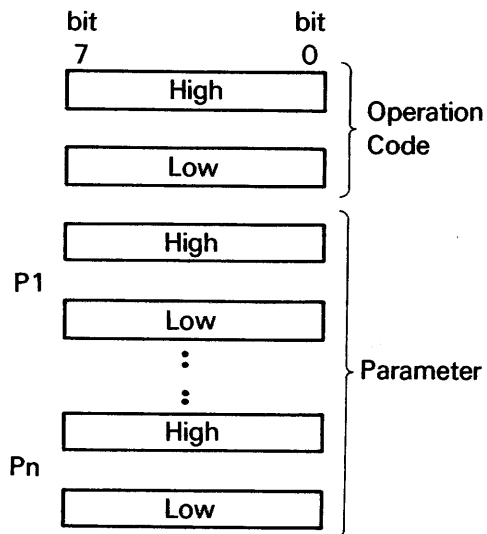
In the case of 16 bit interface, first move the 16 bit operation code and then move necessary 16 bit parameters one by one.



(a) 16 bit Interface

(b) 8 bit interface

In the case of 8 bit interface, first move the operation code's High byte and Low byte in this order and then move those of parameters in the same order.



(b) 8 bit Interface

6.3 Command Transfer Modes

Commands (and associated parameters) can be issued to the ACRTC in one of two ways – program transfer or DMA transfer.

6.3.1 Program Transfer

Program Transfer occurs when the MPU specifies the FIFO entry address and then writes commands/parameters to the write FIFO under program control ($RS = \text{high}$, R/\overline{W} , $\overline{CS} = \text{low}$). The MPU writes are normally synchronized with ACRTC FIFO status by software polling or interrupts.

- Software Polling (WFR, WFE interrupts disabled)
 - a) MPU program checks the SR (Status Register) for Write FIFO Ready (WFR) flag = 1, and then writes one word of command or parameters.
 - b) MPU program checks the SR (Status Register) for Write FIFO Empty (WFE) flag = 1, and then writes one to eight words of commands or parameters.
- Interrupt Driven (WFR, WFE interrupts enabled)
 - a) MPU WFR interrupt service routine writes one word of command or parameters.
 - b) MPU WFE interrupt service routine writes one to eight words of commands or parameters.

In the specific case of Register Access Commands and an initially empty write FIFO, MPU writes need not be synchronized to the write FIFO status. The ACRTC can fetch and execute these commands faster than the MPU can issue them.

6.3.2 Command DMA Transfer

Commands and parameters can be transferred from MPU system memory using in external DMAC. The MPU initiates and terminates Command DMA Transfer mode under software control (CDM bit of CCR). Command DMA can also be terminated by assertion of the ACRTC \overline{DONE} signal. \overline{DONE} is treated as an input in Command DMA Transfer Mode.

Using Command DMA Transfer, the ACRTC will issue cycle stealing DMA requests to the DMAC when the write FIFO is empty. The DMA data is automatically sent from system memory to the ACRTC write FIFO regardless of the contents of the Address Register.

6.4 Register Access Commands

Registers associated with the Drawing processor (the Pattern RAM and Drawing Parameter Registers) are accessed through the read and write FIFOs using the Register Access Commands.

Command	Function
ORG	Initialize the relation between the origin point in the X-Y coordinates and the physical address.
WPR	Write into the parameter register
RPR	Read the parameter register
WPTN	Write into the pattern RAM
RPTN	Read the pattern RAM

Figure 6.2 Register Access Commands

6.5 Data Transfer Commands

Data Transfer Commands are used to move blocks of data between the MPU system memory and the ACRTC frame buffer or within the frame buffer itself. Before issuing these commands, a physical 20 bit frame buffer address must be specified in the RWP (Read Write Pointer) Drawing Parameter Register.

The DMA Data Transfer Commands (DRD, DWT and DMOD) are used to send large amounts of data between system and frame buffer memory. The programmer specifies the command and the X and Y logical pixel dimensions of the frame buffer data block. The ACRTC will automatically control the external DMAC to request data transfers via the read or write FIFOs. In Data DMA Transfer, the ACRTC \overline{DONE} pin becomes an output which the ACRTC asserts to the external DMAC to terminate the transfer. Also, either cycle steal or burst DMA request mode can be used for data DMA (DRC bit of CCR).

Note that DMA data transfer can be performed without an external DMAC, i.e. under MPU program control. In this case, the data DMA handshaking (\overline{DREQ} , \overline{DACK} and \overline{DONE}) signals are disabled by resetting the DDM bit in CCR to 0. After issuing a DMA data transfer command, the MPU reads or writes the appropriate data to the ACRTC FIFOs under program control. The programmer must insure that the amount of data transferred equals the amount specified as parameters to the command. Also note that the ACRTC will go into an indefinite wait state after the last transfer of a DRD command. Then, the command should be aborted (by setting the ABT bit in CCR to 1) and the next command issued.

Command	Function
DRD	DMA read of the frame buffer data
DWT	DMA write into the frame buffer
DMOD	DMA modify of the frame buffer data (bit maskable)
RD	One word read from the frame buffer
WT	One word write into the frame buffer
MOD	One word modify of the frame buffer (bit maskable)
CLR	Clear of frame buffer area
SCLR	Clear of frame buffer area (bit maskable)
CPY	Copy of frame buffer area into another area
SCPY	Copy of frame buffer area into another area (bit maskable)

Figure 6.3 Data Transfer Commands

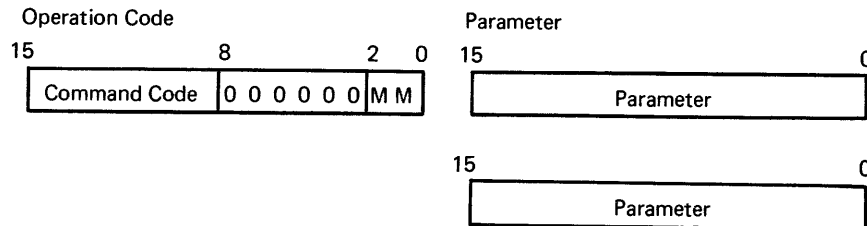


Figure 6.4 Data Transfer Command Format

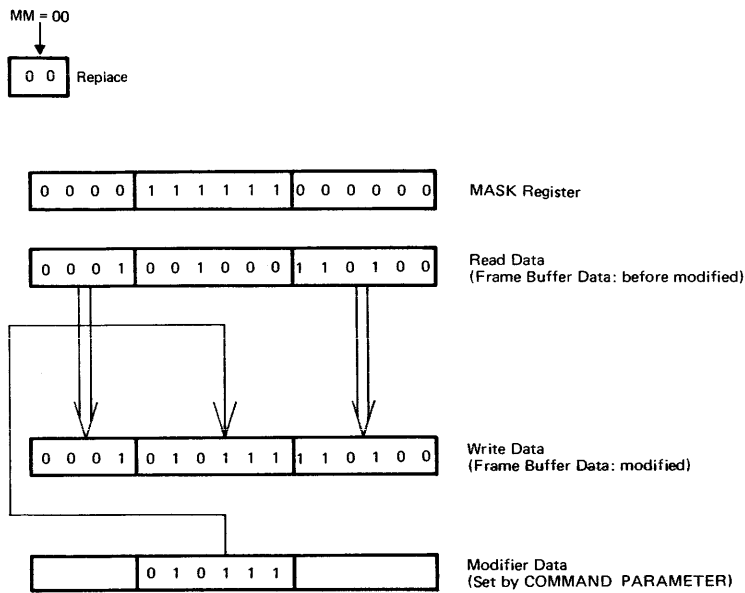
6.5.1 Modify Mode

The DMOD, MOD, SCLR and SCPY commands allow 4 types of bit level logical operations to be applied to frame buffer data. The modify mode is encoded in the lower two bits (MM) of these op-codes. The bit positions within each frame buffer word to be modified are selectable using the mask register (MASK). Bits masked with 1 are modifiable, those masked with 0 are not.

MM		Modify Mode
0	0	REPLACE frame buffer data with command parameter data.
0	1	OR frame buffer data with command parameter data and rewrite to the frame buffer.
1	0	AND frame buffer data with command parameter data and rewrite to the frame buffer.
1	1	EOR frame buffer data with command parameter data and rewrite to the frame buffer.

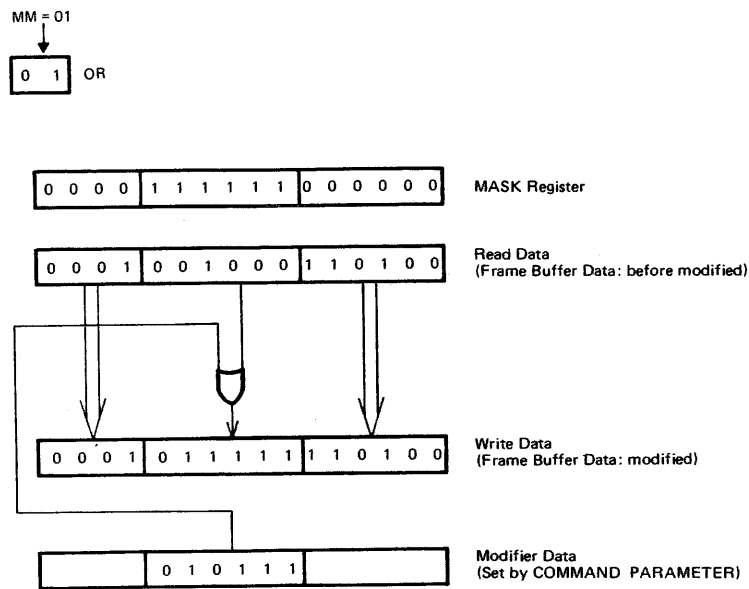
○ Modify Mode Examples

The following examples show the use of the REPLACE, OR, AND and EOR modify modes. The modifier data (issued as a parameter to the DMOD, MOD, SCLR and SCPY commands) and the non-masked data in the frame buffer are logically operated on, and the result is rewritten to the frame buffer.



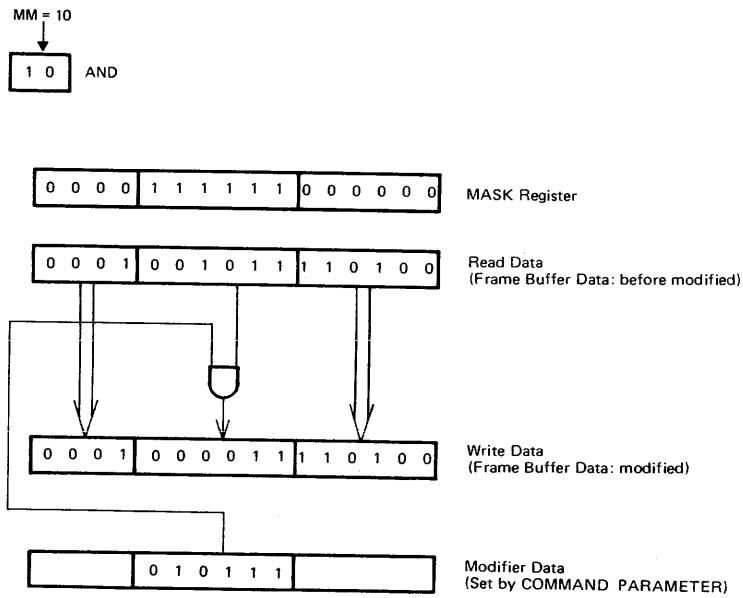
The read data bit positions for which the MASK register contains '1' is REPLACED with the command parameter modifier data. The result is rewritten to the read data location in the frame buffer.

Figure 6.5(a) REPLACE Modify Mode



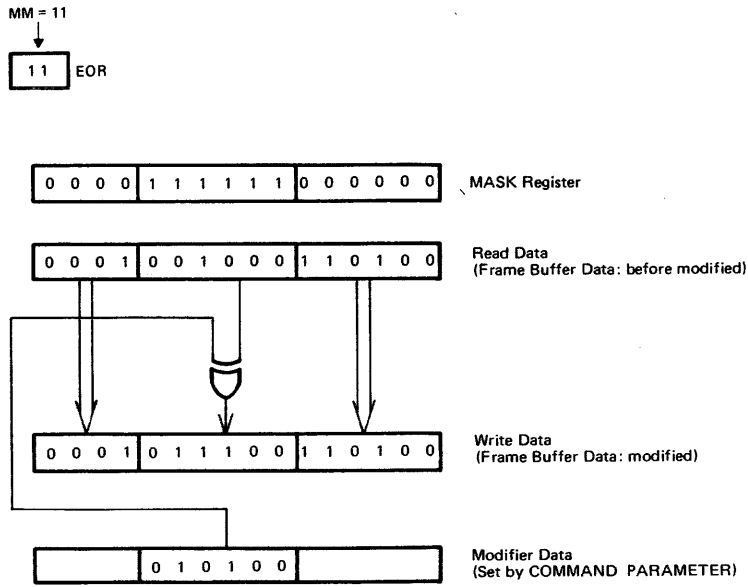
The read data bit positions for which the MASK register contains '1' is ORed with the command parameter modifier data. The result is rewritten to the read data location in the frame buffer.

Figure 6.5(b) OR Modify Mode



The read data bit positions for which the MASK register contains '1' is ANDed with the command parameter modifier data. The result is rewritten to the read data location in the frame buffer.

Figure 6.5(c) AND Modify Mode



The read data bit positions for which the MASK register contains '1' is EORed with the command parameter modifier data. The result is rewritten to the read data location in the frame buffer.

Figure 6.5(d) EOR Modify Mode

6.6 Graphic Drawing Commands

The ACRTC has 23 separate graphic drawing commands. Graphic drawing is performed by modifying the contents of the frame buffer based upon microcoded drawing algorithms in the ACRTC drawing processor.

Most coordinate parameters for graphic drawing commands are specified using logical pixel X-Y addressing. The complex task of translating a logical pixel address to a linear frame buffer word address, and further selecting the appropriate sub-field of the word (for example, a given logical pixel in 4 bits per logical pixel mode might reside in bits 8-11 of a frame buffer word) is performed at high speed by ACRTC hardware.

Many instructions allow specification of X-Y coordinates with either absolute or relative X-Y coordinates (e.g. ALINE and RLINE). In both cases, two's complement numbers are used to represent positive and negative values.

(a) Absolute Coordinate Specification

The screen address (X, Y) is specified in units of logical pixels relative to an origin point defined with the ORG command.

(b) Relative Coordinate Specification

The screen address (dX,dY) is specified in units of logical pixels relative to the current drawing pointer (CP) position.

A graphic drawing command consists of a 16 bit op-code and optionally 0 to 64K 16 bit parameters.

The 16 bit op-code consists of an 8 bit command code, an AREA Mode specifier (3 bits), a Color Mode specifier (2 bits) and an Operation Mode specifier (3 bits).

The Area Mode allows versatile clipping and hitting detection. A drawing area can be defined, and should drawing operations attempt to enter or leave that area, a number of programmable actions can be taken by the ACRTC.

The Color Mode determines whether the Pattern RAM is used indirectly to select Color Registers or is directly used as the color information.

The Operation Mode defines one of eight logical operations to be performed between the frame buffer read data and the color data in the Pattern RAM to determine the drawing data to be rewritten to the frame buffer.

- (i) **Absolute Coordinate Specification**
Specifies the addresses (x, y) based on the origin point set by the ORG command.

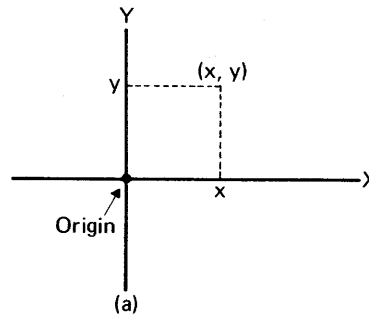


Figure 6.6(a) Absolute Coordinate Specification

- (ii) **Relative Coordinate Specification**
Specifies the relative addresses $(\Delta x, \Delta y)$ related to the current drawing point.

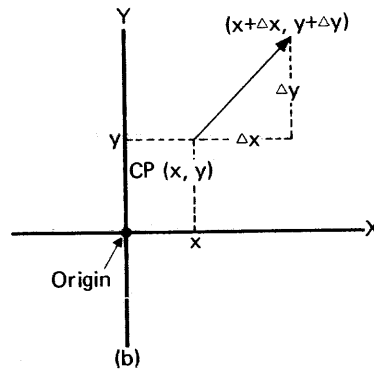


Figure 6.6(b) Relative Coordinate Specification

Command	Function
AMOVE	Movement of current points
RMOVE	
ALINE	Drawing of straight lines
RLINE	
ARCT	Drawing of rectangles
RRCT	
APLL	Drawing of polylines
RPLL	
APLG	Drawing of polygons
RPLG	
CRCL	Drawing of circles
ELPS	Drawing of ellipses
AARC	Drawing of arcs
RARC	
AEARC	Drawing of ellipse arcs
REARC	
AFRCT	Painting of rectangle areas (Tiling)
RFRCT	
PAINT	Painting of arbitrary areas (Tiling)
DOT	Making of dots
PTN	Drawing of basic patterns (rotation angle: 45°)
AGCPY	Graphic copy between frame memories (rotation angle: 90°/mirror turnover)
RGCPY	

Figure 6.7 Graphic Drawing Commands

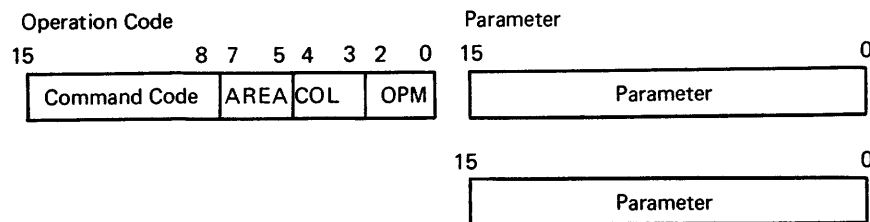


Figure 6.8 Graphic Drawing Command Format

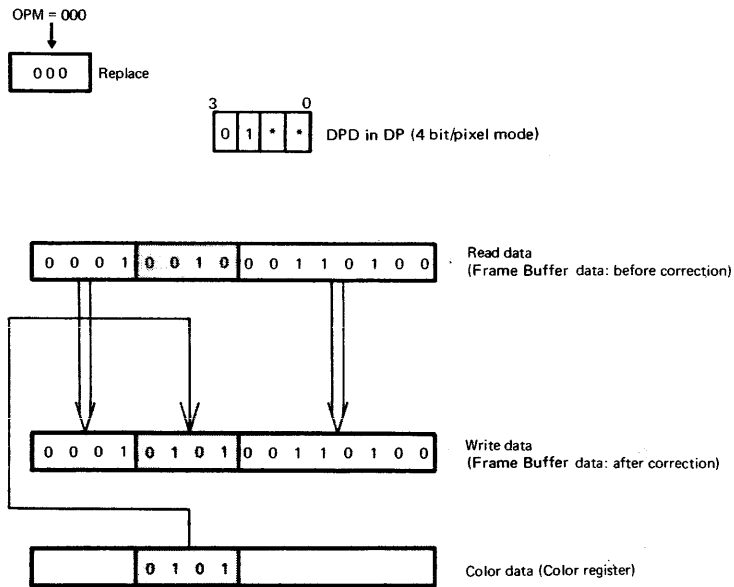
6.6.1 Operation Mode

The Operation Mode (OPM bits) of the Graphic Drawing Command specify the logical drawing condition.

OPM	Operation Mode
0 0 0	REPLACE: Replaces the frame buffer data with the color data.
0 0 1	OR: ORs the frame buffer data with the color data. The result is rewritten to the frame buffer.
0 1 0	AND: ANDs the frame buffer data with the color data. The result is rewritten to the frame buffer.
0 1 1	EOR: EORs the frame buffer data with the color data. The result is rewritten to the frame buffer.
1 0 0	CONDITIONAL REPLACE ($P=CCMP$): When the frame buffer data at the drawing position (P) is equal to the comparison color (CCMP), the frame buffer data is replaced with the color data.
1 0 1	CONDITIONAL REPLACE ($P \neq CCMP$): When the frame buffer data at the drawing position (P) is not equal to the comparison color (CCMP), the frame buffer data is replaced with the color data.
1 1 0	CONDITIONAL REPLACE ($P < CL$): When the frame buffer data at the drawing position (P) is less than the color register data (CL), the frame buffer data is replaced with the color data.
1 1 1	CONDITIONAL REPLACE ($P > CL$): When the frame buffer data at the drawing position (P) is greater than the color register data (CL), the frame buffer data is replaced with the color data.

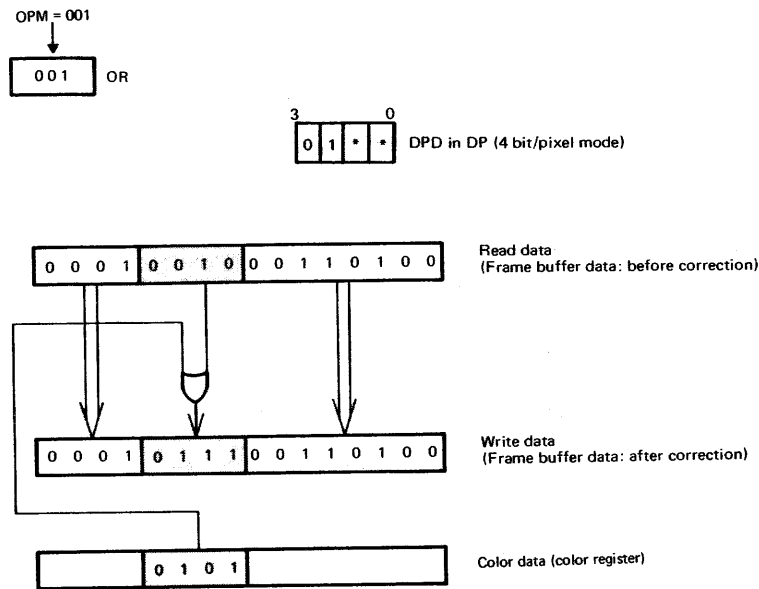
Following are examples of each of the eight operation modes. In these examples, 4 bits/logical pixel is assumed.

Figure 6.10 shows examples of a drawing pattern applied with various OPM modes.



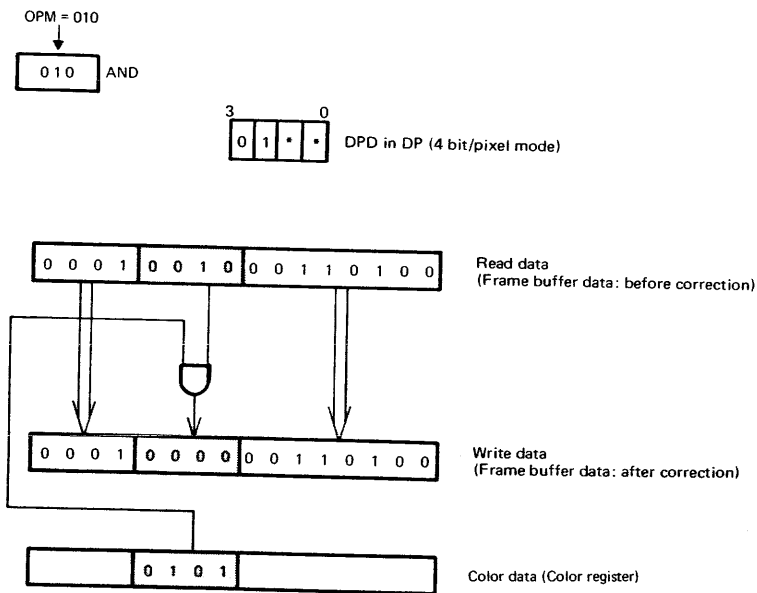
One pixel of the frame buffer read data is REPLACED with the corresponding color register data and the result is rewritten to the frame buffer read data location. The dot pointer serves to extract the pixel from the frame buffer word — in this example, 4 bits/pixel.

Figure 6.9(a) REPLACE Operation Mode



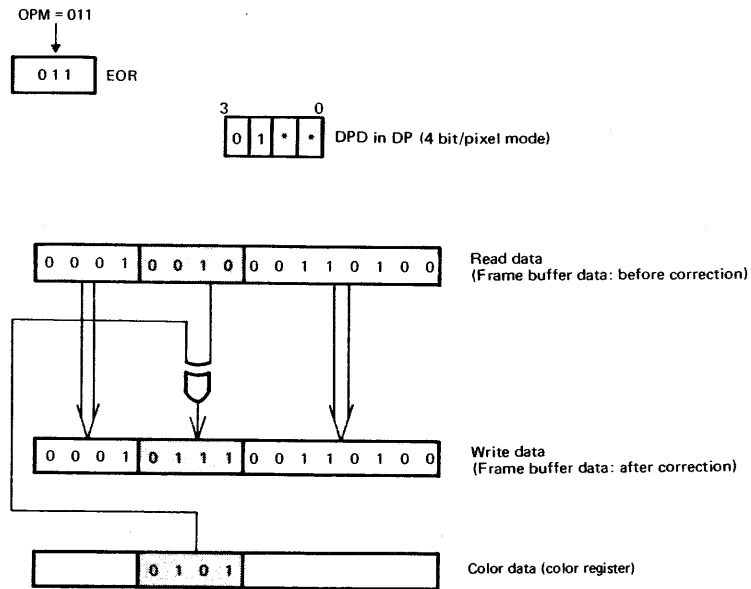
One pixel of the frame buffer read data is ORed with the corresponding color register data and the result is rewritten to the frame buffer read data location. The dot pointer serves to extract the pixel from the frame buffer word — in this example, 4 bits/pixel.

Figure 6.9(b) OR Operation Mode



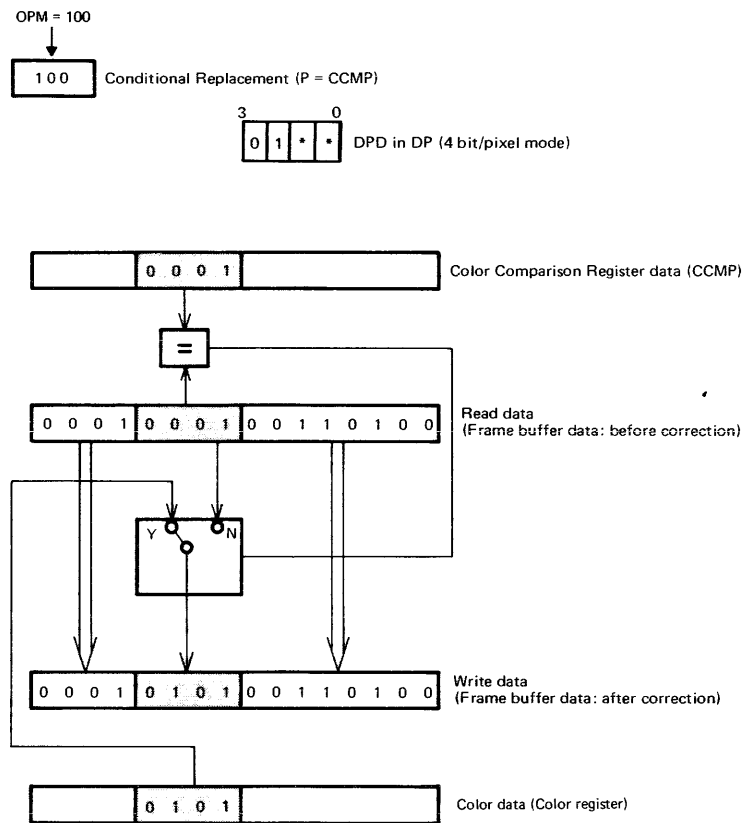
One pixel of the frame buffer read data is ANDed with the corresponding color register data and the result is rewritten to the frame buffer read data location. The dot pointer serves to extract the pixel from the frame buffer word – in this example, 4 bits/pixel.

Figure 6.9(c) AND Operation Mode



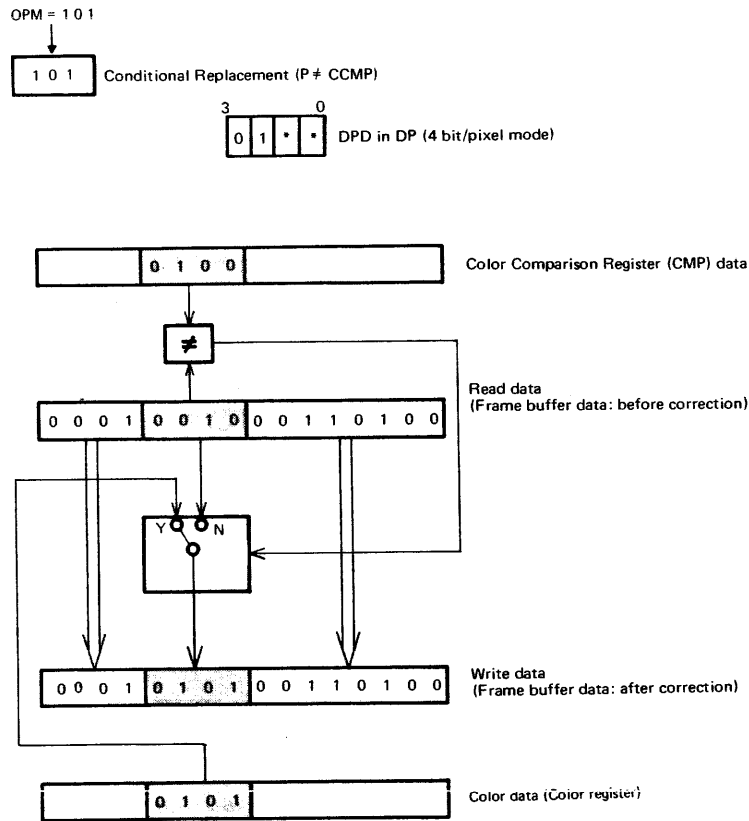
One pixel of the frame buffer read data is EORed with the corresponding color register data and the result is rewritten to the frame buffer read data location. The dot pointer serves to extract the pixel from the frame buffer word — in this example, 4 bits/pixel.

Figure 6.9(d) EOR Operation Mode



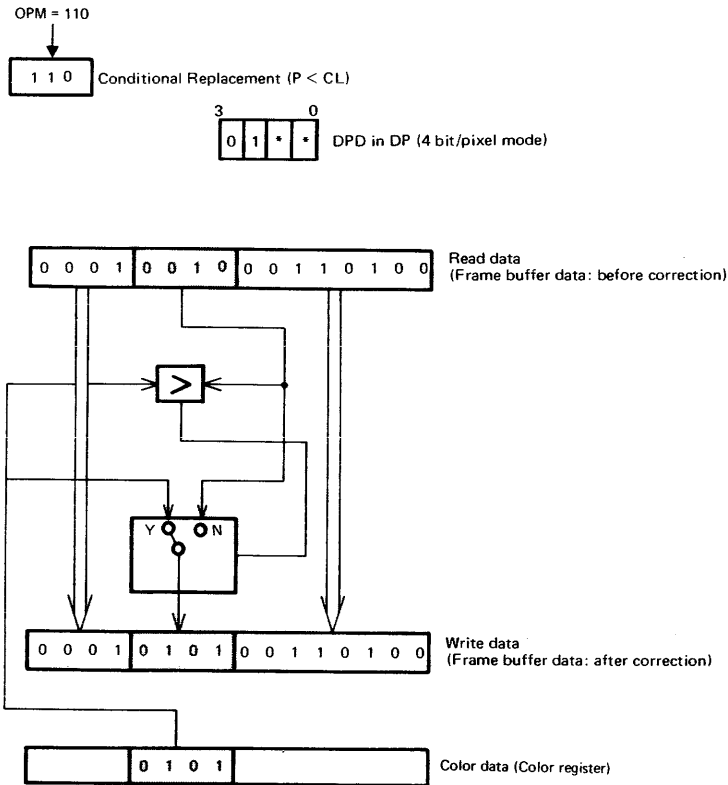
One pixel of the frame buffer read data is compared with the corresponding one pixel contents of the Color Comparison Register (CCMP). If equal, the read data is replaced with the color data and the result is rewritten to the read data location in the frame buffer. If not equal, the read data (unmodified) is rewritten to the read data location in the frame buffer. The dot pointer serves to extract the pixel from the frame buffer word – in this example, 4 bits/pixel.

Figure 6.9(e) P=CCMP Operation Mode



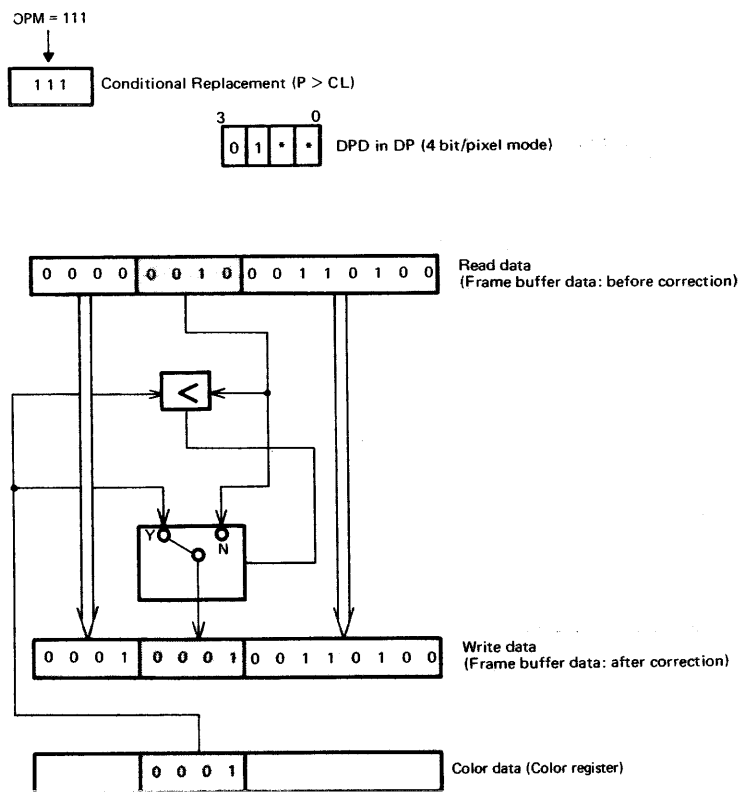
One pixel of the frame buffer read data is compared with the corresponding one pixel contents of the Color Comparison Register (CCMP). If not equal, the read data is replaced with the color data and the result is rewritten to the read data location in the frame buffer. If equal, the read data (unmodified) is rewritten to the read data location in the frame buffer. The dot pointer serves to extract the pixel from the frame buffer word — in this example, 4 bits/pixel.

Figure 6.9(f) P ≠ CCMP Operation Mode



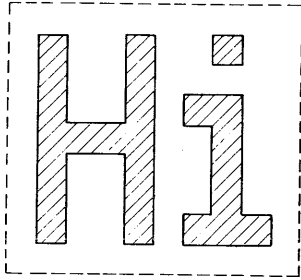
One pixel of the frame buffer read data is compared with the corresponding one pixel contents of the color data (CL). If the read data is LESS than the color data, the read data is replaced with the color data and the result is rewritten to the read data location in the frame buffer. If the read data is GREATER than or EQUAL to the color data, the read data (unmodified) is rewritten to the read data location in the frame buffer. The dot pointer serves to extract the pixel from the frame buffer word – in this example, 4 bits/pixel.

Figure 6.9(g) P < CL Operation Mode

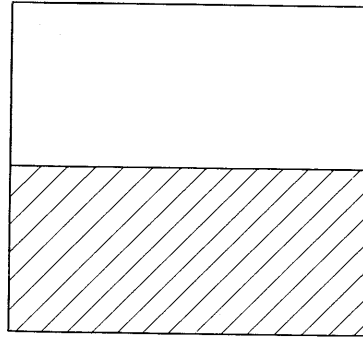


One pixel of the frame buffer read data is compared with the corresponding one pixel contents of the color data (CL). If the read data is **GREATER** than the color data, the read data is replaced with the color data and the result is rewritten to the read data location in the frame buffer. If the read data is **LESS** than or **EQUAL** to the color data, the read data (unmodified) is rewritten to the read data location in the frame buffer. The dot pointer serves to extract the pixel from the frame buffer word — in this example, 4 bits/pixel.

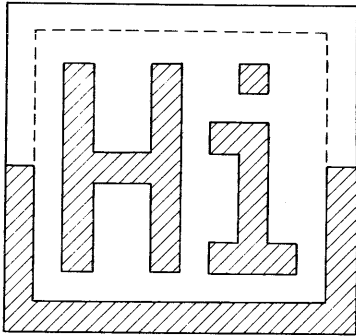
Figure 6.9(h) P > CL Operation Mode



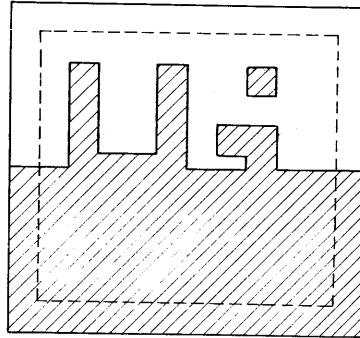
Drawing Pattern



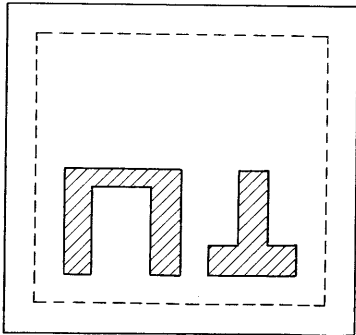
Picture Memory before Drawing



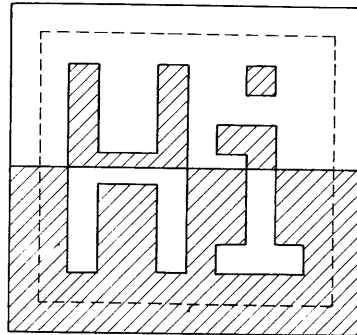
Replacement



OR



AND



EOR

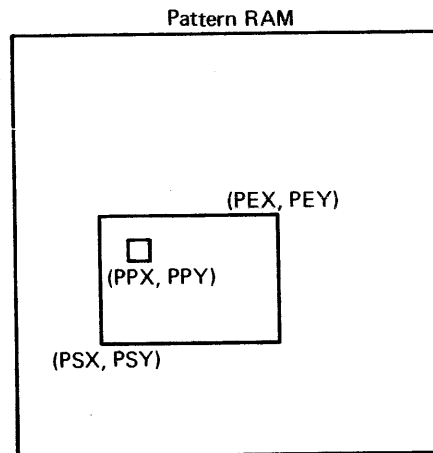
Figure 6.10 Operation Mode Example

6.6.2 Color Mode

The Color Mode (COL bits) specify the source of the drawing color data as directly or indirectly (using the Color Registers) determined by the contents of the Pattern RAM.

COL		Color Mode
0	0	When Pattern RAM data = 0, Color Register 0 is used. When Pattern RAM data = 1, Color Register 1 is used.
0	1	When Pattern RAM data = 0, drawing is suppressed. When Pattern RAM data = 1, Color Register 1 is used.
1	0	When Pattern RAM data = 0, Color Register 0 is used. When Pattern RAM data = 1, drawing is suppressed.
1	1	Pattern RAM contents are directly used as color data.

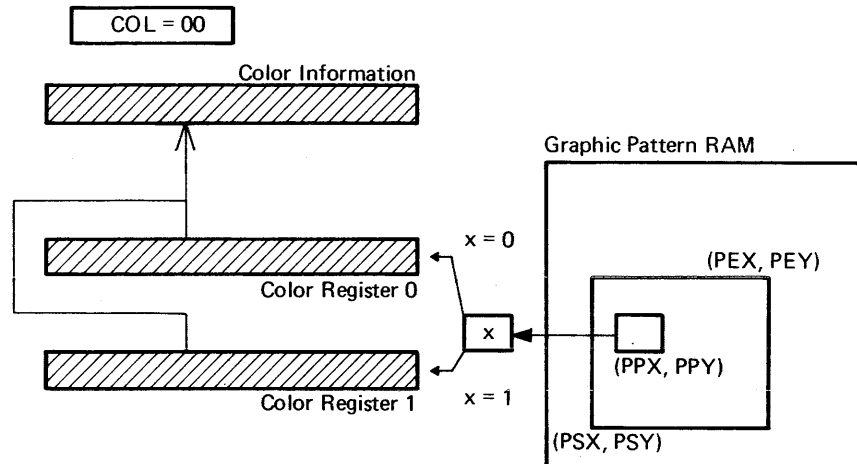
The Color Mode chooses the source for color information based on the contents (0 or 1) of a particular bit in the 16 bit by 16 bit (32 byte) Pattern RAM. A sub-pattern is specified by programming the Pattern RAM Control Register (PRC) with the start (PSX, PSY) and end (PEX, PEY) points which define the diagonal of the sub-pattern. Furthermore, a specific starting point for Pattern RAM scanning is specified by PPX and PPY.



Normally, the color registers (CL) should be loaded with one color data based on the number of bits per pixel. For example, if 4 bits/pixel are used, the 4 bit color pattern (e.g. 0001) should be replicated four times in the color register, i.e.

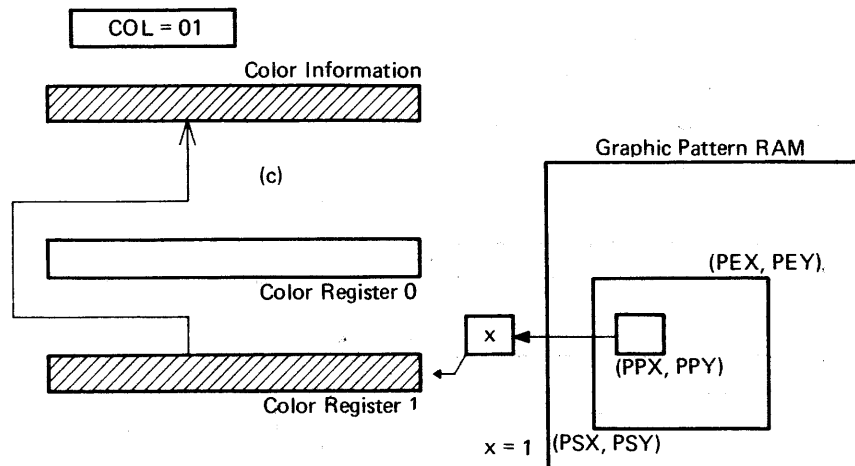
Color Register = 0 0 0 1 0 0 0 1 0 0 0 1 0 0 0 1

In this way, color changes due to changing dot address are avoided.



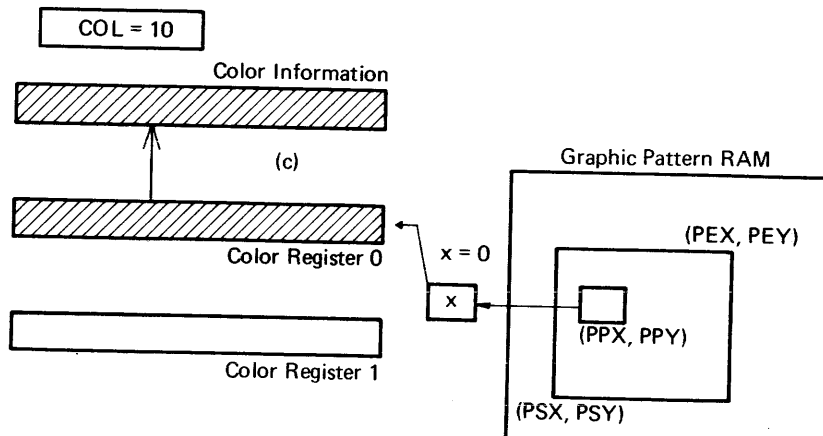
If the scanned Pattern RAM bit is equal '0', Color Register 0 (CL0) determines the color information. If the scanned Pattern RAM bit is equal '1', Color Register 1 (CL1) determines the color information.

Figure 6.11(a) Color Mode = 00



If the scanned Pattern RAM bit is equal '0', the drawing operation is suppressed and the frame buffer is not changed. If the scanned Pattern RAM bit is equal '1', Color Register 1 (CL1) determines the color information.

Figure 6.11(b) Color Mode = 01



If the scanned Pattern RAM bit is equal '1', the drawing operation is suppressed and the frame buffer is not changed. If the scanned Pattern RAM bit is equal '0', Color Register 0 (CLO) determines the color information.

Figure 6.11(c) Color Mode = 10

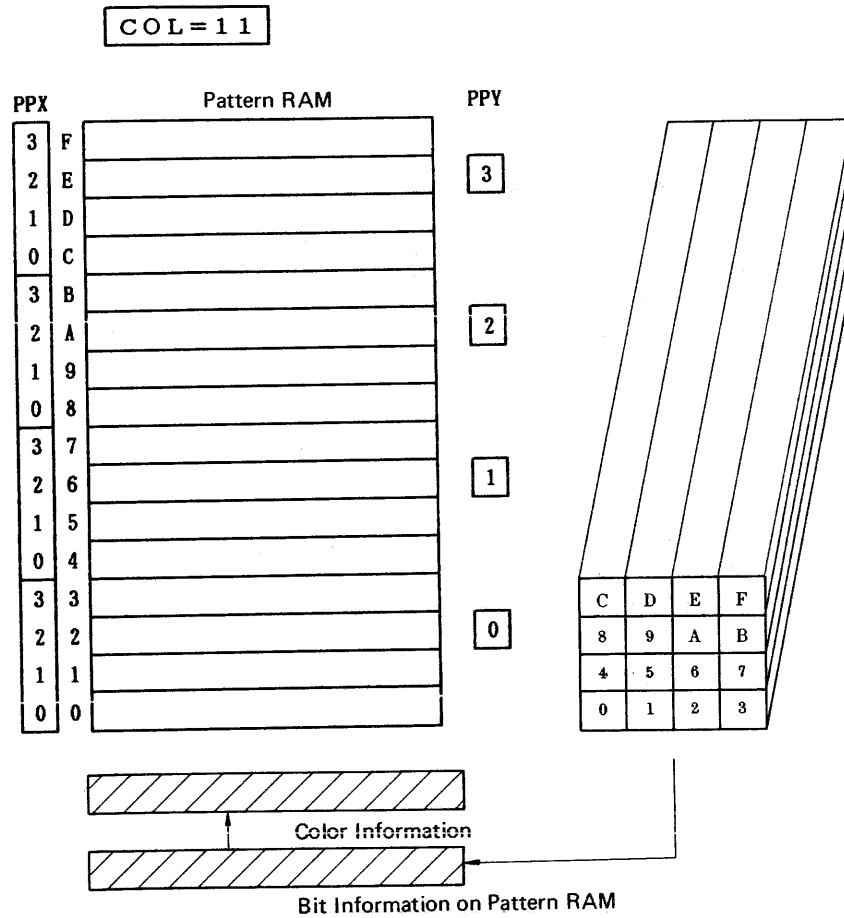


Figure 6.11(d) Color Mode = 11

In the former three color modes (Pattern RAM indirect), the actual color information is stored in the color registers (CL0, CL1) and selection is based on the 0 or 1 bit value during Pattern RAM scanning.

In color mode = 11 (Pattern RAM direct), the Pattern RAM contents are directly used to generate color information. This is accomplished by remapping of the Pattern RAM so that it is interpreted as containing up to 4 by 4 logical pixel color patterns, each of which contains 16 bits of color information.

Associated with this logical remapping of the Pattern RAM, the contents of the Pattern RAM Control Register (PRC) are interpreted differently. As shown below the pattern pointer, pattern start and pattern end (PPX, PPY, PSX, PSY, PEX and PEY) are restricted to specify a maximum 4 by 4 logical pixel pattern. Specifically, bits 15-14 and 7-6 must be set to 0.

RN	Register Name	15	14	13	12	11	10	9	8	7	6	5	4	3	2	1	0
05	Pattern Control	0	0	PPY	PZCY	0	0	PPX	PZCX								
06		0	0	PSY	0	0	0	0	0	0	0	PSX	0	0	0	0	
07		0	0	PEY	PZY	0	0	PEX	PZX								

A pattern size less than 4 by 4 logical pixels can be specified (minimum is 1 by 1 logical pixel) as shown below. In this example a 2 by 4 logical pixel pattern is specified by setting PSX = 1, PSY = 0, PEX = 2 and PEY = 3.

	D	E	
	9	A	
	5	6	
	1	2	

As in color register indirect modes, normally one color is repeatedly assigned to the 16 bit color information depending on the number of bits per pixel. For example, when 4 bits per pixel are used, and color information for a pixel is 0001, the Pattern RAM should contain ...

0	0	0	1	0	0	0	1	0	0	0	1	0	0	0	1
---	---	---	---	---	---	---	---	---	---	---	---	---	---	---	---

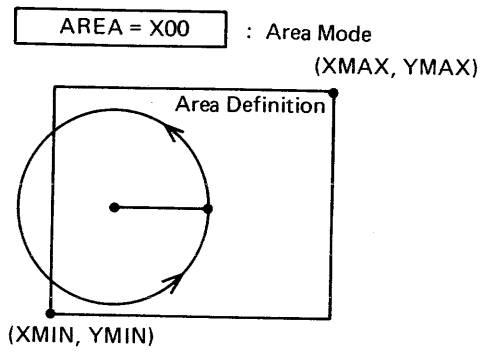
This prevents color change due to changing dot address.

6.6.3 Area Mode

Prior to drawing, a drawing 'area' may be defined (Area Definition Register). Then, during Graphics Drawing operation the ACRTC will check if the drawing point is attempting to enter or exit the defined drawing area. Based on eight Area Modes, the ACRTC will take appropriate action for clipping or hitting.

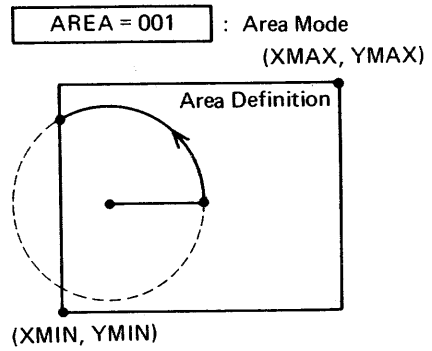
AREA			Drawing Area Mode
0	0	0	Drawing is executed without Area checking.
0	0	1	When attempting to exit the Area, drawing is stopped and the ARD (Area Detect) and CED (Command End) flags are set.
0	1	0	Drawing suppressed outside the Area – drawing operation continues and the ARD flag is not set.
0	1	1	Drawing suppressed outside the Area – drawing operation continues and the ARD flag is set.
1	0	0	Same as AREA = 0 0 0.
1	0	1	When attempting to enter the Area, drawing is stopped and the ARD and CED (Command End) flags are set.
1	1	0	Drawing suppressed inside the Area – drawing operation continues and the ARD flag is not set.
1	1	1	Drawing suppressed inside the Area – drawing operation continues and the ARD flag is set.

The following examples show execution of a CRCL (Circle) command using the various Area Modes. It is assumed that the Area Definition Register has been loaded to define the Area bounded by XMIN, YMIN and XMAX, YMAX.



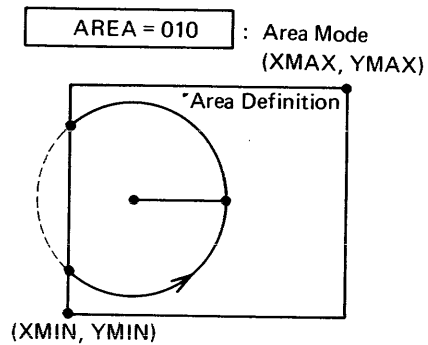
Drawing is executed without area checking.

Figure 6.12(a) Area Mode = X00



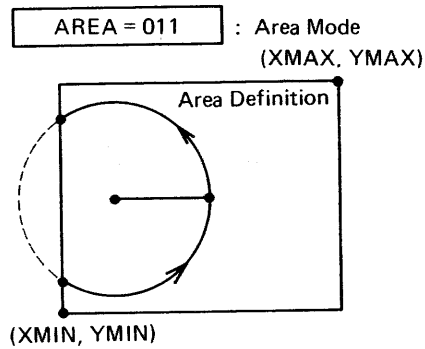
Drawing is executed as long as the CP (Current Pointer) resides in the defined area. When the drawing operation causes the CP to go outside the defined area, the drawing instruction is terminated and the ARD (Area Detect) and CED (Command End) flags in the Status Register (SR) are set to '1'.

Figure 6.12(b) Area Mode = 001



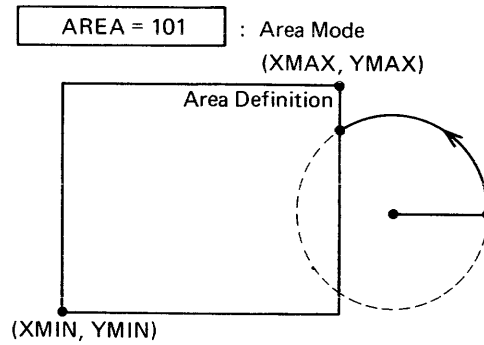
When the CP (Current Pointer) is outside the defined area, drawing is suppressed but the drawing operation continues. When CP is inside the defined area, drawing operation is enabled. When the drawing instruction execution is completed, the CED (Command End) bit in the Status Register (SR) is set to '1'. The ARD bit (Area Detect) bit in the Status Register is not set to '1' at any time during the drawing instruction execution regardless of whether CP goes inside or outside the defined area.

Figure 6.12(c) Area Mode = 010



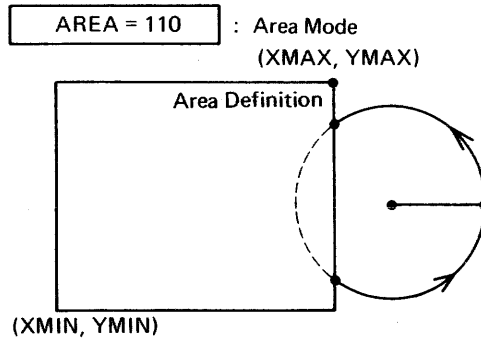
This mode is the same as AREA MODE = 010 in that drawing is enabled when CP (Current Pointer) is inside the defined area and suppressed when CP is outside the defined area. However, if at any time during the drawing instruction execution, CP goes outside the defined area, the ARD (Area Detect) bit in the Status Register (SR) will be set to '1'. The ARD bit can be monitored to determine when the CP goes outside the defined area.

Figure 6.12(d) Area Mode = 011



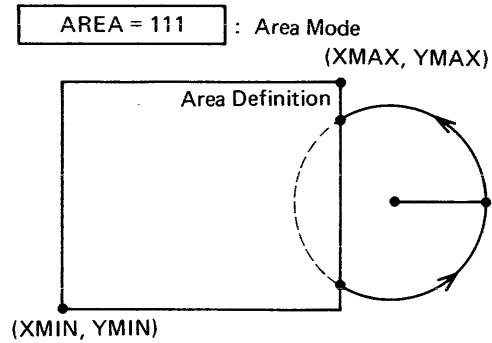
Drawing is executed as long as the CP (Current Pointer) resides outside the defined area. When the drawing operation causes the CP to go inside the defined area, the drawing instruction is terminated and the ARD (Area Detect) and CED (Command End) flags in the Status Register (SR) are set to '1'.

Figure 6.12(e) Area Mode = 101



When the CP (Current Pointer) is inside the defined area, drawing is suppressed but the drawing operation continues. When CP is outside the defined area, drawing operation is enabled. When the drawing instruction execution is completed, the CED (Command End) bit in the Status Register (SR) is set to '1'. The ARD bit (Area Detect) bit in the Status Register is not set to '1' at any time during the drawing instruction execution regardless of whether CP goes inside or outside the defined area.

Figure 6.12(f) Area Mode = 110



This mode is the same as AREA MODE = 110 in that drawing is enabled when CP (Current Pointer) is outside the defined area and suppressed when CP is inside the defined area. However, if at any time during the drawing instruction execution, CP goes inside the defined area, the ARD (Area Detect) bit in the Status Register (SR) will be set to '1'. The ARD bit can be monitored to determine when the CP goes inside the defined area.

Figure 6.12(g) Area Mode = 111

6.7 Graphic Drawing Processor

ACRTC Graphic Drawing is performed in units of logical pixels which may be programmed to consist of 1, 2, 4, 8 or 16 physical bits in the frame buffer.

In order to draw, the ACRTC Drawing Processor uses three operation control units.

(a) Drawing Algorithm Control Unit

Interprets graphic commands and parameters and executes the appropriate microprogrammed drawing algorithm. Note that this unit calculates coordinates using logical pixel X-Y addressing.

(b) Drawing Address Generation Unit

Converts logical X-Y addresses from the DACU to a bit address in the frame buffer. The frame buffer is organized as sequential 16 bit words. The bit address consists of a 20 bit address (1M word address space) and 0-4 bits specifying the logical pixel bit address within the physical frame buffer word.

(c) Logic Operation Unit

Using the address calculated in (a) and (b), performs logical operations between the existing (read) data in the frame buffer and the drawing pattern in the Pattern RAM, and rewrites the results to the frame buffer.

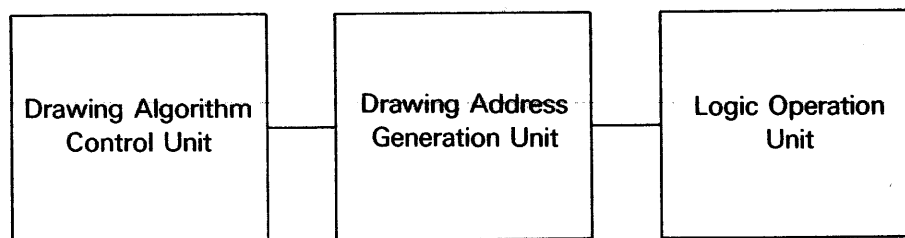


Figure 6.13 Drawing Processor

Bit Mode	Data (bit) per pixel	Color or color image number	Number of pixels per word
1 bit/pixel	1	1	16
2 bit/pixel	2	4	8
4 bit/pixel	4	16	4
8 bit/pixel	8	256	2
16 bit/pixel	16	65536	1

Figure 6.14(a) Bits per Pixel

Figure 6.14(b) Pixel Physical Address Specification

Bit Mode	1 Word Data Configuration	Linear Address (Dot Address)	Operation Offset
1 bit/pixel			1
2 bit/pixel			2
4 bit/pixel			4
8 bit/pixel			8
16 bit/pixel			16

*) don't care

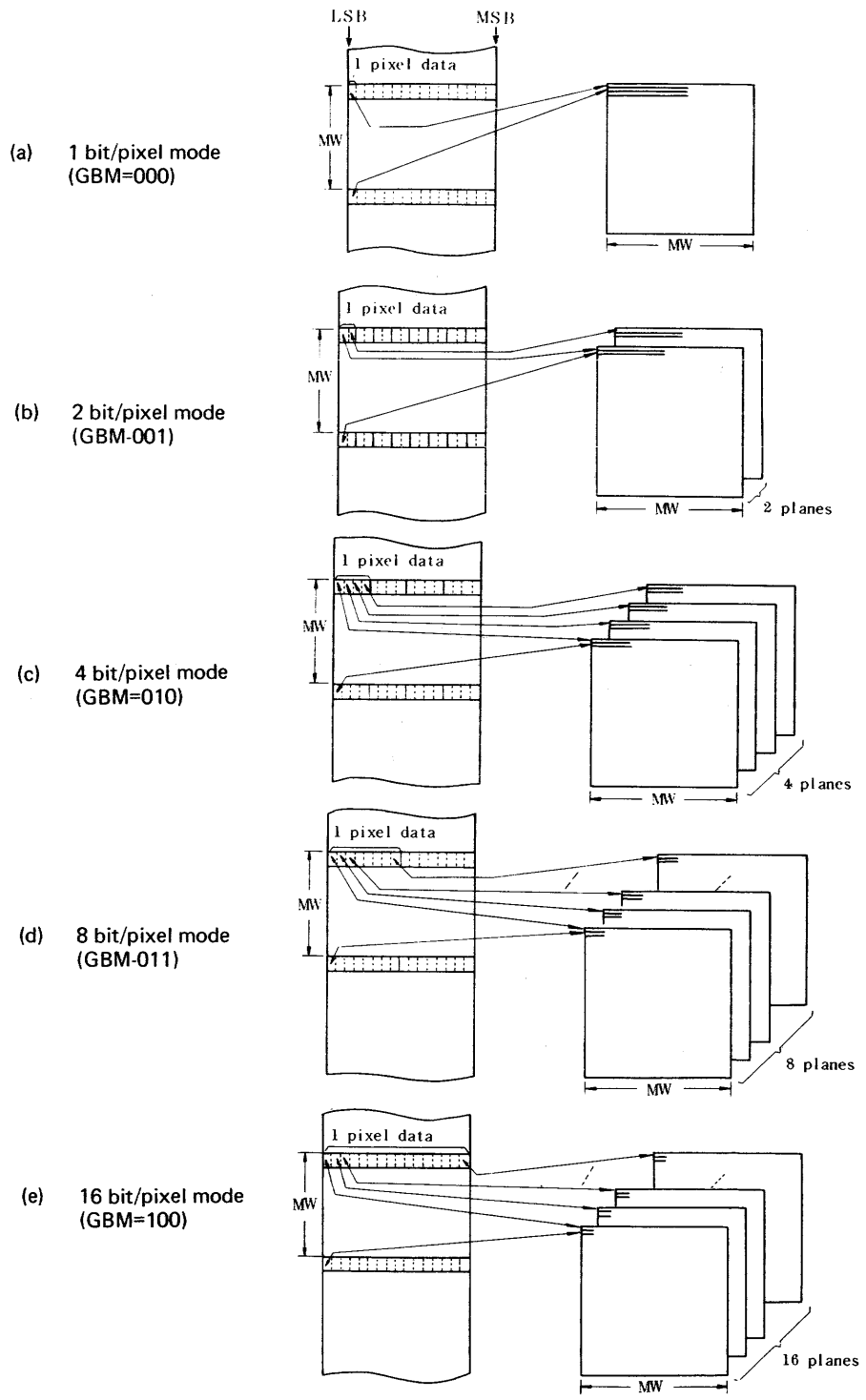


Figure 6.14(c) Logical/Physical Addressing

6.8 Graphic Drawing Operation

Since a logical pixel can consist of multiple bits of frame buffer, a logical pixel is said to contain color information. If a logical pixel is defined as 4 bits or frame buffer, 16 tones of gray scale or 16 colors can be associated with the logical pixel.

The ACRTC performs graphic drawing based on the unit of logical pixel including color information.

6.8.1 Pattern RAM

The 16 by 16 bit Pattern RAM contains the color pattern for graphic drawing. A sub-pattern to be used can be specified by defining the Pattern Start X, Y and Pattern End X, Y addresses. Furthermore, a specific starting point for pattern scanning is defined with the Pattern Pointer X, Y addresses.

6.8.2 One Pixel Drawing Operation

In this example, Color Register Indirect Drawing Mode is used.

Before the drawing color data. This data can be accessed by the MPU using the RPTN and WPTN (read and write Pattern RAM) commands. Also, the Drawing Parameter Registers must be initialized using the RPR and WPR (read and write Parameter Register) commands.

After the drawing command is issued, the ACRTC reads the 16 bit word in the frame buffer whose address was calculated by the Drawing Algorithm Control Unit (DACU) and Drawing Address Generation Unit (DAGU). Since the ACRTC reads 16 bit words from the frame buffer, in the case of 4 bits/logical pixel, 4 pixels are read at one time. However, the drawing is performed in units of one pixel. So, the ACRTC maintains an Internal Dot Pointer (IDP) which is used to mask the appropriate bits. In this example, the logical pixel is bits 4-7 of the word (Cc), so IDP contains is in bits 4-7 and 0s in other bits.

The IDP mask is also applied to the color registers to select one logical pixel (in this case 4 bits) of color information (C0 and C1).

Depending on the bit value in the Pattern RAM pointed to by Pattern Pointer X and Pattern Pointer Y, the color register is selected. If 0, Color Register 0 is used, if 1, Color Register 1 is used.

The fetched data (Cc) and selected color data (C0 and C1) are logically operated on based on 1 of 8 logical operation modes (OPM) specified with the drawing instruction. the resulting drawing data (Cy) is rewritten to the frame buffer.

Color Register drawing normally specifies the 'background' color in CL0 and the 'foreground' or 'drawing' color in CL1. In this case, a dashed line can easily be drawn by loading the dash pattern (0's for OFF, 1s for ON) into the Pattern RAM.

Note in this example (4 bits/pixel) that the color values C0 and C1 are normally repeated in the other three 4 bit subfields of the color register so that as IDP varies, the same colors will be used. However, there is no restriction in this regard. Each of the four 4 bit logical pixel subfields of Color Register 0 and 1 could be loaded with a different color value. Thus, as IDP varies, different colors will be selected from CL0 and CL1.

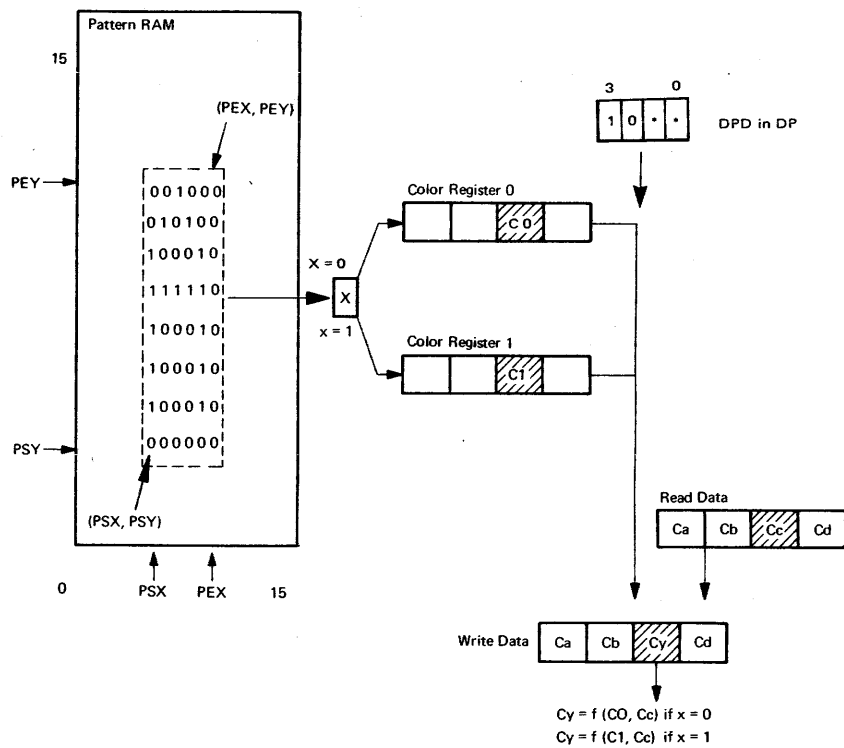


Figure 6.15 One Pixel Drawing Operation

6.8.3 Line Drawing Operation

The following describes an example of the LINE command using Color Register Indirect Drawing Mode and the 'Replace' operation mode.

For line drawing, the drawing pattern is limited to the 16 bit word pointed to by Pattern Pointer Y (PPY). A portion of the word can be extracted based on Pattern Start X and Pattern End X (PSX and PEX).

For the first pixel of the line, the Pattern RAM bit at PPX is used and Color Register 0 and 1 are selected based on this bit's value. The selected color is drawn. Then the Pattern RAM pointer is incremented and operation continues until PPX = PEX. Then, PPX is reset to PSX and operation continues. Note that the Pattern RAM horizontal scanning direction is independent of pixel drawing direction.

The drawing pattern can be magnified using the Pattern Zoom Factor (PZX and PZY). For line drawing, only PZX is applicable. The example uses PZX = 0 which is 'by 1' magnification. If PZX = 1 (by 2 magnification) was specified, the selected portion of the Pattern RAM would have each bit scanned twice. Thus, the example '1111101010' pattern would be interpreted as '11111111110011001100' during scanning.

6.8.4 Plane Drawing Operation

Figure 6.17(b) shows a Plane drawing example which also uses Color Register Indirect Drawing Mode and Replace Operation Mode.

For plane drawing commands (AFRCT, RFRCT, PAINT and PTN) a two dimensional portion of the Pattern RAM bounded by PSX,PSY and PEX,PEY is used. Pattern scanning starts at PPX and PPY. As each pixel is drawn, the Pattern scanning point is incremented independent of pixel drawing direction. The two dimensional pattern can be independently magnified (i.e. each pattern point repeatedly scanned) in the X and Y directions using the Pattern Zoom Factor (PZX, PZY).

Classification	Applicable Commands
Line drawing command	ALINE, RLINE, ARCT, RRCT, APLL, RPLL, APLG, RPLG, CRCL, ELPS, AARC, RARC, AEARC, REARC, DOT
Plane drawing command	AFRCT, RFRCT, PAINT, PTN

Figure 6.16 Line and Plane Drawing Commands

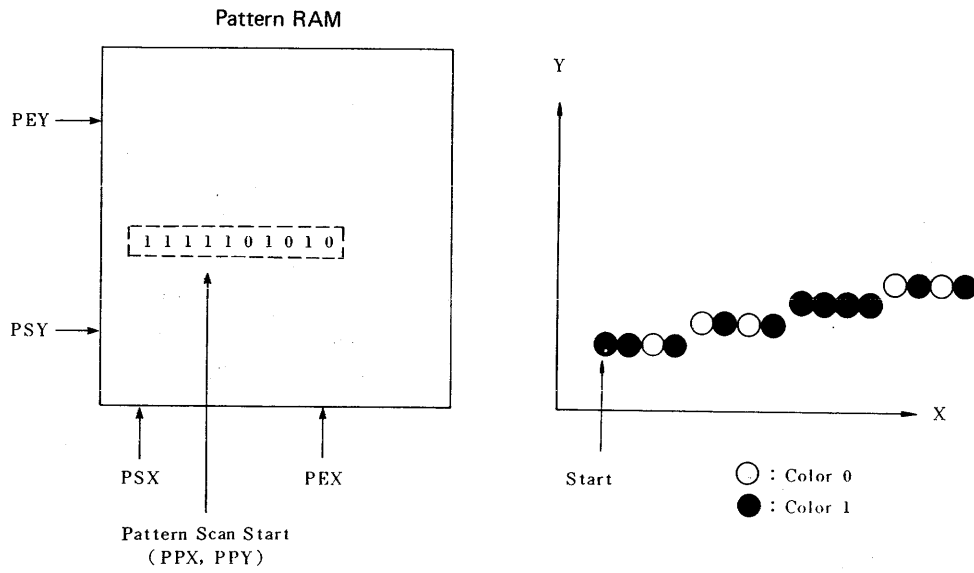


Figure 6.17(a) Line Drawing Example

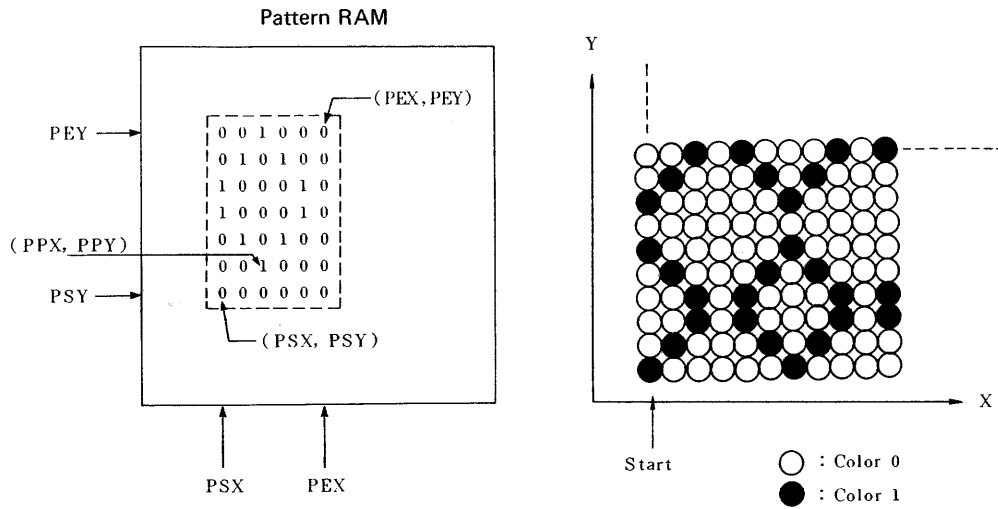


Figure 6.17(b) Plane Drawing Example

FUNCTION OF COMMANDS

COMMANDS

TYPE	MNEMONIC	COMMAND NAME	OPERATION CODE				PARAMETER	# (words)	~ (cycles)	
Register Access Command	ORG	Origin	0 0 0 0	0 1 0 0	0 0 0 0	0 0 0 0	DPH DPL	3	8	
	WPR	Write Parameter Register	0 0 0 0	1 0 0 0	0 0 0 0	RN	D	2	6	
	RPR	Read Parameter Register	0 0 0 0	1 1 0 0	0 0 0 0	RN		1	6	
	WPTN	Write Pattern RAM	0 0 0 1	1 0 0 0	0 0 0 0	PRA	n D ₁ , ..., D _n	n+2	4n+8	
	RPTN	Read Pattern RAM	0 0 0 1	1 1 0 0	0 0 0 0	PRA	n	2	4n+10	
Data Transfer Command	DRD	DMA Read	0 0 1 0	0 1 0 0	0 0 0 0	0 0 0 0	AX AY	3	(4x+8)y+12[x·y/8↑]+(62~68)	
	DWT	DMA Write	0 0 1 0	1 0 0 0	0 0 0 0	0 0 0 0	AX AY	3	(4x+8)y+16[x·y/8↑]+34	
	DMOD	DMA Modify	0 0 1 0	1 1 0 0	0 0 0 0	0 0 0 0	MM AX AY	3	(4x+8)y+16[x·y/8↑]+34	
	RD	Read	0 1 0 0	0 1 0 0	0 0 0 0	0 0 0 0		1	12	
	WT	Write	0 1 0 0	1 0 0 0	0 0 0 0	0 0 0 0	D	2	8	
	MOD	Modify	0 1 0 0	1 1 0 0	0 0 0 0	0 0 0 0	MM D	2	8	
	CLR	Clear	0 1 0 1	1 0 0 0	0 0 0 0	0 0 0 0	D AX AY	4	(2x+8)y+12	
	SCLR	Selective Clear	0 1 0 1	1 1 0 0	0 0 0 0	0 0 0 0	MM D AX AY	4	(4x+6)y+12	
	CPY	Copy	0 1 1 0	S DSD	0 0 0 0	0 0 0 0	SAH SAL AX AY	5	(6x+10)y+12	
	SCPY	Selective Copy	0 1 1 1	S DSD	0 0 0 0	0 0 0 0	MM SAH SAL AX AY	5	(6x+10)y+12	
	Graphic Command	AMOVE	Absolute Move	1 0 0 0	0 0 0 0	0 0 0 0	0 0 0 0	X Y	3	56
RMOVE		Relative Move	1 0 0 0	0 1 0 0	0 0 0 0	0 0 0 0	dX dY	3	56	
ALINE		Absolute Line	1 0 0 0	1 0 0 0	AREA	COL OPM	X Y	3	P·L+18	
RLINE		Relative Line	1 0 0 0	1 1 0 0	AREA	COL OPM	dX dY	3	P·L+18	
ARCT		Absolute Rectangle	1 0 0 1	0 0 0 0	AREA	COL OPM	X Y	3	2P(A+B)+54	
RRCT		Relative Rectangle	1 0 0 1	0 1 0 0	AREA	COL OPM	dX dY	3	2P(A+B)+54	
APLL		Absolute Polyline	1 0 0 1	1 0 0 0	AREA	COL OPM	n X ₁ , Y ₁ , ..., X _n , Y _n	2n+2	Σ[P·L+16]+8	
RPLL		Relative Polyline	1 0 0 1	1 1 0 0	AREA	COL OPM	n dX ₁ , dY ₁ , ..., dX _n , dY _n	2n+2	Σ[P·L+16]+8	
APLG		Absolute Polygon	1 0 1 0	0 0 0 0	AREA	COL OPM	n X ₁ , Y ₁ , ..., X _n , Y _n	2n+2	Σ[P·L+16]+P·Lo+20	
RPLC		Relative Polygon	1 0 1 0	0 1 0 0	AREA	COL OPM	n dX ₁ , dY ₁ , ..., dX _n , dY _n	2n+2	Σ[P·L+16]+P·Lo+20	
CRCL		Circle	1 0 1 0	1 0 0 0	AREA	COL OPM	r	2	8d+66	
ELPS		Ellipse	1 0 1 0	1 1 0 0	AREA	COL OPM	a b dX	4	10d+90	
AARC		Absolute Arc	1 0 1 1	0 0 0 0	AREA	COL OPM	Xc Yc Xe Ye	5	8d+18	
RARC		Relative Arc	1 0 1 1	0 1 0 0	AREA	COL OPM	dXc dYc dXe dYe	5	8d+18	
AEARC		Absolute Ellipse Arc	1 0 1 1	1 0 0 0	AREA	COL OPM	a b Xc Yc Xe Ye	7	10d+96	
REARC		Relative Ellipse Arc	1 0 1 1	1 1 0 0	AREA	COL OPM	a b dXc dYc dXe dYe	7	10d+96	
AFRCT		Absolute Filled Rectangle	1 1 0 0	0 0 0 0	AREA	COL OPM	X Y	3	(P·A+B)B+18	
RFRCT		Relative Filled Rectangle	1 1 0 0	0 1 0 0	AREA	COL OPM	dX dY	3	(P·A+B)B+18	
PAINT		Paint	1 1 0 0	1 0 0 0	AREA	COL OPM		1	(18A+102)B-58 *1)	
DOT		Dot	1 1 0 0	1 1 0 0	AREA	COL OPM		1	8	
PTN		Pattern	1 1 0 1	SL SD	AREA	COL OPM	SZ	*2)	2	(P·A+10)B+20
AGCPY		Absolute Graphic Copy	1 1 1 0	S DSD	AREA	0 0 OPM	Xs Ys DX DY	5	((P+2)A+10)B+70	
RGCPY		Relative Graphic Copy	1 1 1 1	S DSD	AREA	0 0 OPM	dXs dYs DX DY	5	((P+2)A+10)B+70	

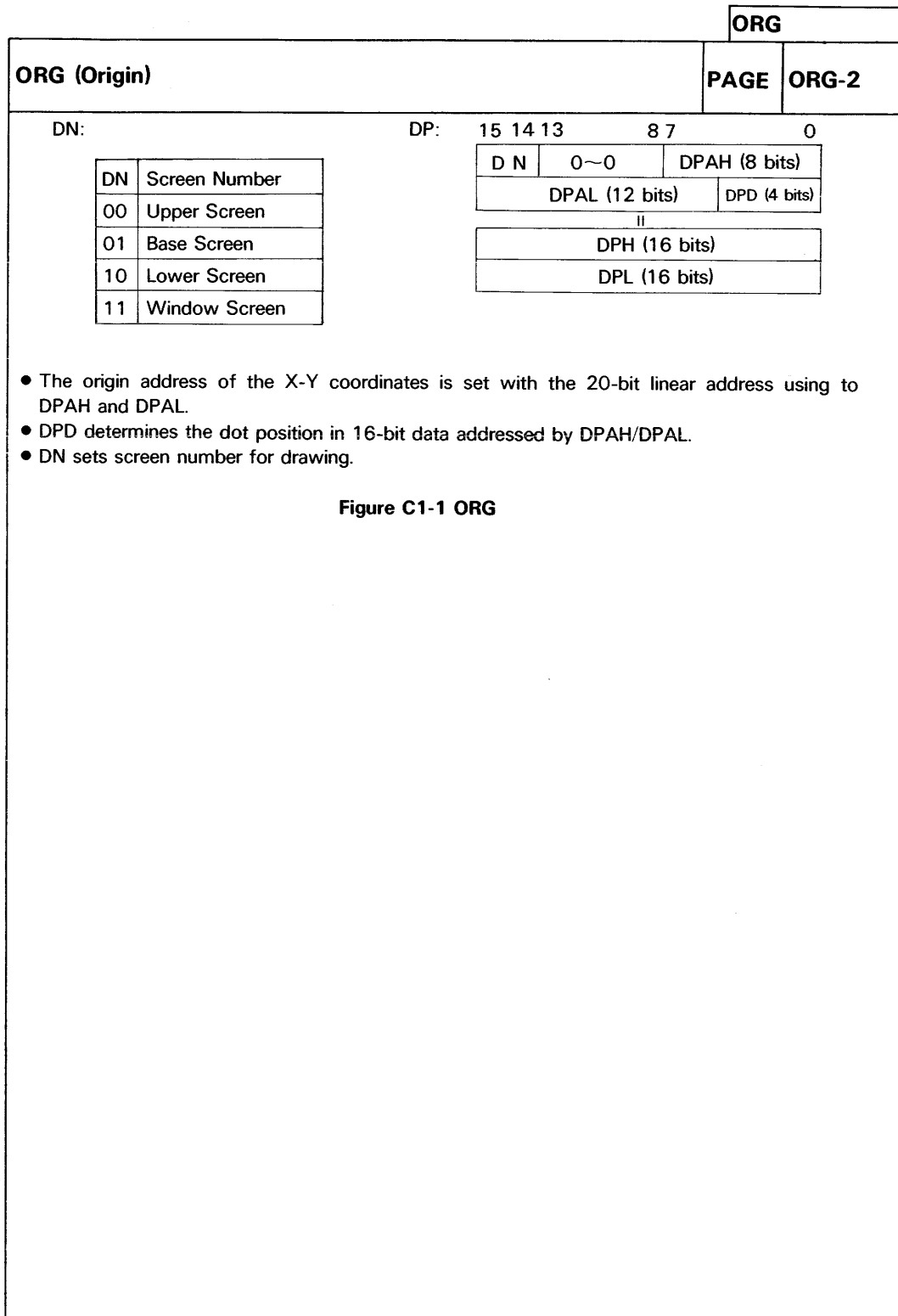
*1) In case of rectangular filling

*2) SZ: $\begin{matrix} 15 & 87 & 0 \\ \boxed{SZy} & \boxed{SZx} & \end{matrix}$ SZy, SZx: Pattern Size

n: number of repetition x/y: drawing words of x-direction/y-direction L/Lo/d: sum of drawing dots A/B: drawing dots of main/sub direction
E: [E=0 (stop at Edge color), E=1 (stop at excepting Edge color)] C: [C=1 (clock wise), C=0 (reverse)] [↑]: rounding up

P= {4: OPM-000 ~ 011
6: OPM-100 ~ 111

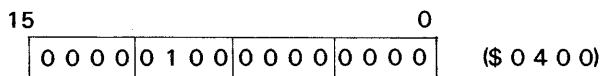
		ORG							
[1] ORG (Origin)		PAGE	ORG-1						
<p>< FUNCTION > Associates a logical X-Y screen origin with a physical frame buffer address.</p> <p>< MNEMONIC > ORG DPH,DPL</p>		TYPE	Register Access Command						
<p>< FORMAT ></p> <p>COMMAND CODE hexadecimal notation</p> <p>15 0</p> <table border="1" style="margin-left: 20px;"> <tr> <td style="width: 40px;">0 0 0 0</td> <td style="width: 40px;">0 1 0 0</td> <td style="width: 40px;">0 0 0 0</td> <td style="width: 40px;">0 0 0 0</td> </tr> </table> <p style="margin-left: 20px;">(\$ 0 4 0 0)</p> <p>COMMAND PARAMETERS</p> <p>15 0</p> <table border="1" style="margin-left: 20px;"> <tr> <td style="width: 100px; text-align: center;">DPH</td> </tr> </table> <p>15 0</p> <table border="1" style="margin-left: 20px;"> <tr> <td style="width: 100px; text-align: center;">DPL</td> </tr> </table>		0 0 0 0	0 1 0 0	0 0 0 0	0 0 0 0	DPH	DPL	WORD NUMBER Wn=3	EXECUTION CYCLES Cn=8
0 0 0 0	0 1 0 0	0 0 0 0	0 0 0 0						
DPH									
DPL									
<p>< DESCRIPTION ></p> <p>The ORG command must be issued to the ACRTC prior to graphic drawing. ORG defines the logical X-Y coordinate origin upon which all graphic drawing addresses are based and sets the screen number in which to draw.</p> <p>The DPH and DPL (Drawing Pointer High, Low) parameters establish the physical address in the frame buffer at which the origin is set. This physical address is composed of the following three components – DN (Screen Number) is a screen designator, DPAH, DPAL (Drawing Pointer Address High, Low) is a 20 bit address selecting one of 1 megawords in the frame buffer and DPD (Drawing Pointer Dot) specifies the bit field associated with the addressed logical pixel.</p> <p>The ORG command initializes the Drawing Pointer (DP) to the origin and clears the Current Pointer (CP).</p>									



< EXAMPLE >

The origin for the Upper screen (screen number 0) is set to bit position 4-7 at frame buffer word address \$25. 4 bits per logical pixel and Memory Width (MW) = \$10 are assumed.

COMMAND CODE



COMMAND PARAMETERS

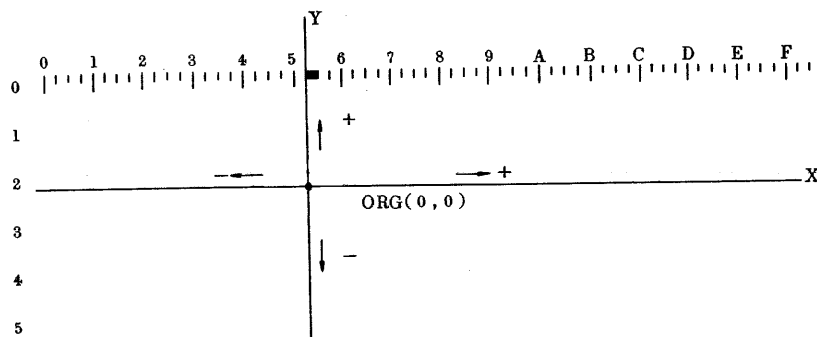
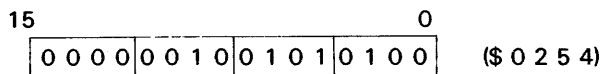
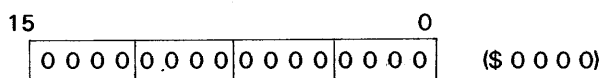


Figure C1-2 ORG Execution Example

WPR						
[2] WPR (Write Parameter Register)	PAGE	WPR-1				
<p>< FUNCTION > Write the contents of the Drawing Parameter Registers.</p> <p>< MNEMONIC > WPR (RN) D</p>	TYPE	Register Access Command				
<p>< FORMAT ></p> <p>COMMAND CODE</p> <div style="display: flex; align-items: center; justify-content: space-between;"> 15 0 </div> <table border="1" style="margin-left: auto; margin-right: auto; text-align: center;"> <tr> <td style="width: 40px;">0 0 0 0</td> <td style="width: 40px;">1 0 0 0</td> <td style="width: 40px;">0 0 0 0</td> <td style="width: 40px;">RN</td> </tr> </table> <div style="display: flex; align-items: center; justify-content: center; margin-top: 5px;"> hexadecimal notation (\$ 0 8 0 X) </div> <div style="display: flex; align-items: center; justify-content: center; margin-top: 5px;"> 5 bits </div> <p>COMMAND PARAMETERS</p> <div style="display: flex; align-items: center; justify-content: space-between;"> 15 0 </div> <table border="1" style="margin-left: auto; margin-right: auto; text-align: center;"> <tr> <td style="width: 100px;">D (Data)</td> </tr> </table>	0 0 0 0	1 0 0 0	0 0 0 0	RN	D (Data)	<p>WORD NUMBER Wn=2</p> <p>EXECUTION CYCLES Cn=6</p>
0 0 0 0	1 0 0 0	0 0 0 0	RN			
D (Data)						
<p>< DESCRIPTION ></p> <p>The Drawing Parameter Register number to be written is specified in the RN (Register Number) field of the op-code. The contents of the parameter (D) is written to the selected register.</p>						

WPR (Write Parameter Register)		WPR	
		PAGE	WPR-2
<p>< EXAMPLE > The value \$1111 is written to the CL1 (Color 1) of the drawing parameter register.</p>			
<p>COMMAND CODE</p>			
15		0	
	0 0 0 0	1 0 0 0	0 0 0 0 0 0 1 (\$ 0 8 0 1)
<p>COMMAND PARAMETERS</p>			
15		0	
	0 0 0 1	0 0 0 1	0 0 0 1 0 0 0 1 (\$ 1 1 1 1)
<p>< Color Register > RN=01</p>			
	15 14 13 12 11 10 9 8 7 6 5 4 3 2 1 0		
	0 0 0 1	0 0 0 1	0 0 0 1 0 0 0 1

Figure C2-1 WPR Execution Example

		RPR	
[3] RPR (Read Parameter Register)		PAGE	RPR-1
<p>< FUNCTION > Read the contents of the Drawing Parameter Registers.</p> <p>< MNEMONIC > RPR (RN)</p>		TYPE	Register Access Command
<p>< FORMAT ></p> <p>COMMAND CODE</p> <div style="display: flex; align-items: center; justify-content: center;"> <div style="text-align: right; margin-right: 5px;">15</div> <div style="border: 1px solid black; padding: 2px; display: flex; align-items: center; gap: 2px;"> 00001100000 </div> <div style="margin-left: 5px; text-align: left;">0</div> </div> <p style="margin-left: 100px;">hexadecimal notation</p> <div style="display: flex; align-items: center; margin-left: 100px;"> <div style="border: 1px solid black; padding: 2px; margin-right: 5px;">RN</div> (\$ 0 C 0 X) </div> <p style="margin-left: 100px;">5 bits</p> <p>COMMAND PARAMETERS - NON -</p>		WORD NUMBER W _n =1	EXECUTION CYCLES C _n =6
<p>< DESCRIPTION ></p> <p>The Drawing Parameter Register number to be read is specified in the RN (Register Number) field of the command code. After execution, the contents of the specified Drawing Parameter Register is loaded into the Read FIFO.</p>			

< EXAMPLE >

The value \$1111 in the Drawing Parameter Register (Color Register 1: CL1) is loaded into the Read FIFO.

COMMAND CODE

15	0	
0	0	0
0	0	0
1	1	0
0	0	0
0	0	0
0	0	1

(\$ 0 C 0 1)

COMMAND PARAMETER

- NON -

< Color Register 1 >

15	0	
0	0	0
0	0	0
1	0	0
0	0	0
0	0	0
1	0	0
0	0	0
0	0	1

< Read FIFO >

15	0	
0	0	0
0	0	0
1	0	0
0	0	0
0	0	0
1	0	0
0	0	0
0	0	1

Figure C3-1 RPR Execution Example

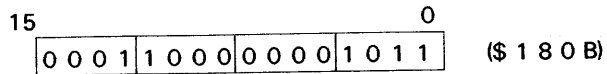
		WPTN																
[4] WPTN (Write Pattern RAM)		PAGE	WPTN-1															
<p>< FUNCTION > Write data to the Pattern RAM.</p> <p>< MNEMONIC > WPTN (PRA) n, D1, D2, ... Dn</p>		TYPE	Register Access Command															
<p>< FORMAT ></p> <p>COMMAND CODE hexadecimal notation</p> <p style="text-align: center;">15 0</p> <table border="1" style="margin-left: auto; margin-right: auto;"> <tr> <td style="text-align: center;">0</td> <td style="text-align: center;">0</td> <td style="text-align: center;">0</td> <td style="text-align: center;">1</td> <td style="text-align: center;">1</td> <td style="text-align: center;">0</td> <td style="text-align: center;">0</td> <td style="text-align: center;">0</td> <td style="text-align: center;">0</td> <td style="text-align: center;">0</td> <td style="text-align: center;">0</td> <td style="text-align: center;">PRA</td> </tr> </table> <p style="text-align: center;">(\$ 1 8 0 X)</p> <p>COMMAND PARAMETERS</p> <p style="text-align: center;">15 0</p> <table border="1" style="margin-left: auto; margin-right: auto;"> <tr> <td style="text-align: center;">n (Number of Words)</td> </tr> </table> <p style="text-align: center;">15 0</p> <table border="1" style="margin-left: auto; margin-right: auto;"> <tr> <td style="text-align: center;">D1 (Pattern Data)</td> </tr> </table> <p style="text-align: center;">⋮</p> <p style="text-align: center;">15 0</p> <table border="1" style="margin-left: auto; margin-right: auto;"> <tr> <td style="text-align: center;">Dn (Pattern Data)</td> </tr> </table>		0	0	0	1	1	0	0	0	0	0	0	PRA	n (Number of Words)	D1 (Pattern Data)	Dn (Pattern Data)	<p>WORD NUMBER $W_n = n + 2$</p> <p>EXECUTION CYCLES $C_n = 4n + 8$</p>	
0	0	0	1	1	0	0	0	0	0	0	PRA							
n (Number of Words)																		
D1 (Pattern Data)																		
Dn (Pattern Data)																		
<p>< DESCRIPTION ></p> <p>WPTN command is used to write data into the Pattern RAM.</p> <p>Pattern RAM Address (PRA) of \$0~\$F is allocated to the Pattern RAM and each PRA represents 1 word (16 bits) of pattern RAM.</p> <p>The PRA (Pattern RAM Address) field of the command code selects the Pattern RAM word address at which writing starts. The first parameter is n, the number of words to be written. This is followed by n data words (D1-Dn).</p> <p>For the 8-bit interface, 1 word is divided into high and low bytes. The pattern data is sent in the order of the high byte, then the low byte. The first parameter n must be set to (the number of words) × 2. (In this case writing in unit of byte is not allowed.)</p>																		

WPTN (Write Pattern RAM)

< EXAMPLE >

Two words of data, \$2314 and \$5713, are written to the Pattern RAM beginning at address \$B.

COMMAND CODE



COMMAND PARAMETERS

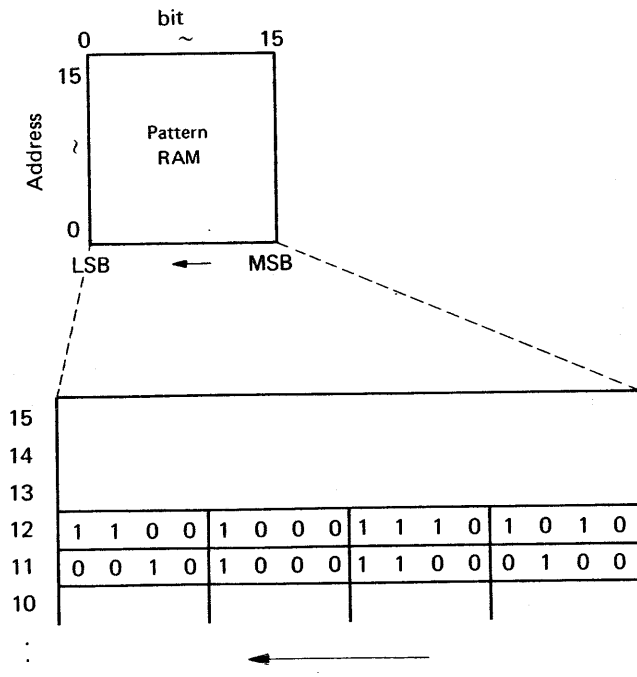
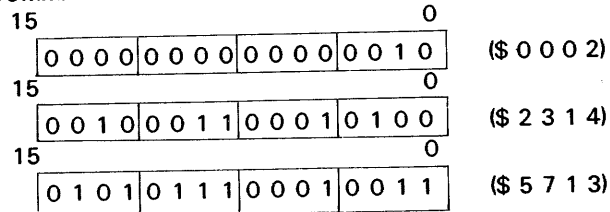


Figure C4-1 WPTN Execution Example

		RPTN														
[5] RPTN (Read Pattern RAM)		PAGE	RPTN-1													
<p>< FUNCTION > Read Data from the Pattern RAM.</p> <p>< MNEMONIC > RPTN (PRA) n</p>		TYPE	Register Access Command													
<p>< FORMAT ></p> <p>COMMAND CODE hexadecimal notation</p> <p style="text-align: center;">15 0</p> <table border="1" style="margin-left: auto; margin-right: auto;"> <tr> <td style="text-align: center;">0</td> <td style="text-align: center;">0</td> <td style="text-align: center;">0</td> <td style="text-align: center;">1</td> <td style="text-align: center;">1</td> <td style="text-align: center;">1</td> <td style="text-align: center;">0</td> <td style="text-align: center;">0</td> <td style="text-align: center;">0</td> <td style="text-align: center;">0</td> <td style="text-align: center;">0</td> <td style="text-align: center;">PRA</td> </tr> </table> <p style="text-align: center;">(\$ 1 C 0 X)</p> <p>COMMAND PARAMETERS</p> <p style="text-align: center;">15 0</p> <table border="1" style="margin-left: auto; margin-right: auto;"> <tr> <td style="text-align: center; width: 100px;">n (Number of word)</td> </tr> </table>		0	0	0	1	1	1	0	0	0	0	0	PRA	n (Number of word)	<p>WORD NUMBER Wn=2</p> <p>EXECUTION CYCLES Cn=4n+10</p>	
0	0	0	1	1	1	0	0	0	0	0	PRA					
n (Number of word)																
<p>< DESCRIPTION ></p> <p>RPTN command is used to read the data in the Pattern RAM.</p> <p>Pattern RAM address (PRA) of \$0~\$F is allocated to the Pattern RAM and each PRA represents 1 word (16 bits) of Pattern RAM.</p> <p>The PRA (Pattern RAM Address) field of the command code select the Pattern RAM word address at which reading starts. The parameter n specifies the number of words to be read. The specified Pattern RAM contents are loaded into the Read FIFO.</p> <p>For the 8 bit interface, 1 word of the pattern RAM is divided into high and the low bytes. The pattern data is put into the Read FIFO in the order of the high byte, the low byte.</p>																

RPTN (Read Pattern RAM)

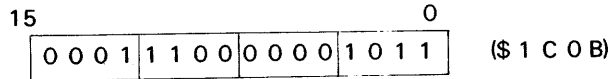
PAGE

RPTN-2

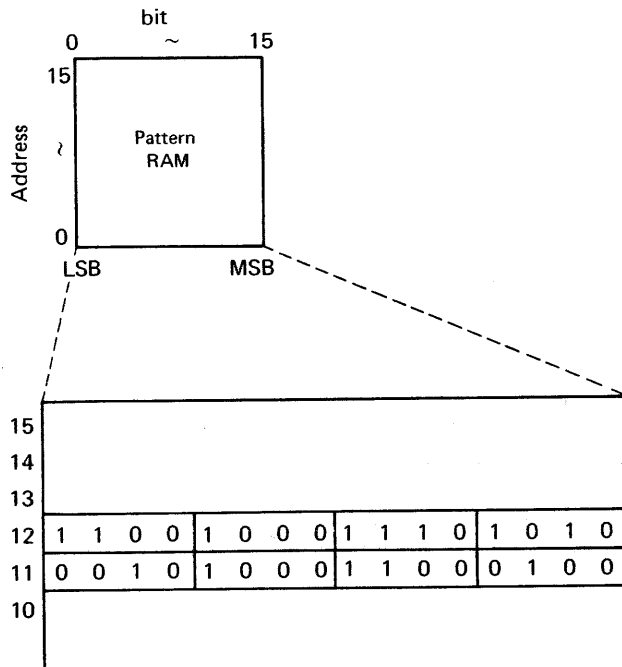
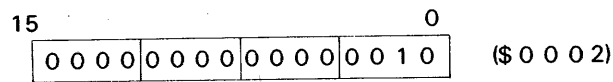
< EXAMPLE >

Two words of data, \$2314 and \$5713 from the Pattern RAM beginning from address \$B is placed in the Read FIFO.

COMMAND CODE



COMMAND PARAMETERS



Read FIFO

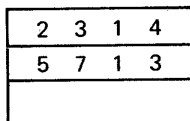
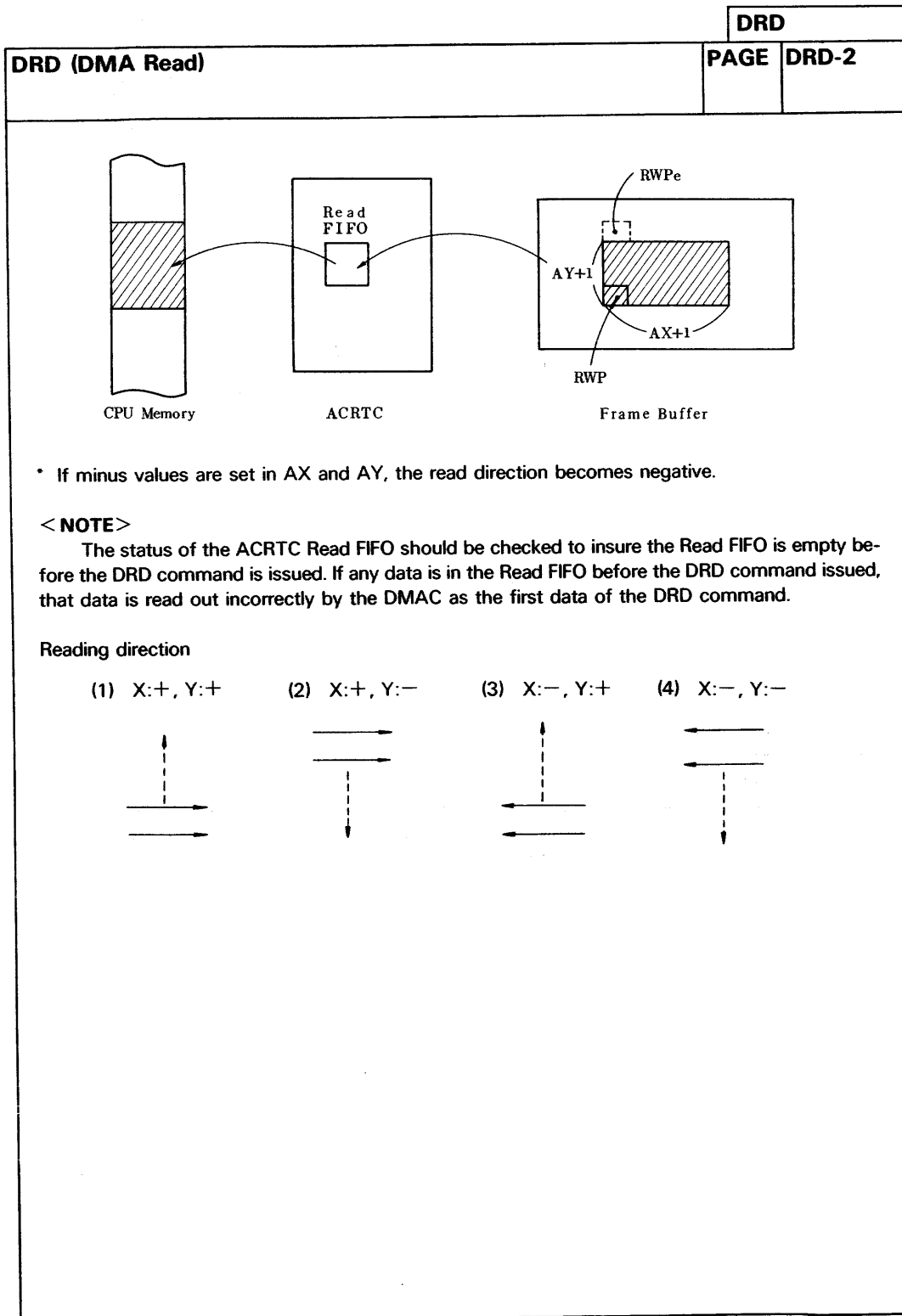
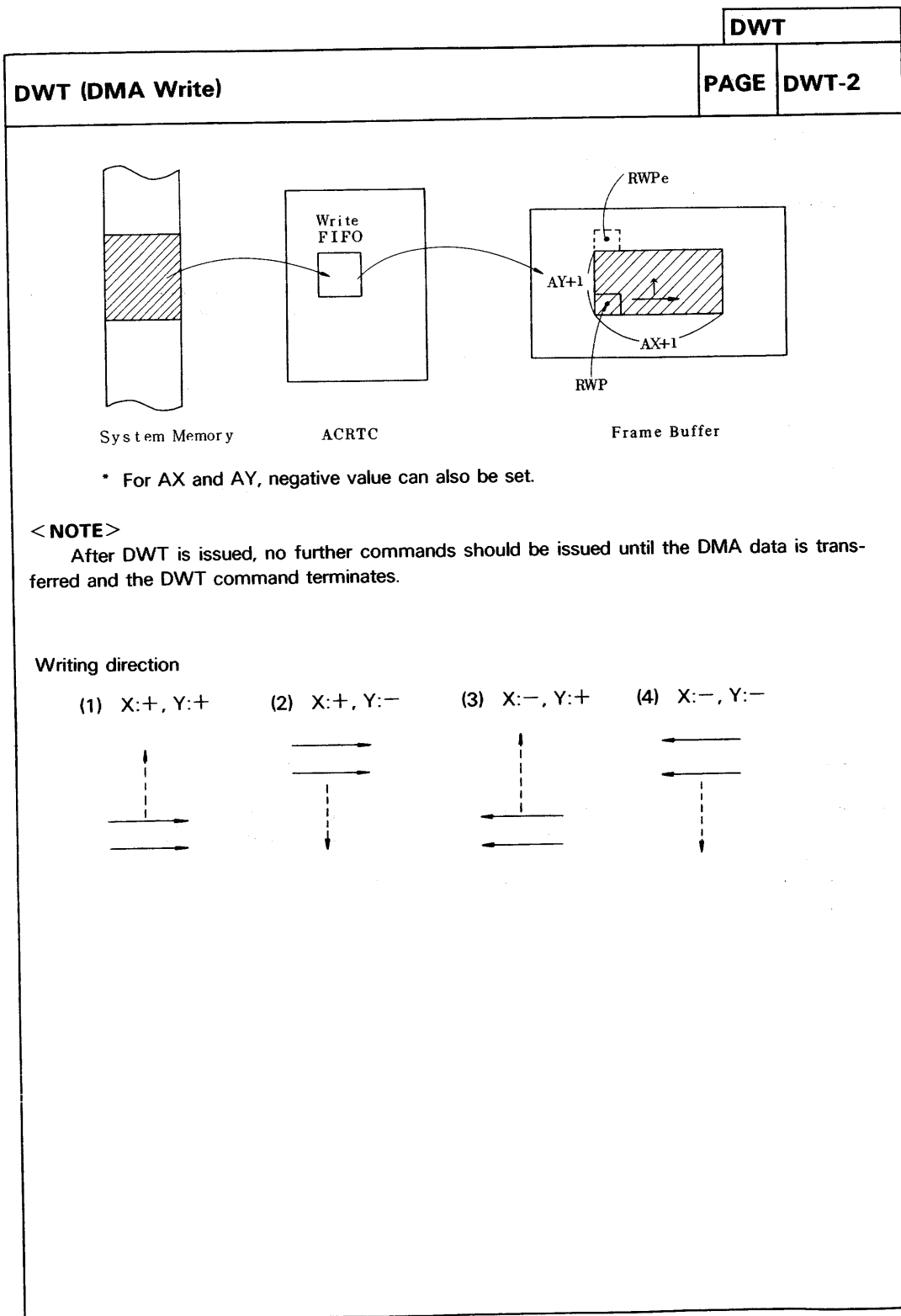


Figure C5-1 RPTN Execution Example

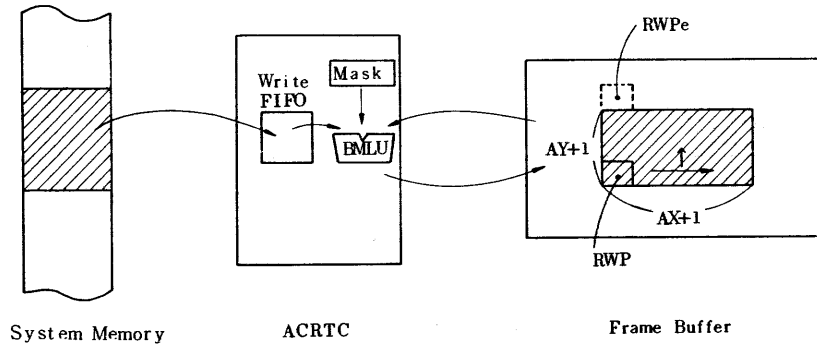
		DRD																			
[6] DRD (DMA Read)		PAGE	DRD-1																		
<p>< FUNCTION > Transfer data from the frame buffer to the MPU system memory.</p> <p>< MNEMONIC > DRD AX, AY</p>		TYPE	Data Transfer Command																		
<p>< FORMAT ></p> <p>COMMAND CODE hexadecimal notation</p> <p>15 0</p> <table border="1" style="margin-left: 20px;"> <tr> <td>0</td><td>0</td><td>1</td><td>0</td><td>0</td><td>1</td><td>0</td><td>0</td><td>0</td><td>0</td><td>0</td><td>0</td><td>0</td><td>0</td><td>0</td><td>0</td> </tr> </table> <p style="margin-left: 100px;">(\$ 2 4 0 0)</p> <p>COMMAND PARAMETERS</p> <p>15 0</p> <table border="1" style="margin-left: 20px; width: 100px;"> <tr> <td style="text-align: center;">AX</td> </tr> </table> <p>15 0</p> <table border="1" style="margin-left: 20px; width: 100px;"> <tr> <td style="text-align: center;">AY</td> </tr> </table>		0	0	1	0	0	1	0	0	0	0	0	0	0	0	0	0	AX	AY	<p>WORD NUMBER Wn=3</p> <p>EXECUTION CYCLES Cn = $(4x+8)y+12 \left\lceil \frac{x \cdot y}{8} \right\rceil + (62 \sim 68)$</p> <p>x = AX + 1 y = AY + 1</p>	
0	0	1	0	0	1	0	0	0	0	0	0	0	0	0	0						
AX																					
AY																					
<p>< DESCRIPTION ></p> <p>DRD command causes the ACRTC to enter DMA Data Transfer Mode in which the ACRTC will control the external DMAC to transfer data (in unit of words) from the rectangular area in the frame buffer to the MPU memory. The frame buffer data origin must be predefined in the Read Write Pointer (RWP). The parameters of the command define the frame buffer area to be read in units of physical frame buffer words. At the end of DRD command execution, RWP will be set to RWPe.</p>																					



DWT															
[7] DWT (DMA Write)	PAGE	DWT-1													
<p>< FUNCTION > Transfer data from the MPU system memory to the frame buffer.</p> <p>< MNEMONIC > DWT AX, AY</p>	TYPE	Data Transfer Command													
<p>< FORMAT ></p> <p>COMMAND CODE hexadecimal notation</p> <p style="text-align: center;">15 0</p> <table border="1" style="margin-left: auto; margin-right: auto;"> <tr> <td style="width: 40px; text-align: center;">0</td> <td style="width: 40px; text-align: center;">0</td> <td style="width: 40px; text-align: center;">1</td> <td style="width: 40px; text-align: center;">0</td> <td style="width: 40px; text-align: center;">0</td> <td style="width: 40px; text-align: center;">0</td> <td style="width: 40px; text-align: center;">0</td> <td style="width: 40px; text-align: center;">0</td> <td style="width: 40px; text-align: center;">0</td> <td style="width: 40px; text-align: center;">0</td> <td style="width: 40px; text-align: center;">0</td> <td style="width: 40px; text-align: center;">0</td> </tr> </table> <p style="text-align: right;">(\$ 2 8 0 0)</p> <p>COMMAND PARAMETERS</p> <p style="text-align: center;">15 0</p> <table border="1" style="margin-left: auto; margin-right: auto; width: 80%;"> <tr> <td style="width: 100px; text-align: center;">AX</td> </tr> </table> <p style="text-align: center;">15 0</p> <table border="1" style="margin-left: auto; margin-right: auto; width: 80%;"> <tr> <td style="width: 100px; text-align: center;">AY</td> </tr> </table>	0	0	1	0	0	0	0	0	0	0	0	0	AX	AY	<p>WORD NUMBER W_n=3</p> <p>EXECUTION CYCLES C_n= (4x+8)y+16 $\left\lceil \frac{xy}{8} \right\rceil$ +34 $\begin{cases} x = AX + 1 \\ y = AY + 1 \end{cases}$</p>
0	0	1	0	0	0	0	0	0	0	0	0				
AX															
AY															
<p>< DESCRIPTION ></p> <p>DWT command causes the ACRTC to enter DMA Data Transfer Mode in which the ACRTC will control the external DMAC to transfer data (in unit of words) from the MPU memory to the rectangular area in the frame buffer. The frame buffer data origin must be predefined in the Read Write Pointer (RWP). The parameters of the command (AX, AY) define the frame buffer area to be written in units of physical frame buffer words. At the end of DWT command execution, RWP will be set to RWPe.</p>															



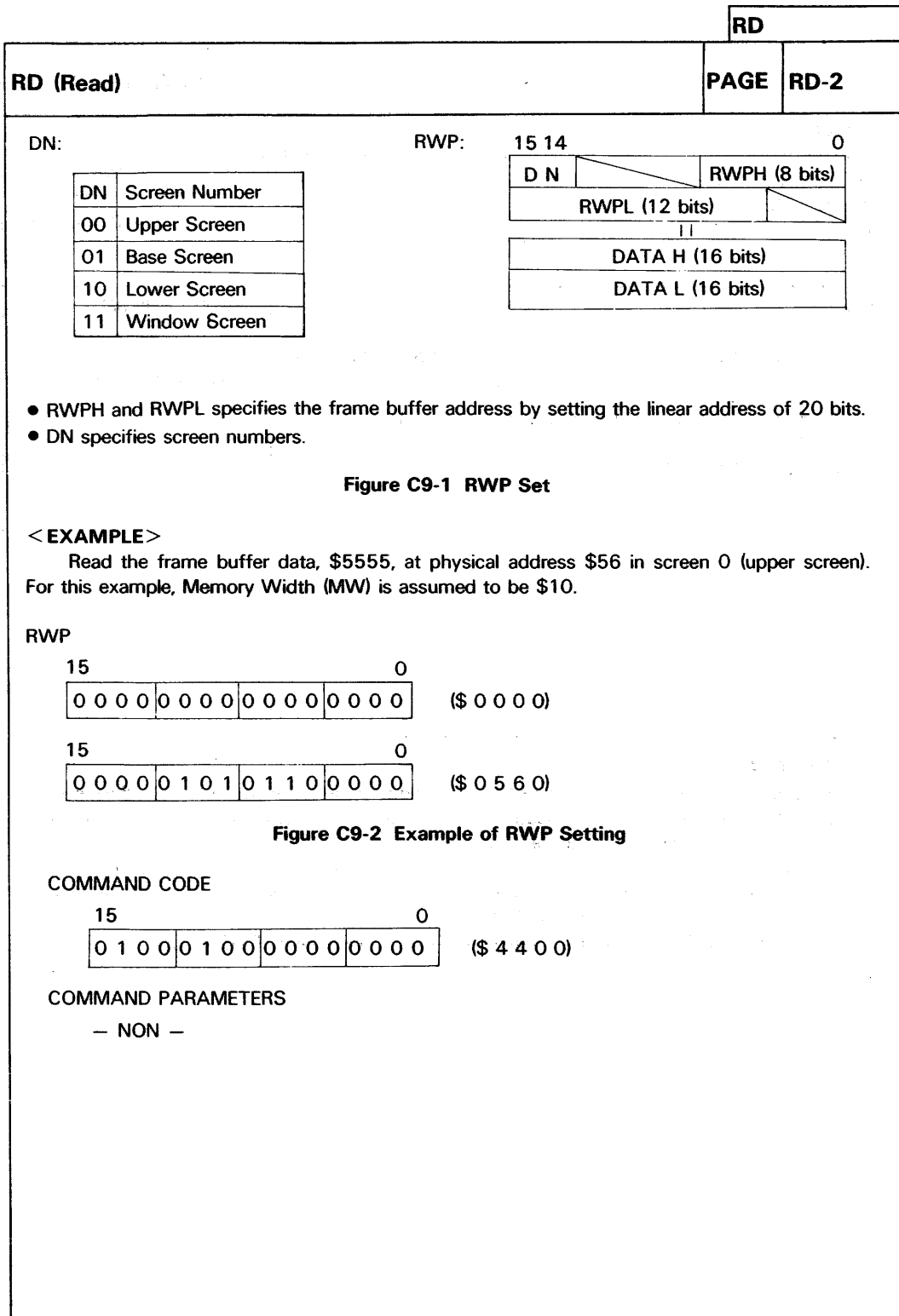
		DMOD	
[8] DMOD (DMA Modify)		PAGE	DMOD-1
<p>< FUNCTION > Transfer data from the MPU system memory to the frame buffer subject to logical modification.</p> <p>< MNEMONIC > DMOD (MM) AX, AY</p>		TYPE	Data Transfer Command
<p>< FORMAT ></p> <p>COMMAND CODE hexadecimal notation</p> <div style="display: flex; align-items: center; justify-content: center;"> <div style="text-align: right; margin-right: 5px;">15</div> <div style="border: 1px solid black; padding: 2px; display: flex; align-items: center; justify-content: center; gap: 2px;"> 0 0 1 0 1 1 0 0 0 0 0 0 0 0 MM </div> <div style="text-align: left; margin-left: 5px;">0</div> </div> <p style="margin-left: 100px;">(\$ 2 C 0 X)</p> <p>COMMAND PARAMETERS</p> <div style="margin-bottom: 10px;"> <div style="display: flex; align-items: center; justify-content: center;"> <div style="text-align: right; margin-right: 5px;">15</div> <div style="border: 1px solid black; padding: 2px; display: flex; align-items: center; justify-content: center; width: 100px;">AX</div> <div style="text-align: left; margin-left: 5px;">0</div> </div> </div> <div> <div style="display: flex; align-items: center; justify-content: center;"> <div style="text-align: right; margin-right: 5px;">15</div> <div style="border: 1px solid black; padding: 2px; display: flex; align-items: center; justify-content: center; width: 100px;">AY</div> <div style="text-align: left; margin-left: 5px;">0</div> </div> </div>		<p>WORD NUMBER Wn=3</p> <p>EXECUTION CYCLES $C_n = (4x + 8)y + 16 \left\lceil \frac{xy}{8} \right\rceil + 34$ $\begin{cases} x = AX + 1 \\ y = AY + 1 \end{cases}$ </p>	
<p>< DESCRIPTION ></p> <p>DMOD causes the ACRTC to enter DMA Data Transfer Mode in which the ACRTC will control the external DMAC to modify data in the rectangular area in the frame buffer using data in the MPU memory (in unit of words). The frame buffer data origin must be predefined in the Read Write Pointer (RWP). The parameters of the command (AX, AY) define the frame buffer area to be written in units of physical frame buffer words. At the end of DMOD command execution, RWP will be set to RWPe.</p> <p>The MM (Modify Mode) field of the command code specifies the DMA data transfer modify mode. Each pixel transferred from MPU system memory is logically operated on the corresponding pixel from the frame buffer, and the result is rewritten to the frame buffer. Logic operation can be enabled and disabled on a bit by bit basis based on the contents of the MASK register.</p>			

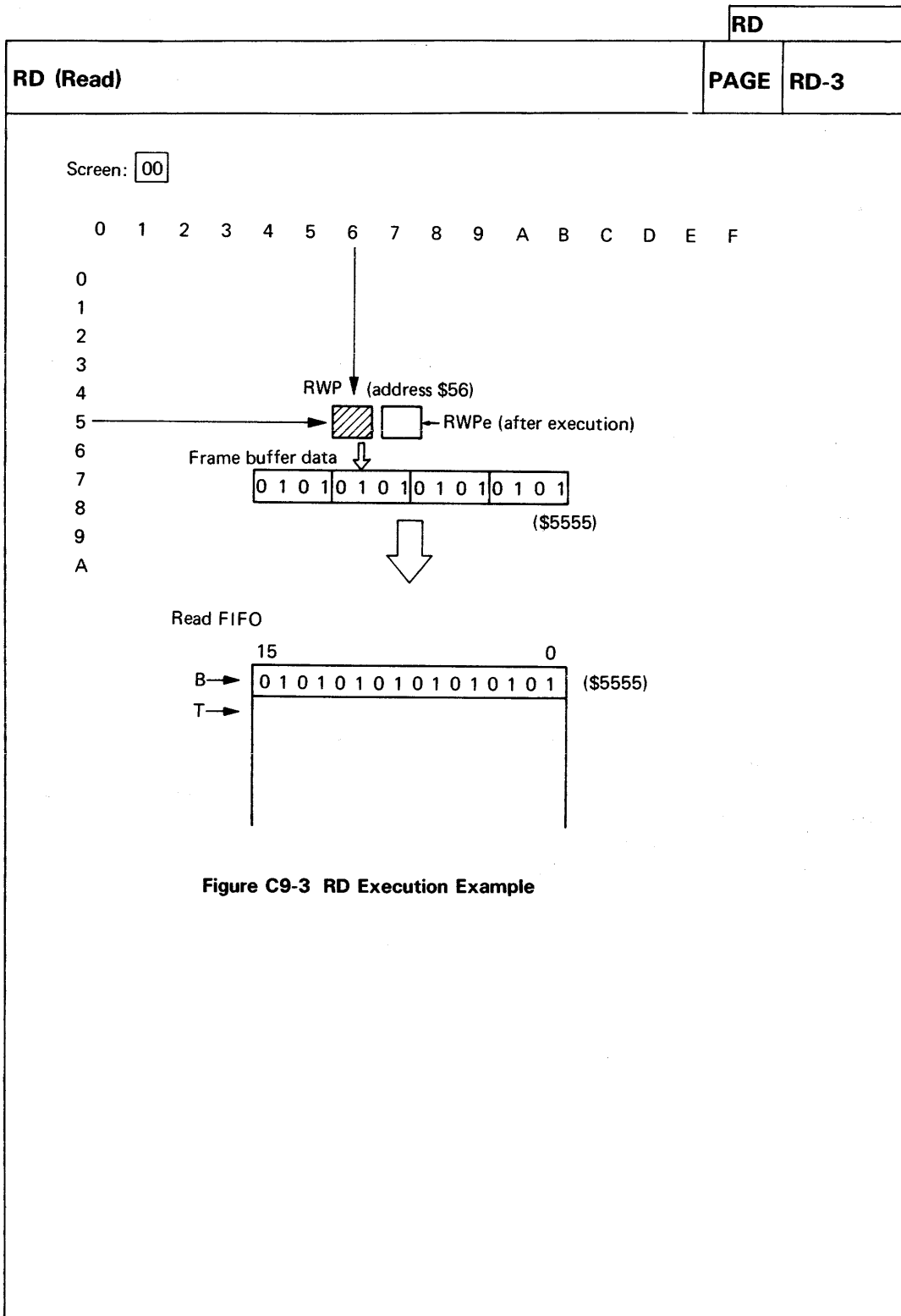


< NOTE >

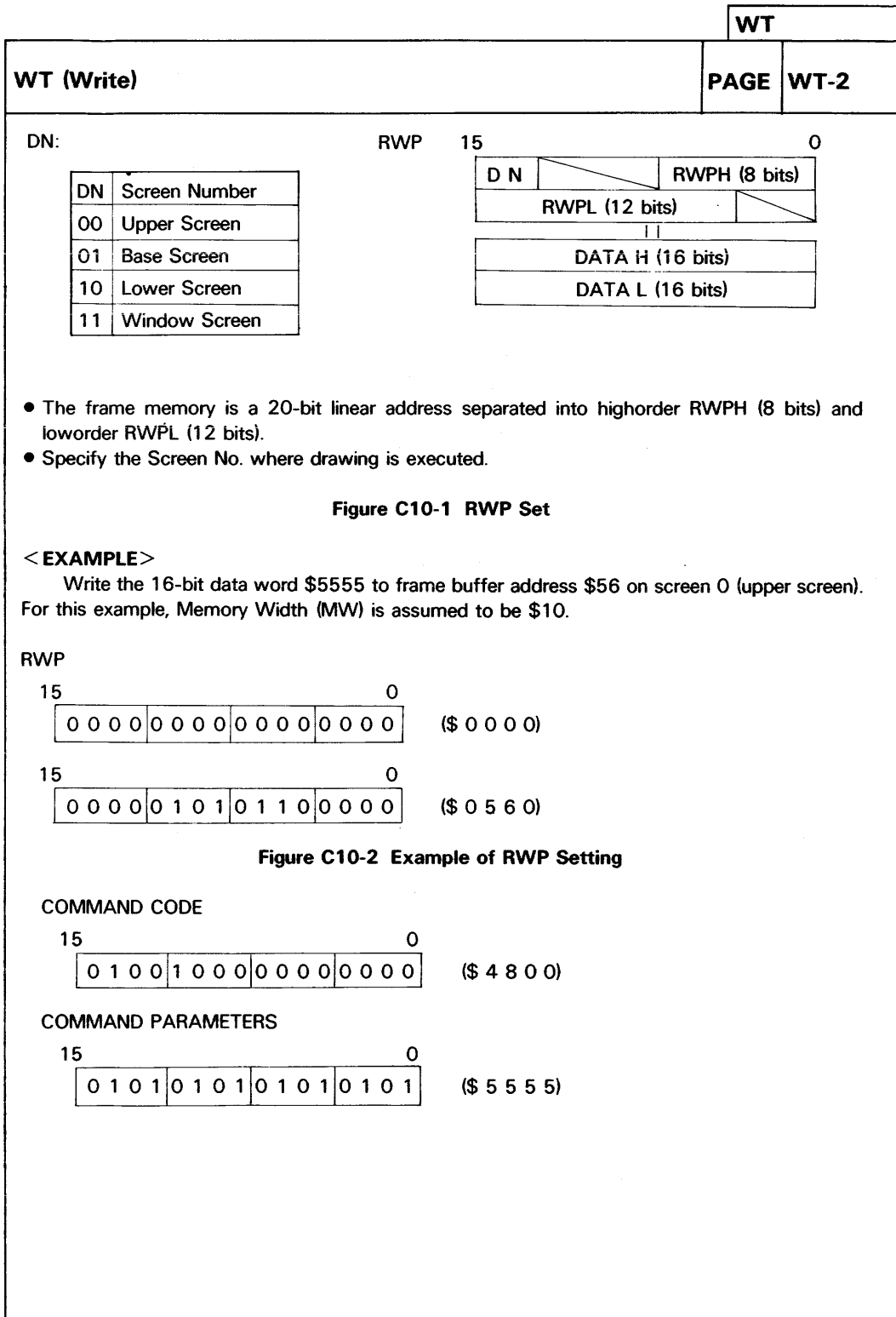
After DMOD is issued, no further commands should be issued until the DMA data is transferred and the DMOD command terminates.

		RD																	
[9] RD (Read)	PAGE	RD-1																	
<p>< FUNCTION > Read one word of data from the frame buffer and load the word into Read FIFO.</p> <p>< MNEMONIC > RD</p>	TYPE	Data Transfer Command																	
<p>< FORMAT ></p> <p>COMMAND CODE hexadecimal notation</p> <p style="text-align: center;">15 0</p> <table border="1" style="margin-left: auto; margin-right: auto;"> <tr> <td style="padding: 2px 5px;">0</td> <td style="padding: 2px 5px;">1</td> <td style="padding: 2px 5px;">0</td> <td style="padding: 2px 5px;">0</td> <td style="padding: 2px 5px;">0</td> <td style="padding: 2px 5px;">1</td> <td style="padding: 2px 5px;">0</td> <td style="padding: 2px 5px;">0</td> <td style="padding: 2px 5px;">0</td> <td style="padding: 2px 5px;">0</td> <td style="padding: 2px 5px;">0</td> <td style="padding: 2px 5px;">0</td> <td style="padding: 2px 5px;">0</td> <td style="padding: 2px 5px;">0</td> <td style="padding: 2px 5px;">0</td> <td style="padding: 2px 5px;">0</td> </tr> </table> <p style="text-align: right;">(\$ 4 4 0 0)</p> <p>COMMAND PARAMETER - NON -</p>	0	1	0	0	0	1	0	0	0	0	0	0	0	0	0	0	WORD NUMBER Wn=1	EXECUTION CYCLES Cn=12	
0	1	0	0	0	1	0	0	0	0	0	0	0	0	0	0				
<p>< DESCRIPTION ></p> <p>RD reads one word (16 bits) of data from the frame buffer. The frame buffer address to be read must be predefined in the Read Write Pointer (RWP) before the RD command is issued. The results are loaded into the Read FIFO.</p> <p>The result may be read from the Read FIFO by the MPU anytime after the RD command is issued. If the Read FIFO is full when the command is executed, the ACRTC will enter a wait state until space becomes available in the Read FIFO.</p> <p>At the end of the RD command execution, the ACRTC increments RWP by one.</p>																			





		WT																		
[10] WT (Write)	PAGE	WT-1																		
<p>< FUNCTION > Write one word of data to the frame buffer.</p> <p>< MNEMONIC > WT D</p>		TYPE	Data Transfer Command																	
<p>< FORMAT ></p> <p>COMMAND CODE hexadecimal notation</p> <p>15 0</p> <table border="1" style="margin-left: 20px;"> <tr> <td style="width: 40px;">0</td> <td style="width: 40px;">1</td> <td style="width: 40px;">0</td> <td style="width: 40px;">0</td> <td style="width: 40px;">1</td> <td style="width: 40px;">0</td> <td style="width: 40px;">0</td> <td style="width: 40px;">0</td> <td style="width: 40px;">0</td> <td style="width: 40px;">0</td> <td style="width: 40px;">0</td> <td style="width: 40px;">0</td> <td style="width: 40px;">0</td> <td style="width: 40px;">0</td> <td style="width: 40px;">0</td> <td style="width: 40px;">0</td> </tr> </table> <p style="margin-left: 100px;">(\$ 4 8 0 0)</p> <p>COMMAND PARAMETERS</p> <p>15 0</p> <table border="1" style="margin-left: 20px; width: 100%;"> <tr> <td style="text-align: center;">D (16 bits)</td> </tr> </table>		0	1	0	0	1	0	0	0	0	0	0	0	0	0	0	0	D (16 bits)	WORD NUMBER W _n =2	EXECUTION CYCLES C _n =8
0	1	0	0	1	0	0	0	0	0	0	0	0	0	0	0					
D (16 bits)																				
<p>< DESCRIPTION ></p> <p>WT writes one word (16 bits) of data to the frame buffer. The frame buffer address to be written must be predefined in the Read Write Pointer (RWP) before the WT command is issued. The command parameter (D) is the data to be written.</p> <p>At the end of the WT command execution, the ACRTC increments the RWP by one.</p>																				



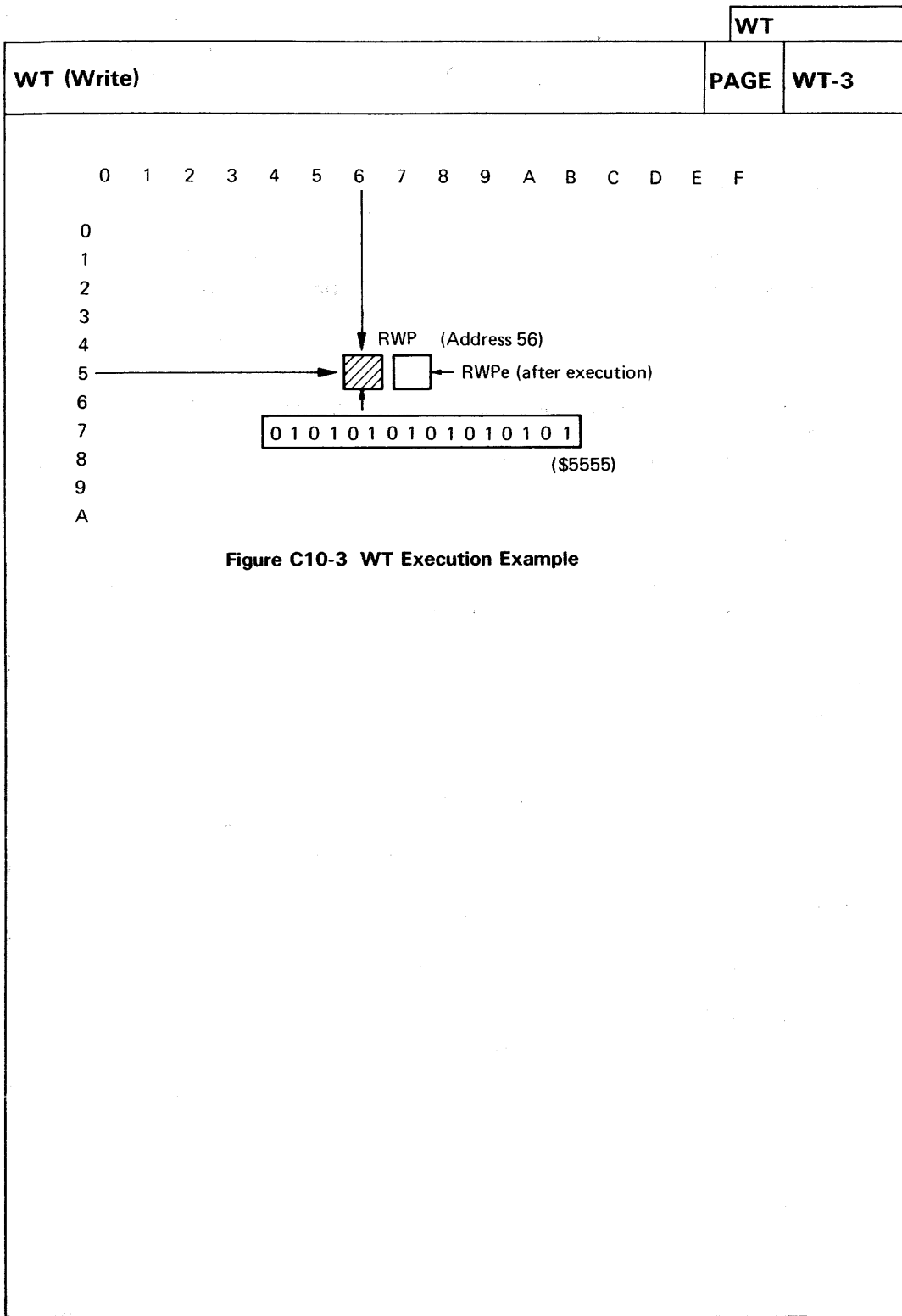


Figure C10-3 WT Execution Example

		MOD								
[11] MOD (Modify)		PAGE	MOD-1							
<p>< FUNCTION > Perform logical operation on one word in the frame buffer.</p> <p>< MNEMONIC > MOD (MM) D</p>		TYPE	Data Transfer Command							
<p>< FORMAT ></p> <p>COMMAND CODE hexadecimal notation</p> <p>15 2 1 0</p> <table border="1" style="margin-left: 20px;"> <tr> <td style="width: 40px;">0 1 0 0</td> <td style="width: 40px;">1 1 0 0</td> <td style="width: 40px;">0 0 0 0</td> <td style="width: 40px;">0 0</td> <td style="width: 40px;">MM</td> <td style="width: 40px;">(\$ 4 C 0 X)</td> </tr> </table> <p>COMMAND PARAMETER</p> <p>15 0</p> <table border="1" style="margin-left: 20px;"> <tr> <td style="width: 100px; text-align: center;">D (16 bits)</td> </tr> </table>		0 1 0 0	1 1 0 0	0 0 0 0	0 0	MM	(\$ 4 C 0 X)	D (16 bits)	WORD NUMBER Wn=2	EXECUTION CYCLES Cn=8
0 1 0 0	1 1 0 0	0 0 0 0	0 0	MM	(\$ 4 C 0 X)					
D (16 bits)										
<p>< DESCRIPTION ></p> <p>The MM (Modify Mode) field of the command code specifies the data transfer modify mode. This command performs logical operation on one word in the frame buffer with the data given the parameter and writes the result back in the frame buffer. The frame buffer word address to be modified must be predefined in the Read Write Pointer (RWP).</p> <p>The word is read from the frame buffer, then the logical operation defined by MM is performed between the data read from the frame buffer and the command parameter (D) for those bits not masked in the MASK register, and the result is rewritten to the frame buffer.</p> <p>At the end of the MOD command execution, the ACRTC increments the RWP by one.</p>										

< EXECUTION EXAMPLE >

RWP

15					0	
	0	0	0	0	0	(\$ 0 0 0 0)

15					0	
	0	0	1	0	1	(\$ 0 5 6 0)

MASK

15					0	
	1	1	1	1	1	(\$ F F F F)

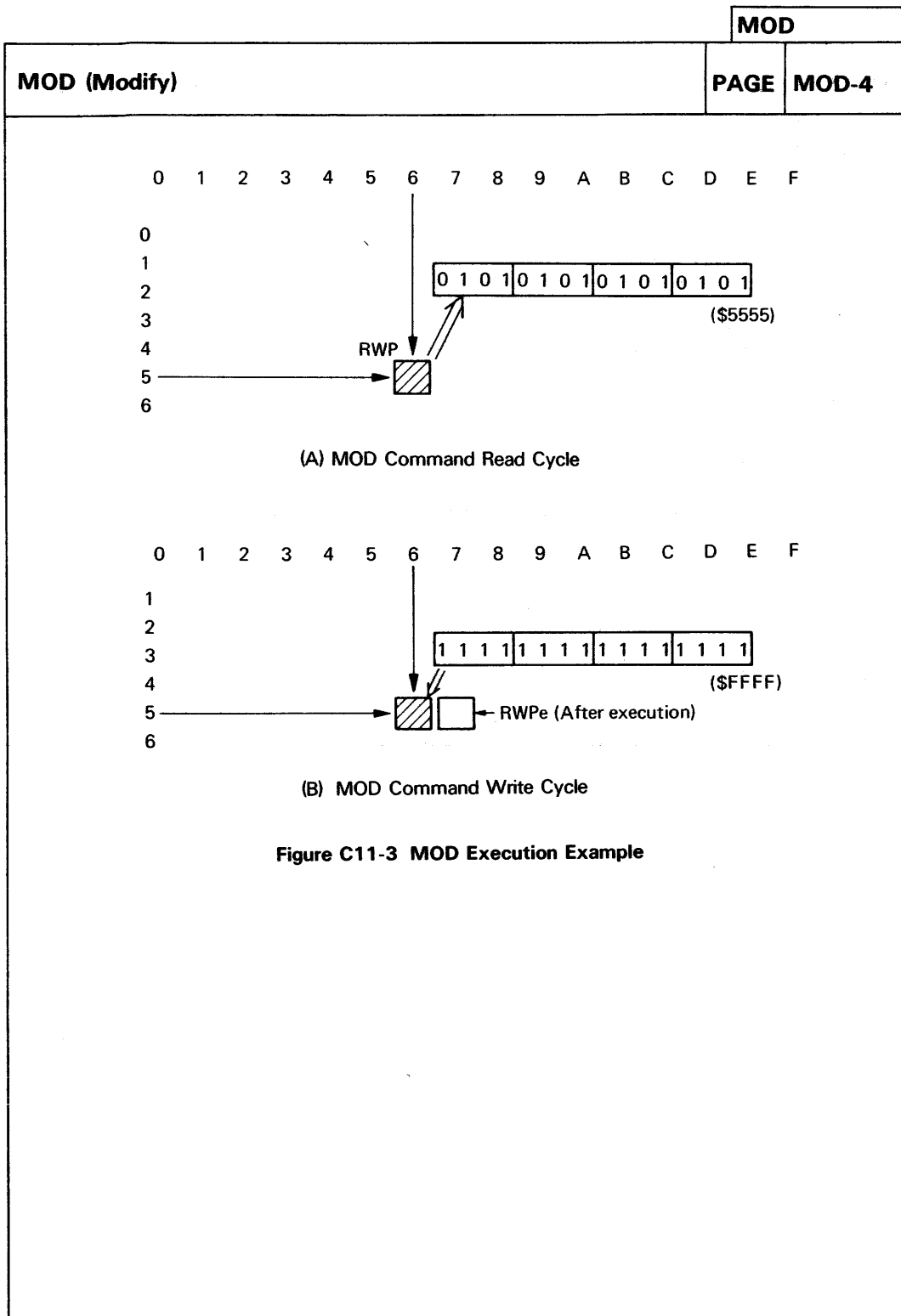
Figure C11-2 Examples of RWP and MASK Setting

COMMAND CODE

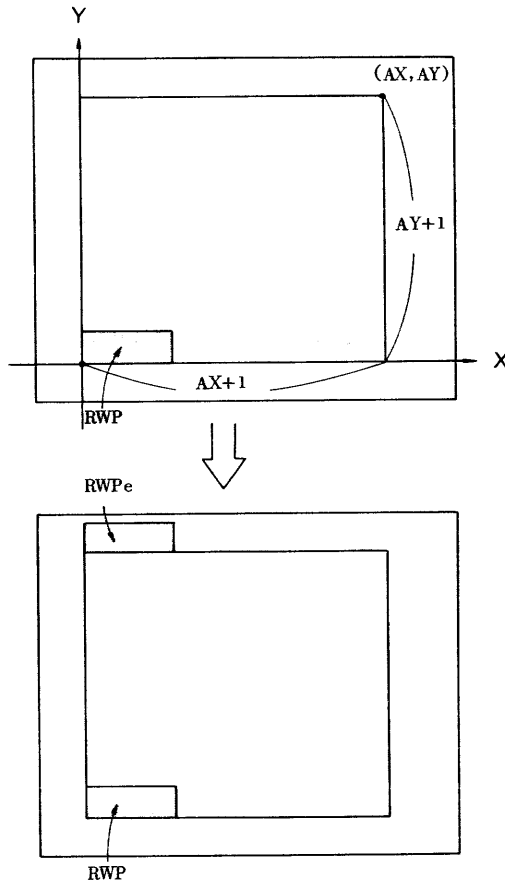
15						0	
	0	1	0	0	1	1	(\$ 4 C 0 1)

COMMAND PARAMETER

15						0	
	1	0	1	0	1	0	(\$ A A A A)



		CLR								
[12] CLR (Clear)	PAGE	CLR-1								
<p>< FUNCTION > Initialize a frame buffer area with a data in the command parameter.</p> <p>< MNEMONIC > CLR D, AX, AY</p>	TYPE	Data Transfer Command								
<p>< FORMAT ></p> <p>COMMAND CODE hexadecimal notation</p> <p>15 0</p> <table border="1" style="margin-left: 20px;"> <tr> <td style="width: 40px;">0 1 0 1</td> <td style="width: 40px;">1 1 0 0 0</td> <td style="width: 40px;">0 0 0 0 0</td> <td style="width: 40px;">0 0 0 0 0</td> </tr> </table> <p style="margin-left: 100px;">(\$ 5 8 0 0)</p> <p>COMMAND PARAMETERS</p> <p>15 0</p> <table border="1" style="margin-left: 20px;"> <tr> <td style="width: 100px; text-align: center;">D (16 bits)</td> </tr> </table> <p>15 0</p> <table border="1" style="margin-left: 20px;"> <tr> <td style="width: 100px; text-align: center;">AX (16 bits)</td> </tr> </table> <p>15 0</p> <table border="1" style="margin-left: 20px;"> <tr> <td style="width: 100px; text-align: center;">AY (16 bits)</td> </tr> </table>	0 1 0 1	1 1 0 0 0	0 0 0 0 0	0 0 0 0 0	D (16 bits)	AX (16 bits)	AY (16 bits)	WORD NUMBER W _n =4	EXECUTION CYCLES C _n =(2x+8)y+12 $\begin{cases} x = AX + 1 \\ y = AY + 1 \end{cases}$	
0 1 0 1	1 1 0 0 0	0 0 0 0 0	0 0 0 0 0							
D (16 bits)										
AX (16 bits)										
AY (16 bits)										
<p>< DESCRIPTION ></p> <p>The frame buffer area defined by the physical origin (RWP) and physical frame buffer word address (AX and AY) parameters is filled with the data parameter (D).</p> <p>Since the ACRTC performs the clear using 16 bit words, multiple logical pixels (if 4 bits/pixel then 4 pixels) are cleared in one access. D is normally specified to contain multiple copies (if 4 bits/pixel then 4 copies) of the color information for a single color clear.</p> <p>At the end of CLR command execution, RWP will be set to RWPe.</p>										



AX: 2nd parameter
 AY: 3rd parameter
 (4-bits/pixel)

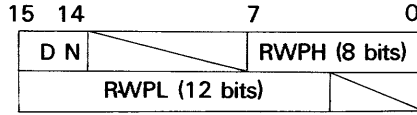
RWP is set with a 2-word
 (32-bit) data, as shown in
 Fig. C12-1.

The RWP needs to be specified in advance as follows.

DN:

DN	Screen Number
00	Upper Screen
01	Base Screen
10	Lower Screen
11	Window Screen

RWP:



- The frame buffer 20-bit linear address is separated into high order RWPH (8 bits) and low order RWPL (12 bits).
- Specify the Screen No. where drawing is executed.

Figure C12-1 RWP Set

< EXAMPLE >

For this example 4 bits per logical pixel is used, the Memory Width (MW) is \$10 and the clear operation is to start at address \$56 on screen 0.

RWP

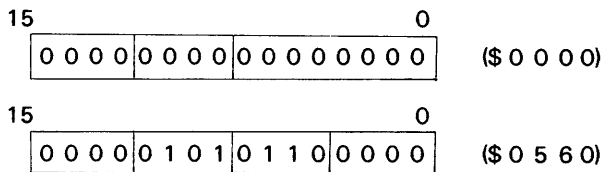
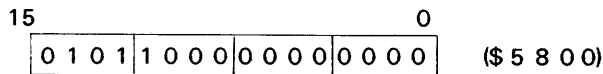
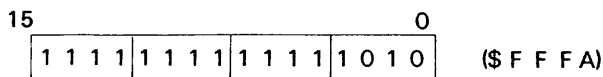
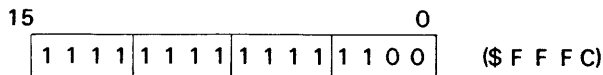
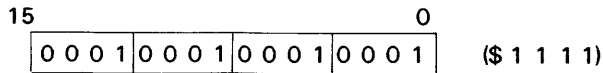


Figure C12-2 Example of RWP Setting

COMMAND CODE



COMMAND PARAMETERS



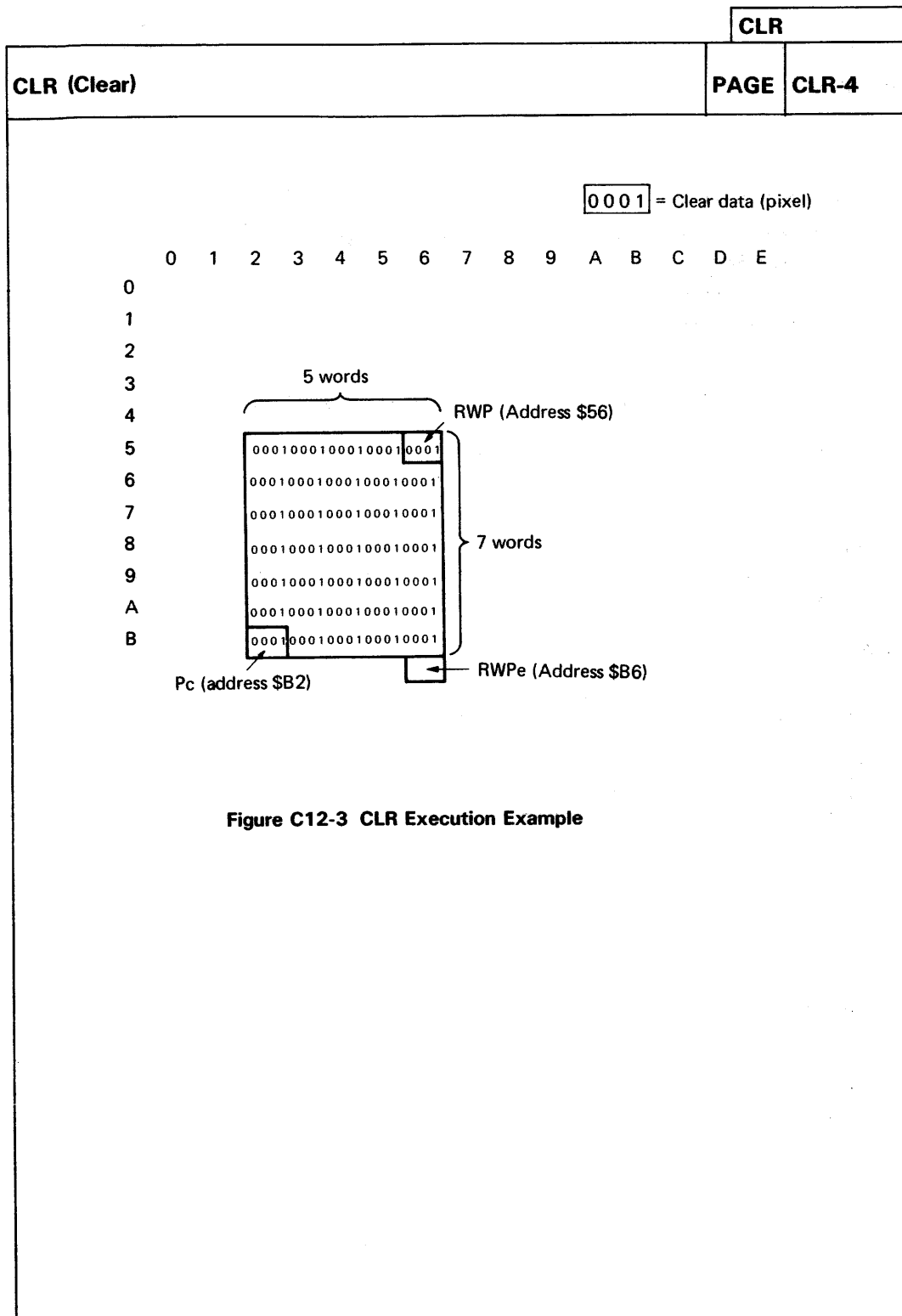


Figure C12-3 CLR Execution Example

		SCLR	
[13] SCLR (Selective Clear)		PAGE	SCLR-1
<p>< FUNCTION > Initialize a frame buffer area with a constant value subject to logical modification.</p> <p>< MNEMONIC > SCLR (MM) D, AX, AY</p>		TYPE	Data Transfer Command
<p>< FORMAT ></p> <p>COMMAND CODE hexadecimal notation</p> <div style="display: flex; justify-content: space-between; width: 100%;"> 15 0 </div> <div style="border: 1px solid black; padding: 2px; width: fit-content; margin: 0 auto;"> 0 1 0 1 1 1 0 0 0 0 0 0 0 0 MM (\$ 5 C 0 X) </div> <p>COMMAND PARAMETERS</p> <div style="margin-bottom: 10px;"> <div style="display: flex; justify-content: space-between; width: 100%;"> 15 0 </div> <div style="border: 1px solid black; padding: 2px; width: 100%; text-align: center;">D (16 bits)</div> </div> <div style="margin-bottom: 10px;"> <div style="display: flex; justify-content: space-between; width: 100%;"> 15 0 </div> <div style="border: 1px solid black; padding: 2px; width: 100%; text-align: center;">AX (16 bits)</div> </div> <div> <div style="display: flex; justify-content: space-between; width: 100%;"> 15 0 </div> <div style="border: 1px solid black; padding: 2px; width: 100%; text-align: center;">AY (16 bits)</div> </div>			

< DESCRIPTION >

- : Modifier information
 - : 1st parameter
 - 2 . : 2nd parameter
 - 4 : 3rd parameter
- } in units of words

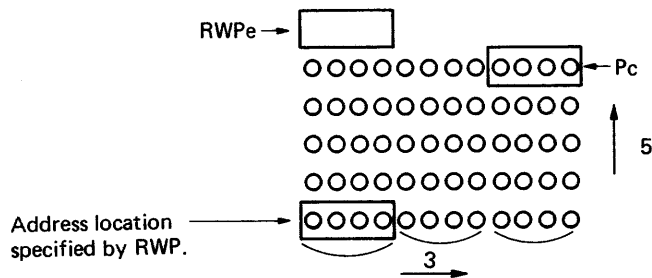


Figure C13-1 Command Parameter Set

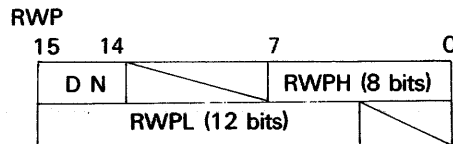
The operation is specified by the above operation mode, and is set with bits 1, 0 in the command code.

This command can be utilized for clearing the character code, the specific attribute bits, and the specific color plane in the graphic display.

The RWP needs to be specified in advance as follows.

DN:

DN	Screen Number
00	Upper Screen
01	Base Screen
10	Lower Screen
11	Window Screen



- The frame memory is a 20-bit linear address separated into high order RWPH (8 bits) and low order RWPL (12 bits).
- Specify the Screen No. where drawing is executed.

Figure C13-2 RWP Set

SCLR (Selective Clear)

< EXAMPLE >
 For this example 4 bits per logical pixel is used, the Memory Width (MW) is \$10, the MASK register contains \$F0F0 and the selective clear operation is to start at address \$56 on screen 0.
 Based on MM, a logical operation (REPLACE, OR, AND or EOR) is defined and SCLR is executed as shown.

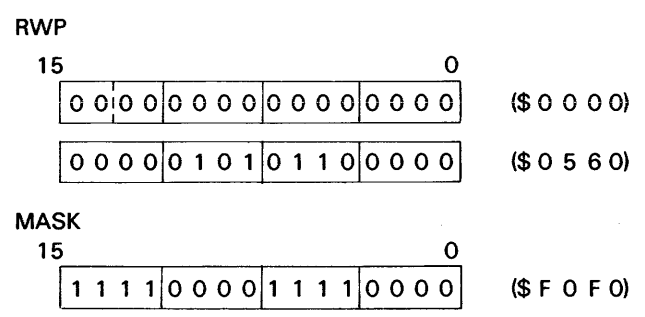


Figure C13-3 Examples of RWP and MASK Setting

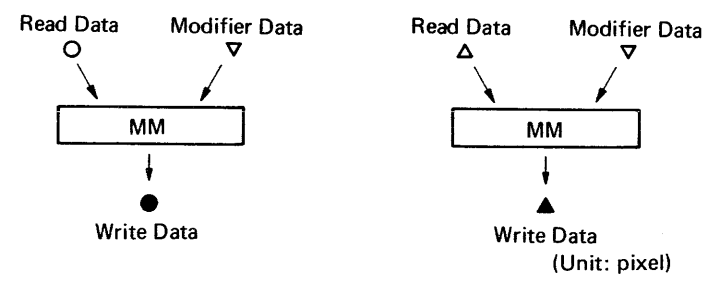


Figure C13-4 Notation of Data

< EXECUTION EXAMPLE >

COMMAND CODE

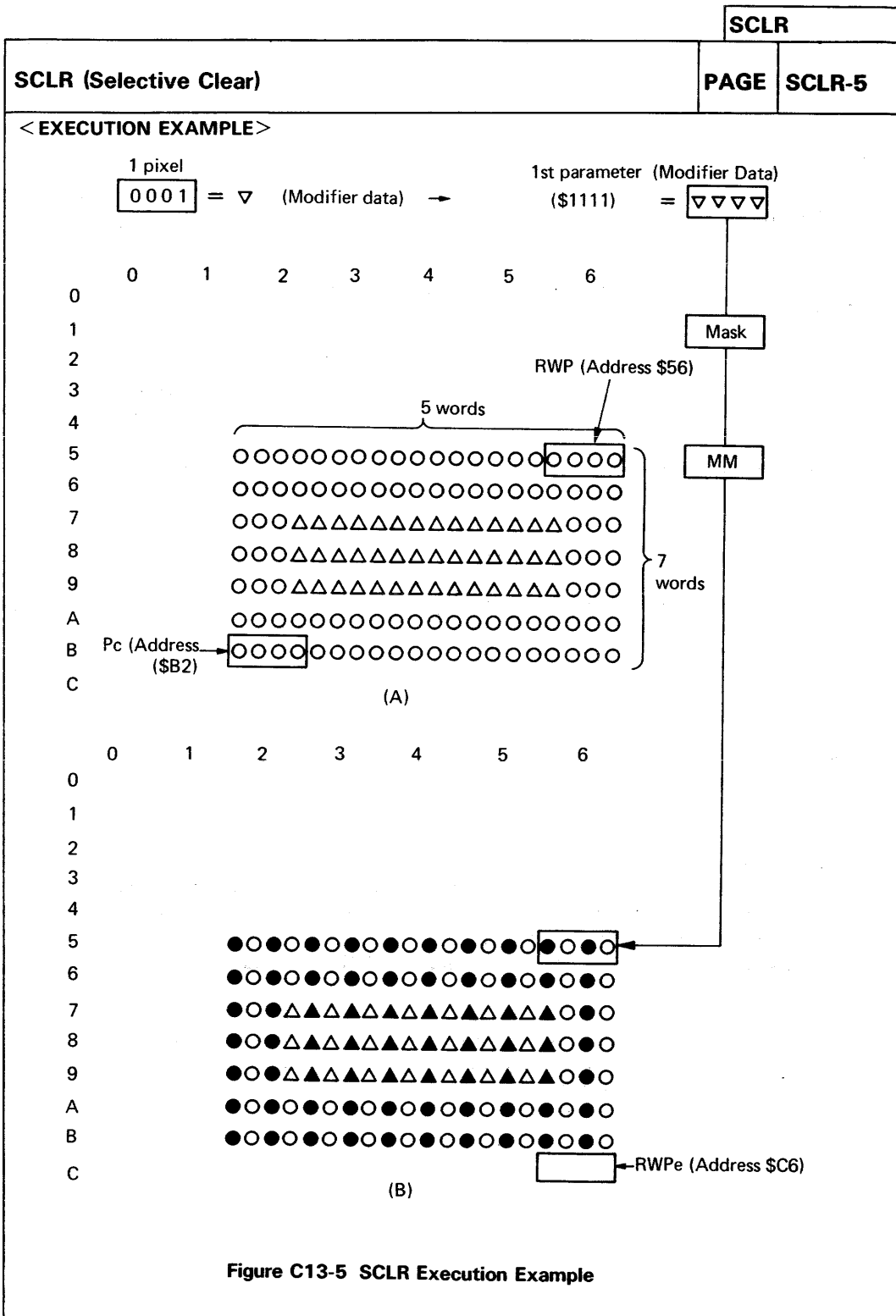
15 0
0 1 0 1 1 1 0 0 0 0 0 0 0 0 MM (\$ 5 C 0 X)

COMMAND PARAMETERS

15 0
0 0 0 1 0 0 0 1 0 0 0 1 0 0 0 1 (\$ 1 1 1 1)

15 0
1 1 1 1 1 1 1 1 1 1 1 1 1 1 0 0 (\$ F F F C)

15 0
1 1 1 1 1 1 1 1 1 1 1 1 1 0 1 0 (\$ F F F A)



CPY (Copy)

< CPY Command Scan Direction >

As to CPY, the direction of pointer scanning is specified in command code. (The pointer functions in the unit of word).

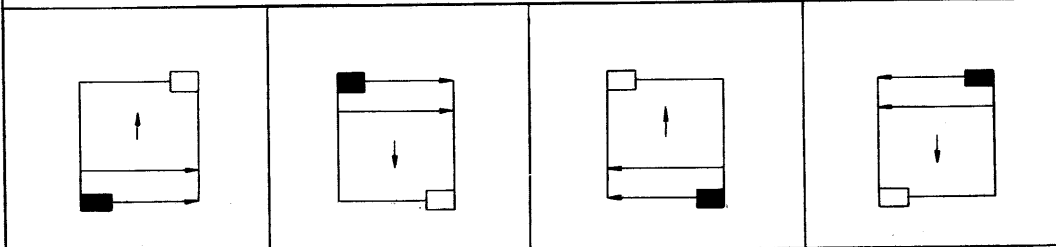
(a) Scanning Direction of Source Area (S: Source Scan Direction)

COMMAND CODE

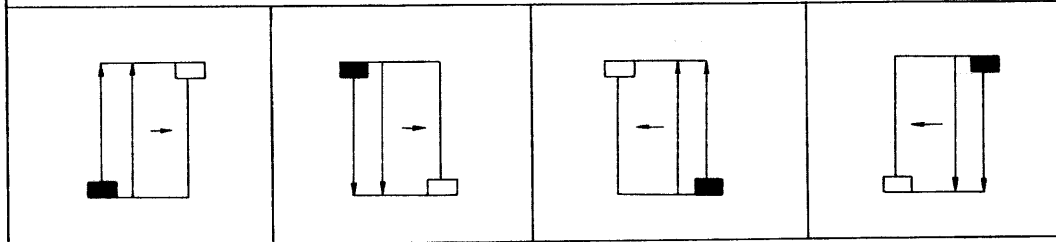


Table C14-1 Source Scan Direction

S = 0



S = 1



■ : Pss □ : Pse

As shown in Table C14-1, the scanning direction in frame buffer of the copy source area is decided by the relation between bit 11 in the command code and the Pss and the Pse.

(a) Scanning Direction of Destination Area (DSD: Destination Scan Direction)

COMMAND CODE

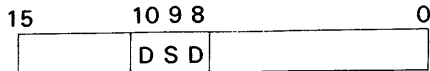


Table C14-2 Destination Scan Direction

DSD = 000	DSD = 001	DSD = 010	DSD = 011
DSD = 100	DSD = 101	DSD = 110	DSD = 111

■ : RWP □ : RWPe

As shown in Table C14-2, the scanning direction in frame buffer of the destination area is decided by the relation between bit 10 to 8 in the command code and the RWP.

Upon termination of the command, RWPe, end point of the RWP moves as shown in Table C14-2.

Relation to Linear Address

Fig. C14-2 provides the relation between CPY and specified value when S = 1 and DSD = 000.

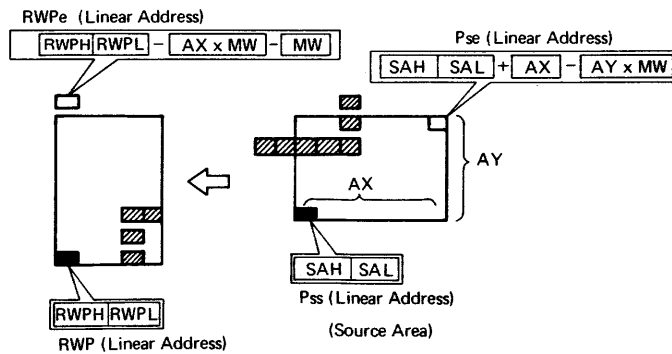


Figure C14-2 Relations with Linear Addresses

< EXAMPLE >

For this example 4 bits per logical pixel is used, the Memory Width (MW) is \$10 and the copy operation source area (SAH/SAL) start is frame buffer address \$89 while the copy destination area (RWP) start is frame buffer address \$B0 on screen 0.

The source area scanning direction is specified as S = 1 and the destination area scanning direction is specified as DSD = 000.

RWP

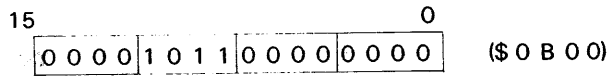
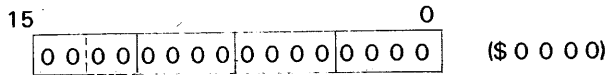
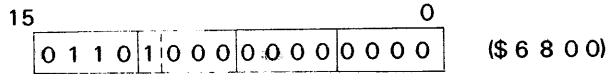
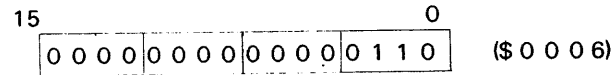
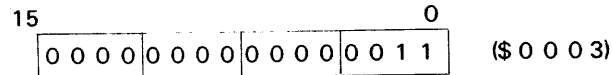
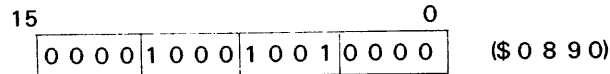
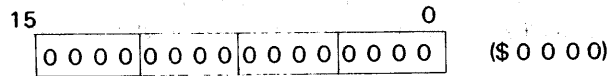


Figure C14-3 Example of Read Write Pointer Setting

COMMAND CODE



COMMAND PARAMETERS



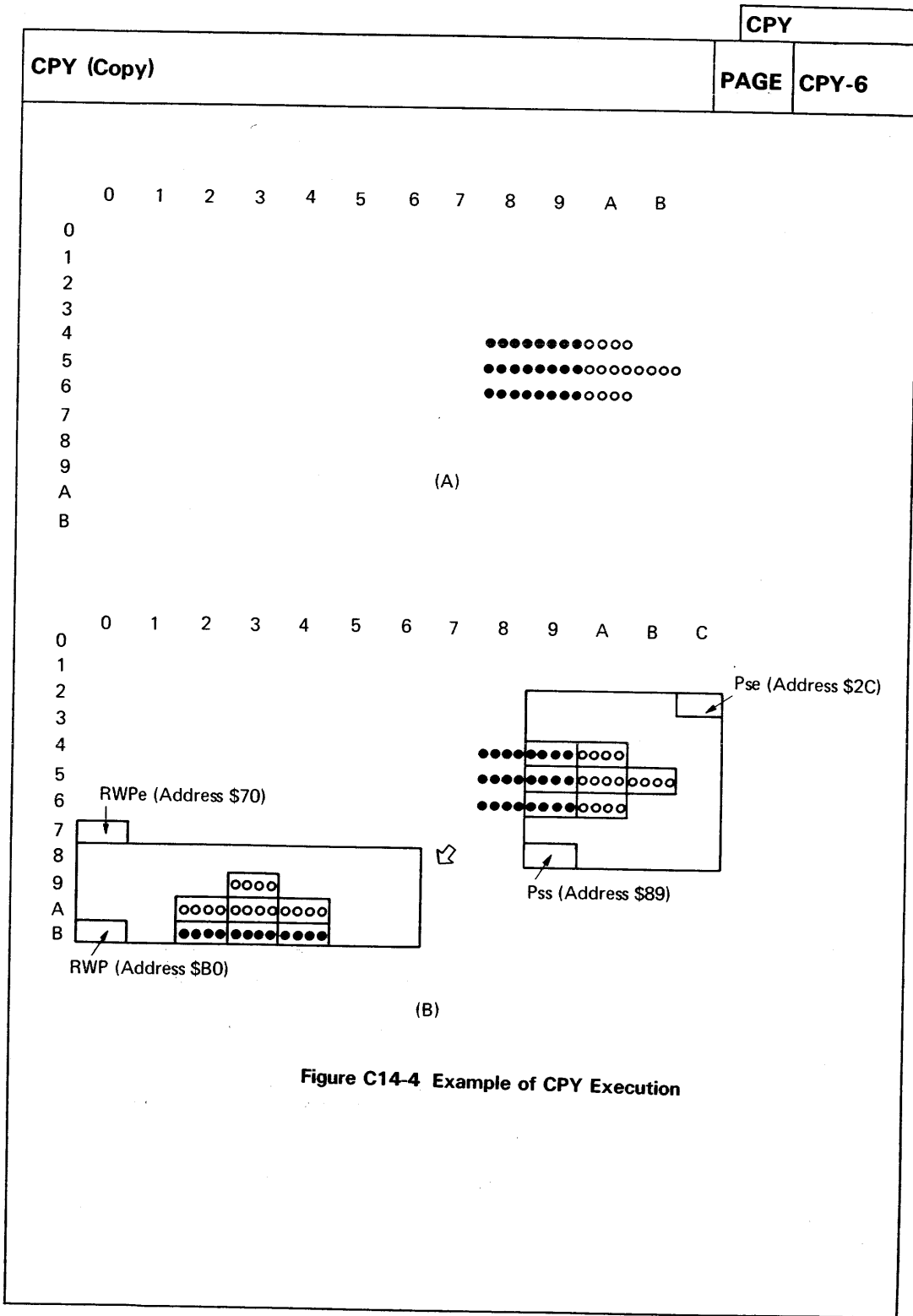


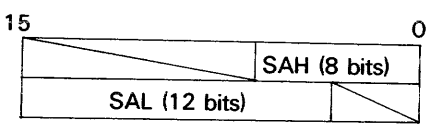
Figure C14-4 Example of CPY Execution

		SCPY																												
[15] SCPY (Selective Copy)		PAGE	SCPY-1																											
<p>< FUNCTION > Copy frame buffer data from one area (source area) to another area (destination area) subject to logical modification. The source and destination areas must reside on the same screen.</p> <p>< MNEMONIC > SCPY (S, DSD, MM) SAH, SAL, AX, AY</p>		TYPE	Data Transfer Command																											
<p>< FORMAT ></p> <p>COMMAND CODE</p> <table style="width: 100%; border-collapse: collapse;"> <tr> <td style="width: 10%; text-align: right;">15</td> <td style="width: 20%; text-align: center;">11 10</td> <td style="width: 20%; text-align: center;">8 7</td> <td style="width: 20%; text-align: center;">2 1</td> <td style="width: 10%; text-align: right;">0</td> <td style="width: 10%;"></td> </tr> <tr> <td></td> <td style="border: 1px solid black; text-align: center;">0 1 1 1</td> <td style="border: 1px solid black; text-align: center;">S D S D</td> <td style="border: 1px solid black; text-align: center;">0 0 0 0 0 0</td> <td style="border: 1px solid black; text-align: center;">MM</td> <td style="text-align: right;">hexadecimal notation (\$ 7 X 0 X)</td> </tr> </table> <p>COMMAND PARAMETERS</p> <table style="width: 100%; border-collapse: collapse;"> <tr> <td style="width: 10%; text-align: right;">15</td> <td style="width: 70%;"></td> <td style="width: 10%; text-align: right;">0</td> </tr> <tr> <td></td> <td style="border: 1px solid black; text-align: center;">0 0 0 0 0 0 0 0</td> <td style="text-align: right;">SAH (8 bits)</td> </tr> <tr> <td style="text-align: right;">15</td> <td style="border: 1px solid black; text-align: center;">SAL (12 bits)</td> <td style="text-align: right;">0 0 0 0</td> </tr> <tr> <td style="text-align: right;">15</td> <td style="border: 1px solid black; text-align: center;">AX (16 bits)</td> <td style="text-align: right;">0</td> </tr> <tr> <td style="text-align: right;">15</td> <td style="border: 1px solid black; text-align: center;">AY (16 bits)</td> <td style="text-align: right;">0</td> </tr> </table>		15	11 10	8 7	2 1	0			0 1 1 1	S D S D	0 0 0 0 0 0	MM	hexadecimal notation (\$ 7 X 0 X)	15		0		0 0 0 0 0 0 0 0	SAH (8 bits)	15	SAL (12 bits)	0 0 0 0	15	AX (16 bits)	0	15	AY (16 bits)	0	<p>WORD NUMBER $W_n = 5$</p> <p>EXECUTION CYCLES $C_n = (6x + 10)y + 12$</p> $\begin{cases} x = AX + 1 \\ y = AY + 1 \end{cases}$	
15	11 10	8 7	2 1	0																										
	0 1 1 1	S D S D	0 0 0 0 0 0	MM	hexadecimal notation (\$ 7 X 0 X)																									
15		0																												
	0 0 0 0 0 0 0 0	SAH (8 bits)																												
15	SAL (12 bits)	0 0 0 0																												
15	AX (16 bits)	0																												
15	AY (16 bits)	0																												
<p>< DESCRIPTION ></p> <p>The parameters to the command define the source area. The RWP must be predefined to point to the destination area (including screen number). The source area resides in the same screen as that of the destination area as defined in RWP.</p> <p>The source area is defined by the origin address (SAH/SAL) and physical frame buffer word (AX and AY) dimensions.</p> <p>To allow rotation and proper operation for overlapping during copying, the command code contains fields which define the source and destination scanning direction. The S (Source Scan Direction) and DSD (Destination Scan Direction) fields of the command code define the source and destination scanning direction respectively as shown next page.</p> <p>The MM (Modify Mode) field of the command code specifies the data transfer modify mode. Based on MM, logical operation is performed (except for bits masked in the MASK register) between the source data and the destination data, and the result is written to the destination.</p> <p>At the end of the CPY command, RWP is set to RWP_e.</p>																														

SCPY (Selective Copy) **PAGE** **SCPY-2**

The source address and Read/Write Pointer need to be specified as follows prior to the execution.

Pss:

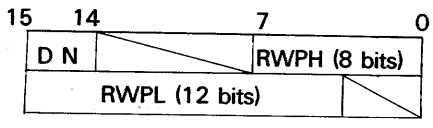


- (1) Pss (SAH, SAL) is set to be a 20-bit linear address separated into 2 words, high order SAH (8 bits) and low order SAL (12 bits).

DN:

DN	Screen Number
00	Upper Screen
01	Base Screen
10	Lower Screen
11	Window Screen

RWP:



The frame buffer 20-bit linear address is separated into high order RWPH (8 bits) and low order RWPL (12 bits).

Specify the Screen No. where drawing is executed.

Figure C15-1 P_{SS} and RWP Set

< SCPY Command Scan Direction >

As to SCPY, the direction of pointer scanning is specified in command code. (The pointer functions in the unit of word)

(a) Scanning Direction of Source Area (S: Source Scan Direction)

COMMAND CODE



Table C15-1 Source Scan Direction

S = 0			
S = 1			
		■ : Pss	□ : Pse

As shown in Table C15-1, the scanning direction in frame buffer of the copy source area is decided by the relation between bit 11 in the command code and the Pss and the Pse.

SCPY (Selective Copy)

(b) Scanning Direction of Destination Area (DSD: Destination Scan Direction)

COMMAND CODE

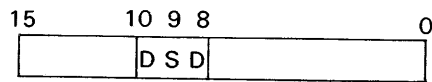


Table C15-2 Destination Scan Direction

DSD = 000	DSD = 001	DSD = 010	DSD = 011
DSD = 100	DSD = 101	DSD = 110	DSD = 111

■ : RWP □ : RWPe

As shown in Table C15-2, the scanning direction in frame buffer of the destination area is decided by the relation between bit 10 to 8 in the command code and the RWP.

Upon termination of the command, RWPe, end point of the RWP moves as shown in Table C15-2.

The operation is decided by the modify mode (MM) and is specified by bit "0" or "1" in the command code.

Relation to Linear Address

Fig. C15-2 provides the relation between SCPY and specified value when $S = 1$ and $DSD = 000$.

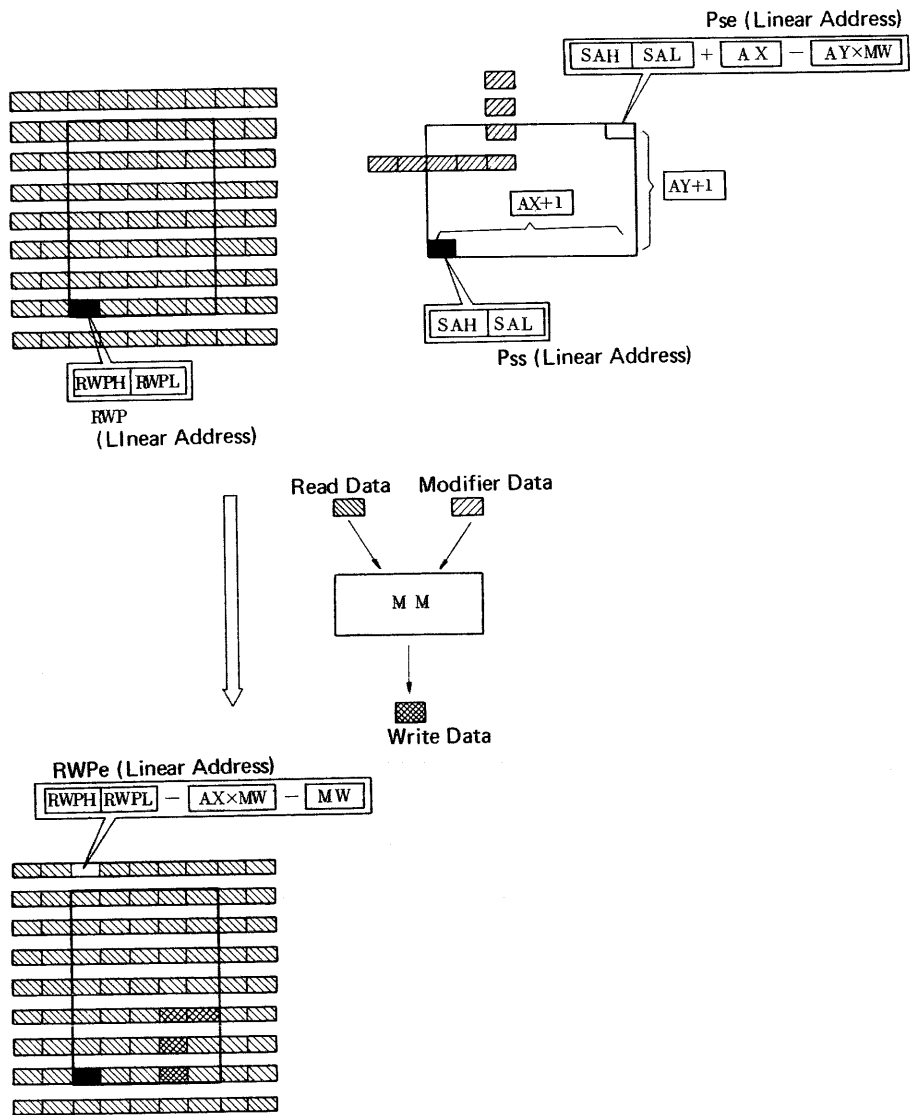


Figure C15-2 Relations with Linear Addresses

SCPY (Selective Copy)

PAGE

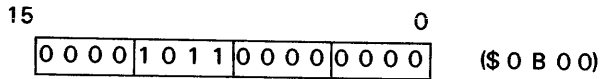
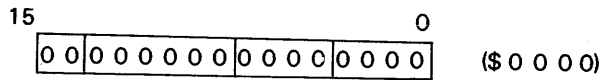
SCPY-6

< EXAMPLE >

For this example 4 bits per logical pixel is used, the Memory Width (MW) is \$10, the MASK register contains \$FOFO and the copy operation source area (SAH/SAL) start is frame buffer address \$85 while the copy destination area (RWP) start is frame buffer address \$B0 on screen 0.

The source area scanning direction is specified as S = 1 and the destination area scanning direction is specified as DSD = 000.

RWP



MASK

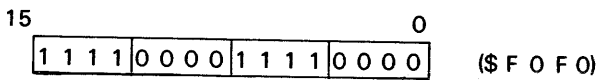


Figure C15-3 RWP and MASK Setting

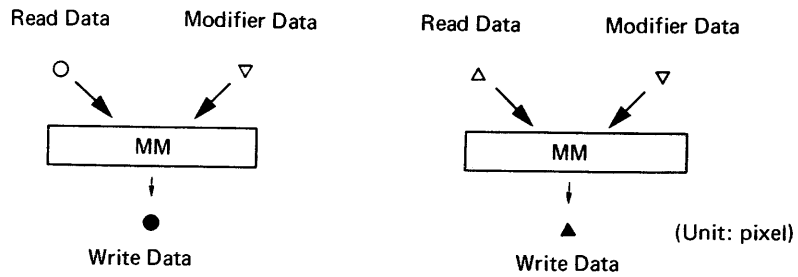


Figure C15-4 Operation of SCPY

COMMAND CODE

15															0	
	0	1	1	1	1	0	0	0	0	0	0	0	0	0	0	MM

(\$ 7 8 0 X)

COMMAND PARAMETERS

15															0
	0	0	0	0	0	0	0	0	0	0	0	0	0	0	0

(\$ 0 0 0 0)

15															0
	0	0	0	0	1	0	0	0	0	1	0	1	0	0	0

(\$ 0 8 5 0)

15															0
	0	0	0	0	0	0	0	0	0	0	0	0	0	0	1

(\$ 0 0 0 1)

15															0
	0	0	0	0	0	0	0	0	0	0	0	0	0	1	1

(\$ 0 0 0 6)

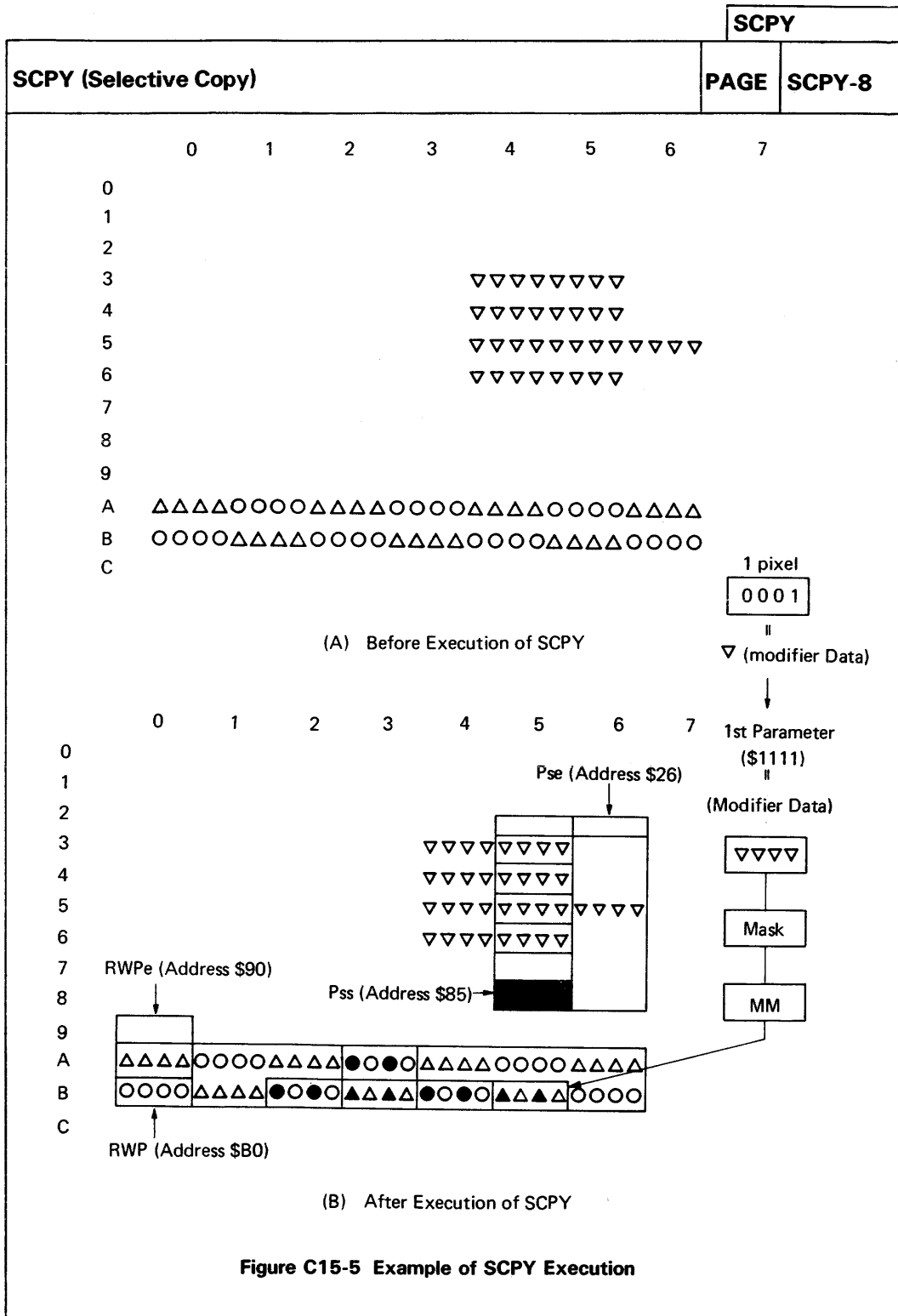


Figure C15-5 Example of SCPY Execution

AMOVE

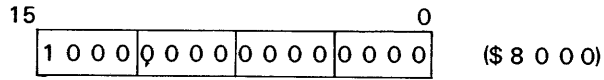
<p>[16] AMOVE (Absolute Move)</p>	<p>PAGE</p>	<p>AMOVE-1</p>												
<p>< FUNCTION > Move the Current Pointer (CP) to an absolute logical pixel X-Y address.</p> <p>< MNEMONIC > AMOVE X, Y</p>	<p>TYPE</p>	<p>Graphic Command</p>												
<p>< FORMAT ></p> <p>COMMAND CODE hexadecimal notation</p> <p>15 0</p> <table border="1" style="margin-left: 20px;"> <tr> <td style="width: 40px; text-align: center;">1</td> <td style="width: 40px; text-align: center;">0</td> <td style="width: 40px; text-align: center;">0</td> <td style="width: 40px; text-align: center;">0</td> <td style="width: 40px; text-align: center;">0</td> <td style="width: 40px; text-align: center;">0</td> <td style="width: 40px; text-align: center;">0</td> <td style="width: 40px; text-align: center;">0</td> <td style="width: 40px; text-align: center;">0</td> <td style="width: 40px; text-align: center;">0</td> </tr> </table> <p style="margin-left: 20px;">(\$ 8 0 0 0)</p> <p>COMMAND PARAMETERS</p> <p>15 0</p> <table border="1" style="margin-left: 20px;"> <tr> <td style="width: 100px; text-align: center;">X (16 bits)</td> </tr> </table> <p>15 0</p> <table border="1" style="margin-left: 20px;"> <tr> <td style="width: 100px; text-align: center;">Y (16 bits)</td> </tr> </table>	1	0	0	0	0	0	0	0	0	0	X (16 bits)	Y (16 bits)	<p>WORD NUMBER Wn=3</p> <p>EXECUTION CYCLES Cn=56</p>	
1	0	0	0	0	0	0	0	0	0					
X (16 bits)														
Y (16 bits)														
<p>< DESCRIPTION ></p> <p>The parameters (X, Y) of the AMOVE command specify the new value for the CP. The address is specified using logical pixel X-Y addresses relative to the origin defined by the ORG command.</p> <div style="text-align: center;"> </div> <p>Figure C16-1 Function of AMOVE Command</p>														

AMOVE (Absolute Move)

<EXAMPLE>

If CP = (-13, -10) and AMOVE command is executed with parameters (X, Y) = (10, 2), then the CP is set to Pe as shown below.

COMMAND CODE



COMMAND PARAMETERS

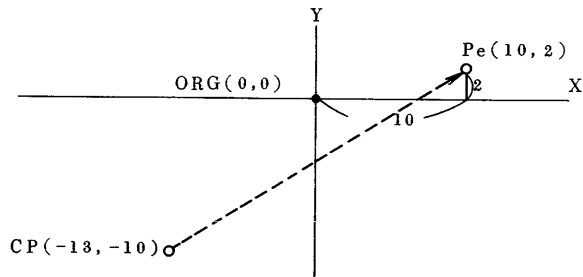
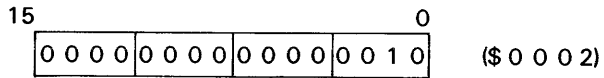
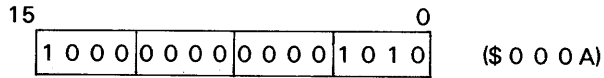


Figure C16-2 Example of AMOVE Execution

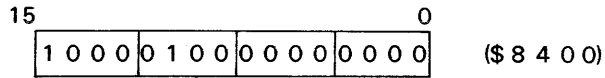
		RMOVE																		
[17] RMOVE (Relative Move)		PAGE	RMOVE-1																	
<p>< FUNCTION > Move the Current Pointer (CP) to a relative logical pixel X-Y address.</p> <p>< MNEMONIC > RMOVE dX, dY</p>		TYPE	Graphic Command																	
<p>< FORMAT ></p> <p>COMMAND CODE hexadecimal notation</p> <div style="display: flex; align-items: center; gap: 20px;"> <div style="text-align: center;"> <p>15 0</p> <table border="1" style="border-collapse: collapse; text-align: center;"> <tr> <td style="width: 40px;">1</td><td style="width: 40px;">0</td><td style="width: 40px;">0</td><td style="width: 40px;">0</td><td style="width: 40px;">0</td><td style="width: 40px;">1</td><td style="width: 40px;">0</td><td style="width: 40px;">0</td><td style="width: 40px;">0</td><td style="width: 40px;">0</td><td style="width: 40px;">0</td><td style="width: 40px;">0</td><td style="width: 40px;">0</td><td style="width: 40px;">0</td><td style="width: 40px;">0</td> </tr> </table> </div> <div style="text-align: center;"> <p>(\$ 8 4 0 0)</p> </div> </div> <p>COMMAND PARAMETERS</p> <div style="margin-bottom: 10px;"> <p>15 0</p> <table border="1" style="border-collapse: collapse; width: 100%; text-align: center;"> <tr> <td style="width: 100%;">dX (16 bits)</td> </tr> </table> </div> <div> <p>15 0</p> <table border="1" style="border-collapse: collapse; width: 100%; text-align: center;"> <tr> <td style="width: 100%;">dY (16 bits)</td> </tr> </table> </div>		1	0	0	0	0	1	0	0	0	0	0	0	0	0	0	dX (16 bits)	dY (16 bits)	<p>WORD NUMBER Wn=3</p> <p>EXECUTION CYCLES Cn=56</p>	
1	0	0	0	0	1	0	0	0	0	0	0	0	0	0						
dX (16 bits)																				
dY (16 bits)																				
<p>< DESCRIPTION ></p> <p>The parameters (dX, dY) of the RMOVE command are used to calculate the new value for the CP. The address is specified using logical pixel X-Y displacements relative to CP.</p> <div style="text-align: center;"> </div> <p>Figure C17-1 Function of RMOVE</p>																				

RMOVE (Relative Move)

< EXAMPLE >

If CP = (-13, -10) and RMOVE command is executed with parameters (X, Y) = (10, 2), then the CP is set to Pe as shown below.

COMMAND CODE



COMMAND PARAMETERS

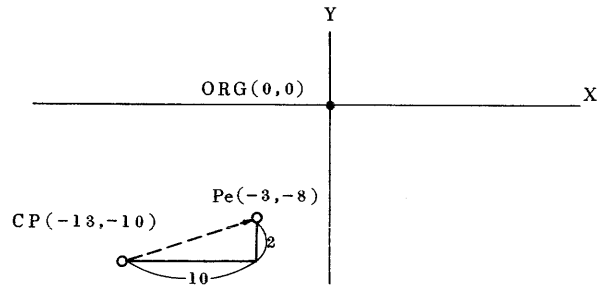
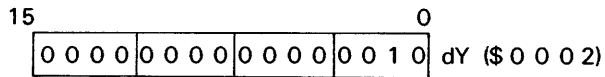
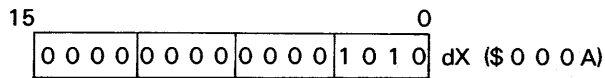


Figure C17-2 Example of RMOVE Execution

ALINE								
[18] ALINE (Absolute Line)	PAGE ALINE-1							
<p>< FUNCTION > Draw a straight line from CP to a command specified end point.</p> <p>< MNEMONIC > ALINE (AREA, COL, OPM) X, Y</p>	<p>TYPE</p> <p>Graphic Command</p>							
<p>< FORMAT ></p> <p>COMMAND CODE hexadecimal notation</p> <p>15 8 7 5 4 3 2 0</p> <table border="1" style="margin-left: 20px;"> <tr> <td style="width: 40px;">1 0 0 0</td> <td style="width: 40px;">1 0 0 0</td> <td style="width: 40px;">AREA</td> <td style="width: 40px;">COL</td> <td style="width: 40px;">OPM</td> </tr> </table> <p style="margin-left: 100px;">(\$ 8 8 X X)</p> <p>COMMAND PARAMETERS</p> <p>15 0</p> <table border="1" style="margin-left: 20px;"> <tr> <td style="width: 100px; text-align: center;">X (16 bits)</td> </tr> </table> <p>15 0</p> <table border="1" style="margin-left: 20px;"> <tr> <td style="width: 100px; text-align: center;">Y (16 bits)</td> </tr> </table>	1 0 0 0	1 0 0 0	AREA	COL	OPM	X (16 bits)	Y (16 bits)	<p>WORD NUMBER Wn=3</p> <p>EXECUTION CYCLES Cn=P·L+18</p>
1 0 0 0	1 0 0 0	AREA	COL	OPM				
X (16 bits)								
Y (16 bits)								
<p>< DESCRIPTION ></p> <p>The parameters (X, Y) define the line end point as absolute logical pixel X-Y addresses relative to the origin defined with the ORG command.</p> <p>As the line is drawn, CP is moved to Pe. However, the logical pixel at position Pe is not drawn.</p>								
<p>Figure C18-1 Function of ALINE</p>								

ALINE (Absolute Line)

PAGE

ALINE-2

<EXAMPLE>

If $CP = (-13, -10)$ and ALINE command is executed with parameters $(X, Y) = (10, 2)$, then a line is drawn and CP is set to Pe as shown below.

COMMAND CODE

15		8	7	5	4	3	2	0		
1	0	0	0	1	0	0	0	AREA	COL	OPM

(\$ 8 8 X X)

COMMAND PARAMETERS

15									0		
0	0	0	0	0	0	0	0	1	0	1	0

X (\$ 0 0 0 A)

15									0		
0	0	0	0	0	0	0	0	0	0	1	0

Y (\$ 0 0 0 2)

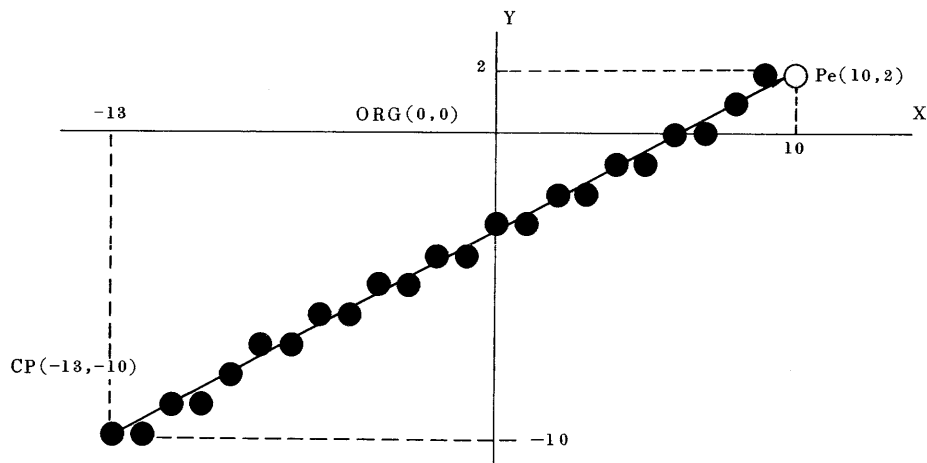


Figure C18-2 Example of ALINE Execution

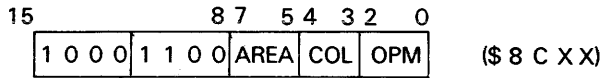
		RLINE																			
[19] RLINE (Relative Line)		PAGE	RLINE-1																		
<p>< FUNCTION > Draw a straight line from CP to a command specified end point.</p> <p>< MNEMONIC > RLINE (AREA, COL, OPM) dX, dY</p>		TYPE	Graphic Command																		
<p>< FORMAT ></p> <p>COMMAND CODE hexadecimal notation</p> <table style="width: 100%; border-collapse: collapse;"> <tr> <td style="text-align: right;">15</td> <td style="text-align: center;">8 7</td> <td style="text-align: center;">5 4</td> <td style="text-align: center;">3 2</td> <td style="text-align: center;">0</td> <td></td> </tr> <tr> <td style="border: 1px solid black; text-align: center;">1 0 0 0</td> <td style="border: 1px solid black; text-align: center;">1 1 0 0</td> <td style="border: 1px solid black; text-align: center;">AREA</td> <td style="border: 1px solid black; text-align: center;">COL</td> <td style="border: 1px solid black; text-align: center;">OPM</td> <td style="text-align: center;">(\$ 8 C X X)</td> </tr> </table> <p>COMMAND PARAMETERS</p> <table style="width: 100%; border-collapse: collapse;"> <tr> <td style="text-align: right;">15</td> <td style="border: 1px solid black; text-align: center; width: 100%;">dX (16 bits)</td> <td style="text-align: left;">0</td> </tr> <tr> <td style="text-align: right;">15</td> <td style="border: 1px solid black; text-align: center; width: 100%;">dY (16 bits)</td> <td style="text-align: left;">0</td> </tr> </table>		15	8 7	5 4	3 2	0		1 0 0 0	1 1 0 0	AREA	COL	OPM	(\$ 8 C X X)	15	dX (16 bits)	0	15	dY (16 bits)	0	<p>WORD NUMBER $W_n=3$</p> <p>EXECUTION CYCLES $C_n=P \cdot L + 18$</p>	
15	8 7	5 4	3 2	0																	
1 0 0 0	1 1 0 0	AREA	COL	OPM	(\$ 8 C X X)																
15	dX (16 bits)	0																			
15	dY (16 bits)	0																			
<p>< DESCRIPTION ></p> <p>The parameters (dX, dY) define the line end point as relative logical pixel X-Y displacements from the CP.</p> <p>As the line is drawn, CP is moved to Pe. However, the logical pixel at position Pe is not drawn.</p> <div style="text-align: center;"> </div> <p>Figure C19-1 Function of RLINE</p>																					

RLINE (Relative Line)

<EXAMPLE>

If CP = (-13, -10) and RLINE command is executed with parameters (dX, dY) = (10, 2), then a line is drawn and CP is set to Pe as shown below.

COMMAND CODE



COMMAND PARAMETERS

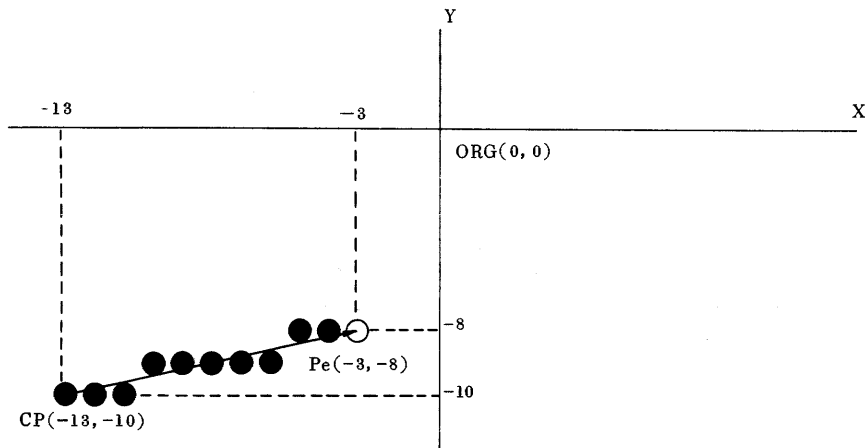
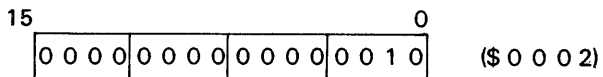
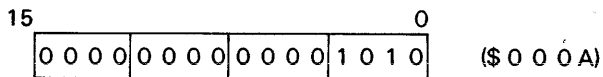


Figure C19-2 Example of RLINE Execution

ARCT

<p>[20] ARCT (Absolute Rectangle)</p>	<p>PAGE</p>	<p>ARCT-1</p>															
<p>< FUNCTION > Draw a rectangle defined by CP and the command specified diagonal point.</p> <p>< MNEMONIC > ARCT (AREA, COL, OPM) X, Y</p>	<p>TYPE</p>	<p>Graphic Command</p>															
<p>< FORMAT ></p> <p>COMMAND CODE hexadecimal notation</p> <table style="width: 100%; border-collapse: collapse;"> <tr> <td style="text-align: right;">15</td> <td style="text-align: center;">8 7 5 4 3 2 0</td> <td style="text-align: right;">0</td> <td></td> </tr> <tr> <td style="border: 1px solid black; text-align: center;">1 0 0 1</td> <td style="border: 1px solid black; text-align: center;">0 0 0 0</td> <td style="border: 1px solid black; text-align: center;">AREA</td> <td style="border: 1px solid black; text-align: center;">COL OPM</td> </tr> </table> <p style="text-align: right;">(\$ 9 0 X X)</p> <p>COMMAND PARAMETERS</p> <table style="width: 100%; border-collapse: collapse;"> <tr> <td style="text-align: right;">15</td> <td style="text-align: center;">0</td> </tr> <tr> <td style="border: 1px solid black; text-align: center;">X (16 bits)</td> <td></td> </tr> <tr> <td style="text-align: right;">15</td> <td style="text-align: center;">0</td> </tr> <tr> <td style="border: 1px solid black; text-align: center;">Y (16 bits)</td> <td></td> </tr> </table>	15	8 7 5 4 3 2 0	0		1 0 0 1	0 0 0 0	AREA	COL OPM	15	0	X (16 bits)		15	0	Y (16 bits)		<p>WORD NUMBER $W_n = 3$</p> <p>EXECUTION CYCLES $C_n = 2p(A+B) + 54$</p>
15	8 7 5 4 3 2 0	0															
1 0 0 1	0 0 0 0	AREA	COL OPM														
15	0																
X (16 bits)																	
15	0																
Y (16 bits)																	
<p>< DESCRIPTION ></p> <p>The parameters (X, Y) define the diagonal point of the rectangle as absolute logical pixel X-Y addresses relative to the origin defined by the ORG command.</p> <p>As the rectangle is drawn, CP is moved to Pe (which is the same as CP). However, the logical pixel at position Pe is not drawn.</p> <p>Drawing starts in the X direction first, and is drawn in the direction shown below. The initial X direction is determined by the relationship between CP and (X, Y).</p> <div style="text-align: center;"> </div> <p>Figure C20-1 Function of ARCT</p>																	

ARCT (Absolute Polyline)

PAGE

ARCT-2

< EXAMPLE >

If CP = (6, -6) and ACT command is executed with parameters (X, Y) = (-16, 10), then a rectangle is drawn and CP is set to Pe as shown below.

< NOTE >

Drawing starts from the X-axis direction.

COMMAND CODE

15			8	7		5	4	3	2	0	
1	0	0	1	0	0	0	0	0	0	0	(\$ 9 0 X X)
							AREA	COL	OPM		

COMMAND PARAMETERS

15										0	
1	1	1	1	1	1	1	1	1	1	0	(\$ F F F 0)

15										0	
0	0	0	0	0	0	0	0	0	1	0	1
											(\$ 0 0 0 A)

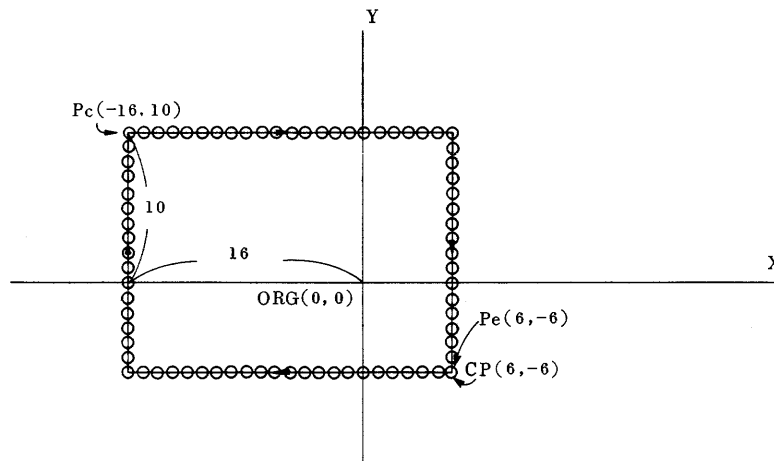


Figure C20-2 Example of ARCT Execution

RRCT

<p>[21] RRCT (Relative Rectangle)</p>	<p>PAGE</p>	<p>RRCT-1</p>																										
<p>< FUNCTION > Draw a rectangle defined by CP and the command specified diagonal point.</p> <p>< MNEMONIC > RRCT (AREA, COL, OPM) dX, dY</p>	<p>TYPE</p>	<p>Graphic Command</p>																										
<p>< FORMAT ></p> <p>COMMAND CODE hexadecimal notation</p> <table border="1" style="margin-left: 20px;"> <tr> <td style="text-align: center;">15</td> <td style="text-align: center;">87</td> <td style="text-align: center;">54</td> <td style="text-align: center;">32</td> <td style="text-align: center;">0</td> <td></td> </tr> <tr> <td style="text-align: center;">1</td> <td style="text-align: center;">0</td> <td style="text-align: center;">0</td> <td style="text-align: center;">1</td> <td style="text-align: center;">0</td> <td style="text-align: center;">0</td> </tr> <tr> <td colspan="2"></td> <td style="text-align: center;">AREA</td> <td style="text-align: center;">COL</td> <td colspan="2" style="text-align: center;">OPM</td> </tr> </table> <p style="margin-left: 100px;">(\$ 9 4 X X)</p> <p>COMMAND PARAMETERS</p> <table border="1" style="margin-left: 20px;"> <tr> <td style="text-align: center;">15</td> <td style="text-align: center;">0</td> </tr> <tr> <td colspan="2" style="text-align: center;">dX (16 bits)</td> </tr> </table> <table border="1" style="margin-left: 20px;"> <tr> <td style="text-align: center;">15</td> <td style="text-align: center;">0</td> </tr> <tr> <td colspan="2" style="text-align: center;">dY (16 bits)</td> </tr> </table>	15	87	54	32	0		1	0	0	1	0	0			AREA	COL	OPM		15	0	dX (16 bits)		15	0	dY (16 bits)		<p>WORD NUMBER $W_n = 3$</p> <p>EXECUTION CYCLES $C_n = 2P(A + B) + 54$</p>	
15	87	54	32	0																								
1	0	0	1	0	0																							
		AREA	COL	OPM																								
15	0																											
dX (16 bits)																												
15	0																											
dY (16 bits)																												
<p>< DESCRIPTION ></p> <p>The parameters (dX, dY) define the diagonal point of the rectangle as relative logical pixel X-Y displacements from the CP.</p> <p>As the rectangle is drawn, CP is moved to Pe. However, the logical pixel at position Pe is not drawn.</p> <p>Drawing starts in the X direction first, and is drawn in the direction show below. The initial X direction is determined by the relationship between CP and (dX, dY).</p> <div style="text-align: center;"> </div> <p style="text-align: center;">Figure C21-1 Function of RRCT</p>																												

RRCT (Relative Rectangular)

PAGE

RRCT-2

< EXAMPLE >

If $CP = (6, -6)$ and RRCT command is executed with parameters $(dX, dY) = (-16, 10)$, then a rectangle is drawn and CP is set to Pe as shown below.

COMMAND CODE

15				8	7	5	4	3	2	0	
1	0	0	1	0	1	0	0	AREA	COL	OPM	(\$ 9 4 X X)

COMMAND PARAMETERS

15										0	
1	1	1	1	1	1	1	1	1	1	1	0

 dX (\$ F F F O)

15											0
0	0	0	0	0	0	0	0	0	0	0	1

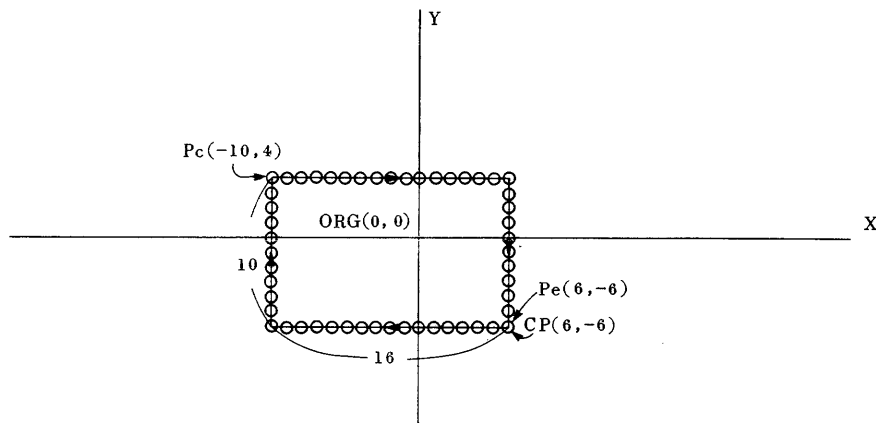
 dY (\$ 0 0 0 A)


Figure C21-2 Example of RRCT

<p>[22] APLL (Absolute Polyline)</p>	<p>PAGE</p>	<p>APLL-1</p>																																																																																																																																																																																																							
<p>< FUNCTION > Draw a polyline (multiple contiguous segments) from the CP through command specified points.</p> <p>< MNEMONIC > APLL (AREA, COL, OPM) n, X₁, Y₁ ... X_n, Y_n</p>	<p>TYPE</p>	<p>Graphic Command</p>																																																																																																																																																																																																							
<p>< FORMAT ></p> <p>COMMAND CODE hexadecimal notation</p> <table style="width: 100%; border-collapse: collapse;"> <tr> <td style="text-align: right; width: 10%;">15</td> <td style="width: 10%;"></td> <td style="text-align: center; width: 10%;">8</td> <td style="text-align: center; width: 10%;">7</td> <td style="text-align: center; width: 10%;">5</td> <td style="text-align: center; width: 10%;">4</td> <td style="text-align: center; width: 10%;">3</td> <td style="text-align: center; width: 10%;">2</td> <td style="text-align: center; width: 10%;">0</td> <td style="width: 10%;"></td> </tr> <tr> <td colspan="2" style="border: 1px solid black; text-align: center;">1 0 0 1</td> <td colspan="2" style="border: 1px solid black; text-align: center;">1 0 0 0</td> <td style="border: 1px solid black; text-align: center;">AREA</td> <td style="border: 1px solid black; text-align: center;">COL</td> <td colspan="2" style="border: 1px solid black; text-align: center;">OPM</td> <td colspan="2" style="text-align: right;">(\$ 9 8 X X)</td> </tr> </table> <p>COMMAND PARAMETERS</p> <table style="width: 100%; border-collapse: collapse;"> <tr> <td style="text-align: right; width: 10%;">15</td> <td style="width: 10%;"></td> <td style="text-align: center; width: 10%;">0</td> <td style="width: 10%;"></td> <td style="width: 10%;"></td> <td style="width: 10%;"></td> <td style="width: 10%;"></td> <td style="width: 10%;"></td> <td style="width: 10%;"></td> <td style="width: 10%;"></td> </tr> <tr> <td colspan="10" style="border: 1px solid black; text-align: center;">n (16 bits)</td> </tr> <tr> <td style="text-align: right;">15</td> <td></td> <td style="text-align: center;">0</td> <td></td> <td></td> <td></td> <td></td> <td></td> <td></td> <td></td> </tr> <tr> <td colspan="10" style="border: 1px solid black; text-align: center;">X₁ (16 bits)</td> </tr> <tr> <td style="text-align: right;">15</td> <td></td> <td style="text-align: center;">0</td> <td></td> <td></td> <td></td> <td></td> <td></td> <td></td> <td style="text-align: right;">P1</td> </tr> <tr> <td colspan="10" style="border: 1px solid black; text-align: center;">Y₁ (16 bits)</td> </tr> <tr> <td style="text-align: right;">15</td> <td></td> <td style="text-align: center;">0</td> <td></td> <td></td> <td></td> <td></td> <td></td> <td></td> <td></td> </tr> <tr> <td colspan="10" style="border: 1px solid black; text-align: center;">X₂ (16 bits)</td> </tr> <tr> <td style="text-align: right;">15</td> <td></td> <td style="text-align: center;">0</td> <td></td> <td></td> <td></td> <td></td> <td></td> <td></td> <td style="text-align: right;">P2</td> </tr> <tr> <td colspan="10" style="border: 1px solid black; text-align: center;">Y₂ (16 bits)</td> </tr> <tr> <td style="text-align: right;">15</td> <td></td> <td style="text-align: center;">0</td> <td></td> <td style="text-align: center;">⋮</td> <td></td> <td></td> <td></td> <td></td> <td style="text-align: center;">⋮</td> </tr> <tr> <td colspan="10" style="border: 1px solid black; text-align: center;">X_{n-1} (16 bits)</td> </tr> <tr> <td style="text-align: right;">15</td> <td></td> <td style="text-align: center;">0</td> <td></td> <td></td> <td></td> <td></td> <td></td> <td></td> <td style="text-align: right;">Pn-1</td> </tr> <tr> <td colspan="10" style="border: 1px solid black; text-align: center;">Y_{n-1} (16 bits)</td> </tr> <tr> <td style="text-align: right;">15</td> <td></td> <td style="text-align: center;">0</td> <td></td> <td></td> <td></td> <td></td> <td></td> <td></td> <td></td> </tr> <tr> <td colspan="10" style="border: 1px solid black; text-align: center;">X_n (16 bits)</td> </tr> <tr> <td style="text-align: right;">15</td> <td></td> <td style="text-align: center;">0</td> <td></td> <td></td> <td></td> <td></td> <td></td> <td></td> <td style="text-align: right;">Pe</td> </tr> <tr> <td colspan="10" style="border: 1px solid black; text-align: center;">Y_n (16 bits)</td> </tr> </table> <p style="margin-top: 10px;">P_{2n+1}</p> <p>n is specified by the absolute value of a 16-bits binary number.</p>	15		8	7	5	4	3	2	0		1 0 0 1		1 0 0 0		AREA	COL	OPM		(\$ 9 8 X X)		15		0								n (16 bits)										15		0								X ₁ (16 bits)										15		0							P1	Y ₁ (16 bits)										15		0								X ₂ (16 bits)										15		0							P2	Y ₂ (16 bits)										15		0		⋮					⋮	X _{n-1} (16 bits)										15		0							Pn-1	Y _{n-1} (16 bits)										15		0								X _n (16 bits)										15		0							Pe	Y _n (16 bits)										<p>WORD NUMBER $W_n = 2n + 2$</p> <p>EXECUTION CYCLES $C_n = \sum (P \cdot L + 16) + 8$</p>
15		8	7	5	4	3	2	0																																																																																																																																																																																																	
1 0 0 1		1 0 0 0		AREA	COL	OPM		(\$ 9 8 X X)																																																																																																																																																																																																	
15		0																																																																																																																																																																																																							
n (16 bits)																																																																																																																																																																																																									
15		0																																																																																																																																																																																																							
X ₁ (16 bits)																																																																																																																																																																																																									
15		0							P1																																																																																																																																																																																																
Y ₁ (16 bits)																																																																																																																																																																																																									
15		0																																																																																																																																																																																																							
X ₂ (16 bits)																																																																																																																																																																																																									
15		0							P2																																																																																																																																																																																																
Y ₂ (16 bits)																																																																																																																																																																																																									
15		0		⋮					⋮																																																																																																																																																																																																
X _{n-1} (16 bits)																																																																																																																																																																																																									
15		0							Pn-1																																																																																																																																																																																																
Y _{n-1} (16 bits)																																																																																																																																																																																																									
15		0																																																																																																																																																																																																							
X _n (16 bits)																																																																																																																																																																																																									
15		0							Pe																																																																																																																																																																																																
Y _n (16 bits)																																																																																																																																																																																																									

APLL (Absolute Polyline)

PAGE APLL-2

< DESCRIPTION >

The first parameter (n) specifies the number of line segments, that is, $n = 1$ specifies one line segment. The following parameters (X_n, Y_n) are absolute logical pixel X-Y addresses, which specify each segments end point relative to the origin defined by the ORG command.

As the polyline is drawn, CP is moved to Pe. However, the logical pixel at position Pe is not drawn.

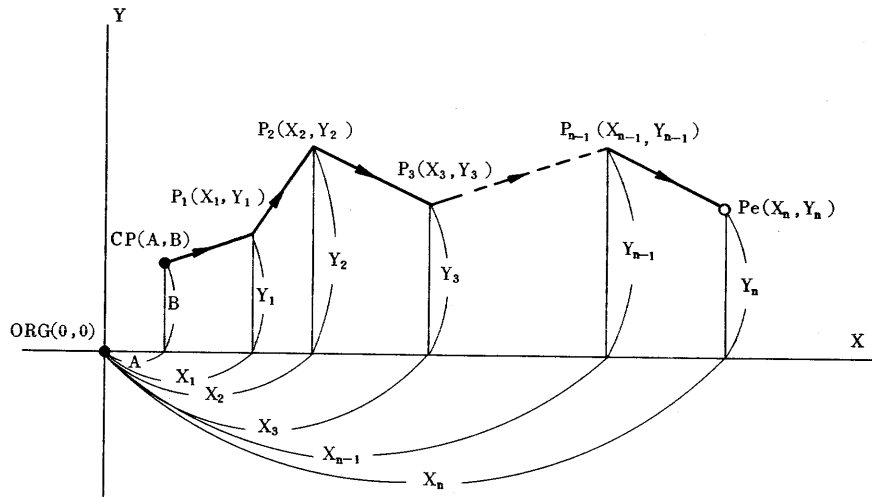


Figure C22-1 Function of APLL

APLL (Absolute Polyline)

< EXECUTION EXAMPLE >

If the CP is at (-8, -6) on the split screen, n is set to 3, X1 to -4, Y1 to 4, X2 to 8, Y2 to 6, X3 to 16 and Y3 to -8, then the APLL command draws a poly line as shown below.

COMMAND CODE

15		8	7	5	4	3	2	0
1	0	0	1	1	0	0	0	0
AREA				COL		OPM		

COMMAND PARAMETERS

15								0	
0	0	0	0	0	0	0	0	0	1
									(\$ 0 0 0 3)
15								0	
1	1	1	1	1	1	1	1	1	0
									(\$ F F F C)
15								0	
0	0	0	0	0	0	0	0	0	1
									(\$ 0 0 0 4)
15								0	
0	0	0	0	0	0	0	0	1	0
									(\$ 0 0 0 8)
15								0	
0	0	0	0	0	0	0	0	0	1
									(\$ 0 0 0 6)
15								0	
0	0	0	0	0	0	0	1	0	0
									(\$ 0 0 1 0)
15								0	
1	1	1	1	1	1	1	1	1	0
									(\$ F F F 8)

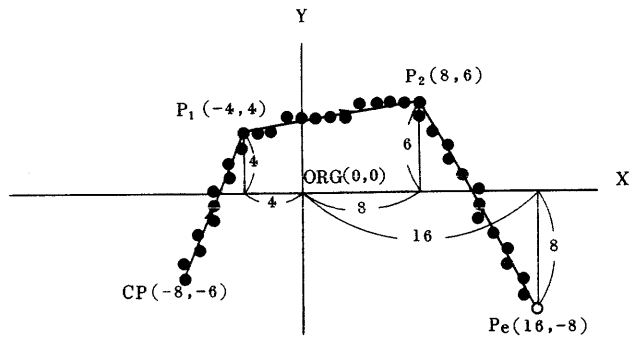


Figure C22-2 Example of APLL Execution

		RPLL																																																																																																																																																																																																																												
[23] RPLL (Relative Polyline)		PAGE	RPLL-1																																																																																																																																																																																																																											
<p>< FUNCTION > RPLL command draws a polyline which connects the Start point, current pointer, and each relative coordinate point.</p> <p>< MNEMONIC > RPLL (AREA, COL, OPM) n, dX₁, dY₁, ... dX_n, dY_n</p>		TYPE	Graphic Command																																																																																																																																																																																																																											
<p>< FORMAT ></p> <p>COMMAND CODE hexadecimal notation</p> <table style="width: 100%; border-collapse: collapse;"> <tr> <td style="width: 5%;"></td> <td style="width: 15%; text-align: center;">15</td> <td style="width: 15%;"></td> <td style="width: 15%; text-align: center;">8 7</td> <td style="width: 15%;"></td> <td style="width: 15%; text-align: center;">5 4</td> <td style="width: 15%;"></td> <td style="width: 15%; text-align: center;">3 2</td> <td style="width: 15%;"></td> <td style="width: 15%; text-align: center;">0</td> <td style="width: 10%;"></td> </tr> <tr> <td style="text-align: center;">C</td> <td style="border: 1px solid black; text-align: center;">1 0 0 1</td> <td style="border: 1px solid black; text-align: center;">1 1 0 0</td> <td style="border: 1px solid black; text-align: center;">AREA</td> <td style="border: 1px solid black; text-align: center;">COL</td> <td style="border: 1px solid black; text-align: center;">OPM</td> <td colspan="4"></td> <td style="text-align: center;">(\$ 9 8 X X)</td> </tr> </table> <p>COMMAND PARAMETERS</p> <table style="width: 100%; border-collapse: collapse;"> <tr> <td style="width: 5%;"></td> <td style="width: 15%; text-align: center;">15</td> <td style="width: 15%;"></td> <td style="width: 15%;"></td> <td style="width: 15%;"></td> <td style="width: 15%;"></td> <td style="width: 15%;"></td> <td style="width: 15%;"></td> <td style="width: 15%;"></td> <td style="width: 15%; text-align: center;">0</td> <td style="width: 10%;"></td> </tr> <tr> <td></td> <td colspan="9" style="border: 1px solid black; text-align: center;">n (16 bits)</td> <td></td> </tr> <tr> <td></td> <td style="text-align: center;">15</td> <td></td> <td></td> <td></td> <td></td> <td></td> <td></td> <td></td> <td style="text-align: center;">0</td> <td></td> </tr> <tr> <td></td> <td colspan="9" style="border: 1px solid black; text-align: center;">dX₁ (16 bits)</td> <td></td> </tr> <tr> <td></td> <td style="text-align: center;">15</td> <td></td> <td></td> <td></td> <td></td> <td></td> <td></td> <td></td> <td style="text-align: center;">0</td> <td style="text-align: center;">P₁</td> </tr> <tr> <td></td> <td colspan="9" style="border: 1px solid black; text-align: center;">dY₁ (16 bits)</td> <td></td> </tr> <tr> <td></td> <td style="text-align: center;">15</td> <td></td> <td></td> <td></td> <td></td> <td></td> <td></td> <td></td> <td style="text-align: center;">0</td> <td></td> </tr> <tr> <td></td> <td colspan="9" style="border: 1px solid black; text-align: center;">dX₂ (16 bits)</td> <td></td> </tr> <tr> <td></td> <td style="text-align: center;">15</td> <td></td> <td></td> <td></td> <td></td> <td></td> <td></td> <td></td> <td style="text-align: center;">0</td> <td style="text-align: center;">P₂</td> </tr> <tr> <td></td> <td colspan="9" style="border: 1px solid black; text-align: center;">dY₂ (16 bits)</td> <td></td> </tr> <tr> <td></td> <td style="text-align: center;">15</td> <td></td> <td style="text-align: center;">⋮</td> <td></td> <td></td> <td></td> <td></td> <td></td> <td style="text-align: center;">0</td> <td style="text-align: center;">⋮</td> </tr> <tr> <td></td> <td colspan="9" style="border: 1px solid black; text-align: center;">dX_{n-1} (16 bits)</td> <td></td> </tr> <tr> <td></td> <td style="text-align: center;">15</td> <td></td> <td></td> <td></td> <td></td> <td></td> <td></td> <td></td> <td style="text-align: center;">0</td> <td style="text-align: center;">P_{n-1}</td> </tr> <tr> <td></td> <td colspan="9" style="border: 1px solid black; text-align: center;">dY_{n-1} (16 bits)</td> <td></td> </tr> <tr> <td></td> <td style="text-align: center;">15</td> <td></td> <td></td> <td></td> <td></td> <td></td> <td></td> <td></td> <td style="text-align: center;">0</td> <td></td> </tr> <tr> <td></td> <td colspan="9" style="border: 1px solid black; text-align: center;">dX_n (16 bits)</td> <td></td> </tr> <tr> <td></td> <td style="text-align: center;">15</td> <td></td> <td></td> <td></td> <td></td> <td></td> <td></td> <td></td> <td style="text-align: center;">0</td> <td style="text-align: center;">P_e</td> </tr> <tr> <td></td> <td colspan="9" style="border: 1px solid black; text-align: center;">dY_n (16 bits)</td> <td></td> </tr> </table> <p style="margin-left: 20px;">P_{2n+1}</p> <p>Set "n" in binary absolute values of 16 bits.</p>			15		8 7		5 4		3 2		0		C	1 0 0 1	1 1 0 0	AREA	COL	OPM					(\$ 9 8 X X)		15								0			n (16 bits)											15								0			dX ₁ (16 bits)											15								0	P ₁		dY ₁ (16 bits)											15								0			dX ₂ (16 bits)											15								0	P ₂		dY ₂ (16 bits)											15		⋮						0	⋮		dX _{n-1} (16 bits)											15								0	P _{n-1}		dY _{n-1} (16 bits)											15								0			dX _n (16 bits)											15								0	P _e		dY _n (16 bits)										<p>WORD NUMBER $W_n = 2n + 2$</p> <p>EXECUTION CYCLES $C_n = \sum (P \cdot L + 16) + 8$</p>
	15		8 7		5 4		3 2		0																																																																																																																																																																																																																					
C	1 0 0 1	1 1 0 0	AREA	COL	OPM					(\$ 9 8 X X)																																																																																																																																																																																																																				
	15								0																																																																																																																																																																																																																					
	n (16 bits)																																																																																																																																																																																																																													
	15								0																																																																																																																																																																																																																					
	dX ₁ (16 bits)																																																																																																																																																																																																																													
	15								0	P ₁																																																																																																																																																																																																																				
	dY ₁ (16 bits)																																																																																																																																																																																																																													
	15								0																																																																																																																																																																																																																					
	dX ₂ (16 bits)																																																																																																																																																																																																																													
	15								0	P ₂																																																																																																																																																																																																																				
	dY ₂ (16 bits)																																																																																																																																																																																																																													
	15		⋮						0	⋮																																																																																																																																																																																																																				
	dX _{n-1} (16 bits)																																																																																																																																																																																																																													
	15								0	P _{n-1}																																																																																																																																																																																																																				
	dY _{n-1} (16 bits)																																																																																																																																																																																																																													
	15								0																																																																																																																																																																																																																					
	dX _n (16 bits)																																																																																																																																																																																																																													
	15								0	P _e																																																																																																																																																																																																																				
	dY _n (16 bits)																																																																																																																																																																																																																													

< DESCRIPTION >

As shown in figure below, the relative poly line command (RPLL) draws a poly line which connects the Start point CP, and each relative coordinate ($P_1, P_2, P_3, \dots, P_{n-1}, P_e$).

The total number of points is set in the 1st command parameter (n_1). X and Y components of each point are set in the command parameters in the order the lines are drawn. CP moves to the End point P_e as the lines are drawn. However, a dot is not drawn at P_e .

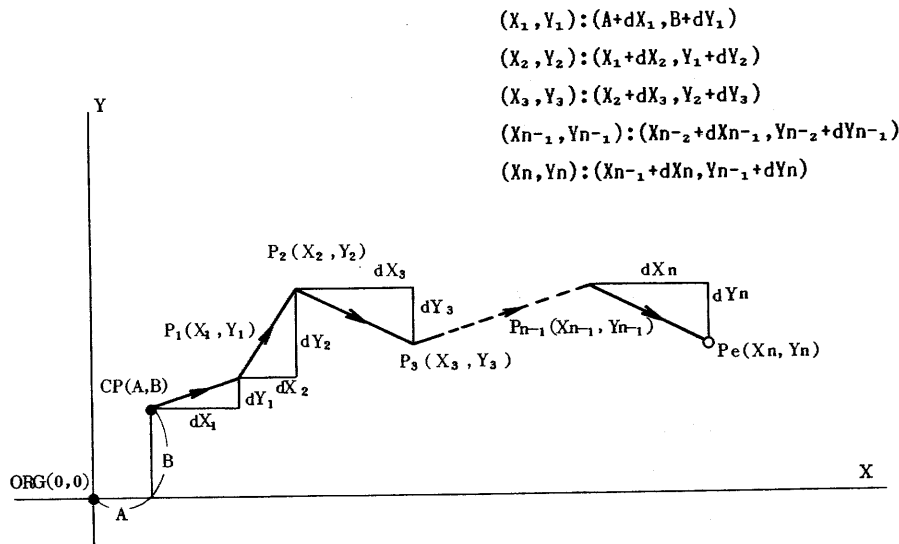


Figure C23-1 Function of RPLL

RPLL (Relative Polyline)

PAGE RPLL-3

< EXECUTION EXAMPLE >

If the CP is at $(-8, -6)$ on the split screen, dX_1 is set to -4 , dY_1 to 4 , dX_2 to 8 , dY_2 to 6 , dX_3 to 16 and dY_3 to -8 , then the RPLL command draws a poly line as shown below.

COMMAND CODE

15		8	7	5	4	3	2	0		
1	0	0	1	1	1	0	0	AREA	COL	OPM

 (\$ 9 C X X)

COMMAND PARAMETERS

15									0
0	0	0	0	0	0	0	0	0	0

 (\$ 0 0 0 3)

15									0
1	1	1	1	1	1	1	1	1	0

 (\$ F F F C)

15									0
0	0	0	0	0	0	0	0	0	1

 (\$ 0 0 0 4)

15									0
0	0	0	0	0	0	0	0	1	0

 (\$ 0 0 0 8)

15									0
0	0	0	0	0	0	0	0	0	1

 (\$ 0 0 0 6)

15									0
0	0	0	0	0	0	1	0	0	0

 (\$ 0 0 1 0)

15									0
1	1	1	1	1	1	1	1	1	0

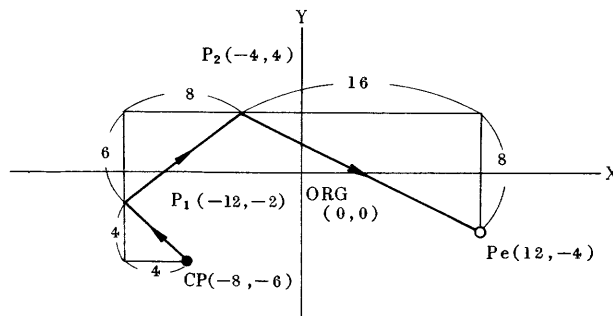
 (\$ F F F 8)


Figure C23-2 Example of RPLL Execution

<p>[24] APLG (Absolute Polygon)</p>	<p>PAGE</p>	<p>APLG-1</p>																																																																																																																							
<p>< FUNCTION > APLG draws a polygon which connects the initial point, CP, and each absolute coordinate.</p> <p>< MNEMONIC > APLG (AREA, COL, OPM) n, X₁, Y₁ X_n, Y_n</p>	<p>TYPE</p>	<p>Graphic Command</p>																																																																																																																							
<p>< FORMAT ></p> <p>COMMAND CODE hexadecimal notation</p> <table style="width: 100%; border-collapse: collapse;"> <tr> <td style="text-align: right; width: 5%;">15</td> <td style="width: 10%;"></td> <td style="text-align: center; width: 5%;">8</td> <td style="text-align: center; width: 5%;">7</td> <td style="text-align: center; width: 5%;">5</td> <td style="text-align: center; width: 5%;">4</td> <td style="text-align: center; width: 5%;">3</td> <td style="text-align: center; width: 5%;">2</td> <td style="text-align: center; width: 5%;">0</td> <td style="width: 10%;"></td> </tr> <tr> <td style="border: 1px solid black; text-align: center;">1</td> <td style="border: 1px solid black; text-align: center;">0</td> <td style="border: 1px solid black; text-align: center;">0</td> <td style="border: 1px solid black; text-align: center;">0</td> <td style="border: 1px solid black; text-align: center;">0</td> <td style="border: 1px solid black; text-align: center;">0</td> <td style="border: 1px solid black; text-align: center;">0</td> <td style="border: 1px solid black; text-align: center;">0</td> <td style="border: 1px solid black; text-align: center;">0</td> <td style="text-align: center;">AREA</td> </tr> <tr> <td style="border: 1px solid black; text-align: center;">0</td> <td style="border: 1px solid black; text-align: center;">0</td> <td style="border: 1px solid black; text-align: center;">0</td> <td style="border: 1px solid black; text-align: center;">0</td> <td style="border: 1px solid black; text-align: center;">0</td> <td style="border: 1px solid black; text-align: center;">0</td> <td style="border: 1px solid black; text-align: center;">0</td> <td style="border: 1px solid black; text-align: center;">0</td> <td style="border: 1px solid black; text-align: center;">0</td> <td style="text-align: center;">COL</td> </tr> <tr> <td style="border: 1px solid black; text-align: center;">0</td> <td style="border: 1px solid black; text-align: center;">0</td> <td style="border: 1px solid black; text-align: center;">0</td> <td style="border: 1px solid black; text-align: center;">0</td> <td style="border: 1px solid black; text-align: center;">0</td> <td style="border: 1px solid black; text-align: center;">0</td> <td style="border: 1px solid black; text-align: center;">0</td> <td style="border: 1px solid black; text-align: center;">0</td> <td style="border: 1px solid black; text-align: center;">0</td> <td style="text-align: center;">OPM</td> </tr> </table> <p style="text-align: right;">(\$ A 0 X X)</p> <p>COMMAND PARAMETERS</p> <table style="width: 100%; border-collapse: collapse;"> <tr> <td style="text-align: right; width: 5%;">15</td> <td style="width: 10%;"></td> <td style="text-align: center; width: 5%;">0</td> <td style="width: 10%;"></td> <td style="width: 10%;"></td> </tr> <tr> <td style="border: 1px solid black; text-align: center;">n (16 bits)</td> <td style="width: 10%;"></td> <td style="width: 10%;"></td> <td style="width: 10%;"></td> <td style="width: 10%;"></td> </tr> <tr> <td style="text-align: right;">15</td> <td></td> <td style="text-align: center;">0</td> <td></td> <td></td> </tr> <tr> <td style="border: 1px solid black; text-align: center;">X₁ (16 bits)</td> <td></td> <td></td> <td></td> <td></td> </tr> <tr> <td style="text-align: right;">15</td> <td></td> <td style="text-align: center;">0</td> <td></td> <td style="text-align: center;">P₁</td> </tr> <tr> <td style="border: 1px solid black; text-align: center;">Y₁ (16 bits)</td> <td></td> <td></td> <td></td> <td></td> </tr> <tr> <td style="text-align: right;">15</td> <td></td> <td style="text-align: center;">0</td> <td></td> <td style="text-align: center;">P₂</td> </tr> <tr> <td style="border: 1px solid black; text-align: center;">X₂ (16 bits)</td> <td></td> <td></td> <td></td> <td></td> </tr> <tr> <td style="text-align: right;">15</td> <td></td> <td style="text-align: center;">0</td> <td style="text-align: center;">⋮</td> <td style="text-align: center;">⋮</td> </tr> <tr> <td style="border: 1px solid black; text-align: center;">X_{n-1} (16 bits)</td> <td></td> <td></td> <td></td> <td style="text-align: center;">P_{n-1}</td> </tr> <tr> <td style="text-align: right;">15</td> <td></td> <td style="text-align: center;">0</td> <td></td> <td></td> </tr> <tr> <td style="border: 1px solid black; text-align: center;">Y_{n-1} (16 bits)</td> <td></td> <td></td> <td></td> <td></td> </tr> <tr> <td style="text-align: right;">15</td> <td></td> <td style="text-align: center;">0</td> <td></td> <td style="text-align: center;">P_n</td> </tr> <tr> <td style="border: 1px solid black; text-align: center;">X_n (16 bits)</td> <td></td> <td></td> <td></td> <td></td> </tr> <tr> <td style="text-align: right;">15</td> <td></td> <td style="text-align: center;">0</td> <td></td> <td></td> </tr> <tr> <td style="border: 1px solid black; text-align: center;">Y_n (16 bits)</td> <td></td> <td></td> <td></td> <td></td> </tr> </table> <p>P_{2n+1}</p> <p>Set "n" in binary absolute values of 16 bits.</p>	15		8	7	5	4	3	2	0		1	0	0	0	0	0	0	0	0	AREA	0	0	0	0	0	0	0	0	0	COL	0	0	0	0	0	0	0	0	0	OPM	15		0			n (16 bits)					15		0			X ₁ (16 bits)					15		0		P ₁	Y ₁ (16 bits)					15		0		P ₂	X ₂ (16 bits)					15		0	⋮	⋮	X _{n-1} (16 bits)				P _{n-1}	15		0			Y _{n-1} (16 bits)					15		0		P _n	X _n (16 bits)					15		0			Y _n (16 bits)					<p>WORD NUMBER $W_n = 2n + 2$</p> <p>EXECUTION CYCLES $C_n = \sum \{P \cdot L + 16\} + P \cdot L_0 + 20$</p>
15		8	7	5	4	3	2	0																																																																																																																	
1	0	0	0	0	0	0	0	0	AREA																																																																																																																
0	0	0	0	0	0	0	0	0	COL																																																																																																																
0	0	0	0	0	0	0	0	0	OPM																																																																																																																
15		0																																																																																																																							
n (16 bits)																																																																																																																									
15		0																																																																																																																							
X ₁ (16 bits)																																																																																																																									
15		0		P ₁																																																																																																																					
Y ₁ (16 bits)																																																																																																																									
15		0		P ₂																																																																																																																					
X ₂ (16 bits)																																																																																																																									
15		0	⋮	⋮																																																																																																																					
X _{n-1} (16 bits)				P _{n-1}																																																																																																																					
15		0																																																																																																																							
Y _{n-1} (16 bits)																																																																																																																									
15		0		P _n																																																																																																																					
X _n (16 bits)																																																																																																																									
15		0																																																																																																																							
Y _n (16 bits)																																																																																																																									

< DESCRIPTION >

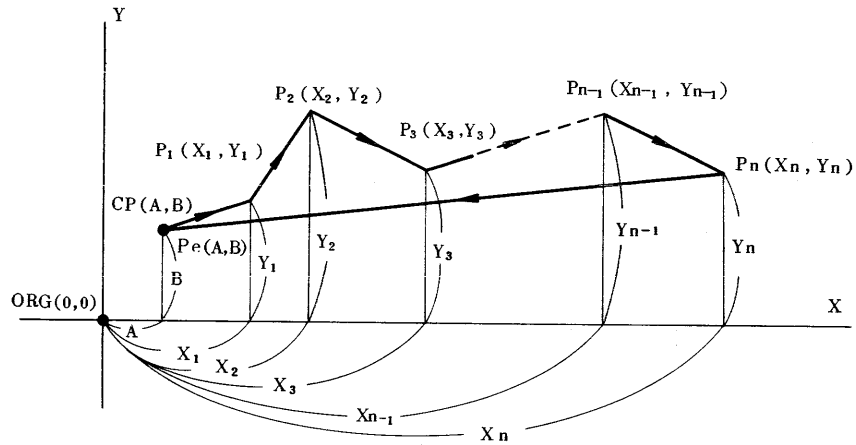


Figure C24-1 Function of APLG

As shown in above figure, the APLG command draws a polygon line which connects the start point, CP, and each absolute coordinate ($P_1, P_2, \dots, P_{n-1}, P_n$), then back to CP. The total number of points are set in the first command parameter. X and Y components of each point are set in the command parameters in the order the lines are drawn. CP moves to the end point CPe to draw a poly line. However a dot is not drawn at Pe. CP is the same point as Pe.

APLG (Absolute Polygon)

<EXAMPLE>

If the CP is at (-8, -6) on the split screen, n is set to 3, X₁ to -4, Y₁ to 4, X₂ to 8, Y₂ to 6, X₃ to 16 and Y₃ to -8 in the command parameter. The APLG command draws a polygon line as shown below.

COMMAND CODE

15										0	
	1	0	1	0	0	0	0	0	AREA	COL	OPM

(\$ A 0 X X)

COMMAND PARAMETERS

15											0
	0	0	0	0	0	0	0	0	0	0	1

(\$ 0 0 0 3)

15											0
	1	1	1	1	1	1	1	1	1	1	0

(\$ F F F C)

15											0
	0	0	0	0	0	0	0	0	0	1	0

(\$ 0 0 0 4)

15											0
	0	0	0	0	0	0	0	0	0	1	0

(\$ 0 0 0 8)

15											0
	0	0	0	0	0	0	0	0	0	1	1

(\$ 0 0 0 6)

15											0
	0	0	0	0	0	0	0	0	1	0	0

(\$ 0 0 1 0)

15											0
	1	1	1	1	1	1	1	1	1	1	0

(\$ F F F 8)

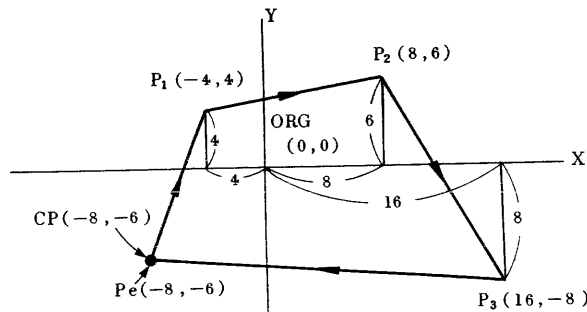


Figure C24-2 Example of APLG Execution

		RPLG																																																																		
[25] RPLG (Relative Polygon)		PAGE	RPLG-1																																																																	
<p>< FUNCTION > APLG draws a polygon which connects the initial point, CP, and each relative coordinate.</p> <p>< MNEMONIC > RPLG (AREA, COL, OPM) n, dX₁, dY₁, ... dX_n, dY_n</p>		TYPE	Graphic Command																																																																	
<p>< FORMAT ></p> <p>COMMAND CODE hexadecimal notation</p> <table style="width: 100%; border-collapse: collapse;"> <tr> <td style="width: 5%; text-align: right;">15</td> <td style="width: 20%;"></td> <td style="width: 5%; text-align: right;">8</td> <td style="width: 5%; text-align: right;">7</td> <td style="width: 5%; text-align: right;">5</td> <td style="width: 5%; text-align: right;">4</td> <td style="width: 5%; text-align: right;">3</td> <td style="width: 5%; text-align: right;">2</td> <td style="width: 5%; text-align: right;">0</td> <td></td> </tr> <tr> <td></td> <td style="border: 1px solid black; text-align: center;">1 0 1 0</td> <td style="border: 1px solid black; text-align: center;">0 1 0 0</td> <td style="border: 1px solid black; text-align: center;">AREA</td> <td style="border: 1px solid black; text-align: center;">COL</td> <td style="border: 1px solid black; text-align: center;">OPM</td> <td colspan="4"></td> <td style="text-align: left;">(\$ A 4 X X)</td> </tr> </table> <p>COMMAND PARAMETERS</p> <table style="width: 100%; border-collapse: collapse;"> <tr> <td style="width: 5%; text-align: right;">15</td> <td style="width: 85%;"></td> <td style="width: 5%; text-align: right;">0</td> <td></td> </tr> <tr> <td></td> <td style="border: 1px solid black; text-align: center;">n (16 bits)</td> <td></td> <td></td> </tr> <tr> <td style="text-align: right;">15</td> <td style="border: 1px solid black; text-align: center;">dX₁ (16 bits)</td> <td style="text-align: right;">0</td> <td></td> </tr> <tr> <td style="text-align: right;">15</td> <td style="border: 1px solid black; text-align: center;">dY₁ (16 bits)</td> <td style="text-align: right;">0</td> <td style="text-align: center;">P₁</td> </tr> <tr> <td style="text-align: right;">15</td> <td style="border: 1px solid black; text-align: center;">dX₂ (16 bits)</td> <td style="text-align: right;">0</td> <td></td> </tr> <tr> <td style="text-align: right;">15</td> <td style="border: 1px solid black; text-align: center;">dY₂ (16 bits)</td> <td style="text-align: right;">0</td> <td style="text-align: center;">P₂</td> </tr> <tr> <td style="text-align: right;">15</td> <td style="border: 1px solid black; text-align: center;">⋮</td> <td style="text-align: right;">0</td> <td style="text-align: center;">⋮</td> </tr> <tr> <td style="text-align: right;">15</td> <td style="border: 1px solid black; text-align: center;">dX_{n-1} (16 bits)</td> <td style="text-align: right;">0</td> <td></td> </tr> <tr> <td style="text-align: right;">15</td> <td style="border: 1px solid black; text-align: center;">dY_{n-1} (16 bits)</td> <td style="text-align: right;">0</td> <td style="text-align: center;">P_{n-1}</td> </tr> <tr> <td style="text-align: right;">15</td> <td style="border: 1px solid black; text-align: center;">dX_n (16 bits)</td> <td style="text-align: right;">0</td> <td></td> </tr> <tr> <td style="text-align: right;">15</td> <td style="border: 1px solid black; text-align: center;">dY_n (16 bits)</td> <td style="text-align: right;">0</td> <td style="text-align: center;">P_n</td> </tr> </table> <p style="margin-left: 20px;">P_{2n+1}</p> <p>Set "n" in binary absolute values of 16 bits.</p>		15		8	7	5	4	3	2	0			1 0 1 0	0 1 0 0	AREA	COL	OPM					(\$ A 4 X X)	15		0			n (16 bits)			15	dX ₁ (16 bits)	0		15	dY ₁ (16 bits)	0	P ₁	15	dX ₂ (16 bits)	0		15	dY ₂ (16 bits)	0	P ₂	15	⋮	0	⋮	15	dX _{n-1} (16 bits)	0		15	dY _{n-1} (16 bits)	0	P _{n-1}	15	dX _n (16 bits)	0		15	dY _n (16 bits)	0	P _n	<p>WORD NUMBER W_n = 2n + 2</p> <p>EXECUTION CYCLES C_n = Σ {P·L + 16} + P·L₀ + 20</p>	
15		8	7	5	4	3	2	0																																																												
	1 0 1 0	0 1 0 0	AREA	COL	OPM					(\$ A 4 X X)																																																										
15		0																																																																		
	n (16 bits)																																																																			
15	dX ₁ (16 bits)	0																																																																		
15	dY ₁ (16 bits)	0	P ₁																																																																	
15	dX ₂ (16 bits)	0																																																																		
15	dY ₂ (16 bits)	0	P ₂																																																																	
15	⋮	0	⋮																																																																	
15	dX _{n-1} (16 bits)	0																																																																		
15	dY _{n-1} (16 bits)	0	P _{n-1}																																																																	
15	dX _n (16 bits)	0																																																																		
15	dY _n (16 bits)	0	P _n																																																																	

< DESCRIPTION >

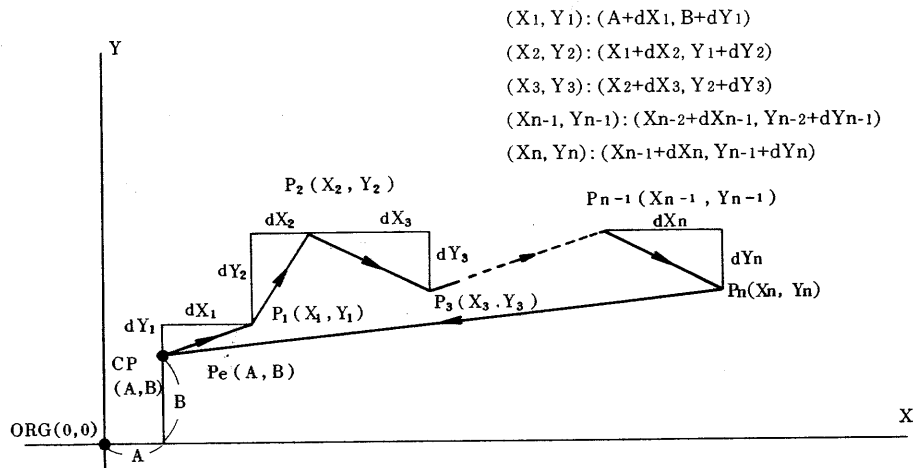


Figure C25-1 Function of RPLG

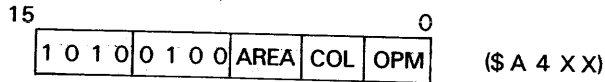
As shown in above figure, the RPLG command draws a polygon line which connects the start point, CP, and each related coordinate ($P_1, P_2, P_3, \dots, P_{n-1}, P_n$), then back to CP. The total number of points are set in the first command parameter. X and Y components of each point are set in the command parameters in the order the lines are drawn. CP moves to the end point Pe as the lines are drawn. However a dot is not drawn at Pe. CP is the same point as Pe.

RPLG (Relative Polygon)

< EXAMPLE >

If the CP is at (-8, -6) on the split screen, n is set to 3, dX₁ to -4, dY₁ to 4, dX₂ to 8, dY₂ to 6, dX₃ to 16 and dY₃ to -8 in the command parameter, then the RPLG command draws a polygon line as shown below.

COMMAND CODE



COMMAND PARAMETERS

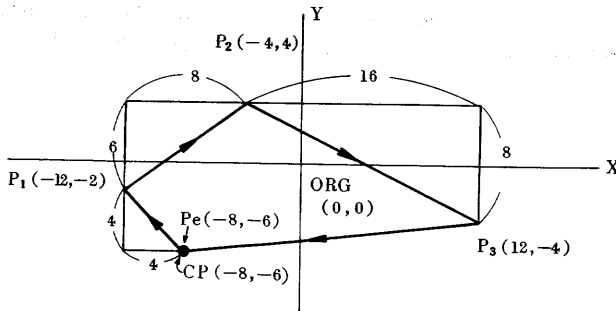
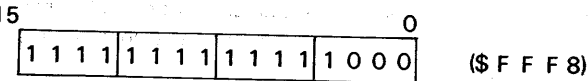
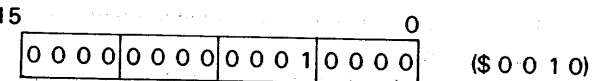
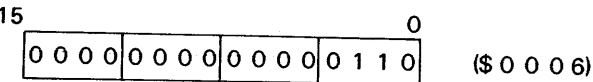
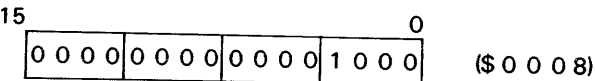
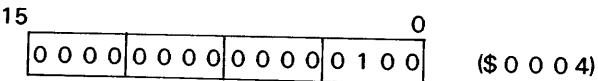
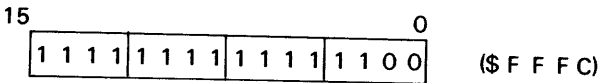
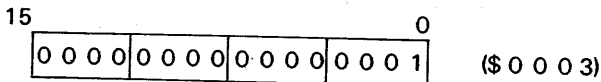


Figure C25-2 Example of RPLG Execution

		CRCL																	
[26] CRCL (Circle Command)	PAGE	CRCL-1																	
<p>< FUNCTION > CRCL Command draws a circle of the radius R placing the CP at the center.</p> <p>< MNEMONIC > CRCL (C, AREA, COL, OPM) r</p>	TYPE	Graphic Command																	
<p>< FORMAT ></p> <p>COMMAND CODE hexadecimal notation</p> <table style="margin-left: 20px;"> <tr> <td style="text-align: right;">15</td> <td style="text-align: center;">9 8 7</td> <td style="text-align: center;">5 4</td> <td style="text-align: center;">3 2</td> <td style="text-align: center;">0</td> <td></td> </tr> <tr> <td style="border: 1px solid black; padding: 2px;">1 0 1 0</td> <td style="border: 1px solid black; padding: 2px;">1 0 0 0</td> <td style="border: 1px solid black; padding: 2px;">C</td> <td style="border: 1px solid black; padding: 2px;">AREA</td> <td style="border: 1px solid black; padding: 2px;">COL</td> <td style="border: 1px solid black; padding: 2px;">OPM</td> </tr> </table> <p style="margin-left: 40px;">C = 1 : (\$ A 9 X X) C = 0 : (\$ A 8 X X)</p> <p>COMMAND PARAMETERS</p> <table style="margin-left: 20px;"> <tr> <td style="text-align: right;">15</td> <td style="text-align: center;">0</td> </tr> <tr> <td colspan="2" style="border: 1px solid black; padding: 5px; text-align: center;">r (16 bits)</td> </tr> </table>	15	9 8 7	5 4	3 2	0		1 0 1 0	1 0 0 0	C	AREA	COL	OPM	15	0	r (16 bits)		<p>WORD NUMBER $W_n = 2$</p> <p>EXECUTION CYCLES $C_n = 8d + 66$</p>		
15	9 8 7	5 4	3 2	0															
1 0 1 0	1 0 0 0	C	AREA	COL	OPM														
15	0																		
r (16 bits)																			
<p>< DESCRIPTION ></p> <p>The Circle Command (CRCL) draws a circle placing the Current Pointer (CP) at the center. The command parameter r specifies a radius in units of pixels.</p> <p>First the CP moves in the X-direction from the center for the length of the radius r. Now this point is named Ps. The circle drawing starts at Ps and finishes at P1 (=Ps). But, a dot is not drawn at P1. After the circle has been drawn, the CP moves back to the center and the command is finished. The position of the CP and Pe are the same.</p> <p>Bit 8 (C) of the command code specifies whether a circle is drawn clockwise or counterclockwise. When C = 1, it is drawn clockwise, when C = 0, counterclockwise as shown next page.</p> <p>The parameter radius r is allocated 16 bits, but only the low order 13 bits are effective.</p>																			

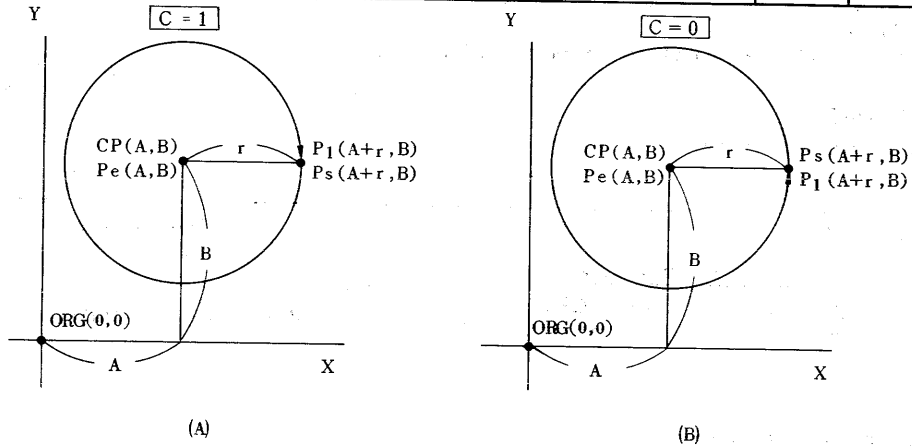
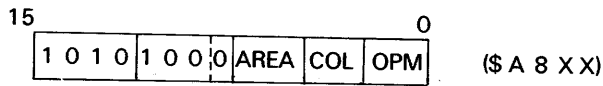


Figure C26-1 Function of CRCL

< EXAMPLE >

If the CP is (0, 0) on the split screen, and r is set 7 in the command parameter, then the CRCL Command draws a circle as shown in figure below.

COMMAND CODE



COMMAND PARAMETERS

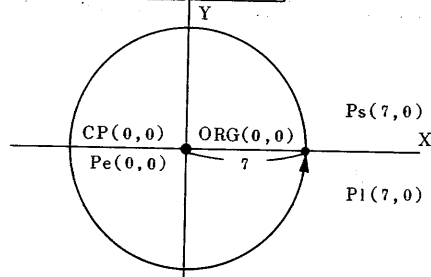
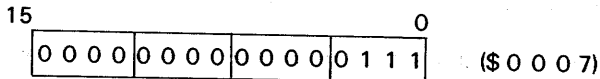


Figure C26-2 Example of CRCL Execution

ELPS																														
[27] ELPS (Ellipse Command)	PAGE ELPS-1																													
<p>< FUNCTION > ELPS Command draws an ellipse placing the CP at the center.</p> <p>< MNEMONIC > ELPS (C, AREA, COL, OPM) a, b, DX</p>	<p>TYPE</p> <p>Graphic Command</p>																													
<p>COMMAND CODE</p> <table style="width: 100%; border-collapse: collapse;"> <tr> <td style="text-align: right; padding-right: 10px;">15</td> <td style="text-align: center; padding: 0 10px;">9 8 7</td> <td style="text-align: center; padding: 0 10px;">5 4</td> <td style="text-align: center; padding: 0 10px;">3 2</td> <td style="text-align: center; padding: 0 10px;">0</td> <td style="padding-left: 20px;">hexadecimal notation</td> </tr> <tr> <td style="border: 1px solid black; text-align: center; padding: 2px;">1 0 1 0</td> <td style="border: 1px solid black; text-align: center; padding: 2px;">1 1 0 1</td> <td style="border: 1px solid black; text-align: center; padding: 2px;">C</td> <td style="border: 1px solid black; text-align: center; padding: 2px;">AREA</td> <td style="border: 1px solid black; text-align: center; padding: 2px;">COL</td> <td style="border: 1px solid black; text-align: center; padding: 2px;">OPM</td> <td style="padding-left: 20px;">C = 1 : (\$ A D X X)</td> </tr> <tr> <td></td> <td></td> <td></td> <td></td> <td></td> <td></td> <td style="padding-left: 20px;">C = 0 : (\$ A C X X)</td> </tr> </table> <p>COMMAND PARAMETERS</p> <table style="width: 100%; border-collapse: collapse;"> <tr> <td style="text-align: right; padding-right: 10px;">15</td> <td style="border: 1px solid black; text-align: center; padding: 5px;">a (16 bits)</td> <td style="text-align: left; padding-left: 10px;">0</td> </tr> <tr> <td style="text-align: right; padding-right: 10px;">15</td> <td style="border: 1px solid black; text-align: center; padding: 5px;">b (16 bits)</td> <td style="text-align: left; padding-left: 10px;">0</td> </tr> <tr> <td style="text-align: right; padding-right: 10px;">15</td> <td style="border: 1px solid black; text-align: center; padding: 5px;">dX (16 bits)</td> <td style="text-align: left; padding-left: 10px;">0</td> </tr> </table>	15	9 8 7	5 4	3 2	0	hexadecimal notation	1 0 1 0	1 1 0 1	C	AREA	COL	OPM	C = 1 : (\$ A D X X)							C = 0 : (\$ A C X X)	15	a (16 bits)	0	15	b (16 bits)	0	15	dX (16 bits)	0	<p>WORD NUMBER Wn=4</p> <p>EXECUTION CYCLES Cn=10d+90</p>
15	9 8 7	5 4	3 2	0	hexadecimal notation																									
1 0 1 0	1 1 0 1	C	AREA	COL	OPM	C = 1 : (\$ A D X X)																								
						C = 0 : (\$ A C X X)																								
15	a (16 bits)	0																												
15	b (16 bits)	0																												
15	dX (16 bits)	0																												
<p>< DESCRIPTION > The Ellipse Command (ELPS) draws an ellipse placing the current pointer (CP) at the center.</p> <p>On the X-Y coordinates, if the center of an ellipse is CP (A, B), the major axis is dX, and the minor axis is dY. An ellipse is drawn according to Equation (1) as shown next page.</p> $\frac{(X-A)^2}{dX^2} + \frac{(Y-B)^2}{dY^2} = 1 \dots\dots\dots (1)$ <p>In Equation (1), letting the ratio of squared dX and dY be a, b;</p> $a : b = dX^2 : dY^2 \dots\dots\dots (2)$ <p>Then substituting (2) for Equation (1);</p> $\frac{(X-A)^2}{a} + \frac{(Y-B)^2}{b} = \frac{dX^2}{a} \dots\dots\dots (3)$																														

ELPS (Ellipse Command)

The ELPS Command draws an ellipse according to Equation (3). The a, b, dX are specified in units of pixels.

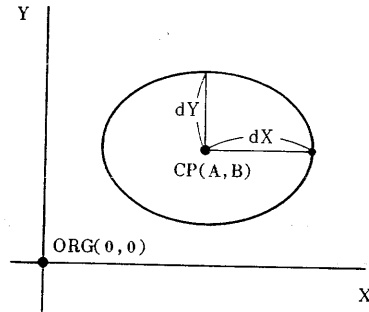


Figure C27-1 Function of ELPS

As shown in figure below, the CP moves in the X-direction from the center for the length of dX. This point is named Ps. The ellipse drawing starts at Ps and finishes at P1 (=Ps). But, the dot is not drawn at P1. After the ellipse has been drawn, the CP moves back to the center, and the command is finished. The first position of the CP and Pe are the same.

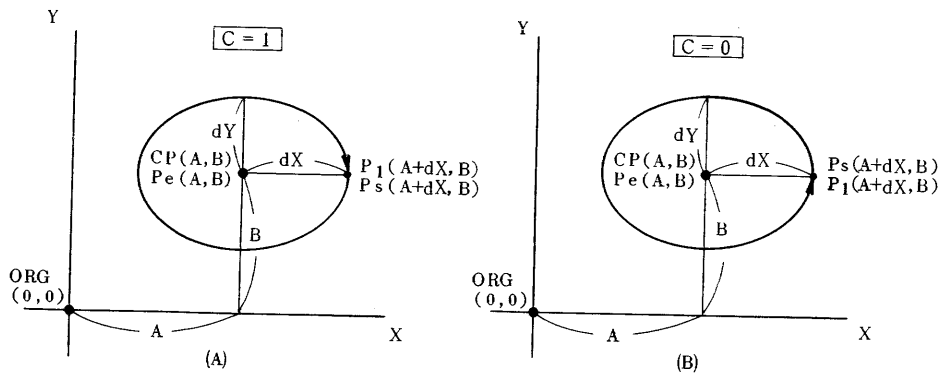


Figure C27-2 Drawing Direction of ELPS

< EXAMPLE >

Bit 8 (c) of the command code specifies whether an ellipse is drawn clockwise or counterclockwise. When C = 1, it is drawn clockwise, when C = 0, counterclockwise as shown in previous page.

If the bit length of a, b, dX are l_a, l_b, l_{dX} , then the bit length of these parameters must be as follows;

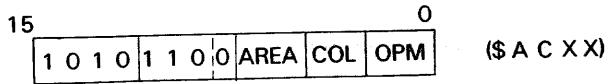
$$l_a + l_{dX} \leq 13$$

$$l_b + l_{dX} \leq 13$$

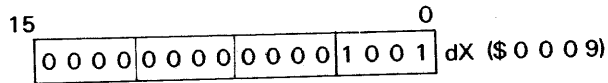
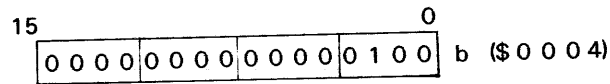
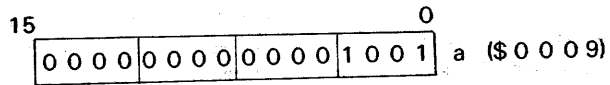
< EXECUTION EXAMPLE >

If the absolute coordinate of CP is (16, 10) on the split screen, a is set to 9, b to 4, dX to 9 in the command parameter, then the ELPS Command (C = 0) draws an ellipse as shown below.

COMMAND CODE



COMMAND PARAMETERS



$$9 : 4 = 9^2 : 6^2$$

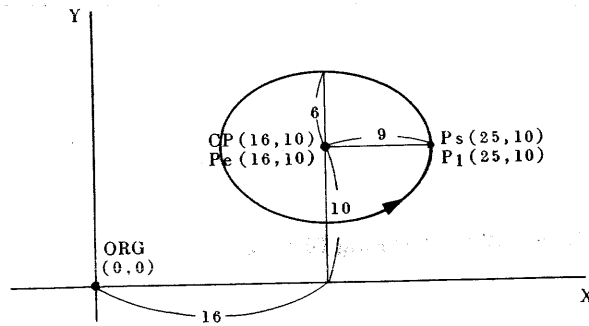


Figure C27-3 Example of ELPS Execution

AARC																																						
[28] AARC (Absolute Arc)	PAGE AARC-1																																					
<p>< FUNCTION > AARC draws an arc by current pointer (start point), end point, and center point of the absolute coordinate.</p> <p>< MNEMONIC > AARC (C, AREA, COL, OPM) Xc, Yc, Xe, Ye</p>	<p>TYPE</p> <p>Graphic Command</p>																																					
<p>< FORMAT ></p> <p>COMMAND CODE</p> <table style="margin-left: 40px;"> <tr> <td style="text-align: right;">15</td> <td style="text-align: center;">9 8 7</td> <td style="text-align: center;">5 4</td> <td style="text-align: center;">3 2</td> <td style="text-align: right;">0</td> <td></td> </tr> <tr> <td></td> <td style="border: 1px solid black; padding: 2px;">1 0 1 1</td> <td style="border: 1px solid black; padding: 2px;">0 0 0</td> <td style="border: 1px solid black; padding: 2px;">C</td> <td style="border: 1px solid black; padding: 2px;">AREA</td> <td style="border: 1px solid black; padding: 2px;">COL</td> <td style="border: 1px solid black; padding: 2px;">OPM</td> </tr> </table> <p style="margin-left: 100px;">hexadecimal notation</p> <p style="margin-left: 100px;">C = 1 : (\$ B 1 X X)</p> <p style="margin-left: 100px;">C = 0 : (\$ B 0 X X)</p> <p>COMMAND PARAMETERS</p> <table style="margin-left: 40px;"> <tr> <td style="text-align: right;">15</td> <td style="border: 1px solid black; width: 150px; height: 20px;"></td> <td style="text-align: right;">0</td> </tr> <tr> <td></td> <td style="text-align: center;">Xc (16 bits)</td> <td></td> </tr> <tr> <td style="text-align: right;">15</td> <td style="border: 1px solid black; width: 150px; height: 20px;"></td> <td style="text-align: right;">0</td> </tr> <tr> <td></td> <td style="text-align: center;">Yc (16 bits)</td> <td></td> </tr> <tr> <td style="text-align: right;">15</td> <td style="border: 1px solid black; width: 150px; height: 20px;"></td> <td style="text-align: right;">0</td> </tr> <tr> <td></td> <td style="text-align: center;">Xe (16 bits)</td> <td></td> </tr> <tr> <td style="text-align: right;">15</td> <td style="border: 1px solid black; width: 150px; height: 20px;"></td> <td style="text-align: right;">0</td> </tr> <tr> <td></td> <td style="text-align: center;">Ye (16 bits)</td> <td></td> </tr> </table>	15	9 8 7	5 4	3 2	0			1 0 1 1	0 0 0	C	AREA	COL	OPM	15		0		Xc (16 bits)		15		0		Yc (16 bits)		15		0		Xe (16 bits)		15		0		Ye (16 bits)		<p>WORD NUMBER Wn=5</p> <p>EXECUTION CYCLES Cn=8d+18</p>
15	9 8 7	5 4	3 2	0																																		
	1 0 1 1	0 0 0	C	AREA	COL	OPM																																
15		0																																				
	Xc (16 bits)																																					
15		0																																				
	Yc (16 bits)																																					
15		0																																				
	Xe (16 bits)																																					
15		0																																				
	Ye (16 bits)																																					
<p>< DESCRIPTION ></p> <p>As shown in Fig. C28-1, the AARC command draws an arc from the current pointer, CP, to Pe of the absolute coordinate, the absolute coordinates CC (Xc, Yc) being the center point. The X and Y components of the absolute coordinates CC and Pe are set in the first and second parameters in units of pixels. After the arc drawing, current pointer moves to Pe. However a dot is not drawn at Pe. The command code bit 8 (C) selects whether an arc is drawn clockwise or counterclockwise. When C is "1", the arc is drawn clockwise, and when C is "0", the arc is drawn counterclockwise as shown in Fig. C28-1.</p>																																						

The command parameters are allocated 16 bits, but only the low order 13 bits are effective.

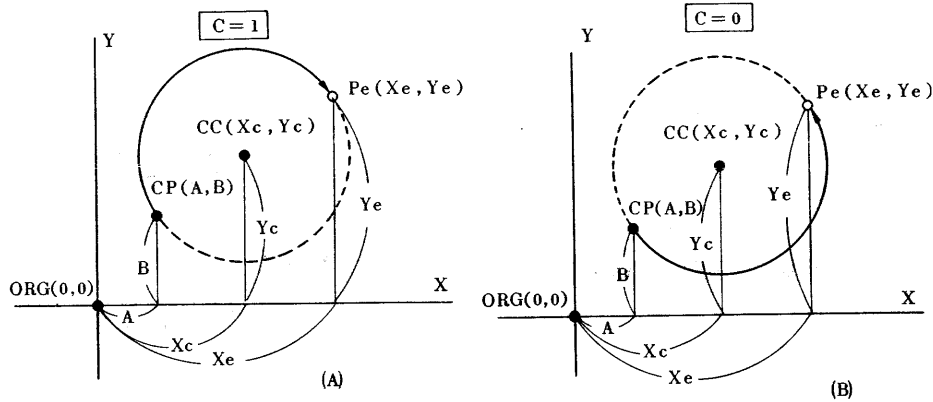
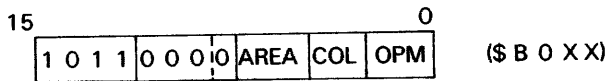


Figure C28-1 Function of AARC Command

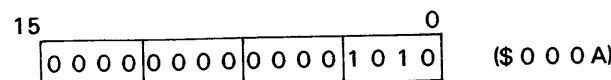
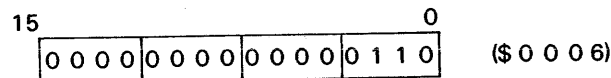
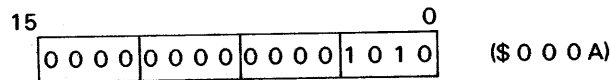
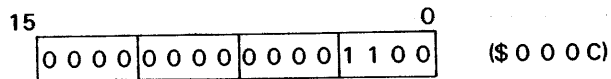
< EXAMPLE >

If the coordinate of CP is at (12, 4) on the split screen, Xc is set to 12, Yc to 10, Xe to 6, and Ye to 10 in the command parameter, then the AARC Command (C = 0) draws an arc as shown in figure next page.

COMMAND CODE



COMMAND PARAMETERS



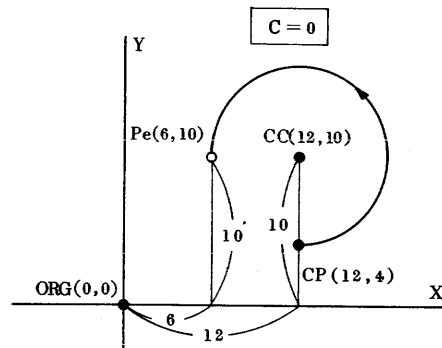


Figure C28-2 Example of AARC Execution

		RARC																																												
[29] RARC (Relative Arc)		PAGE	RARC-1																																											
<p>< FUNCTION > RARC draws an arc by current pointer (start point), end point, and center point of the relative coordinate.</p> <p>< MNEMONIC > RARC (C, AREA, COL, OPM) dXc, dYc, dXe, dYe</p>		TYPE	Graphic Command																																											
<p>< FORMAT ></p> <p>COMMAND CODE hexadecimal notation</p> <table style="width: 100%; border-collapse: collapse;"> <tr> <td style="text-align: right; width: 10%;">15</td> <td style="width: 10%;"></td> <td style="text-align: center; width: 10%;">9 8 7</td> <td style="width: 10%;"></td> <td style="text-align: center; width: 10%;">5 4</td> <td style="width: 10%;"></td> <td style="text-align: center; width: 10%;">3 2</td> <td style="width: 10%;"></td> <td style="text-align: right; width: 10%;">0</td> <td style="width: 10%;"></td> </tr> <tr> <td colspan="2" style="border: 1px solid black; text-align: center;">1 0 1 1</td> <td colspan="2" style="border: 1px solid black; text-align: center;">0 1 0 C</td> <td colspan="2" style="border: 1px solid black; text-align: center;">AREA</td> <td colspan="2" style="border: 1px solid black; text-align: center;">COL</td> <td colspan="2" style="border: 1px solid black; text-align: center;">OPM</td> </tr> </table> <p style="margin-left: 40px;">C = 1 : (\$ B 5 X X) C = 0 : (\$ B 4 X X)</p> <p>COMMAND PARAMETERS</p> <table style="width: 100%; border-collapse: collapse;"> <tr> <td style="text-align: right; width: 10%;">15</td> <td style="width: 80%;"></td> <td style="text-align: right; width: 10%;">0</td> </tr> <tr> <td colspan="3" style="border: 1px solid black; text-align: center; padding: 5px;">dXc (16 bits)</td> </tr> <tr> <td style="text-align: right;">15</td> <td></td> <td style="text-align: right;">0</td> </tr> <tr> <td colspan="3" style="border: 1px solid black; text-align: center; padding: 5px;">dYc (16 bits)</td> </tr> <tr> <td style="text-align: right;">15</td> <td></td> <td style="text-align: right;">0</td> </tr> <tr> <td colspan="3" style="border: 1px solid black; text-align: center; padding: 5px;">dXe (16 bits)</td> </tr> <tr> <td style="text-align: right;">15</td> <td></td> <td style="text-align: right;">0</td> </tr> <tr> <td colspan="3" style="border: 1px solid black; text-align: center; padding: 5px;">dYe (16 bits)</td> </tr> </table>		15		9 8 7		5 4		3 2		0		1 0 1 1		0 1 0 C		AREA		COL		OPM		15		0	dXc (16 bits)			15		0	dYc (16 bits)			15		0	dXe (16 bits)			15		0	dYe (16 bits)			<p>WORD NUMBER $W_n = 5$</p> <p>EXECUTION CYCLES $C_n = 8d + 18$</p>
15		9 8 7		5 4		3 2		0																																						
1 0 1 1		0 1 0 C		AREA		COL		OPM																																						
15		0																																												
dXc (16 bits)																																														
15		0																																												
dYc (16 bits)																																														
15		0																																												
dXe (16 bits)																																														
15		0																																												
dYe (16 bits)																																														
<p>< DESCRIPTION ></p> <p>As shown in Fig. C29-1, the RARC command draws an arc from the current pointer, CP, to Pe (A+ dXe, B+ dYe) of the relative coordinates, the relative coordinates CC (A+ dXc, B+ dYc) being the center points. The X and Y components of the relative coordinates CC and Pe are set in the first and second parameters in units of pixels. CP moves to the end point Pe when an arc is drawn. However a dot is not drawn at Pe. The command code bit 8(C) selects whether an arc is drawn clockwise or counterclockwise. When C is "1", the arc is drawn clockwise, and when C is "0", the arc is drawn counterclockwise as shown in Fig. C29-2.</p>																																														

RARC (Relative Arc)

The command parameters are allocated 16 bits, but only the low order 13 bits are effective.

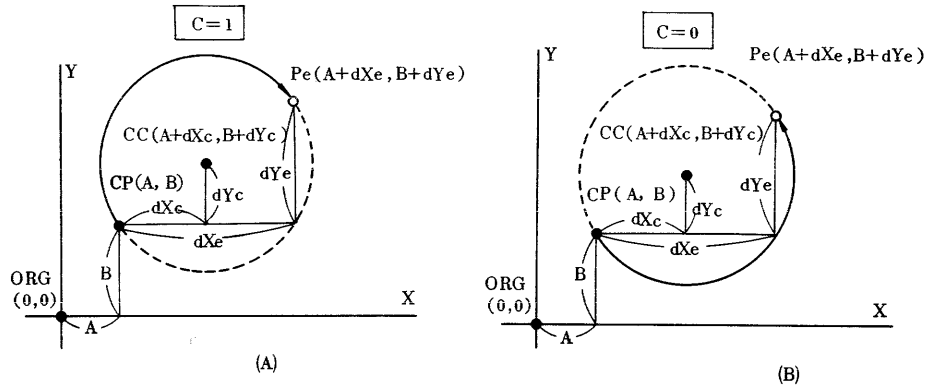


Figure C29-1 Function of RARC

< EXAMPLE >

If the coordinate of CP is at (6, 10) on the split screen, dXc is set to 6, dYc to 0, dXe to 6, and dYe to 6 in the command parameter, then the RARC command (C = 0) draws an arc as shown next page.

COMMAND CODE

15									0
	1	0	1	1	0	1	0	0	

(\$ B 4 X X)

COMMAND PARAMETERS

15									0
	0	0	0	0	0	0	0	0	0

(\$ 0 0 0 6)

15									0
	0	0	0	0	0	0	0	0	0

(\$ 0 0 0 0)

15									0
	0	0	0	0	0	0	0	0	0

(\$ 0 0 0 6)

15									0
	0	0	0	0	0	0	0	0	0

(\$ 0 0 0 6)

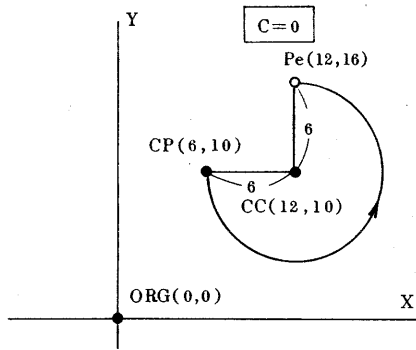


Figure C29-2 Example of RARC Execution

AEARC																															
[30] AEARC (Absolute Ellipse ARC)	PAGE AEARC-1																														
<p>< FUNCTION > AEARC draws an ellipse ARC.</p> <p>< MNEMONIC > AEARC (C, AREA, COL, OPM) a, b, Xc, Yc, Xe, Ye</p>	<p>TYPE</p> <p>Graphic Command</p>																														
<p>< FORMAT ></p> <p>COMMAND CODE hexadecimal notation</p> <table style="width: 100%; border-collapse: collapse;"> <tr> <td style="text-align: right;">15</td> <td style="text-align: center;">9 8 7</td> <td style="text-align: center;">5 4</td> <td style="text-align: center;">3 2</td> <td style="text-align: right;">0</td> <td></td> </tr> <tr> <td colspan="5" style="border: 1px solid black; text-align: center;">1 0 1 1 1 0 0 C AREA COL OPM</td> <td> C = 1 : (\$ B 9 X X) C = 0 : (\$ B 8 X X) </td> </tr> </table> <p>COMMAND PARAMETERS</p> <table style="width: 100%; border-collapse: collapse;"> <tr> <td style="text-align: right;">15</td> <td style="border: 1px solid black; text-align: center; width: 100%;">a (16 bits)</td> <td style="text-align: right;">0</td> </tr> <tr> <td style="text-align: right;">15</td> <td style="border: 1px solid black; text-align: center;">b (16 bits)</td> <td style="text-align: right;">0</td> </tr> <tr> <td style="text-align: right;">15</td> <td style="border: 1px solid black; text-align: center;">Xc (16 bits)</td> <td style="text-align: right;">0</td> </tr> <tr> <td style="text-align: right;">15</td> <td style="border: 1px solid black; text-align: center;">Yc (16 bits)</td> <td style="text-align: right;">0</td> </tr> <tr> <td style="text-align: right;">15</td> <td style="border: 1px solid black; text-align: center;">Xe (16 bits)</td> <td style="text-align: right;">0</td> </tr> <tr> <td style="text-align: right;">15</td> <td style="border: 1px solid black; text-align: center;">Ye (16 bits)</td> <td style="text-align: right;">0</td> </tr> </table>	15	9 8 7	5 4	3 2	0		1 0 1 1 1 0 0 C AREA COL OPM					C = 1 : (\$ B 9 X X) C = 0 : (\$ B 8 X X)	15	a (16 bits)	0	15	b (16 bits)	0	15	Xc (16 bits)	0	15	Yc (16 bits)	0	15	Xe (16 bits)	0	15	Ye (16 bits)	0	<p>WORD NUMBER Wn=7</p> <p>EXECUTION CYCLES Cn=10d+96</p>
15	9 8 7	5 4	3 2	0																											
1 0 1 1 1 0 0 C AREA COL OPM					C = 1 : (\$ B 9 X X) C = 0 : (\$ B 8 X X)																										
15	a (16 bits)	0																													
15	b (16 bits)	0																													
15	Xc (16 bits)	0																													
15	Yc (16 bits)	0																													
15	Xe (16 bits)	0																													
15	Ye (16 bits)	0																													
<p>< DESCRIPTION ></p> <p>The AEARC command draws an arc from the current pointer, CP, to Pe of the absolute coordinate, the absolute coordinates CC (Xc, Yc) being the center point. the X and Y components of the absolute coordinates CC and Pe are set in the command parameters in units of pixels.</p> <p>CP moves to the end point Pe when an arc is drawn. However a dot is not drawn at Pe.</p>																															

The command code bit 8(C) selects whether an arc is drawn clockwise or counterclockwise. When C is "1", the arc is drawn clockwise, and when C is "0", the arc is drawn counterclockwise as shown in Fig. C30-1.

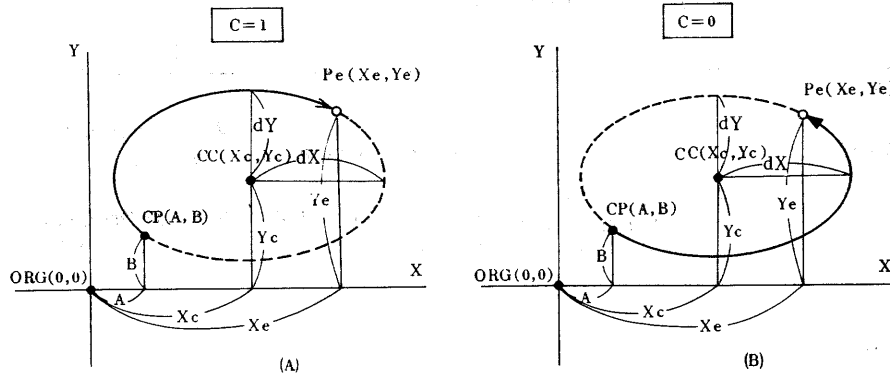


Figure C30-1 Function of AEARC

< RELATED EQUATIONS >

In the X-Y coordinate, let the center point of the ellipse be $CC(X_c, Y_c)$, let the length of the X-axis be dX , and let the length of the Y-axis be dY . Depending on (1), an ellipse ARC is drawn as shown in Fig. C30-2.

$$\frac{(X-X_c)^2}{dX^2} + \frac{(Y-Y_c)^2}{dY^2} = 1 \dots\dots\dots (1)$$

When letting dX^2 and dY^2 be a and b ,
 then $a : b = dX^2 : dY^2 \dots\dots\dots (2)$

by substituting (2) for (1), the result is

$$\frac{(X-X_c)^2}{a} + \frac{(Y-Y_c)^2}{b} = \frac{dX^2}{a} \dots\dots\dots (3)$$

The AEARC draws an ellipse ARC according to Equation (3).

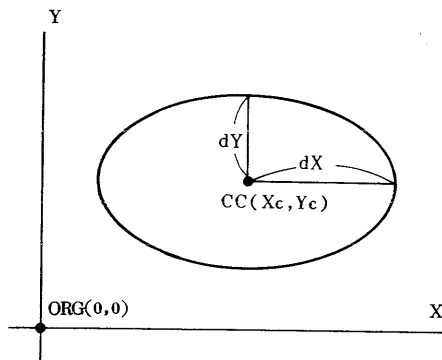


Figure C30-2 Notation of an Ellipse (1)

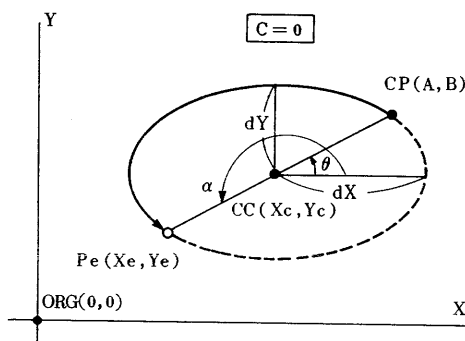


Figure C30-3 Notation of an Ellipse (2)

When setting CP (A, B) and CPe (Xe, Ye) as shown in Fig. C30-3 for an ellipse arc drawing, the following equations are applicable.

AEARC (Absolute Ellipse ARC)

$$A = \frac{dXdY \cos \theta}{\sqrt{dX^2 \sin^2 \theta + dY^2 \cos^2 \theta}} + Xc \dots\dots\dots (4)$$

$$B = \frac{dXdY \sin \theta}{\sqrt{dX^2 \sin^2 \theta + dY^2 \cos^2 \theta}} + Yc \dots\dots\dots (5)$$

$$Xe = \frac{dXdY \cos \alpha}{\sqrt{dX^2 \sin^2 \alpha + dY^2 \cos^2 \alpha}} + Xc \dots\dots\dots (6)$$

$$Ye = \frac{dXdY \sin \alpha}{\sqrt{dX^2 \sin^2 \alpha + dY^2 \cos^2 \alpha}} + Yc \dots\dots\dots (7)$$

a, b, Xc, Yc, Xe and Ye are given as a parameter to the AEARC command in units of pixels. When setting the command parameters, CC (Xc, Yc) of an ellipse, and CP (A, B) and Pe (Xe, Ye) and ellipse ARC must meet the above (4), (5), (6) and (7) equations.

		REARC																																																							
[31] REARC (Relative Ellipse ARC)	PAGE	REARC-1																																																							
<p>< FUNCTION > REARC draws an ellipse ARC.</p> <p>< MNEMONIC > REARC (C, AREA, COL, OPM) a, b, dXc, dYc, dXe, dYe</p>		TYPE	Graphic Command																																																						
<p>< FORMAT ></p> <p>COMMAND CODE hexadecimal notation</p> <table style="width: 100%; border-collapse: collapse;"> <tr> <td style="text-align: right;">15</td> <td style="text-align: center;">9 8 7</td> <td style="text-align: center;">5 4</td> <td style="text-align: center;">3 2</td> <td style="text-align: right;">0</td> <td></td> </tr> <tr> <td style="border: 1px solid black; text-align: center;">1</td> <td style="border: 1px solid black; text-align: center;">0</td> <td style="border: 1px solid black; text-align: center;">1</td> <td style="border: 1px solid black; text-align: center;">1</td> <td style="border: 1px solid black; text-align: center;">0</td> <td style="border: 1px solid black; text-align: center;">C</td> </tr> <tr> <td></td> <td></td> <td style="border: 1px solid black; text-align: center;">AREA</td> <td style="border: 1px solid black; text-align: center;">COL</td> <td style="border: 1px solid black; text-align: center;">OPM</td> <td></td> </tr> </table> <p style="margin-left: 100px;">C = 1 : (\$ B D X X) C = 0 : (\$ B C X X)</p> <p>COMMAND PARAMETERS</p> <table style="width: 100%; border-collapse: collapse;"> <tr> <td style="text-align: right;">15</td> <td style="border: 1px solid black; width: 100%; height: 20px;"></td> <td style="text-align: right;">0</td> </tr> <tr> <td></td> <td style="text-align: center;">a (16 bits)</td> <td></td> </tr> <tr> <td style="text-align: right;">15</td> <td style="border: 1px solid black; width: 100%; height: 20px;"></td> <td style="text-align: right;">0</td> </tr> <tr> <td></td> <td style="text-align: center;">b (16 bits)</td> <td></td> </tr> <tr> <td style="text-align: right;">15</td> <td style="border: 1px solid black; width: 100%; height: 20px;"></td> <td style="text-align: right;">0</td> </tr> <tr> <td></td> <td style="text-align: center;">dXc (16 bits)</td> <td></td> </tr> <tr> <td style="text-align: right;">15</td> <td style="border: 1px solid black; width: 100%; height: 20px;"></td> <td style="text-align: right;">0</td> </tr> <tr> <td></td> <td style="text-align: center;">dYc (16 bits)</td> <td></td> </tr> <tr> <td style="text-align: right;">15</td> <td style="border: 1px solid black; width: 100%; height: 20px;"></td> <td style="text-align: right;">0</td> </tr> <tr> <td></td> <td style="text-align: center;">dXe (16 bits)</td> <td></td> </tr> <tr> <td style="text-align: right;">15</td> <td style="border: 1px solid black; width: 100%; height: 20px;"></td> <td style="text-align: right;">0</td> </tr> <tr> <td></td> <td style="text-align: center;">dYe (16 bits)</td> <td></td> </tr> </table>		15	9 8 7	5 4	3 2	0		1	0	1	1	0	C			AREA	COL	OPM		15		0		a (16 bits)		15		0		b (16 bits)		15		0		dXc (16 bits)		15		0		dYc (16 bits)		15		0		dXe (16 bits)		15		0		dYe (16 bits)		<p>WORD NUMBER Wn=7</p> <p>EXECUTION CYCLES Cn=10d+96</p>	
15	9 8 7	5 4	3 2	0																																																					
1	0	1	1	0	C																																																				
		AREA	COL	OPM																																																					
15		0																																																							
	a (16 bits)																																																								
15		0																																																							
	b (16 bits)																																																								
15		0																																																							
	dXc (16 bits)																																																								
15		0																																																							
	dYc (16 bits)																																																								
15		0																																																							
	dXe (16 bits)																																																								
15		0																																																							
	dYe (16 bits)																																																								
<p>< DESCRIPTION ></p> <p>As shown in Fig. C31-1, the REARC command draws an arc from the current pointer, CP, to Pe (dXe, dYe) of the relative coordinate, the relative coordinates CC (dXc, dYc) being the center point.</p> <p>The X and Y components of the relative coordinates CC and Pe are set in the command parameters in units of pixels.</p>																																																									

The command code bit 8 (C) selects whether an arc is drawn clockwise or counterclockwise. When C is "1", the arc is drawn clockwise, and when C is "0", the arc is drawn counterclockwise as shown in Fig. C31-1.

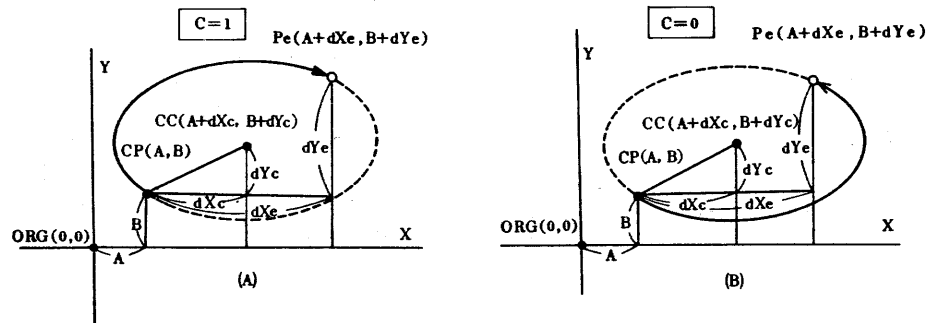


Figure C31-1 Function of REARC

		AFRCT																																											
[32] AFRCT (Absolute Filled Rectangle)		PAGE	AFRCT-1																																										
<p>< FUNCTION ></p> <p>AFRCT command paints the rectangular area specified with CP (Current Pointer) and the command parameter (the absolute coordinates) according to a figure pattern stored in the Pattern RAM.</p> <p>< MNEMONIC ></p> <p>AFRC (AREA, COL, OPM) X, Y</p>		TYPE	Graphic Command																																										
<p>< FORMAT ></p> <p>COMMAND CODE hexadecimal notation</p> <table style="width: 100%; border-collapse: collapse;"> <tr> <td style="text-align: right; width: 10%;">15</td> <td style="width: 10%;"></td> <td style="text-align: right; width: 10%;">87</td> <td style="width: 10%;"></td> <td style="text-align: right; width: 10%;">54</td> <td style="width: 10%;"></td> <td style="text-align: right; width: 10%;">32</td> <td style="width: 10%;"></td> <td style="text-align: right; width: 10%;">0</td> <td style="width: 10%;"></td> </tr> <tr> <td style="border: 1px solid black; text-align: center;">1</td> <td style="border: 1px solid black; text-align: center;">1</td> <td style="border: 1px solid black; text-align: center;">0</td> <td style="border: 1px solid black; text-align: center;">0</td> <td style="border: 1px solid black; text-align: center;">0</td> <td style="border: 1px solid black; text-align: center;">0</td> <td style="border: 1px solid black; text-align: center;">0</td> <td style="border: 1px solid black; text-align: center;">0</td> <td style="border: 1px solid black; text-align: center;">0</td> <td style="border: 1px solid black; text-align: center;">0</td> </tr> <tr> <td colspan="2"></td> <td style="border: 1px solid black; text-align: center;">AREA</td> <td style="border: 1px solid black; text-align: center;">COL</td> <td colspan="2"></td> <td style="border: 1px solid black; text-align: center;">OPM</td> <td colspan="3"></td> </tr> </table> <p style="text-align: right;">(\$ C 0 X X)</p> <p>COMMAND PARAMETERS</p> <table style="width: 100%; border-collapse: collapse;"> <tr> <td style="text-align: right; width: 10%;">15</td> <td style="width: 80%;"></td> <td style="text-align: right; width: 10%;">0</td> </tr> <tr> <td></td> <td style="border: 1px solid black; text-align: center;">X (16 bits)</td> <td></td> </tr> </table> <table style="width: 100%; border-collapse: collapse;"> <tr> <td style="text-align: right; width: 10%;">15</td> <td style="width: 80%;"></td> <td style="text-align: right; width: 10%;">0</td> </tr> <tr> <td></td> <td style="border: 1px solid black; text-align: center;">Y (16 bits)</td> <td></td> </tr> </table>		15		87		54		32		0		1	1	0	0	0	0	0	0	0	0			AREA	COL			OPM				15		0		X (16 bits)		15		0		Y (16 bits)		<p>WORD NUMBER</p> <p style="text-align: center;">Wn=3</p> <p>EXECUTION CYCLES</p> <p style="text-align: center;">Cn=(P·A+8)B+18</p>	
15		87		54		32		0																																					
1	1	0	0	0	0	0	0	0	0																																				
		AREA	COL			OPM																																							
15		0																																											
	X (16 bits)																																												
15		0																																											
	Y (16 bits)																																												
<p>< DESCRIPTION ></p> <p>The Absolute Filled Rectangle Command (AFRCT) paints the rectangle area according to the color information in the pattern RAM. The sizes of the rectangle are parallel to the coordinate axis. Two corner points on the diagonal are CP and Pc (X, Y) at the absolute coordinate point from the origin.</p> <p>Pc (X, Y) expressed in the absolute X-Y coordinates from the origin are given by the command parameter in units of pixels.</p> <div style="text-align: center;"> </div> <p style="text-align: center;">Figure C32-1 Function of AFRCT</p>																																													

Painting in a rectangular area depends on the position of CP and Pc, as shown in Fig. C32-2. In Fig. C32-2, painting between CP and Pc is performed. CP is moved to Pe at the termination of the command. The drawing at the end point Pe is not performed.

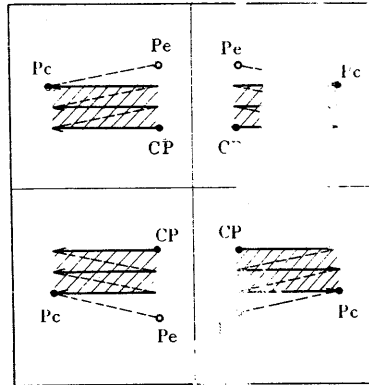


Figure C32-2 Painting Direction of AFRCT

< EXAMPLE >

If the absolute coordinate of CP is (A, B) on the split screen, X is set to X₁ and Y to Y₁ in the command parameter, and the drawing parameter register for the pattern RAM is set to the following, the pattern start point (PSX, PSY), the pattern end point (PEX, PEY), the graphic pattern pointer (PPX, PPY), then, the rectangular area is painted with the AFRCT command as shown next page.

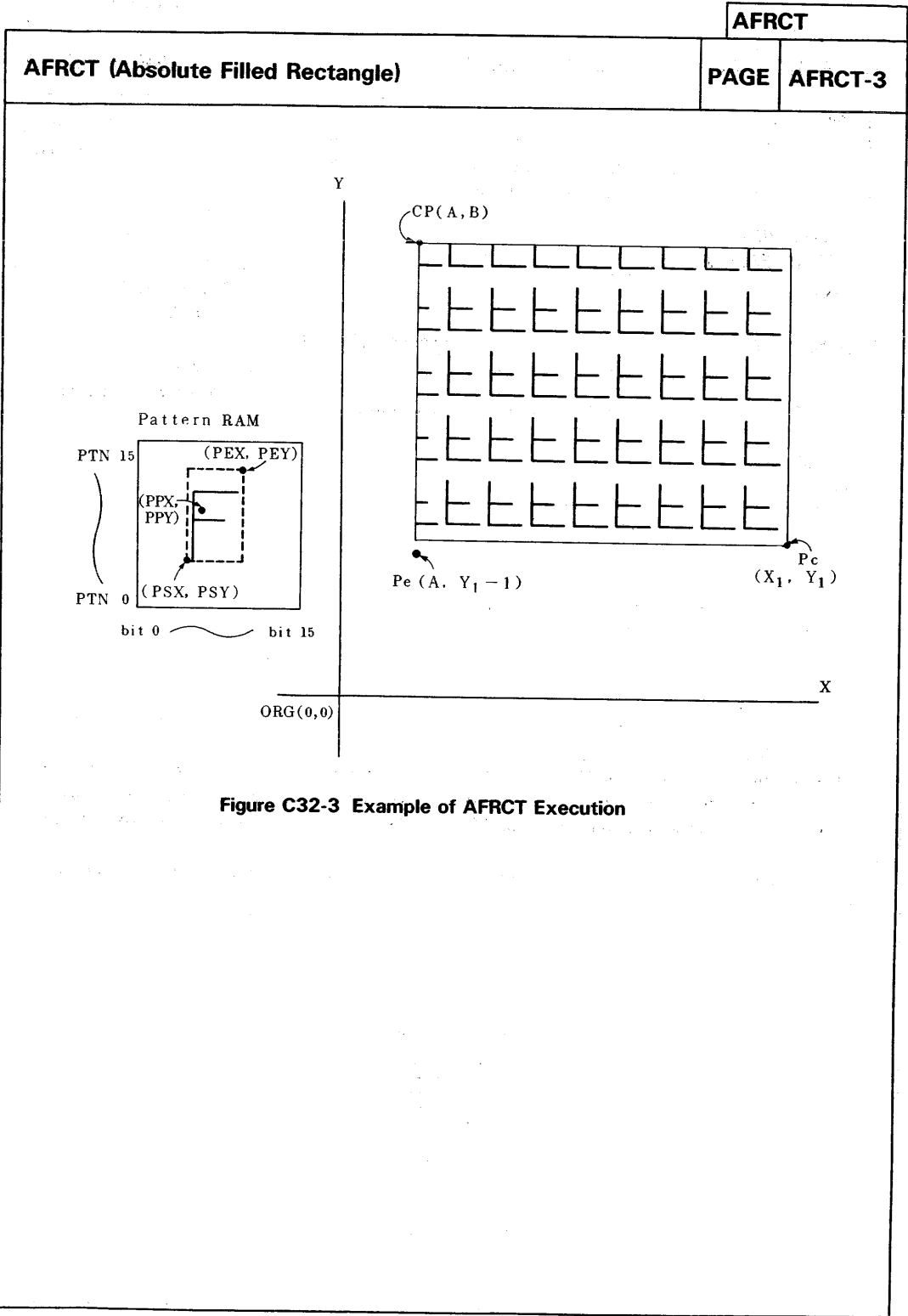
COMMAND CODE

15	0
1 1 0 0	0 0 0 0
AREA	COL OPM
(\$ C O X X)	

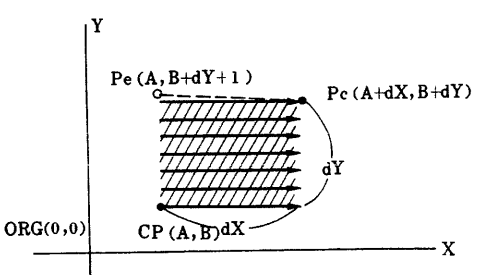
COMMAND PARAMETERS

15	0
X ₁	(\$ X X X X)

15	0
Y ₁	(\$ X X X X)



RFRCT

<p>[33] RFRCT (Relative Filled Rectangle)</p>	<p>PAGE</p>	<p>RFRCT-1</p>																									
<p>< FUNCTION > RFRCT command paints in the rectangular area specified with CP (Current Pointer) and the command parameter (the relative coordinates) according to a figure pattern stored in the Pattern RAM.</p> <p>< MNEMONIC > RFRCT (AREA, COL, OPM) dX, dY</p>	<p>TYPE</p>	<p>Graphic Command</p>																									
<p>< FORMAT ></p> <p>COMMAND CODE hexadecimal notation</p> <table border="1" style="margin-left: 20px;"> <tr> <td style="text-align: center;">15</td> <td style="text-align: center;">87</td> <td style="text-align: center;">54</td> <td style="text-align: center;">32</td> <td style="text-align: center;">0</td> <td></td> </tr> <tr> <td style="text-align: center;">1</td> <td style="text-align: center;">1</td> <td style="text-align: center;">0</td> <td style="text-align: center;">0</td> <td style="text-align: center;">0</td> <td style="text-align: center;">0</td> </tr> <tr> <td></td> <td></td> <td style="text-align: center;">AREA</td> <td style="text-align: center;">COL</td> <td style="text-align: center;">OPM</td> <td style="text-align: center;">(\$ C 4 X X)</td> </tr> </table> <p>COMMAND PARAMETERS</p> <table border="1" style="margin-left: 20px;"> <tr> <td style="text-align: center;">15</td> <td style="text-align: center;">0</td> </tr> <tr> <td colspan="2" style="text-align: center;">dX (16 bits)</td> </tr> </table> <table border="1" style="margin-left: 20px;"> <tr> <td style="text-align: center;">15</td> <td style="text-align: center;">0</td> </tr> <tr> <td colspan="2" style="text-align: center;">dY (16 bits)</td> </tr> </table>	15	87	54	32	0		1	1	0	0	0	0			AREA	COL	OPM	(\$ C 4 X X)	15	0	dX (16 bits)		15	0	dY (16 bits)		<p>WORD NUMBER $W_n = 3$</p> <p>EXECUTION CYCLES $C_n = (P \cdot A + 8)B + 18$</p>
15	87	54	32	0																							
1	1	0	0	0	0																						
		AREA	COL	OPM	(\$ C 4 X X)																						
15	0																										
dX (16 bits)																											
15	0																										
dY (16 bits)																											
<p>< DESCRIPTION ></p> <p>The Relative Filled Rectangle Command (RFRCT) paints the rectangular area according to the color information in the pattern RAM. The sizes of the rectangle are parallel to the coordinates axis. Two corner points on the diagonal are CP and Pe (A+dX, B+dY) at the relative coordinate point from CP.</p> <p>Pe (dX, dY) expressed in the relative coordinate from CP is given by the command parameter in units of pixels.</p> <div style="text-align: center;">  </div> <p>Figure C33-1 Function of RFRCT</p>																											

RFRCT (Relative Filled Rectangle)

PAGE

RFRCT-2

Painting in a rectangular area depends on the position of CP and Pe, as shown in Fig. C33-2. In Fig. C33-2, painting between CP and Pe is performed. CP is moved to Pe at the termination of the command. The drawing at the end point Pe is not performed.

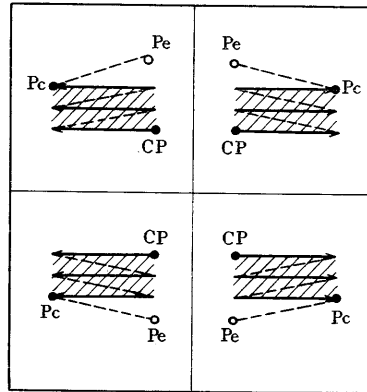


Figure C33-2 Painting Direction of RFRCT

< EXAMPLE >

If the absolute coordinate of CP is (A, B) on the split screen, dX is set to dX_1 and dY to dY_1 in the command parameter, and the drawing parameter register for the pattern RAM is set to the following, the pattern start point (PSX, PSY), the pattern end point (PEX, PEY), the graphic pattern pointer (PPX, PPY), then, the rectangular area is painted with the RFRCT command, as shown in Fig. C33-3.

COMMAND CODE

15	0
1 1 0 0 0 1 0 0 AREA COL OPM	(\$ C 4 X X)

COMMAND PARAMETERS

15	0
dX_1	(\$ X X X X)

15	0
dY_1	(\$ X X X X)

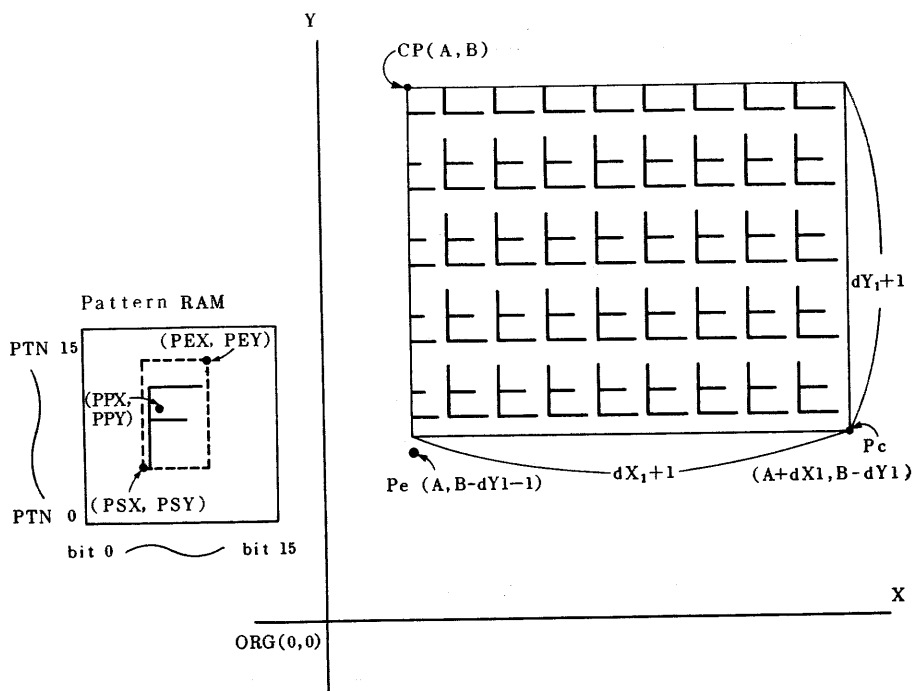
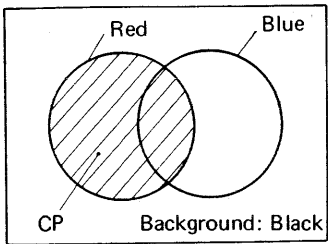


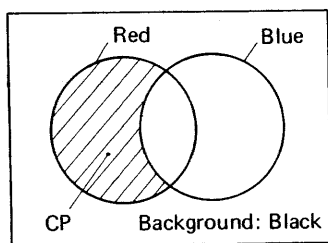
Figure C33-3 Example of RFRCT Execution

PAINT													
[34] PAINT (Paint)	PAGE	PAINT-1											
<p>< FUNCTION > PAINT command paints the closed area surrounded by edge color using the figure pattern stored in the pattern RAM.</p> <p>< MNEMONIC > PAINT (AREA, COL, OPM)</p>	TYPE	Graphic Command											
<p>< FORMAT ></p> <p>COMMAND CODE hexadecimal notation</p> <table style="margin-left: 20px;"> <tr> <td style="text-align: center;">15</td> <td style="text-align: center;">9 8 7</td> <td style="text-align: center;">5 4</td> <td style="text-align: center;">3 2</td> <td style="text-align: center;">0</td> <td></td> </tr> <tr> <td style="text-align: center;">1</td> <td style="text-align: center;">1</td> <td style="text-align: center;">0</td> <td style="text-align: center;">0</td> <td style="text-align: center;">E</td> <td style="text-align: center;">AREA COL OPM</td> </tr> </table> <p style="margin-left: 20px;">(\$ C X X X)</p> <p>COMMAND PARAMETERS - NON -</p>	15	9 8 7	5 4	3 2	0		1	1	0	0	E	AREA COL OPM	<p>WORD NUMBER $W_n = 1$</p> <p>Command execution cycle number</p> <p>$C_n = (18 \cdot A + 102)B - 58$</p> <p>(When painting rectangle)</p>
15	9 8 7	5 4	3 2	0									
1	1	0	0	E	AREA COL OPM								
<p>< DESCRIPTION ></p> <p>The "Paint" command (PAINT) paints the closed area surrounded by edge color defined in the parameter register (EDG: edge color), using the figure pattern stored in the pattern RAM. If the CP is inside the closed area, the paint operation is performed only inside the closed area. If the CP is outside, the paint operation is performed outside the closed area. Color code stored in color registers (CLO or CL1) are also considered to be an edge during PAINT execution. (See < Complex Figure Painting >.) When an unpaintable area is detected during this command, the coordinates are put in the Read FIFO and painting is continued. Therefore, a complex figure can be completely painted by re-issuing PAINT commands using the coordinate data put in the Read FIFO.</p> <p>< Definition of Edge Color ></p> <p>E = 0 : The edge color is defined by the data in the EDG register. (See figure next page)</p> <p>E = 1 : The edge color is defined to be all colors except for the color in the EDG register. (See figure next page)</p>													



E = 0 : "red" is set to the EDG register.
PAINT is executed at E=0.

Figure C34-1 Paint Function (E=0)



E = 1 : "black" is set to the EDG register.
PAINT is executed at E=1.

Figure C34-2 Paint Function (E=1)

< Paint Using a Pattern >

The PAINT command paints using a pattern stored in the pattern RAM. As the scan point in the pattern RAM moves corresponding to the movement of the drawing point, the figure is repeatedly drawn.

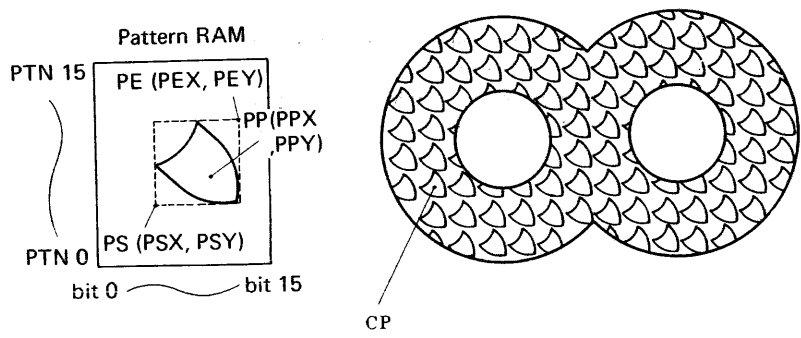


Figure C34-3 Paint Function Using Figure Pattern

< Paint Procedure >

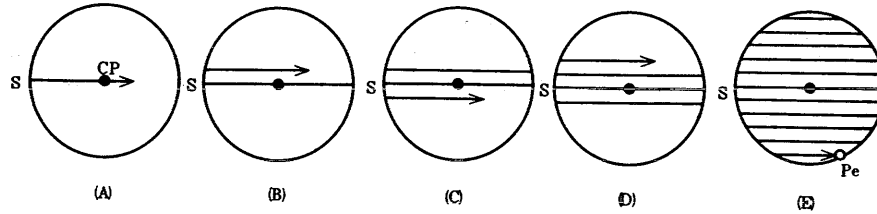


Figure C34-4 Paint Procedure

Painting is continuously performed parallel to the X axis (left to right), and in the Y direction, dot by dot. Fig. C34-2 shows an example of painting the encircled area. First, painting begins from points S on a line which is parallel to the X axis from CP. Next, painting is executed on the adjacent line which is above or below the first line. This drawing is repeated and painting proceeds. In this way, the whole encircled area is painted. The current pointer, CP, moves to the end point Pe at the finish.

< Complex Figure Painting >

The PAINT command checks the outlined area for any un-painted areas during painting. If there are any during painting, the coordinates of the areas are pushed into the internal stack. Figure below shows a case of four coordinates being pushed into the stack.

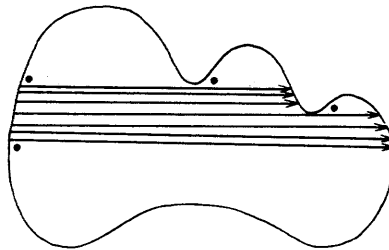
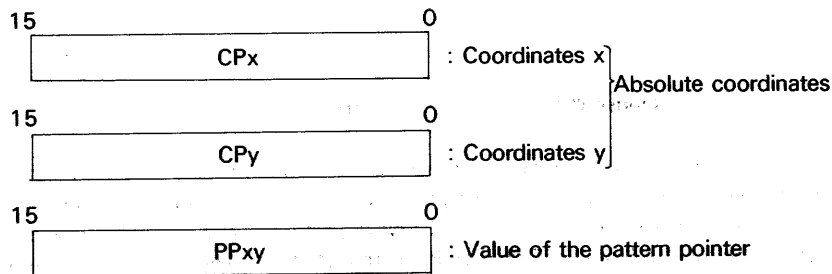


Figure C34-5 Paint Stack Function

PAIN (Paint)

The ACRTC can store four such coordinates. If the points are within four, one PAIN command can completely paint a complex figure.

If the points are five or more all coordinates cannot be pushed into the stack. The un-stacked coordinates are put in the Read FIFO to be read out by the MPU. the MPU reads out the coordinates and issues another PAIN command to paint the un-painted areas using these coordinates after the initial PAIN command is finished. The coordinate for one point put in the Read FIFO consists of the following 3 words.



If the Read FIFO is full, the command execution remains halted until the MPU reads out the coordinates. When the Read FIFO has data before "PAIN" is instructed, only two or less coordinates can be pushed into the stack. Therefore, it is recommended that the read FIFO be empty before instructing A "PAIN" command.

The following two cases are the state of termination of the command.

- ① Data is not written in the Read FIFO
(The outlined area is completely painted.)
- ② Data is written in the read FIFO
(An un-paintable area exists.)

In the case of ② any un-painted area should be painted by issuing the PAIN command again.

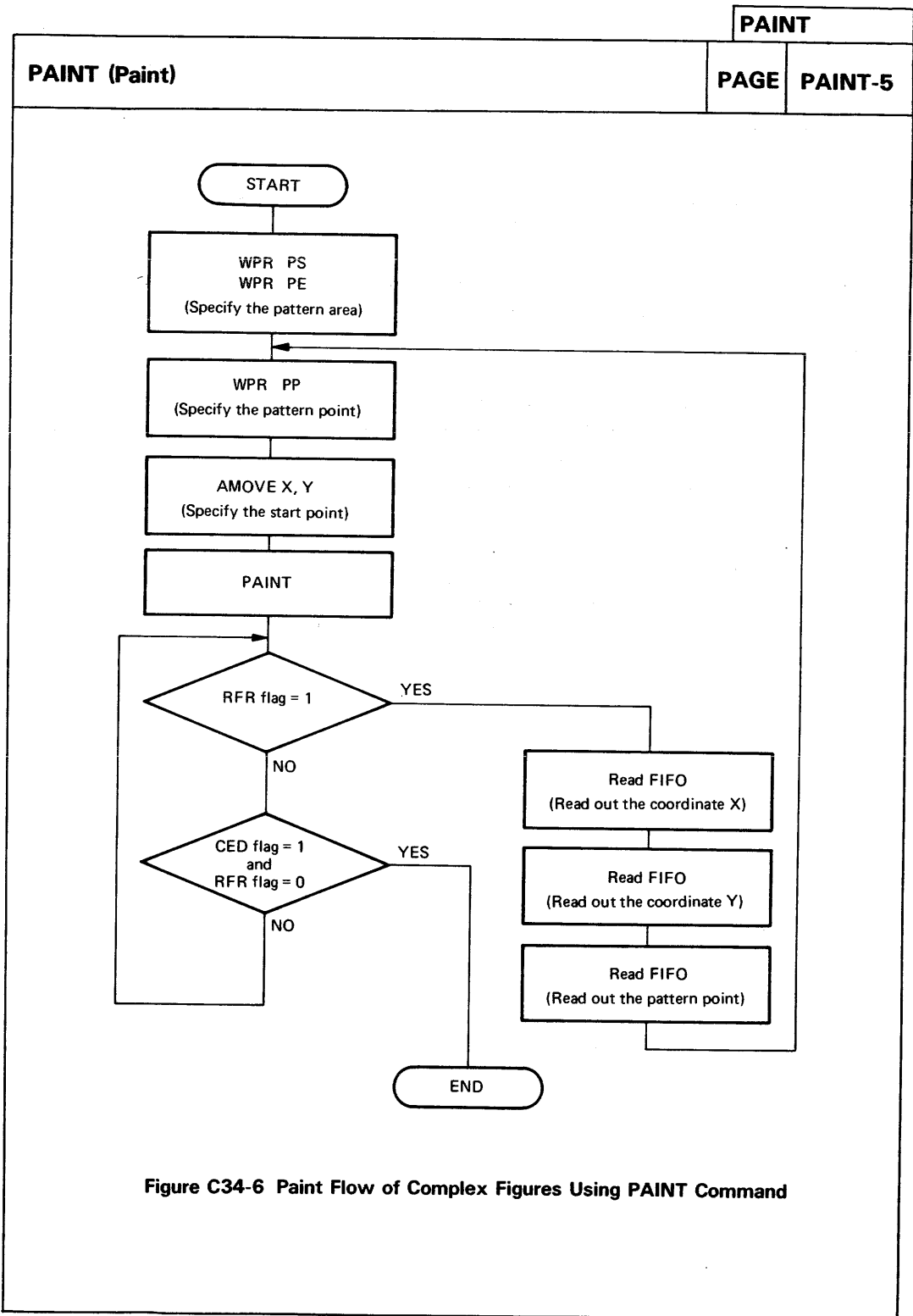


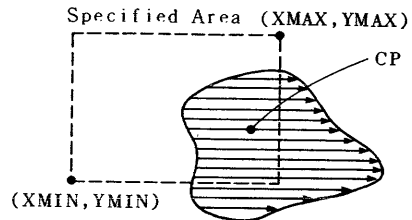
Figure C34-6 Paint Flow of Complex Figures Using PAINT Command

< PAINT Area Detection Mode >

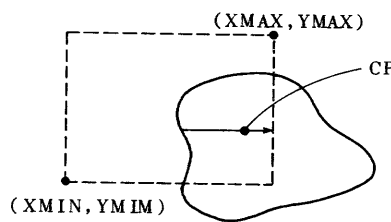
PAINT Area Detection modes have each of the following functions.

AREA	PAINT Command Execution
000	Not check the specified area.
001	AREA flag is set and the command execution is truncated, if CP moves outside the specified area during painting.
010	Paint only inside the specified area. AREA flag is not set.
011	Paint only inside the specified area. If CP meets the edge of the specified area, AREA flag is set.
100	Not check the specified area.
101	AREA flag is set and the command execution is truncated, if CP moves inside the specified area.
110	Paint only outside the specified area. AREA flag is not set.
111	Paint only outside the specified area. If CP meets the edge of the specified area, AREA flag is set.

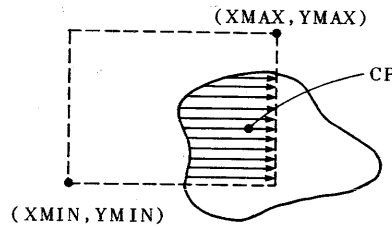
- (i) AREA = 0 0 0
AREA = 1 0 0



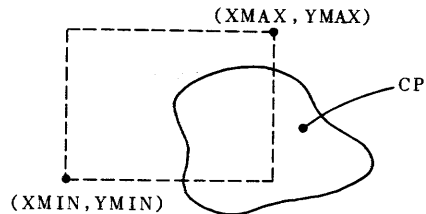
- (ii) AREA = 0 0 1
(AREA flag is set.)



- (iii) AREA = 0 1 0
(AREA flag is not changed.)
AREA = 0 1 1
(AREA flag is set.)



- (iv) AREA = 1 0 1
(AREA flag is set.)



- (v) AREA = 1 1 0
(AREA flag is not changed.)
AREA = 1 1 1
(AREA flag is set.)

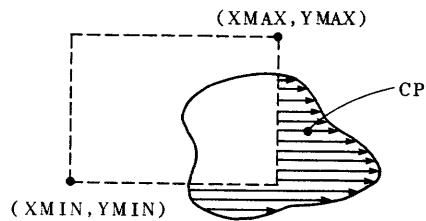


Figure C34-6A Paint Command Example with AREA Modes

< EXECUTION EXAMPLE > (In the case of E = "0")

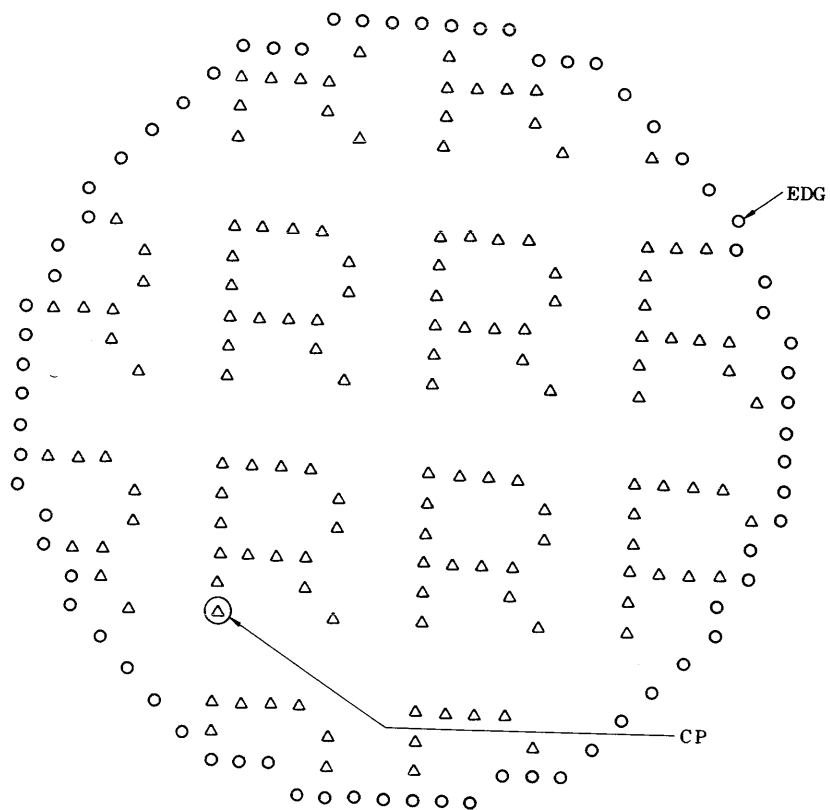


Figure C34-8 Example of PAINT Execution (E = "0")

<EXAMPLE> (In the case of E = "1")

If a circle of the same color as specified in the edge color parameter register (EDG) is drawn on the split screen and the inside of the circle is also painted in the same color and the surround of the circle is not the same color as the edge, Fig. C34-10 (A), and the pattern shown in Fig. C34-9 is in the pattern RAM, the pattern pointer (PP) is in the position shown in Fig. C34-9. Then the PAINT command with bit 8 = "1", CP in the position shown in Fig. C34-10 (A) is executed as shown in Fig. C34-10 (B).

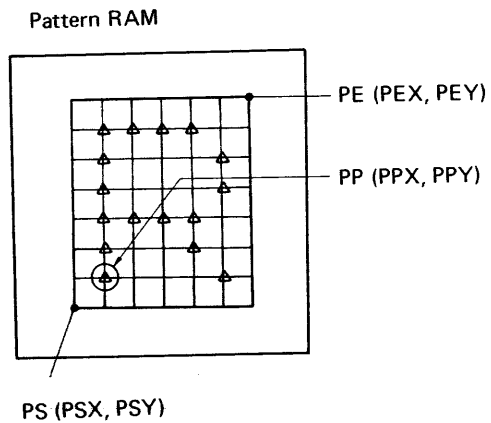


Figure C34-9 Setting of Pattern RAM

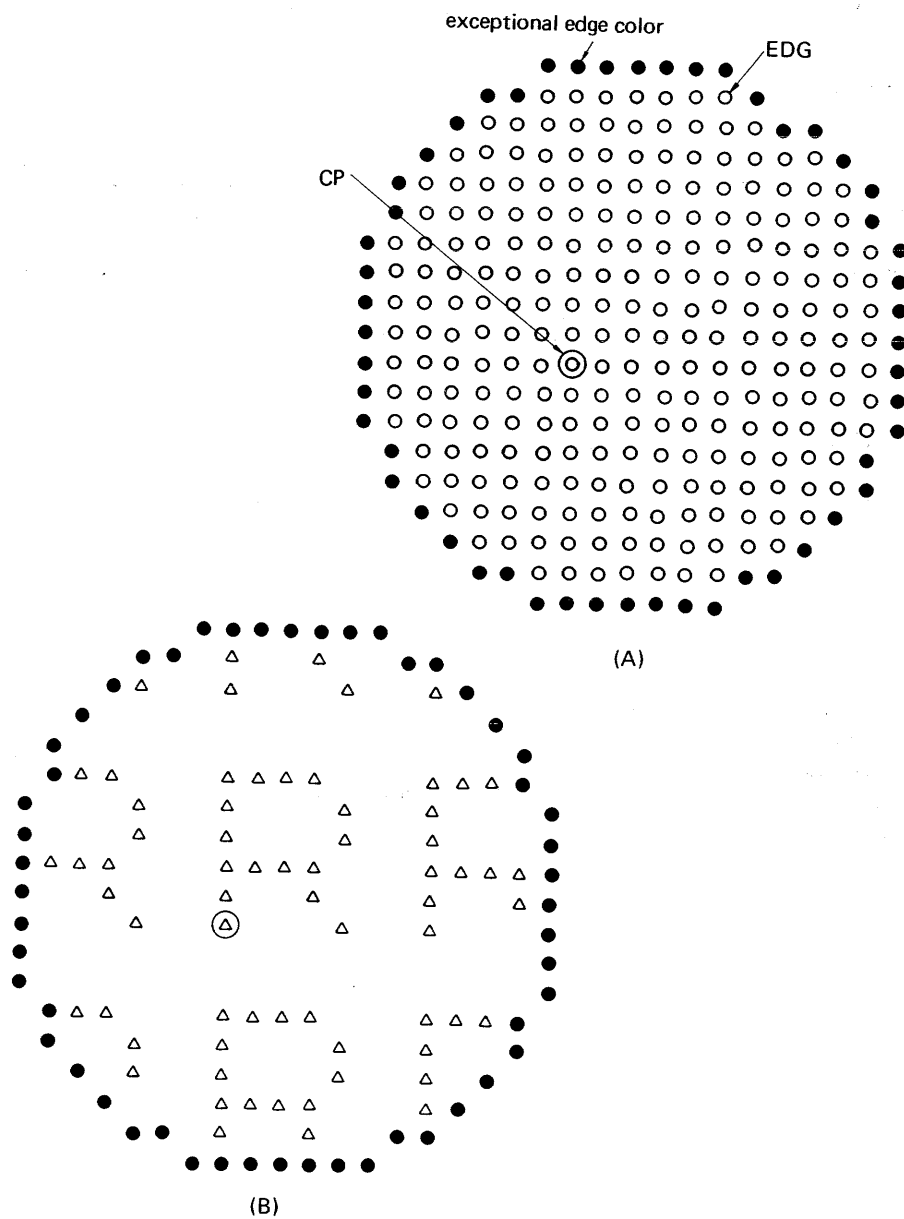


Figure C34-10 Example of PAINT Execution (E = "1")

DOT																			
[35] DOT (Dot Command)	PAGE DOT-1																		
<p>< FUNCTION > DOT Command marks a dot on the coordinates where the CP points.</p> <p>< MNEMONIC > DOT (AREA, COL, OPM)</p>	<p>TYPE</p> <p>Graphic Command</p>																		
<p>< FORMAT ></p> <p>COMMAND CODE</p> <table style="margin-left: 40px;"> <tr> <td style="text-align: right;">15</td> <td style="width: 40px;"></td> <td style="text-align: right;">87</td> <td style="width: 40px;"></td> <td style="text-align: right;">54</td> <td style="width: 40px;"></td> <td style="text-align: right;">32</td> <td style="width: 40px;"></td> <td style="text-align: right;">0</td> </tr> <tr> <td style="border: 1px solid black; text-align: center;">1</td> <td style="border: 1px solid black; text-align: center;">1</td> <td style="border: 1px solid black; text-align: center;">0</td> <td style="border: 1px solid black; text-align: center;">0</td> <td style="border: 1px solid black; text-align: center;">AREA</td> <td style="border: 1px solid black; text-align: center;">COL</td> <td style="border: 1px solid black; text-align: center;">OPM</td> <td colspan="2"></td> </tr> </table> <p style="margin-left: 100px;">hexadecimal notation (\$ C C X X)</p> <p>COMMAND PARAMETERS - NON -</p>	15		87		54		32		0	1	1	0	0	AREA	COL	OPM			<p>WORD NUMBER $W_n = 1$</p> <p>EXECUTION CYCLES $C_n = 8$</p>
15		87		54		32		0											
1	1	0	0	AREA	COL	OPM													
<p>< DESCRIPTION > The Dot Command (DOT) marks a dot on the coordinate where the Current Pointer (CP) indicates. After dot drawing, the CP doesn't move. So, Pe, the dotting-finishing point, is the same point as the CP.</p> <div style="text-align: center; margin: 20px 0;"> </div>																			

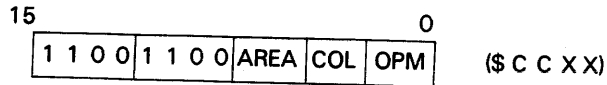
Figure C35-1 Function of DOT

DOT (Dot Command)

< EXAMPLE >

In the case of the absolute coordinate of the CP is (10, 8) on the split screen, the DOT Command marks a dot as shown in Fig. C35-2.

COMMAND CODE



COMMAND PARAMETERS

- NON -

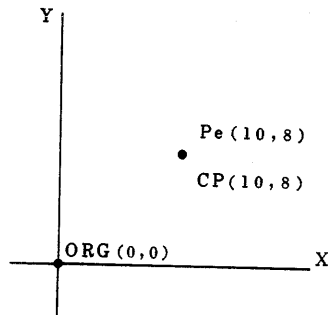
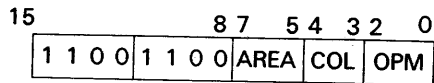


figure C35-2 Example of DOT Execution

The LINE Commands and ARC Commands do not draw a dot at the finishing points, Pe. The DOT Command can be used to draw a dot at the Pe to draw a complete line or arc.

COMMAND CODE



EXAMPLE

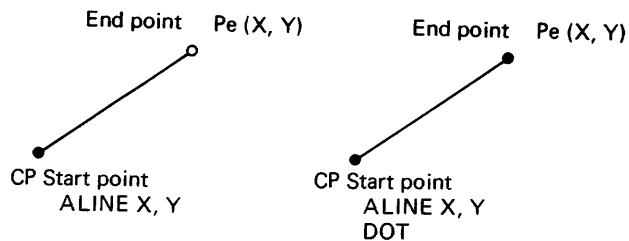


Figure C35-3 DOT Command for the End Point

		PTN													
[36] PTN (Pattern)	PAGE	PTN-1													
<p>< FUNCTION > The graphic pattern defined in the pattern RAM is drawn onto the rectangular area specified by the current pointer and by the pattern size.</p> <p>< MNEMONIC > PTN (SL, SD, AREA, COL, OPM) S</p>		TYPE	Graphic Command												
<p>< FORMAT ></p> <p>COMMAND CODE hexadecimal notation</p> <p>15 12 11 10 8 7 5 4 3 2 0</p> <table border="1" style="margin-left: 20px;"> <tr> <td style="width: 20px;">1</td> <td style="width: 20px;">1</td> <td style="width: 20px;">0</td> <td style="width: 20px;">1</td> <td style="width: 20px;">SL</td> <td style="width: 20px;">SD</td> <td style="width: 20px;">AREA</td> <td style="width: 20px;">COL</td> <td style="width: 20px;">OPM</td> </tr> </table> <p style="margin-left: 100px;">(\$ D X X X)</p> <p>COMMAND PARAMETERS</p> <p>15 8 7 0</p> <table border="1" style="margin-left: 20px;"> <tr> <td style="width: 20px;">SZ</td> <td style="width: 20px;">SZy</td> <td style="width: 20px;">SZx</td> </tr> </table> <p style="margin-left: 100px;">SZx, SZy Setting: 0~255 Meaning: 1~256 in units of pixels</p>		1	1	0	1	SL	SD	AREA	COL	OPM	SZ	SZy	SZx	<p>WORD NUMBER Wn=2</p> <p>EXECUTION CYCLES Cn=(P-A+10)·B+20</p>	
1	1	0	1	SL	SD	AREA	COL	OPM							
SZ	SZy	SZx													
<p>< DESCRIPTION ></p> <p>As shown in Fig. C36-1, the Pattern command (PTN) is used to draw the graphic pattern defined in the pattern RAM onto the rectangular area specified by the current pointer (CP) and by the parameter (SZ: SZy, SZx). The pattern to be taken out of the pattern RAM is set by the pattern start point (PS) and pattern end point (PE).</p> <p>The point at which to start pattern RAM scan to obtain color information is set by the pattern pointer (PP). The color information is set on color registers "0" and "1" for execution of pattern drawing.</p> <p>Parameter SZ is divided into X component (SZx) and Y component (SZy), each component being set in units of pixels.</p> <p>The PTN command has the CP scan direction set up in units of 45° in the operation code, together with the choice of 45° slanted pattern drawing. After pattern drawing, the CP is moved to the Pe (see Table C36-1).</p>															

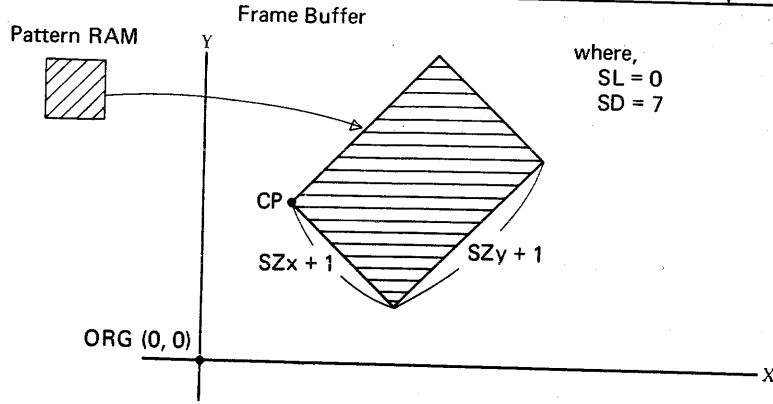


Figure C36-1 Function of PTN

Table C36-1 Directions of CP Scan

SL \ SD	000	001	010	011
0				
0				
1				
1				

• : CP ○ : Pe

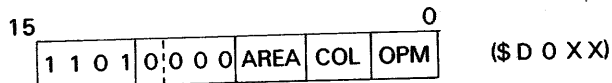
PTN (Pattern)

< Example of Command Execution >

From the pattern RAM, take out a pattern using the PS (PSX, PSY) and PE (PEX, PEY), and execute the PTN command.

(1) Where PP=PS, PZ=0, SZ=PE-PS, SL=0, SD=0

COMMAND CODE



COMMAND PARAMETERS

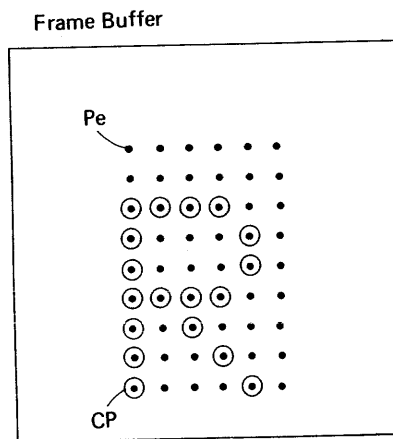
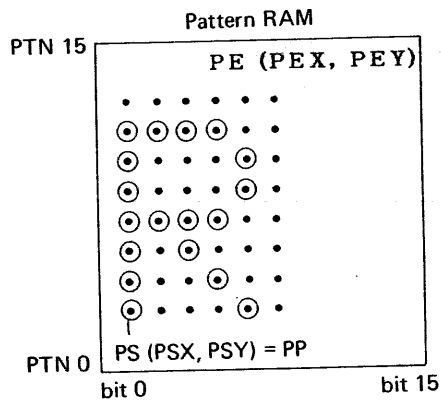
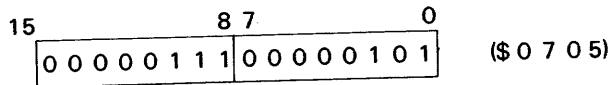


Figure C36-2 Example of PTN Execution (1)

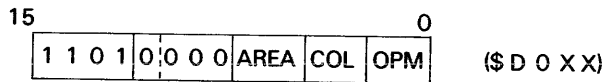
PTN (Pattern)

PAGE

PTN-4

(2) Where $PP \neq PS$, $PZ=0$, $SZ=PE-PS$, $SL=0$, $SD=0$

COMMAND CODE



COMMAND PARAMETERS

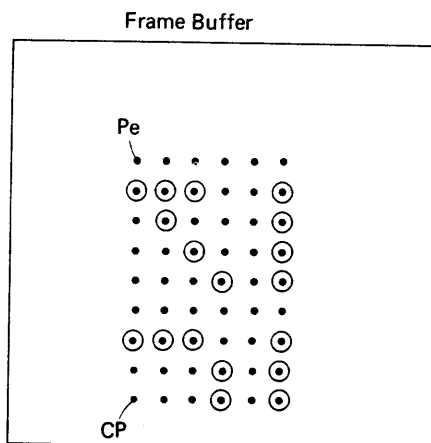
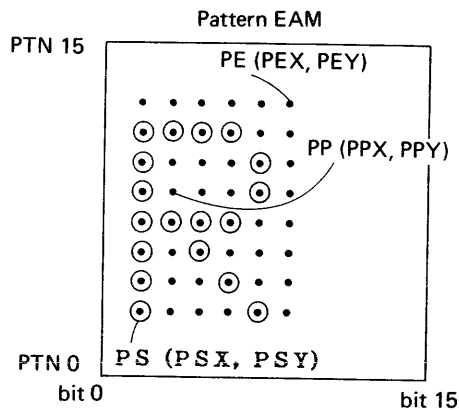
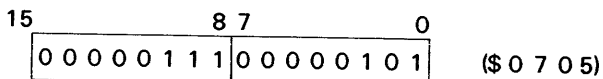
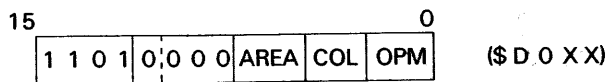


Figure 36-3 Example of PTN Execution (2)

PTN (Pattern)

(3) Where PP=PS, PZ=0, SZ < PE-PS, SL=0, SD=0

COMMAND CODE



COMMAND PARAMETERS

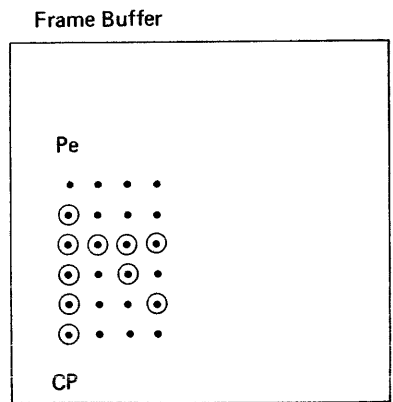
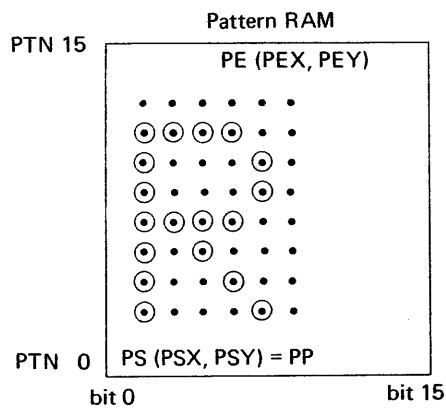
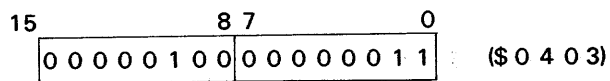
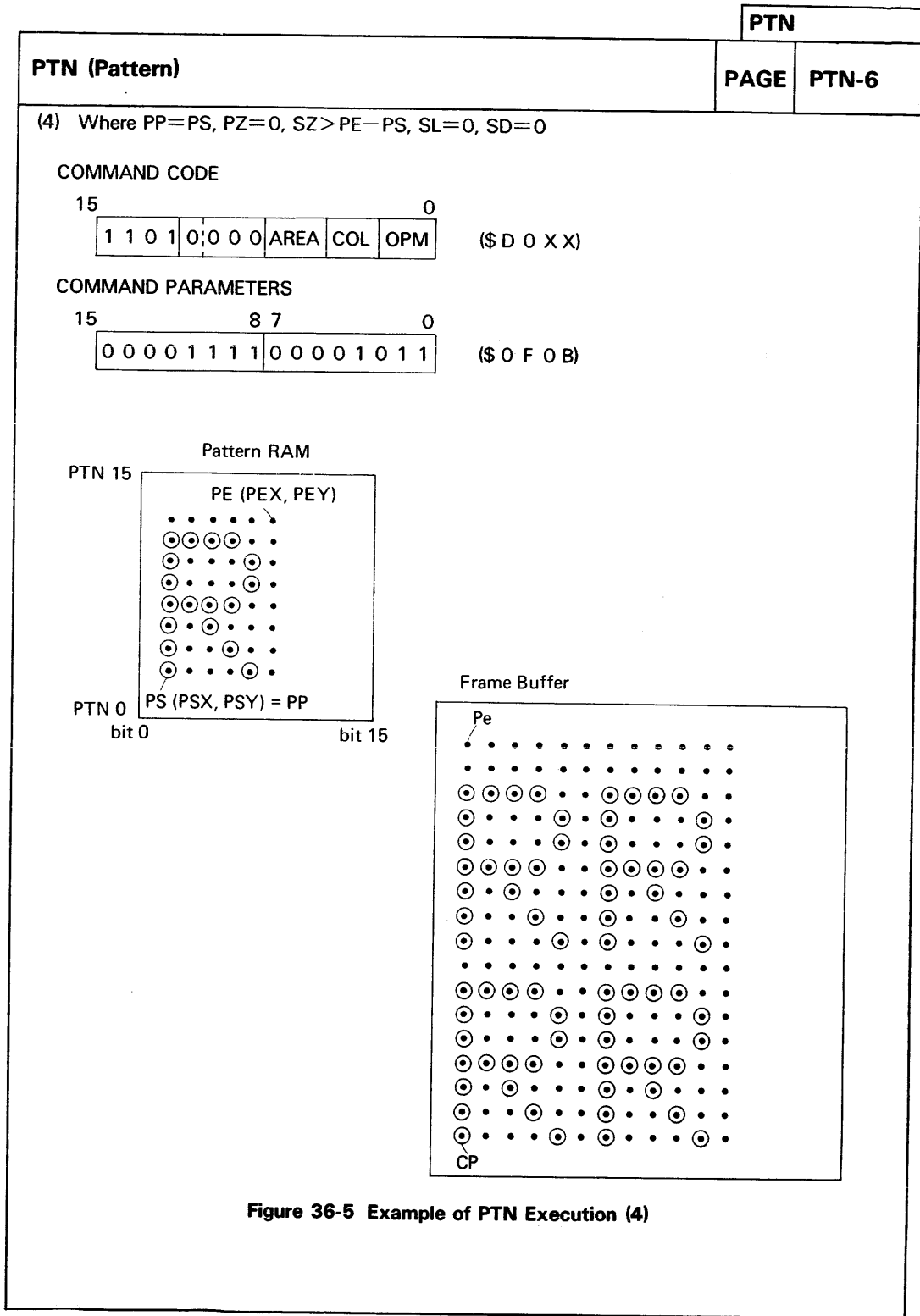


Figure 36-4 Example of PTN Execution (3)



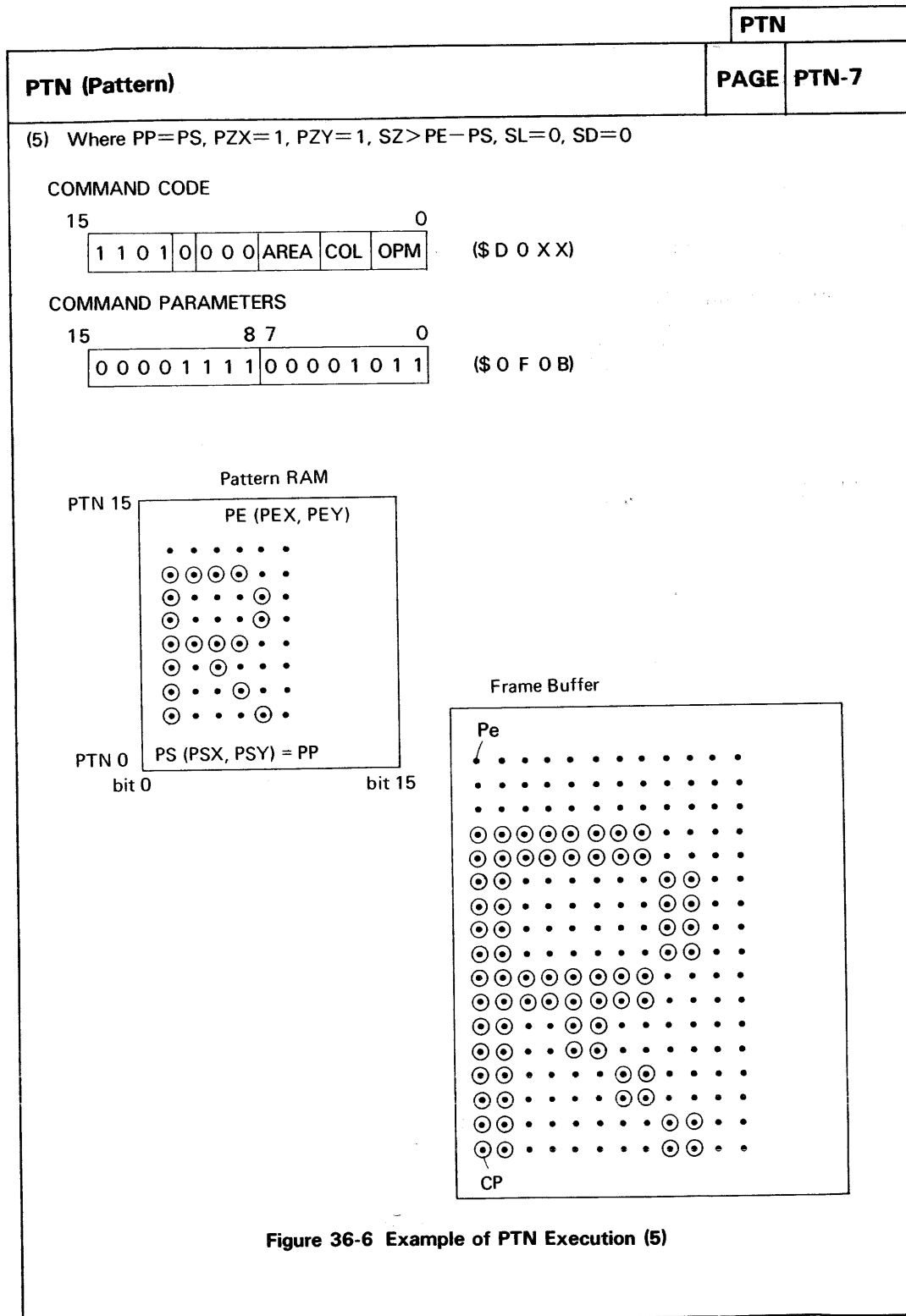
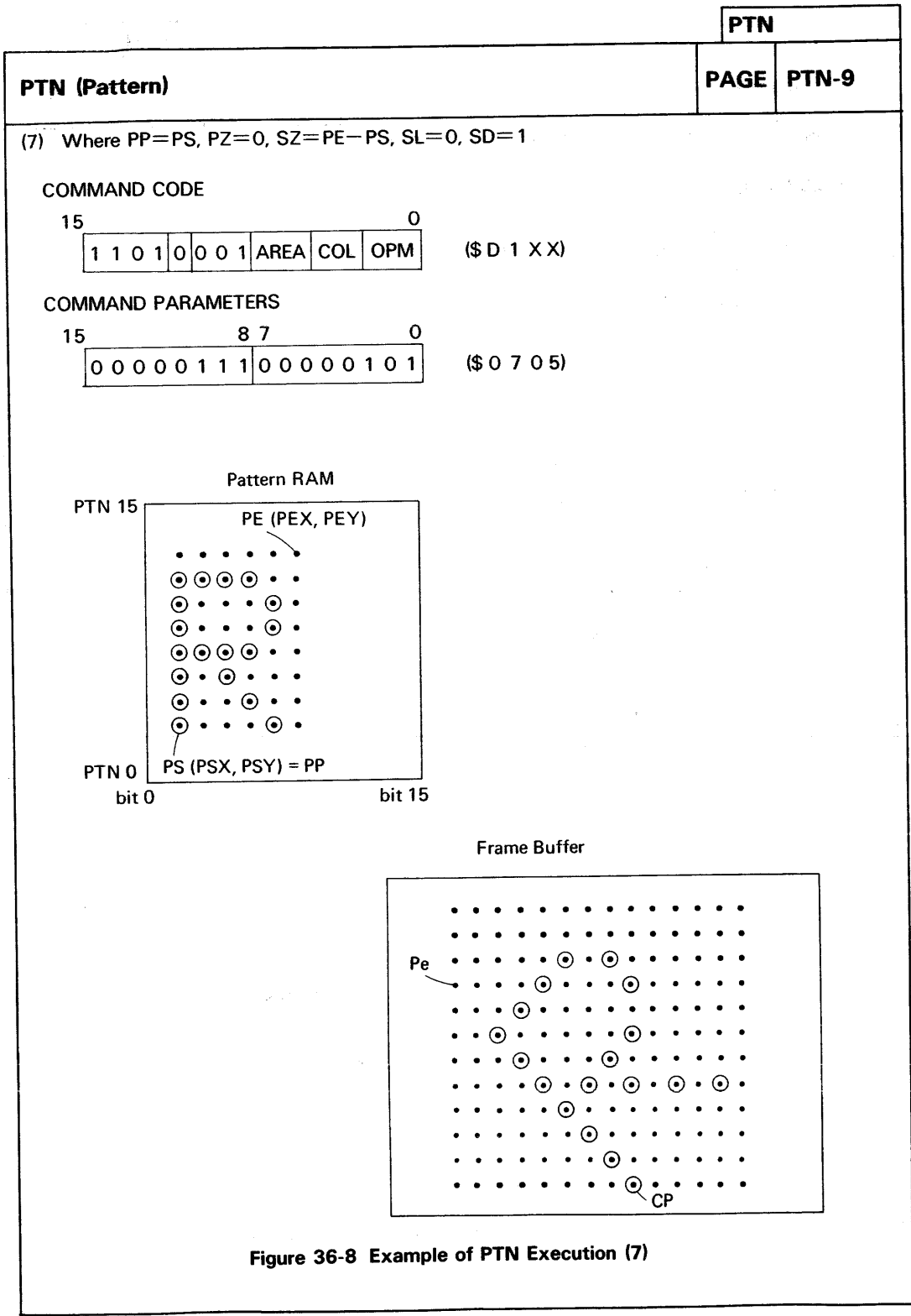


Figure 36-6 Example of PTN Execution (5)



		AGCPY																											
[37] AGCPY (Absolute Graphic Copy)		PAGE	AGCPY-1																										
<p>< FUNCTION > AGCPY command copies a rectangular area specified by the absolute coordinates to the address specified by CP (Current Pointer)</p> <p>< MNEMONIC > AGCPY (S, DSD, AREA, COL, OPM) Xs, Ys, DX, DY</p>		TYPE	Graphic Command																										
<p>< FORMAT ></p> <p>COMMAND CODE</p> <table style="margin-left: 40px;"> <tr> <td style="text-align: right;">15</td> <td style="text-align: center;">12 11 10</td> <td style="text-align: center;">8 7</td> <td style="text-align: center;">5 4</td> <td style="text-align: center;">3 2</td> <td style="text-align: center;">0</td> <td style="text-align: right;">hexadecimal notation</td> </tr> <tr> <td></td> <td style="border: 1px solid black; padding: 2px;">1 1 1 0</td> <td style="border: 1px solid black; padding: 2px;">S D S D</td> <td style="border: 1px solid black; padding: 2px;">AREA</td> <td style="border: 1px solid black; padding: 2px;">0 0</td> <td style="border: 1px solid black; padding: 2px;">OPM</td> <td style="text-align: center;">(\$ E X X X)</td> </tr> </table> <p>COMMAND PARAMETERS</p> <table style="margin-left: 40px;"> <tr> <td style="text-align: right;">15</td> <td style="border: 1px solid black; width: 150px; height: 20px; text-align: center;">Xs</td> <td style="text-align: right;">0</td> </tr> <tr> <td style="text-align: right;">15</td> <td style="border: 1px solid black; width: 150px; height: 20px; text-align: center;">Ys</td> <td style="text-align: right;">0</td> </tr> <tr> <td style="text-align: right;">15</td> <td style="border: 1px solid black; width: 150px; height: 20px; text-align: center;">DX</td> <td style="text-align: right;">0</td> </tr> <tr> <td style="text-align: right;">15</td> <td style="border: 1px solid black; width: 150px; height: 20px; text-align: center;">DY</td> <td style="text-align: right;">0</td> </tr> </table>		15	12 11 10	8 7	5 4	3 2	0	hexadecimal notation		1 1 1 0	S D S D	AREA	0 0	OPM	(\$ E X X X)	15	Xs	0	15	Ys	0	15	DX	0	15	DY	0	<p>WORD NUMBER Wn=5</p> <p>EXECUTION CYCLES Cn= (P+2)A+10)B+70</p>	
15	12 11 10	8 7	5 4	3 2	0	hexadecimal notation																							
	1 1 1 0	S D S D	AREA	0 0	OPM	(\$ E X X X)																							
15	Xs	0																											
15	Ys	0																											
15	DX	0																											
15	DY	0																											
<p>< DESCRIPTION ></p> <p>The Absolute Graphic Copy Command (AGCPY) copies data from an rectangular area in the frame buffer (the source area) to another location in the frame buffer (the destination area) with the initial starting point CP. The size of the source rectangular area is parallel to the coordinate axis. Two diagonal corner points are Pss (Xs, Ys) at the absolute coordinate point from the origin and Pse (Xs+DX, Ys+DY) at the relative coordinate point from Pss.</p> <p>Pss (Xs, Ys) expressed by absolute X-Y coordinates from the origin are set in the command parameter in units of pixels.</p> <p>Pse (DX, DY) expressed by relative X-Y coordinates from Pss are set in the command parameter in units of pixels.</p>																													

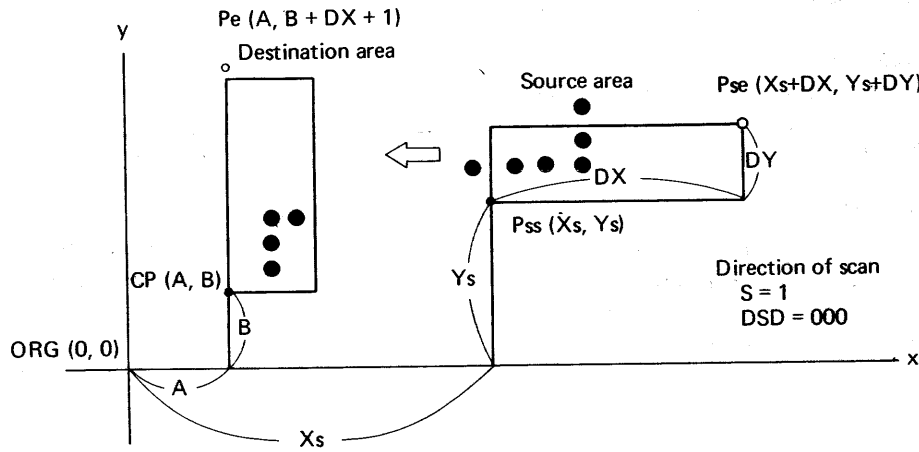


Figure C37-1 Function of AGCPY

< DIRECTION OF POINTER SCAN >

The direction of pointer scan is determined by S bit and DSD bit in the command code through the AGCPY command.

(a) S (Source Scan Direction)

COMMAND CODE

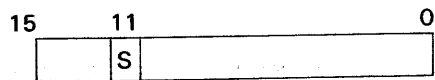
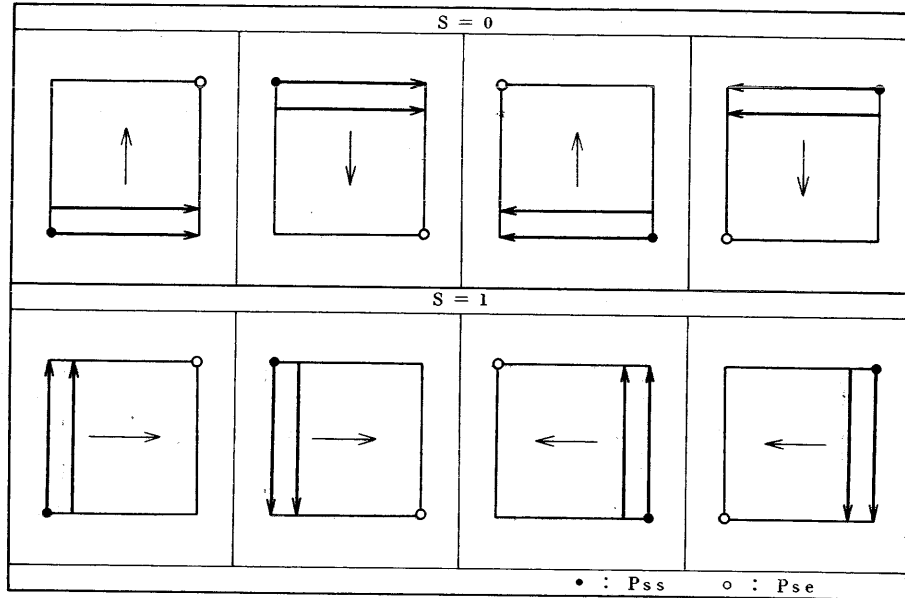


Table C37-1 Direction of Source Data Scan



The direction of scan on the frame buffer in the source area is determined with bit 11 in the command code and the position of Pss and Pse, as shown in Table C37-1.

(b) DSD (Destination Scan Direction)

COMMAND CODE

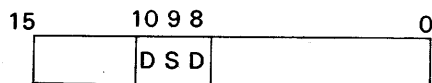


Table C37-2 Direction of Destination Data Scan

DSD=000	DSD=001	DSD=010	DSD=011
DSD=100	DSD=101	DSD=110	DSD=111
• : CP ○ : Pe			

As shown Table C37-2, the direction of scan on the frame buffer in the destination area is determined with bits 10 through 8 in the command code and position of CP and Pe.

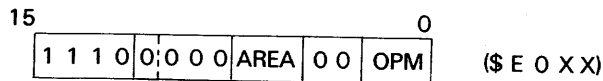
After termination of the command, Pe, the end point of CP, is moved to the point shown in Table C37-2.

< EXAMPLE >

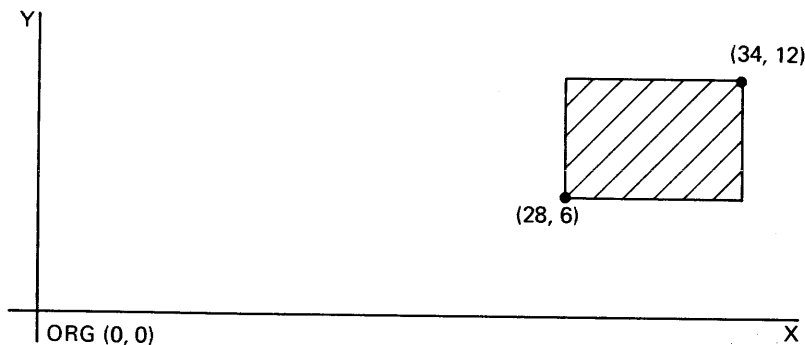
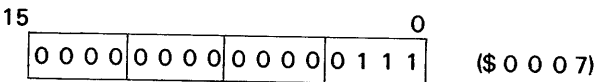
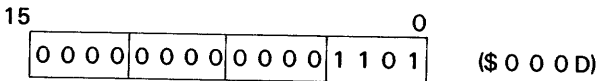
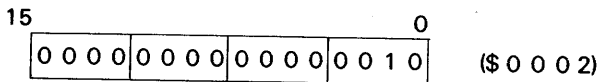
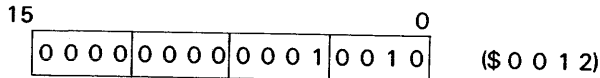
If the absolute coordinates of CP is (4, 2) on the split screen, Xs is set to 18, Ys is set to 2, DX is set to 13 and DY is set to 7 in the command parameter. Then, the drawing is copied by the AGCPY command (S = 1, DSD = 000), as shown in Fig. C37-2 (B).

AGCPY (Absolute Graphic Copy)

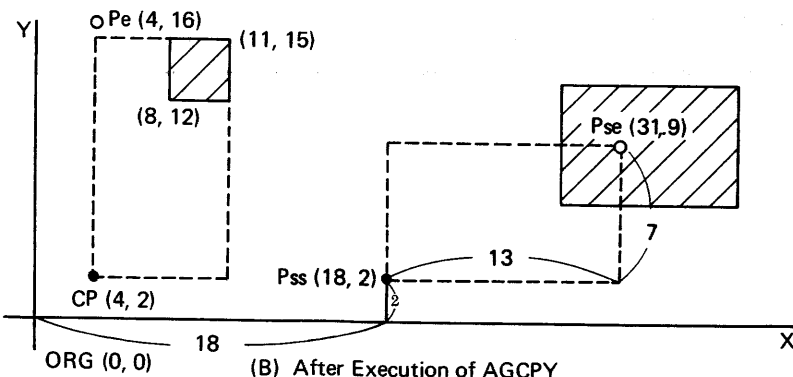
COMMAND CODE



COMMAND PARAMETERS



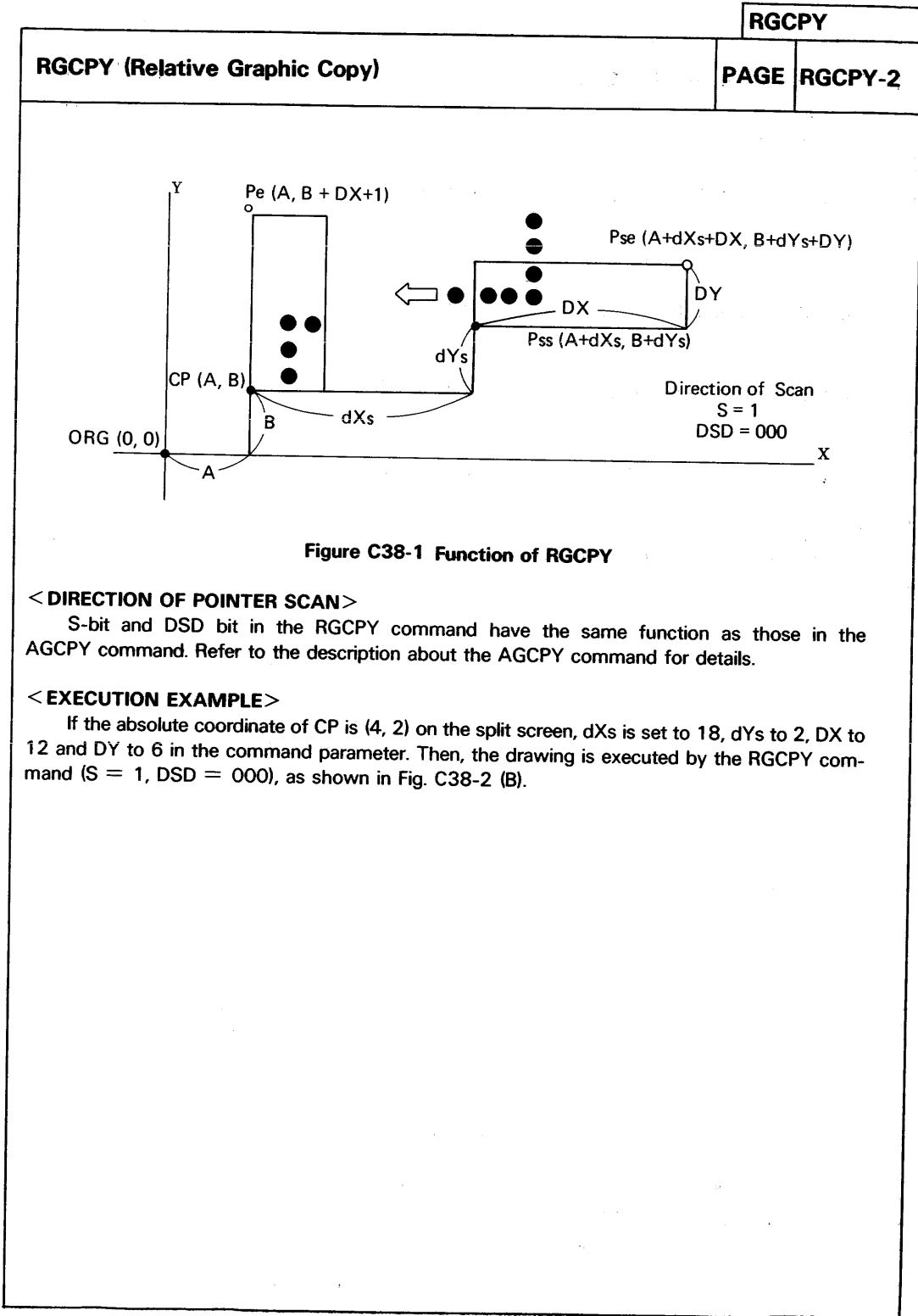
(A) Before Execution of AGCPY



(B) After Execution of AGCPY

Figure C37-2 Example of AGCPY Execution

		RGCPY																																			
[38] RGCPY (Relative Graphic Copy)		PAGE	RGCPY-1																																		
<p>< FUNCTION > RGCPY command copy a rectangular area specified by the reative coordinates based on CP (Current Pointer) to an address specified by CP.</p> <p>< MNEMONIC > RGCPY (S, DSD, AREA, COL, OPM) dXs, dYs, DX, DY</p>		TYPE	Graphic Command																																		
<p>< FORMAT ></p> <p>COMMAND CODE hexadecimal notation</p> <table style="width: 100%; border-collapse: collapse;"> <tr> <td style="text-align: right;">15</td> <td style="text-align: center;">12 11 10 8 7</td> <td style="text-align: center;">5 4 3 2</td> <td style="text-align: right;">0</td> <td></td> </tr> <tr> <td></td> <td style="text-align: center;">1 1 1 1</td> <td style="text-align: center;">S D S D</td> <td style="text-align: center;">AREA</td> <td style="text-align: center;">O O OPM</td> </tr> </table> <p style="text-align: right;">(\$ F X X X)</p> <p>COMMAND PARAMETERS</p> <table style="width: 100%; border-collapse: collapse;"> <tr> <td style="text-align: right;">15</td> <td style="width: 80%;"></td> <td style="text-align: right;">0</td> </tr> <tr> <td></td> <td style="text-align: center; border: 1px solid black;">dXs</td> <td></td> </tr> <tr> <td style="text-align: right;">15</td> <td style="width: 80%;"></td> <td style="text-align: right;">0</td> </tr> <tr> <td></td> <td style="text-align: center; border: 1px solid black;">dYs</td> <td></td> </tr> <tr> <td style="text-align: right;">15</td> <td style="width: 80%;"></td> <td style="text-align: right;">0</td> </tr> <tr> <td></td> <td style="text-align: center; border: 1px solid black;">DX</td> <td></td> </tr> <tr> <td style="text-align: right;">15</td> <td style="width: 80%;"></td> <td style="text-align: right;">0</td> </tr> <tr> <td></td> <td style="text-align: center; border: 1px solid black;">DY</td> <td></td> </tr> </table>		15	12 11 10 8 7	5 4 3 2	0			1 1 1 1	S D S D	AREA	O O OPM	15		0		dXs		15		0		dYs		15		0		DX		15		0		DY		WORD NUMBER Wn=5	EXECUTION CYCLES Cn= (P+2)A+10)B+70
15	12 11 10 8 7	5 4 3 2	0																																		
	1 1 1 1	S D S D	AREA	O O OPM																																	
15		0																																			
	dXs																																				
15		0																																			
	dYs																																				
15		0																																			
	DX																																				
15		0																																			
	DY																																				
<p>< DESCRIPTION ></p> <p>The Relative Graphic Copy Command (RGCPY) copies data from an rectangular area in the frame buffer (the source area) to another location in the frame buffer (the destination area) with the initial starting point CP. The size of the source rectangular area is parallel to the coordinate axis. Two diagonal corner points are Pss (A+ dXs, B+ dYs) at the absolute coordinate point from CP and Pse (A+ dXs+DX, B+ dYs+DY) at the relative coordinate point from Pss.</p> <p>Pss (dXs, dYs) expressed by the relative X-Y coordinates from CP are set in the command parameter in units of pixels.</p> <p>Pse (DX, DY) expressed by the relative X-Y coordinates from Pss are set in the command parameter in units of pixels.</p>																																					



USE OF ARC AND ELLIPSE ARC COMMAND

○ Use of Arcs and Ellipse Arcs Commands

How to Calculate Parameters of Arc Commands

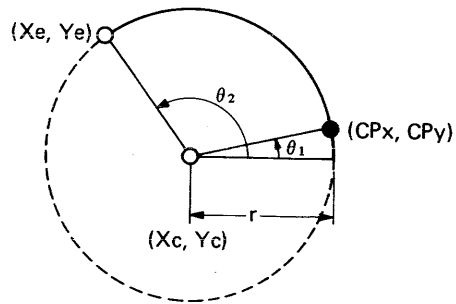
AARC Xc, Yc, Xe, Ye;

RARC dXc, dYc, dXe, dYe;

(Command Issuing Procedure)

CP is moved to the start point
(CPx, CPy) by MOVE, then
ARC is issued.

[Example 1] Given center coordinates
(Xc, Yc), radius r, drawing
start angle θ_1 and drawing
end angle θ_2 , calculate as
follows (counterclockwise
rotation):



(Parameter calculation: ① absolute addressing)

- Calculate the start point (CPx, CPy):

$$CPx = Xc + [r \cos \theta_1 \uparrow]$$

$$CPy = Yc + [r \sin \theta_1 \uparrow]$$

- Calculate the end point (Xe, Ye):

$$Xe = Xc + [R \cos \theta_2 \downarrow]$$

$$Ye = Yc + [R \sin \theta_2 \downarrow] \text{ (where, } R = \sqrt{(CPx - Xc)^2 + (CPy - Yc)^2} \doteq r)$$

(Parameter calculation: ② relative addressing)

- Calculate the start point (CPx, CPy):

$$CPx = Xc + [r \cos \theta_1 \uparrow]$$

$$CPy = Yc + [r \sin \theta_1 \uparrow] \text{ Same as in absolute addressing}$$

- Calculate the center coordinates (dXc, dYc):

$$dXc = - [r \cos \theta_1 \uparrow]$$

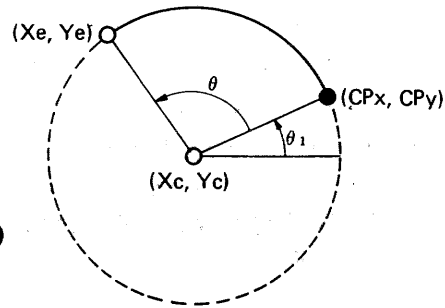
$$dYc = - [r \sin \theta_1 \uparrow]$$

- Calculate the end point (dXe, dYe):

$$dXe = dXc + [R \cos \theta_2 \downarrow]$$

$$dYe = dYc + [R \sin \theta_2 \downarrow] \text{ where, } (R = \sqrt{(CPx - Xc)^2 + (CPy - Yc)^2} \doteq r)$$

[Example 2] Given center coordinates (X_c, Y_c) , start point (CP_x, CP_y) and drawing angle θ , calculate as follows (counterclockwise rotation):



(Parameter calculation: ① absolute addressing)

- Calculate the end point (X_e, Y_e) :

$$X_e = X_c + [R \cos (\theta + \theta_1) \downarrow]$$

$$Y_e = Y_c + [R \sin (\theta + \theta_1) \downarrow]$$

$$\left(\begin{array}{l} \text{where, } R = \sqrt{(CP_x - X_c)^2 + (CP_y - Y_c)^2} \\ \theta_1 = \tan^{-1} \left(\frac{CP_y - Y_c}{CP_x - X_c} \right) \end{array} \right)$$

(Parameter calculation: ② relative addressing)

- Calculate the center coordinates (dX_c, dY_c) :

$$dX_c = X_c - CP_x$$

$$dY_c = Y_c - CP_y$$

- Calculate the end point (dX_e, dY_e) :

$$dX_e = dX_c + [R \cos (\theta + \theta_1) \downarrow]$$

$$dY_e = dY_c + [R \sin (\theta + \theta_1) \downarrow]$$

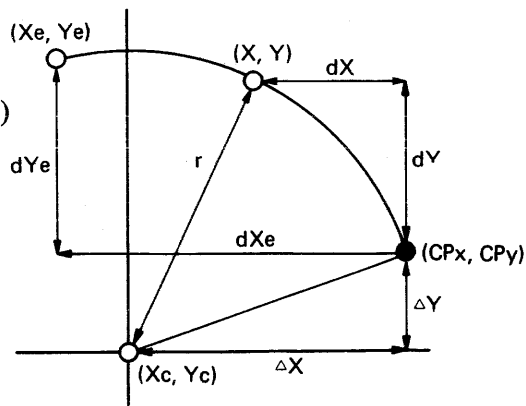
$$\left(\begin{array}{l} \text{where, } R = \sqrt{(CP_x - X_c)^2 + (CP_y - Y_c)^2} \\ \theta_1 = \tan^{-1} \left(\frac{CP_y - Y_c}{CP_x - X_c} \right) \end{array} \right)$$

[Example 3] Calculate parameters for an Arc that passes 3 points, (CP_x, CP_y) , (X, Y) and (X_e, Y_e) .

(Parameter calculation: Relative addressing)

$$\left\{ \begin{array}{l} dX = X - CP_x \\ dY = Y - CP_y \end{array} \right.$$

$$\left\{ \begin{array}{l} dX_e = X_e - CP_x \\ dY_e = Y_e - CP_y \end{array} \right.$$



• Calculate the center coordinates (dXc, dYc):

$$\begin{cases} \Delta X^2 + \Delta Y^2 = r^2 \\ (\Delta X + dX)^2 + (\Delta Y + dY)^2 = r^2 \\ (\Delta X + dXe)^2 + (\Delta Y + dYe)^2 = r^2 \end{cases}$$

where,

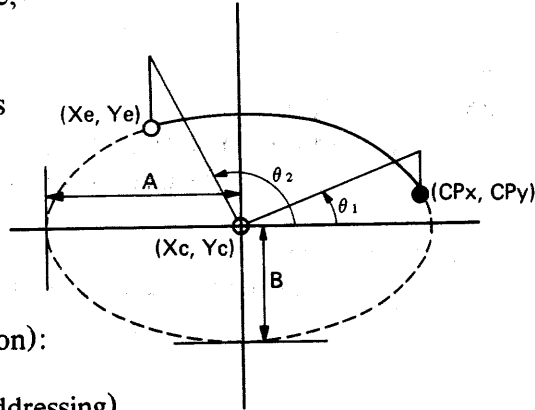
$$\begin{cases} dXc = [-\Delta X] \\ \quad = \left[\frac{1}{2} \cdot \frac{(dX^2 + dY^2) \cdot dYe - (dXe^2 + dYe^2) \cdot dY}{dX \cdot dYe - dXe \cdot dY} \right] \\ \\ dYc = [-\Delta Y] \\ \quad = \left[\frac{1}{2} \cdot \frac{(dXe^2 + dYe^2) \cdot dX - (dX^2 + dY^2) \cdot dXe}{dX \cdot dYe - dXe \cdot dY} \right] \end{cases}$$

○ Calculating Parameters of Ellipse Arc Commands

AEARC a, b, Xc, Yc, Xe, Ye;
REARC a, b, dXc, dYc, dXe, dYe;

(Command Issuing Procedure)

[Example 1] Given center coordinates (Xc, Yc), X direction axial length A, Y direction axial length B, drawing start angle θ_1 and drawing end angle θ_2 , calculate as follows (counterclockwise rotation):



(Parameter calculation: ① absolute addressing)

- Calculate the axial length square ratio (a/b):
The ratio should be an integral ratio satisfying $a/b = A^2/B^2$.
- Calculate the start point (CPx, CPy):

$$\begin{cases} CPx = Xc + [A \cos \theta_1 \downarrow] \\ CPy = Yc + [B \sin \theta_1 \downarrow] \end{cases}$$
- Calculate the end point (Xe, Ye):

$$\begin{cases} Xe = Xc + [\sqrt{a} R' \cos \theta_2 \downarrow] \\ Ye = Yc + [\sqrt{b} R' \sin \theta_2 \downarrow] \end{cases}$$

where $R' = \sqrt{\frac{(CPx - Xc)^2}{a} + \frac{(CPy - Yc)^2}{b}} \doteq \frac{A}{\sqrt{a}}$ or $\frac{B}{\sqrt{b}}$

(Parameter calculation: ② relative addressing)

- Calculate the start point (CPx, CPy):

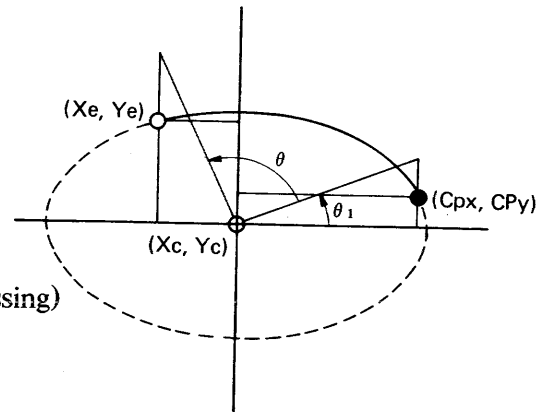
$$\begin{cases} CPx = Xc + [A \cos \theta_1 \downarrow] \\ CPy = Yc + [B \sin \theta_1 \downarrow] \end{cases} \quad \leftarrow \text{Same as in absolute addressing}$$
- Calculate the center coordinates (dXc, dYc):

$$\begin{cases} dXc = - [A \cos \theta_1 \downarrow] \\ dYc = - [B \sin \theta_1 \downarrow] \end{cases}$$
- Calculate the end point (dXe, dYe):

$$\begin{cases} dXe = dXc + [\sqrt{a} R' \cos \theta_2 \downarrow] \\ dYe = dYc + [\sqrt{b} R' \sin \theta_2 \downarrow] \end{cases}$$

where $R' = \sqrt{\frac{(CPx - Xc)^2}{a} + \frac{(CPy - Yc)^2}{b}} \doteq \frac{A}{\sqrt{a}}$ or $\frac{B}{\sqrt{b}}$

[Example 2] Given center coordinates (X_c, Y_c) , axial length square ratio a/b , drawing start point (CP_x, CP_y) and drawing angle θ , calculate as follows (counterclockwise rotation):



(parameter calculation: ① absolute addressing)

- Calculate the end point (X_e, Y_e) :

$$\begin{cases} X_e = X_c + [\sqrt{a} R' \cos(\theta + \theta_1)] \\ Y_e = Y_c + [\sqrt{b} R' \sin(\theta + \theta_1)] \end{cases}$$

$$\text{where } R' = \sqrt{\frac{(CP_x - X_c)^2}{a} + \frac{(CP_y - Y_c)^2}{b}}$$

$$\theta_1 = \tan^{-1} \left(\sqrt{\frac{a}{b}} \cdot \frac{CP_y - Y_c}{CP_x - X_c} \right)$$

(Parameter calculation: ② relative addressing)

- Calculate the center coordinates (dX_c, dY_c) :

$$\begin{cases} dX_c = X_c - CP_x \\ dY_c = Y_c - CP_y \end{cases}$$

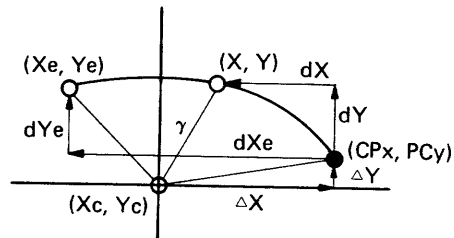
- Calculate the end point (dX_e, dY_e) :

$$\begin{cases} dX_e = dX_c + [\sqrt{a} R' \cos(\theta + \theta_1)] \\ dY_e = dY_c + [\sqrt{b} R' \sin(\theta + \theta_1)] \end{cases}$$

$$\text{where } R' = \sqrt{\frac{(CP_x - X_c)^2}{a} + \frac{(CP_y - Y_c)^2}{b}}$$

$$\theta_1 = \tan^{-1} \left(\sqrt{\frac{a}{b}} \cdot \frac{CP_y - Y_c}{CP_x - X_c} \right)$$

[Example 3] Calculate parameters for an ellipse arc that passes 3 points, (CP_x, CP_y) , (X, Y) and (X_e, Y_e) (axial length square ratio: a/b).



(Parameter calculation: Relative addressing)

$$\begin{cases} dX = X - CP_x & dX_e = X_e - CP_x \\ dY = Y - CP_y & dY_e = Y_e - CP_y \end{cases}$$

- Calculate the center coordinates (dXc, dYc):

$$\begin{cases} \frac{\Delta X^2}{a} + \frac{\Delta Y^2}{b} = r^2 \\ \frac{(\Delta X + dX)^2}{a} + \frac{(\Delta Y + dY)^2}{b} = r^2 \\ \frac{(\Delta X + dXe)^2}{a} + \frac{(\Delta Y + dYe)^2}{b} = r^2 \end{cases}$$

we get

$$\begin{aligned} dXc &= [-\Delta X \uparrow] \\ &= \left[\frac{1}{2b} \cdot \frac{(b \cdot dX^2 + a \cdot dY^2) \cdot dYe - (b \cdot dXe^2 + a \cdot dYe^2) \cdot dY}{dX \cdot dYe - dXe \cdot dY} \uparrow \right] \end{aligned}$$

$$\begin{aligned} dYc &= [-\Delta Y \uparrow] \\ &= \left[\frac{1}{2a} \cdot \frac{(b \cdot dXe^2 + a \cdot dYe^2) \cdot dX - (b \cdot dX^2 + a \cdot dY^2) \cdot dXe}{dX \cdot dYe - dXe \cdot dY} \uparrow \right] \end{aligned}$$

Note:

[↑]: With sign unchanged, rounding the absolute value to the integer.

[↑]: With sign unchanged, round up the absolute value to the integer.

[↓]: With sign unchanged, truncate the absolute value to the integer.

ELECTRICAL SPECIFICATION

○ Absolute Maximum Ratings

Item	Symbol	Rating	Unit
Supply voltage	V_{cc} *	-0.3 ~ +7.0	V
Input voltage	V_{in} *	-0.3 ~ +7.0	V
Allowable output current	$ I_o $ **	5	mA
Total allowable output current	$ \Sigma I_o $ ***	120	mA
Operating temperature	T_{opr}	-20 ~ +75	°C
Storage temperature	T_{stg}	-55 ~ +150	°C

* This value is in reference to $V_{ss} = 0V$.

** The allowable output current is the maximum current that may be drawn from, or flow out to, one output terminal or one input/output common terminal.

*** The total allowable output current is the total sum of currents that may be drawn from, or flow out to, output terminals or input/output common terminals.

Note: Using an LSI beyond its maximum ratings may result in its permanent destruction. LSI's should usually be used under recommended operating conditions. Exceeding any of these conditions may adversely affect its reliability.

○ Recommended Operating Conditions

Item	Symbol	min	typ	max	Unit
Supply voltage	V_{cc} *	4.5	5.0	5.5	V
Input "low" level voltage	V_{IL} *	0	—	0.8	V
Input "high" level voltage	V_{IH} *	2.2	—	V_{cc}	V
Operating temperature	T_{opr}	-20	25	75	°C

* This value is in reference to $V_{ss} = 0V$.

○ Electrical Characteristics

- DC characteristics ($V_{CC} = 5.0V \pm 10\%$, $V_{SS} = 0V$, $T_a = -20$ to $75^\circ C$ unless otherwise noted)

Item	Symbol	Measuring condition	4 MHz Version		6 MHz Version		8 MHz Version		Unit	
			HD63484-4		HD63484-6		HD63484-8			
			min	max	min	max	min	max		
Input "high" level voltage	All Inputs	V_{IH}	2.2	V_{CC}	2.2	V_{CC}	2.2	V_{CC}	V	
Input "low" level voltage	All Inputs	V_{IL}	-0.3	0.8	-0.3	0.8	-0.3	0.8	V	
Input leak current	$\overline{R/W}, \overline{CS}, \overline{RS}, \overline{RES}, \overline{DACK}, 2\overline{CLK}, \overline{LPSTB}$	I_{in}	$V_{in}=0$ $\sim V_{CC}$	-2.5	2.5	-2.5	2.5	-2.5	2.5	μA
Three state (off state) input current	$\overline{D0} \sim \overline{D15}$, \overline{EXSYNC} , $\overline{MAD0} \sim \overline{MAD15}$	I_{TSI}	$V_{in}=0.4$ $\sim V_{CC}$	-10	10	-10	10	-10	10	μA
Output "high" level voltage	$\overline{D0} \sim \overline{D15}$, $\overline{MAD0} \sim \overline{MAD15}$, $\overline{CUD1}$, $\overline{CUD2}$, \overline{DREQ} , \overline{DTACK} , \overline{HSYNC} , \overline{VSYNC} , \overline{EXSYNC}	V_{OH}	$I_{OH} = -400 \mu A$	V_{CC} -1.0	-	V_{CC} -1.0	-	V_{CC} -1.0	-	V
Output "low" level voltage	$\overline{DISP1}$, $\overline{DISP2}$, $\overline{CHR}, \overline{MRD}$, $\overline{DRAW}, \overline{AS}$, \overline{MCYC} , $\overline{RA4}$, $\overline{MA16}/\overline{RA0} \sim \overline{MA19}/\overline{RA3}$	V_{OL}	$I_{OL} = 2.2mA$	-	0.5	-	0.5	-	0.5	V
Output leak current (off state)	\overline{IRQ} , \overline{DONE}	I_{LOH}	$V_{OH} = V_{CC}$	-	10	-	10	-	10	μA
Input capacity	$\overline{D0} \sim \overline{D15}$, \overline{EXSYNC} , $\overline{MAD0} \sim \overline{MAD15}$	C_{in}	$V_{in}=0V$ $T_a=25^\circ C$ $f=1.0MHz$	-	15	-	15	-	15	PF
	$\overline{R/W}, \overline{CS}, \overline{RS}, \overline{RES}, \overline{DACK}, 2\overline{CLK}, \overline{LPSTB}$			-	15	-	15	-	15	

Item	Symbol	Measuring condition	4 MHz Version		6 MHz Version		8 MHz Version		Unit		
			HD63484-4		HD63484-6		HD63484-8				
			min	max	min	max	min	max			
Output capacity	$\overline{\text{IRQ}}$, DONE	Cout	—	15	—	15	—	15	PF		
Current consumption		Icc	• Chip not selected • Display in progress		—	T.B.D	—	T.B.D	—	T.B.D	mA
			• Data bus in read/write operation • Display in progress • Command execution in progress		—	T.B.D	—	T.B.D	—	T.B.D	mA

- AC characteristics ($V_{cc} = 5.0 \pm 10\%$, $V_{ss} = 0V$, $T_a = -20$ to $75^\circ C$ unless otherwise noted)

No.	Item	Symbol	Measuring condition	4 MHz Version		6 MHz Version		8 MHz Version		Unit
				HD63484-4		HD63484-6		HD63484-8		
				min	max	min	max	min	max	
	Frequency of Operation	f		1	4	1	6	1	8	MHz
1	Clock Cycle Time	t _{cyc}		250	1000	167	1000	125	1000	ns
2	Clock "High" Level Pulse Width	t _{PWCH}		115	500	75	500	55	500	ns
3	Clock "Low" Level Pulse Width	t _{PWCL}		115	500	75	500	55	500	ns
4	Clock Rise Time	t _{cr}		—	10	—	10	—	10	ns
5	Clock Fall Time	t _{cf}		—	10	—	10	—	10	ns
6	R/W Setup Time	t _{RWS}		70	—	60	—	50	—	ns
7	R/W Hold Time	t _{RWH}		0	—	0	—	0	—	ns
8	RS Setup Time	t _{RSS}		70	—	60	—	50	—	ns
9	RS Hold Time	t _{RSH}		0	—	0	—	0	—	ns
10	\overline{CS} Setup Time	t _{CSS}		50	—	40	—	40	—	ns
11	\overline{CS} Hold Time	t _{CSH}		60	—	60	—	60	—	ns
12										
13	Read Wait Time	t _{RWAI}		0	—	0	—	0	—	ns
14	Read Data Access Time	t _{RDAC}		—	120	—	100	—	80	ns
15	Read Data Hold Time	t _{RDH}		10	—	10	—	10	—	ns
16	Read Data Turn Off Time	t _{RDZ}		—	60	—	60	—	60	ns
17	\overline{DTACK} Delay Time (Z to L)	t _{DTKZL}		—	90	—	80	—	70	ns
18	\overline{DTACK} Delay Time (L to L)	t _{DTKDL}		0	—	0	—	0	—	ns
19	\overline{DTACK} Hold Time (L to H)	t _{DTKLH}		—	60	—	60	—	60	ns
20	\overline{DTACK} Turn Off Time (H to Z)	t _{DTKZ}		—	100	—	100	—	100	ns
21	Data Bus 3 State Recovery Time 1	t _{DBRT1}		0	—	0	—	0	—	ns
22	Write Wait Time	t _{WWAI}		0	—	0	—	0	—	ns
23	WRITE Data Setup Time	t _{WDS}		80	—	60	—	40	—	ns
24	WRITE Data Hold Time	t _{WDH}		10	—	10	—	10	—	ns
25	\overline{DREQ} Delay Time1	t _{DRQD1}		70	—	60	—	50	—	ns
26	\overline{DREQ} Delay Time2	t _{DRQD2}		70	—	60	—	50	—	ns
27	DMA R/W Setup Time	t _{DRWS}		70	—	60	—	50	—	ns
28	DMA R/W Hold Time	t _{DRWH}		0	—	0	—	0	—	ns
29	\overline{DACK} Setup Time	t _{DAKS}		50	—	40	—	40	—	ns
30	\overline{DACK} Hold Time	t _{DAKH}		60	—	60	—	60	—	ns
31										
32	DMA Read Wait Time	t _{DRW}		0	—	0	—	0	—	ns
33	DMA Read Data Access Time	t _{DRDAC}		—	120	—	100	—	80	ns
34	DMA Read Data Hold Time	t _{DRDH}		10	—	10	—	10	—	ns

No.	Item	Symbol	Measuring condition	4 MHz Version		6 MHz Version		8 MHz Version		Unit
				HD63484-4		HD63484-6		HD63484-8		
				min	max	min	max	min	max	
35	DMA Read Data Turn Off Time	tDRDZ		-	60	-	60	-	60	ns
36	DMA \overline{DTACK} Delay Time (Z to L)	tDDTZL		-	90	-	80	-	70	ns
37	DMA \overline{DTACK} Delay Time (D to L)	tDDTDL		0	-	0	-	0	-	ns
38	DMA \overline{DTACK} Hold Time (L to H)	tDDTLH		60	-	60	-	60	-	ns
39	DMA \overline{DTACK} Turn Off Time (H to Z)	tDDTHZ		-	100	-	100	-	100	ns
40	\overline{DONE} Output Delay Time	tDND		-	70	-	60	-	50	ns
41	\overline{DONE} Output Turn Off Time (L to Z)	tDNLZ		-	100	-	90	-	80	ns
42	Data Bus 3 State Recovery Time 2	tDBRT2		0	-	0	-	0	-	ns
43	\overline{DONE} Input Pulse Width	tDNPW		2	-	2	-	2	-	Clk. Cyc
44	DMA Write Wait Time	tDWW		0	-	0	-	0	-	ns
45	DMA Write Data Setup Time	tDWDS		80	-	60	-	40	-	ns
46	DMA Write Data Hold Time	tDWDH		10	-	10	-	10	-	ns
47										
48										
49	Memory Address Hold Time 2	tMAH2		10	-	10	-	10	-	ns
50	\overline{AS} Delay Time	tASD		-	90	-	75	-	65	ns
51	\overline{AS} "Low" Level Pulse Width	tPWASL		80	tPWCL + 30	50	tPWCL + 10	30	tPWCL	ns
52	Memory Address Delay Time	tMAD		-	90	-	80	-	70	ns
53	Memory Address Hold Time 1	tMAH1		10	-	10	-	10	-	ns
54	Memory Address Turn Off Time (A-Z)	tMAAZ		-	50	-	50	-	50	ns
55	Memory Address Data Setup Time	tMRDS		60	-	50	-	40	-	ns
56	Memory Read Data Hold Time	tMRDH		10	-	10	-	10	-	ns
57	MA/RA Delay Time	tMARAD		-	90	-	80	-	70	ns
58	MA/RA Hold Time	tMARAH		10	-	10	-	10	-	ns
59	MCYC Delay Time	tMCYCD		-	60	-	50	-	40	ns
60	MRD Delay Time	tMRDD		-	90	-	80	-	70	ns
61	MRD Hold Time	tMRDH		10	-	10	-	10	-	ns
62	\overline{DRAW} Delay Time	tDRWD		-	90	-	80	-	70	ns
63	\overline{DRAW} Hold Time	tDRWH		10	-	10	-	10	-	ns
64	Memory Write Data Delay Time	tMWDD		-	90	-	80	-	70	ns
65	Memory Write Data Hold Time	tMWDH		10	-	10	-	10	-	ns

No.	Item	Symbol	Measuring condition	4 MHz Version		6 MHz Version		8 MHz Version		Unit
				HD63484-4		HD63484-6		HD63484-8		
				min	max	min	max	min	max	
66	Memory Write Data Turn Off Time	tMWDZ		–	60	–	50	–	40	ns
67	HSYNC Delay Time	tHSD		–	90	–	80	–	70	ns
68	VSYNC Delay Time	tVSD		–	90	–	80	–	70	ns
69	DISPT, DISP2 Delay Time	tDSPD		–	90	–	80	–	70	ns
70	CUDT, CUD2 Delay Time	tCUDD		–	90	–	80	–	70	ns
71	EXSYNC Output Delay Time	tEXD		30	90	30	80	30	70	ns
72	CHR Delay Time	tCHD		–	90	–	80	–	70	ns
73										
74										
75	EXSYNC Input Pulse Width	tEXSW		3	–	3	–	3	–	Clk. Cyc
76	EXSYNC Input Setup Time	tEXS		60	–	60	–	50	–	ns
77	EXSYNC Input Hold Time	tEXH		30	–	30	–	30	–	ns
78	LPSTB Uncertain Time 1	tLPD1		70	–	70	–	70	–	ns
79	LPSTB Uncertain Time 2	tLPD2		10	–	10	–	10	–	ns
80	LPSTB Input Hold Time	tLPH		10	–	10	–	10	–	ns
81	LPSTB Input Inhibit time	tLPI		4	–	4	–	4	–	Clk. Cyc
82	DACK Setup Time for RES	tDAKSR		100	–	100	–	100	–	ns
83	DACK Hold Time for RES	tDAKHR		0	–	0	–	0	–	ns
84	RES Input Pulse Width	tRES		10	–	10	–	10	–	Clk. Cyc
85	IRQ Delay Time 1	tIRQ1		100	–	100	–	100	–	ns
86	IRQ Delay Time 2	tIRQ2		500	–	500	–	500	–	ns
87	ATR Delay Time 1	tATRD1		–	100	–	90	–	80	ns
88	ATR Hold Time 1	tATRH1		10	–	10	–	10	–	ns
89	ATR Turn Off Time	tATRZ		–	60	–	50	–	40	ns
90	ATR Delay Time 2	tATRD2		–	100	–	90	–	80	ns
91	ATR Hold Time 2	tATRH2		10	–	10	–	10	–	ns

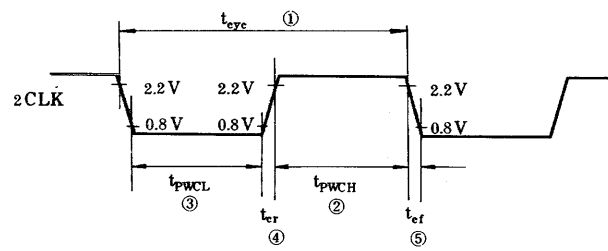


Figure T-1 2CLK Waveform

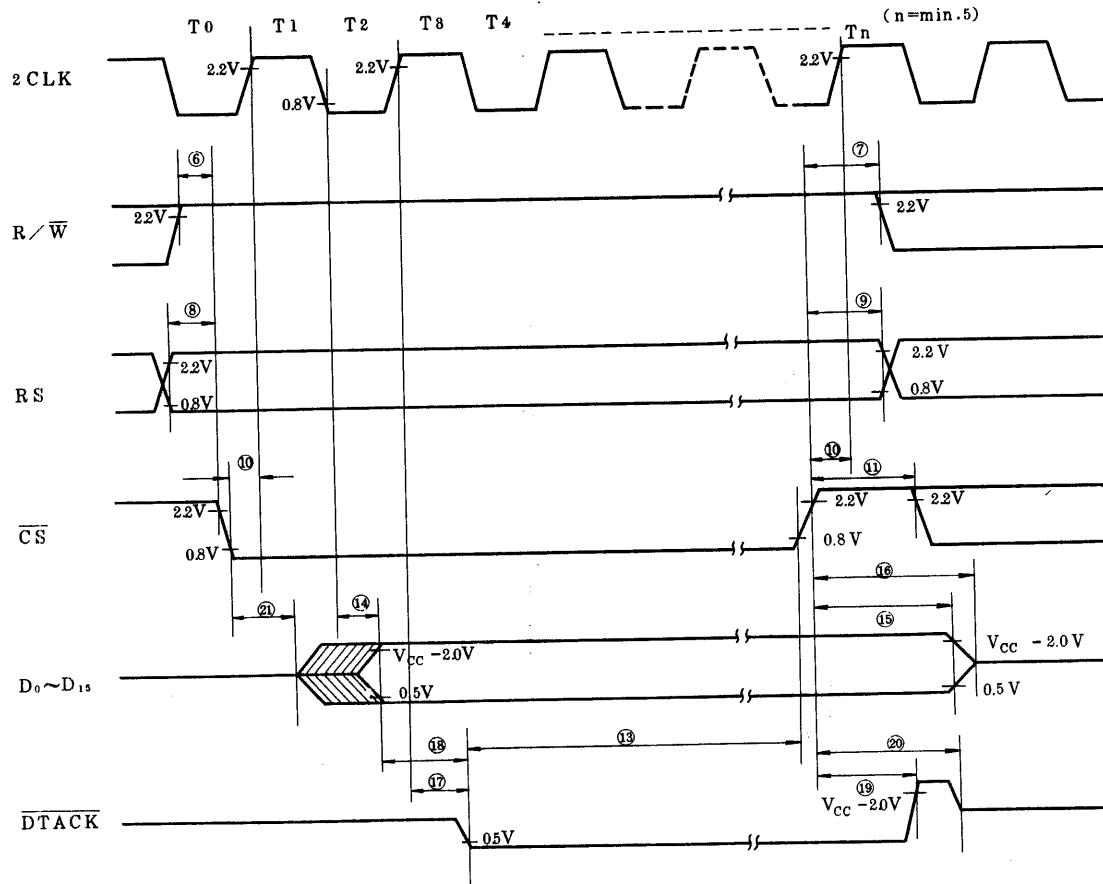


Figure T-2 MPU Read Cycle Timing (MPU ← ACRTC)

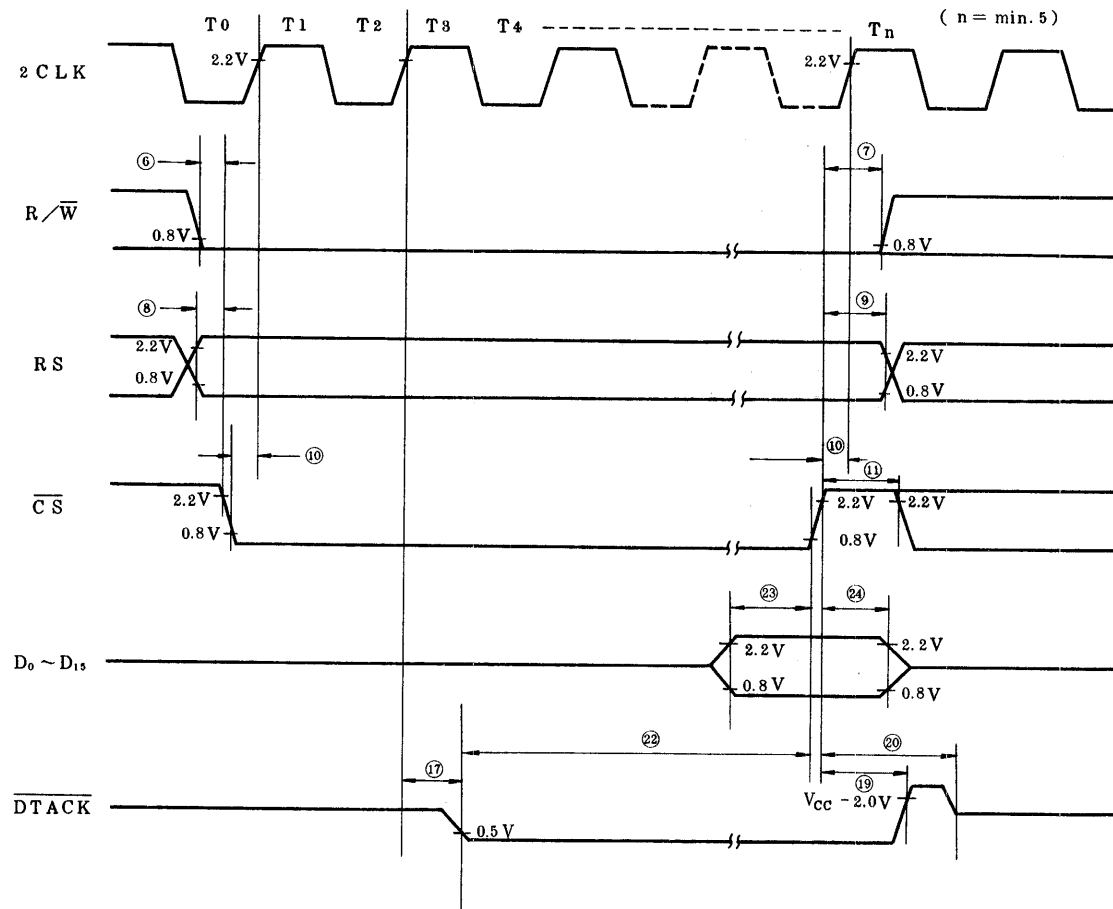


Figure T-3 MPU Write Cycle Timing (MPU → ACRTC)

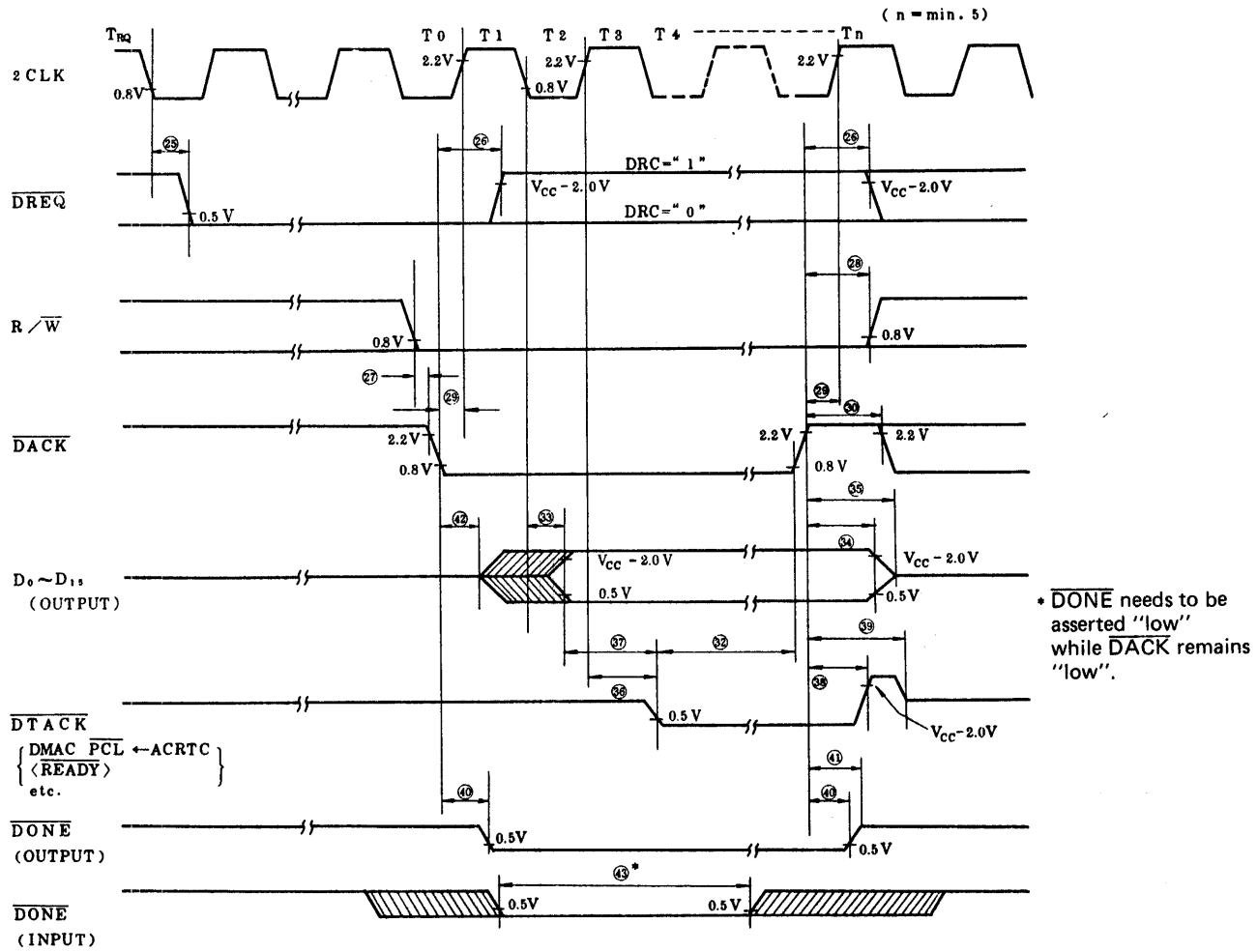
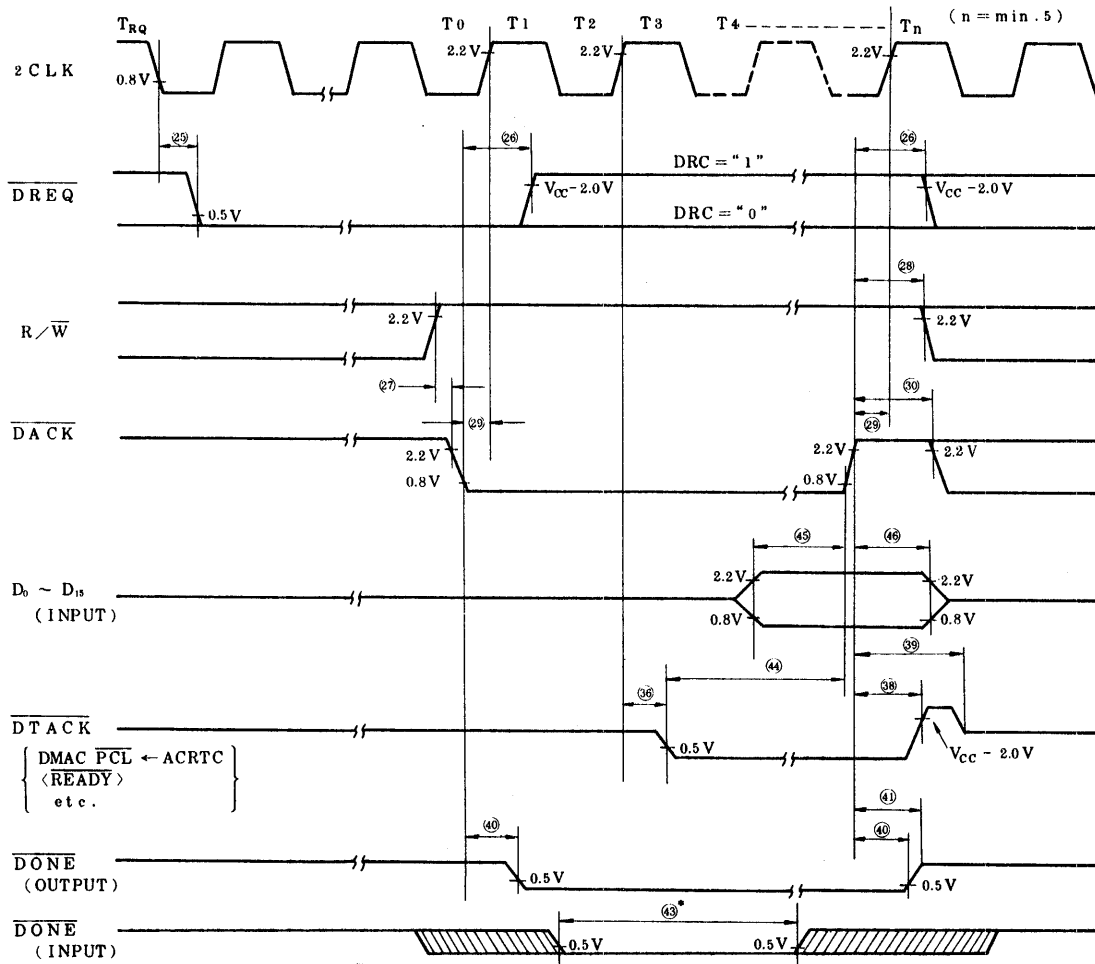


Figure T-4 DMA Read Cycle timing (Memory ← ACRTC)



• \overline{DONE} needs to be asserted "low" while \overline{DACK} remains "low."

Figure T-5 DMA Write Cycle timing (Memory → ACRTC)

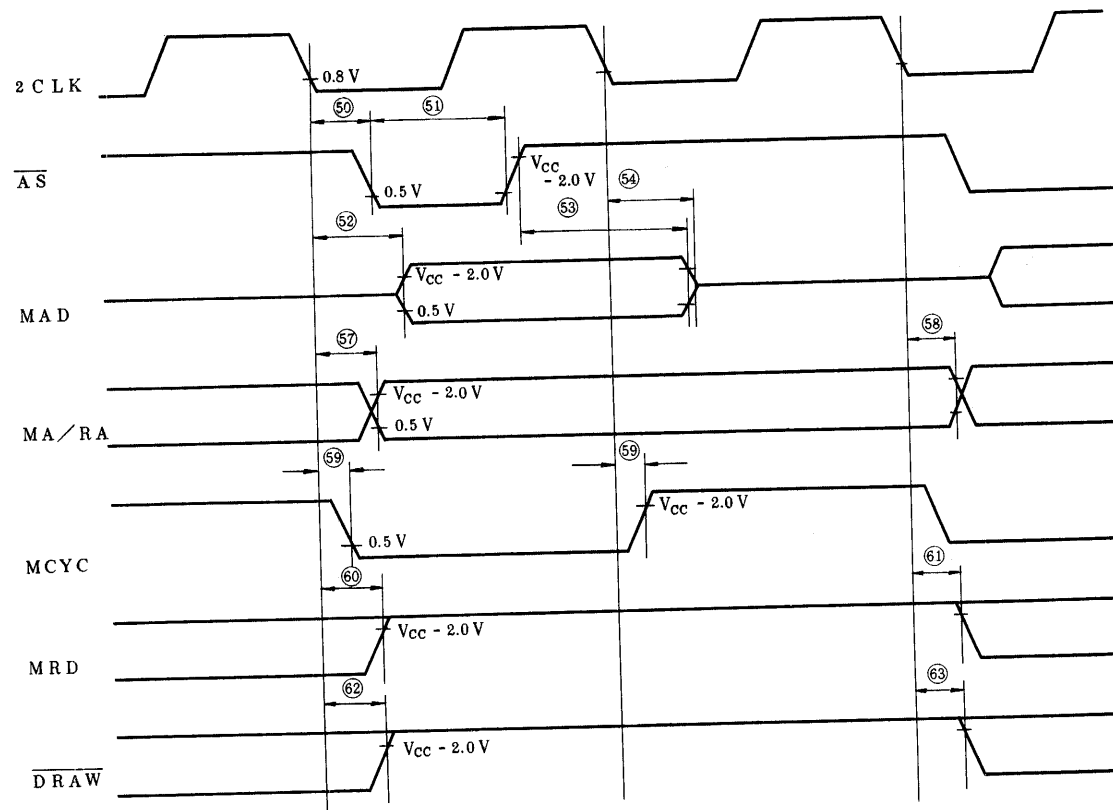


Figure T-6 Screen Display Cycle Timing

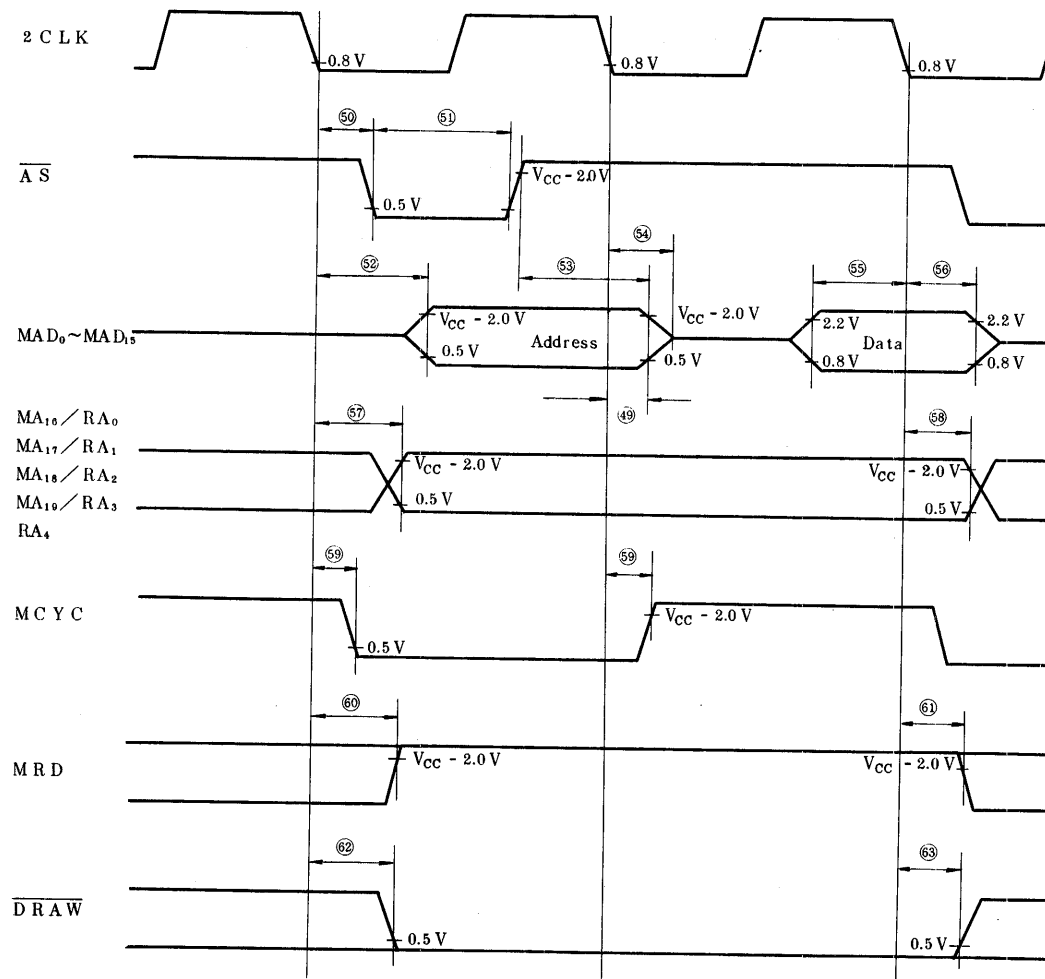


Figure T-7 Frame Memory Read Cycle Timing
(ACRTC ← Frame Memory)

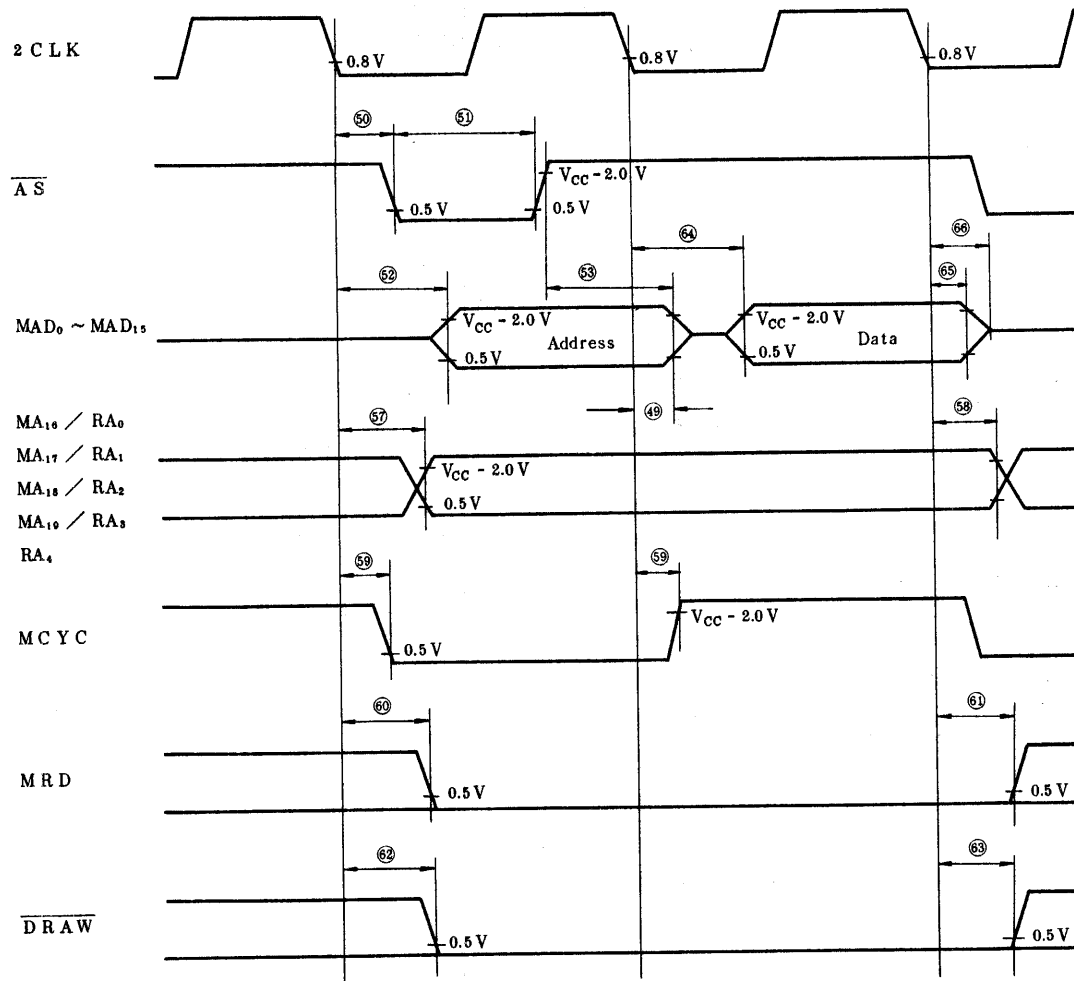
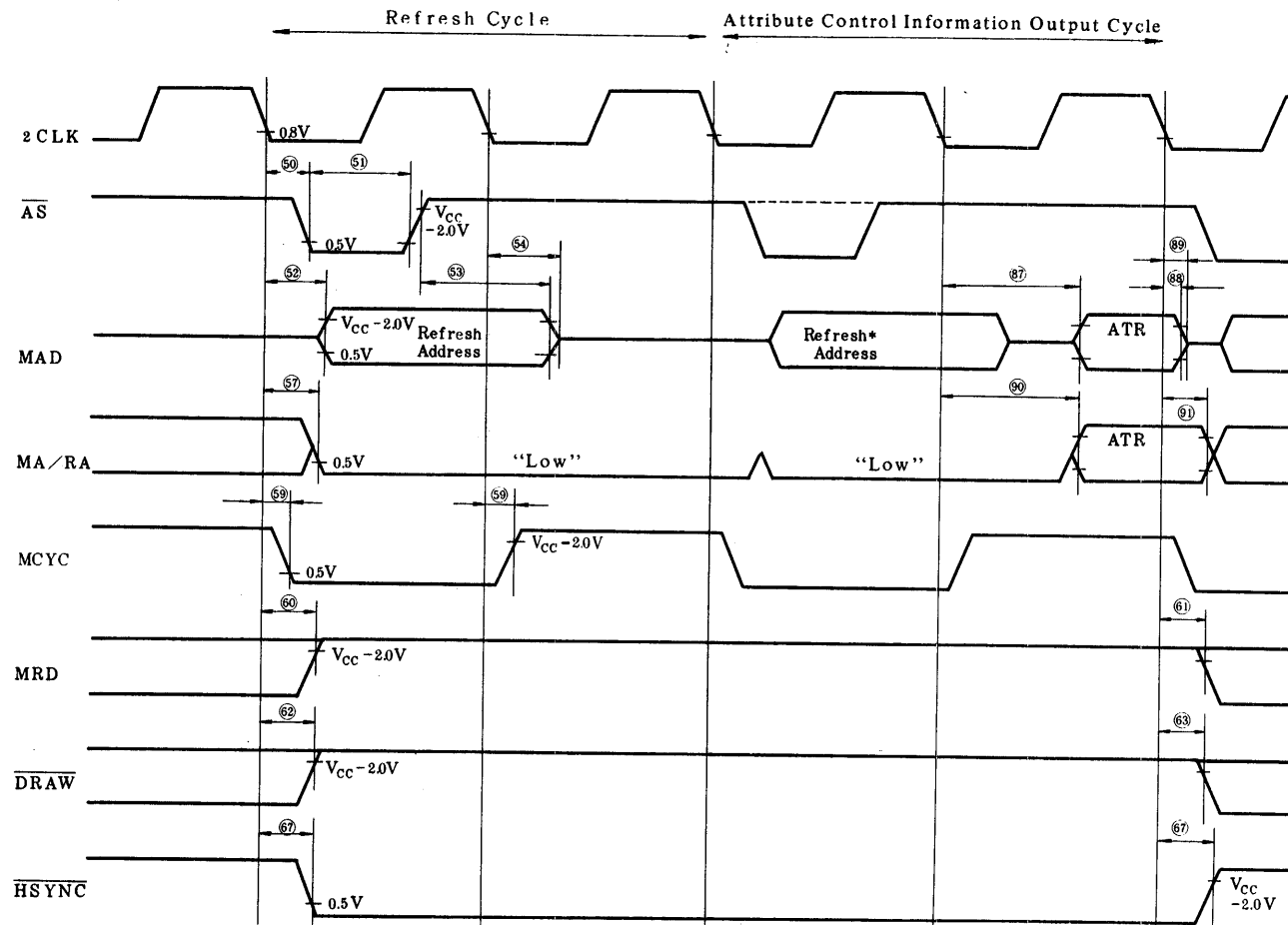


Figure T-8 Frame Memory Write Cycle Timing
(ACRTC → Frame Memory)



* When AS is "High", a "0" output is given.

Figure T-9 Frame Memory Refresh/Attribute Control Information Output Cycle Timing

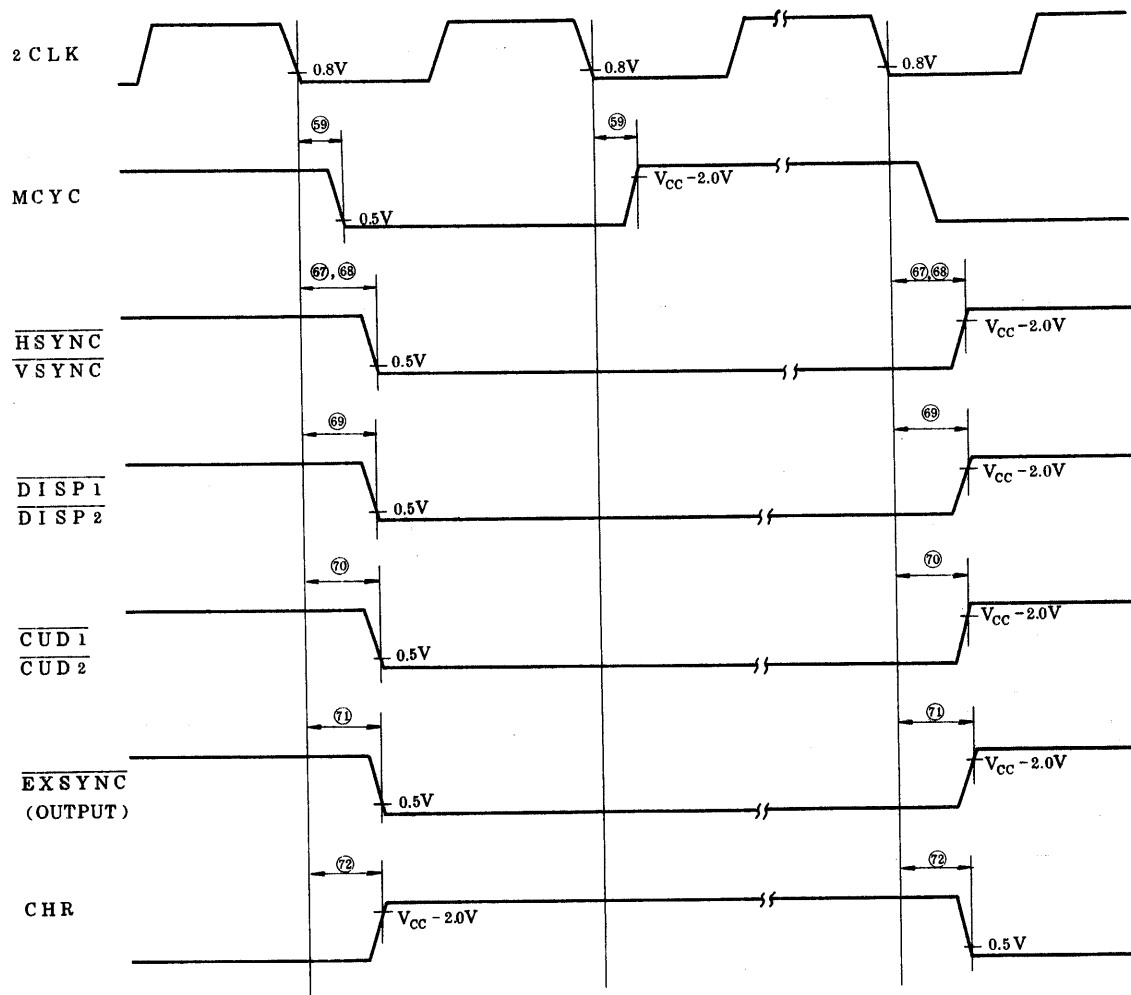
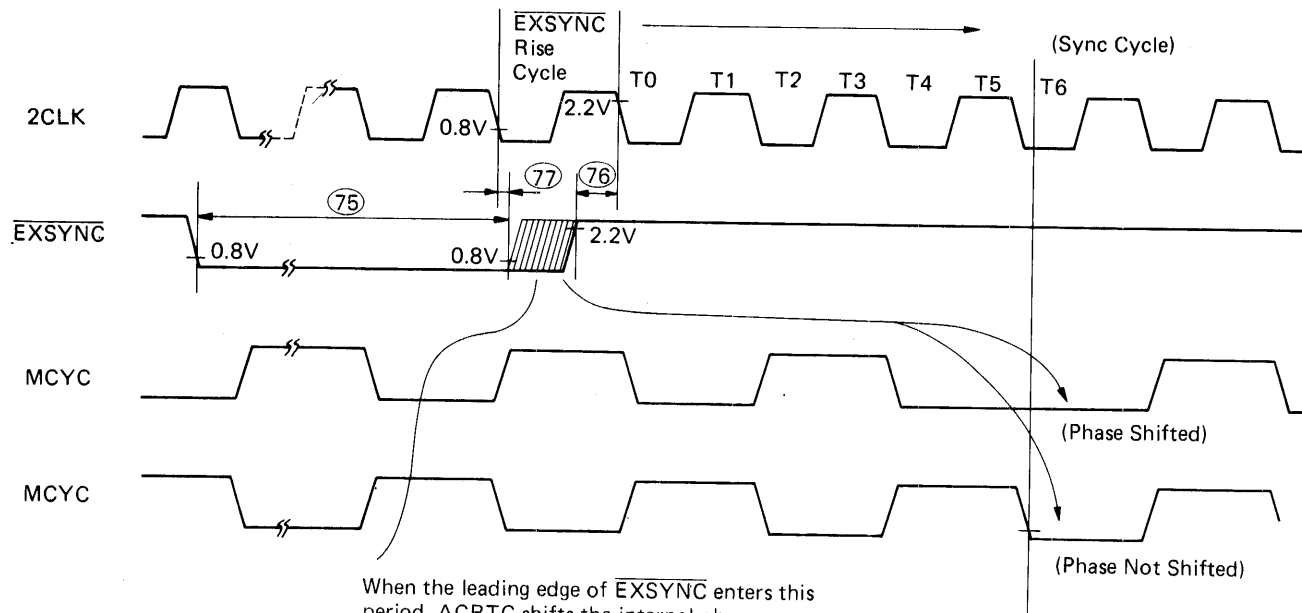
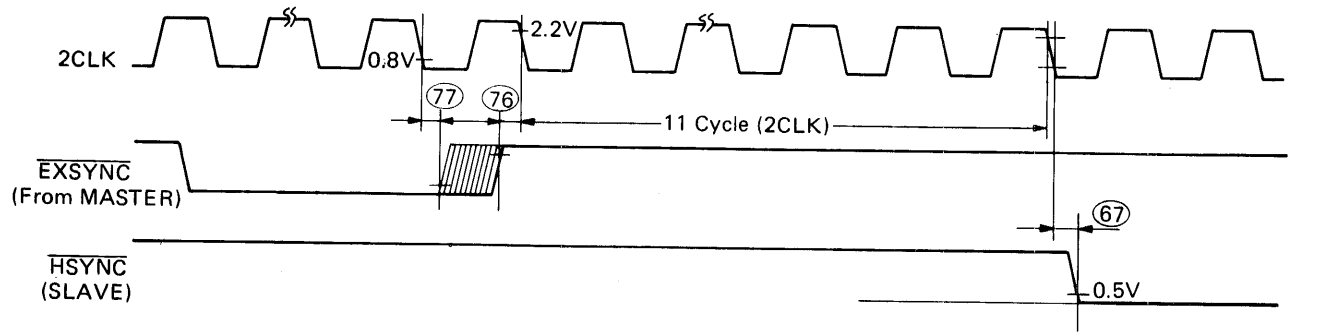


Figure T-10 Display Control Signal Output Timing



When the leading edge of EXSYNC enters this period, ACRTC shifts the internal phase according to the above sequence.

Figure T-11 EXSYNC Input Timing

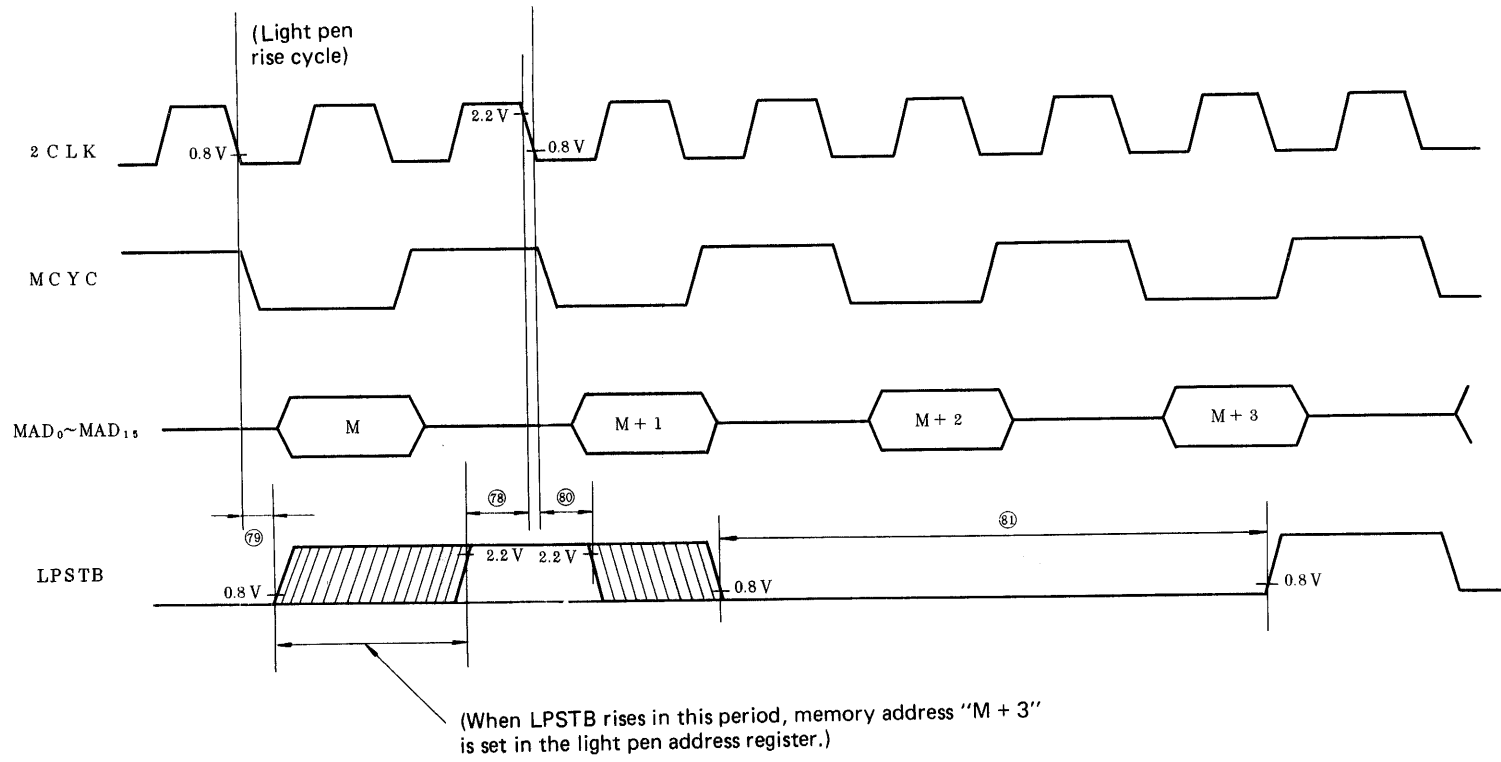
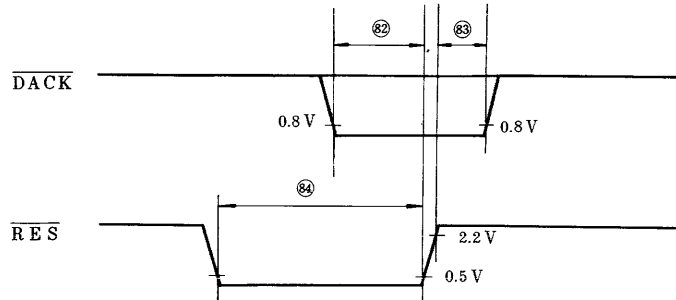


Figure T-12 Input LPSTB Timing and Light Pen Address



**Figure T-13 \overline{RES} Input and \overline{DACK} Input Timing
(System Reset and 16-bit/8-bit Selection)**

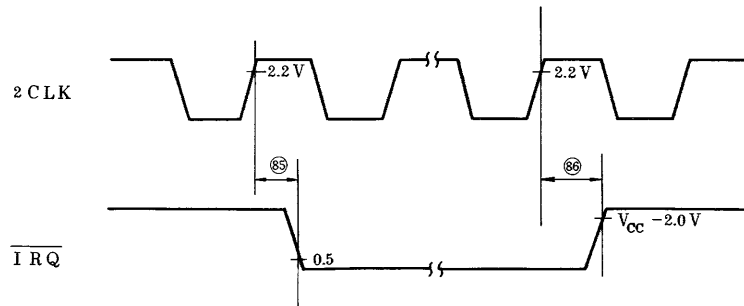


Figure T-14 \overline{IRQ} Output Timing

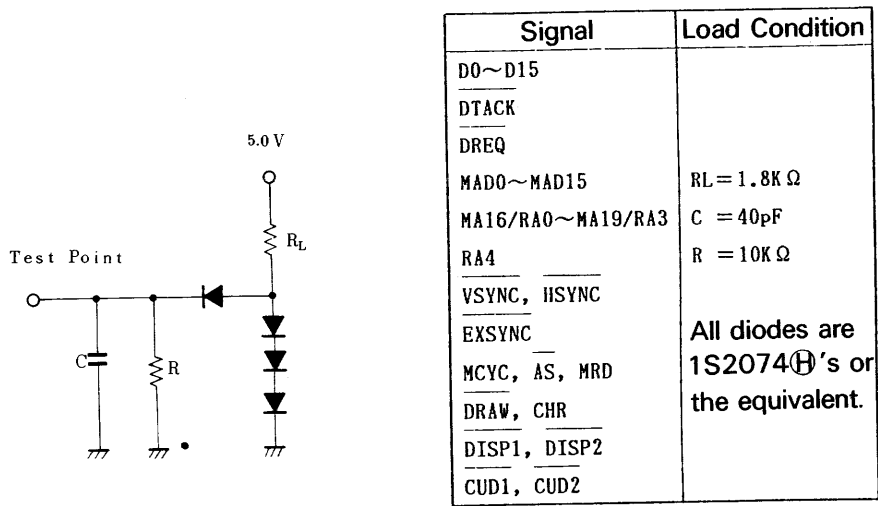


Figure T-15 Test Load Circuit A

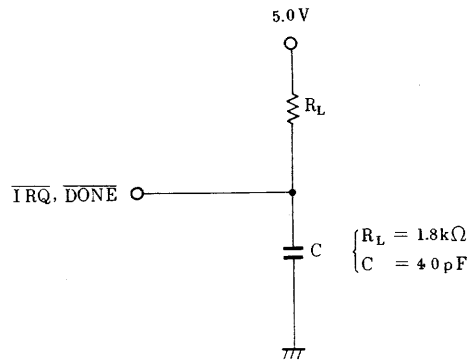


Figure T-16 Test Load Circuit B

HITACHI AMERICA, LTD.

SEMICONDUCTOR AND IC SALES & SERVICE DIVISION

HEADQUARTERS

Hitachi, Ltd.
Nippon Bldg., 6-2, 2-chome
Ohtemachi, Chiyoda-ku, Tokyo, 100, Japan
Tel: 212-1111
Telex: J22395, J22432

U.S. SALES OFFICE

Hitachi America, Ltd.
Semiconductor and IC Sales & Service Division
2210 O'Toole Avenue
San Jose, CA 95131
Tel: 408-942-1500
Telex: 17-1581
Twx: 910-338-2103
Fax: 408-942-8225
Fax: 408-942-8880

REGIONAL OFFICES

NORTHEAST REGION

Hitachi America, Ltd.
5 Burlington Woods Dr.
Burlington, MA 01803
617/229-2150

SOUTHERN REGION

Hitachi America, Ltd.
Two Lincoln Centre, Suite 865
5420 LBJ Freeway
Dallas, TX 75240
214/991-4510

NORTHERN CENTRAL REGION

Hitachi America, Ltd.
500 Park Blvd., Suite 415
Itasca, IL 60143
312/773-4864

NORTHWEST REGION

Hitachi America, Ltd.
2099 Gateway Place, Suite 550
San Jose, CA 95110
408/277-0712

SOUTHWEST REGION

Hitachi America, Ltd.
Warner Center Plaza One
21600 Oxnard St., Suite 600
Woodland Hills, CA 91367
818/704-6500

DISTRICT OFFICES

- Hitachi America, Ltd.
1700 Galloping Hill Rd.
Kenilworth, NJ 07033
201/245-6400
- Hitachi America, Ltd.
3500 W. 80th Street, Suite 175
Bloomington, MN 55431
612/831-0408
- Hitachi America, Ltd.
80 Washington St., Suite 101
Poughkeepsie, NY 12601
914/485-3400
- Hitachi America, Ltd.
1 Parkland Blvd., #1222E
Dearborn, MI 48126
313/271-4410
- Hitachi America, Ltd.
6161 Savoy Dr., Suite 850
Houston, TX 77036
713/974-0534
- Hitachi America, Ltd.
5775 Peachtree Dunwoody Rd.
Suite 270-C
Atlanta, GA 30342
404/843-3445
- Hitachi America, Ltd.
4901 N.W. 17th Way
Fort Lauderdale, FL 33309
305/491-6154
- Hitachi America, Ltd.
18004 Skypark Circle, Suite 200
Irvine, CA 92714
714/261-9034
- Hitachi America, Ltd.
10300 S.W. Greenburg Rd., Suite 480
Portland, OR 97223
503/245-1825
- Hitachi America, Ltd.
2625 Queensview Dr.
Ottawa, Ontario, Canada



A World Leader in Technology

Hitachi America, Ltd.
Semiconductor and IC Sales and Service Division
2210 O'Toole Avenue, San Jose, CA 95131
1-408-942-1500
